

## 7 DAY TIME SWITCHES

### Different Schedules Each Day

W SERIES

#### APPLICATIONS

- Heating
- Air Conditioning
- Display Lighting
- Ventilating
- Lighted Signs
- Storefront Lighting

SPDT switches provide for control of mechanically-held contactors.

#### SPECIFICATIONS

Offers the easiest and most accurate setting of any 7 day Time Switch by means of unique combination ON-OFF trippers, distinctive time indicator and trigger action switch tripping mechanism.

#### Contact Ratings:

- 40 Amp. Tungsten, 120 VAC
- 40 Amp. Resistive, 120-277 VAC Single Phase
- 40 Amp. General Purpose, 120-277 VAC Single Phase
- 20 Amp. Inductive 120 VAC, 277 VAC Single Phase
- 1000 VA Pilot Duty 120-277 VAC.
- 2 HP (24 FLA) 120 VAC; 5 HP (28 FLA) 240 VAC

**Timing Motor:** Heavy duty synchronous, self-starting high torque. Power Consumption: 3-5 watts. Optional reserve power spring mechanism keeps dial on time up to 24 hours during power outage (16 hours on 4PST models). Power Consumption: 5 watts. Add suffix L to model number.

**Automatic Operation:** Minimum ON setting: 1 Hour. Minimum OFF setting: 2 Hours. (8 hours between 2 OFF settings). Models W400A and W402A offer minimum ON/OFF settings of 3-1/2 hours. 6-1/2 inch dial accommodates up to 2 pairs of ON-OFF removable Trippers per day - 7 pairs are supplied. Dial markings in English, French & Spanish.

**Temporary Manual Override:** Available.

**Operating Temperature Range:** -40° to +165°F. (-40° to +74°C.)

**Enclosures:** See end of controls section for dimensions. Surface - General Purpose (NEMA 1). Deep-drawn Steel, beige enamel, lockable hasp, with combination 1/2" - 3/4" K.O.'s on both sides and bottom.

Other Mountings:

**Flush Mount with lock and key** - NEMA Type 1 suffix FL3 - Model 9003\*. For 3 pole, suffix FL5 - Model 9005\*. For 4 pole, suffix FL6 - Model 9005I.

**Indoor /Outdoor Metal** - NEMA Type 3 (Suffix O) - Model 9006\*. For 4 pole - Model 9013I\*

**Bracket mounting** - specify mechanism only with bracket.

\*Use model number when ordering special enclosures separately.

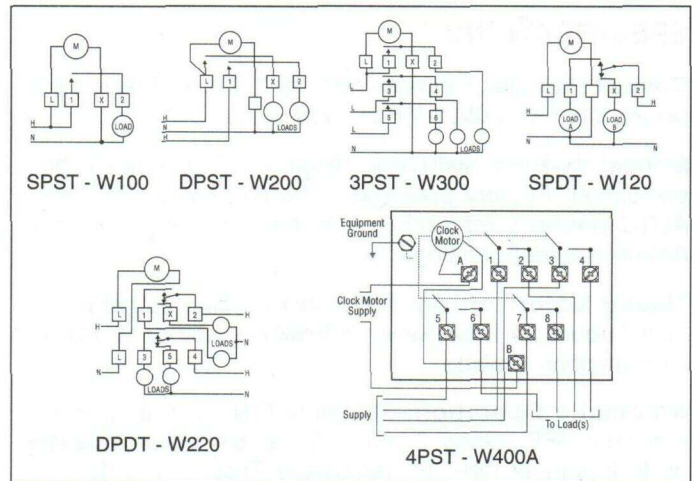

#### SPECIFICATION WRITER'S GUIDE

Furnish and install where shown TORK Time Switch of the 7 day type, powered by a self-starting synchronous motor, capable of being set for different ON-OFF times each day of the week, to an operating accuracy of plus or minus 15 minutes of the desired time. Time Switch contacts shall be capable of switching 40 amperes per pole continuously at 277 volts and shall be SPST (DPST, 3PST, DPDT, SPDT, 4PST as required). Removable ON-OFF trippers shall make possible automatic operation with a minimum ON period of one hour and a minimum of 2 hours between one OFF operation and the next ON. Models W400 and W402 offer minimum ON and OFF settings of 3-1/2 hours. Enclosure shall be NEMA 1 surface, NEMA 1 enclosure shall be finished in baked beige enamel, with combination 1/2" - 3/4" knock-outs on bottom and both sides. Provision shall be made for positive padlocking and/or sealing. Terminals shall be capable of receiving #8 AWG wire. Time Switch shall be TORK Model W\_\_\_ (to fit requirement).

**FOR RESERVE POWER (Add suffix L):** Spring-driven reserve shall be provided sufficient to operate the Time Switch contacts at least 24 hours after power failure 16 hour reserve power on 4PST models. On restoration of power, Time Switch shall transfer to synchronous motor driven and automatically rewind reserve.

#### ORDERING INFORMATION

†Model #	†Model # with Reserve Power	Switch	Amps	H.P. Rating	AC Voltage	Hz	Available in 50 Hz	MOTOR Enclosure Type
W100	-	SPST	40	2	120	60	YES	Metal Indoor
W200	-	DPST	40	2	120	60	YES	Metal Indoor
W202	-	DPST	40	5	208-277	60	YES	Metal Indoor
W300	W300L	3PST	40	2	120	60	YES	Metal Indoor
W302	W302L	3PST	40	5	208-277	60	YES	Metal Indoor
W120	-	SPDT	40	2	120	60	YES	Metal Indoor
W220	W220L	DPDT	40	2	120	60	YES	Metal Indoor
W222	W222L	DPDT	40	5	208-277	60	YES	Metal Indoor
W400A	W400AL	4PST	40	2	120	60	NO	Metal Indoor (Gray)
W402A	-	4PST	40	5	208-277	60	NO	Metal Indoor (Gray)
-	W402AL-0	4PST	40	5	208-277	60	NO	Metal Indoor/Outdoor

†24 Volt in all models available on specification.

MECHANICAL

## METAL INDOOR NEMA 1 #68229

### STD. FOR MODELS

1101	7122
1102	8001
1103	8004
1104	8011
1101FM	8061
1104FM	8121
7100	8301
7102	8601
7200	8602
7202	E100 Series,
7120	EH10/20

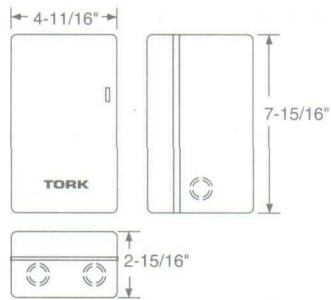

## METAL INDOOR/OUTDOOR NEMA 3 Model 9000A – Suffix O (replaces Model 9000)

### STD. FOR MODELS

7300, (L)	7302Z
7302, (L)	7300ZL
7300Z	7302ZL

### AVAILABLE FOR MODELS

1101	7200, (L,Z,ZL)	1847AL	8007V
1102	7202, (L,Z,ZL)	1847AZL	8011
1103	7120, (L,Z,ZL)	8001	8061
1104	7122, (L,ZL)	8004	8121
1101FM	7220, (L)	E100 Series	8301
1104FM	7222, (L)	8001U	8601
7100	1847A	8007	8602
7102	1847AZ	8007L	

DW, DWZ, DZS, DTS Series

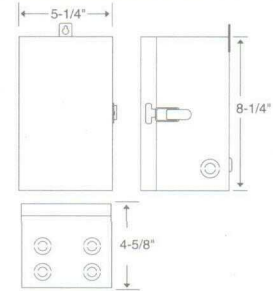

## METAL INDOOR NEMA 1 #63100

### STD. FOR MODELS

7220, (L)	1847AL	LC200
7222, (L)	1847AZL	LDS-A
7200L	8001L	LDSH-A
7202L	8007	
7120L	8007L	
1847A	8007V	
1848A	8150	
1849A	8150U	
1847AZ		



AVAILABLE FOR SERIES  
DZS, DTS,  
DW, DWZ,  
DG

## METAL INDOOR/OUTDOOR NEMA 3 Model 9006 – Suffix O

### AVAILABLE FOR MODELS

W100	W222	T920L
W200	W220L	T930L
W202	W222L	1847AW
W300	W300L	1847AWL
W302	W302L	
W120	TW220L	
W220	TW300L	

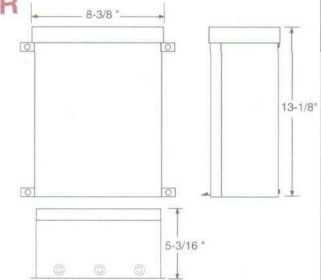

## METAL INDOOR NEMA 1 #63016-1

### STD. FOR MODELS

TZ220L	W302L
TZ300L	TW220L
W300	TW300L
W302	T920L
W300L	T930L

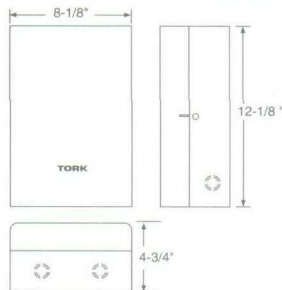

## METAL INDOOR/OUTDOOR – NEMA 3 Model 9013I - Suffix O

DIMENSIONS: 10-1/2" x 7-7/8" x 4-3/4"

### AVAILABLE FOR MODELS

W400AL
W402AL

## METAL INDOOR NEMA 1 #70100

### STD. FOR MODELS

W100	W222
W200	W220L
W202	W222L
W120	1847AW
W220	1847AWL

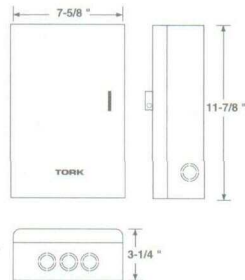

## NORYL® INDOOR/OUTDOOR NEMA 3R Model 9000N – Suffix N

### STD. FOR MODELS

7200Z, (L)	DG Series	DWZ Series
7202Z, (L)	DZS Series	SMC-3D
7120Z, (L)	DTS Series	
7122ZL	DW Series	

### AVAILABLE FOR MODELS

1101	7202, (L,Z,ZL)	1847AZL	8602
1102	7120, (L,Z,ZL)	8001	E100 Series
1103	7122	8004	
1104	7122ZL	8001U	
1101FM	7220, (L)	8011	
1104FM	7222, (L)	8061	
7100	1847A	8121	
7102	1847AZ	8301	
7200, (L,Z,ZL)	1847AL	8601	

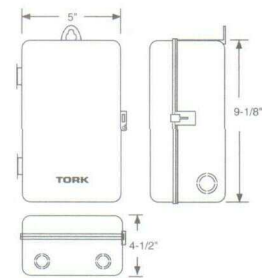

## METAL INDOOR NEMA 1

### STD. FOR MODELS

W400A	W400AL
W402A	W402AL

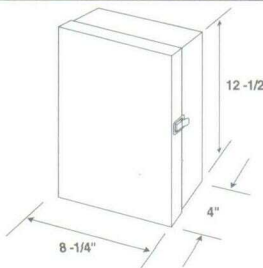

## 7 DAY TIME SWITCHES

### Different Schedules Each Day

W SERIES

#### APPLICATIONS

- Heating
- Air Conditioning
- Display Lighting
- Ventilating
- Lighted Signs
- Storefront Lighting

SPDT switches provide for control of mechanically-held contactors.

#### SPECIFICATIONS

Offers the easiest and most accurate setting of any 7 day Time Switch by means of unique combination ON-OFF trippers, distinctive time indicator and trigger action switch tripping mechanism.

#### Contact Ratings:

- 40 Amp. Tungsten, 120 VAC
- 40 Amp. Resistive, 120-277 VAC Single Phase
- 40 Amp. General Purpose, 120-277 VAC Single Phase
- 20 Amp. Inductive 120 VAC, 277 VAC Single Phase
- 1000 VA Pilot Duty 120-277 VAC.
- 2 HP (24 FLA) 120 VAC; 5 HP (28 FLA) 240 VAC

**Timing Motor:** Heavy duty synchronous, self-starting high torque. Power Consumption: 3-5 watts. Optional reserve power spring mechanism keeps dial on time up to 24 hours during power outage (16 hours on 4PST models). Power Consumption: 5 watts. Add suffix L to model number.

**Automatic Operation:** Minimum ON setting: 1 Hour. Minimum OFF setting: 2 Hours. (8 hours between 2 OFF settings). Models W400A and W402A offer minimum ON/OFF settings of 3-1/2 hours. 6-1/2 inch dial accommodates up to 2 pairs of ON-OFF removable Trippers per day - 7 pairs are supplied. Dial markings in English, French & Spanish.

**Temporary Manual Override:** Available.

**Operating Temperature Range:** -40° to +165°F. (-40° to +74°C.)

**Enclosures:** See end of controls section for dimensions. Surface - General Purpose (NEMA 1). Deep-drawn Steel, beige enamel, lockable hasp, with combination 1/2" - 3/4" K.O.'s on both sides and bottom.

Other Mountings:

**Flush Mount with lock and key** - NEMA Type 1 suffix FL3 - Model 9003\*. For 3 pole, suffix FL5 - Model 9005\*. For 4 pole, suffix FL6 - Model 9005I.

**Indoor /Outdoor Metal** - NEMA Type 3 (Suffix O) - Model 9006\*. For 4 pole - Model 9013I\*

**Bracket mounting** - specify mechanism only with bracket.

\*Use model number when ordering special enclosures separately.

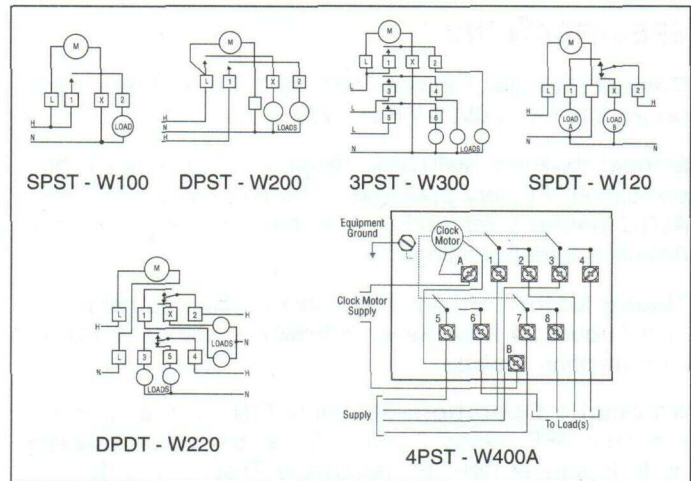

MECHANICAL

#### SPECIFICATION WRITER'S GUIDE

Furnish and install where shown TORK Time Switch of the 7 day type, powered by a self-starting synchronous motor, capable of being set for different ON-OFF times each day of the week, to an operating accuracy of plus or minus 15 minutes of the desired time. Time Switch contacts shall be capable of switching 40 amperes per pole continuously at 277 volts and shall be SPST (DPST, 3PST, DPDT, SPDT, 4PST as required). Removable ON-OFF trippers shall make possible automatic operation with a minimum ON period of one hour and a minimum of 2 hours between one OFF operation and the next ON. Models W400 and W402 offer minimum ON and OFF settings of 3-1/2 hours. Enclosure shall be NEMA 1 surface, NEMA 1 enclosure shall be finished in baked beige enamel, with combination 1/2" - 3/4" knock-outs on bottom and both sides. Provision shall be made for positive padlocking and/or sealing. Terminals shall be capable of receiving #8 AWG wire. Time Switch shall be TORK Model W\_\_\_ (to fit requirement).

**FOR RESERVE POWER (Add suffix L):** Spring-driven reserve shall be provided sufficient to operate the Time Switch contacts at least 24 hours after power failure 16 hour reserve power on 4PST models. On restoration of power, Time Switch shall transfer to synchronous motor driven and automatically rewind reserve.

#### ORDERING INFORMATION

†Model #	†Model # with Reserve Power	Switch	Amps	H.P. Rating	AC Voltage	Hz	Available in 50 Hz	MOTOR Enclosure Type
W100	-	SPST	40	2	120	60	YES	Metal Indoor
W200	-	DPST	40	2	120	60	YES	Metal Indoor
W202	-	DPST	40	5	208-277	60	YES	Metal Indoor
W300	W300L	3PST	40	2	120	60	YES	Metal Indoor
W302	W302L	3PST	40	5	208-277	60	YES	Metal Indoor
W120	-	SPDT	40	2	120	60	YES	Metal Indoor
W220	W220L	DPDT	40	2	120	60	YES	Metal Indoor
W222	W222L	DPDT	40	5	208-277	60	YES	Metal Indoor
W400A	W400AL	4PST	40	2	120	60	NO	Metal Indoor (Gray)
W402A	-	4PST	40	5	208-277	60	NO	Metal Indoor (Gray)
-	W402AL-0	4PST	40	5	208-277	60	NO	Metal Indoor/Outdoor

†24 Volt in all models available on specification.

## METAL INDOOR NEMA 1 #68229

### STD. FOR MODELS

1101	7122
1102	8001
1103	8004
1104	8011
1101FM	8061
1104FM	8121
7100	8301
7102	8601
7200	8602
7202	E100 Series,
7120	EH10/20

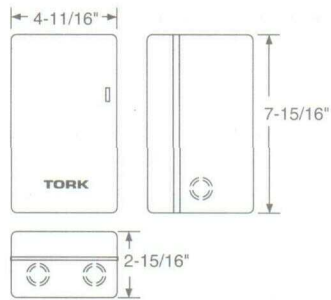

## METAL INDOOR/OUTDOOR NEMA 3 Model 9000A – Suffix O (replaces Model 9000)

### STD. FOR MODELS

7300, (L)	7302Z
7302, (L)	7300ZL
7300Z	7302ZL

### AVAILABLE FOR MODELS

1101	7200, (L,Z,ZL)	1847AL	8007V
1102	7202, (L,Z,ZL)	1847AZL	8011
1103	7120, (L,Z,ZL)	8001	8061
1104	7122, (L,ZL)	8004	8121
1101FM	7220, (L)	E100 Series	8301
1104FM	7222, (L)	8001U	8601
7100	1847A	8007	8602
7102	1847AZ	8007L	

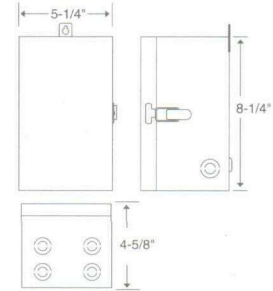

## METAL INDOOR NEMA 1 #63100

### STD. FOR MODELS

7220, (L)	1847AL	LC200
7222, (L)	1847AZL	LDS-A
7200L	8001L	LDSH-A
7202L	8007	
7120L	8007L	
1847A	8007V	
1848A	8150	
1849A	8150U	
1847AZ		



**AVAILABLE FOR SERIES**  
DZS, DTS,  
DW, DWZ,  
DG

## METAL INDOOR/OUTDOOR NEMA 3 Model 9006 – Suffix O

### AVAILABLE FOR MODELS

W100	W222	T920L
W200	W220L	T930L
W202	W222L	1847AW
W300	W300L	1847AWL
W302	W302L	
W120	TW220L	
W220	TW300L	

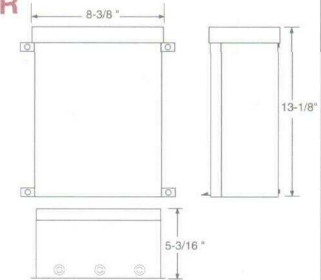

## METAL INDOOR NEMA 1 #63016-1

### STD. FOR MODELS

TZ220L	W302L
TZ300L	TW220L
W300	TW300L
W302	T920L
W300L	T930L

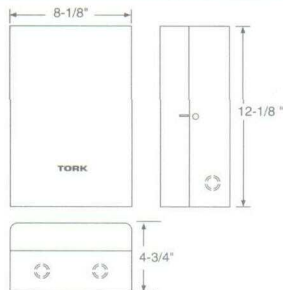

## METAL INDOOR/OUTDOOR – NEMA 3 Model 9013I - Suffix O

**DIMENSIONS:** 10-1/2" x 7-7/8" x 4-3/4"

### AVAILABLE FOR MODELS

W400AL
W402AL

## METAL INDOOR NEMA 1 #70100

### STD. FOR MODELS

W100	W222
W200	W220L
W202	W222L
W120	1847AW
W220	1847AWL

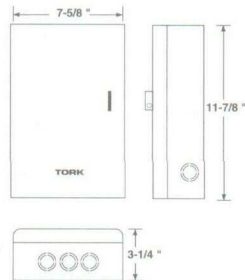

## NORYL® INDOOR/OUTDOOR NEMA 3R Model 9000N – Suffix N

### STD. FOR MODELS

7200Z, (L)	DG Series	DWZ Series
7202Z, (L)	DZS Series	SMC-3D
7120Z, (L)	DTS Series	
7122ZL	DW Series	

### AVAILABLE FOR MODELS

1101	7202, (L,Z,ZL)	1847AZL	8602
1102	7120, (L,Z,ZL)	8001	E100 Series
1103	7122	8004	
1104	7122ZL	8001U	
1101FM	7220, (L)	8011	
1104FM	7222, (L)	8061	
7100	1847A	8121	
7102	1847AZ	8301	
7200, (L,Z,ZL)	1847AL	8601	

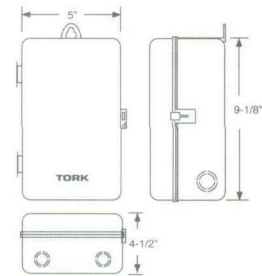

## METAL INDOOR NEMA 1

### STD. FOR MODELS

W400A	W400AL
W402A	W402AL

