

MILBANK[®]
ENERGY AT WORK



Western Region

Product Catalog



Milbank Overview

Energy At Work since 1927

Milbank designs and manufactures electrical solutions that move and manage power for the residential, commercial, industrial, utility and transportation sectors. With 90 years of expertise in electrical engineering design and manufacturing, Milbank's portfolio includes metering equipment, enclosures and enclosed controls. Founded in 1927, Milbank is a family-owned, American manufacturer headquartered in Kansas City, Mo. For more information, please visit milbankworks.com.

METERING



As a market leader in electrical metering equipment, Milbank has set the standard for quality since 1927. Hundreds of configurations are available, including many sizes, knockout configurations, terminal configurations, bypass options, hubs, locks and connectors. Milbank has the socket you need with thousands of active products to meet your utility's requirements.

ENCLOSURES



Milbank's line of enclosures include commercial junction boxes, panel mount enclosures, transformer cabinets, wireway, trough and industrial panel mount and push-button enclosures. Built with high-quality craftsmanship and materials which meet or exceed industry standards, Milbank enclosures are made to protect controls and equipment from dust, dirt and other harmful elements found in a wide variety of environments.

ENCLOSED CONTROLS



Milbank doesn't just build empty enclosures. We can deliver the entire package, complete with custom control equipment built to your exact specifications by our engineers. Milbank commercial pedestals are an attractive, secure, easy to install and cost-effective solution when underground remote site power distribution and control equipment is required, replacing unsightly and inefficient strut and backboard structures. Milbank's manual and automatic transfer switches are durable, easy to install and compatible with most generators.



Please consult serving utility for their requirements prior to ordering or installing, as specifications and approvals vary by utility, and may require local electrical inspector approval. All installations must be installed by a licensed electrician and must comply with all national and local codes, laws and regulations. Milbank reserves the right to make changes in specifications and features shown without notice or obligation.

Air Conditioner Disconnects

30-60 amp AC disconnects	7
60 amp AC disconnect with 20 amp GFCI receptacle	8
Hot tub disconnects.....	9

Single Position Sockets

30-100 amp, 4 terminal, ring type	10
100 amp, solar sockets, 4 terminal	11
125 amp, 4 & 7 terminal, ringless & ring type	12
200 amp, 4 & 7 terminal, ringless & ring type	13-14
200 amp, 4 terminal, ring type	15
125-200 amp, 4 & 7 terminal, ring type, link bypass	16
200 amp, 4 & 5 terminal, lever bypass, ringless, lever bypass.....	17
125-200 amp, 4,5 & 7 terminal, ringless, lever bypass	18-19
320 amp, 4 terminal, lever & non-lever bypass, ringless.....	20
320 amp, 4 terminal, link bypass, ring type.....	21
320 amp, 7 terminal, lever bypass, ringless.....	22
100-200 amp, 4 terminal, main breaker.....	23

Meter Mains

200 amp, 4 & 7 terminal, ring type.....	24
100-200 amp, 4 & 5 terminal, ringless & ring type	25
400-320 amp continuous, 4 terminal, ringless & ring type	26-30

Safety Sockets

100 & 200 amp, 4, 5 & 7 terminal, ring type, test block bypass.....	31-32
100 amp, 4, 5 & 7 terminal, ring type, test block bypass	33-35
200 amp, 4, 5 & 7 terminal, ring type, test block bypass	36-39
100 & 200 amp, all-in-one series, test block bypass	40-41
Replacement Parts.....	42-44

Underground Termination Boxes

100-800 amp.....	45
Bussed gutters, type 3R	46-47

Multi-Position Sockets

100-125 amp, 4 terminal, ringless	48
200 amp, 4 terminal, ringless.....	49
125 & 200 amp, 4 terminal, meter mains, ringless.....	50-53

Please consult serving utility for their requirements prior to ordering or installing, as specifications and approvals vary by utility, and may require local electrical inspector approval. All installations must be installed by a licensed electrician and must comply with all national and local codes, laws and regulations. Milbank reserves the right to make changes in specifications and features shown without notice or obligation.



Miscellaneous

Current transformer enclosures	54-55
Current transformer test switches	56-57
Test switch worksheet	58
Current transformer cabinets.....	59-62
Service pedestals, mobile home	63-64
Power pedestals	65
Replacement parts.....	66-67
Mobile home pedestals.....	68
Service pedestals.....	69-74
Temporary power	75-79
Surface mount power	80
Power outlet pedestals.....	81
Replacement receptacle plates.....	82
Lighting accessories.....	83-84
Telecom and pedestal accessories.....	85
Pedestal mounting accessories	86
Metering and receptacle accessories.....	87
Replacement parts and accessories	88-89
Recreational vehicle products.....	90-91
Dry type transformers.....	92

Commercial Pedestals

Commercial pedestal overview.....	93-94
100-200 amp, 4 terminal ringless & ring type.....	95
100-200 amp, Switch load center, 4 terminal, ringless & ring type	96
400 amp, class 320 4 terminal, ringless & ring type	97
100 amp, irrigation, 4 terminal, ring type.....	98
Battery backup series	99
Power transfer series	100
CT metered series.....	101
Slim line series	102
Commercial pedestal accessories	103
Commercial pedestal reference information.....	104-113

Miscellaneous

Commercial & industrial enclosures	114
Accessories	115-119
Reference information	120-123
Index.....	124-128



Please consult serving utility for their requirements prior to ordering or installing, as specifications and approvals vary by utility, and may require local electrical inspector approval. All installations must be installed by a licensed electrician and must comply with all national and local codes, laws and regulations. Milbank reserves the right to make changes in specifications and features shown without notice or obligation.

Catalog Number Logic

How our product catalog numbers are derived

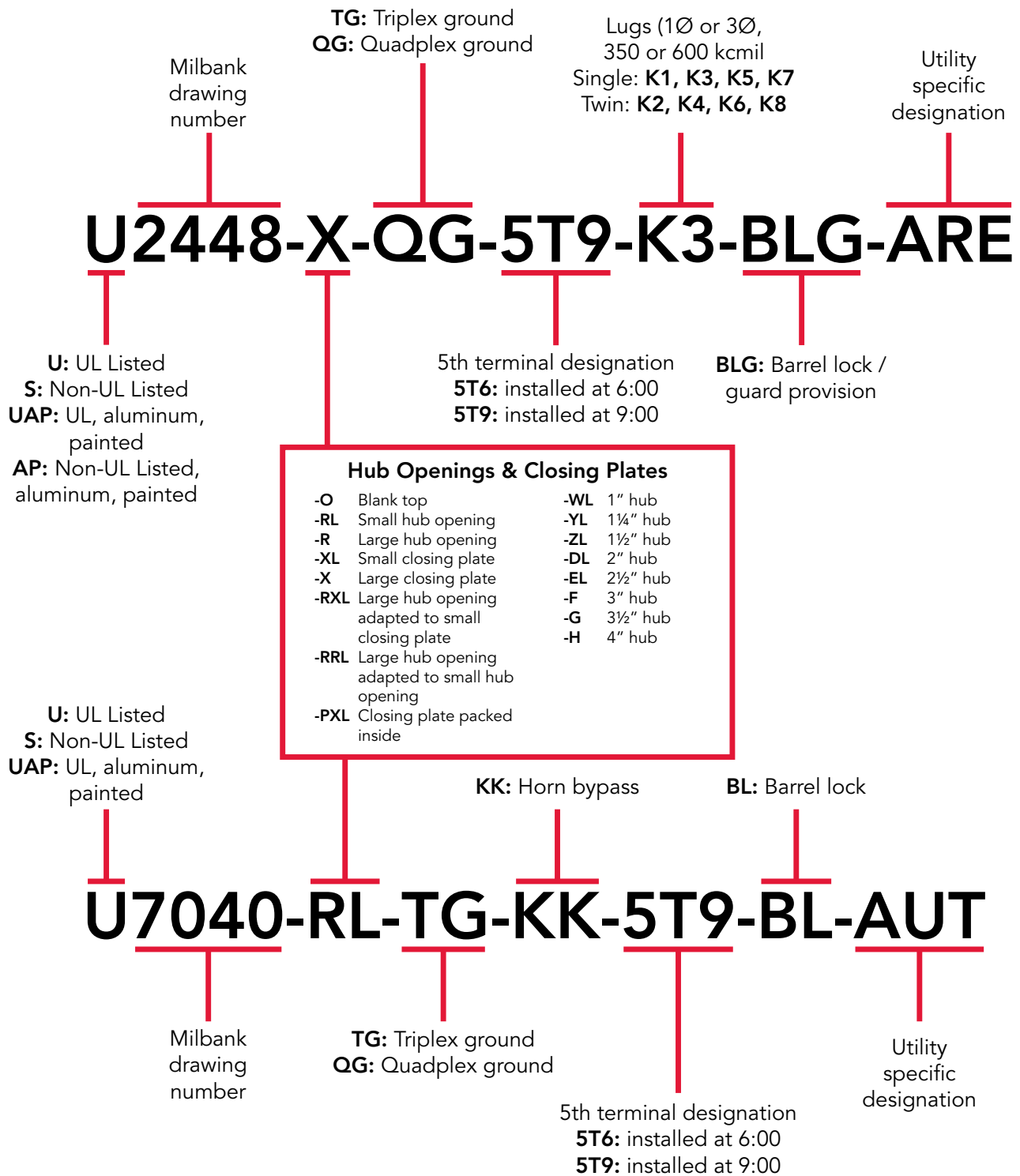

Please consult serving utility for their requirements prior to ordering or installing, as specifications and approvals vary by utility, and may require local electrical inspector approval. All installations must be installed by a licensed electrician and must comply with all national and local codes, laws and regulations. Milbank reserves the right to make changes in specifications and features shown without notice or obligation.



Catalog Number	EUSERC Drawing Number	Catalog Page	Catalog Number	EUSERC Drawing Number	Catalog Page	Catalog Number	EUSERC Drawing Number	Catalog Page
U3574-RL-200	301	24	215MTB-P48	305A, 311	35	PB-034	343	45
U3577-RL-200	301	24	217MTB-P48	305A, 311	35	PB-034-NK	343	45
U3584-O-200	301	24	U214MTB-P48	305A, 311	35	PB-038	343	45
U3597-O-200	301	24	U215MTB-P48	305A, 311	35	U3320-R	313	62
U4015-O	301A	14	U217MTB-P48	305A, 311	35	MPRV-BLANK-78	307	63
UF4015-KO	301A	15	224MTB	305A, 311	36	MPRV-BLANK-78-R5T	307	63
U3548-X	302B	21	225MTB	305A, 311	36	MPRV-100-78	307	63
M400-UG-APS-F	302A	28	227MTB	305A, 311	37	MPRV-100-MB-78	307	63
M400-UG-APS-F-BS	302	28	U224MTB	305A, 311	36	MPRV-50-78	307	63
M400-UG-APS-P	302A	28	U225MTB	305A, 311	36	MPRV-503020GR-78	307	63
M400-UG-APS-LC	302A	28	U227MTB	305A, 311	36	MPAP-BLANK-78	307	64
M400-UG-APS-LC-BS	302A	28	U224MTB	305A, 311	36	MPAP-BLANK-78R	307	64
U3251-O-200-CB	302	28	U225MTB	305A, 311	36	MPAP-100-78	307	64
M401-UG	302A	29	U227MTB	305A, 311	36	MPAP-100-MB-78	307	64
M401-UG-BS	302	29	224MTB/22	305A, 311	37	MPAP-200-78	307	64
M404-UG-LC	302A	30	227MTB/22	305A, 311	37	MPAP-200-MB-78	307	64
M404-UG-LC-BS	302	30	U224MTB/22	305A, 311	37	MPAP-200-20GR-78	307	64
114TB	304, 311	31	U227MTB/22	305A, 311	37	MPAPD-BLANK-78	307	64
115TB	304, 311	31	227MTB-48	305A, 311	38	MPAPD-BLANK-78R	307	64
117TB	304, 311	31	U224MTB-48	305A, 311	38	U3322-R	313	62
124TB	305, 311	31	U227MTB-48	305A, 311	38	U3355-R	313	62
125TB	305, 311	31	224MTB-P	305A, 311	39	U3340-O	314	62
127TB	305, 311	31	225MTB-P	305A, 311	39	U3342-O	314	62
214MTB	305A, 311	32	227MTB-P	305A, 311	39	U3565-O	314	62
215MTB	305A, 311	32	U224MTB-P	305A, 311	39	CT244811-SC	316, 317	61
217MTB	305A, 311	32	U227MTB-P	305A, 311	39	CT364811-SC	316, 317, 318	61
U214MTB	305A, 311	32	224MTB-P48	305A, 311	39	CT364814-SC	316, 317, 318	61
U215MTB	305A, 311	32	225MTB-P48	305A, 311	39	CT484811-SC	316, 317	61
U217MTB	305A, 311	32	227MTB-P48	305A, 311	39	CT244811-HC	316, 317	61
214MTB/22	305A, 311	33	U224MTB-P48	305A, 311	39	CT304811-HC	316, 317	61
217MTB/22	305A, 311	33	U227MTB-P48	305A, 311	39	CT364811-HC	316, 317, 318	61
U214MTB/22	305A, 311	33	U214MTBL	305A, 311	40	CT484811-HC	316, 317, 318	61
U217MTB/22	305A, 311	33	U214MTBPL	305A, 311	40	CT484814-HC	316, 317, 318	61
214MTB-48	305A, 311	34	U217MTBL	305A, 311	40	K4903	328B	60
215MTB-48	305A, 311	34	U217MTBPL	305A, 311	40	K4904	329B	60
217MTB-48	305A, 311	34	U224MTBL	305A, 311	40	K4722	329B	60
U214MTB-48	305A, 311	34	U224MTBPL	305A, 311	40	K4729	328B	60
U215MTB-48	305A, 311	34	U227MTBL	305A, 311	40	K4797	328A	60
U217MTB-48	305A, 311	34	U227MTBPL	305A, 311	40	K4798	339A	60
214MTB-P	305A, 311	35	PB-011	305A, 311	45	UC3435-XL	339	54
215MTB-P	305A, 311	35	PB-012	343A	45	UC3436-XL	339	54
217MTB-P	305A, 311	35	PB-014	343	45	UC3438-XL	339	54
U214MTB-P	305A, 311	35	PB-014-NK	343	45	UC3433-XL	339	54
U215MTB-P	305A, 311	35	PB-018	343	45	UC3434-XL	339	54
U217MTB-P	305A, 311	35	PB-034-NK	343	45			
214MTB-P48	305A, 311	35	PB-032	343A	45			



Please consult serving utility for their requirements prior to ordering or installing, as specifications and approvals vary by utility, and may require local electrical inspector approval. All installations must be installed by a licensed electrician and must comply with all national and local codes, laws and regulations. Milbank reserves the right to make changes in specifications and features shown without notice or obligation.

Air Conditioner Disconnects

30-60 Amp | Fusible & Non-Fusible



U3802

U3812

U3832

Milbank's air conditioner disconnect has a removable hinged cover for ease of installation. Our compact design meets NEC wiring space requirements and also complies with NEC article 440-14. For safe working conditions, our disconnect pullers may be removed and reinstalled in the OFF position. Additionally, padlock provisions are included on the front cover. As with other Milbank products, our enclosure is constructed of G90U galvanized steel and electrostatically finished with an attractive, light gray, baked powder coating. Our epoxy/polyester resin blend offers a finish that is both durable and fade-resistant.

30-60 Amp | 1Ø 240 VAC | Air Conditioner Disconnects

Catalog Number	Amp	Type	Max H.P.	Weight (lbs.)	Line/Load Wire Range		Ground Wire Range CU/AL	Dimensions			Wire Rating	
					CU	AL		D"	W"	H"	CU °C	AL °C
U3802	60	Non-Fusible	10	3.25	#14-#2	#12-#2	#14-4	2½	5	7½	60°/75°	60°/75°
U3812	60	Non-Auto	10	3.25	#14-#2	#12-#2	#14-4	2½	5	7½	60°/75°	60°/75°
U3832	30	Fusible	3	2.5	#14-#3	#14-#3	#14-3	2½	5	7	60°/75°	60°/75°
U3862	60	Fusible	10	3.3	#14-#3	#14-#3	#14-3	2½	5	9	60°/75°	60°/75°

Notes

- UL listed as Enclosed Pullout Switch
- Type 3R rain resistant
- One-inch concentric knockouts

Please consult serving utility for their requirements prior to ordering or installing, as specifications and approvals vary by utility, and may require local electrical inspector approval. All installations must be installed by a licensed electrician and must comply with all national and local codes, laws and regulations. Milbank reserves the right to make changes in specifications and features shown without notice or obligation.



Air Conditioner Disconnects

60 Amp | With 20 Amp GFCI Receptacle



U3822-20GWR

Specifications

- Meets NEC #210.63 requirements
- UL listed as Power Outlet
- Type 3R enclosure
- In-use cover*
- Duplex ground connector
- 1" concentric knockouts
- 1Ø, 240 volt
- 60 amp, non-fused
- 20 amp GFCI receptacle
- Reset/test button
- Weather and tamper resistant
- Meets NEC #406.8 requirements

60 Amp | 1Ø, 240 VAC | Air Conditioner Disconnect with GFCI Receptacle

Catalog Number	Type	Max H.P.	Weight (lbs.)	Line/Load Wire Range		Ground Wire Range CU/AL	Dimensions			Wire Rating	
				CU	AL		D"	W"	H"	CU °C	AL °C
U3822-20GWR	Non-Fusible	10	6	#14-#2	#12-#2	#14-4	4 $\frac{1}{2}$ "	5 $\frac{1}{4}$ "	7 $\frac{1}{2}$ "	60°/75°	60°/75°

Notes

- **Disconnect Pullouts:** To ensure the safest conditions, Milbank disconnect pullouts are reversible so they may be reinstalled in the OFF position.
- **Padlock Provision:** All units are designed with a padlock provision on the cover for security.
- ***In-Use Cover:** Cover is rated as an in-use cover (cover may be closed with cords plugged into receptacle).

Hot Tub Disconnects

Type 3R Enclosures



U4881-O-50GB



U4881-O-60GB

Specifications

- 240 volt ground fault protection
- UL listed, Type 3R rain resistant enclosure
- 2-pole, 50 amp GFCI breaker protection
- Compact size
- Three or four wire installation
- 1Ø, 120/240 VAC
- Standard package of 12
- Two extra one-pole breaker spaces
- 100 amp overall rating
- Easy to install

100 Amp | Hot Tub Disconnect or Sub Panel Breaker Enclosure | Type 3R

Catalog Number	Breaker Amp	Type	Weight (lbs.)	Line/Load Wire Range		Ground Wire Range CU/AL	Dimensions		
				CU	AL		D"	W"	H"
U4881-O	—	Breaker Provision	7	#14-1/0	#14-1/0	#14-1/0	3¾	7½	8½
U4881-O-50GB	50	Breaker	8	#14-1/0	#14-1/0	#14-1/0	3¾	7½	8½
U4881-O-60GB	60	Breaker	8	#14-1/0	#14-1/0	#14-1/0	3¾	7½	8½

Please consult serving utility for their requirements prior to ordering or installing, as specifications and approvals vary by utility, and may require local electrical inspector approval. All installations must be installed by a licensed electrician and must comply with all national and local codes, laws and regulations. Milbank reserves the right to make changes in specifications and features shown without notice or obligation.



Single Position Sockets

30-100 Amp | 4 Terminal | Ring Type

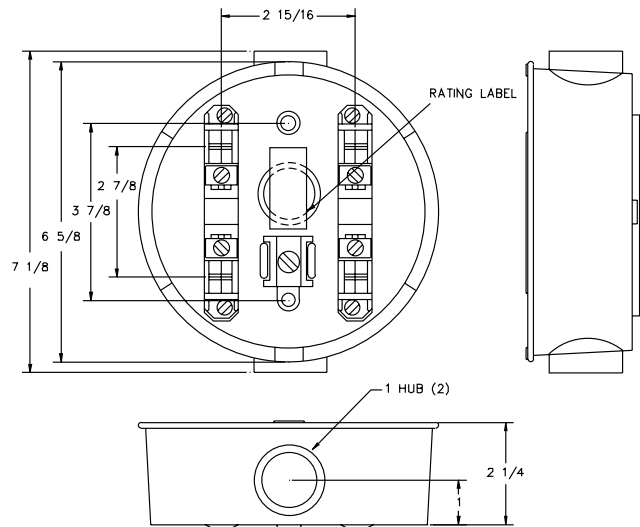

Applications

100 amp max rated is ideal for use on:

- Temporary service
- Outdoor advertising
- Small customer service
- Other low amp requirements

30-100 Amp | 4 Terminal | Economy Cast Socket | Ring Type | Single Position

Catalog Number	Terminal	Service	Hub	Connectors CU/AL		Quantity Per Package	Concentric Knockouts
				Line	Load		
AP2300-03	4	OH/UG	1"	#12-1/0	#12-1/0	12	3/4", 1"
AP2300-04	4	OH/UG	1 1/4"	#12-1/0	#12-1/0	12	3/4", 1"

Notes

- **Fifth & Sixth Terminal:** Contact factory.
- **Sealing Ring:** Supplied with a snap action sealing ring.
- **Hub:** Units supplied with cast in hub on top and bottom. Consult factory for availability of other hub sizes.
- **Bypass:** Also available with auto bypass. Contact factory.



Please consult serving utility for their requirements prior to ordering or installing, as specifications and approvals vary by utility, and may require local electrical inspector approval. All installations must be installed by a licensed electrician and must comply with all national and local codes, laws and regulations. Milbank reserves the right to make changes in specifications and features shown without notice or obligation.

Single Position Solar Sockets

100 Amp | 4 Terminal | 600 VAC

1 1
100 AMP
SINGLE
POSITION
SOCKETS



U5934-XL-BLG



U6087-XL-INS



U4175-RL-BLG

100 Amp | 4 Terminal | Residential Solar Sockets | Standard Neutral

Catalog Number	Socket Type	Service	Hub	Connectors CU/AL		Dimensions			Knockouts			
				Line	Load	D"	W"	H"	1	2	3	4
U4175-RL-BLG*	Ringless	OH/UG	H.O.	#12-1/0	#12-1/0	3 ⁵ / ₁₆	8	11 ¹ / ₂	2	1 ¹ / ₂	1 ¹ / ₄	1 ¹ / ₄
U6087-XL*	Ring Type	OH/UG	C.P.	#12-1/0	#12-1/0	3 ⁵ / ₁₆	8	11 ¹ / ₂	2	1 ¹ / ₂	1 ¹ / ₄	1 ¹ / ₄
U6087-XL-INS*	Ring type	OH/UG	C.P.	#12-1/0	#12-1/0	3 ⁵ / ₁₆	8	11 ¹ / ₂	2	1 ¹ / ₂	1 ¹ / ₄	1 ¹ / ₄

100 Amp | 4 Terminal | Residential Solar Sockets | Integral Isolated Neutral Option

Catalog Number	Socket Type	Service	Hub	Connectors CU/AL		Dimensions			Knockouts			
				Line	Load	D"	W"	H"	1	2	3	4
U5929-XL-INS	Ring Type	OH/UG	C.P.	#12-1/0	#12-1/0	3 ⁵ / ₁₆	8	11 ¹ / ₂	2	1 ¹ / ₂	1 ¹ / ₄	1 ¹ / ₄
U5934-XL-BLG	Ringless	OH/UG	C.P.	#12-1/0	#12-1/0	3 ⁵ / ₁₆	8	11 ¹ / ₂	2	1 ¹ / ₂	1 ¹ / ₄	1 ¹ / ₄

Notes

- **BLG:** Barrel lock guard knockout provision.
- **Hubs:** Accepts standard meter socket hubs.
- **Construction:** Units are Type 3R for durable outdoor use, lockable and sealable.
- ***Application:** The standard bonded neutral units are applicable in areas where utility does not require an isolated neutral.

Please consult serving utility for their requirements prior to ordering or installing, as specifications and approvals vary by utility, and may require local electrical inspector approval. All installations must be installed by a licensed electrician and must comply with all national and local codes, laws and regulations. Milbank reserves the right to make changes in specifications and features shown without notice or obligation.



12

125 AMP
SINGLE
POSITION
SOCKETS

Single Position Sockets

125 Amp | 4 & 7 Terminal | Ringless & Ring Type



U7487-RL

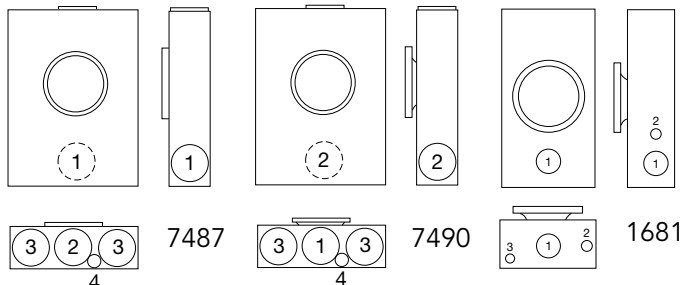

U7490-O

125 Amp | 4 Terminal | Ringless | Single Position

Catalog Number	Terminal	Service	Hub	Connectors CU/AL		Bypass	Dimensions			Knockouts			
				Line	Load		D"	W"	H"	1	2	3	4
U7487-O	4	UG	Blank	#6-2/0	#6-2/0	None	3 ⁵ / ₁₆	8	11 ¹ / ₂	1 ¹ / ₂	2	1 ¹ / ₄	1 ¹ / ₄
U7487-RL	4	OH/UG	H.O.	#6-2/0	#6-2/0	None	3 ⁵ / ₁₆	8	11 ¹ / ₂	1 ¹ / ₂	2	1 ¹ / ₄	1 ¹ / ₄

125 Amp | 4 Terminal | Ring Type | Single Position

Catalog Number	Terminal	Service	Hub	Connectors CU/AL		Bypass	Dimensions			Knockouts					
				Line	Load		D"	W"	H"	1	2	3	4	5	6
U7490-O	4	UG	Blank	#6-2/0	#6-2/0	None	3 ⁵ / ₁₆	8	11 ¹ / ₂	1 ¹ / ₂	1 ¹ / ₂	2	1 ¹ / ₂	—	1 ¹ / ₄
U7490-RL	4	OH/UG	H.O.	#6-2/0	#6-2/0	None	3 ⁵ / ₁₆	8	11 ¹ / ₂	1 ¹ / ₂	1 ¹ / ₂	2	1 ¹ / ₂	—	1 ¹ / ₄

125 Amp | 7 Terminal | Ring Type | Single Position

Catalog Number	Terminal	Service	Hub	Connectors CU/AL		Bypass	Dimensions			Knockouts					
				Line	Load		D"	W"	H"	1	2	3	4	5	6
U1681-RL	7	OH	H.O.	#6-2/0	#6-2/0	None	4 ⁷ / ₁₆	10	18 ¹ / ₂	2	3 ⁴ / ₈	1 ¹ / ₂	—	1 ¹ / ₄ , 1 ¹ / ₂	3 ⁴ / ₈

Notes

- **Fifth Terminal:** For field mounted fifth terminal on the **U7487 & U7490** order catalog number **5T8K2** to fit into round opening at the 9 o'clock position.
- **Hubs:** For proper hub selection see the hub suffix chart on the accessory page.
- **Connectors:** Extruded aluminum connectors are tin plated.
- **Sealing Rings:** Ring type units supplied with an **MR-2** snap action sealing ring as standard.



Please consult serving utility for their requirements prior to ordering or installing, as specifications and approvals vary by utility, and may require local electrical inspector approval. All installations must be installed by a licensed electrician and must comply with all national and local codes, laws and regulations. Milbank reserves the right to make changes in specifications and features shown without notice or obligation.

Single Position Sockets

200 Amp | 4 Terminal | Ringless

13
200 AMP
SINGLE
POSITION
SOCKETS



U7040-XL-TG



U1060-RL



U1980-O

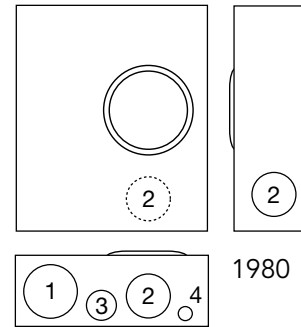
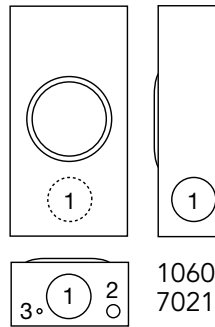
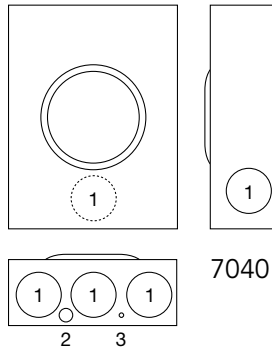

200 Amp | 4 Terminal | Ringless | Single Position

Catalog Number	Terminal	Service	Hub	Connectors CU/AL		Bypass	Dimensions			Knockouts					
				Line	Load		D"	W"	H"	1	2	3	4	5	6
U1060-RL	4	OH	H.O.	#2-350	#2-350	None	4½	8	15½	2	¾	¼	—	—	¼
U1527-O	4	UG	Blank	#2-350	#2-350	None	4½	11	15½	2	½	¼	2½	¼, ½	¼
U1980-O	4	UG	Blank	#6-350	#6-350	None	4½	13	15½	3	2½	¼	½	—	—
U7021-RL-TG	4	OH	H.O.	#6-350	#6-350	None	4½	8	15½	2½	½	¼	—	—	—
U7040-XL-TG	4	OH/UG	C.P.	#6-350	#6-350	None	4½	11	15½	½	¼	2½	—	—	—
U7043-XL-TG	4	OH/UG	C.P.	#6-350	#6-350	None	4½	13	15½	2½	½	¼	—	—	—

Notes

- **Fifth Terminal:** For field mounted fifth terminal order catalog number **K5T** to fit into square opening at the 9 o'clock position.
- **Hubs:** For proper hub selection see the hub suffix chart on accessory page.
- **Connectors:** Extruded aluminum connectors are tin plated.

Please consult serving utility for their requirements prior to ordering or installing, as specifications and approvals vary by utility, and may require local electrical inspector approval. All installations must be installed by a licensed electrician and must comply with all national and local codes, laws and regulations. Milbank reserves the right to make changes in specifications and features shown without notice or obligation.



14

200 AMP
SINGLE
POSITION
SOCKETS

Single Position Sockets

200 Amp | 4 & 7 Terminal | Ring Type



U3328-RXL



U4518-O-W

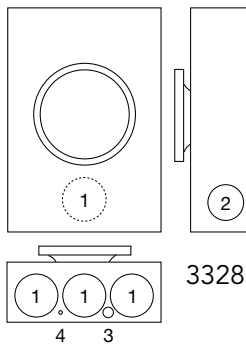

3328

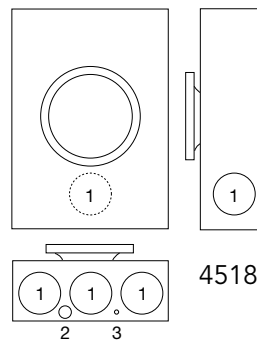

4518

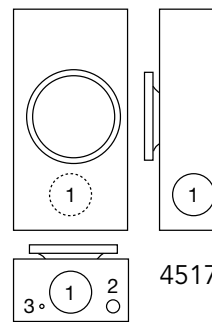

4517

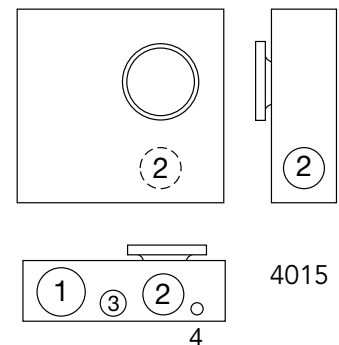

4015

200 Amp | Ring Type | Single Position

Catalog Number	Terminal	Service	Hub	Connectors CU/AL		Bypass	Dimensions			Knockouts			
				Line	Load		D"	W"	H"	1	2	3	4
U4517-DL-M4	4	OH	2"	#6-350	#6-350	None	4½	8	15½	2½	½	¼	—
U4518-XL-W	4	OH/UG	C.P.	#6-350	#6-350	None	4½	11	15½	2½	½	¼	—
U4518-O-W	4	UG	Blank	#6-350	#6-350	None	4½	11	15½	2½	½	¼	—
U4015-O	4	UG	Blank	#6-350	#6-350	None	6	14	16¼	3	2½	1½	½
U3328-RXL	7	OH/UG	C.P.	#6-350	#6-350	None	4¾	13	19	3	2½	½	¼

Notes

- **Fifth Terminal:** For field mounted fifth terminal order catalog number **K5T** to fit into square opening at the 9 o'clock position.
- **Hubs:** For proper hub selection see the hub suffix chart on accessory page.
- **Connectors:** Extruded aluminum connectors are tin plated.
- **Sealing Rings:** The above ring type units are supplied with a **MR-4** screw type sealing ring as standard.



Please consult serving utility for their requirements prior to ordering or installing, as specifications and approvals vary by utility, and may require local electrical inspector approval. All installations must be installed by a licensed electrician and must comply with all national and local codes, laws and regulations. Milbank reserves the right to make changes in specifications and features shown without notice or obligation.

Single Position Sockets

200 Amp | 4 Terminal | Flush Mount | Ring Type

15
200 AMP
SINGLE
POSITION
SOCKETS



UF4518-KO



UF4015-KO

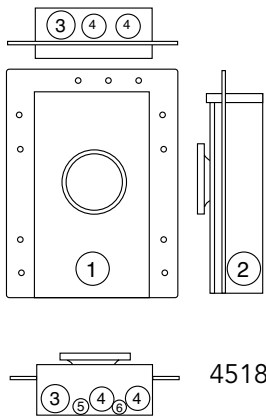

4518

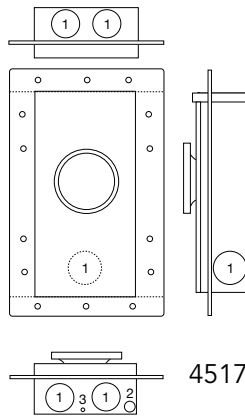

4517

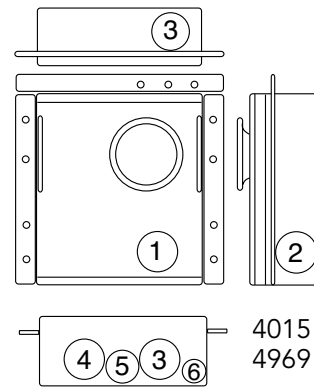

4015
4969

200 Amp | 4 Terminal | Flush Mount | Ring Type | Single Position

Catalog Number	Terminal	Service	Hub	Connectors CU/AL		Bypass	Dimensions			Knockouts					
				Line	Load		D"	W"	H"	1	2	3	4	5	6
UF4517-KO	4	OH	K.O.	#6-350	#6-350	None	5½	8	15½	2	½	¼	—	—	—
UF4518-KO	4	OH/UG	K.O.	#6-350	#6-350	None	5½	11	15½	2	2	2½	2½	½	¼
UF4015-KO	4	UG	K.O.	#6-350	#6-350	None	5	14	16¼	2½	2½	2½	2½	1½	½
UF4969-KO*	4	UG	K.O.	#6-350	#6-350	None	7½	14	16¼	2½	2½	2½	3	1½	½

Notes

- **Fifth Terminal:** For field mounted fifth terminal order catalog number **K5T** to fit into square opening at the 9 o'clock position.
- **Connectors:** Extruded aluminum connectors are tin plated.
- **Sealing Rings:** Ring type units are supplied with a **MR-4** screw type sealing ring as standard.
- * **UF4969** can only be used in a 2 x 6 wall.

Please consult serving utility for their requirements prior to ordering or installing, as specifications and approvals vary by utility, and may require local electrical inspector approval. All installations must be installed by a licensed electrician and must comply with all national and local codes, laws and regulations. Milbank reserves the right to make changes in specifications and features shown without notice or obligation.



16

125-200 AMP
LINK BYPASS
SINGLE
POSITION

Link Bypass Single Position

125-200 Amp | 4 & 7 Terminal | Ring Type



U3504-XL

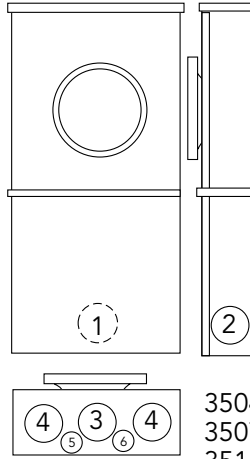

3504
3507
3514
3517



U3517-XL

125 Amp | 4 & 7 Terminal | Ring Type | Link Bypass | Single Position

Catalog Number	Terminal	Service	Hub	Connectors CU/AL		Dimensions			Knockouts					
				Line	Load	D"	W"	H"	1	2	3	4	5	6
U3504-XL	4	OH/UG	C.P.	#6-2/0	#6-2/0	4 ⁷ / ₈	10	18 ¹ / ₂	2	2	2	2	1/4	—
U3507-XL	7	OH/UG	C.P.	#6-2/0	#6-2/0	4 ⁷ / ₈	10	21	2	2	2	2	1/4	—

200 Amp | 4 & 7 Terminal | Ring Type | Link Bypass | Single Position

Catalog Number	Terminal	Service	Hub	Connectors CU/AL		Dimensions			Knockouts					
				Line	Load	D"	W"	H"	1	2	3	4	5	6
U3514-XL	4	OH/UG	C.P.	#6-350	#6-350	4 ⁷ / ₈	13	21	2 ¹ / ₂	2 ¹ / ₂	3	3	1/4	1/2
U3517-XL	7	OH/UG	C.P.	#6-350	#6-350	4 ⁷ / ₈	13	24 ¹ / ₂	2 ¹ / ₂	2 ¹ / ₂	2 ¹ / ₂	2 ¹ / ₂	1/4	1/2

Notes

- **Fifth Terminal:** For field mounted fifth terminal, order catalog number **5T8K2** for the **U3504**; order **K5T** for the **U3514**.
- **Connectors:** Extruded aluminum connectors are tin plated.
- **Sealing Rings:** Ring type units supplied with an **MR-4** screw type sealing ring as standard.
- **Link Bypass:** Links provided by utility.



Please consult serving utility for their requirements prior to ordering or installing, as specifications and approvals vary by utility, and may require local electrical inspector approval. All installations must be installed by a licensed electrician and must comply with all national and local codes, laws and regulations. Milbank reserves the right to make changes in specifications and features shown without notice or obligation.

Lever Bypass Single Position

200 Amp | 4 & 5 Terminal | Ringless

17
200 AMP
LEVER BYPASS
SINGLE
POSITION

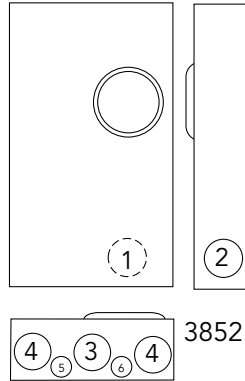

U3852-XL

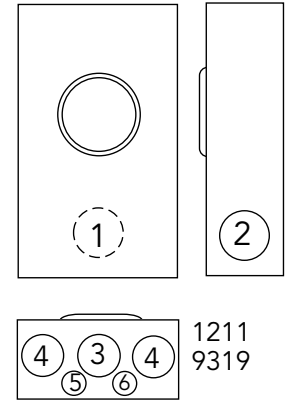

U9319-XL

200 Amp | 4 Terminal | Ringless | Non-Jaw Clamping Lever Bypass | Single Position | 1Ø3W

Catalog Number	Terminal	Service	Hub	Connectors CU/AL		Bypass	Dimensions			Knockouts					
				Line	Load		D"	W"	H"	1	2	3	4	5	6
U3852-XL	4	OH/UG	C.P.	#2-350	#2-350	Lever	4 $\frac{7}{8}$	13	19	3	2 $\frac{1}{2}$	2 $\frac{1}{2}$	2 $\frac{1}{2}$	$\frac{1}{4}$	$\frac{1}{2}$

Notes

- **Fifth Terminal:** Fifth terminal is not available for this unit.
- **Triplex Ground:** Factory installed as standard.

200 Amp | 4 & 5 Terminal | Ringless | Non-Jaw Clamping Lever Bypass | Single Position | 1Ø3W or 3Ø3W

Catalog Number	Terminal	Service	Hub	Connectors CU/AL		Bypass	Dimensions			Knockouts					
				Line	Load		D"	W"	H"	1	2	3	4	5	6
U1211-RXL	4	OH/UG	C.P.	#6-350	#6-350	Lever	4 $\frac{7}{8}$	13	19	3	2 $\frac{1}{2}$	3	3	$\frac{1}{4}$	$\frac{1}{2}$
U9319-XL	5	OH/UG	C.P.	#6-350	#6-350	Lever	4 $\frac{7}{8}$	13	19	3	2 $\frac{1}{2}$	3	3	$\frac{1}{4}$	$\frac{1}{2}$

Notes

- **Fifth Terminal:** For field mounted fifth terminal, order as extra **K3866** for the **U1211**.
- **Hubs:** For proper hub selection see the hub suffix chart on accessory page.
- **Bypass:** 200 amp continuous duty bypass. Lever operates bypass only. Not jaw clamping.
- **Connectors:** Units are supplied with extruded aluminum connectors and bonded, triplex neutral.

Please consult serving utility for their requirements prior to ordering or installing, as specifications and approvals vary by utility, and may require local electrical inspector approval. All installations must be installed by a licensed electrician and must comply with all national and local codes, laws and regulations. Milbank reserves the right to make changes in specifications and features shown without notice or obligation.



Lever Bypass Single Position

125-200 Amp | 7 Terminal | Ringless



U7573-RL

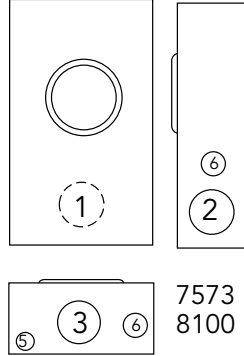

U7422-RXL

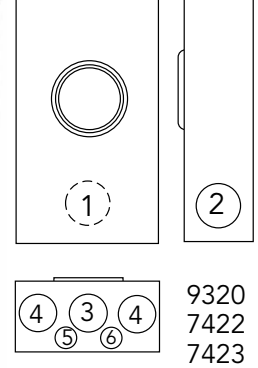

7 Terminal | Ringless | No Bypass | Single Position | 3Ø4W

Catalog Number	Amp	Terminal	Service	Hub	Connectors CU/AL		Bypass	Dimensions			Knockouts					
					Line	Load		D"	W"	H"	1	2	3	4	5	6
U8100-RL	125	7	OH	H.O	#6-2/0	#6-2/0	None	4 $\frac{7}{8}$	10	18 $\frac{1}{2}$	2	2	2	—	$\frac{1}{2}$	$\frac{3}{4}$
U7422-RXL	200	7	OH/UG	C.P.	#6-350	#6-350	None	4 $\frac{7}{8}$	13	19	3	2 $\frac{1}{2}$	3	3	$\frac{1}{4}$	$\frac{1}{2}$

7 Terminal | Ringless | Non-Jaw Clamping Lever Bypass | Single Position | 3Ø4W

Catalog Number	Amp	Terminal	Service	Hub	Connectors CU/AL		Bypass	Dimensions			Knockouts					
					Line	Load		D"	W"	H"	1	2	3	4	5	6
U7573-RL	125	7	OH	H.O.	#6-2/0	#6-2/0	Lever	4 $\frac{7}{8}$	10	18 $\frac{1}{2}$	2	2	2	—	$\frac{1}{2}$	$\frac{3}{4}$
U9320-RXL	125	7	OH/UG	C.P.	#6-2/0	#6-2/0	Lever	4 $\frac{7}{8}$	10	19	3	2 $\frac{1}{2}$	3	3	$\frac{1}{4}$	$\frac{1}{2}$
U7423-RXL	200	7	OH/UG	C.P.	#6-350	#6-350	Lever	4 $\frac{7}{8}$	13	19	3	2 $\frac{1}{2}$	3	3	$\frac{1}{4}$	$\frac{1}{2}$

Notes

- **Hubs:** For proper hub selection see the hub suffix chart on accessory page.
- **Bypass:** 200 amp continuous duty bypass. Lever operates bypass only. Not jaw clamping.
- **Connectors:** Extruded aluminum connectors are tin plated. Units supplied with bonded, duplex neutral.



Please consult serving utility for their requirements prior to ordering or installing, as specifications and approvals vary by utility, and may require local electrical inspector approval. All installations must be installed by a licensed electrician and must comply with all national and local codes, laws and regulations. Milbank reserves the right to make changes in specifications and features shown without notice or obligation.

Lever Bypass Single Position

200 Amp | 4, 5 & 7 Terminal | Ringless

19
200 AMP
LEVER BYPASS
SINGLE
POSITION



U9701-RXL

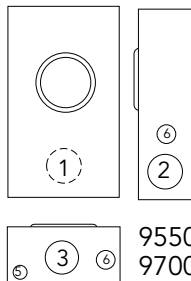

U9800-RRL

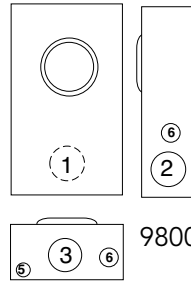

U9551-RXL

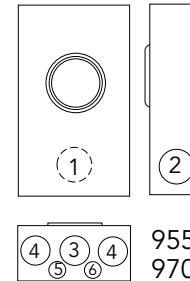

200 Amp | 4 Terminal | Ringless | Jaw Clamping Lever Bypass | Single Position | 1Ø3W or 3Ø3W

Catalog Number	Terminal	Service	Hub	Connectors CU/AL		Bypass	Dimensions			Knockouts					
				Line	Load		D"	W"	H"	1	2	3	4	5	6
U9800-RRL*	4	OH	H.O.	#6-350	#6-350	Lever	4 $\frac{7}{8}$	10	18 $\frac{1}{2}$	3	2 $\frac{1}{2}$	3	—	$\frac{1}{2}$	$\frac{3}{4}$
U9801-RXL*	4	OH/UG	C.P.	#6-350	#6-350	Lever	4 $\frac{7}{8}$	13	19	3	2 $\frac{1}{2}$	3	3	$\frac{1}{4}$	$\frac{1}{2}$

200 Amp | 5 Terminal | Ringless | Jaw Clamping Lever Bypass | Single Position | 1Ø3W or 3Ø3W

Catalog Number	Terminal	Service	Hub	Connectors CU/AL		Bypass	Dimensions			Knockouts					
				Line	Load		D"	W"	H"	1	2	3	4	5	6
U9550-RRL	5	OH	H.O.	#6-350	#6-350	Lever	4 $\frac{7}{8}$	10	18 $\frac{1}{2}$	3	2 $\frac{1}{2}$	3	—	$\frac{1}{2}$	$\frac{3}{4}$
U9551-RXL	5	OH/UG	C.P.	#6-350	#6-350	Lever	4 $\frac{7}{8}$	13	19	3	2 $\frac{1}{2}$	3	3	$\frac{1}{4}$	$\frac{1}{2}$

200 Amp | 7 Terminal | Ringless | Jaw Clamping Lever Bypass | Single Position | 3Ø4W

Catalog Number	Terminal	Service	Hub	Connectors CU/AL		Bypass	Dimensions			Knockouts					
				Line	Load		D"	W"	H"	1	2	3	4	5	6
U9700-RRL	7	OH	H.O.	#6-350	#6-350	Lever	4 $\frac{7}{8}$	10	18 $\frac{1}{2}$	3	2 $\frac{1}{2}$	3	—	$\frac{1}{2}$	$\frac{3}{4}$
U9701-RXL	7	OH/UG	C.P.	#6-350	#6-350	Lever	4 $\frac{7}{8}$	13	19	3	2 $\frac{1}{2}$	3	3	$\frac{1}{4}$	$\frac{1}{2}$

Notes

- **Hubs:** For proper hub selection see the hub suffix chart on accessory page.
- **Bypass:** Lever supplies clamping action and also operates bypass device.
- **Connectors:** Extruded aluminum connectors are tin plated. **U9550** and **U9551** units are supplied with duplex neutral, with removable bonding strap for insulated neutral. **U9700** series units are supplied with duplex neutral.
- * Internal Hex Connectors. For main and/or service disconnect, use with **U5484-O** enclosed circuit breaker.

Please consult serving utility for their requirements prior to ordering or installing, as specifications and approvals vary by utility, and may require local electrical inspector approval. All installations must be installed by a licensed electrician and must comply with all national and local codes, laws and regulations. Milbank reserves the right to make changes in specifications and features shown without notice or obligation.



Lever Bypass Single Position

320 Amp | 4 Terminal | Ringless



U1797-O-K3L-K2L

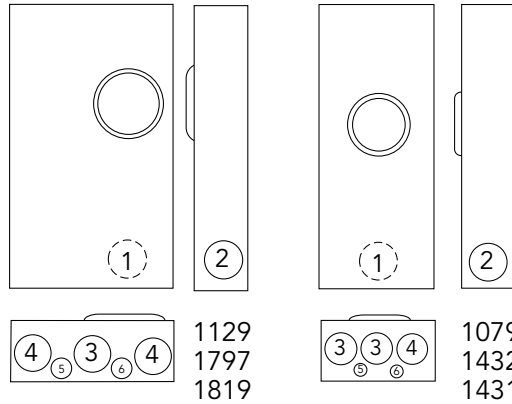

U1129-O-K3L-K2L

320 Amp | 4 Terminal | Ringless | Lever Bypass | Single Position

Catalog Number	Terminal	Service	Hub	Connectors CU/AL		Bypass	Dimensions			Knockouts					
				Line	Load		D"	W"	H"	1	2	3	4	5	6
U1079-R	4	OH	H.O.	3/8" x 16 Studs		Lever	4 7/8	13	38 3/4	3 1/2	2 1/2	3	3	1/4	1/2
U1431-R*	4	OH/UG	H.O.	3/8" x 16 Studs		None	4 7/8	13	38 3/4	3 1/2	2 1/2	3	3	1/4	1/2
U1129-O-K3L-K2L	4	UG	Blank	(1) #4-600 or (2) 1/0-250	Twin #6-350	Lever	4 7/8	15	30	3	2 1/2	3	3	1/4	1/2
U1432-O*	4	UG	Blank	3/8" x 16 Studs		None	4 7/8	13	29 3/4	3 1/2	2 1/2	3	3	1/4	1/2
U1819-X*	4	UG	C.P.	3/8" x 16 Studs		None	4 7/8	15	30	3	3	3	3	1/4	1/2
U1797-O-K3L-K2L	4	UG	Blank	(1) #4-600 or (2) 1/0-250	Twin #6-35	Lever	4 7/8	15	30	3	3	3	3	1/4	1/2

Notes

- **Hubs:** For proper hub selection, see the hub suffix chart on the accessory page.
- ***Bypass:** Lever supplies clamping action on meter spades only on the **U1431**, **U1432** and **U1819**. Lever supplies clamping action and also operates bypass device on the **U1079**, **U1129** & **U1797**.
- **Connector Kits:** Stud type units are supplied with 3/8" x 16 hex head nuts with Belleville washers. Order two connector kits to cover both line and load. Order **K1539** (single #350), **K1540** (single #600) or **K1350** (twin #350). See accessories page.
Note: The **U1129** unit has a single connector on the line side only.
- **Fifth Terminal:** For field mounted fifth terminal, order as extra **K3866** for the **U1079** & **U1431**. Order as extra K3865 for units **U1129**, **U1432**, **U1819**, and **U1797**.
- **Lug Size Range:** See accessories page for lug size range for the U1129 & U1797 units.



Please consult serving utility for their requirements prior to ordering or installing, as specifications and approvals vary by utility, and may require local electrical inspector approval. All installations must be installed by a licensed electrician and must comply with all national and local codes, laws and regulations. Milbank reserves the right to make changes in specifications and features shown without notice or obligation.

Link Bypass Single Position

320 Amp | 4 Terminal | Ring Type

21
320 AMP
LINK BYPASS
SINGLE
POSITION



U3548-X

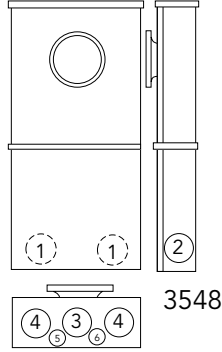

U5056-O

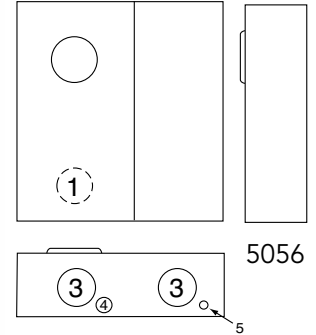

320 Amp | 4 Terminal | Ring Type | Link Bypass | Single Position | 1Ø3W

Catalog Number	Terminal	Service	Hub	Connectors CU/AL		Bypass	Dimensions			Knockouts					
				Line	Load		D"	W"	H"	1	2	3	4	5	6
U3548-X*	4	OH/UG	C.P.	Single = 4-600 Parallel = 1/0-250		Link	6	14	33	3	3	3	3	¼	½
U5056-O	4	UG	Blank	1/2"x13 Studs	#4-600 or Twin 1/0-250	Link	6	24	32	3	—	4	½	¼	—

Notes

- **Sealing Ring:** Ring type units are supplied with an **MR-4**, screw type, sealing ring as standard.
- **Triple Tap Lug:** For triple tap lug kit order **K5049**, wire range **#6-250** kcmil.
- **Link Bypass:** Links provided by utility.
- * **Flush Mount Kit:** For field mounted flush mount kit order **K4086**.

Please consult serving utility for their requirements prior to ordering or installing, as specifications and approvals vary by utility, and may require local electrical inspector approval. All installations must be installed by a licensed electrician and must comply with all national and local codes, laws and regulations. Milbank reserves the right to make changes in specifications and features shown without notice or obligation.



Lever Bypass Single Position

320 Amp | 7 Terminal | Ringless



U2120-X

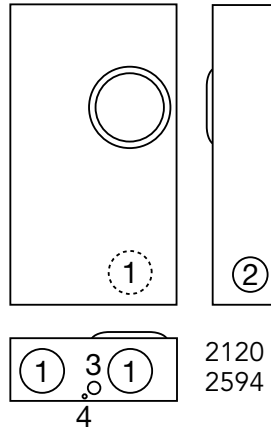

2120
2594



U2827-X

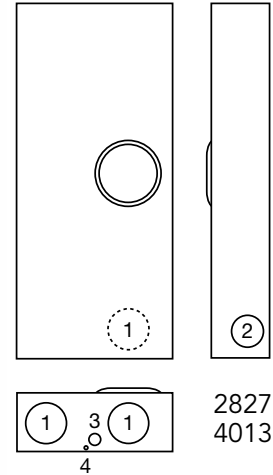

2827
4013

320 Amp | 7 Terminal | Ringless | Lever Bypass | Single Position | Side Wireway

Catalog Number	Terminal	Service	Hub	Connectors CU/AL		Bypass	Dimensions			Knockouts			
				Line	Load		D"	W"	H"	1	2	3	4
U4013-X	7	OH/UG	C.P.	3/8"x16 Studs		Lever	6½	19	34½	4	3	1	¼
U2594-X	7	OH/UG	C.P.	3/8"x16 Studs		Lever	6½	19¾	34½	4	3	1	¼
U2827-X*	7	OH/UG	C.P.	3/8"x16 Studs		non-bypass	6½	17¾	31	4	3	1	¼
U2120-X	7	UG	C.P.	3/8"x16 Studs		Lever	6½	17¾	31¾	4	3	1	¼

Notes

- **Bypass:** Lever supplies clamping action on meter spades and operates bypass device.
- *U2827 has lever with jaw clamping capabilities but no bypass.
- **Connector Kits:** Stud type units are supplied with 3/8"x16 hex head nuts with Belleville washers. Order two connector kits to cover both line and load. For single lug connector kits for the U2120 and U2594 units, order as extra K3082 (350 kcmil) or K3441 (600 kcmil). For twin lug connectors order as extra: K3442 (350 kcmil). Separate kits are required for both line and load.



Please consult serving utility for their requirements prior to ordering or installing, as specifications and approvals vary by utility, and may require local electrical inspector approval. All installations must be installed by a licensed electrician and must comply with all national and local codes, laws and regulations. Milbank reserves the right to make changes in specifications and features shown without notice or obligation.

Service Entrance

100-200 Amp | 4 Terminal | Main Breaker

23
SERVICE
ENTRANCE



USE-AP-200-ML

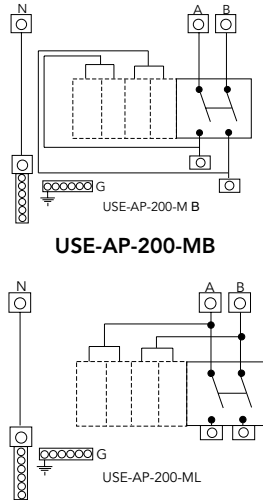
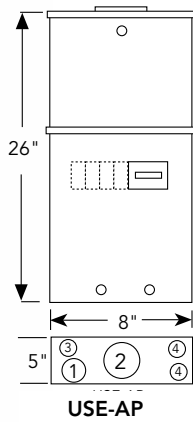

USE-AP-200-ML

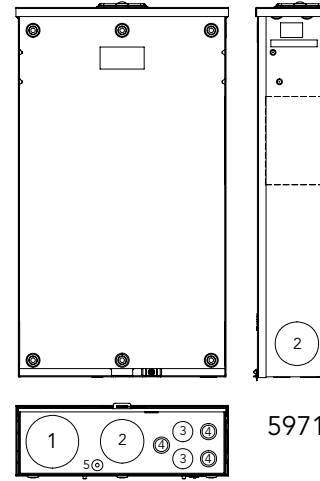

U5971-XL-100



U5971-XL-200

200 Amp | Breaker Enclosure | 1Ø3W | 120/240 Volt | 10K AIC Rating

Catalog Number	Terminal	Service	Hub	Connectors CU/AL		Dimensions			Knockouts			
				Line	Load	D"	W"	H"	1	2	3	4
USE-AP-200-MB	4	OH	2"	#4-250	#4-250	5	8	26	1	2	¾	¾
USE-AP-200-ML	4	OH	2"	#4-250	#4-250	5	8	26	1	2	¾	¾

Notes

- **USE-AP-200-MB:** 200 amp main wired in series with plug-in style bus. **UQFP-M-200** factory installed. Additional 4 branch circuits available for (1) two-pole and (2) one-pole, or (4) one pole breakers. **One 2" hub included.**
- **USE-AP-200-ML:** 200 amp main wired in series with plug-in style bus. **UQFP-200** factory installed. Additional 4 branch circuits available for (1) two-pole and (2) one-pole, or (4) one pole breakers. **One 2" hub included.**

100-200 Amp | Load Center with Main Breaker | 120/240V

Catalog Number	Main Breaker Amp	Branch Circuits	Service	Hub	Dimensions			Knockouts				
					D"	W"	H"	1	2	3	4	5
U5971-XL-100	100	10	OH/UG	C.P.	4½	14⅞	25⅙	3	2½	1	½,¾	¼,½
U5971-XL-200	200	8	OH/UG	C.P.	4½	14⅞	25⅙	3	2½	1	½,¾	¼,½

Notes

- **AIC Rating:** 22K AIC rating.
- **Line Terminals:** As specified on circuit breaker (300 kcmil max).
- **Load Terminals:** As specified on circuit breakers (#1 AWG max).
- **Breaker Interlock:** Order **K5815** for 200A or 150A to 100A breakers (large frame to small frame). Order **K5820** for 200A or 150A to 200A or 150A breakers (large frame to large frame). Order **K5830** for 100A to 100A (small frame to small frame).

Please consult serving utility for their requirements prior to ordering or installing, as specifications and approvals vary by utility, and may require local electrical inspector approval. All installations must be installed by a licensed electrician and must comply with all national and local codes, laws and regulations. Milbank reserves the right to make changes in specifications and features shown without notice or obligation.





U3574-RL-200

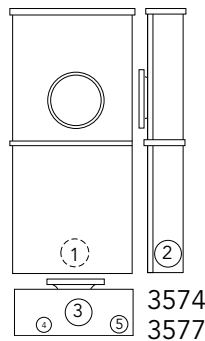
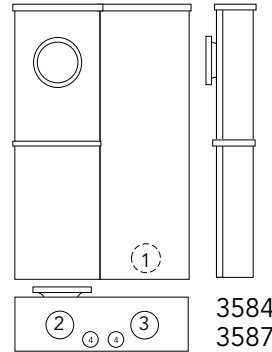

200 Amp | 4 Terminal | Ring Type | 240 Volt

Catalog Number	Terminal	Service	Breaker	Connectors CU/AL		Dimensions			Knockouts					
				Line	Load	D"	W"	H"	1	2	3	4	5	6
U3574-RL-200	4	OH	200A-2P	#2-350	#3-300	4 $\frac{1}{8}$	8	30	2	2	2 $\frac{1}{2}$	$\frac{1}{4}$	$\frac{1}{2}$	—
U3584-O-200	4	UG	200A-2P	#6-350	#3-300	5 $\frac{1}{2}$	14 $\frac{1}{8}$	26	3	3	3	$\frac{1}{2}$	—	—

200 Amp | 7 Terminal | Ring Type | 240 Volt

Catalog Number	Terminal	Service	Breaker	Connectors CU/AL		Dimensions			Knockouts					
				Line	Load	D"	W"	H"	1	2	3	4	5	6
U3577-RL-200	7	OH	200A-3P	#2-350	#3-300	4 $\frac{7}{8}$	10	34	2	2	2 $\frac{1}{2}$	$\frac{1}{4}$	$\frac{1}{2}$	—
U3587-O-200	7	UG	200A-3P	#6-350	#3-300	5 $\frac{1}{2}$	14 $\frac{1}{8}$	26	3	3	3	$\frac{1}{2}$	—	—

Notes

- **Breakers:** Units are supplied with bolt-on 200 amp circuit breakers where specified above.
- **Sealing Rings:** Units are supplied with an **MR-4** screw type sealing ring.



Please consult serving utility for their requirements prior to ordering or installing, as specifications and approvals vary by utility, and may require local electrical inspector approval. All installations must be installed by a licensed electrician and must comply with all national and local codes, laws and regulations. Milbank reserves the right to make changes in specifications and features shown without notice or obligation.

Meter Main with Load Center

100–200 Amp | 4 & 5 Terminal | Ringless & Ring Type

25
100-200 AMP
METER MAINS

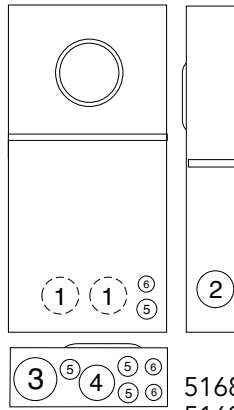

5168 5268
5169 5269



Generator Interlock

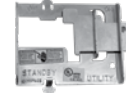

K5815 - large QN with small frame Q

K5820 - large frame QN with large frame QN

K5830 - small frame Q to small frame Q

U5168-XTL-200

U5268-XTL-200-KK

100–200 Amp | Meter Mains | 120/240 Volts | 1Ø3W | Overhead/Underground

Catalog Number	Terminal	Amp	Circuits	Hub	Connectors	Bypass	Dimensions			Knockouts					
							D"	W"	H"	1	2	3	4	5	6
U5168-XTL-100*	4	100	10	C.P.	#6-350	None	4½	14⅞	32	2	2	3	2½	1	¾
U5168-XTL-150*	4	150	8	C.P.	#6-350	None	4½	14⅞	32	2	2	3	2½	1	¾
U5168-XTL-200*	4	200	8	C.P.	#6-350	None	4½	14⅞	32	2	2	3	2½	1	¾
U5168-XTL-100-KK*	4	100	10	C.P.	#6-350	Horn	4½	14⅞	32	2	2	3	2½	1	¾
U5168-XTL-150-KK*	4	150	8	C.P.	#6-350	Horn	4½	14⅞	32	2	2	3	2½	1	¾
U5168-XTL-200-KK*	4	200	8	C.P.	#6-350	Horn	4½	14⅞	32	2	2	3	2½	1	¾
U5168-XTL-100-KK-5T*	5	100	10	C.P.	#6-350	Horn	4½	14⅞	32	2	2	3	2½	1	¾
U5168-XTL-150-KK-5T*	5	150	8	C.P.	#6-350	Horn	4½	14⅞	32	2	2	3	2½	1	¾
U5169-XTL-100	4	100	10	C.P.	#6-350	None	4½	14⅞	32	2	2	3	2½	1	¾
U5169-XTL-150	4	150	8	C.P.	#6-350	None	4½	14⅞	32	2	2	3	2½	1	¾
U5169-XTL-200	4	200	8	C.P.	#6-350	None	4½	14⅞	32	2	2	3	2½	1	¾
U5268-XTL-150*	4	150	20	C.P.	#6-350	None	4½	14⅞	32	2	2	3	2½	1	¾
U5268-XTL-200*	4	200	20	C.P.	#6-350	None	4½	14⅞	32	2	2	3	2½	1	¾
U5268-XTL-150-KK*	4	150	20	C.P.	#6-350	Horn	4½	14⅞	32	2	2	3	2½	1	¾
U5268-XTL-200-KK*	4	200	20	C.P.	#6-350	Horn	4½	14⅞	32	2	2	3	2½	1	¾
U5269-XTL-200	4	200	20	C.P.	#6-350	None	4½	14⅞	32	2	2	3	2½	1	¾

Notes

- **Hubs:** Supplied with (2) closing plates packed inside. Order hubs as a separate item. See accessory page for hub options.
- **Interior:** U5168 units have 8-circuit interior; U5268 units have 20-circuit interior
- **Fifth Terminal:** Order K5T and field install for 208Y/120 network systems. Installs in the 9 o'clock position only.
- **Branch Breakers:** Series rated 22K AIC with Milbank QNR2200H main installed.
- **Interlock Kit:** For generator auxiliary circuit breaker interlock, order K5815 for large QN with small frame Q; order K5820 for large frame QN with large frame QN; order K5830 for small frame Q with small frame Q.
- **Sub-Feed Lugs:** #6-350 kcmil sub-feed lugs provided on 8 and 10 circuit interior. **Not available on 20 circuit interior.**
- Amp rating limited to main breaker rating.

* Ringless

Please consult serving utility for their requirements prior to ordering or installing, as specifications and approvals vary by utility, and may require local electrical inspector approval. All installations must be installed by a licensed electrician and must comply with all national and local codes, laws and regulations. Milbank reserves the right to make changes in specifications and features shown without notice or obligation.



Heavy Duty Lever Bypass Meter Mains

320 Amp | 4 Terminal | Ringless



U5059-X-2/200

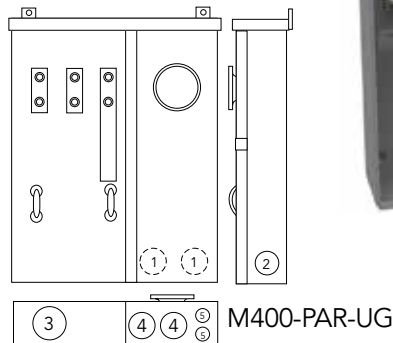
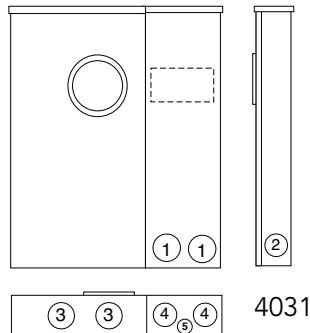
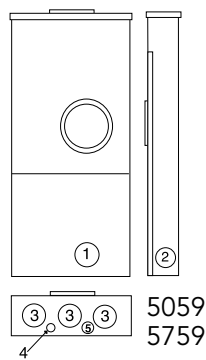

U4031-O-2/200

320 Amp | 4 Terminal | Ringless | 1Ø3W | 22K AIC Rating

Catalog Number	Terminal	Service	Primary Disconnect	Secondary Disconnect	Bypass	Dimensions			Knockouts				
						D"	W"	H"	1	2	3	4	5
U5759-X-2/200*2	4	OH/UG	200 Amp/2 Pole Circuit Breaker	200 Amp/2 Pole Circuit Breaker	None	4 ⁷ / ₈	15	42	2 ¹ / ₂	2 ¹ / ₂	3	¼	½
U5059-X-2/200 ²	4	OH/UG	200 Amp/2 Pole Circuit Breaker	200 Amp/2 Pole Circuit Breaker	Lever	4 ⁷ / ₈	15	42	2 ¹ / ₂	2 ¹ / ₂	3	¼	½
U4031-O-2/200 ²	4	UG	200 Amp/2 Pole Circuit Breaker	200 Amp/2 Pole Circuit Breaker	Lever	5 ³ / ₄	25	30	3	3	4	3	½
M400-PAR-UG**1	4	UG	200 Amp/2 Pole Circuit Breaker	See Note¹	Lever	6 ¹ / ₈	22 ¹ / ₈	36	2	2	4	2	¾

Notes

- **Amperage Rating:** 400 amp, 320 amp continuous.
- **Neutral:** Bonded neutral and ground factory installed.
- **Flush Mount:** Flush mounting available on underground units. Order catalog number **FK-M400-UG** separately.
- **Short Circuit Current Withstand Rating:** 22K AIC Standard.
- **Bypass:** Lever supplies clamping action and operates bypass device.
- **Fifth Terminal:** For field installed fifth terminal for the **U5059** & **U5759**, order separately catalog number **K3866**.
- **Conversion Kit:** To field convert **M400** UG units to OH, order **K4787-F**. Includes connectors (#2-600).

¹ 200 amp primary disconnect factory installed. Order secondary disconnect separately. Specify **UQFPH-100, 125, 150, 175** or **200**.

² **Line Side Connector Kits:** Two 1/2" studs per phase on 1-3/4" centers. Factory installed for the **U5759**, for the **U5059** order anti-rotation connector kit **K1540L** to accommodate #4-600 kcmil single or **K1350L** for twin 350 kcmil connectors.

* Lever supplies clamping action only—does NOT operate bypass on the **U5759**.

** **Lug Kit:** Mechanical lug kit available for **M400-APS-UG**, order **K4920** (#2-500).



Please consult serving utility for their requirements prior to ordering or installing, as specifications and approvals vary by utility, and may require local electrical inspector approval. All installations must be installed by a licensed electrician and must comply with all national and local codes, laws and regulations. Milbank reserves the right to make changes in specifications and features shown without notice or obligation.

Meter Main with Split Load

320 Amp | 4 Terminal | Ring Type

27
320 AMP
METER MAINS



M400-APS-BS

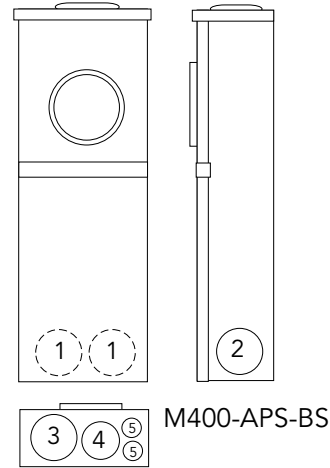

320 Amp | 4 Terminal | Ring Type | 1Ø3W | Type 3R | 120/240 Volt

Catalog Number	Terminal	Service	Primary Disconnect	Secondary Disconnect	Bypass	Dimensions			Knockouts					
						D"	W"	H"	1	2	3	4	5	6
M400-APS	4	OH	200 Amp/2 Pole Circuit Breaker	See Note ¹	None	6 ¹ / ₈	9 ¹ / ₂	47 ¹ / ₈	2	2	2	1 ¹ / ₂	3/4	—
M400-APS-BS	4	OH	200 Amp/2 Pole Circuit Breaker	See Note ¹	Link	6	11 ¹ / ₂	47	2 ¹ / ₂	2 ¹ / ₂	3	3	3/4	—

Notes

- **Amperage Rating:** 400 amp, 320 amp continuous.
- **Neutral:** Bonded neutral and ground factory Installed.
- **Line Side Connectors:** Connectors provided for 4-600 or twin 1/0-250.
- **Overhead:** Overhead units include one 3" hub.

¹ 200 amp primary disconnect factory installed. Order secondary disconnect separately. Specify **UQFPH-100, 125, 150, 175** or **200**.

Please consult serving utility for their requirements prior to ordering or installing, as specifications and approvals vary by utility, and may require local electrical inspector approval. All installations must be installed by a licensed electrician and must comply with all national and local codes, laws and regulations. Milbank reserves the right to make changes in specifications and features shown without notice or obligation.



Meter Main with Split Load

320 Amp | 4 Terminal | Ring Type



M400-UG-APS-F

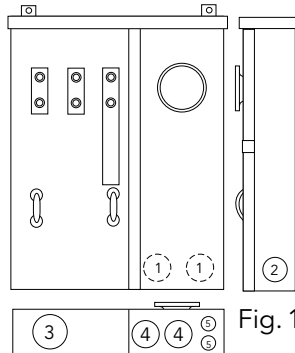

Fig. 1

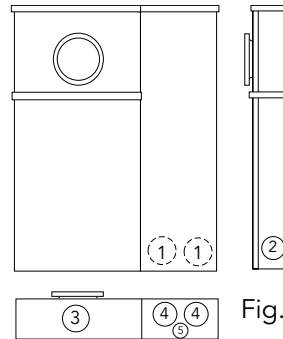

Fig. 2



U3251-O-200-CB

320 Amp | 4 Terminal | Ring Type | 1Ø3W | Type 3R | 120/240 VAC

Catalog Number	Terminal	Service	Primary Disconnect	Secondary Disconnect	Bypass	Dimensions			Knockouts					Fig.
						D"	W"	H"	1	2	3	4	5	
M400-UG-APS-F ¹	4	UG	200 Amp/2 Pole Circuit Breaker	See Note ¹	None	6½	22½	36	2	2	4	2	¾	1
M400-UG-APS-F-BS ¹	4	UG	200 Amp/2 Pole Circuit Breaker	See Note ¹	Link	6	29	41⅞	2	2	4	2	¾	1
M400-UG-APS-P ²	4	UG	200 Amp 2 Pole-T-Fuse	200 Amp 2 Pole-T-Fuse	None	6½	22½	36	2	2	4	2	¾	1
M400-UG-APS-LC ⁴	4	UG	200 Amp/2 Pole Circuit Breaker	200 Amp/2 Pole Circuit Breaker	None	6	29	41⅞	2½	1	4	2½	¾	2
M400-UG-APS-LC-BS ⁴	4	UG	200 Amp/2 Pole Circuit Breaker	200 Amp/2 Pole Circuit Breaker	Link	6	29	41⅞	2½	1	4	2½	¾	2
U3251-O-200-CB ³	4	UG	200 Amp/2 Pole Circuit Breaker	200 Amp/2 Pole Circuit Breaker	Link	6¾	24	40¼	3	3	4	3	⅞	2

Notes

- **Amperage Rating:** 400 amp, 320 amp continuous.
- **EUSERC:** Meets EUSERC requirements. Consult local utility for acceptability before ordering or installing.
- **Neutral:** Bonded neutral and ground factory Installed.
- **Line Side Connectors:** Two 1/2" studs per phase on 1-3/4" centers.
- **Load Side Connectors:** 1/0-300
- **Flush Mount:** Flush mount kit included with **M400-UG-APS-F**, **M400-UG-APS-FBS**, **M400-UG-APS-LC** and **M400-UG-APS-LC-BS**. Available for other underground units. Order catalog number **FK-M400-UG** separately.
- **Short Circuit Current Withstand Rating:** 22K AIC standard, 200k aic standard on T-fuse models.
- **Lug Kit:** Mechanical lug kit available, order **K4920** (#2-500).
- **Conversion Kit:** To field convert **M400** UG units to OH, order **K4787-F**.

¹ 200 amp primary disconnect factory installed. Order secondary disconnect separately. Specify **UQFPH-100, 125, 150, 175** or **200**.

² Two 200 amp T-fuse pull-outs factory installed as primary and secondary disconnects.

³ Two 200 amp 2-pole bolt-on **UQFBH** main breakers factory installed.

⁴ **Breakers:** Two 200 amp 2-pole main breakers factory installed, and semi-flush flange kit packed inside meter section. Universal Copper 24/40 Circuit interior accepts Challenger, GE, Murray, Siemens/ITE, and Cutler-Hammer/Westinghouse universal type plug-in branch circuit breakers.



Please consult serving utility for their requirements prior to ordering or installing, as specifications and approvals vary by utility, and may require local electrical inspector approval. All installations must be installed by a licensed electrician and must comply with all national and local codes, laws and regulations. Milbank reserves the right to make changes in specifications and features shown without notice or obligation.

Meter Main Combination

320 Amp | 4 Terminal | Ring Type



M401-UG

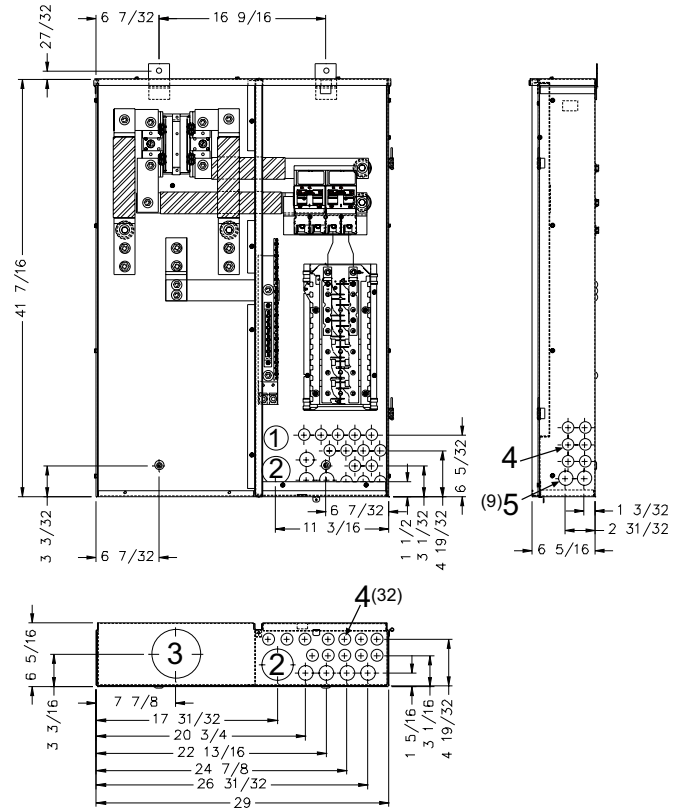
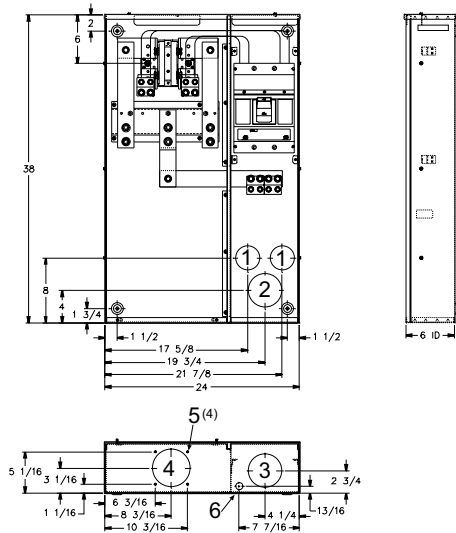

M400-UG-APS-LC
(see previous page for details)

320 Amp Main Breaker | 4 Terminal | Ring Type | 1Ø3W | Type 3R | 120/240 Volt

Catalog Number	Terminal	Service	Main Disconnect	Bypass	Connectors CU/AL		Dimensions			Knockouts					
					Line	Load	D"	W"	H"	1	2	3	4	5	6
M401-UG	4	UG	(1) 400 Amp 2 Pole Breaker	None	Studs	C.B.*	6	24	38	2½	3½	3½	4	¼	½
M401-UG-BS	4	UG	(1) 400 Amp 2 Pole Breaker	Link	Studs	C.B.*	6	24	38	2½	3½	3½	4	¼	½

Notes

- **Amperage Rating:** 400 amp, 320 amp continuous.
 - **Neutral:** Bonded neutral and ground factory installed.
 - **Load Side Connectors:** Two 1/2" studs per phase on 1-3/4" centers.
 - **Lug Kit:** Mechanical lug kit available, order **K4920** (#2-500).
 - **Flush Mount:** Flush mounting available on underground units. Order catalog number **FK-M400-UG** separately.
 - **Short Circuit Current Withstand Rating:** 22K AIC standard.
- * C.B. load side (1) or (2) copper conductors 3/0-500, (2) aluminum conductors 4/0-500 or (1) aluminum conductor 250-500.

Please consult serving utility for their requirements prior to ordering or installing, as specifications and approvals vary by utility, and may require local electrical inspector approval. All installations must be installed by a licensed electrician and must comply with all national and local codes, laws and regulations. Milbank reserves the right to make changes in specifications and features shown without notice or obligation.



Meter Main Combination

320 Amp | 4 Terminal | Ring Type



M404-UG-LC

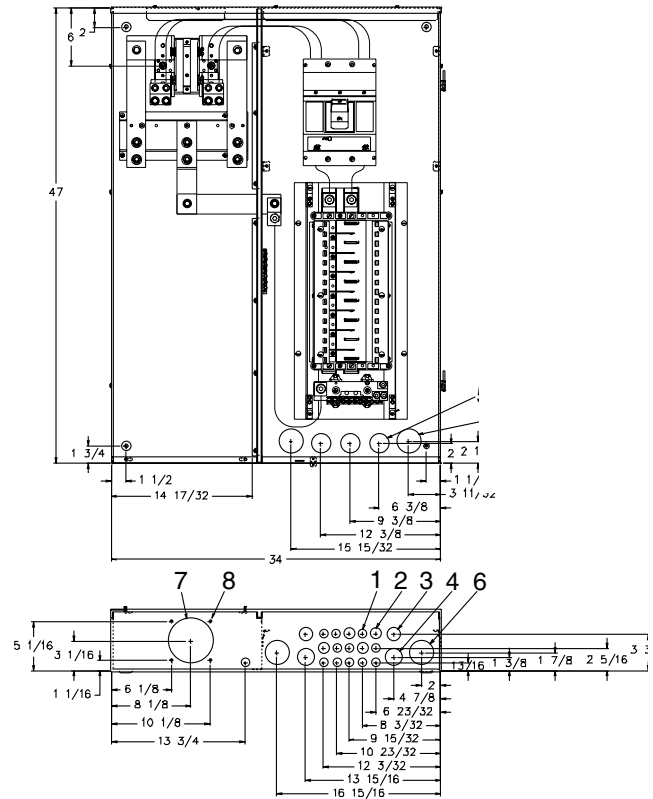

Knockouts

- 1 = (12) 1/2"
- 2 = (4) 1/2, 3/4"
- 3 = (4) 3/4, 1"
- 4 = (2) 1/2, 3/4, 1, 1-1/4"
- 5 = (3) 3/4, 1, 1-1/4, 1-1/2"
- 6 = (4) 1, 1 1/4, 1-1/2, 2"
- 7 = (1) 3, 3-1/2, 4"
- 8 = (4) 1/4" diameter hole

320 Amp Main With Circuit Load Center | 4 Terminal | Ring Type | 1Ø3W | 120/240 Volt

Catalog Number	Terminal	Service	Primary Disconnect	Secondary Disconnect	Bypass	Dimensions			Knockouts							
						D"	W"	H"	1	2	3	4	5	6	7	8
M404-UG-LC*	4	UG	400 Amp 2 Pole Breaker	NA	None	6	34	47	1/2	3/4	1	1 1/4	1 1/2	2	4	1/4
M404-UG-LC-BS*	4	UG	400 Amp 2 Pole Breaker	NA	Link	6	34	47	1/2	3/4	1	1 1/4	1 1/2	2	4	1/4

Notes

- **Amperage Rating:** 400 amp, 320 amp continuous.
- **Neutral:** Bonded neutral and ground factory installed.
- **Line Side Connectors:** Two 1/2" studs per phase on 1-3/4" centers.
- **Flush Mount:** Flush mounting available on underground units. Order catalog number **FK-M404-UGLC** separately.
- **Short Circuit Current Withstand Rating:** 22K AIC standard.
- **Lug Kit:** Mechanical lug kit available, order **K4920** (#2-500).
- **Branch Breakers:** Use Siemens, Cutler-Hammer, GE or Siemens/Murray breakers to maintain 22K rating.
- * Includes a 30-circuit load center.



Please consult serving utility for their requirements prior to ordering or installing, as specifications and approvals vary by utility, and may require local electrical inspector approval. All installations must be installed by a licensed electrician and must comply with all national and local codes, laws and regulations. Milbank reserves the right to make changes in specifications and features shown without notice or obligation.

Test Block Bypass/Safety Sockets

100 & 200 Amp | 4, 5 & 7 Terminal | Ring Type

31
100 & 200 AMP
SAFETY SOCKETS

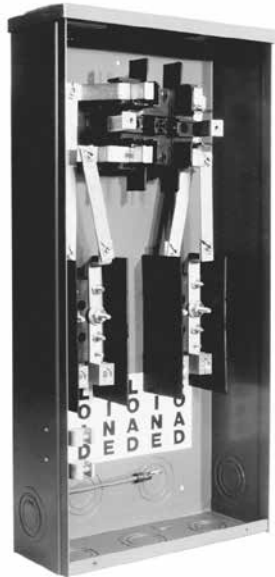

114TB

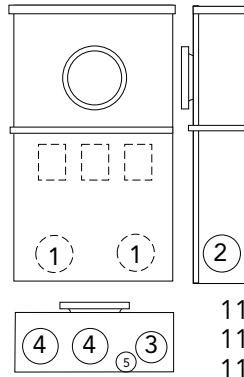

114TB
115TB
117TB

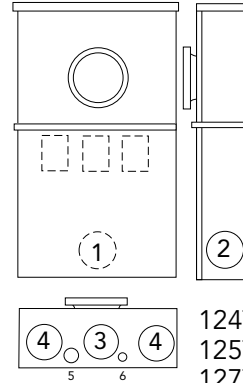

124TB
125TB
127TB



127TB

100 Amp | 4, 5 & 7 Terminal | Ring Type | 600 Volt Self-Contained | Socket Only

Catalog Number	Terminal	Service	Type of Service	Connectors CU/AL		Dimensions			Knockouts					
				Line	Load	D"	W"	H"	1	2	3	4	5	6
114TB*	4	OH/UG	1Ø3W*	#6-1/0	#6-1/0	4 ⁵ / ₈	12	25	2	2	1½	2	½	—
115TB	5	OH/UG	3Ø3W	#6-1/0	#6-1/0	4 ⁵ / ₈	12	25	2	2	1½	2	½	—
117TB	7	OH/UG	3Ø4W	#6-1/0	#6-1/0	4 ⁵ / ₈	12	25	2	2	1½	2	½	—

200 Amp | 4, 5 & 7 Terminal | Ring Type | 600 Volt Self-Contained | Socket Only

Catalog Number	Terminal	Service	Type of Service	Connectors CU/AL		Dimensions			Knockouts					
				Line	Load	D"	W"	H"	1	2	3	4	5	6
124TB*	4	OH/UG	1Ø3W*	#1/0-250	#1/0-250	6	14	30	2½	2½	3	3	¼	½, ¼
125TB	5	OH/UG	3Ø3W	#1/0-250	#1/0-250	6	14	30	2½	2½	3	3	¼	½, ¼
127TB	7	OH/UG	3Ø4W	#1/0-250	#1/0-250	6	14	30	2½	2½	3	3	¼	½, ¼

Notes

- **Hubs:** OH units use hub up to 2-1/2" (see accessory page). Units provided with closing plates.
- **Sealing Rings:** Units furnished with MR-2 snap style sealing rings.
- **Ring Protector:** Add suffix **-RP** to catalog number for factory installed ring protector (ex. **117TB** becomes **117TB-RP**).
- * For 3W (208Y/120) network service, install field mounted fifth terminal catalog number **105J**. See accessories page.

**SHORT CIRCUIT CURRENT WITHSTAND RATING UP TO 200K AIC
DEPENDENT ON OVERCURRENT PROTECTION DEVICE USED**

Please consult serving utility for their requirements prior to ordering or installing, as specifications and approvals vary by utility, and may require local electrical inspector approval. All installations must be installed by a licensed electrician and must comply with all national and local codes, laws and regulations. Milbank reserves the right to make changes in specifications and features shown without notice or obligation.



Test Block Bypass/MTB Series

100 Amp | 4, 5 & 7 Terminal | Ring Type | 10K AIC



U214MTB

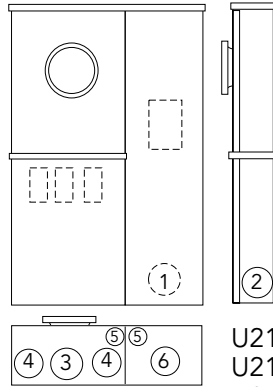

U214MTB
U215MTB
U217MTB

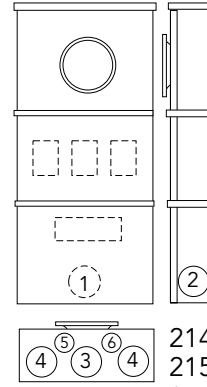

214MT
215MT
217MT



217MTB

100 Amp | 4, 5 & 7 Terminal | Ring Type | 240 Volt Self-Contained | Circuit Breaker

Catalog Number	Terminal	Service	Type of Service	Connectors CU/AL		Dimensions			Knockouts					
				Line	Load	D"	W"	H"	1	2	3	4	5	6
214MTB*	4	OH	1Ø3W*	#6-2/0	#14-1/0	4 ⁵ / ₈	12	34	2	2	2	1½	—	½
215MTB	5	OH	3Ø3W	#6-2/0	#14-1/0	4 ⁵ / ₈	12	34	2	2	2	1½	—	½
217MTB	7	OH	3Ø4W	#6-2/0	#14-1/0	4 ⁵ / ₈	12	34	2	2	2	1½	—	½
U214MTB*	4	OH/UG	1Ø3W*	#6-2/0	#14-1/0	4 ⁵ / ₈	18	25	2	2	2½	1½	¾	1½
U215MTB	5	OH/UG	3Ø3W	#6-2/0	#14-1/0	4 ⁵ / ₈	18	25	2	2	2½	1½	¾	1½
U217MTB	7	OH/UG	3Ø4W	#6-2/0	#14-1/0	4 ⁵ / ₈	18	25	2	2	2½	1½	¾	1½

Notes

- **Replacement Main Disconnects:** For replacement main disconnect see pages 42-43.
- **Hubs:** OH units use hub up to 2-1/2" (see accessory page). Units provided with closing plates.
- **Sealing Rings:** Units furnished with MR-2 snap style sealing rings.
- * For 3W (208Y/120) network service, install field mounted fifth terminal catalog number 105J. See accessories page.

These UL listed products are for use in areas requiring Electrical Utility Service Equipment Requirements Committee (EUSERC) compliance.



Please consult serving utility for their requirements prior to ordering or installing, as specifications and approvals vary by utility, and may require local electrical inspector approval. All installations must be installed by a licensed electrician and must comply with all national and local codes, laws and regulations. Milbank reserves the right to make changes in specifications and features shown without notice or obligation.

Test Block Bypass/MTB Series

100 Amp | 4 & 7 Terminal | Ring Type | 22K AIC

33
100 AMP
TEST BLOCK
BYPASS



U214MTB/22

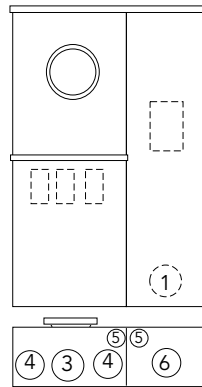

U214MTB/22
U217MTB/22

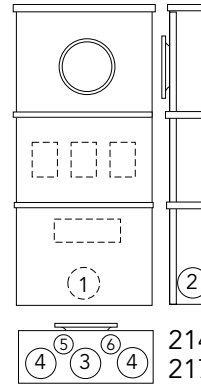

214MTB/2
217MTB/2



217MTB/2

100 Amp | 4 & 7 Terminal | Ring Type | 240 Volt Self-Contained | Circuit Breaker

Catalog Number	Terminal	Service	Type of Service	Connectors CU/AL		Dimensions			Knockouts					
				Line	Load	D"	W"	H"	1	2	3	4	5	6
214MTB/22*	4	OH	1Ø3W*	#6-2/0	#14-1/0	4 $\frac{5}{8}$	12	34	2	2	2	1 $\frac{1}{2}$	—	$\frac{1}{2}$
217MTB/22	7	OH	3Ø4W	#6-2/0	#14-1/0	4 $\frac{5}{8}$	12	34	2	2	2	1 $\frac{1}{2}$	—	$\frac{1}{2}$
U214MTB/22*	4	OH/UG	1Ø3W*	#6-2/0	#14-1/0	4 $\frac{5}{8}$	18	25	2	2	2 $\frac{1}{2}$	1 $\frac{1}{2}$	$\frac{3}{4}$	1 $\frac{1}{2}$
U217MTB/22	7	OH/UG	3Ø4W	#6-2/0	#14-1/0	4 $\frac{5}{8}$	18	25	2	2	2 $\frac{1}{2}$	1 $\frac{1}{2}$	$\frac{3}{4}$	1 $\frac{1}{2}$

Notes

- **Replacement Main Disconnects:** For replacement main disconnect see pages 42-43.
 - **Hubs:** OH units use hub up to 2-1/2" (see accessory page). Units provided with closing plates.
 - **Sealing Rings:** Units furnished with MR-2 snap style sealing rings.
- * For 3W (208Y/120) network service, install field mounted fifth terminal catalog number 105J. See accessories page.

*These UL listed products are for use in areas requiring
Electrical Utility Service Equipment Requirements Committee (EUSERC) compliance.*

Please consult serving utility for their requirements prior to ordering or installing, as specifications and approvals vary by utility, and may require local electrical inspector approval. All installations must be installed by a licensed electrician and must comply with all national and local codes, laws and regulations. Milbank reserves the right to make changes in specifications and features shown without notice or obligation.



Test Block Bypass/MTB Series

100 Amp | 4, 5 & 7 Terminal | Ring Type | 14K AIC | 480 Volt



217MTB-48

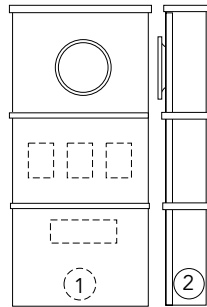

214MTB-48
215MTB-48
217MTB-48

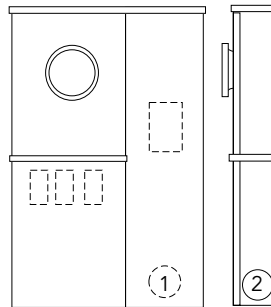

U214MTB-48
U215MTB-48
U217MTB-48



U214MTB-48

100 Amp | 4, 5 & 7 Terminal | Ring Type | 480 Volt Self-Contained | Circuit Breaker

Catalog Number	Terminal	Service	Type of Service	Connectors CU/AL		Dimensions			Knockouts					
				Line	Load	D"	W"	H"	1	2	3	4	5	6
214MTB-48*	4	OH	1Ø3W*	#6-2/0	#14-1/0	6	14	48	2½	2½	3	3	¼	½
215MTB-48	5	OH	3Ø3W	#6-2/0	#14-1/0	6	14	48	2½	2½	3	3	¼	½
217MTB-48	7	OH	3Ø4W	#6-2/0	#14-1/0	6	14	48	2½	2½	3	3	¼	½
U214MTB-48*	4	OH/UG	1Ø3W*	#6-2/0	#14-1/0	4⅝	18	25	2	2	2½	1½	½, ¾	1½
U217MTB-48	7	OH/UG	3Ø4W	#6-2/0	#14-1/0	4⅝	18	25	2	2	2½	1½	½, ¾	1½

Notes

- **Replacement Main Disconnects:** For replacement main disconnect see pages 42-43.
 - **Hubs:** OH units use hub up to 2-1/2" (see accessory page). Units provided with closing plates.
 - **Sealing Rings:** Units furnished with **MR-2** snap style sealing rings.
- * For 3W (208Y/120) network service, install field mounted fifth terminal catalog number **105J**. See accessories page.

These UL listed products are for use in areas requiring Electrical Utility Service Equipment Requirements Committee (EUSERC) compliance.



Please consult serving utility for their requirements prior to ordering or installing, as specifications and approvals vary by utility, and may require local electrical inspector approval. All installations must be installed by a licensed electrician and must comply with all national and local codes, laws and regulations. Milbank reserves the right to make changes in specifications and features shown without notice or obligation.

Test Block Bypass/MTB-P & MTB-P48 Series

35
100 AMP
TEST BLOCK
BYPASS

100 Amp | 4, 5 & 7 Terminal | Ring Type | 200K AIC



214MTB-P

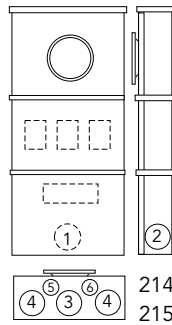

214MTB-P
215MTB-P
217MTB-P
214MTB-P48
215MTB-P48
217MTB-P48

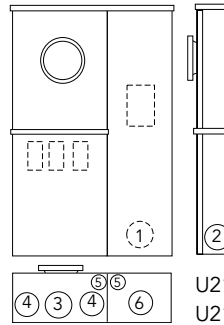

U214MTB-P
U215MTB-P
U217MTB-P
U214MTB-P48
U215MTB-P48
U217MTB-P48



U217MTB-P

100 Amp | 4, 5 & 7 Terminal | Ring Type | 240 Volt Self-Contained | T-Fuse Pullout

Catalog Number	Terminal	Service	Type of Service	Connectors CU/AL		Dimensions			Knockouts					
				Line	Load	D"	W"	H"	1	2	3	4	5	6
214MTB-P*	4	OH	1Ø3W*	#1/0-250	#14-1/0	6	14	48	2½	2½	3	3	¼	½
215MTB-P	5	OH	3Ø3W	#1/0-250	#14-1/0	6	14	48	2½	2½	3	3	¼	½
217MTB-P	7	OH	3Ø4W	#1/0-250	#14-1/0	6	14	48	2½	2½	3	3	¼	½
U214MTB-P*	4	OH/UG	1Ø3W*	#6-2/0	#14-1/0	4½	18	25	2	2	2½	1½	½, ¾	1½
U215MTB-P	5	OH/UG	3Ø3W	#6-2/0	#14-1/0	4½	18	25	2	2	2½	1½	½, ¾	1½
U217MTB-P	7	OH/UG	3Ø4W	#6-2/0	#14-1/0	4½	18	25	2	2	2½	1½	½, ¾	1½

100 Amp | 4, 5 & 7 Terminal | Ring Type | 480 Volt Self-Contained | T-Fuse Pullout

Catalog Number	Terminal	Service	Type of Service	Connectors CU/AL		Dimensions			Knockouts					
				Line	Load	D"	W"	H"	1	2	3	4	5	6
214MTB-P48*	4	OH	1Ø3W*	#6-2/0	#14-1/0	6	14	48	2½	2½	3	3	¼	½
215MTB-P48	5	OH	3Ø3W	#6-2/0	#14-1/0	6	14	48	2½	2½	3	3	¼	½
217MTB-P48	7	OH	3Ø4W	#6-2/0	#14-1/0	6	14	48	2½	2½	3	3	¼	½
U214MTB-P48*	4	OH/UG	1Ø3W*	#6-2/0	#14-1/0	4½	18	25	2	2	2½	1½	½, ¾	1½
U215MTB-P48	5	OH/UG	3Ø3W	#6-2/0	#14-1/0	4½	18	25	2	2	2½	1½	½, ¾	1½
U217MTB-P48	7	OH/UG	3Ø4W	#6-2/0	#14-1/0	4½	18	25	2	2	2½	1½	½, ¾	1½

Notes

- **Replacement Main Disconnects:** For replacement main disconnect see pages 42-43.
 - **Hubs:** OH units use hub up to 2-1/2" (see accessory page). Units provided with closing plates.
 - **Sealing Rings:** Units furnished with MR-2 snap style sealing rings.
 - **Pull-Outs:** For use with T-fuses only. Fuses are included with fused safety sockets.
- * For 3W (208Y/120) network service, install field mounted fifth terminal catalog number 105J. See accessories page.

These UL listed products are for use in areas requiring Electrical Utility Service Equipment Requirements Committee (EUSERC) compliance.

Please consult serving utility for their requirements prior to ordering or installing, as specifications and approvals vary by utility, and may require local electrical inspector approval. All installations must be installed by a licensed electrician and must comply with all national and local codes, laws and regulations. Milbank reserves the right to make changes in specifications and features shown without notice or obligation.



Test Block Bypass/MTB Series

200 Amp | 4, 5 & 7 Terminal | Ring Type | 10K AIC



227MTB

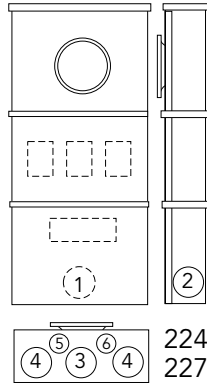

224MTB
227MTB

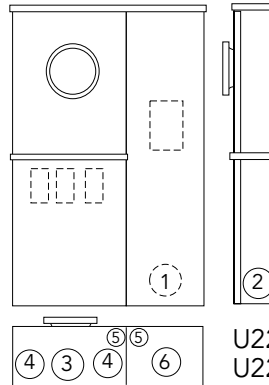

U224MTB
U227MTB



U224MTB

200 Amp | 4 & 7 Terminal | Ring Type | 240 Volt Self-Contained | Circuit Breaker

Catalog Number	Terminal	Service	Type of Service	Connectors CU/AL		Dimensions			Knockouts					
				Line	Load	D"	W"	H"	1	2	3	4	5	6
224MTB*	4	OH	1Ø3W*	#6-250	#2/0-250	6	14	48	2½	2½	3	3	½	¼
227MTB	7	OH	3Ø4W	#6-250	#2/0-250	6	14	48	2½	2½	3	3	½	¼
U224MTB*	4	OH/UG	1Ø3W*	#6-250	#2/0-250	6	22¾	30	2½	2½	2½	1½	½,¾	1½
U227MTB	7	OH/UG	3Ø4W	#6-250	#2/0-250	6	22¾	30	2½	2½	2½	1½	½,¾	1½

Notes

- **Replacement Main Disconnects:** For replacement main disconnect see pages 42-43.
- **Hubs:** OH units use hub up to 2-1/2" (see accessory page). Units provided with closing plates.
- **Sealing Rings:** Units furnished with MR-2 snap style sealing rings.
- * For 3W (208Y/120) network service, install field mounted fifth terminal catalog number 105J. See accessories page.

These UL listed products are for use in areas requiring Electrical Utility Service Equipment Requirements Committee (EUSERC) compliance.



Please consult serving utility for their requirements prior to ordering or installing, as specifications and approvals vary by utility, and may require local electrical inspector approval. All installations must be installed by a licensed electrician and must comply with all national and local codes, laws and regulations. Milbank reserves the right to make changes in specifications and features shown without notice or obligation.

Test Block Bypass/MTB Series

200 Amp | 4 & 7 Terminal | Ring Type | 22K AIC

37
200 AMP
TEST BLOCK
BYPASS



227MTB/22

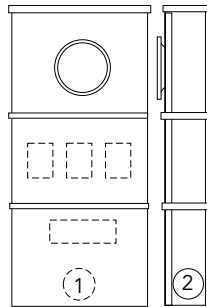

224MTB/22
227MTB/22

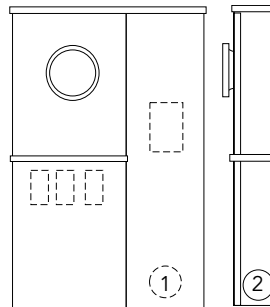

U224MTB/22
U227MTB/22



U224MTB/22

200 Amp | 4 & 7 Terminal | Ring Type | 240 Volt Self-Contained | Circuit Breaker

Catalog Number	Terminal	Service	Type of Service	Connectors CU/AL		Dimensions			Knockouts					
				Line	Load	D"	W"	H"	1	2	3	4	5	6
224MTB/22*	4	OH	1Ø3W*	#6-250	#2/0-250	6	14	48	2½	2½	3	3	½	¼
227MTB/22	7	OH	3Ø4W	#6-250	#2/0-250	6	14	48	2½	2½	3	3	½	¼
U224MTB/22*	4	OH/UG	1Ø3W*	#6-250	#2/0-250	6	22¾	30	2½	2½	2½	1½	½,¾	1½
U227MTB/22	7	OH/UG	3Ø4W	#6-250	#2/0-250	6	22¾	30	2½	2½	2½	1½	½,¾	1½

Notes

- **Replacement Main Disconnects:** For replacement main disconnect see pages 42-43.
 - **Hubs:** OH units use hub up to 2-1/2" (see accessory page). Units provided with closing plates.
 - **Sealing Rings:** Units furnished with MR-2 snap style sealing rings.
- * For 3W (208Y/120) network service, install field mounted fifth terminal catalog number 105J. See accessories page.

Please consult serving utility for their requirements prior to ordering or installing, as specifications and approvals vary by utility, and may require local electrical inspector approval. All installations must be installed by a licensed electrician and must comply with all national and local codes, laws and regulations. Milbank reserves the right to make changes in specifications and features shown without notice or obligation.



Test Block Bypass/MTB Series

200 Amp | 4 & 7 Terminal | Ring Type | 35K AIC | 480 Volt



227MTB-48

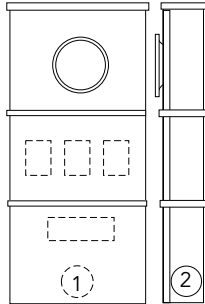

224MTB-48
227MTB-48

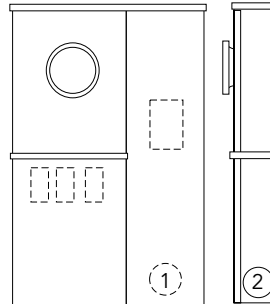

U224MTB-48
U227MTB-48



U224MTB-48

200 Amp | 4 & 7 Terminal | Ring Type | 480 Volt Self-Contained | Circuit Breaker

Catalog Number	Terminal	Service	Type of Service	Connectors CU/AL		Dimensions			Knockouts					
				Line	Load	D"	W"	H"	1	2	3	4	5	6
224MTB-48*	4	OH	1Ø3W*	#6-250	#2/0-250	6	22¾	30	2½	2½	3	2½	½	¼
U224MTB-48	4	OH/UG	1Ø3W*	#6-250	#2/0-250	6	22¾	30	2½	2½	3	2½	½	¼
227MTB-48	7	OH	3Ø4W	#6-250	#2/0-250	6	14	48	2½	2½	3	3	½	¼
U227MTB-48	7	OH/UG	3Ø4W	#6-250	#2/0-250	6	22¾	30	2½	2½	2½	1½	½¾	1½

Notes

- **Replacement Main Disconnects:** For replacement main disconnect see pages 42-43.
 - **Hubs:** OH units use hub up to 2-1/2" (see accessory page). Units provided with closing plates.
 - **Sealing Rings:** Units furnished with MR-2 snap style sealing rings.
- * For 3W (208Y/120) network service, install field mounted fifth terminal catalog number 105J. See accessories page.



Please consult serving utility for their requirements prior to ordering or installing, as specifications and approvals vary by utility, and may require local electrical inspector approval. All installations must be installed by a licensed electrician and must comply with all national and local codes, laws and regulations. Milbank reserves the right to make changes in specifications and features shown without notice or obligation.

Test Block Bypass/MTB-P & MTB-P48

200 Amp | Ring Type | 200K AIC

39
200 AMP
TEST BLOCK
BYPASS



224MTB-P

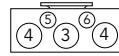
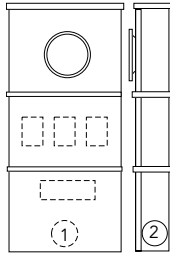

224MTB-P
225MTB-P
227MTB-P
224MTB-P48
225MTB-P48
227MTB-P48

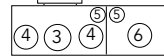
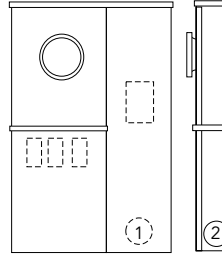

U224MTB-P
U227MTB-P
U224MTB-P48
U227MTB-P48



U227MTB-P

200 Amp | 4, 5 & 7 Terminal | Ring Type | 240 Volt Self-Contained | T-Fuse Pullout

Catalog Number	Terminal	Service	Type of Service	Connectors CU/AL		Dimensions			Knockouts					
				Line	Load	D"	W"	H"	1	2	3	4	5	6
224MTB-P*	4	OH	1Ø3W*	#6-250	#1/0-250	6	14	48	2½	2½	3	3	¼	½
225MTB-P	5	OH	3Ø3W	#6-250	#1/0-250	6	14	48	2½	2½	3	3	¼	½
227MTB-P	7	OH	3Ø4W	#6-250	#1/0-250	6	14	48	2½	2½	3	3	¼	½
U224MTB-P*	4	OH/UG	1Ø3W*	#6-250	#1/0-250	6	22¾	30	2½	2½	3	2½	½,¾	2½
U227MTB-P	7	OH/UG	3Ø4W	#6-250	#1/0-250	6	22¾	30	2½	2½	3	2½	½,¾	2½

200 Amp | 4, 5 & 7 Terminal | Ring Type | 480 Volt Self-Contained | T-Fuse Pullout

Catalog Number	Terminal	Service	Type of Service	Connectors CU/AL		Dimensions			Knockouts					
				Line	Load	D"	W"	H"	1	2	3	4	5	6
224MTB-P48*	4	OH	1Ø3W*	#6-250	#1/0-250	6	14	48	2½	2½	3	3	¼	½
225MTB-P48	5	OH	3Ø3W	#6-250	#1/0-250	6	14	48	2½	2½	3	3	¼	½
227MTB-P48	7	OH	3Ø4W	#6-250	#1/0-250	6	14	48	2½	2½	3	3	¼	½
U224MTB-P48*	4	OH/UG	1Ø3W*	#6-250	#1/0-250	6	22¾	30	2½	2½	3	2½	½,¾	2½
U227MTB-P48	7	OH/UG	3Ø4W	#6-250	#1/0-250	6	22¾	30	2½	2½	3	2½	½,¾	2½

Notes

- **Replacement Main Disconnects:** For replacement main disconnect see pages 42-43.
 - **Hubs:** OH units use hub up to 2-1/2" (see accessory page). Units provided with closing plates.
 - **Sealing Rings:** Units furnished with MR-2 snap style sealing rings.
 - **Pull-Outs:** For use with T-fuses only. Fuses are included with fused safety sockets.
- * For 3W (208Y/120) network service, install field mounted fifth terminal catalog number 105J. See accessories page.

Please consult serving utility for their requirements prior to ordering or installing, as specifications and approvals vary by utility, and may require local electrical inspector approval. All installations must be installed by a licensed electrician and must comply with all national and local codes, laws and regulations. Milbank reserves the right to make changes in specifications and features shown without notice or obligation.



Test Block Bypass/MTBL

All-In-One Series | 100 & 200 Amp | 10K & 200K AIC



U227MTBL

100 & 200 Amp | 240 Volt Meter Main | Circuit Breaker/T-Fuse Pullout

Catalog Number	Rating	No. Internal Circuits	Main Circuit Breaker Or Fuse Pullout	Dimensions			Bottom Knockouts	Back Knockouts
				D"	W"	H"		
U214MTBL*	100A, 120/240 VAC 1Ø3W	12/24	100A, 2P, 10K Milbank Q2100	4 $\frac{5}{8}$	25	24 $\frac{3}{4}$	Utility Section (1) ½" (3) 1¼", 1½", 2", 2½" Customer Section (3) ½", ¾" (1) ½", ¾", 1", 1¼" (2) ¾", 1", 1¼", 1½"	Customer Section (7) ½" (4) ½", ¾" (1) ¾", 1", 1¼", 1½"
U214MTBPL*	100A, 120/240 VAC 1Ø3W	12/24	100A, 2P, 200K Boltswitch PT223	4 $\frac{5}{8}$	25	24 $\frac{3}{4}$		
U217MTBL	100A, 240Δ/120; 208Y/120 VAC 3Ø4W	18/36	100A, 3P, 10K Siemens BQ3100	4 $\frac{5}{8}$	25	24 $\frac{3}{4}$		
U217MTBPL	100A, 240Δ/120; 208Y/120 VAC 3Ø4W	18/36	100A, 3P, 200K Boltswitch PT323	4 $\frac{5}{8}$	25	24 $\frac{3}{4}$		
U224MTBL*	200A, 120/240 VAC 1Ø3W	20/40	200A, 2P, 10K Milbank UQFP-200	6	27	30	Utility Section (1) ½", ¾" (2) 1¼", 1½", 2", 2½" (1) 2½", 3" Customer Section (11) ½" (2) ½", ¾" (1) ½", ¾", 1", 1¼" (2) ¾", 1", 1¼", 1½"	Customer Section (6) ½" (4) ½", ¾" (1) ¾", 1", 1¼", 1½"
U224MTBPL*	200A, 120/240 VAC 1Ø3W	20/40	200A, 2P, 200K Boltswitch PT224	6	27	30		
U227MTBL	200A, 240Δ/120; 208Y/120 VAC 3Ø4W	24/42	200A, 3P, 10K Siemens QJ23B200	6	27	30		
U227MTBPL	200A, 240Δ/120; 208Y/120 VAC 3Ø4W	24/42	200A, 3P, 200K Boltswitch PT324	6	27	30		

Notes

- **Line:** Underground or overhead service. Line Lug: 100A, 14-1/0 and 200A 1/0-250.
 - **Load:** Exit below load center only
 - **Branch Breakers:** Single phase units—approved for Siemens/ITE Type Q, Challenger, Cutler-Hammer/Westinghouse, General Electric, Murray. Three phase units—approved for Siemens/ITE Type Q.
 - **Hubs:** OH units use hub up to 2-1/2" (see accessory page). Units provided with closing plate.
 - **Pull-Outs:** For use with T-fuses only. Fuses are included with fused safety sockets.
- * For 208Y/120 applications, order field kit **105J** separately and install.



Please consult serving utility for their requirements prior to ordering or installing, as specifications and approvals vary by utility, and may require local electrical inspector approval. All installations must be installed by a licensed electrician and must comply with all national and local codes, laws and regulations. Milbank reserves the right to make changes in specifications and features shown without notice or obligation.

Test Block Bypass/MTBL

Knockout Information

Catalog Number	Knockouts				
	1	2	3	4	5
U214MTBL	2½	1½	1¼	¾	½
U217MTBL	2½	1½	1¼	¾	½
U227MTBL	3	2½	1½	¾	½
U227MTBPL	3	2½	1½	1¼	¾

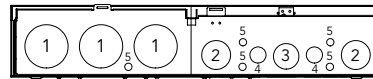
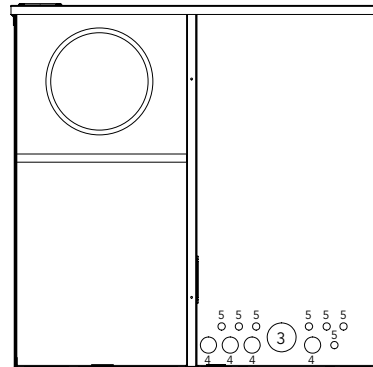

U214MTBL
U217MTBL

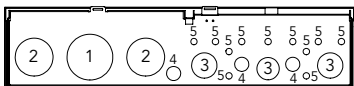
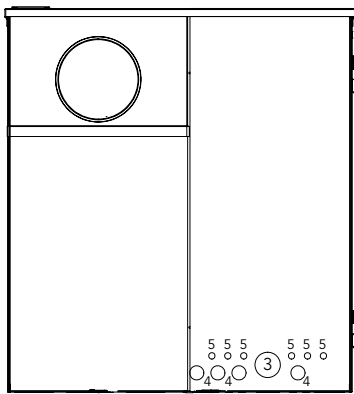

U227MTBL

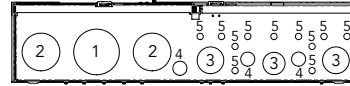
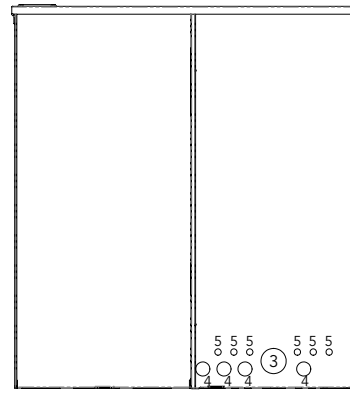

U227MTBPL

Please consult serving utility for their requirements prior to ordering or installing, as specifications and approvals vary by utility, and may require local electrical inspector approval. All installations must be installed by a licensed electrician and must comply with all national and local codes, laws and regulations. Milbank reserves the right to make changes in specifications and features shown without notice or obligation.



Replacement Circuit Breakers

Catalog Number	Circuit Breaker
214MTB	BQ2B100L
214MTB-48	ED42B100
214MTB/22	BQ2B100HL
U214MTB	BQ2B100L
U214MTB-48	ED42B100
U214MTB/22	BQ2B100HL
U214MTBL	Q2100
215MTB	BQ3B100L
215MTB-48	ED43B100L
U215MTB	BQ3B100L
U215MTB-48	ED43B100L
217MTB	BQ3B100L
217MTB48	ED43B100L
217MTB/22	BQ3B100HL
U217MTB	BQ3B100L
U217MTB-48	ED43B100L
U217MTB/22	BQ3B100HL
U217MTBL	BQ3B100L
224MTB	UQFB-200
224MTB/22	UQFBH-200
U224MTB	UQFB-200
U224MTB-48	FXD62B200
U224MTB/22	UQFBH-200
U224MTBL	UQFB-200
U225MTB	UQFB-3200

Catalog Number	Circuit Breaker
227MTB	UQFB-3200
227MTB-125	UQFB-3125
227MTB-150	UQFB-3150
227MTB-175	UQFB-3175
227MTB-48	FXD63B200L
227MTB/22	QJH23B200L
U227MTB	UQFB-3200
U227MTB-125	UQFB-3125
U227MTB-150	UQFB-3150
U227MTB-175	UQFB-3175
U227MTB-48	FXD63B200L
U227MTB/22	QJH23B200L
U227MTBL	QJ23B200

Lug Kits for Circuit Breakers

Siemens Circuit Breaker	Number of Lug Collars Required
ED42B100	(2) LN13100
ED43B100	(3) LN1E100
FXD62B200	(4) TA1FD350
FXD63B200	(6) TA1FD350
QJ22B200H	(2) TA1Q300
QJ23B200	(1) TA1Q300
QJH23B200L	(1) TA1Q300

Note

When replacing Siemens Circuit Breaker (FXD,ED,QJ) in safety sockets, lug collars must be ordered from Siemens separately.



Please consult serving utility for their requirements prior to ordering or installing, as specifications and approvals vary by utility, and may require local electrical inspector approval. All installations must be installed by a licensed electrician and must comply with all national and local codes, laws and regulations. Milbank reserves the right to make changes in specifications and features shown without notice or obligation.

Safety Socket Replacement

T-Fuse Pullouts

Replacement T-Fuse Pullouts

Catalog Number	Circuit Breaker	Mfg.	Part Number
214MTB-P	PT223	Boltswitch	707674-MO
214MTB-P48	PT263	Boltswitch	708564-MO
U214MTB-P	PT223	Boltswitch	707674-MO
U214MTB-P48	PT263	Boltswitch	708564-MO
U214MTBPL	PT223	Boltswitch	707674-MO
215MTB-P	PT323	Boltswitch	708565-MO
215MTB-P48	PT363	Boltswitch	708566-MO
U215MTB-P	PT323	Boltswitch	708565-MO
U215MTB-P48	PT363	Boltswitch	708566-MO
217MTB-P	PT323	Boltswitch	708565-MO
217MTB-P48	PT363	Boltswitch	708566-MO
U217MTB-P	PT323	Boltswitch	708565-MO
U217MTB-P48	PT363	Boltswitch	708566-MO
U217MTBPL	PT323	Boltswitch	708565-MO
224MTB-P	PT224	Boltswitch	707684-MO
224MTB-P48	PT264	Boltswitch	708567-MO
U224MTB-P	PT224	Boltswitch	707684-MO
U224MTB-P48	PT264	Boltswitch	708567-MO
U224MTBPL	PT224	Boltswitch	707684-MO
225MTB-P48	PT364	Boltswitch	708569-MO
U225MTBPL	PT324	Boltswitch	708568-MO
227MTB-P	PT323	Boltswitch	708568-MO
227MTB-P48	PT364	Boltswitch	708569-MO
U227MTB-P	PT324	Boltswitch	708568-MO
U227MTB-P48	PT364	Boltswitch	708569-MO
U227MTBPL	PT324	Boltswitch	708568-MO

Lug Kits for T-Fuse Pullouts

Part Number	Number of Lug Collars Required
707682-AC	(2) TK100P
708570-AC	(2) TK200P
707682-AC	(2) TK100P
708570-AC	(2) TK200P
707682-AC	(3) TK100P
708570-AC	(3) TK200P
707682-AC	(3) TK100P
708570-AC	(3) TK200P

Note

T-Fuse pullouts provided with load side lugs. Order line side lugs separately from above chart.

Please consult serving utility for their requirements prior to ordering or installing, as specifications and approvals vary by utility, and may require local electrical inspector approval. All installations must be installed by a licensed electrician and must comply with all national and local codes, laws and regulations. Milbank reserves the right to make changes in specifications and features shown without notice or obligation.



44

SAFETY SOCKET
& T-FUSE
REPLACEMENT

Safety Socket & T-Fuse Replacement



MS-27-TB



TB200-47

Tenant Meter Sockets

Catalog Number	Amp	Voltage/System
MS-24-TB	200	600V/1Ø3W
MS-25-TB	200	600V/3Ø3W
MS-27-TB	200	600V/3Ø4W

Replacement Test Blocks

Catalog Number	Amp	Phase
TB100-47	100	Phase A, B & C
TB100-5 Center Block Only	100	Phase B – 3Ø3W
TB200-47	200	Phase A, B & C
TB200-5 Center Block Only	200	Phase B – 3Ø3W
TB200-LL	200	Lug – Lug



PT324

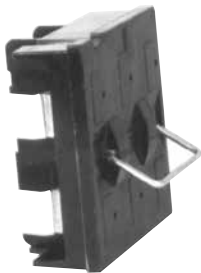

240 Volt Main Disconnects Pullout Switch (Uses Type "T" Fuse)

Catalog Number	Amp	Rating
PT223	100	2 Pole – 240 Volt
PT224	200	2 Pole – 240 Volt
PT323	100	3 Pole – 240 Volt
PT324	200	3 Pole – 240 Volt

480 Volt Main Disconnects Pullout Switch (Uses Type "T" Fuse)

Catalog Number	Amp	Rating
PT263	100	2 Pole – 480 Volt
PT264	200	2 Pole – 480 Volt
PT363	100	3 Pole – 480 Volt
PT364	200	3 Pole – 480 Volt

*These UL listed products are for use in areas requiring
Electrical Utility Service Equipment Requirements Committee (EUSERC) compliance.*



Please consult serving utility for their requirements prior to ordering or installing, as specifications and approvals vary by utility, and may require local electrical inspector approval. All installations must be installed by a licensed electrician and must comply with all national and local codes, laws and regulations. Milbank reserves the right to make changes in specifications and features shown without notice or obligation.

Underground Termination Boxes

600 VAC

45
UNDERGROUND
TERMINATION
BOXES



PB-012



PB-038



PB-011



PB-032

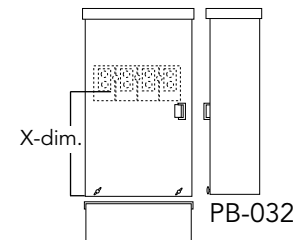
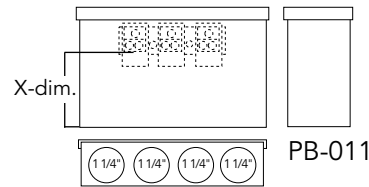
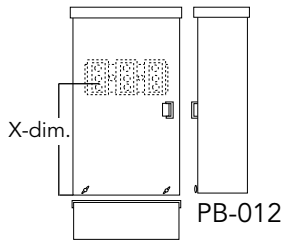

Underground Termination Boxes | 600 VAC

Catalog Number	Amp	Type of Service	Connectors CU/AL		Dimensions				Short Circuit Current Withstand Rating
			Line	Load	D"	W"	H"	X"	
PB-011*	100	1Ø3W	#14-1/0	#14-1/0	4	12	8½	3¾	10K Amp
PB-012	200	1Ø3W	#6-250	#6-250	6	12	26	14¼	10K Amp
PB-014** PB-014-NK	400	1Ø3W	½"x13 Studs	#4-600 Twin 1/0-250	6	16	36	22	50K Amp
PB-018** PB-018-NK	800	1Ø3W	½"x13 Studs**	#4-600 Twin 1/0-250	11	24	48	26	50K Amp
PB-032	200	3Ø4W	#6-250	#6-250	6	16	26	14¼/6	10K Amp
PB-034** PB-034-NK	400	3Ø4W	½"x13 Studs**	#4-600 Twin 1/0-250	6	16	36	22	50K Amp
PB-038**	800	3Ø4W	½"x13 Studs**	#4-600 Twin 1/0-250	11	24	48	26	50K Amp

Notes

- **Connectors and Bussing:** Extruded aluminum connectors and bus bars are tin plated.
- For no knockouts, add suffix -NK to the above catalog numbers.
- * No lift handles provided on the **PB-011**.
- ** 2 studs per lug position provided for 400 amp units. 4 studs per lug position provided for 800 amp units.

Please consult serving utility for their requirements prior to ordering or installing, as specifications and approvals vary by utility, and may require local electrical inspector approval. All installations must be installed by a licensed electrician and must comply with all national and local codes, laws and regulations. Milbank reserves the right to make changes in specifications and features shown without notice or obligation.



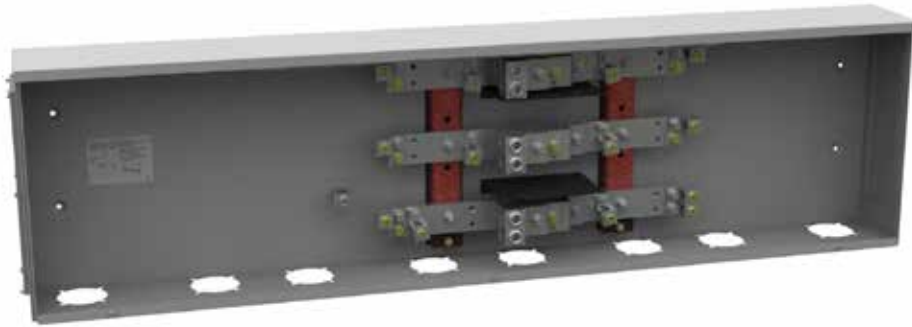

For Commercial Safety Socket Applications

Bussed Gutters | Type 3R | 1Ø3W | 600 VAC

Catalog Number	Meter Position	Amp	Dimensions			Length of Bus	Line Lugs Per Each Bus	Load Lugs Per Bus
			D"	W"	H"			
BC214	2	400	6	28 $\frac{5}{8}$	15 $\frac{1}{2}$	20" Bar	(1) 600	(2) 6-250
BC318	3	800	6	43	15 $\frac{1}{2}$	(2) 20" Bars	(2) 600	(3) 6-250
BC418	4	800	6	57 $\frac{1}{4}$	15 $\frac{1}{2}$	(2) 20" Bars	(2) 600	(4) 6-250
BC518	5	800	6	71 $\frac{5}{8}$	15 $\frac{1}{2}$	(2) 20" Bars	(2) 600	(5) 6-250
BC618	6	800	6	85 $\frac{7}{8}$	15 $\frac{1}{2}$	(2) 20" Bars	(2) 600	(6) 6-250

Bussed Gutters | Type 3R | 3Ø4W | 600 VAC

Catalog Number	Meter Position	Amp	Dimensions			Length of Bus	Line Lugs Per Each Bus	Load Lugs Per Bus
			D"	W"	H"			
BC234	2	400	6	28 $\frac{5}{8}$	15 $\frac{1}{2}$	20" Bar	(1) 600	(2) 6-250
BC338	3	800	6	43	15 $\frac{1}{2}$	(2) 20" Bars	(2) 600	(3) 6-250
BC438	4	800	6	57 $\frac{1}{4}$	15 $\frac{1}{2}$	(2) 20" Bars	(2) 600	(4) 6-250
BC538	5	800	6	71 $\frac{5}{8}$	15 $\frac{1}{2}$	(2) 20" Bars	(2) 600	(5) 6-250
BC638	6	800	6	85 $\frac{7}{8}$	15 $\frac{1}{2}$	(2) 20" Bars	(2) 600	(6) 6-250

Notes

- **Short Circuit Current Withstanding Rating:** Standard bracing is 42K AIC.
- **Connectors and Bussing:** Extruded aluminum connectors and bus bars are tin plated.
- **Cover:** Lift handles provided along with a cover sealing provision. A removable, sealable cover is provided at both ends for pull box assembly.
- **Hardware:** Meter socket mounting hardware included.
- Suitable for use on line side of service equipment.



Please consult serving utility for their requirements prior to ordering or installing, as specifications and approvals vary by utility, and may require local electrical inspector approval. All installations must be installed by a licensed electrician and must comply with all national and local codes, laws and regulations. Milbank reserves the right to make changes in specifications and features shown without notice or obligation.

Bussed Gutters

Type 3R | 3Ø4W | 600 VAC



- Enclosure without knockouts
- Tin plated aluminum bus bars
- Furnished with line lugs only
- Bus is drilled and tapped for easy installation of load lugs

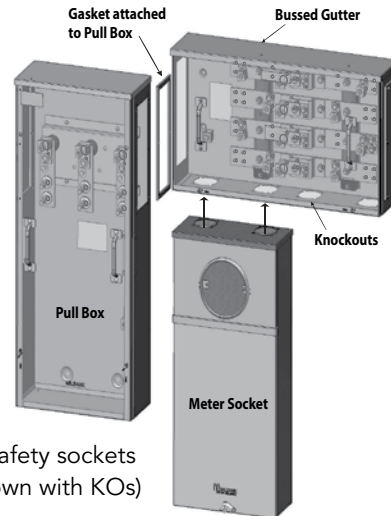

Typical application of safety sockets with multi-metering (shown with KOs)

Bussed Gutters | Type 3R | 1Ø4W | 600 VAC

Catalog Number	Meter Position	Amp	Dimensions			Length of Bus	Line Lugs Per Each Bus
			D"	W"	H"		
U3412-O	2	400	6	24	24	17" Bar	(1) 600
U3413-O	3	600	6	36	24	24" Bars	(2) 600
U3414-O	4	800	6	48	24	32" Bars	(3) 600
U3415-O	5	800	6	60	24	40" Bars	(3) 600
U3416-O	6	800	6	72	24	56" Bars	(3) 600

Bussed Gutters | Type 3R | 3Ø4W | 600 VAC

Catalog Number	Meter Position	Amp	Dimensions			Length of Bus	Line Lugs Per Each Bus
			D"	W"	H"		
U3462-O	2	400	6	24	24	17" Bar	(1) 600
U3463-O	3	600	6	36	24	24" Bars	(2) 600
U3464-O	4	800	6	48	24	32" Bars	(3) 600
U3465-O	5	800	6	60	24	40" Bars	(3) 600
U3466-O	6	800	6	72	24	56" Bars	(3) 600

Notes

- **Short Circuit Current Withstanding Rating:** The 400 and 600 amp units have a withstand rating of 50K amp, and the 800 amp units have a rating of 65K amp.
- Suitable for use on line side of service equipment.

Please consult serving utility for their requirements prior to ordering or installing, as specifications and approvals vary by utility, and may require local electrical inspector approval. All installations must be installed by a licensed electrician and must comply with all national and local codes, laws and regulations. Milbank reserves the right to make changes in specifications and features shown without notice or obligation.



48

100-125 AMP
MULTI-POSITION
SOCKETS

Multi-Position Sockets

100-125 Amp | 4 Terminal | Ringless | 300 VAC



U8032-XL

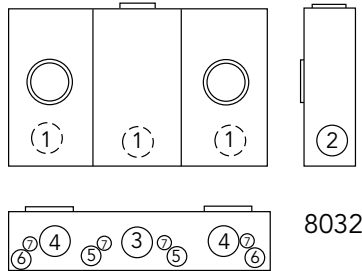

8032



U3522-XL-K1

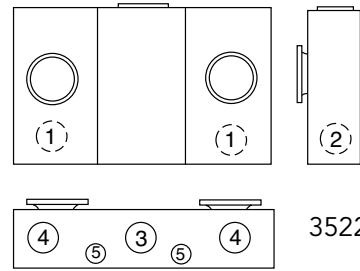

3522

100 Amp per Position | 4 Terminal | Multi-Position | Horizontal Gangs | Ringless

Catalog Number	Positions	Service	Hub	Connectors CU/AL		Dimensions			Knockouts						
				Line	Load	D"	W"	H"	1	2	3	4	5	6	7
U8032-XL	2	OH/UG	C.P.	#2-350	#6-2/0	4½	24½	16	2	2	2½	2	½	½	⅝
U8033-XL	3	OH/UG	C.P.	#2-350	#6-2/0	4½	32¾	16	2	2	2½	(3) 2	½	½	⅝
U8034-XL	4	OH/UG	C.P.	#2-350	#6-2/0	4½	40⅞	16	2	2	2½	(4) 2	½	½	⅝
U8035-XL	5	OH/UG	C.P.	#2-350	#6-2/0	4½	49⅙	16	2	2	2½	(5) 2	½	½	⅝
U8036-XL	6	OH/UG	C.P.	#2-350	#6-2/0	4½	57¼	16	2	2	2½	(6) 2	½	½	⅝

125 Amp per Position | 4 Terminal | Multi-Position | Horizontal Gangs | Ring Type

Catalog Number	Positions	Service	Hub	Connectors CU/AL		Dimensions			Knockouts					
				Line	Load	D"	W"	H"	1	2	3	4	5	6
U3522-XL-K1	2	OH/UG	C.P.	#2-350	#6-2/0	4½	24½	14	1½	1½	2½	2½	¼, ½	½
U3523-XL-K1	3	OH/UG	C.P.	#2-350	#6-2/0	4½	32¾	14	1½	1½	2½	(3) 2½	¼, ½	½
U3524-XL-K2	4	OH/UG	C.P.	#2-350	#6-2/0	4½	40⅞	14	1½	1½	2½	(4) 2½	¼, ½	½
U3525-XL-K2	5	UG	C.P.	#2-350	#6-2/0	4½	49⅙	14	1½	1½	2½	(5) 2½	¼, ½	½

Notes

- **Fifth Terminal:** For field mounted fifth terminal, order catalog number **5T8K2** (6 o'clock only on 100 amp units, 9 o'clock only on 125 amp units).
- **Hubs:** For proper hub selection, see the hub suffix chart on the accessory page.
- **Sealing Rings:** Ring type units are supplied with one **MR-4** screw type sealing ring per position.



Please consult serving utility for their requirements prior to ordering or installing, as specifications and approvals vary by utility, and may require local electrical inspector approval. All installations must be installed by a licensed electrician and must comply with all national and local codes, laws and regulations. Milbank reserves the right to make changes in specifications and features shown without notice or obligation.

Multi-Position Sockets

200 Amp | 4 Terminal | Ringless | 300 VAC

49
200 AMP
MULTI-POSITION
SOCKETS



U1252-X-K1

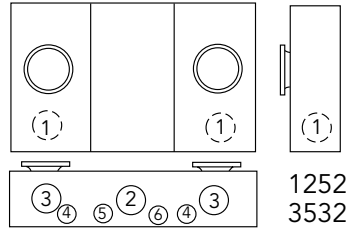

1252
3532

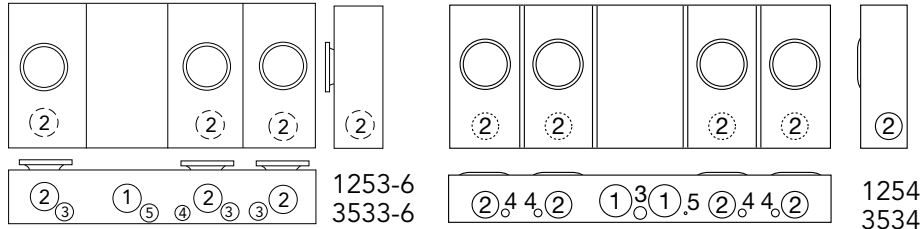

1253-6
3533-6

1254
3534

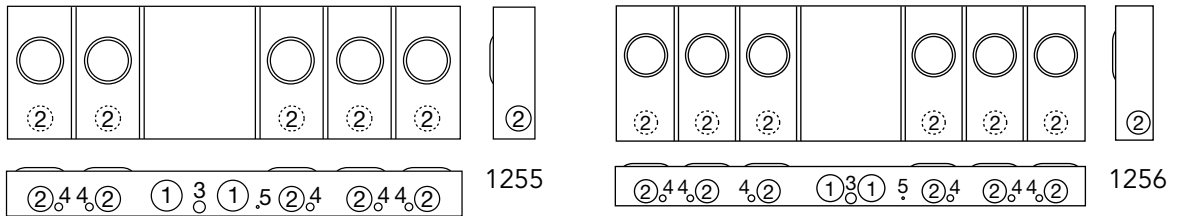

1255

1256

200 Amp per Position | 4 Terminal | Multi-Position | Horizontal Gangs | Ringless

Catalog Number	Positions	Service	Hub	Connectors CU/AL		Dimensions			Knockouts				
				Line	Load	D"	W"	H"	1	2	3	4	5
U1252-X-K1	2	OH/UG	C.P.	#6-350	#2-350	5 $\frac{1}{8}$	26 $\frac{1}{2}$	14	2 $\frac{1}{2}$	3	2 $\frac{1}{2}$	$\frac{1}{2}$	$\frac{1}{4}$
U1253-X-K3	3	OH/UG	C.P.	#4-600	#2-350	5 $\frac{1}{8}$	34 $\frac{3}{4}$	14	3	2 $\frac{1}{2}$	$\frac{1}{2}$	$\frac{1}{4}$	1
U1254-X-K3	4	OH/UG	C.P.	#4-600	#2-350	5 $\frac{1}{8}$	42 $\frac{7}{8}$	16	3	2 $\frac{1}{2}$	1	$\frac{1}{2}$	$\frac{1}{4}$
U1255-X-K4	5	OH/UG	C.P.	(2) #2-600	#2-350	5 $\frac{1}{8}$	54 $\frac{7}{8}$	16	3	2 $\frac{1}{2}$	1	$\frac{1}{2}$	$\frac{1}{4}$
U1256-X-K4	6	OH/UG	C.P.	(2) #2-600	#2-350	5 $\frac{1}{8}$	63 $\frac{1}{6}$	18	3	2 $\frac{1}{2}$	1	$\frac{1}{2}$	$\frac{1}{4}$

200 Amp per Position | 4 Terminal | Multi-Position | Horizontal Gangs | Ring Type

Catalog Number	Positions	Service	Hub	Connectors CU/AL		Dimensions			Knockouts					
				Line	Load	D"	W"	H"	1	2	3	4	5	6
U3532-X-K1	2	OH/UG	C.P.	#6-350	#2-350	5 $\frac{1}{8}$	26 $\frac{1}{2}$	16	2 $\frac{1}{2}$	3	2 $\frac{1}{2}$	—	$\frac{1}{2}$	1
U3533-X-K3	3	OH/UG	C.P.	#4-600	#2-350	5 $\frac{1}{8}$	34 $\frac{1}{2}$	16	3	2 $\frac{1}{2}$	—	$\frac{1}{4}$	$\frac{1}{2}$	—
U3534-X-K3	4	OH/UG	C.P.	#4-600	#2-350	5 $\frac{1}{8}$	42 $\frac{7}{8}$	16	3	2 $\frac{1}{2}$	1	—	$\frac{1}{2}$	—

Notes

- **Fifth Terminal:** For field mounted fifth terminal, order catalog number **5T8K2** (6 o'clock only on 100 amp units, 9 o'clock only on 125 amp units).
- **Hubs:** For proper hub selection, see the hub suffix chart on the accessory page.
- **Sealing Rings:** Ring type units are supplied with one **MR-4** screw type sealing ring per position.

Please consult serving utility for their requirements prior to ordering or installing, as specifications and approvals vary by utility, and may require local electrical inspector approval. All installations must be installed by a licensed electrician and must comply with all national and local codes, laws and regulations. Milbank reserves the right to make changes in specifications and features shown without notice or obligation.



50

125-200 AMP
MULTI-POSITION
METER MAINS

Multi-Position Meter Mains

125-200 Amp | 4 Terminal | Ringless | 120/240 VAC



U2854-X

125 Amp | Position

Catalog Number	Positions	Main Bus Rating	Connectors CU/AL
			Line
U2852-X	2	200 Amp	*3/8"-16 STUD
U2853-X	3	200 Amp	*3/8"-16 STUD



U2866-X

200 Amp | Position

Catalog Number	Positions	Main Bus Rating	Connectors CU/AL
			Line
U2862-X	2	250 Amp	*3/8"-16 STUD
U2863-X	3	300 Amp	*3/8"-16 STUD

VERTICAL

125 Amp | Position

Catalog Number	Positions	Main Bus Rating	Connectors CU/AL
			Line
U2854-X	4	400 Amp	*3/8"-16 STUD
U2855-X	5	400 Amp	*3/8"-16 STUD
U2856-X	6	400 Amp	*3/8"-16 STUD

200 Amp | Position

Catalog Number	Positions	Main Bus Rating	Connectors CU/AL
			Line
U2864-X	4	400 Amp	*3/8"-16 STUD
U2865-X	5	400 Amp	*3/8"-16 STUD
U2866-X	6	400 Amp	*3/8"-16 STUD

RECTANGULAR

Connector Kits

Size	Suffix	Kit Number	Compatible With	Wire Range
SINGLE	-K1	K1539	U2852-56 U2862-66	#6-350
	-K3	K1540	U2854-56 U2864-66	#4-600
TWIN	-K2	K1350	U2854-56 U2863-66	#6-350
	-K4	K1541	U2864-66	#2-600

Connectors: For line wire connector kits, order separately.

Fifth Terminal: For field mounted fifth terminal order catalog number **K2381**. Order one per meter position (9 o'clock position only).

Breakers: Units have provision for one double pole main per meter position. Breakers not included. Order as extra Milbank.

*To add lugs, refer to the connector kits available in the Connector Kits table.

Amp	Cutler-Hammer (Westinghouse)	Simens (ITE)	Siemens Murray/ Crouse-Hinds	G.E.	SQ-D
150-200	HQP/BR/WBJ	QN	MD	THQ	
≤125	QP/BR/HQP	QP	MP	THQ	Homeline



Please consult serving utility for their requirements prior to ordering or installing, as specifications and approvals vary by utility, and may require local electrical inspector approval. All installations must be installed by a licensed electrician and must comply with all national and local codes, laws and regulations. Milbank reserves the right to make changes in specifications and features shown without notice or obligation.

Multi-Position Meter Mains

125-200 Amp | 22K AIC Rated | 240 VAC

51

125-200 AMP
MULTI-POSITION
METER MAINS



U2852-X

CONDOMINIUM METERING BANKS

VERTICAL

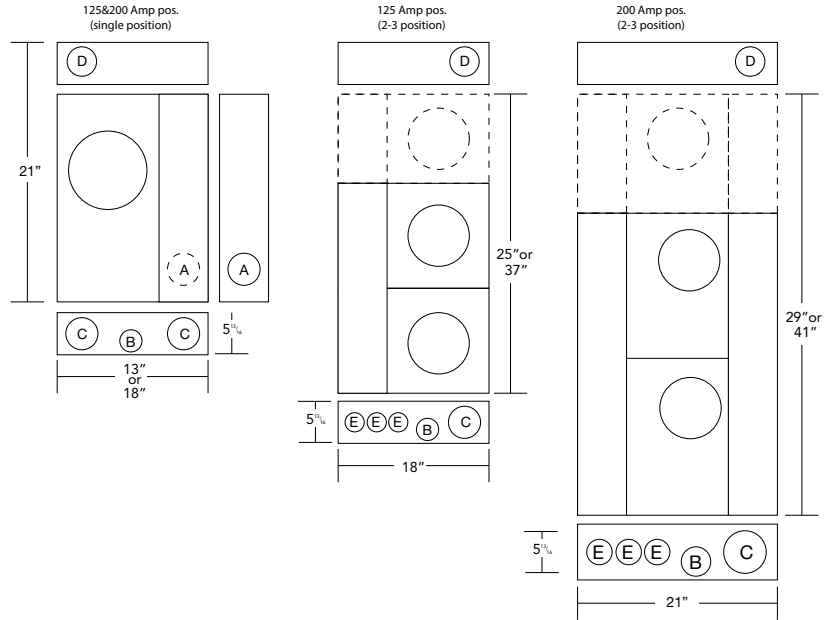

RECTANGULAR

Knockouts	
A	1 1/4"
B	1/4, 1/2"
C	3"
D	4"
E	2"

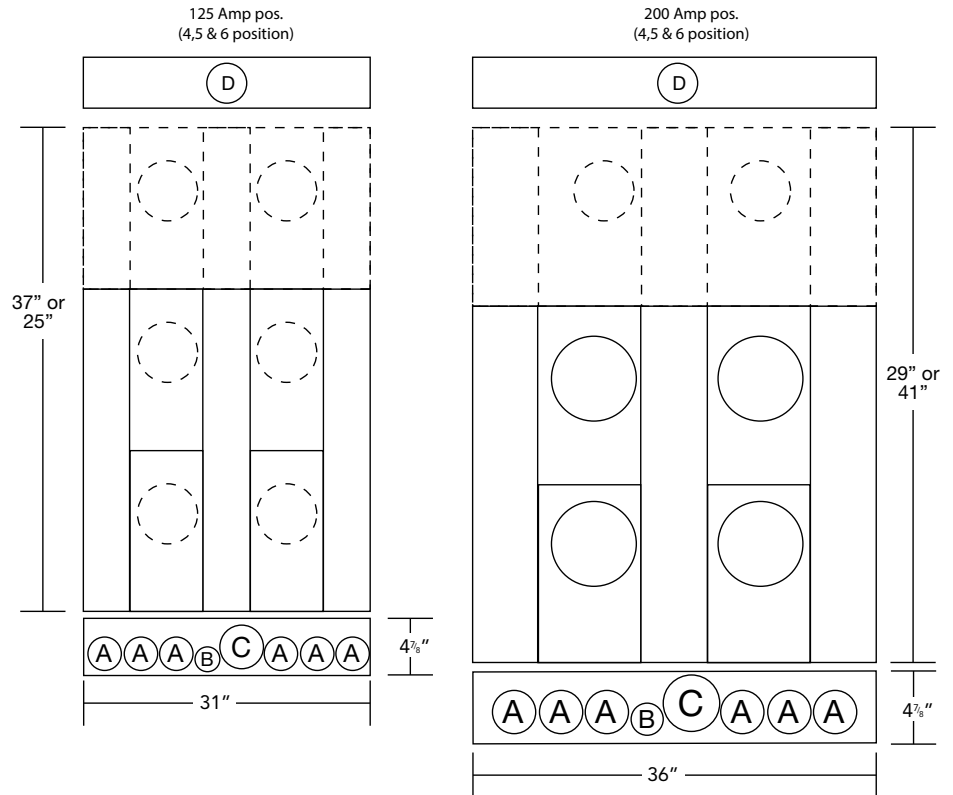

Please consult serving utility for their requirements prior to ordering or installing, as specifications and approvals vary by utility, and may require local electrical inspector approval. All installations must be installed by a licensed electrician and must comply with all national and local codes, laws and regulations. Milbank reserves the right to make changes in specifications and features shown without notice or obligation.



52

125-200 AMP
MULTI-POSITION
METER MAINS

Multi-Position Meter Mains

125-200 Amp | 22K AIC Rated | 240 VAC



U5882-X



U5884-X

4 Terminal | Multi-Position Meter Main | Ringless

Catalog Number	Amp	Positions	Service	Hub	Connectors CU/AL	Bypass	Dimensions			Weight (lbs.)
					Line		D"	W"	H"	
U5902-X	125	2	OH/UG	C.P.	3/8" x 16 Stud	None	5 1/8"	26 1/2"	30"	58
U5903-X	125	3	OH/UG	C.P.	3/8" x 16 Stud	None	5 1/8"	34 5/8"	30"	88
U5904-X	125	4	OH/UG	C.P.	3/8" x 16 Stud	None	5 1/8"	42 5/8"	30"	107
U5905-X	125	5	OH/UG	C.P.	3/8" x 16 Stud	None	5 1/8"	51 1/20"	30"	128
U5906-X	125	6	OH/UG	C.P.	3/8" x 16 Stud	None	5 1/8"	59 3/10"	30"	146
U5882-X	200	2	OH/UG	C.P.	3/8" x 16 Stud	None	5 1/8"	26 1/2"	30"	58
U5883-X	200	3	OH/UG	C.P.	3/8" x 16 Stud	None	5 1/8"	34 5/8"	30"	88
U5884-X	200	4	OH/UG	C.P.	3/8" x 16 Stud	None	5 1/8"	42 5/8"	30"	107
U5885-X	200	5	OH/UG	C.P.	3/8" x 16 Stud	None	5 1/8"	51 1/20"	30"	128
U5886-X	200	6	OH/UG	C.P.	3/8" x 16 Stud	None	5 1/8"	59 3/10"	30"	146

Notes

- **Knockouts:** See drawings on the next page.
- **Optional:** Factory installed breakers are available—consult factory.
- **AIC Rating:** All models are rated 22K AIC when used with approved breakers rated at 22K.
- **Hub:** Units supplied with one (1) closing plate. Order hubs separately, see accessories page.
- **Fifth Terminal:** For field installed fifth terminal, order **K5T**.
- **Connectors:** Socket is supplied with 3/8" - 16 hex head nuts with Belleville washers. For connector lug kits, order as extra from chart on the accessories page. Separate lug kits are required for line and load.

Breaker Chart - 10K AIC (unless noted 22K)

Manufacturer	Cutler Hammer	Siemens	G.E. (50 Amp Max)	Square D
125 Amp or Less	BR, HQP, QPGF	QP, QPH (22K)	THQL, THQL-GF	Homeline
150-200 Amp		QN, QNH (22K)	—	—



Please consult serving utility for their requirements prior to ordering or installing, as specifications and approvals vary by utility, and may require local electrical inspector approval. All installations must be installed by a licensed electrician and must comply with all national and local codes, laws and regulations. Milbank reserves the right to make changes in specifications and features shown without notice or obligation.

Multi-Position Meter Mains

U5902 & U5882 Series | Dimensional Information

53

125-200 AMP
MULTI-POSITION
METER MAINS

Knockouts				
1	2	3	4	5
3	2½	1	7/8	¼

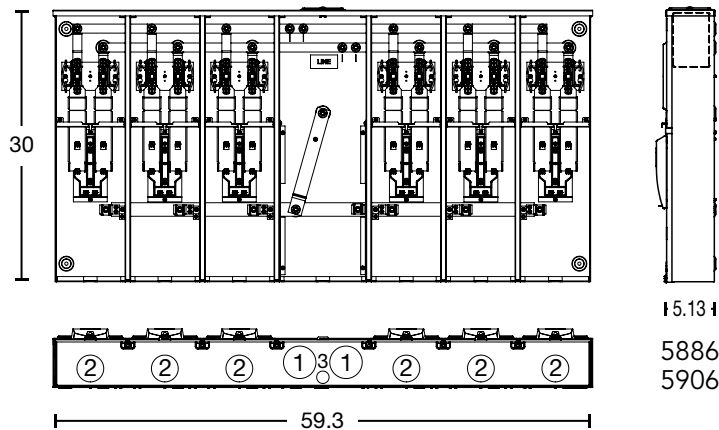
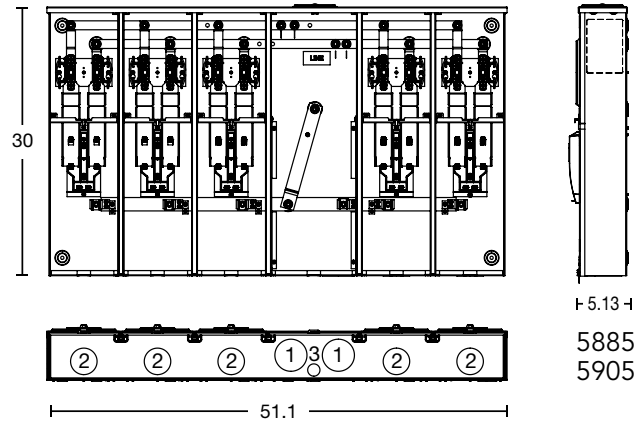
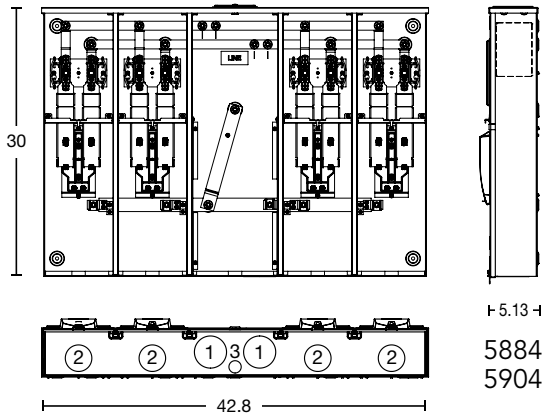
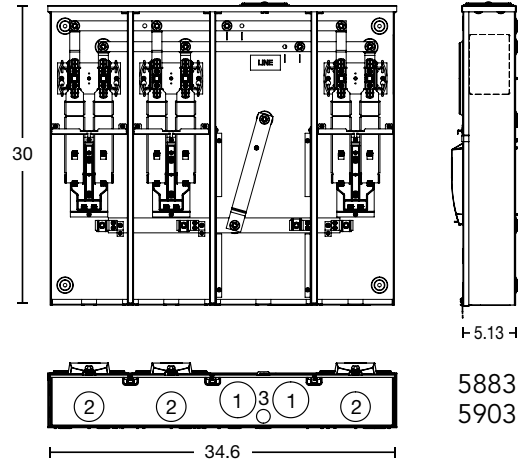
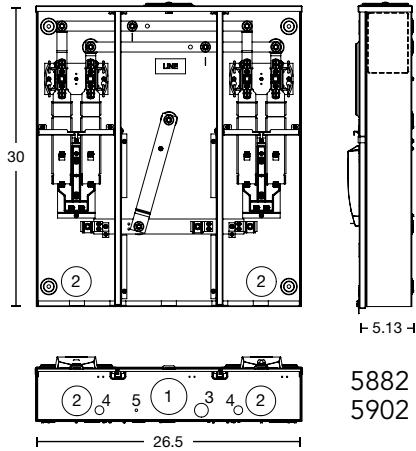

Please consult serving utility for their requirements prior to ordering or installing, as specifications and approvals vary by utility, and may require local electrical inspector approval. All installations must be installed by a licensed electrician and must comply with all national and local codes, laws and regulations. Milbank reserves the right to make changes in specifications and features shown without notice or obligation.





UC7582-XL

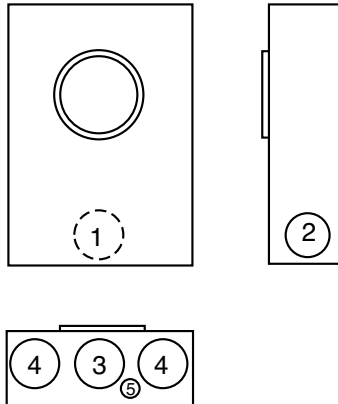

UC7237-RL

20 Amp | Ringless | Plunger Type Bypass | Overhead/Underground

Catalog Number	Terminal	Meter Form	Hub	Bypass	Connectors CU/AL		Dimensions			Knockouts				
					Line	Load	D"	W"	H"	1	2	3	4	5
UC1290-XL	5	3S	C.P.	Plunger*	#14 - #10		3 ⁵ / ₁₆	8	14	1 ¹ / ₂	1 ¹ / ₂	2	1 ¹ / ₄	1 ¹ / ₄
UC1299-XL	6	4S	C.P.	Plunger*	#14 - #10		3 ⁵ / ₁₆	8	14	1 ¹ / ₂	1 ¹ / ₂	2	1 ¹ / ₄	1 ¹ / ₄
UC7233-XL	7	7, 14, 15 & 24 S	C.P.	Plunger*	#14 - #10		3 ⁵ / ₁₆	8	14	1 ¹ / ₂	1 ¹ / ₂	2	1 ¹ / ₄	1 ¹ / ₄
UC7235-XL	8	5S	C.P.	Plunger*	#14 - #10		3 ⁵ / ₁₆	8	14	1 ¹ / ₂	1 ¹ / ₂	2	1 ¹ / ₄	1 ¹ / ₄
UC7237-XL	13	6, 8, 9S & (ALT) 10S	C.P.	Plunger*	#14 - #10		3 ⁵ / ₁₆	8	14	1 ¹ / ₂	1 ¹ / ₂	2	1 ¹ / ₄	1 ¹ / ₄

20 Amp | Ring Type | Plunger Type Bypass | Overhead/Underground

Catalog Number	Terminal	Meter Form	Hub	Bypass	Connectors CU/AL		Dimensions			Knockouts				
					Line	Load	D"	W"	H"	1	2	3	4	5
UC1291-RL	5	3S	H.O.	Plunger*	#14 - #10 Max		3 ⁵ / ₁₆	8	14	1 ¹ / ₂	1 ¹ / ₂	1 ¹ / ₄	1 ¹ / ₄	1 ¹ / ₄
UC1300-RL	6	4S	H.O.	Plunger*	#14 - #10 Max		3 ⁵ / ₁₆	8	14	1 ¹ / ₂	1 ¹ / ₂	1 ¹ / ₄	1 ¹ / ₄	1 ¹ / ₄
UC7544-RL	7	5S	H.O.	Plunger*	#14 - #10 Max		3 ⁵ / ₁₆	8	14	1 ¹ / ₂	1 ¹ / ₂	1 ¹ / ₄	1 ¹ / ₄	1 ¹ / ₄
UC7545-RL	8	6, 8, 9S & (ALT) 10S	H.O.	Plunger*	#14 - #10 Max		3 ⁵ / ₁₆	8	14	1 ¹ / ₂	1 ¹ / ₂	1 ¹ / ₄	1 ¹ / ₄	1 ¹ / ₄
UC7582-RL	13	6, 8, 9S & (ALT) 10S	C.P.	None	#14 - #10 Max		3 ⁵ / ₁₆	8	14	1 ¹ / ₂	1 ¹ / ₂	1 ¹ / ₄	1 ¹ / ₄	1 ¹ / ₄

Notes

- **Hubs:** For proper hub selection see the hub suffix chart on the accessory page.
- **Connectors:** Units are supplied with sleeve type connectors (#14-#2).
- * **Bypass:** Plunger type bypass automatically closes when meter is removed.



Please consult serving utility for their requirements prior to ordering or installing, as specifications and approvals vary by utility, and may require local electrical inspector approval. All installations must be installed by a licensed electrician and must comply with all national and local codes, laws and regulations. Milbank reserves the right to make changes in specifications and features shown without notice or obligation.

Current Transformer

20 Amp | 5, 6, 8, 13, & 15 Terminal | 600 VAC

55
CURRENT
TRANSFORMER



UC3438-XL



UC3426-XL

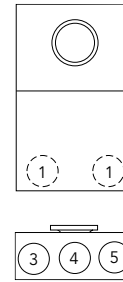
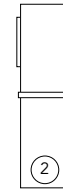
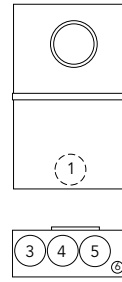

3425
3426
3428
3423
7636
7461

3435
3436
3438
3433
3434

20 Amp | Ringless | With Provision for Test Switch | Two-Piece Front

Catalog Number	Terminal	Meter Form	Service	Hub	Bypass	Connectors CU/AL		Dimensions			Knockouts					
						Line	Load	D"	W"	H"	1	2	3	4	5	6
UC3425-XL	5	3S	OH/UG	C.P.	None	#14 - #2		5½	12	20	1¼	1¼	1¼	1¼	1¼	¼, ½
UC3426-XL	6	4S	OH/UG	C.P.	None	#14 - #2		5½	12	20	1¼	1¼	1¼	1¼	1¼	¼, ½
UC3428-XL	8	5S	OH/UG	C.P.	None	#14 - #2		5½	12	20	1¼	1¼	1¼	1¼	1¼	¼, ½
UC3423-XL	13	6, 8, 9S & (ALT) 10S	OH/UG	C.P.	None	#14 - #2		5½	12	20	1¼	1¼	1¼	1¼	1¼	¼, ½

20 Amp | Ring Type | Test Switch Factory Prewired | Two-Piece Front

Approved for Tucson Electric Power

Catalog Number	Terminal	Service	Hub	Bypass	Connectors CU/AL		Dimensions			Knockouts						
					Line	Load	D"	W"	H"	1	2	3	4	5	6	
UC7636-YL-TGE-DES	6	OH	1¼	Test Switch	#14 - #2		4½	12	20	1¼	1¼	1¼	1¼	1¼	1¼	¼, ½
UC7461-YL-TGE-DES	13	OH	1¼	Test Switch	#14 - #2		4½	12	20	1¼	1¼	1¼	1¼	1¼	1¼	¼, ½

20 Amp | Ring Type | With Provision for Test Switch | EUSERC Compliant | Two-Piece Front

Catalog Number	Terminal	Service	Hub	Bypass	Connectors CU/AL		Dimensions			Knockouts						
					Line	Load	D"	W"	H"	1	2	3	4	5	6	
UC3435-XL	5	OH/UG	C.P.	None	#14 - #2		5½	12	20	2	2	2	2	2	2	-
UC3436-XL	6	OH/UG	C.P.	None	#14 - #2		5½	12	20	2	2	2	2	2	2	-
UC3438-XL	8	OH/UG	C.P.	None	#14 - #2		5½	12	20	2	2	2	2	2	2	-
UC3433-XL	13	OH/UG	C.P.	None	#14 - #2		5½	12	20	2	2	2	2	2	2	-
UC3434-XL	15	OH/UG	C.P.	None	#14 - #2		5½	12	20	2	2	2	2	2	2	-

Notes

- **Prewiring:** If factory prewiring is required consult factory before ordering. Please include meter socket catalog number, test switch number, meter form number, and a copy of your wiring diagram.
- **Test Switch Covers:** Units on this page can be used with clear lexan cover (except units **7636** and **7461**).
- **Connectors:** Units are supplied with sleeve type connectors (#14-#2).
- **Hubs:** For proper hub selection see the hub suffix chart in accessory section.

Please consult serving utility for their requirements prior to ordering or installing, as specifications and approvals vary by utility, and may require local electrical inspector approval. All installations must be installed by a licensed electrician and must comply with all national and local codes, laws and regulations. Milbank reserves the right to make changes in specifications and features shown without notice or obligation.



Current Transformer Test Switches

4, 7, & 10 Pole

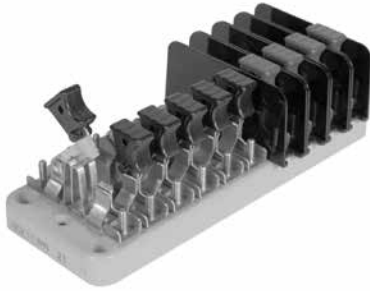

SWITCH BLADES

Two dimples coined into one side of the switch blade ensure positive contact in corrosive, sooty environments – even after years of inactivity.

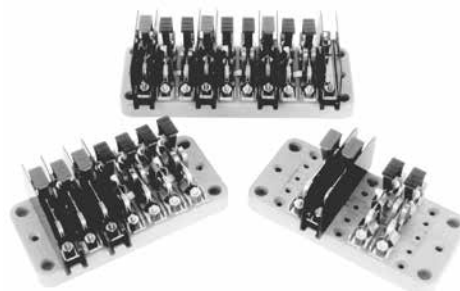

TEST SWITCH BASE

The base is molded from a high strength, fiberglass reinforced, thermoset polyester. This material is track resistant, flame retardant and has low water absorption qualities. Bases are available in 7 pole and 10 pole sizes.



POLARITY BARRIER

For maximum protection potential circuits are supplied with permanently mounted, rigid barriers made from high tensile strength, polycarbonate.

TEST SWITCH COVERS

Standard test switch covers are made from break resistant, clear, thermal plastic which has excellent tracking and moisture resistant properties. If covers are required, add suffix "-WC" (with cover) to the catalog number or order separately catalog number **K3388**. Black flush mount covers are also available. Order catalog number **K3388-BLK-FL**. 10 pole base only.

SWITCH JAWS

The switch blade jaw clips are constructed from spring grade copper alloy. The material and design ensure excellent contact which prevents overheating.

CURRENT CARRYING PARTS

Highly conductive copper and copper alloy materials are used on all current carrying parts. This ensures conductivity and deters corrosion. Spring grades are used where appropriate. Plating is available if required. Contact general offices to special order.

STANDARD COVER



K3388

Units must be
5-1/8" deep
for Cover

FLUSH MOUNT COVER BLACK



K3388-BLK-FL

Notes

- **Factory Installed:** For cover installed add the suffix **-WC** or **-WCFL** to the catalog number of desired test switch
- **Field Installed:** For field installed cover order kit number **K3388** or **K3388-BLK-FL**.

The MILBANK test switch is designed to meet the critical requirements of the electric utility industry. Not only do they meet EEI, ANSI C12.9, and UL standards but they combine several special features giving the MILBANK test switch increased safety, durability and reliability. One such feature is our unique switch blade contact points which cut through residue that builds up after years of service. Another distinction is our polarity barrier which is designed to be flexible as well as offer exceptional insulating qualities. Our test switches are constructed from the latest materials available using modern fabricating and assembly methods.



Please consult serving utility for their requirements prior to ordering or installing, as specifications and approvals vary by utility, and may require local electrical inspector approval. All installations must be installed by a licensed electrician and must comply with all national and local codes, laws and regulations. Milbank reserves the right to make changes in specifications and features shown without notice or obligation.

Current Transformer Test Switches

4, 7, & 10 Pole | 600 VAC | Per Ansi C12.9 Standard

57
CURRENT
TRANSFORMER
TEST SWITCHES

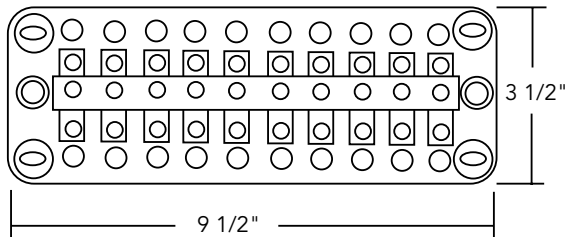
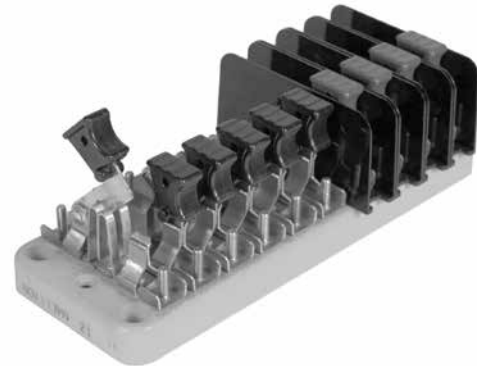
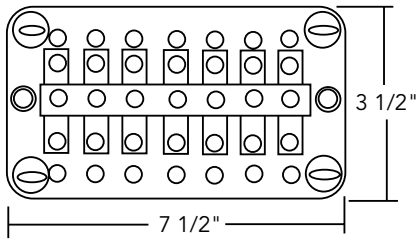

Catalog Number	4-POLE						
TS04-0101	X	P	Pn	X	C+	C	X
TS04-0104	X	C+	C	X	P	Pn	X

KEY	
P	Potential Switch
C+	Line side current switch with short circuit assembly
C	Load side current switch with test jack assembly
N	Neutral bar (no switch)
Pn	Neutral potential switch
X	Unused position on base
	Line side current switch with short circuit assembly

Catalog Number	7-POLE						
TS07-0105	P	P	Pn	C+	C	C+	C

Catalog Number	7-POLE ON A 10-POLE BASE									
TS07-0049	P	X	P	X	Pn	X	C+	C	C	C+
TS07-0106	X	P	C+	C	P	C+	C	Pn	X	X

CUSTOM POLE ARRANGEMENTS

The key may be used to diagram your own pole arrangement. Be sure to specify base size and whether all C+ line side, current switch/shunt circuit assemblies are to be bussed together. The catalog numbers shown above are connected in line-load pairs; therefore, if bussed is required, different catalog numbers will apply.

Catalog Number	10-POLE									
TS10-0109	P	P	P	Pn	C+	C	C+	C	C+	C
TS10-0110	P	C+	C	P	C+	C	P	C+	C	Pn
TS10-0111	P	P	P	Pn	C	C+	C	C+	C	C+
TS10-0112	C+	C	C+	C	C+	C	P	P	P	Pn
TS10-0016	P	P	P	PN	C	C+	C	C+	C	C+

Please consult serving utility for their requirements prior to ordering or installing, as specifications and approvals vary by utility, and may require local electrical inspector approval. All installations must be installed by a licensed electrician and must comply with all national and local codes, laws and regulations. Milbank reserves the right to make changes in specifications and features shown without notice or obligation.



Milbank Test Switch Worksheet



TEST SWITCH BASE

The base is molded from a high strength, fiberglass reinforced, thermoset polyester. This material is track-resistant, flame-retardant and has low water absorption qualities. Bases are available in two standard sizes following NEMA mounting classifications.

Customer Name: _____

Email: _____

Phone: _____

Handle Color Key							
BK	Black	P	Purple	Y	Yellow	GN	Green
R	Red	BL	Blue	W	White	BKS	BK/Stripe
BR	Brown	GR	Gray	O	Orange	WS	W/Stripe

Pole Position Chart

1	2	3	4	5	6	7	8	9	10

Special Features

Features	1	2	3	4	5	6	7	8	9	10

Engineering Information: _____

KEY	
P	Potential Switch
C+	Line side current switch with short circuit assembly
C	Load side current switch with test jack assembly
N	Neutral bar (no switch)
Pn	Neutral potential switch
X	Unused position on base
<input type="checkbox"/>	Line side current switch with short circuit assembly

Custom Pole Arrangements: The key may be used to diagram your own pole arrangement. Be sure to specify base size and whether all C+ line side, current switch/shunt circuit assemblies are to be bussed together. The catalog numbers shown above are connected in line-load pairs; therefore, if bussed is required, different catalog numbers will apply.

Number of Poles

- 4
- 7
- 10
- Other _____

Test Switch Cover*

- Yes ___ Clear ___ Black
- No

Base Size

- 7-Pole
- 10-Pole

* Test switch covers are only available for 10-pole bases.



Please consult serving utility for their requirements prior to ordering or installing, as specifications and approvals vary by utility, and may require local electrical inspector approval. All installations must be installed by a licensed electrician and must comply with all national and local codes, laws and regulations. Milbank reserves the right to make changes in specifications and features shown without notice or obligation.

Current Transformer Cabinets

Door Mount CT Rated Socket & Type 3R

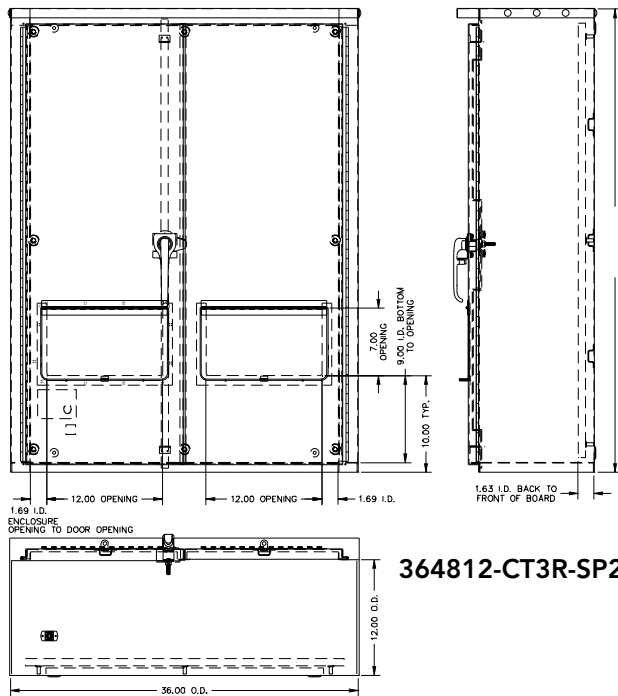

364812-CT3R-SP2

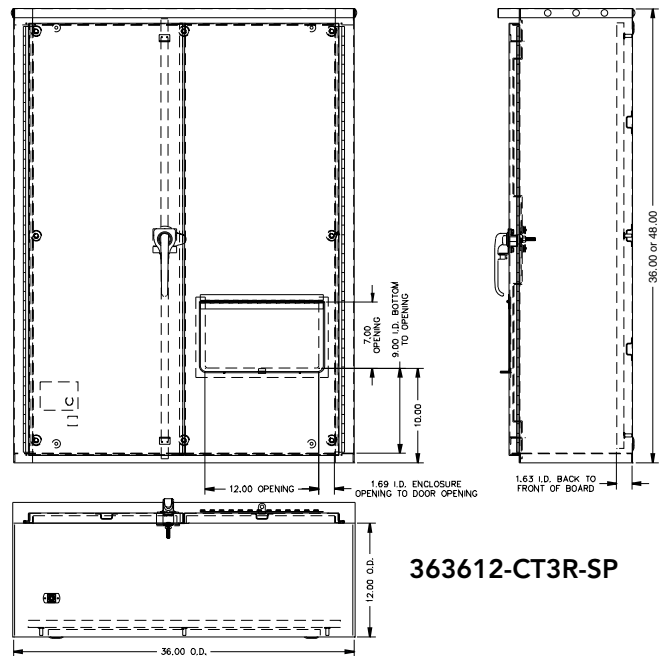

363612-CT3R-SP



Door Mount C.T. Rated Socket

Catalog Number	Terminal	Bypass	Amp	Connectors	Dimensions		
					D"	W"	H"
K4806-BP	13	Plunger	20 A	#14-4 Max	2½	7⅞	7½

Note

BP: The -BP suffix indicates plunger bypass.

Current Transformer Rated Cabinets – Type 3R

Catalog Number	Gauge of Steel	Dimensions			Panel Size		Panel & Backboard Catalog Numbers	
		D"	W"	H"	W" x H"	Painted Steel Panel	Wood Backboard	
243210-LC3R-SP	14	10	24	32	21	29	A-24P32	A-24P32W
323610-LC3R-SP	14	10	32	36	29	33	A-32P36	A-32P36W
363016-CT3R	14	16	36	30	33	27	A-36P30	A-36P30W
363612-CT3R-SP	14	12	36	36	33	33	A-36P36	A-36P36W Included
364812-CT3R-SP2	14	12	36	48	33	45	A-48P36	A-48P36W Included

Please consult serving utility for their requirements prior to ordering or installing, as specifications and approvals vary by utility, and may require local electrical inspector approval. All installations must be installed by a licensed electrician and must comply with all national and local codes, laws and regulations. Milbank reserves the right to make changes in specifications and features shown without notice or obligation.



Current Transformer Cabinets

Mounting Racks

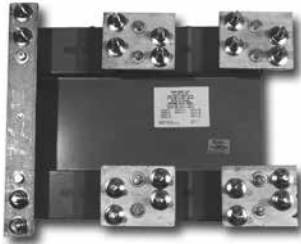

K4797



K4722

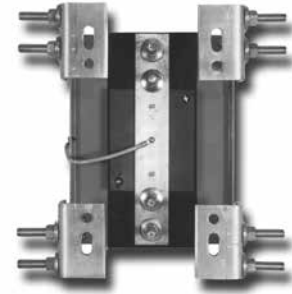

K4793/K4795

Current Transformer Enclosure Mounting Racks

Catalog Number	Code	AIC Rating	Amp	Volts	Type of Service	Termination Type
K4797	A4	50K	400	600	1Ø3W	1/2 x 13 Studs on 1-3/4" Centers
K4797	A	50K	800	600	1Ø3W	1/2 x 13 Studs on 1-3/4" Centers
K4798	B4	50K	400	600	3Ø4W	1/2 x 13 Studs on 1-3/4" Centers
K4798	B	50K	800	600	3Ø4W	1/2 x 13 Studs on 1-3/4" Centers
K4793	C	10K	201-400	600	1Ø3W	1/2 x 13 Studs on 1-3/4" Centers
K4795	D	10K	401-800	600	1Ø3W	1/2 x 13 Studs on 1-3/4" Centers
K4794	E	10K	201-400	600	3Ø4W	1/2 x 13 Studs on 1-3/4" Centers
K4796	F	10K	401-800	600	3Ø4W	1/2 x 13 Studs on 1-3/4" Centers
K4729	G	50K	800	600	1Ø3W	(3) #4 - 600 or (6) #1 - 250
K4722	H	50K	800	600	3Ø4W	(3) #4 - 600 or (6) #1 - 250
K4903	J	50K	400	600	1Ø3W	(1) #4 - 600 or (2) #1 - 250
K4904	K	50K	400	600	3Ø4W	(1) #4 - 600 or (2) #1 - 250
K5747	L	50K	800	600	3Ø4W	Line: 1/2 x 13 Studs on 1-3/4" Centers Load: (3) #4 - 600 or (6) #1 - 250
K5752	M	50K	800	600	1Ø3W	Line: 1/2 x 13 Studs on 1-3/4" Centers Load: (3) #4 - 600 or (6) #1 - 250

Note

- Match red code letter with the applicable CT Cabinet on pages 61 & 62.
- **1/2" Lug Kit:** order **K4200** (single, #4-600) or **K4223** (double, #6-350). Each Kit contains four connectors.



Please consult serving utility for their requirements prior to ordering or installing, as specifications and approvals vary by utility, and may require local electrical inspector approval. All installations must be installed by a licensed electrician and must comply with all national and local codes, laws and regulations. Milbank reserves the right to make changes in specifications and features shown without notice or obligation.

Current Transformer Cabinets

Screw Cover & Hinge Cover



CT363611-SC



CT203611-HC

Screw Cover

Catalog Number	C.T. Racks	Dimensions			Front Cover
		D"	W"	H"	
CT24329-SC	A4, C, D, G, J, M	9	24	32	1 Piece
CT242411-SC	G	11	24	24	1 Piece
CT243011-SC	A4, C, D, G, J, M	11	24	30	1 Piece
CT243611-SC	A4, C, D, G, J, M	11	24	36	1 Piece
CT244811-SC	A, C, D, G, J	11	24	48	1 Piece
CT303011-SC	A4, B4, C, D, E, F, G, H, J, K, L, M	11	30	30	1 Piece
CT303611-SC	A4, B4, C, D, E, F, G, H, J, K, L, M	11	30	36	1 Piece
CT363611-SC	A4, B4, C, D, E, F, G, H, J, K, L, M	11	36	36	1 Piece
CT364211-SC	A, B, C, D, E, F, G, H, J, K, L, M	11	36	42	2 Pieces
CT364811-SC	A, B, C, D, E, F, G, H, J, K, L, M	11	36	48	2 Pieces
CT424211-SC	A, B, C, D, E, F, G, H, J, K, L, M	11	42	42	2 Pieces
CT484811-SC	A, B, C, D, G, J, M	11	48	48	2 Pieces
CT303614-SC	A4, B4, C, D, E, F, G, H, J, K, L, M	14	30	36	2 Pieces
CT364814-SC	A, B, C, D, E, F, G, H, J, K, L, M	14	36	48	2 Pieces
CT484814-SC	A, B, C, D, E, F, G, H, J, K, L, M	14	48	48	2 Pieces

Hinge Cover

Catalog Number	C.T. Racks	Dimensions			Front Cover
		D"	W"	H"	
CT203611-HC	A4, C, D, J	11	20	36	1 Piece
CT243011-HC	A4, C, D, G, J, M	11	24	30	1 Piece
CT243611-HC	A4, C, D, G, J, M	11	24	36	1 Piece
CT244811-HC	A, C, D, G, J, M	11	24	48	1 Piece
CT303611-HC	A4, B4, C, D, E, F, G, H, J, K, L, M	11	30	36	1 Piece
CT304811-HC	A, B, B4, C, D, E, F, G, H, J, K, L, M	11	30	48	1 Piece
CT363611-HC	A4, B4, C, D, E, F, G, H, J, K, L, M	11	36	36	1 Piece
CT364811-HC	A, B, B4, C, D, E, F, G, H, J, K, L, M	11	36	48	1 Piece
CT484811-HC	A, B, C, D, J, M	11	48	48	2 Pieces
CT484814-HC	A, B, B4, C, D, E, F, G, H, J, K, L, M	14	48	48	2 Pieces

Note

- **Enclosure:** These units are rated Type 3R, powder coated, and constructed of galvanized steel.
- **Mounting Rack:** Select CT mounting rack by matching the appropriate letter in **CT rack column** on page 61 with applicable letter in **Code column** on page 60.
- **Mounting:** 1/4-20 welded studs.

Please consult serving utility for their requirements prior to ordering or installing, as specifications and approvals vary by utility, and may require local electrical inspector approval. All installations must be installed by a licensed electrician and must comply with all national and local codes, laws and regulations. Milbank reserves the right to make changes in specifications and features shown without notice or obligation.





U3565-O

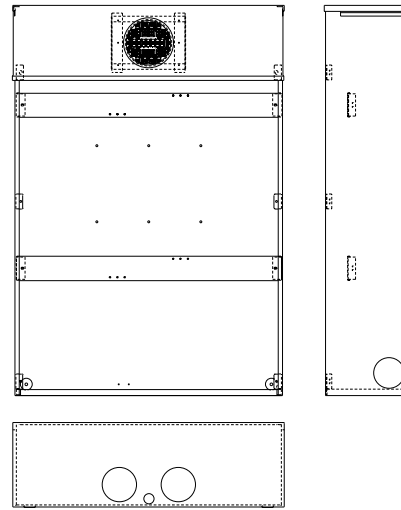

Metered Transformer Cabinets | Ring Type

Catalog Number	Terminal	Service	Meter Form	Hub	Dimensions			CT Racks
					D"	W"	H"	
U3319-R	5	OH	3S	H.O.	11	24	42	A, C, D, G, J, M
U3320-R	6	OH	4S	H.O.	11	24	42	A, C, D, G, J, M
U3321-R	8	OH	5S	H.O.	11	24	42	A, C, D, G, J, M
U3322-R	13	OH	6, 8, 9S & (ALT) 10S	H.O.	11	36	42	A, B, C, D, E, F, G, H, J, K, L, M
U3323-R	8	OH	5S	H.O.	11	36	42	A, B, C, D, E, F, G, H, J, K, L, M
U3555-R	15	OH	39S, 76S	H.O.	11	36	42	A, B, C, D, E, F, G, H, J, K, L, M
U3339-O	5	UG	3S	none	11	24	52	A, C, D, G, J, M
U3340-O	6	UG	4S	none	11	24	52	A, C, D, G, J, M
U3341-O	8	UG	5S	none	11	24	52	A, C, D, G, J, M
U3342-O	13	UG	6, 8, 9S & (ALT) 10S	none	11	36	52	A, B, C, D, E, F, G, H, J, K, L, M
U3343-O	8	UG	5S	none	11	36	52	A, B, C, D, E, F, G, H, J, K, L, M
U3565-O	15	UG	39S, 76S	none	11	36	52	A, B, C, D, E, F, G, H, J, K, L, M

Note

- **Meter Socket:** 20 amp current transformer meter socket built in.
- **Enclosure:** NEMA Type 3R with screw cover.
- **Current Transformer Mounting:** 1/4-20 welded studs.
- **Hubs:** For proper hub selection, see hub suffix chart in the accessory section.
- **Sealing Rings:** Supplied with **MR-4** screw type sealing ring.
- **Mounting Racks:** For mounting rack information refer to previous page. Select CT mounting rack by matching the appropriate letter in **CT rack column** on page 62 with applicable letter in **Code column** on page 60.



Please consult serving utility for their requirements prior to ordering or installing, as specifications and approvals vary by utility, and may require local electrical inspector approval. All installations must be installed by a licensed electrician and must comply with all national and local codes, laws and regulations. Milbank reserves the right to make changes in specifications and features shown without notice or obligation.

Service Pedestals

125 Amp | Mobile Home Metered | 120/240 VAC

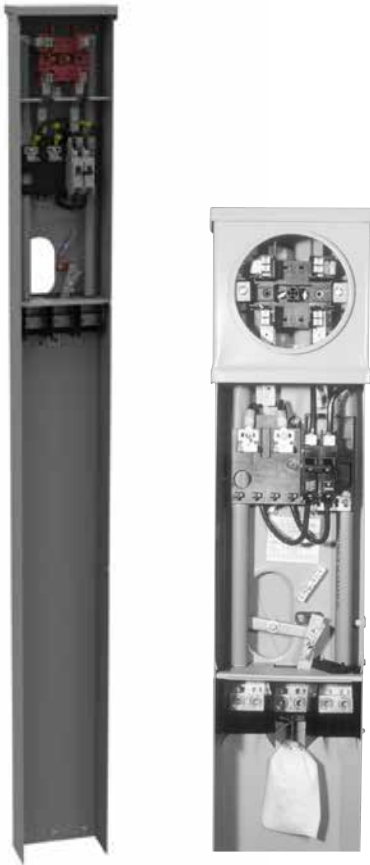

MPRV-100-MB-78

Standard Configurations

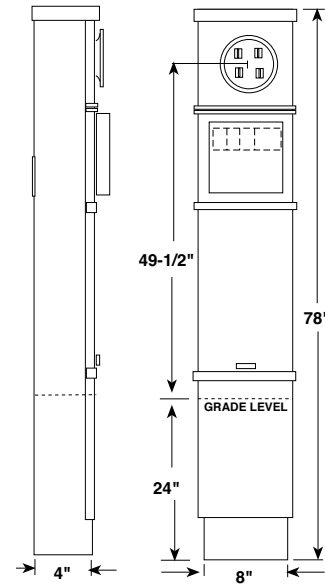
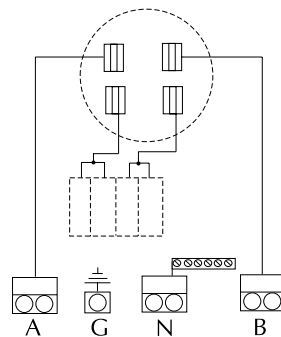
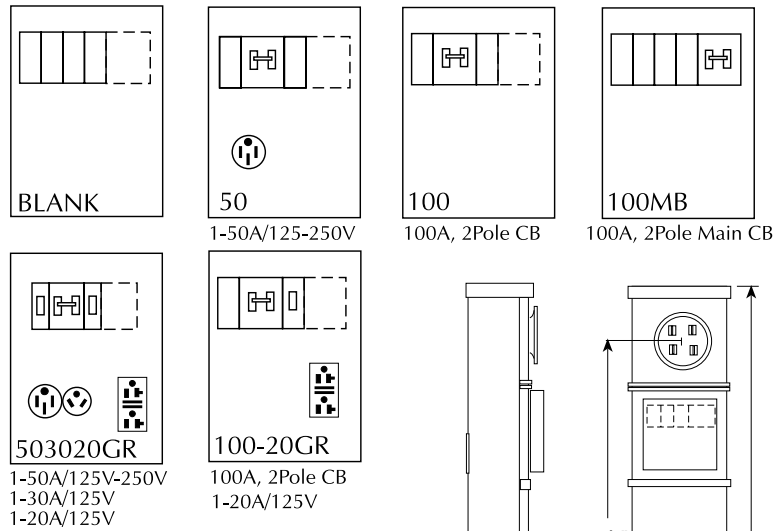

Single

Specifications

- UL listed 100 amp continuous duty meter socket.
- 120/240 volt single phase service.
- Twin line termination lugs #6-350 kcmil CU/AL per phase for looping.
- Space for four (4) single, or one double (240V C/B center- positions only) and two (2) single pole universal style, plug-in circuit breakers.
- Ringless version equipped with horn bypass as standard.
- For fifth terminal field installed order kit **105J** in the 3 o'clock or 9 o'clock position.
- Direct rear feed kit **PF-KR** included.
- For optional stabilizer foot, order **K5763**.
- Specify **MPRV-100-78** for 100 amp service pedestal with direct feed kit and 100 amp CB wired in parallel. Space for two additional single pole CBs provided. Series wiring available; specify **MPRV-100-MB-78**.
- **MR-2** sealing ring standard with ring type cover.
- No knockouts.

Catalog Number	Description
MPRV-BLANK-78	Ring type, parallel wired
MPRV-BLANK-78-R-5T	Ringless, horn bypass
MPRV-100-78	Ring type, parallel wired
MPRV-100-MB-78	Ring type, series wired
MPRV-100-20GR-78	Ring type, parallel wired
MPRV-50-78	Ring type
MPRV-503020GR-78	Ring type

Please consult serving utility for their requirements prior to ordering or installing, as specifications and approvals vary by utility, and may require local electrical inspector approval. All installations must be installed by a licensed electrician and must comply with all national and local codes, laws and regulations. Milbank reserves the right to make changes in specifications and features shown without notice or obligation.



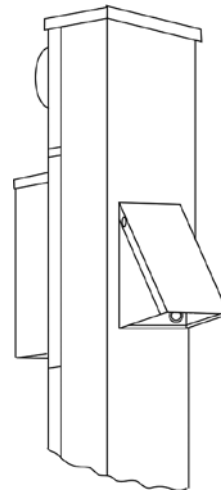
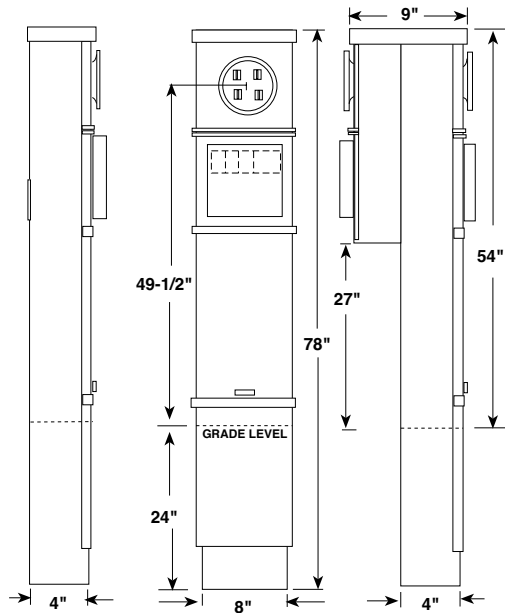

MPAP-200-78

Standard Configurations

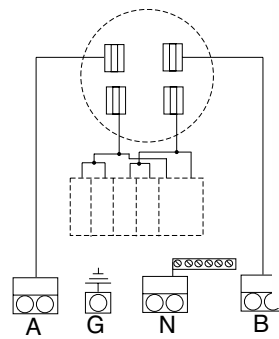
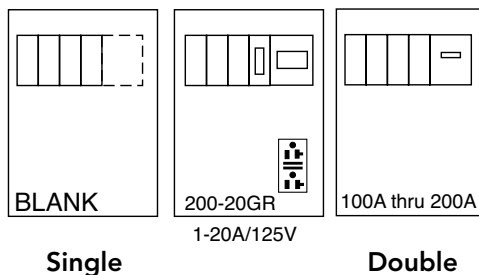

Catalog Number	Description
MPAP-BLANK-78	Ring type, parallel wired
MPAP-BLANK-78R	Ringless, horn bypass, parallel wired
MPAP-100-78	Ring type, parallel wired
MPAP-100-MB-78	Ring type, series wired
MPAP-200-78	Ring type, parallel wired
MPAP-200-MB-78	Ring type, series wired
MPAP-200-20GR-78	Ring type, parallel wired
MPAPD-BLANK-78	Ring type, parallel wired
MPAPD-BLANK-78R	Ringless, horn bypass, parallel wired

Specifications

- 120/240 volt single phase service.
- Twin line termination lugs #6-350 CU/AL per phase for looping.
- **UQFP** breaker provisions factory wired in parallel with branch breaker bus. Series wiring available. Specify **MB** after breaker rating, ex. **MPAP-200-MB**.
- Furnished with space for four single or one double (240V C/B center-positions only) and two single pole universal style, plug-in circuit breakers in addition to main.
- Ringless version equipped with horn bypass as standard.
- For fifth terminal field installed order kit **105J** in the 3 o'clock or 9 o'clock position.
- Direct rear feed kit **PF-KR** included.
- **MR-2** sealing ring standard with ring type cover.
- Series conversion kit order K4714

Notes

- Order K4714 for series wire kit.
- Order K5194 for parallel to series field conversion kit.
- Order K5193 for series to parallel field conversion kit.



Please consult serving utility for their requirements prior to ordering or installing, as specifications and approvals vary by utility, and may require local electrical inspector approval. All installations must be installed by a licensed electrician and must comply with all national and local codes, laws and regulations. Milbank reserves the right to make changes in specifications and features shown without notice or obligation.

Power Pedestals with Load Center

100 & 200 Amp Series MPRV & MPAP | Ring Type

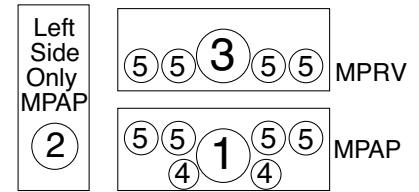
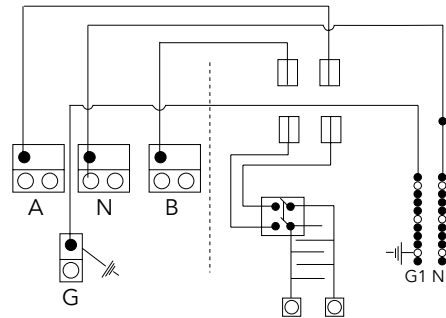
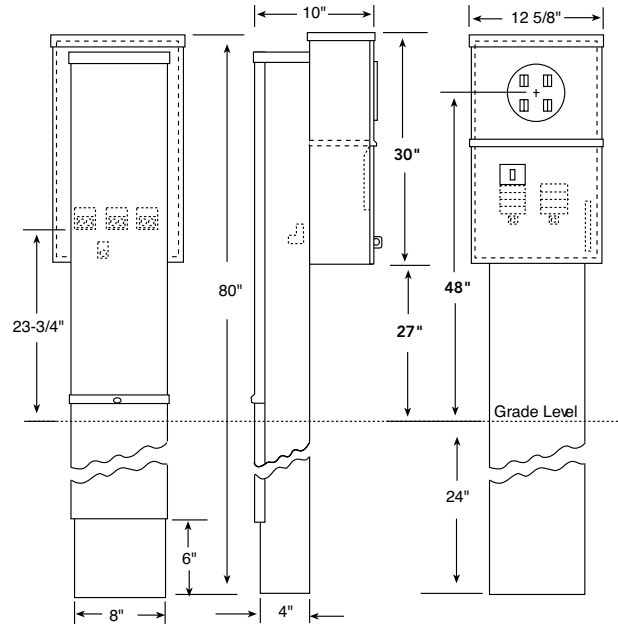

MPAP-200-MBLC-80

100 & 200 Amp | Load Center Power Outlets

Catalog Number	Description	Knockouts				
		1	2	3	4	5
MPRV-100-MBLC-80	100 Amp Metered Pedestal with (8) Circuit Load Center	2½	2	-	1¼	½, ¾
MPAP-200-MBLC-80	200 Amp Metered Pedestal with (8) Circuit Load Center	2½	2	-	1¼	½, ¾

Specifications

- UL listed 100/200 amp continuous duty meter socket.
- Approved for 120/240 volt single phase service.
- Twin line termination lugs #6-350 CU/AL per phase for looping. Rear termination.
- Space for (8) single, or (4) double and two single pole universal style plug-in circuit breakers.
- Series main breaker factory installed.
- Direct feed lugs standard.

Please consult serving utility for their requirements prior to ordering or installing, as specifications and approvals vary by utility, and may require local electrical inspector approval. All installations must be installed by a licensed electrician and must comply with all national and local codes, laws and regulations. Milbank reserves the right to make changes in specifications and features shown without notice or obligation.



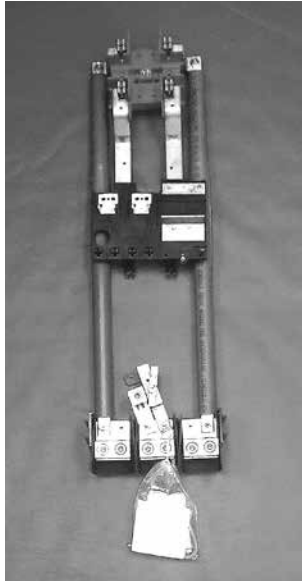

Catalog Number Z020-148-00-00-0
MPAP 200A interior rebuild kit



Catalog Number 020-147-00-00-0
MPRV 100A interior rebuild kit

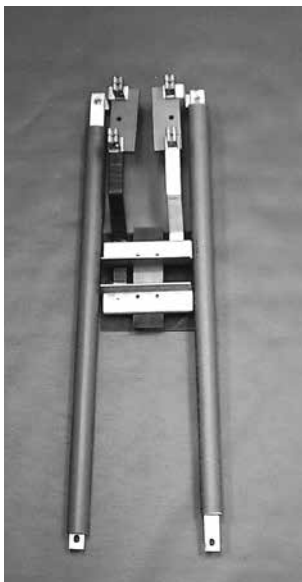

Catalog Number RBK-1
Unicorn MPP (pre-1969)
interior rebuild kit

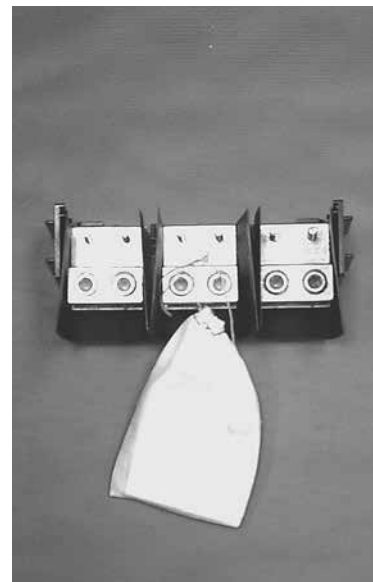

Catalog Number Z1050596
MPAP, MPRV & Unicorn MPP
lug landing assembly with grounding kit

**Above items sold as complete assemblies only.
Individual components not available.**



Please consult serving utility for their requirements prior to ordering or installing, as specifications and approvals vary by utility, and may require local electrical inspector approval. All installations must be installed by a licensed electrician and must comply with all national and local codes, laws and regulations. Milbank reserves the right to make changes in specifications and features shown without notice or obligation.

Replacement Parts

Mobile Home Rebuild Kits

67
REPLACEMENT
PARTS



Catalog Number PF-BL
MPAP/MPRV blank deadfront
with hinged cover



Catalog Number PF-KR
MPAP/MPRV rear connector kit



Lug Cover for MPAP/MPRV
Order Catalog Number **403456-SC**
(8-1/2" W X 20-1/2" H) for 72" pedestals
and Catalog Number **403457-SC** (8-1/2" W X 26-1/2" H)
for 78" pedestals.

Please consult serving utility for their requirements prior to ordering or installing, as specifications and approvals vary by utility, and may require local electrical inspector approval. All installations must be installed by a licensed electrician and must comply with all national and local codes, laws and regulations. Milbank reserves the right to make changes in specifications and features shown without notice or obligation.



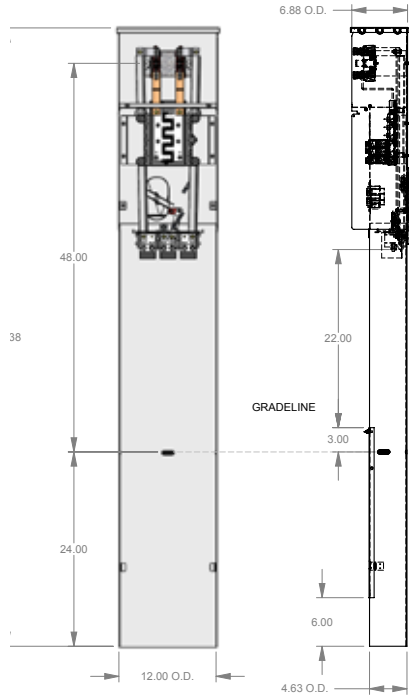

Features and Benefits

- Circuit breaker interior has provisions for twelve full one-inch poles (including main).
- Rating: 100 Amp, 120/240 VAC.
- Interiors will accept plug-in breakers. (GE, Cutler-Hammer, Siemens, SQD)
- Suitable for use as service equipment and mobile home service equipment.
- Rear Feed Kit included in Pedestal
- Twin 350 MCM line terminals (installed) provide optional loop-feed installation.
- 14 gauge corrosion resistant steel construction.
- Type 3R Raintight enclosure.
- Padlock provision.
- Total unit height is 76". Burial depth is 24". Installed height from ground is 48" to meter center.
- Standard color: gray powder coat finish.
- EUSERC compliant drawing number 307
- Pad Mount version available

Catalog Number	Configuration
U6276-O-10GR	(1) 20 amp 5-20R Duplex
U6276-O-54	(1) 50 amp 14-50R Duplex
U6276-O-41	(1) 20 amp 5-20R Duplex (1) 30 amp TT-30R
U6276-O-55	(1) 20 amp 5-20R Duplex (1) 50 amp 14-50GR
U6276-O-75	(1) 50 amp 14-50R (1) 30 amp TT30 (1) 20amp 5-20GR Duplex
U6276-O-100	(1) 100 amp breaker installed
U6276-O-100MB	(1) 100 Main Breaker series wired

Notes

- Contact Factory for additional options
- Extension Kit and Stabilizer Foot Available
- Replacement Parts available (covers, dead-fronts, receptacles, breakers).



Please consult serving utility for their requirements prior to ordering or installing, as specifications and approvals vary by utility, and may require local electrical inspector approval. All installations must be installed by a licensed electrician and must comply with all national and local codes, laws and regulations. Milbank reserves the right to make changes in specifications and features shown without notice or obligation.

Service Pedestals

200 Amp | U5240 & U5241 Series | Ring Type

69
SERVICE
PEDESTALS



U5240-O-200S

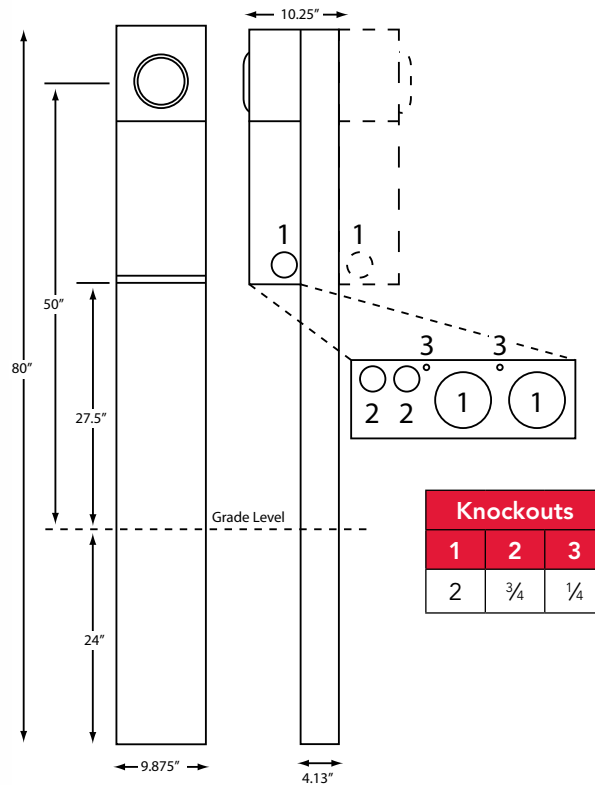

Specifications

- Twin line termination lugs #6-350 CU/AL per phase for looping.
- 200 amp maximum, 120/240 volt, single phase, three wire meter socket.
- Ring type meter socket with stainless steel screw-type sealing ring.
- Short circuit withstand rating 22K AIC.
- Type 3R construction for durable outdoor use, one piece post – lockable and sealable.
- ANSI 61 gray polyester powder coat finish.
- Wire terminations accept copper or aluminum conductors.
- Line & neutral: (2) #6-350 kcmil per phase
- Line ground: (4) #14-1/0
- Load: See Circuit Breaker
- Load neutral: (1) #6-350 kcmil.
- Load ground: (2) #14-1/0, (4) #14/6
- Milbank plug-in main circuit breaker. Available in 100, 125, 150 & 200 amp. Type **UQFPH-M**.
- Four-circuit plated copper interior accepts (2) 2-pole or (4) 1-pole standard plug-in type circuit breakers up to a total of 125 amp maximum. Acceptable manufacturers: Cutler-Hammer, GE or Siemens
- Factory or field-installable receptacle bridge and receptacle/circuit breaker kits available. See accessories.

Please consult serving utility for their requirements prior to ordering or installing, as specifications and approvals vary by utility, and may require local electrical inspector approval. All installations must be installed by a licensed electrician and must comply with all national and local codes, laws and regulations. Milbank reserves the right to make changes in specifications and features shown without notice or obligation.



200 Amp | 4 Terminal | Service Pedestals | Ring Type

Catalog Number	Powerheads	Mounting	Main Breaker	Main CB	Circuits	Dimensions		
						D"	W"	H"
U5240-O-100S	Single	Direct Burial	UQFPH-M-100	100	4	10¼	10	80
U5240-O-200S	Single	Direct Burial	UQFPH-M-200	200	4	10¼	10	80
U5240-O	Single	Direct Burial	Provision for UQFPH-M series	—	4	10¼	10	80
U5242-O-200S	Single	Pad Mount	UQFPH-M-200	200	4	10¼	10	56
U5242-O	Single	Pad Mount	Provision for UQFPH-M series	—	4	10¼	10	56
U5241-O-100S	Double	Direct Burial	(2) UQFPH-M-100	100	4	16	10	80
U5241-O-200S	Double	Direct Burial	(2) UQFPH-M-200	200	4	16	10	80
U5241-O	Double	Direct Burial	Provision for (2) UQFPH-M series	—	4	16	10	80
U5243-O	Double	Pad Mount	Provision for (2) UQFPH-M series	—	4	16	10	56

Accessories

Catalog Number	Description
K5415	Stabilizer foot with hardware
K5035	Pad mount kit with hardware for U5242 & U5243
K5T	5th terminal for 208y/120V 3-wire service
K5193	Bus kit to convert series-wired main breaker to parallel
K5194	Wire kit to convert parallel-wired main breaker to series
K3450	Telephone/CATV mounting bracket (mounts left or right)
K5039	Penta bolt utility cover

Notes

- Up to two receptacle/circuit breaker kits can be field-installed in each powerhead. Order mounting bridge and receptacle kits separately from above. For three receptacles or factory-installed kits, contact factory.
- **K5415** Stabilizer Foot sold separately. Recommended for double pedestals.
- Pad mount pedestals require **K5035** pad mount kit. Order separately.
- Receptacles and circuit breakers can be found in the accessories section.

Service Pedestals

200 Amp | Ringless

71
SERVICE
PEDESTAL



U5136-O-200S

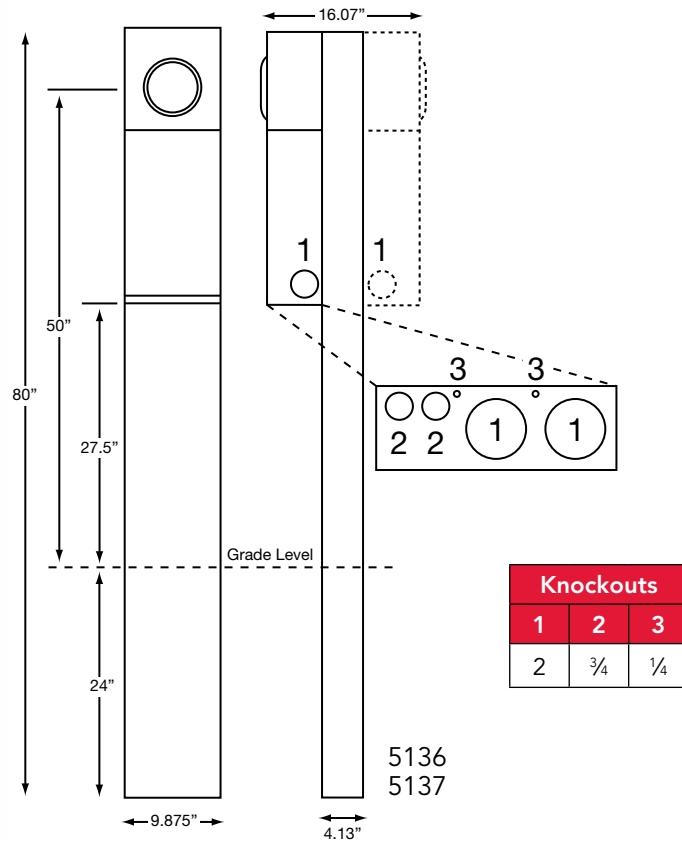

Specifications

- UL listed
- 200 amp maximum, 120/240 V, 1Ø3W
- Ringless type meter socket with stainless steel latch
- Short circuit withstand rating 22 KAIC
- Type 3R construction for durable outdoor use
- ANSI 61 gray polyester powder coat finish
- Wire terminations accept copper or aluminum conductors
- Line & Neutral: (2) #6-350 kcmil per phase, Line Ground: (4) #14-1/0
- Load (CB): 2/0 to 300 kcmil per pole
- Load neutral: (1) #6-350 kcmil
- Load ground: (2) #14-1/0, (4) #14/6
- Commercial grade, plug-in main circuit breaker. Available in 100, 125, 150 & 200 AMP. Type UQFP-H-M.
- 4 circuit plated copper interior accepts (2) 2-pole or (4) 1-pole standard plug-in type circuit breakers. Branch circuit rated to 125 amp max. Acceptable manufacturers: Milbank, Cutler-Hammer, GE or Siemens
- Twin line termination lugs #6-350 CU/AL per phase for looping.

Please consult serving utility for their requirements prior to ordering or installing, as specifications and approvals vary by utility, and may require local electrical inspector approval. All installations must be installed by a licensed electrician and must comply with all national and local codes, laws and regulations. Milbank reserves the right to make changes in specifications and features shown without notice or obligation.



100–200 Amp | Meter Main with Load Center Pedestals | Ringless

Catalog Number	Powerheads	Mounting	Amp	Main Breaker	Interior	Dimensions			Knockouts		
						D"	W"	H"	1	2	3
U5136-O-100S	Single	Direct Burial	100	UQFPH-M-100	4 circuit	10 $\frac{1}{4}$	10	80	2	1/2, 3/4	1/4
U5136-O-200S	Single	Direct Burial	200	UQFPH-M-200	4 circuit	10 $\frac{1}{4}$	10	80	2	1/2, 3/4	1/4
U5136-O	Single	Direct Burial	—	Provision for UQFPH-M series	4 circuit	10 $\frac{1}{4}$	10	80	2	1/2, 3/4	1/4
U5137-O-100S	Double	Direct Burial	100	(2) UQFPH-M-100	4 circuit	16 $\frac{1}{6}$	10	80	2	1/2, 3/4	1/4
U5137-O-200S	Double	Direct Burial	200	(2) UQFPH-M-200	4 circuit	16 $\frac{1}{6}$	10	80	2	1/2, 3/4	1/4
U5137-O	Double	Direct Burial	—	Provision for (2) UQFPH-M series	4 circuit	16 $\frac{1}{6}$	10	80	2	1/2, 3/4	1/4
U5138-O-200S	Single	Pad Mount	200	UQFPH-M-200	4 circuit	10 $\frac{1}{4}$	10	56	2	1/2, 3/4	1/4
U5138-O	Single	Pad Mount	—	Provision for UQFPH-M series	4 circuit	10 $\frac{1}{4}$	10	56	2	1/2, 3/4	1/4
U5139-O	Double	Pad Mount	—	Provision for UQFPH-M series	4 circuit	16 $\frac{1}{6}$	10	56	2	1/2, 3/4	1/4

Accessories

Catalog Number	Description
K5415	Stabilizer foot with hardware
K5035	Pad mount kit with hardware for U5138
K5T	5th terminal for 208y/120V 3-wire service
K5193	Bus kit to convert series-wired main breaker to parallel
K5194	Wire kit to convert parallel-wired main breaker to series
K3450	Telephone/CATV mounting bracket (mounts left or right)
K5039	Penta bolt utility cover

Notes

- **Parallel to Series Conversion:** For field converting from parallel wired to series wired order **K5194**.
- **Fifth Terminal:** For field installed fifth terminal, order **K5T**.
- **Stabilizer Foot:** For field installed stabilizer foot, order **K5415**.
- **Penta Bolt Locking:** For field installed pedestal fronts penta bolt locking, order **K5039**.
- **Pad Mount Units:** Pad mount pedestals require **K5035** pad mount kit. Order separately.
- Receptacles and circuit breakers can be found in the accessories section.



Please consult serving utility for their requirements prior to ordering or installing, as specifications and approvals vary by utility, and may require local electrical inspector approval. All installations must be installed by a licensed electrician and must comply with all national and local codes, laws and regulations. Milbank reserves the right to make changes in specifications and features shown without notice or obligation.

Service Pedestals

U5706 Series | Ringless

73
SERVICE
PEDESTALS

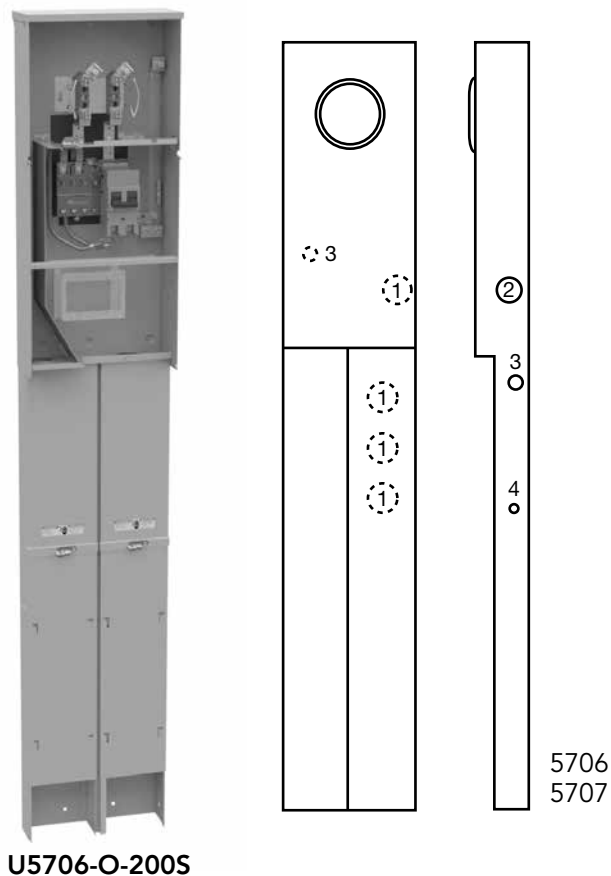

U5706-O-200S

Specifications

- 200 amp, 1Ø, 120/240 volt, 22K AIC, underground service only.
 - U5706 has ringless meter socket available with or without horn bypass (-KK).
 - U5707 has ring type meter socket with MR-4 screw type meter ring.
 - Suitable for use as service equipment, mobile home service equipment and temporary power service equipment.
 - Direct burial pedestal suitable for free standing or structure mounted installation.
 - Separate line and load wireways are removable, lockable and sealable for security.
 - Left side is for utility connection. Right side is for customer underground load exit.
 - Convenient knockouts in post for through-wall load exit requirements.
 - Type 3R enclosure constructed with type G90 galvanized steel.
 - Repaintable light gray polyester powder coat finish.
 - Wire terminations accept copper or aluminum conductors: Line & Neutral: #6-350 Ground: (4) #14-1/0.
 - Main circuit breaker can be series or parallel connected.
 - Universal 4 circuit branch 125 amp interior (up to (2) 2-pole) accepts most manufacturers plug-in type circuit breakers. See wiring diagram.
- *Provisions for up to two Type 3R in-use receptacle.
- *Order receptacle and bridge separately. See ordering information.

Please consult serving utility for their requirements prior to ordering or installing, as specifications and approvals vary by utility, and may require local electrical inspector approval. All installations must be installed by a licensed electrician and must comply with all national and local codes, laws and regulations. Milbank reserves the right to make changes in specifications and features shown without notice or obligation.



200 Amp | 4 Terminal | Meter Main Pedestal | Ringless

Catalog Number	Service	Bypass	Connectors CU/AL		Dimensions			Knockouts			
			Line	Load	D"	W"	H"	1	2	3	4
U5706-O-200S	UG	None	#6-350	CB	5½	14	80	2½	2	1	¼,½
U5706-O-200S-KK	UG	Horn	#6-350	CB	5½	14	80	2½	2	1	¼,½

200 Amp | 4 Terminal | Meter Main Pedestal | Ring Type

Catalog Number	Service	Bypass	Connectors CU/AL		Dimensions			Knockouts			
			Line	Load	D"	W"	H"	1	2	3	4
U5707-O-200S	UG	None	#6-350	CB	5½	14	80	2½	2	1	¼,½

Notes

- **Fifth Terminal:** For field installed fifth terminal, order **K5T**.
- **Receptacles:** Maximum of two receptacles can be added. Contact Milbank for details.
- **Post Extension Kit:** To increase pedestal height, order field-installed post extension kit **K5708**.
- **Series-to-Parallel Field Conversion:** For field conversion from series to parallel wired, order kit **K5193**.
- **Branch Circuit Breakers (Four Additional Single Pole Spaces):** Branch interior accepts most manufacturers' small frame plug-in type circuit breakers (GE, Siemens, Cutler Hammer). Load center's four left stabs are rated up to 125 amp total.

Accessories



K5400-BRIDGE-1POS



K5400-BRIDGE-2POS



UQFPH-M-200

Temporary Power

75
TEMPORARY
POWER

U4908 & U4909 Underground Service Power Outlet



U4909-O-11GR

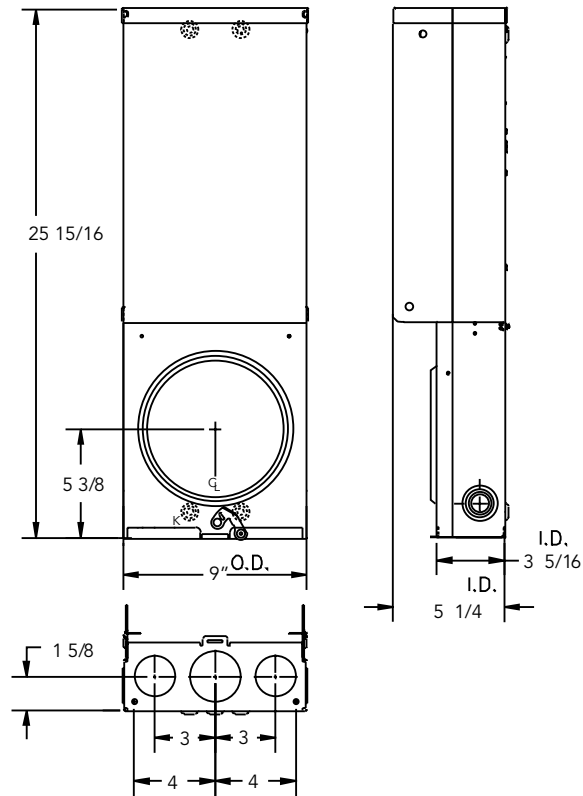

Specifications

- Available in ringless style (**U4908** series) or ring type (**U4909** series).
- UL listed 100 amp, 120/240 Volt – 1Ø Underground Service Power Outlets.
- Short circuit current withstand rating 10K RMS symmetrical amperes.
- Type 3R welded enclosure for durable outdoor use.
- Enclosure constructed with galvanized 16 gauge steel.
- ANSI 61 gray polyester powder coat finish.
- Convenient concentric knock-out configurations and mounting embosses.
- Wire terminations accept copper or aluminum conductors.
Service – Line & Neutral: (1) #6-2/0 Load Ground: (2) 1/0-#14 & (4) #6-#14
Load Neutral: (2) 1/0-#14 & (4) #6-#14 Service Ground: #2-#8
- Six circuit plated copper interior accepts standard plug-in type circuit breakers.
- Three position **self-grounded** receptacle bridge accepts most standard NEMA receptacles with mounting plates.
- Four terminal, ringless meter socket with stainless steel locking hasp. Ring type socket has aluminum **MR-2** snap action sealing ring.
- Lockable hinge cover and deadfront are removable for installation and maintenance. Stay-open hinge cover has safety interlock on deadfront. Deadfront must be removed before hinge cover can be removed.
- Tamper proof fastening available.

Please consult serving utility for their requirements prior to ordering or installing, as specifications and approvals vary by utility, and may require local electrical inspector approval. All installations must be installed by a licensed electrician and must comply with all national and local codes, laws and regulations. Milbank reserves the right to make changes in specifications and features shown without notice or obligation.



U4908 & U4909 Standard Configurations

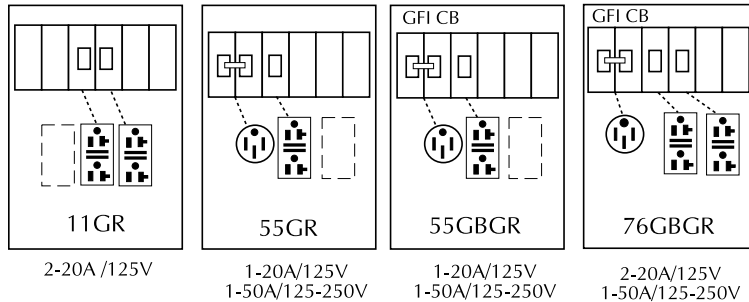

Ordering Information

Catalog Number	Socket Type	Description
• U4908-O	Ringless	Order base model and up to three factory installed receptacle/breaker kit separately from list below. Other kits available. Consult factory.
• U4908-O-11GR	Ringless	
• U4908-O-55GBGR	Ringless	
• U4909-O	Ring type	Order base model and up to three factory installed receptacle/breaker kit separately from list below. Other kits available. Consult factory.
• U4909-O-11GR	Ring type	
• U4909-O-55GBGR	Ring type	

Note: Flat cover may not close completely with twist locking devices in use.

Order slope-front 3R cover #1107681 separately to use with twist lock type receptacles.

- Stock item – availability subject to prior sale.
- Non-stock items – minimum order quantity required.

Temporary Power

Series U5001 Unmetered Service Mount Power Outlet

77
TEMPORARY
POWER



U5001-RL-01

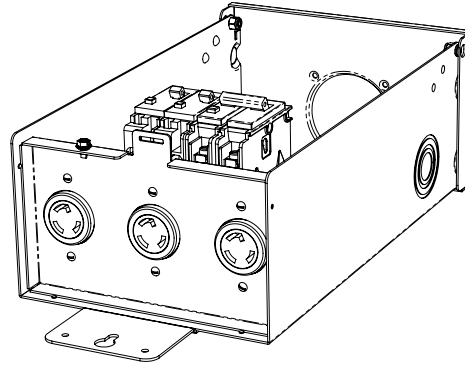

Specifications

- UL listed 125 amp, 120/240 Volt, 1Ø Power Outlet.
- Short circuit current withstand rating 10K RMS symmetrical amperes.
- Type 3R welded enclosure for durable outdoor use.
- ANSI 61 gray polyester powder coat finish.
- Wire terminations accept copper or aluminum conductors.
Line: 1/0-#4 Ground/Neutral: (4) 1/0-#14 & (11) #14-#6
- Six circuit plated copper interior accepts standard plug-in type circuit breakers.
- Components factory wired with stranded copper wire.
- Lockable hinge cover and deadfront are removable for installation and maintenance.
- U5001-RL-01 includes:
 - (1) L6-30 (1) 30 Amp, 2P, 240V GFI Breaker
 - (2) L5-20 (2) 20 Amp, 1P, 120V GFI Breaker

Please consult serving utility for their requirements prior to ordering or installing, as specifications and approvals vary by utility, and may require local electrical inspector approval. All installations must be installed by a licensed electrician and must comply with all national and local codes, laws and regulations. Milbank reserves the right to make changes in specifications and features shown without notice or obligation.





U5865-XL-38GBGRW

Specifications

- UL listed 125 amp, 120/240 Volt, 1Ø Power Outlet.
- Short circuit current withstand rating 10K RMS symmetrical amperes.
- Type 3R welded enclosure for durable outdoor use.
- ANSI 61 gray polyester powder coat finish.
- Wire terminations accept copper or aluminum conductors.
Line & Line Neutral: 250-#6
- Six circuit plated copper interior accepts standard plug-in type circuit breakers.
- Components factory wired with stranded copper wire.
- Lockable hinge cover and deadfront are removable for installation and maintenance.
- **U5865-XL-38GBGRW** includes:
 - (1) L6-30 (1) 30A, 2P, 240V GFI Breaker
 - (2) L5-20 GFI receptacles (2) 20A, IP, 120V Breaker

Temporary Power

Series U5001 Unmetered Service Mount Power Outlet

Catalog Number	Circuit Breaker Description
Q115	15 Amp – 1 Pole – 120/240 – Plug-In Circuit Breaker
Q120	20 Amp – 1 Pole – 120/240 – Plug-In Circuit Breaker
Q130	30 Amp – 1 Pole – 120/240 – Plug-In Circuit Breaker
Q220	20 Amp – 1 Pole – 120/240 – Plug-In Circuit Breaker
Q250	50 Amp – 2 Pole – 120/240 – Plug-In Circuit Breaker
Q2100	100 Amp – 2 Pole – 120/240 – Plug-In Circuit Breaker
708784-MO	20 Amp – GFCI – 1 Pole – 120/240 – Plug-In Circuit Breaker
708785-MO	30 Amp – GFCI – 1 Pole – 120/240 – Plug-In Circuit Breaker
707915-MO	50 Amp – GFCI – 1 Pole – 120/240 – Plug-In Circuit Breaker
703997-MO	50 Amp – Quad – 2 Pole – 120/240 – Circuit Breaker

Catalog Number	Receptacle Description
708777-MO	20 Amp – 120V – NEMA 5-20R – Duplex Receptacle
708080-MO	20 Amp – 120V – NEMA 5-20 – GFCI Duplex Receptacle
704995-MO	20 Amp – 250V – NEMA 6-20R – Single Receptacle
701776-MO	30 Amp – 120V – NEMA TT-30R – Travel Trailer Receptacle
706761-MO	50 Amp – 120V – 3 Pole – 3 Wire – NEMA 10-50R – Receptacle
Z700911-MO	50 Amp – 120/250V – 3 Pole – 4 Wire – NEMA 14-50R – Receptacle

Catalog Number	Lug Landings & Breaker Base Description
Z1050596	MPRV/MPAP – Lug Landing (Twin #6-350 KCMIL)
Z020-148-00-00-0	MPAP – Complete Interior Assembly

Note

- The following brand names may be supplied when replacement circuit breakers are ordered:
Cutler-Hammer/ Westinghouse – QP, BQC, BD, BR. Siemens/ITE – Q, QT. General Electric – TQ, THQ, THQL.
Challenger – C, Q, QC, QP. Contact sales office for brand specific requirements.

Please consult serving utility for their requirements prior to ordering or installing, as specifications and approvals vary by utility, and may require local electrical inspector approval. All installations must be installed by a licensed electrician and must comply with all national and local codes, laws and regulations. Milbank reserves the right to make changes in specifications and features shown without notice or obligation.



Surface Mount Power Outlets

Millennium Series | 120/240 VAC



U5000-XL-75

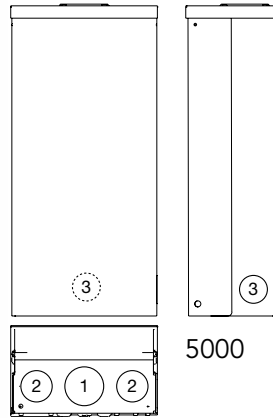

5000



U5100-XL-75

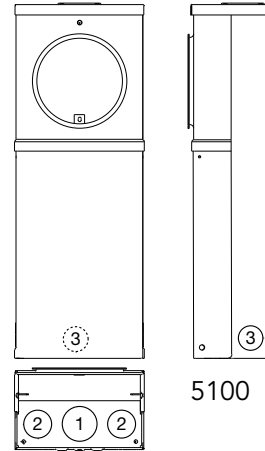

5100

125 Amp | Surface Mount Power Outlets

Catalog Number	Metered/ Unmetered	Receptacle Configuration	Circuit Breaker Configuration	Loop Feed	Connectors Line	Dimensions			Knockouts		
						D"	W"	H"	1	2	3
U5000-XL	Unmetered	—	—	Yes	(2) 1/0-#12	5½	9⅞	19¼	2	1½	1¼
U5000-XL-41	Unmetered	A	X	Yes	(2) 1/0-#12	5½	9⅞	19¼	2	1½	1¼
U5000-XL-55	Unmetered	B	Y	Yes	(2) 1/0-#12	5½	9⅞	19¼	2	1½	1¼
U5000-XL-75	Unmetered	C	Z	Yes	(2) 1/0-#12	5½	9⅞	19¼	2	1½	1¼
U5100-XL	Metered	—	—	No	#6-250	5½	9⅞	25	2	1½	1¼
U5100-XL-41	Metered	A	X	No	#6-250	5½	9⅞	25	2	1½	1¼
U5100-XL-55	Metered	B	Y	No	#6-250	5½	9⅞	25	2	1½	1¼
U5100-XL-75	Metered	C	Z	No	#6-250	5½	9⅞	25	2	1½	1¼

Receptacle Configurations

A	B	C
(1) TT30R, (1) 5-20R GFI	(1) 14-50R, (1) 5-20R GFI	(1) 14-50R, (1) TT30R, (1) 5-20R GFI

Circuit Breaker Configurations

X	Y	Z
(1) 30A, 1P, 120V (1) 20A, 1P, 120V	(1) 50A, 2P, 120/240V (1) 20A, 1P, 120V	(1) 50A, 2P, 120/240V (1) 30A, 1P, 120V (1) 20A, 1P, 120V

NOTE

These units are typically used for submetering applications.

Contact factory for additional configurations not shown here.



Please consult serving utility for their requirements prior to ordering or installing, as specifications and approvals vary by utility, and may require local electrical inspector approval. All installations must be installed by a licensed electrician and must comply with all national and local codes, laws and regulations. Milbank reserves the right to make changes in specifications and features shown without notice or obligation.

Power Outlet Pedestals

Millennium Series | 120/240 VAC

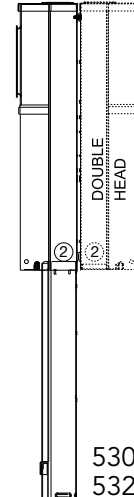
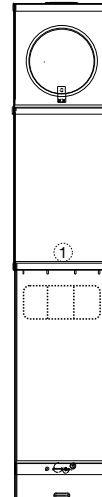
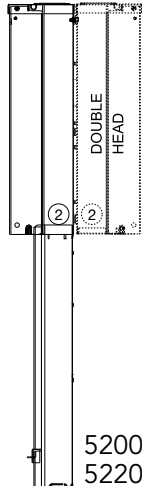
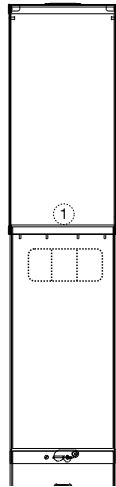

U5200-XL-75

U5300-O-75

125 Amp | Power Outlet Pedestals

Catalog Number	Double Head Catalog Number	Metered/Unmetered	Receptacle Configuration	Circuit Breaker Configuration	Dimensions			Mounting Type
					D"	W"	H"	
U5200-XL	U5220-XL	Unmetered	—	—	5 ⁵ / ₁₆	9 ¹ / ₈	64 ¹ / ₂	Direct Burial
U5200-XL-41	U5220-XL-41	Unmetered	A	X	5 ⁵ / ₁₆	9 ¹ / ₈	64 ¹ / ₂	Direct Burial
U5200-XL-55	U5220-XL-55	Unmetered	B	Y	5 ⁵ / ₁₆	9 ¹ / ₈	64 ¹ / ₂	Direct Burial
U5200-XL-75	U5220-XL-75	Unmetered	C	Z	5 ⁵ / ₁₆	9 ¹ / ₈	64 ¹ / ₂	Direct Burial
U5300-O	U5320-O	Metered	—	—	5 ⁵ / ₁₆	9 ¹ / ₈	70 ¹ / ₄	Direct Burial
U5300-O-41	U5320-O-41	Metered	A	X	5 ⁵ / ₁₆	9 ¹ / ₈	70 ¹ / ₄	Direct Burial
U5300-O-55	U5320-O-55	Metered	B	Y	5 ⁵ / ₁₆	9 ¹ / ₈	70 ¹ / ₄	Direct Burial
U5300-O-75	U5320-O-75	Metered	C	Z	5 ⁵ / ₁₆	9 ¹ / ₈	70 ¹ / ₄	Direct Burial

Notes

- **Receptacle Configurations** - Reference chart on page 79.

NOTE

These units are typically used for submetering applications. Contact factory for additional configurations not shown here. Pad mount is available. Contact factory for information.

Please consult serving utility for their requirements prior to ordering or installing, as specifications and approvals vary by utility, and may require local electrical inspector approval. All installations must be installed by a licensed electrician and must comply with all national and local codes, laws and regulations. Milbank reserves the right to make changes in specifications and features shown without notice or obligation.



Replacement Receptacle Plates

For Millennium Series Products

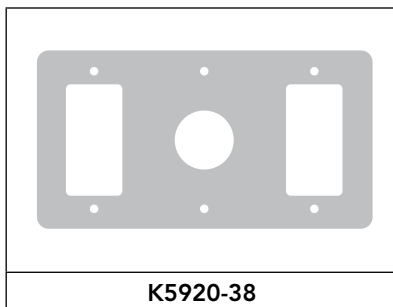
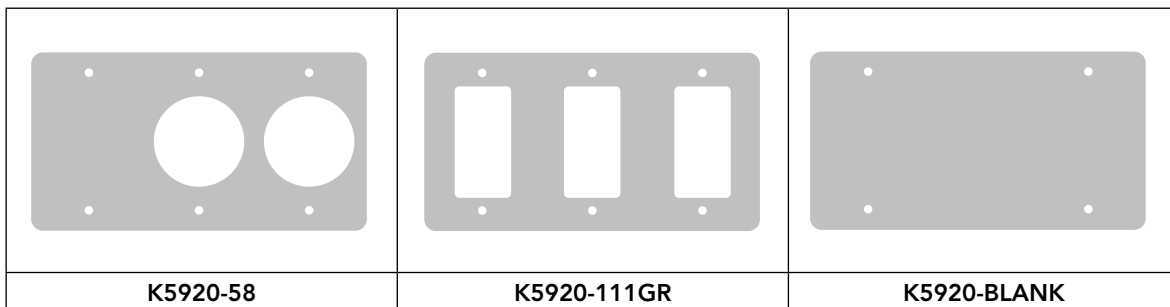
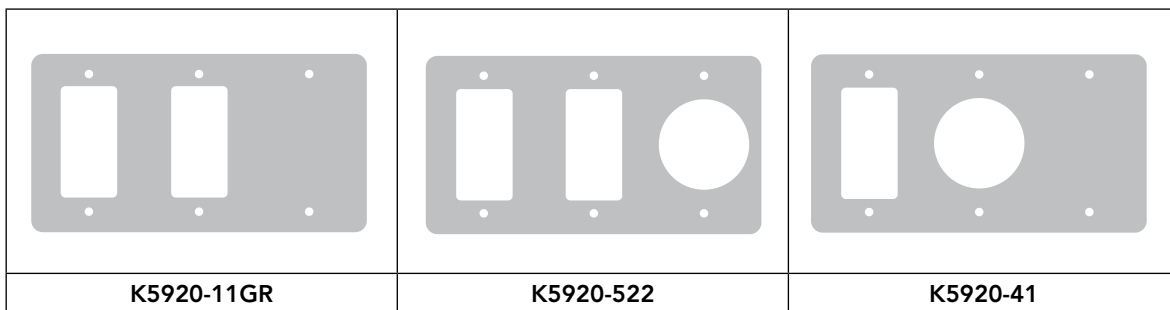
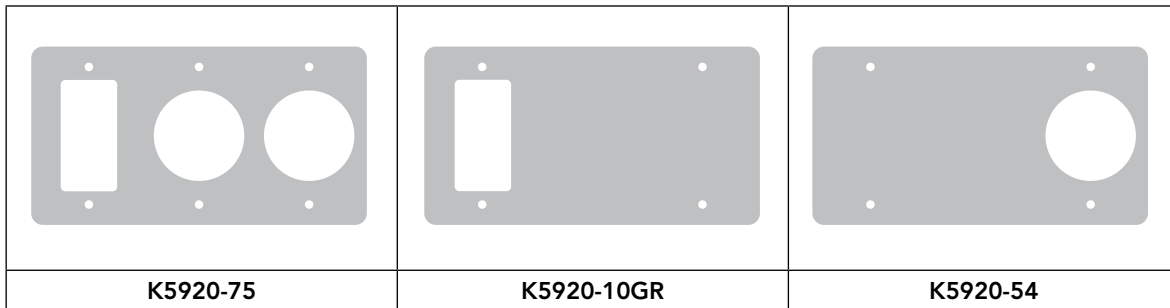

Notes

- For application details, consult factory.



Please consult serving utility for their requirements prior to ordering or installing, as specifications and approvals vary by utility, and may require local electrical inspector approval. All installations must be installed by a licensed electrician and must comply with all national and local codes, laws and regulations. Milbank reserves the right to make changes in specifications and features shown without notice or obligation.

Lighting Accessories

For Millennium Series Products

Internal LED Light Kits for Unmetered Power Outlets (U5000 & U5200)

Application	Internal light kit for unmetered power outlets	
LED Features	Includes new LED light, lamp shield and opaque hinge cover lens. Factory wired to 20 amp GFI circuit. May be wired to separate 20 amp circuit breaker. Order Q120 separately. Cover on unmetered power outlet is 19 1/8" in height.	
Ordering	Order with -LD suffix (after catalog number) for factory installed. Order catalog number K6212 for field installed.	

Internal Fluorescent Light Kits for Unmetered Power Outlets (U5000 & U5200)

Application	Internal light kit for unmetered power outlets	
Fluorescent Features	Includes 5-watt fluorescent lamp socket, ballast, lamp shield and opaque hinge cover lens. Factory wired to 20 amp GFI circuit. May be wired to separate 20 amp circuit breaker. Order Q120 separately. Cover on unmetered power outlet is 19 1/8" in height.	
Ordering	Order with -L suffix (after catalog number) for factory installed. Order catalog number K5411 for field installed.	

Photoelectric Light Control Kit

Application	Photoelectric light control kit for K5411 light kits.	
Features	2.5 amp, 120 volt photo electrical control wired in series with K5411 light kits.	
Ordering	Order with -LPC suffix for factory installed light and PE control. Order catalog number K5413 for field installed.	

WARNING!

Always disconnect power prior to installing these devices.

Please consult serving utility for their requirements prior to ordering or installing, as specifications and approvals vary by utility, and may require local electrical inspector approval. All installations must be installed by a licensed electrician and must comply with all national and local codes, laws and regulations. Milbank reserves the right to make changes in specifications and features shown without notice or obligation.



Internal Light Kits for Metered Power Outlets (U5100 & U5300)

Application	Internal light kit for metered power outlets	
LED Features	Includes new LED light , lamp shield and opaque hinge cover lens. Factory wired to 20 amp GFI circuit. May be wired to separate 20 amp circuit breaker. Order Q120 separately. Cover on metered power outlet is 15¼" in height.	
Ordering	Order with -LD suffix (after catalog number) for factory installed. Order catalog number K6213 for field installed.	

Application	Internal light kit for metered power outlets	
Fluorescent Features	Includes 5-watt fluorescent lamp socket, ballast, lamp shield and opaque hinge cover lens. Factory wired to 20 amp GFI circuit. May be wired to separate 20 amp circuit breaker. Order Q120 separately. Cover on metered power outlet is 15¼" in height.	
Ordering	Order with -L suffix (after catalog number) for factory installed. Order catalog number K5412 for field installed.	

Photoelectric Light Control Kit

Application	Photoelectric light control kit for K5412 light kits.	
Features	2.5 amp, 120 volt photo electrical control wired in series with K5412 light kits.	
Ordering	Order with -LPC suffix for factory installed light and PE control. Order catalog number K5413 for field installed.	

WARNING!

Always disconnect power prior to installing these devices.

Telecom and Pedestal Accessories

For Millennium Series Products

Telephone and Cable TV Kit

Application	Mounts to rear of pedestal series U5200 and U5300 . May also be adaptable to a wooden or similar structure.	 <p>K4709-02-3R K4709-02</p>
Features	Single: 16" galvanized raceway, (1) RJ11 telephone jack and (1) Type F coaxial CATV jack. Dual: 16" galvanized raceway, (2) RJ11 telephone jacks and (1) Type F coaxial CATV jack. Includes mounting hardware and instructions.	
Ordering	Single line telephone and cable TV kit order K4709-02 .	
Note	Confirm acceptability with Cable TV and Telephone provider before ordering or installing these devices.	

Water Shroud with Hardware

Application	Used to cover water pipe and provide means to mount hose bib to rear of pedestal.	
Features	Includes mounting hardware and instructions. Matches K4709 kits when mounted side-by-side.	
Ordering	Order catalog number K4709-WS .	

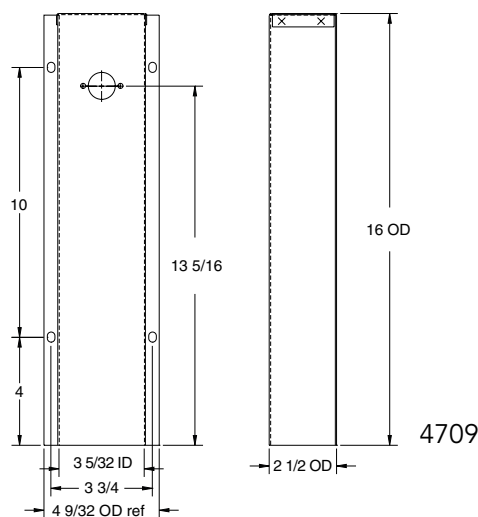

Please consult serving utility for their requirements prior to ordering or installing, as specifications and approvals vary by utility, and may require local electrical inspector approval. All installations must be installed by a licensed electrician and must comply with all national and local codes, laws and regulations. Milbank reserves the right to make changes in specifications and features shown without notice or obligation.



Pedestal Mounting Accessories

For Millennium Series Products

Field-Installed Pad Mount Kit

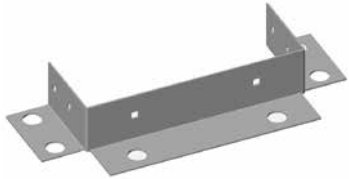
Application	Field installed pad mount kit with (6) ¾" mounting holes.	
Features	Includes ¼-20 stainless steel hardware to attach pad mount base to post. Anchor bolt kit sold separately (order catalog number K5421).	
Ordering	Order catalog number K5410 .	

Stabilizer Foot with Hardware

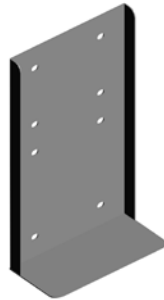
Application	Stabilizes direct burial type posts in unstable soil conditions.	
Features	Includes ¼-20 hardware to attach to U5200 and U5300 pedestals.	
Ordering	Order catalog number K5415 .	

Anchor Bolt Kit

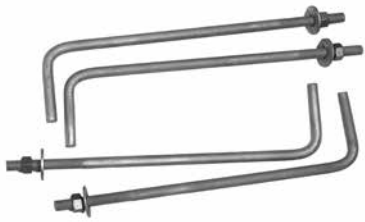
Application	Concrete anchor bolt kit designed to attach pad mount base to concrete.	
Features	(4) sets of zinc-plated ⅝-11 x 10" bolt with 2" toe. Includes nut and flat washer.	
Ordering	Order catalog number K5421 .	

Metering & Receptacle Accessories

For Millennium Series Products

Field-Installed Meter Kits





Application	Field installed meter kit for U5000 and U5200 power outlets.	
Features	100 amp cast meter socket, CL200 E-Z Read Meter, sealing ring, security seal, 1" Milbank hub, nipple and mounting screws. See CL200 for Watt-hour meter specification.	
Ordering	Order catalog number K4800-01 mechanical meter kit , or K4800-D digital meter kit .	

E-Z Read Watt-Hour Meter

Application	200 amp E-Z read watt-hour meter designed to be field installed on the U5100 and U5300 metered power outlets.	
Features	200 amp form 2S 120/240 volt. Numeric readout in full kilowatt increments. No "tenths" dial; digital readout option available. Remanufactured within 1% accuracy.	
Ordering	Order catalog number CL200-D .	

CL200-D
Digital

Single Receptacle Only Power Outlet

Application	Overhead/underground power outlet receptacle, suitable for RV, temporary service, campground, marina and boatyard equipment.			
Features	Type 3R, 120/240 volt single phase. Lockable cover. Breaker not included (in receptacle box).			
Ordering	Order catalog number from chart below.			
Receptacle Options	 P-10GWR 20A 5-20GR 120V GFI	 P-13 30A TT-30R 120V	 P-54 50A 14-50R 120/240V	

WARNING!

Always disconnect power prior to installing these devices.

Please consult serving utility for their requirements prior to ordering or installing, as specifications and approvals vary by utility, and may require local electrical inspector approval. All installations must be installed by a licensed electrician and must comply with all national and local codes, laws and regulations. Milbank reserves the right to make changes in specifications and features shown without notice or obligation.





Replacement Parts & Accessories

For Millennium Series Products



			
Q120 20 Amp, 1 pole circuit breaker	708784-MO 20 Amp, 1 pole GFI circuit breaker	Q130 30 Amp, 1 pole circuit breaker	Q250 50 Amp, 2 pole circuit breaker



Main Breaker Kit Part number	Metered/Unmetered Surface Mount/ Pedestal	Amp
K5400-100MBM	Metered	100
K5400-100MBU	Unmetered	100

		
Z918466-AC Lug landing base	Z917602-AC Circuit breaker base (6-circuit)	Z915141-AC Left or right meter block assembly

Replacement Parts & Accessories

For Millennium Series Products

		
Z918449-AC (19" unmetered) Z918447-AC (15" metered) <i>Hinge cover</i>	Z818052-SC (19" unmetered) Z818480-SC (15" metered) <i>Deadfront</i>	MR-2 <i>Snap action sealing ring</i>

		
Z708080-MO <i>20 Amp GFI receptacle</i> NEMA 5-20GR	Z701776-MO <i>30 Amp receptacle</i> NEMA TT-30	Z708767-MO <i>50 Amp receptacle</i> NEMA 14-50R

Please consult serving utility for their requirements prior to ordering or installing, as specifications and approvals vary by utility, and may require local electrical inspector approval. All installations must be installed by a licensed electrician and must comply with all national and local codes, laws and regulations. Milbank reserves the right to make changes in specifications and features shown without notice or obligation.





Specifications

- 600 to 1200 amp, 120/240 Volt, 1Ø distribution bus accepts up to (6) 2 pole, 200 amp circuit breakers. Order from chart below.
- Costly main breaker not required per NEC 230-71.
- Economical alternative to costly wall hung or strut-mounted panel boards and load centers.
- Low profile, aesthetic design can be located near utility transformers or fed from a main service to a convenient location.
- Pad mounted Type 3R powder coated aluminum enclosure – standard color is gray.
- Hinge door and lift off rear service door are lockable and sealable for security.

NOTE: Consult local code enforcement for pad size requirements. Order catalog number **CP-24-PDMNT-CALT** pad mount base or catalog number **CP-ABK5/8** anchor bolt kit separately.

Circuit Breakers

Catalog Number	Amp	Phase	Volts	Connectors CU/AL		Dimensions		
				Line	Load	D"	W"	H"
CP3B-AUX-1200	1200	1Ø	120/240	(3) 1-600 kcmil/Ø or (3) 2-250 kcmil/Ø	See Circuit Breaker	17	24	41

Circuit Breakers

200 Amp Frame | Plug-In | 10K AIC | Two-Pole | Common Trip



2-Pole Rating	10K AIC Plug-In	Package Quantity	Connectors CU/AL	
			Line	Load
100	UQFP-100	1	#3-#1	#1-1/0
125	UQFP-125	1	#3-#1	#1-1/0
150	UQFP-150	1	1/0-300	2/0-300
175	UQFP-175	1	1/0-300	2/0-300
200	UQFP-200	1	1/0-300	2/0-300
225	UQFP-225	1	1/0-300	2/0-300

Recreational Vehicle

600-1200 Amp | Pad mounted Panel Board



U4540-XL

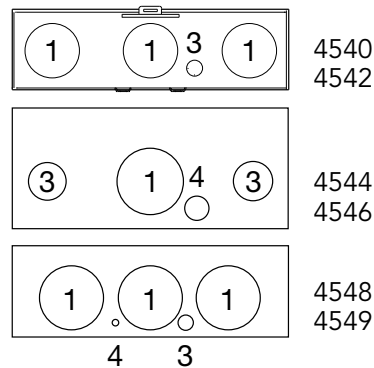
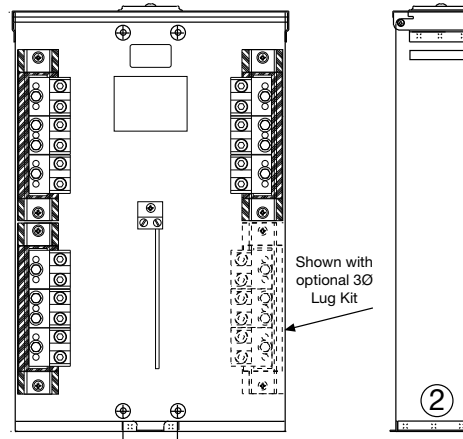

Terminal Boxes | 1Ø & 3Ø | 120/240 Volt

Catalog Number	Amp	Phase	Volts	Hub	1Ø to 3Ø Kit	Connectors CU7AL	Dimensions			Knockouts				
							D"	W"	H"	1	2	3	4	5
U4544-XL	100	1	120/240	C.P.	K4543	(6) #12-1/0	4½	9¼	18	—	2	2	1	¼, ½
U4546-XL	100	3	600	C.P.	N/A	(6) #12-1/0	4½	9¼	18	—	2	2	1	¼, ½
U4540-XL	200	1	120/240	C.P.	K4539	(6) #6-350	4½	14¼	23	—	1¼	2½	2½	¼, ½
U4542-XL	200	3	600	C.P.	N/A	(6) #6-350	4½	14¼	23	—	1¼	2½	2½	¼, ½
U4548-RXL	400	1	120/240	C.P.	K4547	(3) #6-350 or (2) #4-600	5	15½	27	3	3	3	¼, ½	¼
U4549-RXL	400	3	600	C.P.	N/A	(3) #6-350 or (2) #4-600	5	15½	27	3	3	3	¼, ½	¼

Notes

- **Hub:** Standard hub opening on top with closing plate attached.
- **Features:** UL listed pad lockable Type 3R enclosure.
- **3Ø 120/240V application:** Field-installable 3Ø lug kit converts 1Ø unit to 3Ø unit.

Please consult serving utility for their requirements prior to ordering or installing, as specifications and approvals vary by utility, and may require local electrical inspector approval. All installations must be installed by a licensed electrician and must comply with all national and local codes, laws and regulations. Milbank reserves the right to make changes in specifications and features shown without notice or obligation.



Dry Type Transformers

With Distribution for RV & Mobile Home Park Applications



480 Volts to 120/240 Single Phase		
Catalog Number	KVA	Weight
10URMD*	100	1050 lbs.
16URMD*	167½	1400 lbs.
20URMD*	200	1650 lbs.
25URMD	250	1950 lbs.

* UL listed

2400 Volts to 120/240 Single Phase		
Catalog Number	KVA	Weight
10URMD24	100	1050 lbs.
16URMD24	167½	1400 lbs.
20URMD24	200	1650 lbs.
25URMD24	250	1950 lbs.

Voltage	Dimensions		
	A	B	C
480V, A	48"	38"	40"
2400V, A	48"	41"	53"

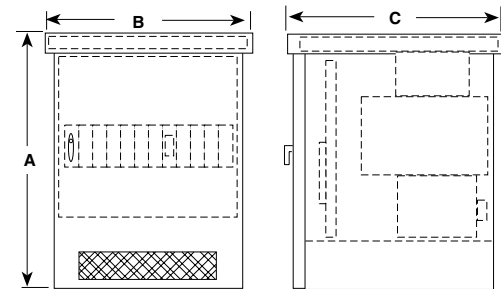
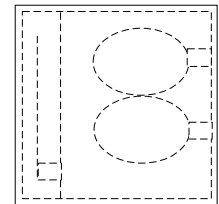

Specifications

- Built in accordance with NEMA, ASA and AIEEE standards. Designed and tested to withstand 150% of rated load for two continuous hours. Consult local utility for acceptance of this product.
- Integrated design of the enclosure, core and coil, and secondary distribution panel permits convenient vertical line and load terminations.
- Primary and/or secondary main circuit breaker protection available. Consult local utility for 480 volt overcurrent protection requirements. Single fuse primary overcurrent protection provided on 2400 volt and above units.
- Other primary voltages available: 4160, 4800, 7200, 7960, & 12,470. Consult factory. Not UL listed.

Core and Coil

- Aluminum wound (Copper available)
- Standard voltage taps @ 2FCAN and 4FCBN
- Rated at 150° C temperature rise

Distribution Bus

- 1600 amp tin plated aluminum
- Space available for up to (12) circuit breakers – 1600 amp maximum
- Uses Milbank type UQFP-100 through 200 amp circuit breakers (See page 117-118)

Enclosure

- Type 3R enclosure
- Powder coated galvanized steel (aluminum available)
- Lockable primary and secondary doors
- Lifting hooks and fork lift slots provided



Please consult serving utility for their requirements prior to ordering or installing, as specifications and approvals vary by utility, and may require local electrical inspector approval. All installations must be installed by a licensed electrician and must comply with all national and local codes, laws and regulations. Milbank reserves the right to make changes in specifications and features shown without notice or obligation.

Commercial Pedestals

Attractive | Easy to Install | Secure | Cost-Effective

Milbank Commercial Pedestals are pad-mounted, weatherproof electrical enclosures consisting of a utility pull section with optional meter socket, and a customer section containing distribution and control equipment. Milbank Commercial Pedestals are an attractive, secure, easy to install and cost-effective solution when underground remote site power distribution and control equipment is required, replacing unsightly and inefficient strut and backboard structures.



Strut and backboard



Commercial pedestal

UL Listed as Industrial Control Equipment (File E113855)

Standard Features

- Type 3R rain resistant, vandal-resistant cabinet of polyurethane powder coated steel (aluminum or stainless steel also available)
- UL listed as enclosed industrial control equipment (UL508)
- Isolated lockable & sealable utility metering and lug landing sections
- Lockable customer section for distribution and control equipment with internal deadfront
- Print pocket inside customer section door contains wiring schematics and installation instructions
- Most load centers are UL listed for use with various manufacturers' circuit breakers
- All stainless steel external hardware (screws, bolts, hinges, handles, hasps and sealing screws)

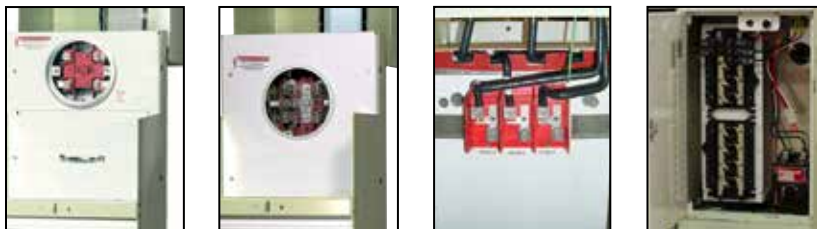

Please consult serving utility for their requirements prior to ordering or installing, as specifications and approvals vary by utility, and may require local electrical inspector approval. All installations must be installed by a licensed electrician and must comply with all national and local codes, laws and regulations. Milbank reserves the right to make changes in specifications and features shown without notice or obligation.





Applications

These units are ideal for controlling and metering:

- Traffic signals
- Street lighting
- Power distribution for EV charging stations
- Irrigation and sprinkler systems
- Cell towers and telephone vaults
- Pump stations
- Temporary power for fairgrounds, swap meets, outdoor markets, portable offices, holiday lights, etc.
- Outdoor lighting for athletic fields, tennis and basketball courts, parking lots, landscaping and subdivision entrances, etc.

Available Factory-Installed Options

- Meter sockets: ring type or ringless, up to 400 amp
- Main and branch breakers or T fuses
- Distribution: copper load centers and panel boards
- Clocks, timers and relays
- Photoelectric cells and controls
- Power receptacles: pin and sleeve, twist lock or straight blade
- Contactors: definite purpose, electrical or mechanically held, IEC and mercury types
- Surge protection and lightning arrestors
- Reserve inlet generator receptacle with interlocked circuit breakers
- Motor starters and relays
- Push button controls
- Thermostat controls, fans and heating strips
- Power blocks and terminal blocks
- Steel, aluminum and plywood backboards
- Transformers
- Interlock devices for circuit breakers
- Available in steel, aluminum (raw painted or anodized) or stainless steel construction with powder coated finish available in eight standard colors or special-ordered RAL colors
- Available for applications up to 400 amp, 120V, 208V, 240V, 277V, 480V - 1Ø or 3Ø

Accessories



K3865
Fifth terminal kit for use with ringless meter sockets

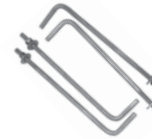

CP-ABK5/8
Anchor bolt kit (includes four 5/8 - 13 x 18" anchor bolts)



105J
Fifth terminal kit for use with ring-type meter sockets



CP-TC7D
7-day time clock kit
CP-TC24H
24-hour time clock kit
CP-TCWIRE
Male 4-pin connector and wiring harness for use with time clocks other than above

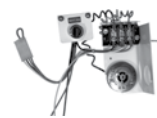

CP-PE-HOA-3POS
HOA switch for field installation



CP-16PDMNT-CALT
16" pedestal mounting base
CP-24PDMNT-CALT
24" pedestal mounting base (includes mounting hardware)



Please consult serving utility for their requirements prior to ordering or installing, as specifications and approvals vary by utility, and may require local electrical inspector approval. All installations must be installed by a licensed electrician and must comply with all national and local codes, laws and regulations. Milbank reserves the right to make changes in specifications and features shown without notice or obligation.

Commercial Pedestals

Main Load Center Series | Custom Designs Available

CP3B "ML" Series

Main Load Center Series

1Ø3 wire 120/240V or 208Y/120V

Application: remote site service for multiple loads

Milbank Main Load Center Commercial Pedestals are designed to handle the vast majority of all requirements in a standard, stocked configuration.

- All units feature a load center with a plug-on, back-fed main breaker.
- Load center has 16 positions for the 100 amp pedestals and 24 circuits for the 200 amp pedestals.
- Both sizes include sub-feed lugs to allow feeding an external panel.

If your application requires turning loads on based on "dusk-to-dawn" requirements, be sure to see the Milbank Switched Load Center Commercial Pedestal products on the following page.

Features

These units include everything required for remote site service:

- NEMA 3R construction.
- Expandable: load centers allow for future expansion without costly modifications.
- All units feature 200 amp meter socket with optional field-installable fifth terminal kit available.
- 22K amp interrupting capacity (AIC) standard.
- Optional mounting base can be embedded in concrete for fast, easy installation.
- Separate sealable and lockable utility termination section.
- Separate sealable and lockable metering section.
- Separate sealable and lockable customer section with a load center for "always on" loads that include a main circuit breaker, 20 (125 or 200 amp model) or 14 (100 amp model) blank breaker spaces and a circuit directory to document configuration.

Note
All meter form and bypass options available to meet utility requirements.



Typical Applications
Remote site service for multiple loads.

Standard Pedestals	Optional Fifth Terminal Kit	Main CB		Load Center Circuits	Meter Socket Type
		Amp	Spaces		
CP3B11115A22	105J	100	1,2	16	Ring type with test/bypass blocks
CP3B12119A22	105J	200	1,2,3 4	24	Ring type with test/bypass blocks
CP3B51115A22	K3865	100	1,2	16	Ringless socket with lever bypass
CP3B52119A22	K3865	200	1,2,3,4	24	Ringless socket with lever bypass

Notes

- Chart shows standard, stocked items. Other options and features are available. Contact factory for options, details and availability.

Please consult serving utility for their requirements prior to ordering or installing, as specifications and approvals vary by utility, and may require local electrical inspector approval. All installations must be installed by a licensed electrician and must comply with all national and local codes, laws and regulations. Milbank reserves the right to make changes in specifications and features shown without notice or obligation.



CP3B "SL" Series

Switched Load Center Series
1Ø3 wire 120/240V or 208Y/120V

Milbank Switched Load Center Commercial Pedestals are designed not only to provide power for various loads, but also to switch specific loads on and off under certain conditions. A photoelectric cell is used for these controlled loads, and an optional time clock is also available.

Features

These units include everything required for remote site service:

- NEMA 3R construction.
- Expandable: load centers allow for future expansion without costly modifications.
- All units feature 200 amp meter socket with optional field-installable fifth terminal kit available.
- 22K amp interrupting capacity (AIC) standard.
- Optional mounting base can be embedded in concrete for fast, easy installation.
- Separate sealable and lockable utility termination section.
- Separate sealable and lockable metering section.
- Separate sealable and lockable customer section with a control circuit including PE receptacle, Lexan® window, glare shield, Hand-Off-Auto (HOA) switch, contractor controlling a 16-circuit load center for controlled loads, a pre-mounted DIN rail and pre-wired connector to add an optional "plug-and-play" time clock kit for PE on and TC off operation and a circuit directory to document configuration.
- A load center for "always on" loads that includes a main circuit breaker, a control power circuit breaker, a switched load center main breaker, nine (125 or 200 amp model) or 11 (100 amp model) blank breaker spaces and a circuit directory to document configuration.

Note
All meter form and bypass options available to meet utility requirements.



Typical Applications
Traffic signals, parking lots, highways & athletic field lighting

Standard Pedestals	Optional Fifth Terminal Kit	Main CB		Contactor amperage	Meter Socket Type
		Amp	Spaces		
CP3B11110A22SL1	105J	100	1,3	60	Ring type with test/bypass blocks
CP3B12110A22SL1	150J	200	1,2,3,4	100	Ring type with test/bypass blocks
CP3B51110A22SL1	K3865	100	1,3	60	Ringless socket with lever bypass
CP3B52110A22SL1	K3865	200	1,2,3,4	100	Ringless socket with lever bypass

Notes

- Chart shows standard, stocked items. Other options and features are available. Contact factory for options, details and availability.



Please consult serving utility for their requirements prior to ordering or installing, as specifications and approvals vary by utility, and may require local electrical inspector approval. All installations must be installed by a licensed electrician and must comply with all national and local codes, laws and regulations. Milbank reserves the right to make changes in specifications and features shown without notice or obligation.

Commercial Pedestals

400 Amp Series



Milbank 400 Amp Commercial Pedestals are designed to provide a weather and vandal resistant metered enclosure for various loads and distribution. Each pedestal has been designed to handle a wide range of applications using standard, stocked configurations.

- Choice of a single main breaker or twin service disconnect breakers gives flexibility to the pedestal design.
- Optional distribution with feed-through lugs below the service disconnect breakers allows the pedestal to handle numerous applications.
- Typical applications include remote homes where the metering is best located at the curb side or other remote area. The pedestal can also provide power to secondary residence, on-site business, workshop, irrigation, lighting, security or other secondary load.
- Available in custom colors to match home or landscaping.

Features

These units include everything required for remote service:

- Type 3R construction
- Main circuit breaker or dual service disconnects
- Expandable: load center units allow for future expansion without costly modifications
- Optional mounting base can be embedded in concrete for fast, easy installation
- Separate sealable and lockable utility termination section with lug termination
- Separate sealable and lockable metering section
- A separate sealable and lockable customer section with a circuit directory and a print pocket to hold all documentation
- Meter socket options include ring type with bypass studs, ringless with heavy duty lever bypass, or K-Type bolt-on

Typical Applications

Remote site service for residential and commercial job sites.

Standard Pedestals	Optional fifth Terminal Kit	Main CB	Load Center Circuits	Meter Socket Type
CP3B1411JB	N/A	320 Amp (400 max)	0	Ring-type with test/bypass studs
CP3B14120B	N/A	2-200 Amp	(2) 12 circuit ¹	Ring-type with test/bypass studs
CP3B54120B22	K3865	2-200 Amp	(2) 12 circuit ¹	Ringless with lever bypass
CP3B5411JB22	K3865	320 Amp (400 max)	0	Ringless with lever bypass

Notes

- Chart shows standard, stocked items. Other options and features are available. Contact factory for options, details and availability.
- Stud utility landing is standard. Lug kits are available from factory.
- Units with load centers have (2) #6-250 sub-feed lugs on each load center. (Each load center is 200 amp rated and UL listed with: Siemens, General Electric and Cutler-Hammer plug-in style circuit breakers.)

Please consult serving utility for their requirements prior to ordering or installing, as specifications and approvals vary by utility, and may require local electrical inspector approval. All installations must be installed by a licensed electrician and must comply with all national and local codes, laws and regulations. Milbank reserves the right to make changes in specifications and features shown without notice or obligation.



Commercial Pedestals

CP3B "IR" Irrigation Control Series



Milbank "IR" Series Irrigation Pedestals install quickly and simply—often in less than an hour with a single technician—a fraction of the time typically needed for strut farm and other installation set ups. Additionally, the pedestal comes pre-wired, so the technician simply drops in the pre-drilled concrete box pad, fastens the pedestal and runs the wires. Prewired landing lugs are provided in a separate utility side so that there is no more need to wrestle with hard-to-bend wires. Simply run the utility wire up and land on the lugs. With both the motor starter and disconnect in the same enclosure, all the controls are housed in a safe, lockable pedestal that protects against vandalism and energy theft.

Features

- 3Ø4W, 480Y/277 volt
- One technician can install in under an hour with use of Milbank's pre-drilled box pad
- All units are UL listed and service entrance rated
- Fused disconnect with accessible handle through the deadfront
- HOA and push button start
- Separate accessible utility side with pre-wired landing lugs
- NEMA rated starters (sizes 1-5)
- Soft start units sizes 30HP-150HP
- 30 amp fuse block for pivot pre-wired in the unit
- White powder coated paint finish helps keep components cooler
 - Options include:
 - Hour meter
 - Chemical injection receptacle
 - Multiple injection receptacle
 - Multiple 30 amp fuse blocks possible

Typical Applications

Power pedestal for irrigation systems or other pump control applications.

Standard Pedestals	Exterior Cabinet	NEMA Rating
CP3B0281UMWIR04	White	4
CP3B0281UMWIR03	White	3
CP3B0181UMWIR02	White	2

Notes

- Chart shows standard, stocked items. Other options and features are available. Contact factory for options, details and availability.



Please consult serving utility for their requirements prior to ordering or installing, as specifications and approvals vary by utility, and may require local electrical inspector approval. All installations must be installed by a licensed electrician and must comply with all national and local codes, laws and regulations. Milbank reserves the right to make changes in specifications and features shown without notice or obligation.

Commercial Pedestals

CP3B "BBS" Battery Backup Series



Milbank BBS Series Commercial Pedestals are designed to provide battery backup power for various loads, and to switch specific loads on and off under certain conditions; a photoelectric cell or time clock to control lighting circuits, as an example. Metered and unmetered power distribution options are available. The back-up power pedestal is designed to handle the vast majority of today's back-up power requirements. By using 19" rack design, shelves can be adjusted to accommodate the required batteries and manufactures DC to AC inverters, transfer switches and other related equipment. This design gives the user a wide range of design and configuration options. Complete turnkey, ready to power-up pedestals are offered along with basic units ready to accept batteries and inverters supplied by others.

Features

- Type 3R construction
- 100 through 320 amp meter socket with the option of either a ring type socket (conforms to EUSERC 308) with or without test/bypass blocks or a heavy duty ringless socket with lever bypass
- Separate sealable utility termination compartment
- An isolated separate customer section with service disconnects, power distribution options and power control
- 19" wide rack in customer compartment for easy layout of equipment
- Battery trays
- Thermostat with cooling fan
- Filtered louvers for heat rise flow through ventilation
- Three point door latch (key or pad lockable)

Typical Applications

Metered emergency uninterrupted power for traffic intersections, wireless, phone and communications equipment, parking lots, camera and security locations

Options

- Manual bypass switch
- Transfer switch for generator power back-up
- Generator inlet receptacles 30 through 200 amp
- Pad lockable provision for receptacles
- Police access door
- Metered load center distribution
- Unmetered load center distribution
- Photo electric controls (for street lighting)
- Time clocks
- HOA switches
- Contactors
- GFI duplex receptacles
- Thermostat for heating control
- Heating pads or elements
- Roll out shelves for batteries
- Surge arrestors and lighting arrestors

Please consult serving utility for their requirements prior to ordering or installing, as specifications and approvals vary by utility, and may require local electrical inspector approval. All installations must be installed by a licensed electrician and must comply with all national and local codes, laws and regulations. Milbank reserves the right to make changes in specifications and features shown without notice or obligation.



Commercial Pedestals

CP3B "Power Transfer" Series



Milbank Power Transfer Series Pedestals provide unmetered AC power, distribution, surge suppression, mechanical interlock and stand-by generator receptacle—all in a neat, compact pedestal.

Features

- 120/240V 1Ø3W through 277/480V 3Ø4W ratings
- Metered or unmetered units
- Choice of EUSERC ring type or ringless meter sockets
- 60 amp through 400 amp ratings
- UL listed Type 3R rated
- Pad lockable, isolated utility compartments
- 20 amp GFI convenience receptacle
- Lockable recessed generator receptacle door
- Utility and generator indicator light options
- All stainless steel hardware
- Galvanized steel, aluminum or stainless steel cabinet options
- Custom designs available



Typical Applications

Traffic intersections, cell sites, cable TV, pump and lift stations requiring utility power with backup generator power

Typical Applications

Traffic intersections, cell sites, cable TV, pump and lift stations requiring utility power with backup generator power



Please consult serving utility for their requirements prior to ordering or installing, as specifications and approvals vary by utility, and may require local electrical inspector approval. All installations must be installed by a licensed electrician and must comply with all national and local codes, laws and regulations. Milbank reserves the right to make changes in specifications and features shown without notice or obligation.

Commercial Pedestals

CP3BB "CT Metered" Series

101
COMMERCIAL
PEDESTALS



Milbank CT Metered Series Commercial Pedestals are designed to be used where a smaller service package would be a better choice over large 3R rated combination switchboards. These pedestals have amperage ratings of 400 to 800 amp at voltages up through 480 volt three phase.

Features

- UL listed, freestanding Type 3R service
- A low profile CT pedestal
- All utility equipment is isolated in separated pad lockable and sealable compartments
- Separate customer compartment designed to hold distribution and control equipment
- Dead front customer construction
- Optional mounting base
- Optional construction in steel, aluminum and stainless steel.
- Wide choice of powder paint colors

Typical Applications

Large homes, pumping & lift stations, motor control, water treatment plants, EV charging stations, commercial buildings, large remote service requirements, commercial and industrial control systems

Please consult serving utility for their requirements prior to ordering or installing, as specifications and approvals vary by utility, and may require local electrical inspector approval. All installations must be installed by a licensed electrician and must comply with all national and local codes, laws and regulations. Milbank reserves the right to make changes in specifications and features shown without notice or obligation.





Milbank Slimline Series Commercial Pedestals provide a sleeker, smaller footprint, with wireway access on the side of the unit rather than the back, allowing maximum flexibility to place the pedestal in tighter spaces.

Features

- UL listed as service equipment
- 100 or 200 amp
- Vandal-resistant, secure and attractive design
- Customer compartment with distribution and control equipment with swing dead front door, secured with both a hasp/latch and draw latch outer door
- Utility metering compartment protected with a hinged hood, increasing resistance to meter vandalism
- Small footprint
- Wireway located on left side of pedestal for utility incoming wire, allowing pedestal to be mounted with back very close to a wall (14")
- Available in 12" and 20" widths and 50" and 63" (metered) and 43" (unmetered) heights
- Includes a print pocket for plans and drawings
- 200 amp main available
- Voltage range: 120V–480V
- Compatible with both ringless and ring type meter sockets, 4–7 terminals
- Available in a wide array of colors, including but not limited too all ANSI powder coated paint colors upon request
- Pedestal mounting base option saves time and labor to install on a cement pad—no anchor bolts required
- Powder coated G90 galvanized steel, raw, anodized or powder coated aluminum and stainless steel exterior options

Typical Applications

Roadway lighting and signage, wastewater treatment facilities, parks and landscaping, and any application where physical space is at a premium



"Slimline" Series Direct Bury Extension

- No need for concrete
- Bolts directly to unit
- Easy, modular design
- Ships in a smaller package
- Increases project flexibility
- Easier to handle and install
- Utilizes stabilizer feet to prevent leaning over time
- Pedestal and extension can be installed within 45 minutes

Notes

- 14 gauge steel
- Only available for 12" pedestals



Please consult serving utility for their requirements prior to ordering or installing, as specifications and approvals vary by utility, and may require local electrical inspector approval. All installations must be installed by a licensed electrician and must comply with all national and local codes, laws and regulations. Milbank reserves the right to make changes in specifications and features shown without notice or obligation.

Commercial Pedestals

Accessories

			
<p>CP-ABK5/8 Anchor bolt kit (includes four 5/8-13" x 18" anchor bolts)</p>	<p>K3865 Fifth terminal kit for use with ringless lever bypass meter sockets</p>	<p>CP-TC7D 7-day time clock kit CP-TC24H 24-hour time clock kit CP-TCWIRE Male 4-pin connector and wiring harness for use with time clocks other than shown</p>	<p>105J Fifth terminal kit for use with ring type meter sockets</p>
			
<p>CP-16PDMNT-CALT Pedestal mounting base for 16" pedestal CP-24PDMNT-CALT Pedestal mounting base for 24" pedestal (includes mounting hardware) CP-32PDMNT Pedestal mounting base for 32" pedestal (includes mounting hardware)</p>	<p>CP-PE-HOA-3POS HOA (Hand-Off-Auto) switch for field installation</p>	<p>CP-PE-TYP5-2POS Two position PE control kit</p>	

Please consult serving utility for their requirements prior to ordering or installing, as specifications and approvals vary by utility, and may require local electrical inspector approval. All installations must be installed by a licensed electrician and must comply with all national and local codes, laws and regulations. Milbank reserves the right to make changes in specifications and features shown without notice or obligation.



Commercial Pedestals

16" Metered & Unmetered Drawings

"A" Style 16" Metered Commercial Pedestal

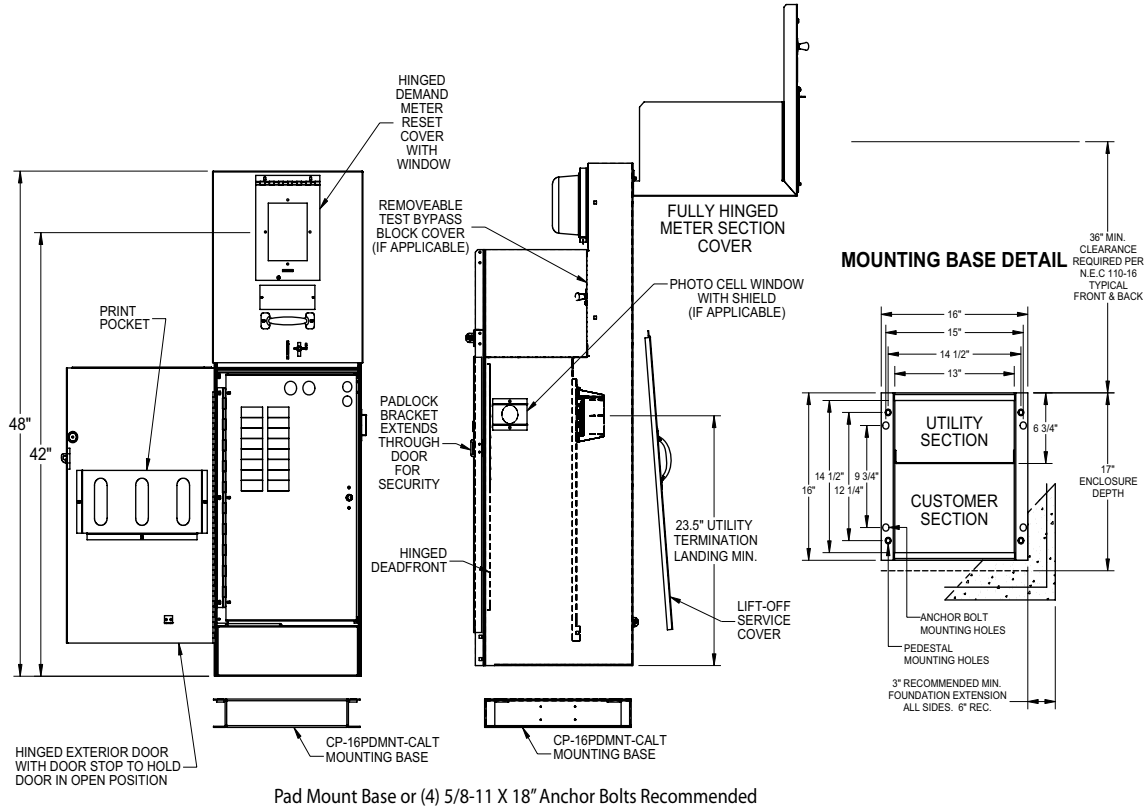

"E" Style 16" Unmetered Commercial Pedestal | Low Profile

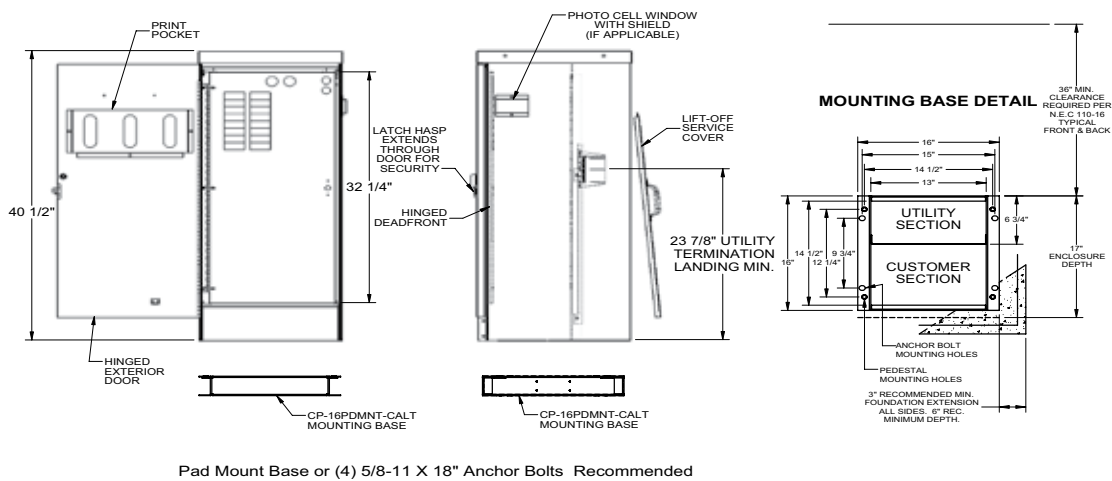

Please consult serving utility for their requirements prior to ordering or installing, as specifications and approvals vary by utility, and may require local electrical inspector approval. All installations must be installed by a licensed electrician and must comply with all national and local codes, laws and regulations. Milbank reserves the right to make changes in specifications and features shown without notice or obligation.

Commercial Pedestals

24" Metered & Unmetered Drawings

"B" Style 24" Metered Commercial Pedestal (with one or two meters)

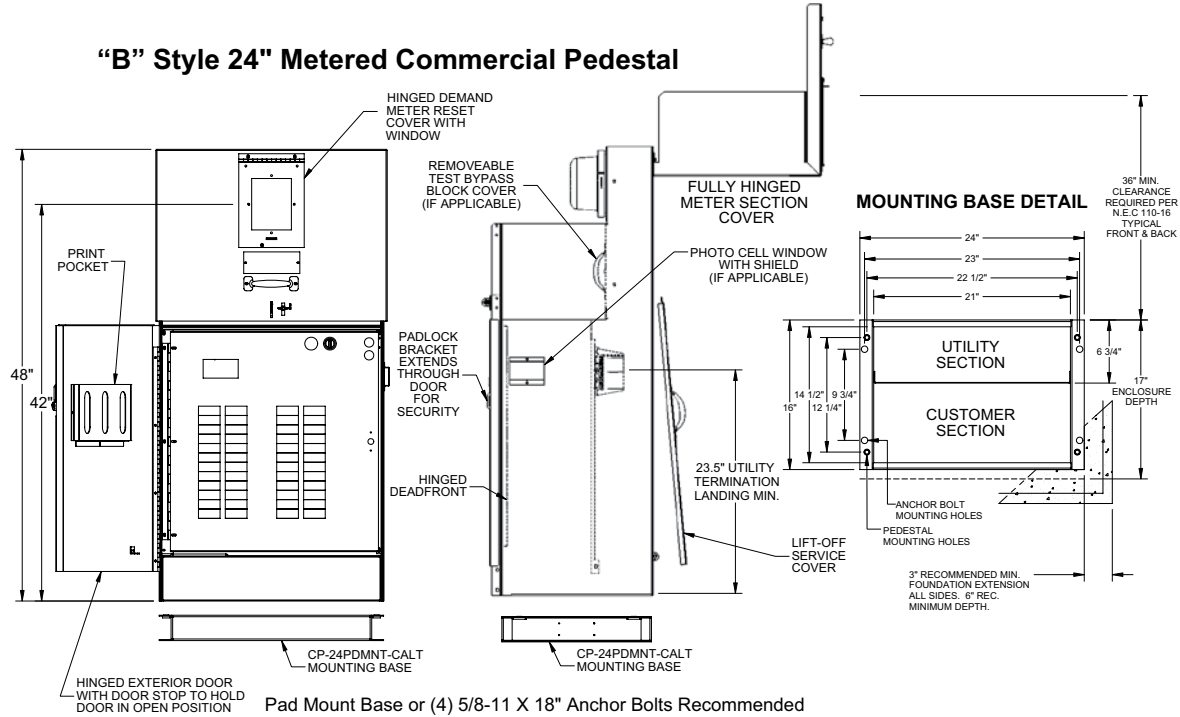

"M" Style 24" Unmetered Commercial Pedestal

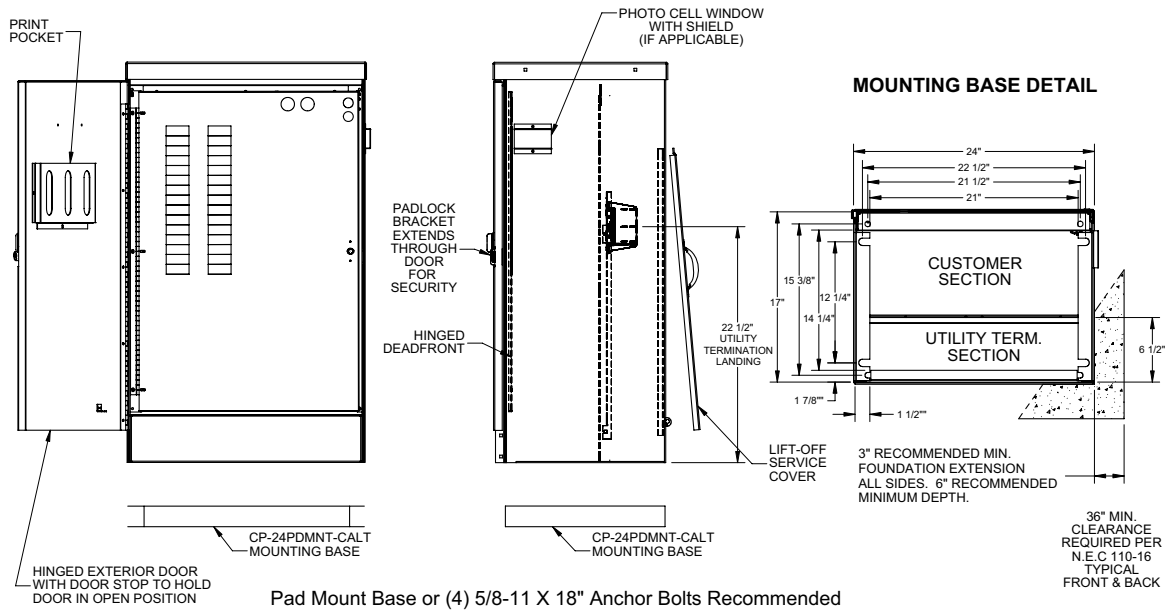

Please consult serving utility for their requirements prior to ordering or installing, as specifications and approvals vary by utility, and may require local electrical inspector approval. All installations must be installed by a licensed electrician and must comply with all national and local codes, laws and regulations. Milbank reserves the right to make changes in specifications and features shown without notice or obligation.



"K" Style 32" Metered Commercial Pedestal (with one or two meters)

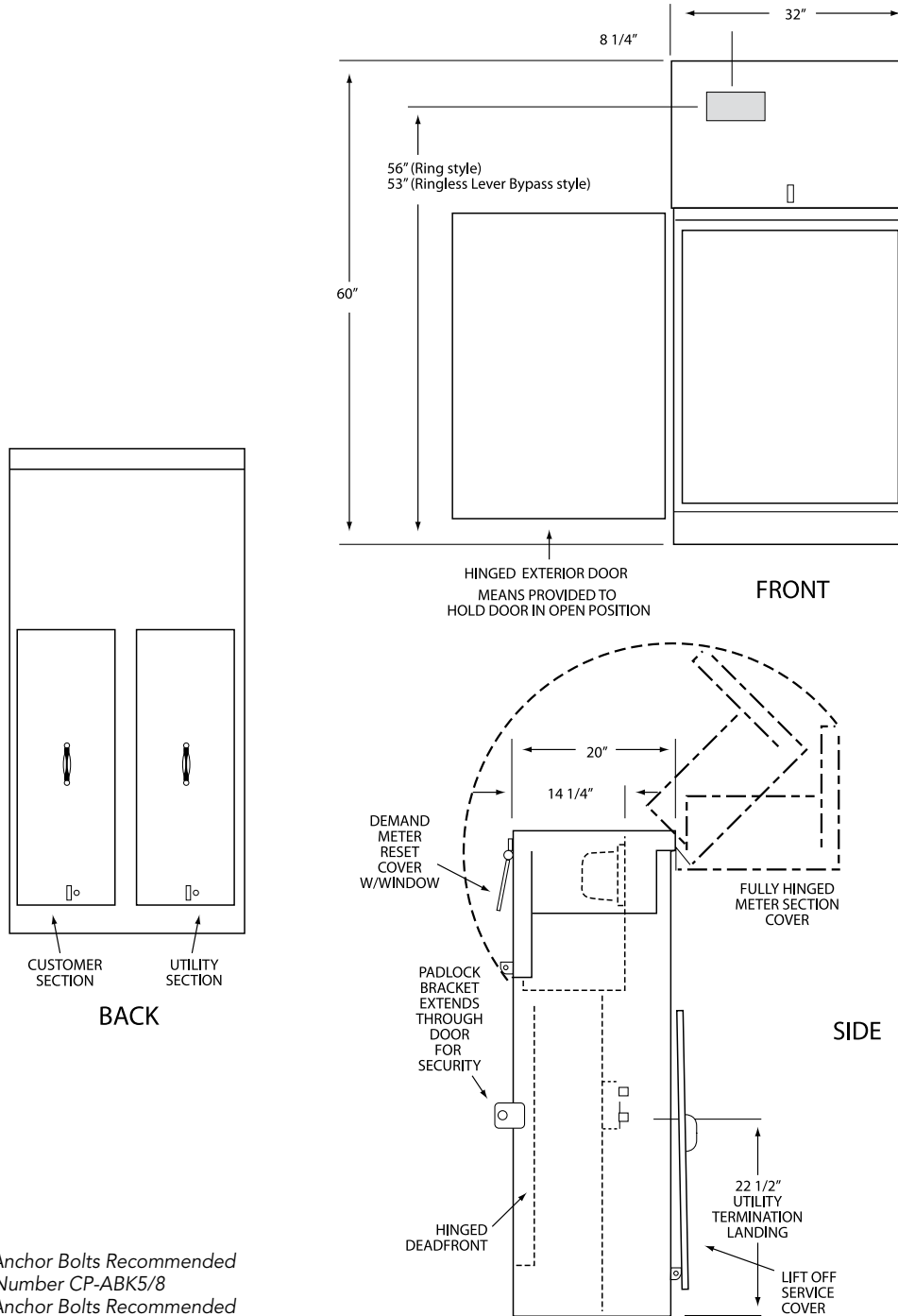

(4) 5/8-11 X 18" Anchor Bolts Recommended
Catalog Number CP-ABK5/8
(4) 5/8-11 X 18" Anchor Bolts Recommended



Please consult serving utility for their requirements prior to ordering or installing, as specifications and approvals vary by utility, and may require local electrical inspector approval. All installations must be installed by a licensed electrician and must comply with all national and local codes, laws and regulations. Milbank reserves the right to make changes in specifications and features shown without notice or obligation.

Commercial Pedestals

32" Unmetered Drawings

107
COMMERCIAL
PEDESTALS

"Q" Style 32" Unmetered Commercial Pedestal

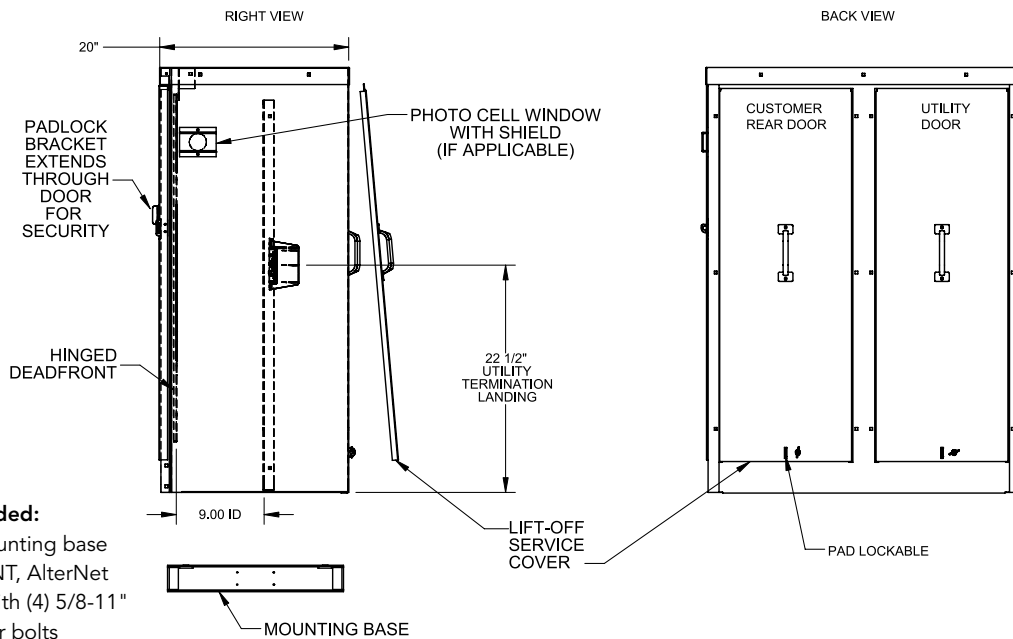
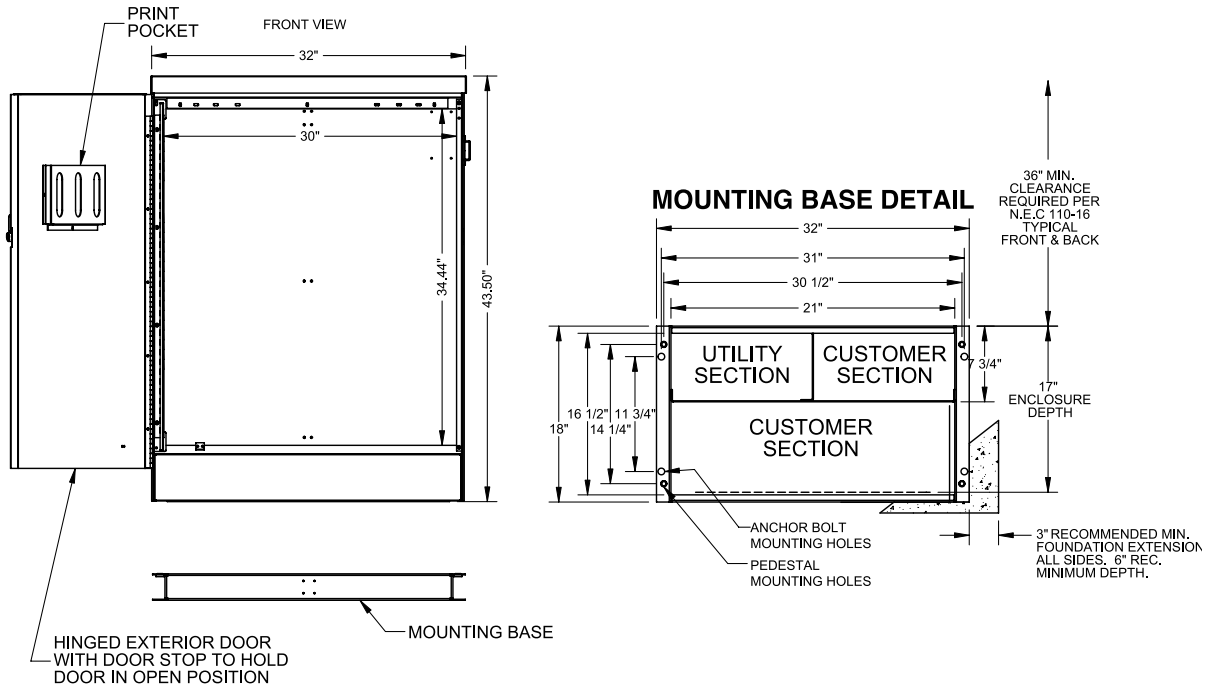

Recommended:
Milbank mounting base
CP-32PDMNT, AlterNet
mounting with (4) 5/8-11"
x 18" anchor bolts

Please consult serving utility for their requirements prior to ordering or installing, as specifications and approvals vary by utility, and may require local electrical inspector approval. All installations must be installed by a licensed electrician and must comply with all national and local codes, laws and regulations. Milbank reserves the right to make changes in specifications and features shown without notice or obligation.



"D" Style Metered Commercial Pedestal

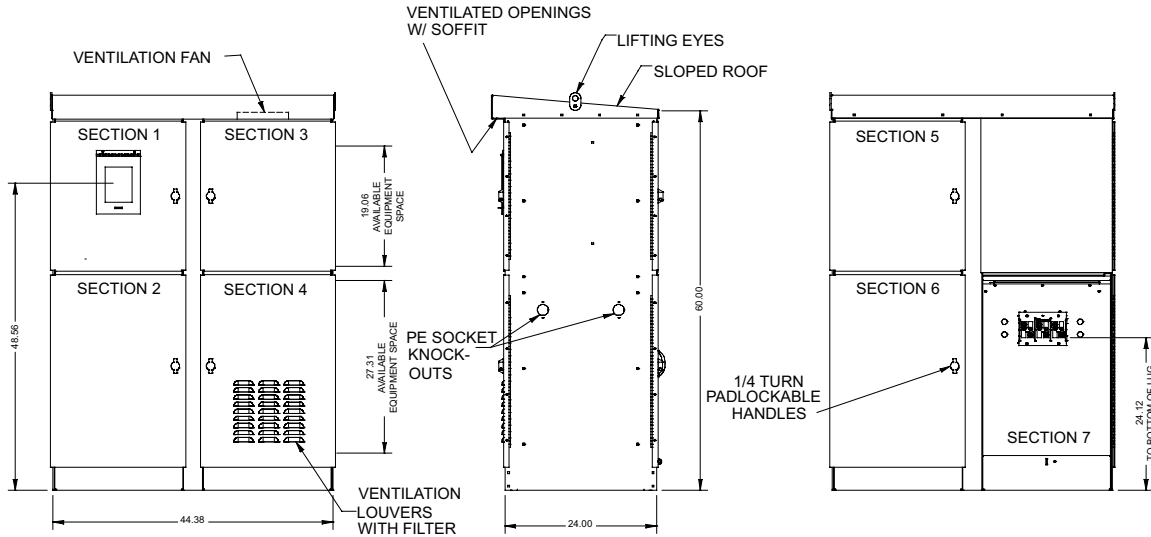

"C" Style 54" Metered Commercial Pedestal

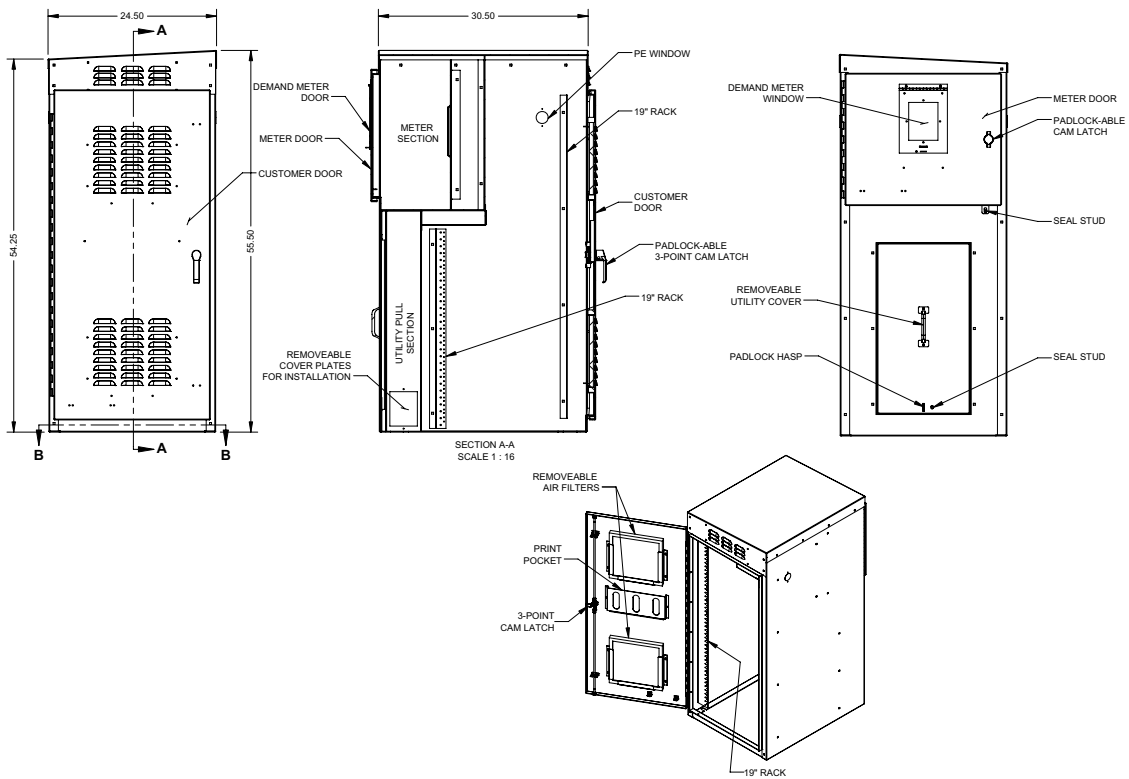

Please consult serving utility for their requirements prior to ordering or installing, as specifications and approvals vary by utility, and may require local electrical inspector approval. All installations must be installed by a licensed electrician and must comply with all national and local codes, laws and regulations. Milbank reserves the right to make changes in specifications and features shown without notice or obligation.

Commercial Pedestals

Slimline "A" Style Drawing

109
COMMERCIAL
PEDESTALS

"A" Style Slimline Metered Commercial Pedestal

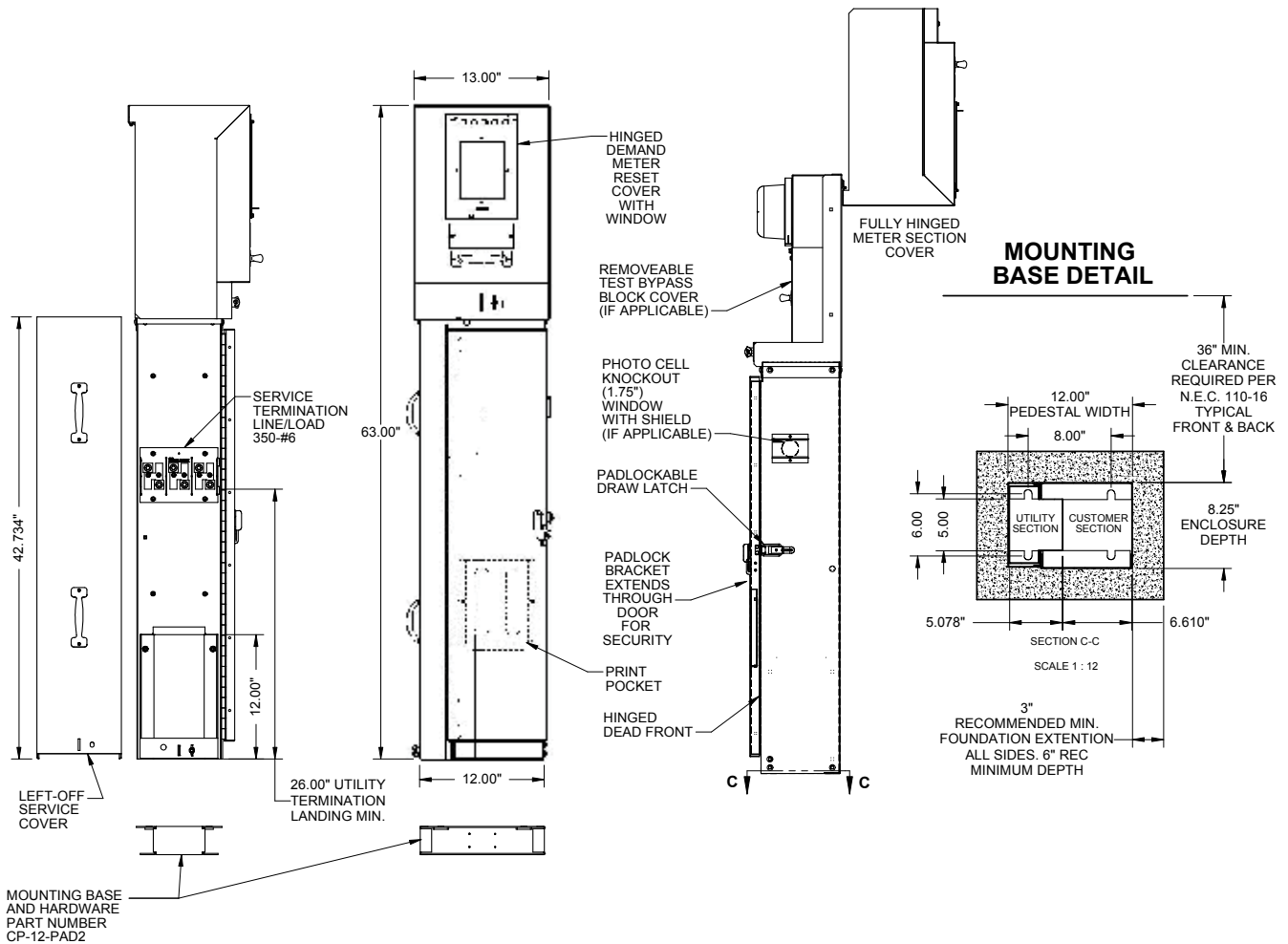

Please consult serving utility for their requirements prior to ordering or installing, as specifications and approvals vary by utility, and may require local electrical inspector approval. All installations must be installed by a licensed electrician and must comply with all national and local codes, laws and regulations. Milbank reserves the right to make changes in specifications and features shown without notice or obligation.



"B" Style Slimline Metered Commercial Pedestal

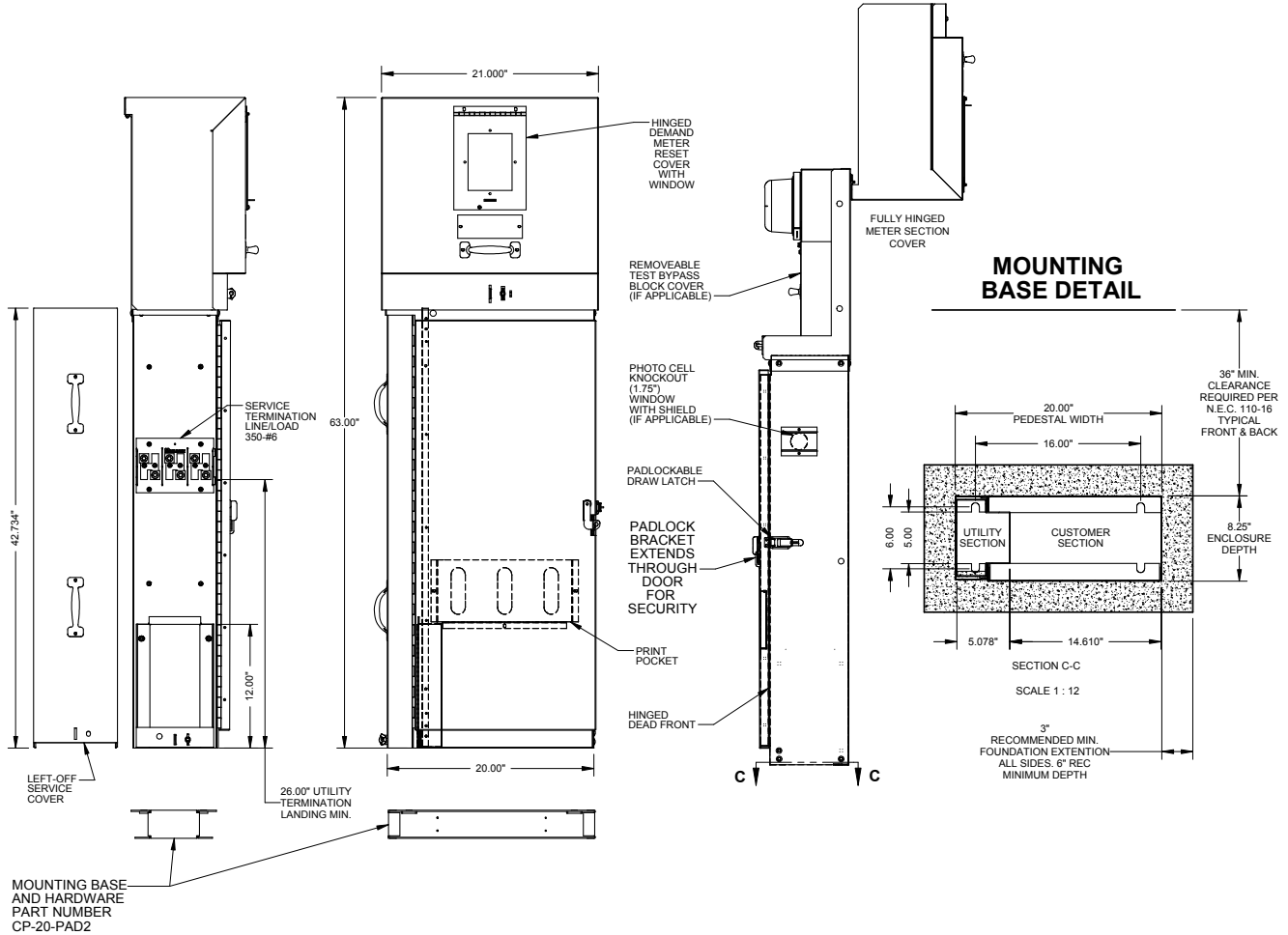

Please consult serving utility for their requirements prior to ordering or installing, as specifications and approvals vary by utility, and may require local electrical inspector approval. All installations must be installed by a licensed electrician and must comply with all national and local codes, laws and regulations. Milbank reserves the right to make changes in specifications and features shown without notice or obligation.

Commercial Pedestals

Slimline "I" Style Drawing

111
COMMERCIAL
PEDESTALS

"I" Style Slimline Metered Commercial Pedestal

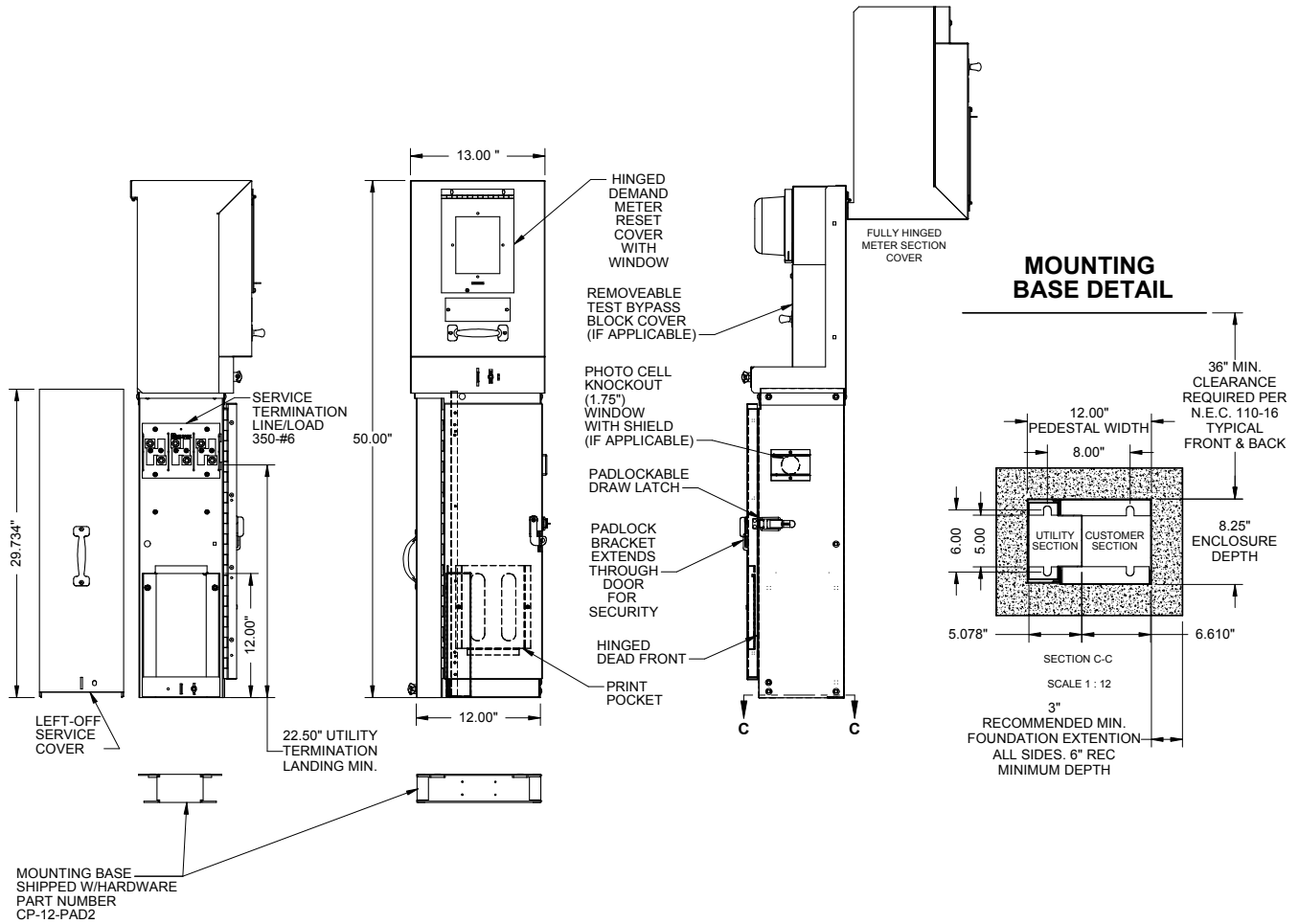

Please consult serving utility for their requirements prior to ordering or installing, as specifications and approvals vary by utility, and may require local electrical inspector approval. All installations must be installed by a licensed electrician and must comply with all national and local codes, laws and regulations. Milbank reserves the right to make changes in specifications and features shown without notice or obligation.



"J" Style Slimline Metered Commercial Pedestal

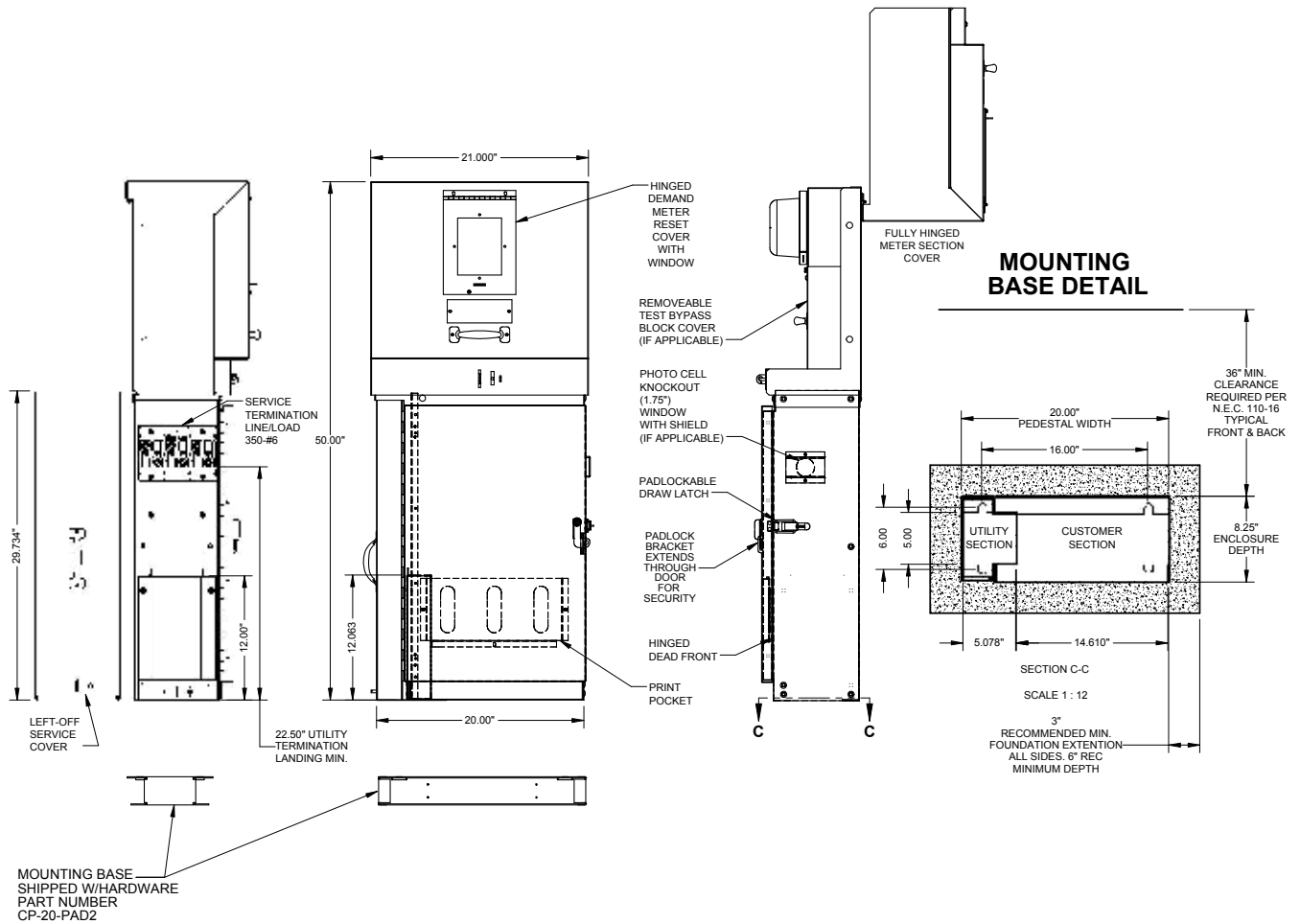

Please consult serving utility for their requirements prior to ordering or installing, as specifications and approvals vary by utility, and may require local electrical inspector approval. All installations must be installed by a licensed electrician and must comply with all national and local codes, laws and regulations. Milbank reserves the right to make changes in specifications and features shown without notice or obligation.

Commercial Pedestals

Product Worksheet

1 1 3

COMMERCIAL
PEDESTALS
PRODUCT
WORKSHEET

Please answer all of the questions listed below. Any additional information regarding application and/or future requirements will enable Milbank to configure the best product for your project.

Distributor: _____ Phone: _____ Fax: _____

Contact Name: _____ Application: _____

Milbank Representative: _____ Salesmen: _____

Project Name & Location: _____

Agency Specifications: (DOT-City-Other) _____

Unit amperage: _____ Voltage: _____ Phase: _____ Wire: _____

Meter socket (200 Amp) RING-TYPE RINGLESS Fifth Terminal? NO YES (at _____ o'clock)

Meter socket (200 Amp) RING-TYPE RINGLESS Fifth Terminal? NO YES (at _____ o'clock)

Main breaker requirements: Amp: _____ Poles: _____ KAIC: _____

Main breaker requirements: Amp: _____ Poles: _____ KAIC: _____

Interior #1 0-42 circuits _____ Load center _____ Panel board _____ Metered? YES NO

Interior #2 0-42 circuits _____ Load center _____ Panel board _____ Metered? YES NO

Branch breakers: Amp: _____ Poles: _____ KAIC: _____ Label & Special Requirements: _____

Qty _____ Breakers _____

Qty _____ Breakers _____

Qty _____ Breakers _____

Qty _____ Breakers _____

Qty _____ Breakers _____

Qty _____ Breakers _____

Controls:

Qty _____ Time Clock: 24 Hr _____ 7 Day _____ 365 Day Astro _____ Description: _____

Qty _____ Photo Electric Control Receptacle

Qty _____ Test switch: 2 Pos. _____ 3 Pos. _____ HOA Type _____ Other _____

Qty _____ Control Transformer _____ Voltage _____ VA Size (required for all 277/480v)

Contractors:

Type: Lighting - LT/Definite Purpose - DP/Mechanical Held - MH/Mercury - MV/IEC - IC

Qty _____ Type _____ Amp _____ Poles _____ Coil voltage _____ Other _____

Qty _____ Type _____ Amp _____ Poles _____ Coil voltage _____ Other _____

Qty _____ Type _____ Amp _____ Poles _____ Coil voltage _____ Other _____

Cabinet/Finish requirements: Alum - Untreated = AO/Alum Anodized = AL/Stainless Steel = SS

Aluminum - Painted = A / GALVANIZED STEEL PAINTED (standard) _____ (specify paint below):

MINT GREEN (standard) = G / PINE GREEN = PG / Dark Green = DG / Black = BK / Desert Tan = DT

White = W / Gray = P / Summerland Gray = SG / Other: (RAL finish number) _____

Other Requirements: _____

Please send any drawings, plans, specifications, and load/panel board schedules with worksheet.

Please consult serving utility for their requirements prior to ordering or installing, as specifications and approvals vary by utility, and may require local electrical inspector approval. All installations must be installed by a licensed electrician and must comply with all national and local codes, laws and regulations. Milbank reserves the right to make changes in specifications and features shown without notice or obligation.



NEMA Commercial Enclosures

Milbank's line of commercial enclosures includes the full gamut of styles and sizes; everything from junction boxes to transformer cabinets, telephone cabinets to wireway.

Type 1 Enclosures

Milbank's Type 1 enclosures are designed for indoor use to provide a degree of protection to personnel against access to hazardous parts and to provide a degree of protection of the equipment inside the enclosure against ingress of solid foreign objects, such as falling dirt.

Type 3R Enclosures

Milbank's Type 3R enclosures are designed for either indoor or outdoor use to provide a degree of protection from harmful effects on the equipment due to the ingress of water (rain, sleet, snow) and that will be undamaged by the external formation of ice on the enclosure.

Wireway

Milbank's wide range of wireway is available in many styles and sizes and its wide range of fittings allows it to smoothly transition to and from competitors' products.

NEMA Industrial Enclosures

Milbank's line of industrial enclosures include junction boxes, wiring trough, push-button enclosures and modular enclosures. Milbank also excels in special designs; nearly any type, size or color of enclosure you need, we can make!

Type 12 Enclosures

Enclosures constructed without knockouts for indoor use to provide a degree of protection to personnel against access to hazardous parts, and protect components against falling dirt, circulating dust and lint, and dripping or splashing water.

Type 4 Enclosures

Enclosures constructed for either indoor or outdoor use to provide a degree of protection to personnel against access to hazardous parts; protect equipment against falling dirt and windblown dust; protect against rain, sleet, snow, splashing water, and hose directed water; and is resistant to damage by the external formation of ice on the enclosure.

Industrial Enclosure Specials

Milbank specializes in custom enclosure projects, offering an almost limitless amount of styles, options, colors and sizes. Milbank will meet your needs and specifications and deliver a custom enclosure that protects your crucial electric equipment.

Thermal Management

Protect components housed in enclosures from damage caused by overheating, freezing, humidity and condensation with these thermal management products.



Please consult serving utility for their requirements prior to ordering or installing, as specifications and approvals vary by utility, and may require local electrical inspector approval. All installations must be installed by a licensed electrician and must comply with all national and local codes, laws and regulations. Milbank reserves the right to make changes in specifications and features shown without notice or obligation.

Accessories

Hubs and Closing Plates

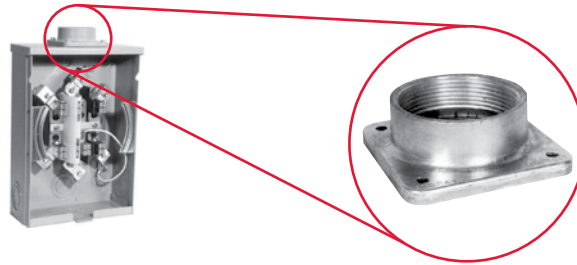
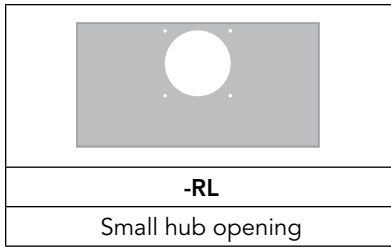

-WL A7514	-YL A7515	-ZL A7516	-DL A7517	-EL A7518	-XL A7551
1" hub	1 1/4" hub	1 1/2" hub	2" hub	2 1/2" hub	Small closing plate

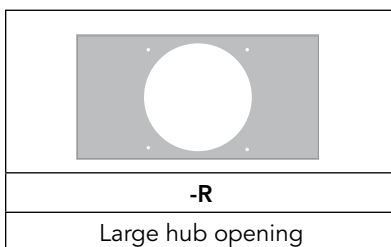

-F A8110	-G A8111	-H A8112	-X A9064	-RRL S8324
3" hub	3 1/2" hub	4" hub	Large closing plate	Large hub opening adapted to small hub opening

Notes



- **Suffix:** Add to catalog number for factory installation of hub.
- **Packaging:** Individually packed units for field installation.
- **Abbreviations:** H.O. (hub opening), C.P. (closing plate).

Please consult serving utility for their requirements prior to ordering or installing, as specifications and approvals vary by utility, and may require local electrical inspector approval. All installations must be installed by a licensed electrician and must comply with all national and local codes, laws and regulations. Milbank reserves the right to make changes in specifications and features shown without notice or obligation.



Connector Kits, Closing Kits & Generator Interlock

Connector Kits — For Use with 3/8"-16 Stud Type Units Only

					
Single			Twin		
Suffix	Part #	(3 per set) - 1Ø	Suffix	Part #	(3 per set) - 1Ø
K1	K1539	6-350	K2	K1350	6-350
K3	K1540	4-600 or (2) 1/0-250	K2L	K1350L	6-350 (non rotating)
K3L	K1540L	4-600 or (2) 1/0-250 (non rotating)	K4	K1541	4-600
Suffix	Part #	(4 per set) - 3Ø	Suffix	Part #	(4 per set) - 3Ø
K5	K3082	6-350	K6	K3442	6-350
K7	K3441	4-600 or (2) 1/0-250	K8	K3083	4-600

Bypass Link



K8180
(sold in pairs, designed for temporary use only.)

Closing Covers

	
Meter Closing Plate (Ring Type/Ringless)	Metal Closing Plate (For Ringless Sockets)
6003 - Gray Plastic	CP-21
6116 - Clear Plastic	

Generator Interlock



K5815 - large QN with small frame Q

K5820 - large frame QN with large frame QN

K5830 - small frame Q to small frame Q

Disconnect Sleeve



M5-144

Do not use with lever bypass sockets

Anti-Inversion Clip



K4802

Isolated Neutral Kit





K1047

Accessories

Fifth Terminal, Tap Connectors & Block Assemblies

Fifth Terminal

		
5T8K2 - 100-200 Amp "Plug-In"	K5T - 200 Amp (Block with Square Hole)	K3865 - Heavy Duty Jaw Clamping (K3866 without Neutral Wire)

Tap Connectors (3 per set)

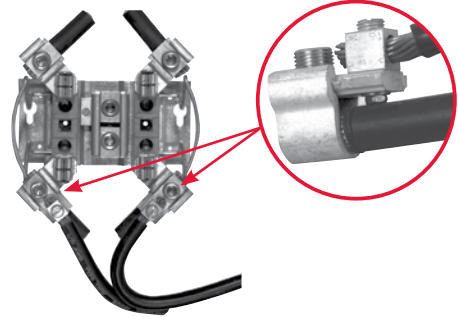
	Replaces the load or line side slide-in nut assembly on Milbank 200 amp sockets. Allows for a 100 amp tap location in addition to the #6-350 kcmil load-side connector. K5022 includes safety barrier extensions for applications over 300 VAC. Three lugs per kit.
K4977-INT - Internal Hex	
K4977-EXT - External Hex	
K5022-INT - Internal Hex (set of 4 with barrier)	

Triplex Ground

K1190 (For factory installed triplex ground, add suffix -TG to catalog number)

100 Amp Blocks *(single sockets only)*

BL7474 - Block Assembly
BL7499 - Horn Bypass Block Assembly
Z904486-AO - Nut Assembly
Z90327486-AO - Horn Bypass Nut Assembly
Z802965-AC - Neutral without Nut
Z901925-AC - Hex Nut Set Screw

200 Amp Blocks *(single sockets only)*

K4527 - Internal Hex Block Assembly (with meter support)
K4528 - External Hex Block Assembly (with meter support)
K4529 - Internal Hex Horn Bypass Block Assembly (with meter support)
K4530 - External Hex Horn Bypass Block Assembly (with meter support)
Z916265-AO - Internal Nut Assembly
Z916264-AO - External Nut Assembly
Z814898-AC - Neutral without Nut

Please consult serving utility for their requirements prior to ordering or installing, as specifications and approvals vary by utility, and may require local electrical inspector approval. All installations must be installed by a licensed electrician and must comply with all national and local codes, laws and regulations. Milbank reserves the right to make changes in specifications and features shown without notice or obligation.



UQFP Plug-In Series Circuit Breakers



UQFP



UQFP-M

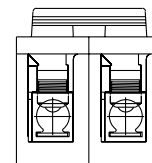
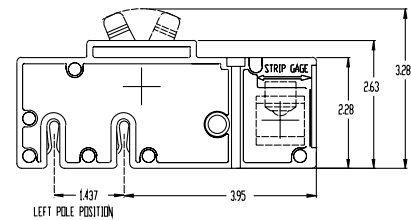
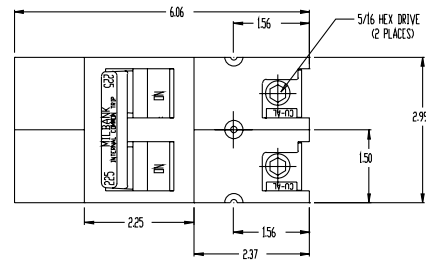

200 Amp Frame | Plug-In | 10K AIC & 22K AIC | Two-Pole | Common Trip

Amp	10K AIC Plug-In	22K AIC Plug-In	10K AIC Plug-In	22K AIC Plug-In	Connectors CU/AL	
					Line	Load
100	UQFP-100	UQFPH-100	UQFP-M-100	UQFPH-M-100	#3-#1	#1-1/0
125	UQFP-125	UQFPH-125	UQFP-M-125	UQFPH-M-125	#3-#1	#1-1/0
150	UQFP-150	UQFPH-150	UQFP-M-150	UQFPH-M-150	1/0-300	2/0-300
200	UQFP-200	UQFPH-200	UQFP-M-200	UQFPH-M-200	1/0-300	2/0-300

Notes

- **UL listed:** For use with 60°C or 75°C wire.
- **UQFP:** For parallel main circuit breaker applications.
- **UQFP-M:** For series main circuit breaker applications. Split load tab features allow for feed through capability.
- **Standard Packaging:** 5 units per 16 lb. carton.



Please consult serving utility for their requirements prior to ordering or installing, as specifications and approvals vary by utility, and may require local electrical inspector approval. All installations must be installed by a licensed electrician and must comply with all national and local codes, laws and regulations. Milbank reserves the right to make changes in specifications and features shown without notice or obligation.

Accessories

UQFB Plug-In Series Circuit Breakers



UQFB-X1



UQFB-X



UQFB



UQFB-X-MOD

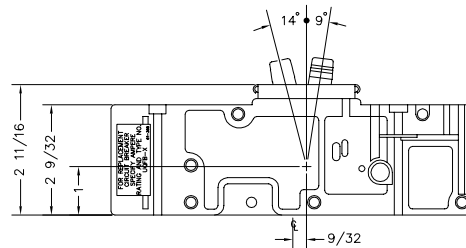
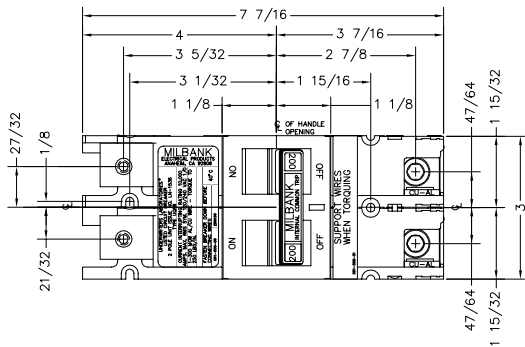

200 Amp Frame | Bolt-On | 10K AIC & 22K AIC | Two-Pole | Common Trip

Amp	10K AIC Bolt-On	22K AIC Bolt-On	10K AIC Bolt-On	Connectors CU/AL	
				Line	Load
100	UQFB-100	UQFBH-100	UQFB-100-X1	#3-#1	#1-1/0
125	UQFB-125	UQFBH-125	UQFB-125-X1	#3-#1	#1-1/0
150	UQFB-150	UQFBH-150	UQFB-150-X1	1/0-300	2/0-300
175	UQFB-175	UQFBH-175	UQFB-175-X1	1/0-300	2/0-300
200	UQFB-200	UQFBH-200	UQFB-200-X1	1/0-300	2/0-300

Notes

- **UL listed:** For use with 60°C or 75°C wire.
- **UQFB:** (2) 1/0-300 kcmil lugs provided on load and line side (cable-in, cable-out).
- **UQFB3:** Three pole available. Consult factory.
- **UQFB-X:** (2) 1/0-300 kcmil lugs provided on load side and (2) line bar bus connections on line side.
- **UQFB-M:** For series main circuit breaker applications. Split load tab features allow for feed through capability.
- **UQFB-X-MOD:** Replacement circuit breaker with line barriers removed.
- **Standard Packaging:** 5 units per 16 lb. carton.

Please consult serving utility for their requirements prior to ordering or installing, as specifications and approvals vary by utility, and may require local electrical inspector approval. All installations must be installed by a licensed electrician and must comply with all national and local codes, laws and regulations. Milbank reserves the right to make changes in specifications and features shown without notice or obligation.



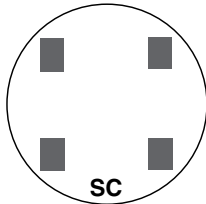

2 and 3-WIRE FORMS
1S & 2S

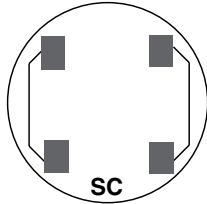

2 and 3-WIRE FORMS
1S & 2S with BYPASS

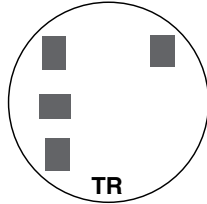

2-WIRE FORM 3S
5th Term. 9 o'clock

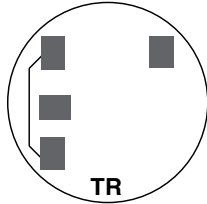

2-WIRE FORM 3S
with BYPASS

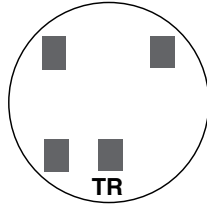

2-WIRE FORM 3S
5th Term. 6 o'clock

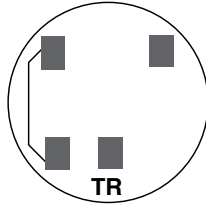

2-WIRE FORM 3S
with BYPASS

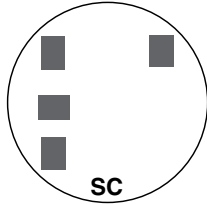

2 ELEMENT
3-WIRE NETWORK
FORM 12S 5th
TERM. 9 o'clock

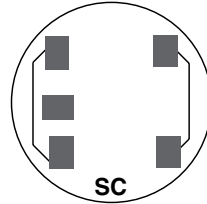

2 ELEMENT 3-WIRE
NETWORK FORM 12S
with BYPASS
5th Term. 9 o'clock

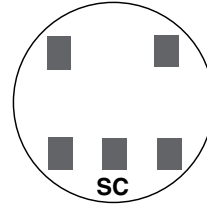

2 ELEMENT
3-WIRE NETWORK
FORM 12S 5th
TERM. 6 o'clock

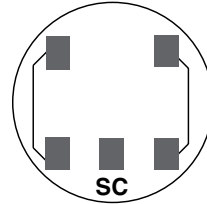

2 ELEMENT 3-WIRE
NETWORK FORM 12S
with BYPASS
5th Term. 6 o'clock

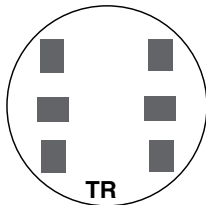

3-WIRE FORM 4S

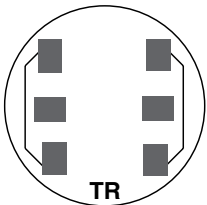

3-WIRE FORM 4S
WITH BYPASS

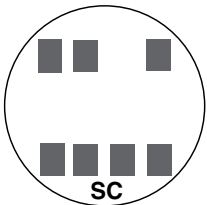

2 or 3 ELEMENT
3Ø4W Y or
Y FORM 14S
FORM 15S
Y FORM 16S

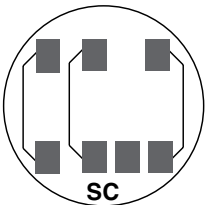

2 or 3 ELEMENT
3Ø4W Y or
FORMS 14S & 15S
with BYPASS

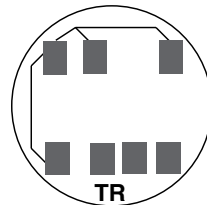

2 ELEMENT
3Ø4W Y or
Y FORM 7S
FORM 24S
with BYPASS

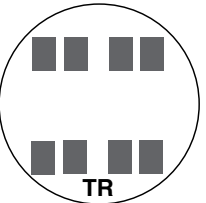

2 ELEMENT
2Ø3W, 2Ø4W, 3Ø3W
FORM 5S

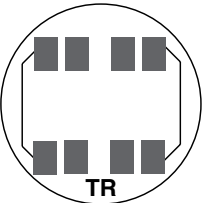

2 ELEMENT 2Ø3W,
2Ø4W, 3Ø3W
FORM 5S with
BYPASS

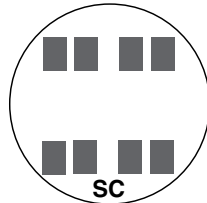

2 ELEMENT
2Ø3W, 2Ø4W, 3Ø3W
FORM 13S

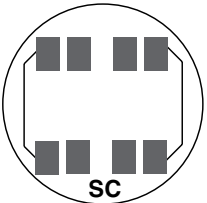

2 or 3 ELEMENT
2Ø3W, 2Ø4W, 3Ø3W
FORM 13S with
BYPASS

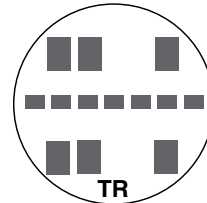

2 or 3 ELEMENT
3Ø4W Y or
Y FORM 9S
FORM 8S

TR = TRANSFORMER RATED
SC = SELF CONTAINED

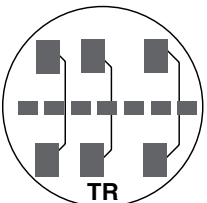

2 or 3 ELEMENT
3Ø4W Y or
FORMS 8S & 9S
FORMS 8S & 9S
with BYPASS

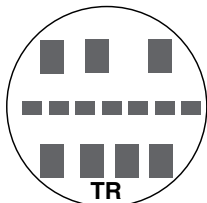

2 ELEMENT
3Ø4W Y
FORM 6S

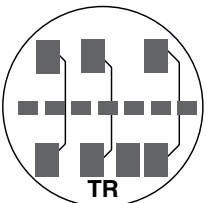

2 ELEMENT
3Ø4W Y
FORM 6S
with BYPASS



Please consult serving utility for their requirements prior to ordering or installing, as specifications and approvals vary by utility, and may require local electrical inspector approval. All installations must be installed by a licensed electrician and must comply with all national and local codes, laws and regulations. Milbank reserves the right to make changes in specifications and features shown without notice or obligation.

Meter Forms

Reference Information

DIAGRAM A
1Ø2W with 1 P.T. & 1 C.T.
Single Stator Meter (2W1Ø) - Form 3S
5T Socket, Test Switch #TS04-0101

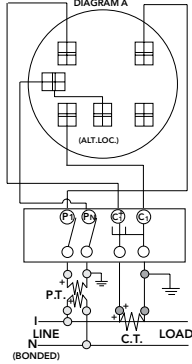

DIAGRAM B
1Ø3W with 1 C.T.
Single Stator Meter (2W1Ø) - Form 3S
5T Socket, Test Switch #TS04-0101

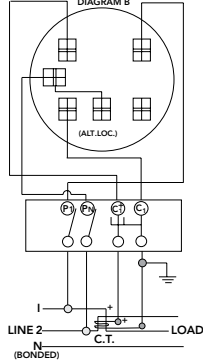

DIAGRAM C
1Ø3W with 2 C.T.'s
Single Stator Meter (3W1Ø) - Form 4S
6T Socket, Test Switch #TS07-0105

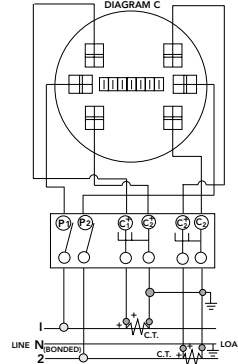

DIAGRAM D
1Ø3W or 3W Network with 2 C.T.'s
2 Stator Meter - Form 5S
8T Socket, Test Switch #TS07-0105

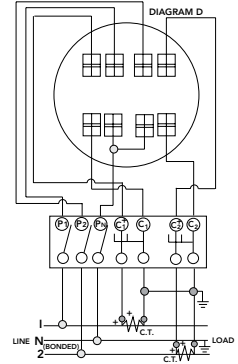

DIAGRAM E
3Ø3W "A" with 2 P.T.'s & 2 C.T.'s
2 Stator Meter - Form 5S
8T Socket, Test Switch #TS07-0105

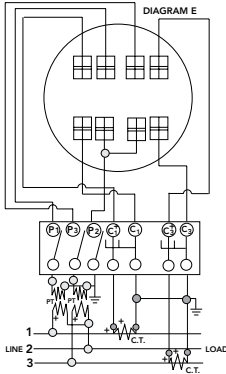

DIAGRAM F
3Ø3W "A" with 2 C.T.'s
2 Stator Meter - Form 5S
8T Socket, Test Switch #TS07-0105

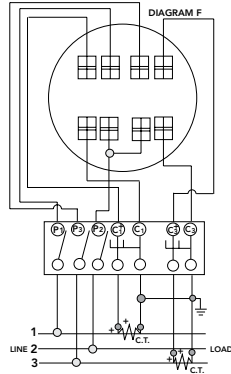

DIAGRAM G
3Ø4W "Y" with 3 C.T.'s
2 1/2 Stator Meter - Form 6S
13T Socket, Test Switch #TS10-0109

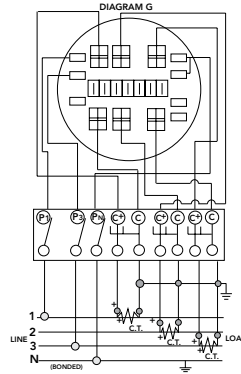

DIAGRAM H
3Ø4W "Y" with 2 P.T.'s & 3 C.T.'s
2 1/2 Stator Meter - Form 6S
13T Socket, Test Switch #TS10-0109

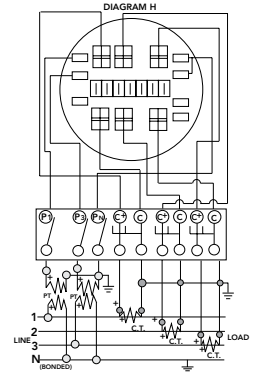

DIAGRAM I
3Ø4W "Y" or "A" with 3 C.T.'s
"Y" 3 Stator Meter - Form 9S
"A" 2 Stator Meter - Form 8S
13T Socket, Test Switch #TS10-0109

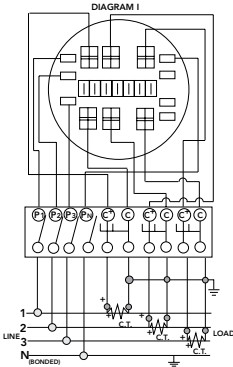
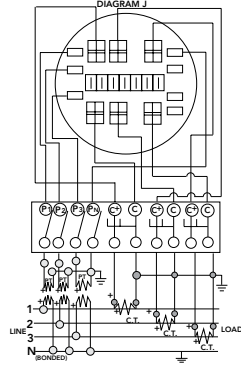

DIAGRAM J
3Ø4W "Y" with 3 P.T.'s & 3 C.T.'s
3 Stator Meter - Form 9S
13T Socket, Test Switch #TS10-0109



Prewiring: If standard factory prewiring is required, refer to wiring diagrams on this page. Determine appropriate diagram and send a copy with order. If custom factory prewiring is required, specify on order. Be sure to include meter socket catalog number, test switch make and catalog number, meter form number and provide a copy of your wiring diagram.

Please consult serving utility for their requirements prior to ordering or installing, as specifications and approvals vary by utility, and may require local electrical inspector approval. All installations must be installed by a licensed electrician and must comply with all national and local codes, laws and regulations. Milbank reserves the right to make changes in specifications and features shown without notice or obligation.



Important Note

In addition to national and local electrical codes, many utilities have specific requirements for metering equipment. Always consult the serving utility for their specifications and requirements prior to ordering or installing Milbank meter mounting equipment.

Before Energizing

1. Give equipment a thorough visual examination to determine that:
 - A. No shipping or installation damage exists.
 - B. Proper clearances have been maintained.
 - C. All connections have been made.
 - D. Equipment is clean and dry.
2. Make a thorough examination to:
 - A. Verify tightness of all bolted connections (see table below).
 - B. Manually operate all circuit breakers, switches, relays, etc.
 - C. Check rigidity of all mountings, bus bars and components.
 - D. Use test equipment to check continuity of circuitry and integrity of insulation.
3. All switches and circuit breakers should be in the "off" position.
4. Verify that manual meter bypass (if applicable) is in non-bypass position.
5. Install cover and/or close doors.
6. If installation is not being energized at this time, follow "after-energizing" steps listed below. These steps will secure the installation in case of accidental energization.

When Energizing

Use caution and follow established safety procedures:

- 1) Wear safety apparel.
- 2) Use safety equipment.
- 3) Take action to prevent injury to yourself and others in the event of failure of the installation.
- 4) Take action to prevent/decrease damage to property in the event of failure of the installation.
- 5) If you are unsure how to safely energize the installation, get someone who is knowledgeable to do it.

After Energizing

Secure the installation:

- 1) To prevent accidental contact with energized parts, cover all openings with approved filler devices.
- 2) To prevent unauthorized access, secure all covers and/or doors with approved security devices.
- 3) Attach/post information to advise others of potential hazards associated with the installation.

Recommended Torque for General Applications*

Nominal Size	Joint Description		Head Type	Torque (Inch Lbs.)
	Screw	Nut		
10	Brass	Brass Nut or Extruded Hole	All	20-25 inch lbs.
10	Steel	Copper or Aluminum Busbar ≤ 1/8"	All	25-30 inch lbs.
10	Steel	Steel Nut or Extruded Hole; CU or AL Busbar > 1/8"	All	30-35 inch lbs.
12	Steel	Aluminum Extruded Hole	All	30-35 inch lbs.
12	Steel	Steel Nut or Extruded Hole	All	40-50 inch lbs.
1/4	Steel	Aluminum Extruded Hole	All	40-50 inch lbs.
1/4	Steel	Steel Nut or Extruded Hole; CU or AL Busbar	All	50-60 inch lbs.
5/16	Steel	Aluminum Extruded Hole	Hex	60-70 inch lbs.
5/16	Steel	Steel Nut or Extruded Hole; CU or AL Busbar	Hex	100-150 inch lbs.
3/8	Steel	Steel Nut	Hex	150-200 inch lbs.
1/2	Steel	Steel Nut	Hex	200-250 inch lbs.

* Interior labels typically indicate the required torque for wire connectors and studs, and should be referenced first.
CU: Copper
AL: Aluminum



Please consult serving utility for their requirements prior to ordering or installing, as specifications and approvals vary by utility, and may require local electrical inspector approval. All installations must be installed by a licensed electrician and must comply with all national and local codes, laws and regulations. Milbank reserves the right to make changes in specifications and features shown without notice or obligation.

Materials & Finishes

Reference Information

Materials

Steel Quality

The meter equipment listed in this catalog is made of galvanized steel (AISI* G90) to afford the best possible weather proofing.
*American Iron and Steel Institute.

Steel Sheet

16 gauge, galvanized, sheet: 1 1/4 oz./ sq.ft. class zinc-coated. (AISI G90)
14 gauge, galvanized, sheet: 1 1/4 oz./ sq.ft. class zinc-coated.

Aluminum Extrusion

Wire-Terminal: Alloy; 6061-T6, Tin-plated for CU/AL wire.
Bus Bar: Alloy; 6101-O & 6063-O

Aluminum Sheet

3000 series aluminum sheet, H14, or 5052 series aluminum sheet, H32. Where applicable thicknesses range from .064-.125

Copper Sheet & Bus

Electrolytic copper with tin plating in most applications.

Insulating Materials

- In most units, support bases for current-carrying components are molded from fiberglass reinforced high-strength, track resistant, thermoset polyester molding compounds.
- Clear or black safety shields and polarity barriers are molded from high-strength, track resistant, polycarbonate molding compounds.
- Various sheet insulating materials, as appropriate for the application are utilized in the fabrication of flat, formed and punched component parts and barriers.

Finish

Process

Light gray state-of-the-art electrostatically applied powder paint offers a durable, non-fading finish. For further information concerning the chemical analysis of the weather resistant finish, please contact the factory.

Metal Fasteners

Zinc-coated with a chromate dip.

Ratings & Compliance

Ratings & Compliance

All Milbank electrical enclosures in this catalog are rated "Type 3R Enclosure" unless specified otherwise on the product's page. All enclosures with a UL designation are constructed per the appropriate UL Standard and may be installed per the National Electric Code. UL procedure files associated with the UL Standards are listed as follows: Meter Sockets (UL 414, File E30202), Test Switches (UL 414, File E62531), Power Outlets (UL 231, File E90945), Panelboards (UL 67, File E32628) and Pullout Switches (UL 1429, File E133062). Additional standards are utilized as applicable: Meter Sockets (ANSI C12.7), Test Switches (ANSI C12.9) and Panelboards (NEMA PB-1).

Please consult serving utility for their requirements prior to ordering or installing, as specifications and approvals vary by utility, and may require local electrical inspector approval. All installations must be installed by a licensed electrician and must comply with all national and local codes, laws and regulations. Milbank reserves the right to make changes in specifications and features shown without notice or obligation.



6003.....	116	BC214.....	46	K3082.....	116
6116.....	116	BC234.....	46	K3083.....	116
020-147-00-00-0.....	65	BC318.....	46	K3441.....	116
105J.....	103	BC338.....	46	K3442.....	116
10URMD.....	92	BC418.....	46	K3865.....	103
10URMD24.....	92	BC438.....	46	K3865.....	117
114TB.....	31	BC518.....	46	K3866.....	117
115TB.....	31	BC538.....	46	K4527.....	117
117TB.....	31	BC618.....	46	K4528.....	117
124TB.....	31	BC638.....	46	K4529.....	117
125TB.....	31	BL7474.....	117	K4530.....	117
127TB.....	31	BL7499.....	117	K4709-02.....	85
16URMD.....	92	CL200-D.....	87	K4709-02-3R.....	85
16URMD24.....	92	CP-16PDMNT-CALT.....	103	K4722.....	60
20URMD.....	92	CP-21.....	116	K4729.....	60
20URMD24.....	92	CP-24PDMNT-CALT.....	103	K4793.....	60
214MTB.....	32	CP-32PDMNT.....	103	K4794.....	60
214MTB/22.....	33	CP3B0181UMWIR02.....	98	K4795.....	60
214MTB-48.....	34	CP3B0281UMWIR03.....	98	K4796.....	60
214MTB-P.....	35	CP3B0281UMWIR04.....	98	K4797.....	60
214MTB-P48.....	35	CP3B11110A22SL1.....	96	K4797.....	60
215MTB.....	32	CP3B11115A22.....	95	K4798.....	60
215MTB-48.....	34	CP3B12110A22SL1.....	96	K4798.....	60
215MTB-P.....	35	CP3B12119A22.....	95	K4800-D.....	87
215MTB-P48.....	35	CP3B1411jb.....	97	K4802.....	116
217MTB.....	32	CP3B14120b.....	97	K4806-BP.....	59
217MTB/22.....	33	CP3B51110A22SL1.....	96	K4903.....	60
217MTB-48.....	34	CP3B51115A22.....	95	K4904.....	60
217MTB-P.....	35	CP3B52110A22SL1.....	96	K4977-EXT.....	117
217MTB-P48.....	35	CP3B52119A22.....	95	K4977-INT.....	117
224MTB.....	36	CP3B5411Jb22.....	97	K5022-INT.....	117
224MTB/22.....	37	CP3B54120b22.....	97	K5400-100MBM.....	88
224MTB-48.....	38	CP3B-AUX-1200.....	90	K5400-100MBU.....	88
224MTB-P.....	39	CP-ABK5/8.....	103	K5410.....	86
224MTB-P48.....	39	CP-PE-HOA-3POS.....	103	K5411.....	83
225MTB-P.....	39	CP-PE-TYP5-2POS.....	103	K5412.....	84
225MTB-P48.....	39	CP-TC24H.....	103	K5413.....	83
227MTB.....	36	CP-TC7D.....	103	K5415.....	86
227MTB/22.....	37	CP-TCWIRE.....	103	K5421.....	86
227MTB-48.....	38	CT203611-HC.....	61	K5747.....	60
227MTB-P.....	39	CT242411-SC.....	61	K5752.....	60
227MTB-P48.....	39	CT243011-HC.....	61	K5815.....	116
243210-LC3R-SP.....	59	CT243011-SC.....	61	K5820.....	116
25URMD.....	92	CT24329-SC.....	61	K5830.....	116
25URMD24.....	92	CT243611-HC.....	61	K5920-10GR.....	82
323610-LC3R-SP.....	59	CT243611-SC.....	61	K5920-111GR.....	82
363016-CT3R.....	59	CT244811-HC.....	61	K5920-11GR.....	82
363612-CT3R-SP.....	59	CT244811-SC.....	61	K5920-38.....	82
364812-CT3R-SP2.....	59	CT303011-SC.....	61	K5920-41.....	82
403456-SC.....	67	CT303611-HC.....	61	K5920-522.....	82
518K2.....	117	CT303611-SC.....	61	K5920-54.....	82
701776-MO.....	89	CT303614-SC.....	61	K5920-58.....	82
703997-MO.....	79	CT304811-HC.....	61	K5920-75.....	82
704995-MO.....	79	CT363611-HC.....	61	K5920-BLANK.....	82
706761-MO.....	79	CT363611-SC.....	61	K5T.....	117
707915-MO.....	79	CT364211-SC.....	61	K6212.....	83
708080-MO.....	89	CT364811-HC.....	61	K6213.....	84
708777-MO.....	79	CT364811-SC.....	61	K8180.....	116
708784-MO.....	88	CT364814-SC.....	61	M400-aps.....	27
708785-MO.....	79	CT424211-SC.....	61	M400-aps-BS.....	27
A7514.....	115	CT484811-HC.....	61	M400-PAR-UG.....	26
A7515.....	115	CT484811-SC.....	61	M400-UG-APS-F.....	28
A7516.....	115	CT484814-HC.....	61	M400-UG-APS-F-BS.....	28
A7517.....	115	CT484814-SC.....	61	M400-UG-APS-LC.....	28
A7518.....	115	K1047.....	116	M400-UG-APS-LC-BS.....	28
A7551.....	115	K1190.....	117	M400-UG-APS-P.....	28
A8110.....	115	K1350.....	116	M401-UG.....	29
A8111.....	115	K1350L.....	116	M401-UG-BS.....	29
A8112.....	115	K1539.....	116	M404-UG-LC.....	30
A9064.....	115	K1540.....	116	M404-UG-LC-BS.....	30
AP2300-03.....	10	K1540L.....	116	M5-144.....	116
AP2300-04.....	10	K1541.....	116	MPAP-100-78.....	64



Please consult serving utility for their requirements prior to ordering or installing, as specifications and approvals vary by utility, and may require local electrical inspector approval. All installations must be installed by a licensed electrician and must comply with all national and local codes, laws and regulations. Milbank reserves the right to make changes in specifications and features shown without notice or obligation.

MPAP-100-MB-78.....	64	U214MTB/22.....	33	U3532-X-K1.....	49
MPAP-200-20GR-78.....	64	U214MTB-48.....	34	U3533-X-K3.....	49
MPAP-200-78.....	64	U214MTBL.....	40	U3534-X-K3.....	49
MPAP-200-MB-78.....	64	U214MTB-P.....	35	U3548-X.....	21
MPAP-200-MBLC-80.....	65	U214MTB-P48.....	35	U3555-R.....	62
MPAP-BLANK-78.....	64	U214MTBPL.....	40	U3565-O.....	62
MPAP-BLANK-78R.....	64	U215MTB.....	32	U3574-RL-200.....	24
MPAPD-BLANK-78.....	64	U215MTB-P.....	35	U3577-RL-200.....	24
MPAPD-BLANK-78R.....	64	U215MTB-P48.....	35	U3584-O-200.....	24
MPRV-100-20GR-78.....	63	U217MTB.....	32	U3587-O-200.....	24
MPRV-100-78.....	63	U217MTB/22.....	33	U3802.....	7
MPRV-100-MB-78.....	63	U217MTB-48.....	34	U3812.....	7
MPRV-100-MBLC-80.....	65	U217MTBL.....	40	U3822-20GWR.....	8
MPRV-503020GR-78.....	63	U217MTB-P.....	35	U3832.....	7
MPRV-50-78.....	63	U217MTB-P48.....	35	U3852-XL.....	17
MPRV-BLANK-78.....	63	U217MTBPL.....	40	U3862.....	7
MPRV-BLANK-78-R-5T.....	63	U224MTB.....	36	U4013-X.....	22
MR-2.....	89	U224MTB/22.....	37	U4015-O.....	14
MS-24-TB.....	44	U224MTB-48.....	38	U4031-O-2/200.....	26
MS-25-TB.....	44	U224MTBL.....	40	U4175-RL-BLG.....	11
MS-27-TB.....	44	U224MTB-P.....	39	U4517-DL-M4.....	14
PB-011.....	45	U224MTB-P48.....	39	U4518-O-W.....	14
PB-012.....	45	U224MTBPL.....	40	U4518-XL-W.....	14
PB-014.....	45	U227MTB.....	36	U4540-XL.....	91
PB-014-NK.....	45	U227MTB/22.....	37	U4542-XL.....	91
PB-018.....	45	U227MTB-48.....	38	U4544-XL.....	91
PB-018-NK.....	45	U227MTBL.....	40	U4546-XL.....	91
PB-032.....	45	U227MTB-P.....	39	U4548-RXL.....	91
PB-034.....	45	U227MTB-P48.....	39	U4549-RXL.....	91
PB-034-NK.....	45	U227MTBPL.....	40	U4881-O.....	9
PB-038.....	45	U2594-X.....	22	U4881-O-50GB.....	9
PF-BL.....	67	U2827-X.....	22	U4881-O-60GB.....	9
PF-KR.....	67	U2852-X.....	50	U4909-O-11GR.....	75
PT223.....	44	U2853-X.....	50	U5000-XL.....	80
PT224.....	44	U2854-X.....	50	U5000-XL-41.....	80
PT263.....	44	U2855-X.....	50	U5000-XL-55.....	80
PT264.....	44	U2856-X.....	50	U5000-XL-75.....	80
PT323.....	44	U2862-X.....	50	U5001-RL-01.....	77
PT324.....	44	U2863-X.....	50	U5056-O.....	21
PT363.....	44	U2864-X.....	50	U5059-x-2/200.....	26
PT364.....	44	U2865-X.....	50	U5100-XL.....	80
Q115.....	79	U2866-X.....	50	U5100-XL-41.....	80
Q120.....	79	U3251-O-200-CB.....	28	U5100-XL-55.....	80
Q130.....	79	U3319-R.....	62	U5100-XL-75.....	80
Q2100.....	79	U3320-R.....	62	U5136-O.....	72
Q220.....	79	U3321-R.....	62	U5136-O-100S.....	72
Q250.....	79	U3322-R.....	62	U5136-O-200S.....	72
RBK-1.....	65	U3323-R.....	62	U5137-O.....	72
S8324.....	115	U3328-RXL.....	14	U5137-O-100S.....	72
TB100-47.....	44	U3339-O.....	62	U5137-O-200S.....	72
TB100-5.....	44	U3340-O.....	62	U5138-O.....	72
TB200-47.....	44	U3341-O.....	62	U5138-O-200S.....	72
TB200-5.....	44	U3342-O.....	62	U5139-O.....	72
TB200-LL.....	44	U3343-O.....	62	U5168-XTL-100.....	25
U1060-RL.....	13	U3412-O.....	47	U5168-XTL-100-KK.....	25
U1079-R.....	20	U3413-O.....	47	U5168-XTL-100-KK-5T.....	25
U1129-O-K3L-K2L.....	20	U3414-O.....	47	U5168-XTL-150.....	25
U1211-RXL.....	17	U3415-O.....	47	U5168-XTL-150-KK.....	25
U1252-X-K1.....	49	U3416-O.....	47	U5168-XTL-150-KK-5T.....	25
U1253-X-K3.....	49	U3462-O.....	47	U5168-XTL-200.....	25
U1254-X-K3.....	49	U3463-O.....	47	U5168-XTL-200-KK.....	25
U1255-X-K4.....	49	U3464-O.....	47	U5169-XTL-100.....	25
U1256-X-K4.....	49	U3465-O.....	47	U5169-XTL-150.....	25
U1431-R.....	20	U3466-O.....	47	U5169-XTL-200.....	25
U1432-O.....	20	U3504-XL.....	16	U5200-XL.....	81
U1527-O.....	13	U3507-XL.....	16	U5200-XL-41.....	81
U1681-RL.....	12	U3514-XL.....	16	U5200-XL-55.....	81
U1797-O-K3L-K2L.....	20	U3517-XL.....	16	U5200-XL-75.....	81
U1819-X.....	20	U3522-XL-K1.....	48	U5240-O.....	70
U1980-O.....	13	U3523-XL-K1.....	48	U5240-O-100S.....	70
U2120-X.....	22	U3524-XL-K2.....	48	U5240-O-200S.....	70
U214MTB.....	32	U3525-XL-K2.....	48	U5241-O.....	70

Please consult serving utility for their requirements prior to ordering or installing, as specifications and approvals vary by utility, and may require local electrical inspector approval. All installations must be installed by a licensed electrician and must comply with all national and local codes, laws and regulations. Milbank reserves the right to make changes in specifications and features shown without notice or obligation.



U5241-O-100S.....	70	UC3426-XL.....	55
U5241-O-200S.....	70	UC3428-XL.....	55
U5242-O.....	70	UC3433-XL.....	55
U5242-O-200S.....	70	UC3434-XL.....	55
U5243-O.....	70	UC3435-XL.....	55
U5268-XTL-150.....	25	UC3436-XL.....	55
U5268-XTL-150-KK.....	25	UC3438-XL.....	55
U5268-XTL-200.....	25	UC7233-XL.....	54
U5268-XTL-200-KK.....	25	UC7235-XL.....	54
U5269-XTL-200.....	25	UC7237-XL.....	54
U5300-O.....	81	UC7461-YL-TGE-DES.....	55
U5300-O-41.....	81	UC7544-RL.....	54
U5300-O-55.....	81	UC7545-RL.....	54
U5300-O-75.....	81	UC7582-RL.....	54
U5706-O-200S.....	74	UC7636-YL-TGE-DES.....	55
U5706-O-200S-KK.....	74	UF4015-KO.....	15
U5707-O-200S.....	74	UF4517-KO.....	15
U5759-x-2/200.....	26	UF4518-KO.....	15
U5865-XL-38GBGRW.....	78	UF4969-KO.....	15
U5882-X.....	52	UQFB-100.....	119
U5883-X.....	52	UQFB-100-X1.....	119
U5884-X.....	52	UQFB-125.....	119
U5885-X.....	52	UQFB-125-X1.....	119
U5886-X.....	52	UQFB-150.....	119
U5902-X.....	52	UQFB-150-X1.....	119
U5903-X.....	52	UQFB-175.....	119
U5904-X.....	52	UQFB-175-X1.....	119
U5905-X.....	52	UQFB-200.....	119
U5906-X.....	52	UQFB-200-X1.....	119
U5929-XL-INS.....	11	UQFBH-100.....	119
U5934-XL-BLG.....	11	UQFBH-125.....	119
U5971-XL-100.....	23	UQFBH-150.....	119
U5971-XL-200.....	23	UQFBH-175.....	119
U6087-XL.....	11	UQFBH-200.....	119
U6087-XL-INS.....	11	UQFP-100.....	118
U6276-O-100.....	68	UQFP-125.....	118
U6276-O-100MB.....	68	UQFP-150.....	118
U6276-O-10GR.....	68	UQFP-200.....	118
U6276-O-41.....	68	UQFPH-100.....	118
U6276-O-54.....	68	UQFPH-125.....	118
U6276-O-55.....	68	UQFPH-150.....	118
U6276-O-75.....	68	UQFPH-200.....	118
U7021-RL-TG.....	13	UQFPH-M-100.....	118
U7040-XL-TG.....	13	UQFPH-M-125.....	118
U7043-XL-TG.....	13	UQFPH-M-150.....	118
U7422-RXL.....	18	UQFPH-M-200.....	118
U7423-RXL.....	18	UQFP-M-100.....	118
U7487-O.....	12	UQFP-M-125.....	118
U7487-RL.....	12	UQFP-M-150.....	118
U7490-O.....	12	UQFP-M-200.....	118
U7490-RL.....	12	USE-AP-200-MB.....	23
U7573-RL.....	18	USE-AP-200-ML.....	23
U8032-XL.....	48	Z020-148-00-00-0.....	65
U8033-XL.....	48	Z020-148-00-00-0.....	79
U8034-XL.....	48	Z1050596.....	65
U8035-XL.....	48	Z1050596.....	79
U8036-XL.....	48	Z700911-MO.....	79
U8100-RL.....	18	Z708767-MO.....	89
U9319-XL.....	17	Z802965-AC.....	117
U9320-RXL.....	18	Z814898-AC.....	117
U9550-RRL.....	19	Z818052-SC.....	89
U9551-RXL.....	19	Z818480-SC.....	89
U9700-RRL.....	19	Z901925-AC.....	117
U9701-RXL.....	19	Z90327486-AO.....	117
U9800-RRL.....	19	Z904486-AO.....	117
U9801-RXL.....	19	Z915141-AC.....	88
UC1290-XL.....	54	Z916264-AO.....	117
UC1291-RL.....	54	Z916265-AO.....	117
UC1299-XL.....	54	Z917602-AC.....	88
UC1300-RL.....	54	Z918447-AC.....	89
UC3423-XL.....	55	Z918449-AC.....	89
UC3425-XL.....	55	Z918466-AC.....	88



Please consult serving utility for their requirements prior to ordering or installing, as specifications and approvals vary by utility, and may require local electrical inspector approval. All installations must be installed by a licensed electrician and must comply with all national and local codes, laws and regulations. Milbank reserves the right to make changes in specifications and features shown without notice or obligation.

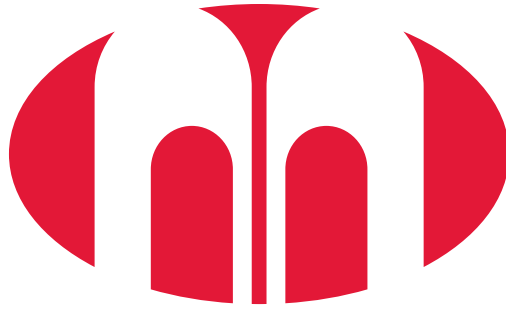

MILBANK[®]

ENERGY AT WORK



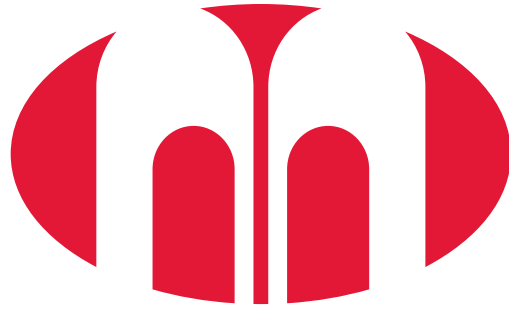

MILBANK[®]
ENERGY AT WORK



Western Region

Product Catalog



Milbank Overview

Energy At Work since 1927

Milbank designs and manufactures electrical solutions that move and manage power for the residential, commercial, industrial, utility and transportation sectors. With 90 years of expertise in electrical engineering design and manufacturing, Milbank's portfolio includes metering equipment, enclosures and enclosed controls. Founded in 1927, Milbank is a family-owned, American manufacturer headquartered in Kansas City, Mo. For more information, please visit milbankworks.com.

METERING



As a market leader in electrical metering equipment, Milbank has set the standard for quality since 1927. Hundreds of configurations are available, including many sizes, knockout configurations, terminal configurations, bypass options, hubs, locks and connectors. Milbank has the socket you need with thousands of active products to meet your utility's requirements.

ENCLOSURES



Milbank's line of enclosures include commercial junction boxes, panel mount enclosures, transformer cabinets, wireway, trough and industrial panel mount and push-button enclosures. Built with high-quality craftsmanship and materials which meet or exceed industry standards, Milbank enclosures are made to protect controls and equipment from dust, dirt and other harmful elements found in a wide variety of environments.

ENCLOSED CONTROLS



Milbank doesn't just build empty enclosures. We can deliver the entire package, complete with custom control equipment built to your exact specifications by our engineers. Milbank commercial pedestals are an attractive, secure, easy to install and cost-effective solution when underground remote site power distribution and control equipment is required, replacing unsightly and inefficient strut and backboard structures. Milbank's manual and automatic transfer switches are durable, easy to install and compatible with most generators.



Please consult serving utility for their requirements prior to ordering or installing, as specifications and approvals vary by utility, and may require local electrical inspector approval. All installations must be installed by a licensed electrician and must comply with all national and local codes, laws and regulations. Milbank reserves the right to make changes in specifications and features shown without notice or obligation.

Air Conditioner Disconnects

30-60 amp AC disconnects	7
60 amp AC disconnect with 20 amp GFCI receptacle	8
Hot tub disconnects.....	9

Single Position Sockets

30-100 amp, 4 terminal, ring type	10
100 amp, solar sockets, 4 terminal	11
125 amp, 4 & 7 terminal, ringless & ring type	12
200 amp, 4 & 7 terminal, ringless & ring type	13-14
200 amp, 4 terminal, ring type	15
125-200 amp, 4 & 7 terminal, ring type, link bypass	16
200 amp, 4 & 5 terminal, lever bypass, ringless, lever bypass.....	17
125-200 amp, 4,5 & 7 terminal, ringless, lever bypass	18-19
320 amp, 4 terminal, lever & non-lever bypass, ringless.....	20
320 amp, 4 terminal, link bypass, ring type.....	21
320 amp, 7 terminal, lever bypass, ringless.....	22
100-200 amp, 4 terminal, main breaker.....	23

Meter Mains

200 amp, 4 & 7 terminal, ring type.....	24
100-200 amp, 4 & 5 terminal, ringless & ring type	25
400-320 amp continuous, 4 terminal, ringless & ring type	26-30

Safety Sockets

100 & 200 amp, 4, 5 & 7 terminal, ring type, test block bypass.....	31-32
100 amp, 4, 5 & 7 terminal, ring type, test block bypass	33-35
200 amp, 4, 5 & 7 terminal, ring type, test block bypass	36-39
100 & 200 amp, all-in-one series, test block bypass	40-41
Replacement Parts	42-44

Underground Termination Boxes

100-800 amp.....	45
Bussed gutters, type 3R	46-47

Multi-Position Sockets

100-125 amp, 4 terminal, ringless	48
200 amp, 4 terminal, ringless.....	49
125 & 200 amp, 4 terminal, meter mains, ringless.....	50-53

Please consult serving utility for their requirements prior to ordering or installing, as specifications and approvals vary by utility, and may require local electrical inspector approval. All installations must be installed by a licensed electrician and must comply with all national and local codes, laws and regulations. Milbank reserves the right to make changes in specifications and features shown without notice or obligation.



Miscellaneous

Current transformer enclosures	54-55
Current transformer test switches	56-57
Test switch worksheet	58
Current transformer cabinets.....	59-62
Service pedestals, mobile home	63-64
Power pedestals	65
Replacement parts.....	66-67
Mobile home pedestals.....	68
Service pedestals.....	69-74
Temporary power	75-79
Surface mount power	80
Power outlet pedestals.....	81
Replacement receptacle plates.....	82
Lighting accessories.....	83-84
Telecom and pedestal accessories.....	85
Pedestal mounting accessories	86
Metering and receptacle accessories.....	87
Replacement parts and accessories	88-89
Recreational vehicle products.....	90-91
Dry type transformers.....	92

Commercial Pedestals

Commercial pedestal overview.....	93-94
100-200 amp, 4 terminal ringless & ring type.....	95
100-200 amp, Switch load center, 4 terminal, ringless & ring type	96
400 amp, class 320 4 terminal, ringless & ring type	97
100 amp, irrigation, 4 terminal, ring type.....	98
Battery backup series	99
Power transfer series	100
CT metered series.....	101
Slim line series	102
Commercial pedestal accessories	103
Commercial pedestal reference information.....	104-113

Miscellaneous

Commercial & industrial enclosures	114
Accessories	115-119
Reference information	120-123
Index.....	124-128



Please consult serving utility for their requirements prior to ordering or installing, as specifications and approvals vary by utility, and may require local electrical inspector approval. All installations must be installed by a licensed electrician and must comply with all national and local codes, laws and regulations. Milbank reserves the right to make changes in specifications and features shown without notice or obligation.

Catalog Number Logic

How our product catalog numbers are derived

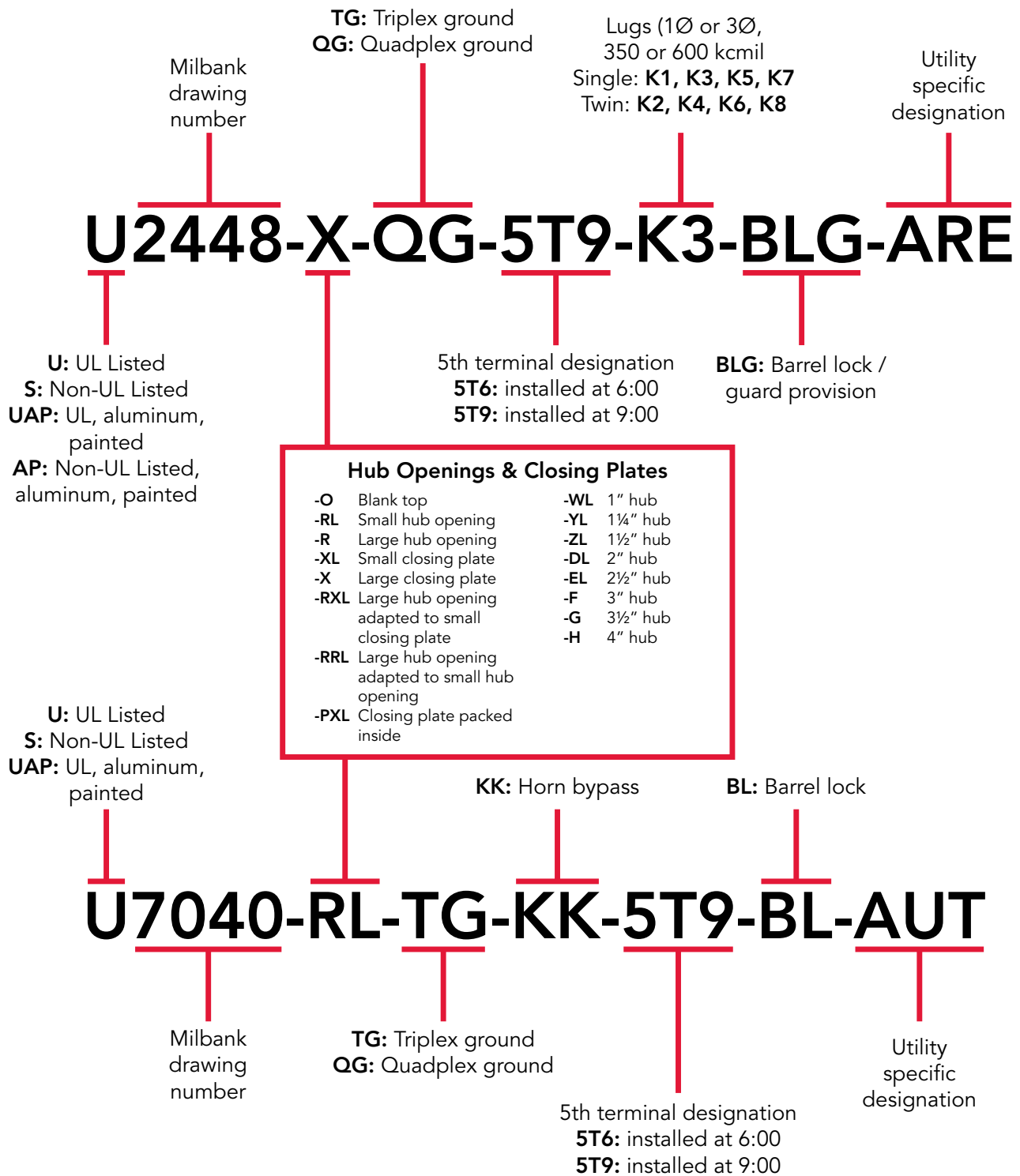

Please consult serving utility for their requirements prior to ordering or installing, as specifications and approvals vary by utility, and may require local electrical inspector approval. All installations must be installed by a licensed electrician and must comply with all national and local codes, laws and regulations. Milbank reserves the right to make changes in specifications and features shown without notice or obligation.



Catalog Number	EUSERC Drawing Number	Catalog Page	Catalog Number	EUSERC Drawing Number	Catalog Page	Catalog Number	EUSERC Drawing Number	Catalog Page
U3574-RL-200	301	24	215MTB-P48	305A, 311	35	PB-034	343	45
U3577-RL-200	301	24	217MTB-P48	305A, 311	35	PB-034-NK	343	45
U3584-O-200	301	24	U214MTB-P48	305A, 311	35	PB-038	343	45
U3597-O-200	301	24	U215MTB-P48	305A, 311	35	U3320-R	313	62
U4015-O	301A	14	U217MTB-P48	305A, 311	35	MPRV-BLANK-78	307	63
UF4015-KO	301A	15	224MTB	305A, 311	36	MPRV-BLANK-78-R5T	307	63
U3548-X	302B	21	225MTB	305A, 311	36	MPRV-100-78	307	63
M400-UG-APS-F	302A	28	227MTB	305A, 311	37	MPRV-100-MB-78	307	63
M400-UG-APS-F-BS	302	28	U224MTB	305A, 311	36	MPRV-50-78	307	63
M400-UG-APS-P	302A	28	U225MTB	305A, 311	36	MPRV-503020GR-78	307	63
M400-UG-APS-LC	302A	28	U227MTB	305A, 311	36	MPAP-BLANK-78	307	64
M400-UG-APS-LC-BS	302A	28	U224MTB	305A, 311	36	MPAP-BLANK-78R	307	64
U3251-O-200-CB	302	28	U225MTB	305A, 311	36	MPAP-100-78	307	64
M401-UG	302A	29	U227MTB	305A, 311	36	MPAP-100-MB-78	307	64
M401-UG-BS	302	29	224MTB/22	305A, 311	37	MPAP-200-78	307	64
M404-UG-LC	302A	30	227MTB/22	305A, 311	37	MPAP-200-MB-78	307	64
M404-UG-LC-BS	302	30	U224MTB/22	305A, 311	37	MPAP-200-20GR-78	307	64
114TB	304, 311	31	U227MTB/22	305A, 311	37	MPAPD-BLANK-78	307	64
115TB	304, 311	31	227MTB-48	305A, 311	38	MPAPD-BLANK-78R	307	64
117TB	304, 311	31	U224MTB-48	305A, 311	38	U3322-R	313	62
124TB	305, 311	31	U227MTB-48	305A, 311	38	U3355-R	313	62
125TB	305, 311	31	224MTB-P	305A, 311	39	U3340-O	314	62
127TB	305, 311	31	225MTB-P	305A, 311	39	U3342-O	314	62
214MTB	305A, 311	32	227MTB-P	305A, 311	39	U3565-O	314	62
215MTB	305A, 311	32	U224MTB-P	305A, 311	39	CT244811-SC	316, 317	61
217MTB	305A, 311	32	U227MTB-P	305A, 311	39	CT364811-SC	316, 317, 318	61
U214MTB	305A, 311	32	224MTB-P48	305A, 311	39	CT364814-SC	316, 317, 318	61
U215MTB	305A, 311	32	225MTB-P48	305A, 311	39	CT484811-SC	316, 317	61
U217MTB	305A, 311	32	227MTB-P48	305A, 311	39	CT244811-HC	316, 317	61
214MTB/22	305A, 311	33	U224MTB-P48	305A, 311	39	CT304811-HC	316, 317	61
217MTB/22	305A, 311	33	U227MTB-P48	305A, 311	39	CT364811-HC	316, 317, 318	61
U214MTB/22	305A, 311	33	U214MTBL	305A, 311	40	CT484811-HC	316, 317, 318	61
U217MTB/22	305A, 311	33	U214MTBPL	305A, 311	40	CT484814-HC	316, 317, 318	61
214MTB-48	305A, 311	34	U217MTBL	305A, 311	40	K4903	328B	60
215MTB-48	305A, 311	34	U217MTBPL	305A, 311	40	K4904	329B	60
217MTB-48	305A, 311	34	U224MTBL	305A, 311	40	K4722	329B	60
U214MTB-48	305A, 311	34	U224MTBPL	305A, 311	40	K4729	328B	60
U215MTB-48	305A, 311	34	U227MTBL	305A, 311	40	K4797	328A	60
U217MTB-48	305A, 311	34	U227MTBPL	305A, 311	40	K4798	339A	60
214MTB-P	305A, 311	35	PB-011	305A, 311	45	UC3435-XL	339	54
215MTB-P	305A, 311	35	PB-012	343A	45	UC3436-XL	339	54
217MTB-P	305A, 311	35	PB-014	343	45	UC3438-XL	339	54
U214MTB-P	305A, 311	35	PB-014-NK	343	45	UC3433-XL	339	54
U215MTB-P	305A, 311	35	PB-018	343	45	UC3434-XL	339	54
U217MTB-P	305A, 311	35	PB-034-NK	343	45			
214MTB-P48	305A, 311	35	PB-032	343A	45			



Please consult serving utility for their requirements prior to ordering or installing, as specifications and approvals vary by utility, and may require local electrical inspector approval. All installations must be installed by a licensed electrician and must comply with all national and local codes, laws and regulations. Milbank reserves the right to make changes in specifications and features shown without notice or obligation.

Air Conditioner Disconnects

30-60 Amp | Fusible & Non-Fusible



U3802



U3812



U3832

Milbank's air conditioner disconnect has a removable hinged cover for ease of installation. Our compact design meets NEC wiring space requirements and also complies with NEC article 440-14. For safe working conditions, our disconnect pullers may be removed and reinstalled in the OFF position. Additionally, padlock provisions are included on the front cover. As with other Milbank products, our enclosure is constructed of G90U galvanized steel and electrostatically finished with an attractive, light gray, baked powder coating. Our epoxy/polyester resin blend offers a finish that is both durable and fade-resistant.

30-60 Amp | 1Ø 240 VAC | Air Conditioner Disconnects

Catalog Number	Amp	Type	Max H.P.	Weight (lbs.)	Line/Load Wire Range		Ground Wire Range CU/AL	Dimensions			Wire Rating	
					CU	AL		D"	W"	H"	CU °C	AL °C
U3802	60	Non-Fusible	10	3.25	#14-#2	#12-#2	#14-4	2½	5	7½	60°/75°	60°/75°
U3812	60	Non-Auto	10	3.25	#14-#2	#12-#2	#14-4	2½	5	7½	60°/75°	60°/75°
U3832	30	Fusible	3	2.5	#14-#3	#14-#3	#14-3	2½	5	7	60°/75°	60°/75°
U3862	60	Fusible	10	3.3	#14-#3	#14-#3	#14-3	2½	5	9	60°/75°	60°/75°

Notes

- UL listed as Enclosed Pullout Switch
- Type 3R rain resistant
- One-inch concentric knockouts

Please consult serving utility for their requirements prior to ordering or installing, as specifications and approvals vary by utility, and may require local electrical inspector approval. All installations must be installed by a licensed electrician and must comply with all national and local codes, laws and regulations. Milbank reserves the right to make changes in specifications and features shown without notice or obligation.



Air Conditioner Disconnects

60 Amp | With 20 Amp GFCI Receptacle



U3822-20GWR

Specifications

- Meets NEC #210.63 requirements
- UL listed as Power Outlet
- Type 3R enclosure
- In-use cover*
- Duplex ground connector
- 1" concentric knockouts
- 1Ø, 240 volt
- 60 amp, non-fused
- 20 amp GFCI receptacle
- Reset/test button
- Weather and tamper resistant
- Meets NEC #406.8 requirements

60 Amp | 1Ø, 240 VAC | Air Conditioner Disconnect with GFCI Receptacle

Catalog Number	Type	Max H.P.	Weight (lbs.)	Line/Load Wire Range		Ground Wire Range CU/AL	Dimensions			Wire Rating	
				CU	AL		D"	W"	H"	CU °C	AL °C
U3822-20GWR	Non-Fusible	10	6	#14-#2	#12-#2	#14-4	4 $\frac{1}{2}$ "	5 $\frac{1}{4}$ "	7 $\frac{1}{2}$ "	60°/75°	60°/75°

Notes

- **Disconnect Pullouts:** To ensure the safest conditions, Milbank disconnect pullouts are reversible so they may be reinstalled in the OFF position.
- **Padlock Provision:** All units are designed with a padlock provision on the cover for security.
- ***In-Use Cover:** Cover is rated as an in-use cover (cover may be closed with cords plugged into receptacle).

Hot Tub Disconnects

Type 3R Enclosures



U4881-O-50GB



U4881-O-60GB

Specifications

- 240 volt ground fault protection
- UL listed, Type 3R rain resistant enclosure
- 2-pole, 50 amp GFCI breaker protection
- Compact size
- Three or four wire installation
- 1Ø, 120/240 VAC
- Standard package of 12
- Two extra one-pole breaker spaces
- 100 amp overall rating
- Easy to install

100 Amp | Hot Tub Disconnect or Sub Panel Breaker Enclosure | Type 3R

Catalog Number	Breaker Amp	Type	Weight (lbs.)	Line/Load Wire Range		Ground Wire Range CU/AL	Dimensions		
				CU	AL		D"	W"	H"
U4881-O	—	Breaker Provision	7	#14-1/0	#14-1/0	#14-1/0	3¾	7½	8½
U4881-O-50GB	50	Breaker	8	#14-1/0	#14-1/0	#14-1/0	3¾	7½	8½
U4881-O-60GB	60	Breaker	8	#14-1/0	#14-1/0	#14-1/0	3¾	7½	8½

Please consult serving utility for their requirements prior to ordering or installing, as specifications and approvals vary by utility, and may require local electrical inspector approval. All installations must be installed by a licensed electrician and must comply with all national and local codes, laws and regulations. Milbank reserves the right to make changes in specifications and features shown without notice or obligation.



Single Position Sockets

30-100 Amp | 4 Terminal | Ring Type

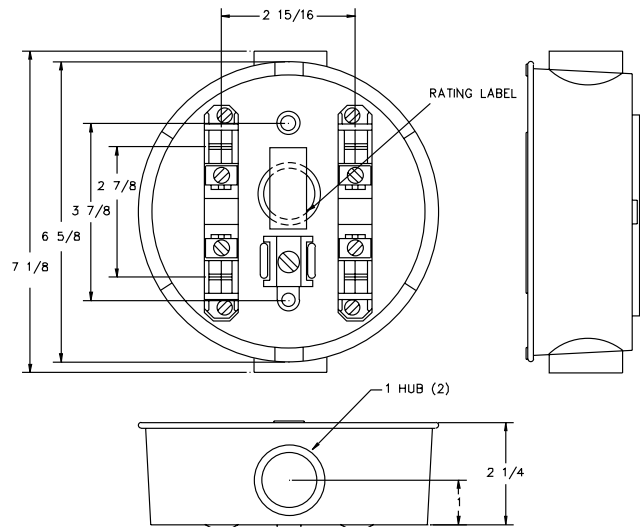

Applications

100 amp max rated is ideal for use on:

- Temporary service
- Outdoor advertising
- Small customer service
- Other low amp requirements

30-100 Amp | 4 Terminal | Economy Cast Socket | Ring Type | Single Position

Catalog Number	Terminal	Service	Hub	Connectors CU/AL		Quantity Per Package	Concentric Knockouts
				Line	Load		
AP2300-03	4	OH/UG	1"	#12-1/0	#12-1/0	12	$\frac{3}{4}$ ", 1"
AP2300-04	4	OH/UG	1 $\frac{1}{4}$ "	#12-1/0	#12-1/0	12	$\frac{3}{4}$ ", 1"

Notes

- **Fifth & Sixth Terminal:** Contact factory.
- **Sealing Ring:** Supplied with a snap action sealing ring.
- **Hub:** Units supplied with cast in hub on top and bottom. Consult factory for availability of other hub sizes.
- **Bypass:** Also available with auto bypass. Contact factory.



Please consult serving utility for their requirements prior to ordering or installing, as specifications and approvals vary by utility, and may require local electrical inspector approval. All installations must be installed by a licensed electrician and must comply with all national and local codes, laws and regulations. Milbank reserves the right to make changes in specifications and features shown without notice or obligation.

Single Position Solar Sockets

100 Amp | 4 Terminal | 600 VAC

1 1
100 AMP
SINGLE
POSITION
SOCKETS



U5934-XL-BLG



U6087-XL-INS



U4175-RL-BLG

100 Amp | 4 Terminal | Residential Solar Sockets | Standard Neutral

Catalog Number	Socket Type	Service	Hub	Connectors CU/AL		Dimensions			Knockouts			
				Line	Load	D"	W"	H"	1	2	3	4
U4175-RL-BLG*	Ringless	OH/UG	H.O.	#12-1/0	#12-1/0	3 ⁵ / ₁₆	8	11 ¹ / ₂	2	1 ¹ / ₂	1 ¹ / ₄	1 ¹ / ₄
U6087-XL*	Ring Type	OH/UG	C.P.	#12-1/0	#12-1/0	3 ⁵ / ₁₆	8	11 ¹ / ₂	2	1 ¹ / ₂	1 ¹ / ₄	1 ¹ / ₄
U6087-XL-INS*	Ring type	OH/UG	C.P.	#12-1/0	#12-1/0	3 ⁵ / ₁₆	8	11 ¹ / ₂	2	1 ¹ / ₂	1 ¹ / ₄	1 ¹ / ₄

100 Amp | 4 Terminal | Residential Solar Sockets | Integral Isolated Neutral Option

Catalog Number	Socket Type	Service	Hub	Connectors CU/AL		Dimensions			Knockouts			
				Line	Load	D"	W"	H"	1	2	3	4
U5929-XL-INS	Ring Type	OH/UG	C.P.	#12-1/0	#12-1/0	3 ⁵ / ₁₆	8	11 ¹ / ₂	2	1 ¹ / ₂	1 ¹ / ₄	1 ¹ / ₄
U5934-XL-BLG	Ringless	OH/UG	C.P.	#12-1/0	#12-1/0	3 ⁵ / ₁₆	8	11 ¹ / ₂	2	1 ¹ / ₂	1 ¹ / ₄	1 ¹ / ₄

Notes

- **BLG:** Barrel lock guard knockout provision.
- **Hubs:** Accepts standard meter socket hubs.
- **Construction:** Units are Type 3R for durable outdoor use, lockable and sealable.
- ***Application:** The standard bonded neutral units are applicable in areas where utility does not require an isolated neutral.

Please consult serving utility for their requirements prior to ordering or installing, as specifications and approvals vary by utility, and may require local electrical inspector approval. All installations must be installed by a licensed electrician and must comply with all national and local codes, laws and regulations. Milbank reserves the right to make changes in specifications and features shown without notice or obligation.



12

125 AMP
SINGLE
POSITION
SOCKETS

Single Position Sockets

125 Amp | 4 & 7 Terminal | Ringless & Ring Type



U7487-RL

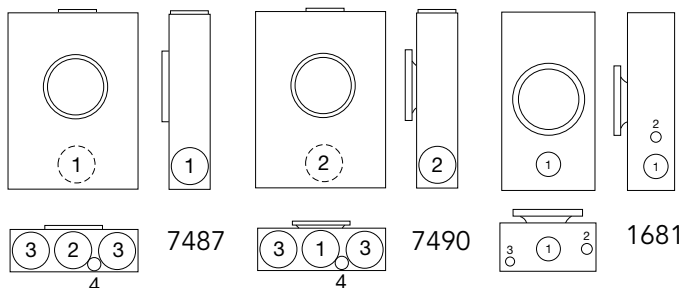

U7490-O

125 Amp | 4 Terminal | Ringless | Single Position

Catalog Number	Terminal	Service	Hub	Connectors CU/AL		Bypass	Dimensions			Knockouts			
				Line	Load		D"	W"	H"	1	2	3	4
U7487-O	4	UG	Blank	#6-2/0	#6-2/0	None	3 ⁵ / ₁₆	8	11 ¹ / ₂	1 ¹ / ₂	2	1 ¹ / ₄	1 ¹ / ₄
U7487-RL	4	OH/UG	H.O.	#6-2/0	#6-2/0	None	3 ⁵ / ₁₆	8	11 ¹ / ₂	1 ¹ / ₂	2	1 ¹ / ₄	1 ¹ / ₄

125 Amp | 4 Terminal | Ring Type | Single Position

Catalog Number	Terminal	Service	Hub	Connectors CU/AL		Bypass	Dimensions			Knockouts					
				Line	Load		D"	W"	H"	1	2	3	4	5	6
U7490-O	4	UG	Blank	#6-2/0	#6-2/0	None	3 ⁵ / ₁₆	8	11 ¹ / ₂	1 ¹ / ₂	1 ¹ / ₂	2	1 ¹ / ₂	—	1 ¹ / ₄
U7490-RL	4	OH/UG	H.O.	#6-2/0	#6-2/0	None	3 ⁵ / ₁₆	8	11 ¹ / ₂	1 ¹ / ₂	1 ¹ / ₂	2	1 ¹ / ₂	—	1 ¹ / ₄

125 Amp | 7 Terminal | Ring Type | Single Position

Catalog Number	Terminal	Service	Hub	Connectors CU/AL		Bypass	Dimensions			Knockouts					
				Line	Load		D"	W"	H"	1	2	3	4	5	6
U1681-RL	7	OH	H.O.	#6-2/0	#6-2/0	None	4 ⁷ / ₁₆	10	18 ¹ / ₂	2	3 ⁴ / ₈	1 ¹ / ₂	—	1 ¹ / ₄ , 1 ¹ / ₂	3 ⁴ / ₈

Notes

- **Fifth Terminal:** For field mounted fifth terminal on the **U7487 & U7490** order catalog number **5T8K2** to fit into round opening at the 9 o'clock position.
- **Hubs:** For proper hub selection see the hub suffix chart on the accessory page.
- **Connectors:** Extruded aluminum connectors are tin plated.
- **Sealing Rings:** Ring type units supplied with an **MR-2** snap action sealing ring as standard.



Please consult serving utility for their requirements prior to ordering or installing, as specifications and approvals vary by utility, and may require local electrical inspector approval. All installations must be installed by a licensed electrician and must comply with all national and local codes, laws and regulations. Milbank reserves the right to make changes in specifications and features shown without notice or obligation.

Single Position Sockets

200 Amp | 4 Terminal | Ringless

13
200 AMP
SINGLE
POSITION
SOCKETS



U7040-XL-TG



U1060-RL



U1980-O

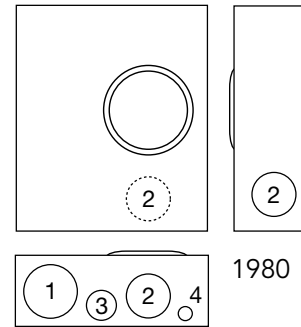
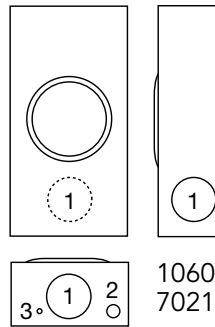
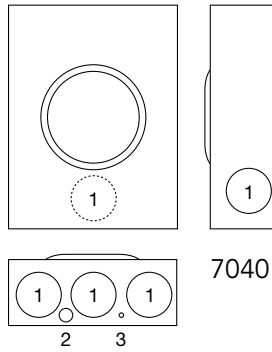

200 Amp | 4 Terminal | Ringless | Single Position

Catalog Number	Terminal	Service	Hub	Connectors CU/AL		Bypass	Dimensions			Knockouts					
				Line	Load		D"	W"	H"	1	2	3	4	5	6
U1060-RL	4	OH	H.O.	#2-350	#2-350	None	4½	8	15½	2	¾	¼	—	—	¼
U1527-O	4	UG	Blank	#2-350	#2-350	None	4½	11	15½	2	½	¼	2½	¼, ½	¼
U1980-O	4	UG	Blank	#6-350	#6-350	None	4½	13	15½	3	2½	¼	½	—	—
U7021-RL-TG	4	OH	H.O.	#6-350	#6-350	None	4½	8	15½	2½	½	¼	—	—	—
U7040-XL-TG	4	OH/UG	C.P.	#6-350	#6-350	None	4½	11	15½	½	¼	2½	—	—	—
U7043-XL-TG	4	OH/UG	C.P.	#6-350	#6-350	None	4½	13	15½	2½	½	¼	—	—	—

Notes

- **Fifth Terminal:** For field mounted fifth terminal order catalog number **K5T** to fit into square opening at the 9 o'clock position.
- **Hubs:** For proper hub selection see the hub suffix chart on accessory page.
- **Connectors:** Extruded aluminum connectors are tin plated.

Please consult serving utility for their requirements prior to ordering or installing, as specifications and approvals vary by utility, and may require local electrical inspector approval. All installations must be installed by a licensed electrician and must comply with all national and local codes, laws and regulations. Milbank reserves the right to make changes in specifications and features shown without notice or obligation.



14

200 AMP
SINGLE
POSITION
SOCKETS

Single Position Sockets

200 Amp | 4 & 7 Terminal | Ring Type



U3328-RXL



U4518-O-W

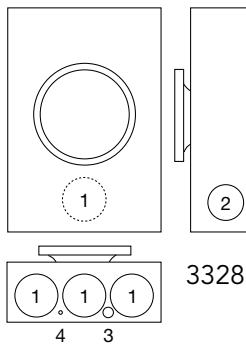

3328

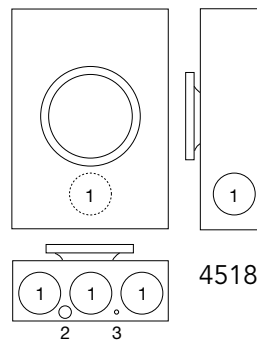

4518

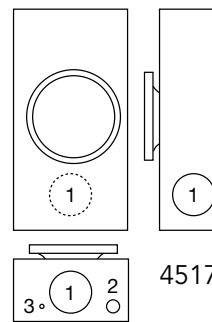

4517

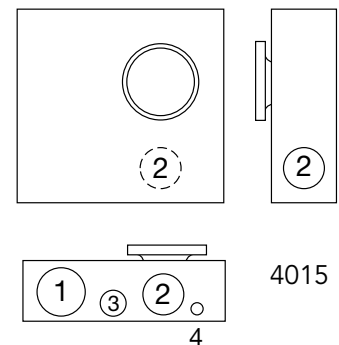

4015

200 Amp | Ring Type | Single Position

Catalog Number	Terminal	Service	Hub	Connectors CU/AL		Bypass	Dimensions			Knockouts			
				Line	Load		D"	W"	H"	1	2	3	4
U4517-DL-M4	4	OH	2"	#6-350	#6-350	None	4½	8	15½	2½	½	¼	—
U4518-XL-W	4	OH/UG	C.P.	#6-350	#6-350	None	4½	11	15½	2½	½	¼	—
U4518-O-W	4	UG	Blank	#6-350	#6-350	None	4½	11	15½	2½	½	¼	—
U4015-O	4	UG	Blank	#6-350	#6-350	None	6	14	16¼	3	2½	1½	½
U3328-RXL	7	OH/UG	C.P.	#6-350	#6-350	None	4¾	13	19	3	2½	½	¼

Notes

- **Fifth Terminal:** For field mounted fifth terminal order catalog number **K5T** to fit into square opening at the 9 o'clock position.
- **Hubs:** For proper hub selection see the hub suffix chart on accessory page.
- **Connectors:** Extruded aluminum connectors are tin plated.
- **Sealing Rings:** The above ring type units are supplied with a **MR-4** screw type sealing ring as standard.



Please consult serving utility for their requirements prior to ordering or installing, as specifications and approvals vary by utility, and may require local electrical inspector approval. All installations must be installed by a licensed electrician and must comply with all national and local codes, laws and regulations. Milbank reserves the right to make changes in specifications and features shown without notice or obligation.

Single Position Sockets

200 Amp | 4 Terminal | Flush Mount | Ring Type

15
200 AMP
SINGLE
POSITION
SOCKETS



UF4518-KO



UF4015-KO

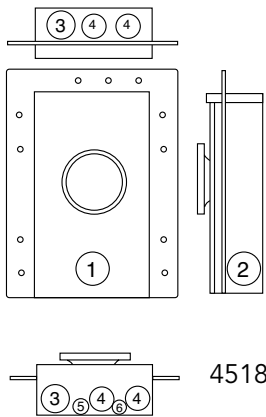

4518

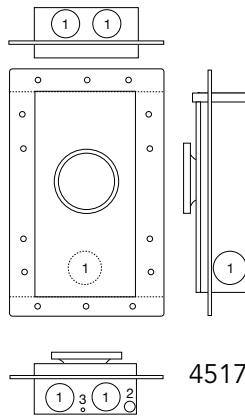

4517

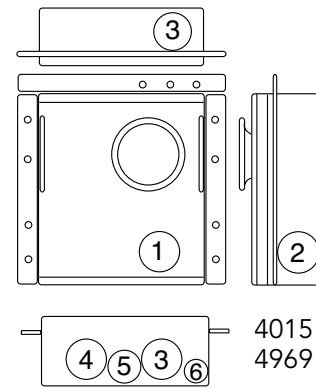

4015
4969

200 Amp | 4 Terminal | Flush Mount | Ring Type | Single Position

Catalog Number	Terminal	Service	Hub	Connectors CU/AL		Bypass	Dimensions			Knockouts					
				Line	Load		D"	W"	H"	1	2	3	4	5	6
UF4517-KO	4	OH	K.O.	#6-350	#6-350	None	5½	8	15½	2	½	¼	—	—	—
UF4518-KO	4	OH/UG	K.O.	#6-350	#6-350	None	5½	11	15½	2	2	2½	2½	½	¼
UF4015-KO	4	UG	K.O.	#6-350	#6-350	None	5	14	16¼	2½	2½	2½	2½	1½	½
UF4969-KO*	4	UG	K.O.	#6-350	#6-350	None	7½	14	16¼	2½	2½	2½	3	1½	½

Notes

- **Fifth Terminal:** For field mounted fifth terminal order catalog number **K5T** to fit into square opening at the 9 o'clock position.
- **Connectors:** Extruded aluminum connectors are tin plated.
- **Sealing Rings:** Ring type units are supplied with a **MR-4** screw type sealing ring as standard.
- * **UF4969** can only be used in a 2 x 6 wall.

Please consult serving utility for their requirements prior to ordering or installing, as specifications and approvals vary by utility, and may require local electrical inspector approval. All installations must be installed by a licensed electrician and must comply with all national and local codes, laws and regulations. Milbank reserves the right to make changes in specifications and features shown without notice or obligation.



16

125-200 AMP
LINK BYPASS
SINGLE
POSITION

Link Bypass Single Position

125-200 Amp | 4 & 7 Terminal | Ring Type



U3504-XL

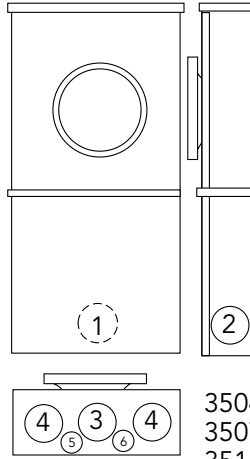

3504
3507
3514
3517



U3517-XL

125 Amp | 4 & 7 Terminal | Ring Type | Link Bypass | Single Position

Catalog Number	Terminal	Service	Hub	Connectors CU/AL		Dimensions			Knockouts					
				Line	Load	D"	W"	H"	1	2	3	4	5	6
U3504-XL	4	OH/UG	C.P.	#6-2/0	#6-2/0	4 ⁷ / ₈	10	18 ¹ / ₂	2	2	2	2	1/4	—
U3507-XL	7	OH/UG	C.P.	#6-2/0	#6-2/0	4 ⁷ / ₈	10	21	2	2	2	2	1/4	—

200 Amp | 4 & 7 Terminal | Ring Type | Link Bypass | Single Position

Catalog Number	Terminal	Service	Hub	Connectors CU/AL		Dimensions			Knockouts					
				Line	Load	D"	W"	H"	1	2	3	4	5	6
U3514-XL	4	OH/UG	C.P.	#6-350	#6-350	4 ⁷ / ₈	13	21	2 ¹ / ₂	2 ¹ / ₂	3	3	1/4	1/2
U3517-XL	7	OH/UG	C.P.	#6-350	#6-350	4 ⁷ / ₈	13	24 ¹ / ₂	2 ¹ / ₂	2 ¹ / ₂	2 ¹ / ₂	2 ¹ / ₂	1/4	1/2

Notes

- **Fifth Terminal:** For field mounted fifth terminal, order catalog number **5T8K2** for the **U3504**; order **K5T** for the **U3514**.
- **Connectors:** Extruded aluminum connectors are tin plated.
- **Sealing Rings:** Ring type units supplied with an **MR-4** screw type sealing ring as standard.
- **Link Bypass:** Links provided by utility.



Please consult serving utility for their requirements prior to ordering or installing, as specifications and approvals vary by utility, and may require local electrical inspector approval. All installations must be installed by a licensed electrician and must comply with all national and local codes, laws and regulations. Milbank reserves the right to make changes in specifications and features shown without notice or obligation.

Lever Bypass Single Position

200 Amp | 4 & 5 Terminal | Ringless

17
200 AMP
LEVER BYPASS
SINGLE
POSITION

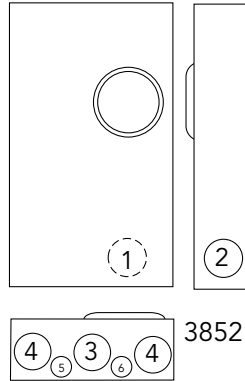

U3852-XL

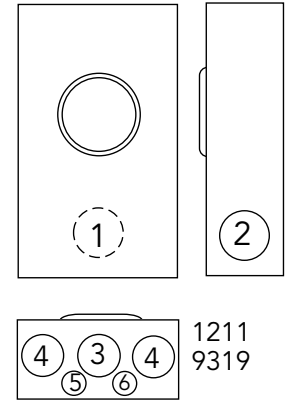

U9319-XL

200 Amp | 4 Terminal | Ringless | Non-Jaw Clamping Lever Bypass | Single Position | 1Ø3W

Catalog Number	Terminal	Service	Hub	Connectors CU/AL		Bypass	Dimensions			Knockouts					
				Line	Load		D"	W"	H"	1	2	3	4	5	6
U3852-XL	4	OH/UG	C.P.	#2-350	#2-350	Lever	4 $\frac{7}{8}$	13	19	3	2 $\frac{1}{2}$	2 $\frac{1}{2}$	2 $\frac{1}{2}$	¼	½

Notes

- **Fifth Terminal:** Fifth terminal is not available for this unit.
- **Triplex Ground:** Factory installed as standard.

200 Amp | 4 & 5 Terminal | Ringless | Non-Jaw Clamping Lever Bypass | Single Position | 1Ø3W or 3Ø3W

Catalog Number	Terminal	Service	Hub	Connectors CU/AL		Bypass	Dimensions			Knockouts					
				Line	Load		D"	W"	H"	1	2	3	4	5	6
U1211-RXL	4	OH/UG	C.P.	#6-350	#6-350	Lever	4 $\frac{7}{8}$	13	19	3	2 $\frac{1}{2}$	3	3	¼	½
U9319-XL	5	OH/UG	C.P.	#6-350	#6-350	Lever	4 $\frac{7}{8}$	13	19	3	2 $\frac{1}{2}$	3	3	¼	½

Notes

- **Fifth Terminal:** For field mounted fifth terminal, order as extra **K3866** for the **U1211**.
- **Hubs:** For proper hub selection see the hub suffix chart on accessory page.
- **Bypass:** 200 amp continuous duty bypass. Lever operates bypass only. Not jaw clamping.
- **Connectors:** Units are supplied with extruded aluminum connectors and bonded, triplex neutral.

Please consult serving utility for their requirements prior to ordering or installing, as specifications and approvals vary by utility, and may require local electrical inspector approval. All installations must be installed by a licensed electrician and must comply with all national and local codes, laws and regulations. Milbank reserves the right to make changes in specifications and features shown without notice or obligation.



Lever Bypass Single Position

125-200 Amp | 7 Terminal | Ringless



U7573-RL

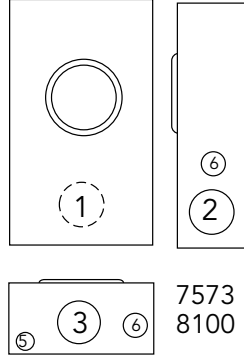

U7422-RXL

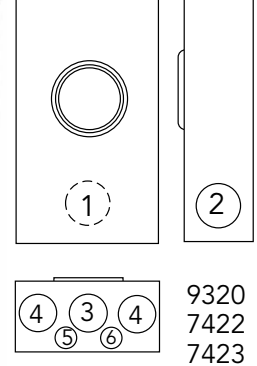

7 Terminal | Ringless | No Bypass | Single Position | 3Ø4W

Catalog Number	Amp	Terminal	Service	Hub	Connectors CU/AL		Bypass	Dimensions			Knockouts					
					Line	Load		D"	W"	H"	1	2	3	4	5	6
U8100-RL	125	7	OH	H.O	#6-2/0	#6-2/0	None	4 $\frac{7}{8}$	10	18 $\frac{1}{2}$	2	2	2	—	1/2	3/4
U7422-RXL	200	7	OH/UG	C.P.	#6-350	#6-350	None	4 $\frac{7}{8}$	13	19	3	2 $\frac{1}{2}$	3	3	1/4	1/2

7 Terminal | Ringless | Non-Jaw Clamping Lever Bypass | Single Position | 3Ø4W

Catalog Number	Amp	Terminal	Service	Hub	Connectors CU/AL		Bypass	Dimensions			Knockouts					
					Line	Load		D"	W"	H"	1	2	3	4	5	6
U7573-RL	125	7	OH	H.O.	#6-2/0	#6-2/0	Lever	4 $\frac{7}{8}$	10	18 $\frac{1}{2}$	2	2	2	—	1/2	3/4
U9320-RXL	125	7	OH/UG	C.P.	#6-2/0	#6-2/0	Lever	4 $\frac{7}{8}$	10	19	3	2 $\frac{1}{2}$	3	3	1/4	1/2
U7423-RXL	200	7	OH/UG	C.P.	#6-350	#6-350	Lever	4 $\frac{7}{8}$	13	19	3	2 $\frac{1}{2}$	3	3	1/4	1/2

Notes

- **Hubs:** For proper hub selection see the hub suffix chart on accessory page.
- **Bypass:** 200 amp continuous duty bypass. Lever operates bypass only. Not jaw clamping.
- **Connectors:** Extruded aluminum connectors are tin plated. Units supplied with bonded, duplex neutral.



Please consult serving utility for their requirements prior to ordering or installing, as specifications and approvals vary by utility, and may require local electrical inspector approval. All installations must be installed by a licensed electrician and must comply with all national and local codes, laws and regulations. Milbank reserves the right to make changes in specifications and features shown without notice or obligation.

Lever Bypass Single Position

200 Amp | 4, 5 & 7 Terminal | Ringless

19
200 AMP
LEVER BYPASS
SINGLE
POSITION



U9701-RXL

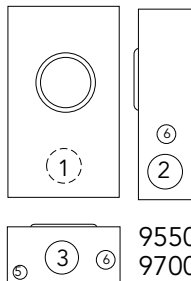

U9800-RRL

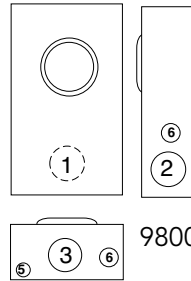

U9551-RXL

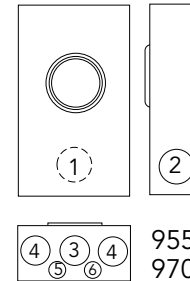

200 Amp | 4 Terminal | Ringless | Jaw Clamping Lever Bypass | Single Position | 1Ø3W or 3Ø3W

Catalog Number	Terminal	Service	Hub	Connectors CU/AL		Bypass	Dimensions			Knockouts					
				Line	Load		D"	W"	H"	1	2	3	4	5	6
U9800-RRL*	4	OH	H.O.	#6-350	#6-350	Lever	4 $\frac{7}{8}$	10	18 $\frac{1}{2}$	3	2 $\frac{1}{2}$	3	—	$\frac{1}{2}$	$\frac{3}{4}$
U9801-RXL*	4	OH/UG	C.P.	#6-350	#6-350	Lever	4 $\frac{7}{8}$	13	19	3	2 $\frac{1}{2}$	3	3	$\frac{1}{4}$	$\frac{1}{2}$

200 Amp | 5 Terminal | Ringless | Jaw Clamping Lever Bypass | Single Position | 1Ø3W or 3Ø3W

Catalog Number	Terminal	Service	Hub	Connectors CU/AL		Bypass	Dimensions			Knockouts					
				Line	Load		D"	W"	H"	1	2	3	4	5	6
U9550-RRL	5	OH	H.O.	#6-350	#6-350	Lever	4 $\frac{7}{8}$	10	18 $\frac{1}{2}$	3	2 $\frac{1}{2}$	3	—	$\frac{1}{2}$	$\frac{3}{4}$
U9551-RXL	5	OH/UG	C.P.	#6-350	#6-350	Lever	4 $\frac{7}{8}$	13	19	3	2 $\frac{1}{2}$	3	3	$\frac{1}{4}$	$\frac{1}{2}$

200 Amp | 7 Terminal | Ringless | Jaw Clamping Lever Bypass | Single Position | 3Ø4W

Catalog Number	Terminal	Service	Hub	Connectors CU/AL		Bypass	Dimensions			Knockouts					
				Line	Load		D"	W"	H"	1	2	3	4	5	6
U9700-RRL	7	OH	H.O.	#6-350	#6-350	Lever	4 $\frac{7}{8}$	10	18 $\frac{1}{2}$	3	2 $\frac{1}{2}$	3	—	$\frac{1}{2}$	$\frac{3}{4}$
U9701-RXL	7	OH/UG	C.P.	#6-350	#6-350	Lever	4 $\frac{7}{8}$	13	19	3	2 $\frac{1}{2}$	3	3	$\frac{1}{4}$	$\frac{1}{2}$

Notes

- **Hubs:** For proper hub selection see the hub suffix chart on accessory page.
- **Bypass:** Lever supplies clamping action and also operates bypass device.
- **Connectors:** Extruded aluminum connectors are tin plated. **U9550** and **U9551** units are supplied with duplex neutral, with removable bonding strap for insulated neutral. **U9700** series units are supplied with duplex neutral.
- * Internal Hex Connectors. For main and/or service disconnect, use with **U5484-O** enclosed circuit breaker.

Please consult serving utility for their requirements prior to ordering or installing, as specifications and approvals vary by utility, and may require local electrical inspector approval. All installations must be installed by a licensed electrician and must comply with all national and local codes, laws and regulations. Milbank reserves the right to make changes in specifications and features shown without notice or obligation.



Lever Bypass Single Position

320 Amp | 4 Terminal | Ringless



U1797-O-K3L-K2L

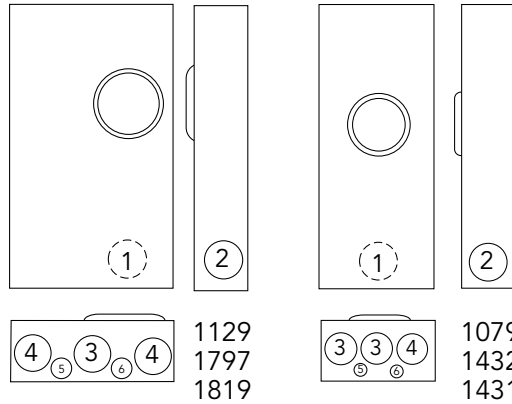

U1129-O-K3L-K2L

320 Amp | 4 Terminal | Ringless | Lever Bypass | Single Position

Catalog Number	Terminal	Service	Hub	Connectors CU/AL		Bypass	Dimensions			Knockouts					
				Line	Load		D"	W"	H"	1	2	3	4	5	6
U1079-R	4	OH	H.O.	3/8" x 16 Studs		Lever	4 7/8	13	38 3/4	3 1/2	2 1/2	3	3	1/4	1/2
U1431-R*	4	OH/UG	H.O.	3/8" x 16 Studs		None	4 7/8	13	38 3/4	3 1/2	2 1/2	3	3	1/4	1/2
U1129-O-K3L-K2L	4	UG	Blank	(1) #4-600 or (2) 1/0-250	Twin #6-350	Lever	4 7/8	15	30	3	2 1/2	3	3	1/4	1/2
U1432-O*	4	UG	Blank	3/8" x 16 Studs		None	4 7/8	13	29 3/4	3 1/2	2 1/2	3	3	1/4	1/2
U1819-X*	4	UG	C.P.	3/8" x 16 Studs		None	4 7/8	15	30	3	3	3	3	1/4	1/2
U1797-O-K3L-K2L	4	UG	Blank	(1) #4-600 or (2) 1/0-250	Twin #6-35	Lever	4 7/8	15	30	3	3	3	3	1/4	1/2

Notes

- **Hubs:** For proper hub selection, see the hub suffix chart on the accessory page.
- ***Bypass:** Lever supplies clamping action on meter spades only on the **U1431**, **U1432** and **U1819**. Lever supplies clamping action and also operates bypass device on the **U1079**, **U1129** & **U1797**.
- **Connector Kits:** Stud type units are supplied with 3/8" x 16 hex head nuts with Belleville washers. Order two connector kits to cover both line and load. Order **K1539** (single #350), **K1540** (single #600) or **K1350** (twin #350). See accessories page.
Note: The **U1129** unit has a single connector on the line side only.
- **Fifth Terminal:** For field mounted fifth terminal, order as extra **K3866** for the **U1079** & **U1431**. Order as extra K3865 for units **U1129**, **U1432**, **U1819**, and **U1797**.
- **Lug Size Range:** See accessories page for lug size range for the U1129 & U1797 units.



Please consult serving utility for their requirements prior to ordering or installing, as specifications and approvals vary by utility, and may require local electrical inspector approval. All installations must be installed by a licensed electrician and must comply with all national and local codes, laws and regulations. Milbank reserves the right to make changes in specifications and features shown without notice or obligation.

Link Bypass Single Position

320 Amp | 4 Terminal | Ring Type

21
320 AMP
LINK BYPASS
SINGLE
POSITION



U3548-X

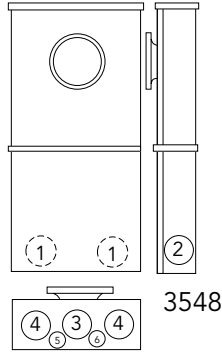

U5056-O

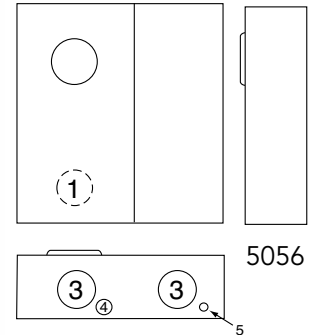

320 Amp | 4 Terminal | Ring Type | Link Bypass | Single Position | 1Ø3W

Catalog Number	Terminal	Service	Hub	Connectors CU/AL		Bypass	Dimensions			Knockouts					
				Line	Load		D"	W"	H"	1	2	3	4	5	6
U3548-X*	4	OH/UG	C.P.	Single = 4-600 Parallel = 1/0-250		Link	6	14	33	3	3	3	3	¼	½
U5056-O	4	UG	Blank	1/2"x13 Studs	#4-600 or Twin 1/0-250	Link	6	24	32	3	—	4	½	¼	—

Notes

- **Sealing Ring:** Ring type units are supplied with an **MR-4**, screw type, sealing ring as standard.
- **Triple Tap Lug:** For triple tap lug kit order **K5049**, wire range **#6-250** kcmil.
- **Link Bypass:** Links provided by utility.
- * **Flush Mount Kit:** For field mounted flush mount kit order **K4086**.

Please consult serving utility for their requirements prior to ordering or installing, as specifications and approvals vary by utility, and may require local electrical inspector approval. All installations must be installed by a licensed electrician and must comply with all national and local codes, laws and regulations. Milbank reserves the right to make changes in specifications and features shown without notice or obligation.



Lever Bypass Single Position

320 Amp | 7 Terminal | Ringless



U2120-X

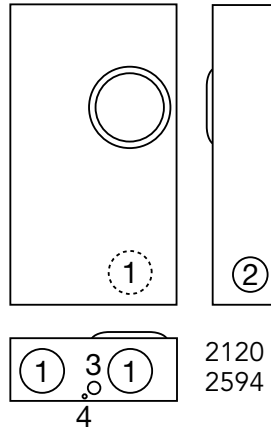

U2827-X

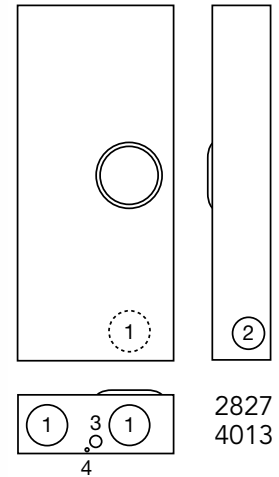

320 Amp | 7 Terminal | Ringless | Lever Bypass | Single Position | Side Wireway

Catalog Number	Terminal	Service	Hub	Connectors CU/AL		Bypass	Dimensions			Knockouts			
				Line	Load		D"	W"	H"	1	2	3	4
U4013-X	7	OH/UG	C.P.	3/8"x16 Studs		Lever	6½	19	34½	4	3	1	¼
U2594-X	7	OH/UG	C.P.	3/8"x16 Studs		Lever	6½	19¾	34½	4	3	1	¼
U2827-X*	7	OH/UG	C.P.	3/8"x16 Studs		non-bypass	6½	17¾	31	4	3	1	¼
U2120-X	7	UG	C.P.	3/8"x16 Studs		Lever	6½	17¾	31¾	4	3	1	¼

Notes

- **Bypass:** Lever supplies clamping action on meter spades and operates bypass device.
- *U2827 has lever with jaw clamping capabilities but no bypass.
- **Connector Kits:** Stud type units are supplied with 3/8"x16 hex head nuts with Belleville washers. Order two connector kits to cover both line and load. For single lug connector kits for the U2120 and U2594 units, order as extra K3082 (350 kcmil) or K3441 (600 kcmil). For twin lug connectors order as extra: K3442 (350 kcmil). Separate kits are required for both line and load.



Please consult serving utility for their requirements prior to ordering or installing, as specifications and approvals vary by utility, and may require local electrical inspector approval. All installations must be installed by a licensed electrician and must comply with all national and local codes, laws and regulations. Milbank reserves the right to make changes in specifications and features shown without notice or obligation.

Service Entrance

100-200 Amp | 4 Terminal | Main Breaker

23
SERVICE
ENTRANCE



USE-AP-200-ML

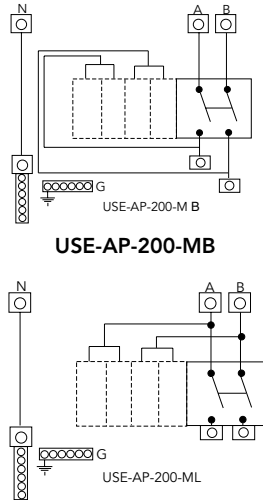
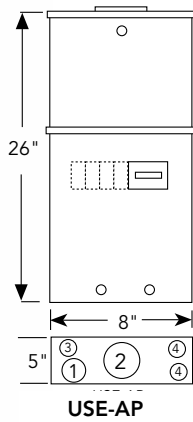

USE-AP-200-ML

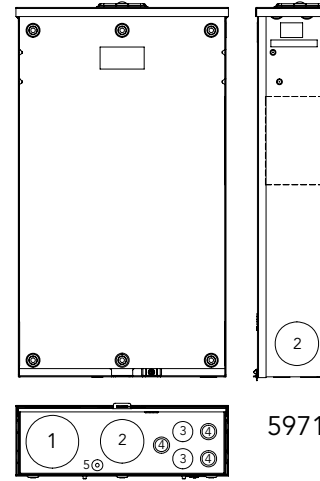

5971



U5971-XL-100



U5971-XL-200

200 Amp | Breaker Enclosure | 1Ø3W | 120/240 Volt | 10K AIC Rating

Catalog Number	Terminal	Service	Hub	Connectors CU/AL		Dimensions			Knockouts			
				Line	Load	D"	W"	H"	1	2	3	4
USE-AP-200-MB	4	OH	2"	#4-250	#4-250	5	8	26	1	2	¾	¾
USE-AP-200-ML	4	OH	2"	#4-250	#4-250	5	8	26	1	2	¾	¾

Notes

- **USE-AP-200-MB:** 200 amp main wired in series with plug-in style bus. **UQFP-M-200** factory installed. Additional 4 branch circuits available for (1) two-pole and (2) one-pole, or (4) one pole breakers. **One 2" hub included.**
- **USE-AP-200-ML:** 200 amp main wired in series with plug-in style bus. **UQFP-200** factory installed. Additional 4 branch circuits available for (1) two-pole and (2) one-pole, or (4) one pole breakers. **One 2" hub included.**

100-200 Amp | Load Center with Main Breaker | 120/240V

Catalog Number	Main Breaker Amp	Branch Circuits	Service	Hub	Dimensions			Knockouts				
					D"	W"	H"	1	2	3	4	5
U5971-XL-100	100	10	OH/UG	C.P.	4½	14⅞	25⅙	3	2½	1	½,¾	¼,½
U5971-XL-200	200	8	OH/UG	C.P.	4½	14⅞	25⅙	3	2½	1	½,¾	¼,½

Notes

- **AIC Rating:** 22K AIC rating.
- **Line Terminals:** As specified on circuit breaker (300 kcmil max).
- **Load Terminals:** As specified on circuit breakers (#1 AWG max).
- **Breaker Interlock:** Order **K5815** for 200A or 150A to 100A breakers (large frame to small frame). Order **K5820** for 200A or 150A to 200A or 150A breakers (large frame to large frame). Order **K5830** for 100A to 100A (small frame to small frame).

Please consult serving utility for their requirements prior to ordering or installing, as specifications and approvals vary by utility, and may require local electrical inspector approval. All installations must be installed by a licensed electrician and must comply with all national and local codes, laws and regulations. Milbank reserves the right to make changes in specifications and features shown without notice or obligation.





U3574-RL-200

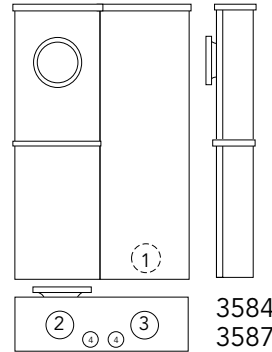

3584
3587

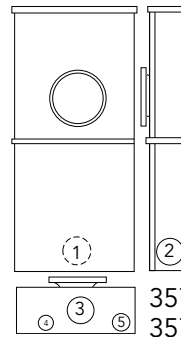

3574
3577

200 Amp | 4 Terminal | Ring Type | 240 Volt

Catalog Number	Terminal	Service	Breaker	Connectors CU/AL		Dimensions			Knockouts					
				Line	Load	D"	W"	H"	1	2	3	4	5	6
U3574-RL-200	4	OH	200A-2P	#2-350	#3-300	4 $\frac{1}{8}$	8	30	2	2	2 $\frac{1}{2}$	$\frac{1}{4}$	$\frac{1}{2}$	—
U3584-O-200	4	UG	200A-2P	#6-350	#3-300	5 $\frac{1}{2}$	14 $\frac{1}{8}$	26	3	3	3	$\frac{1}{2}$	—	—

200 Amp | 7 Terminal | Ring Type | 240 Volt

Catalog Number	Terminal	Service	Breaker	Connectors CU/AL		Dimensions			Knockouts					
				Line	Load	D"	W"	H"	1	2	3	4	5	6
U3577-RL-200	7	OH	200A-3P	#2-350	#3-300	4 $\frac{7}{8}$	10	34	2	2	2 $\frac{1}{2}$	$\frac{1}{4}$	$\frac{1}{2}$	—
U3587-O-200	7	UG	200A-3P	#6-350	#3-300	5 $\frac{1}{2}$	14 $\frac{1}{8}$	26	3	3	3	$\frac{1}{2}$	—	—

Notes

- **Breakers:** Units are supplied with bolt-on 200 amp circuit breakers where specified above.
- **Sealing Rings:** Units are supplied with an **MR-4** screw type sealing ring.



Please consult serving utility for their requirements prior to ordering or installing, as specifications and approvals vary by utility, and may require local electrical inspector approval. All installations must be installed by a licensed electrician and must comply with all national and local codes, laws and regulations. Milbank reserves the right to make changes in specifications and features shown without notice or obligation.

Meter Main with Load Center

100–200 Amp | 4 & 5 Terminal | Ringless & Ring Type

25
100-200 AMP
METER MAINS

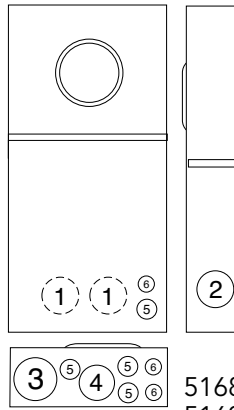

5168 5268
5169 5269



Generator Interlock



K5815 - large QN with small frame Q

K5820 - large frame QN with large frame QN

K5830 - small frame Q to small frame Q

U5168-XTL-200

U5268-XTL-200-KK

100–200 Amp | Meter Mains | 120/240 Volts | 1Ø3W | Overhead/Underground

Catalog Number	Terminal	Amp	Circuits	Hub	Connectors Line	Bypass	Dimensions			Knockouts					
							D"	W"	H"	1	2	3	4	5	6
U5168-XTL-100*	4	100	10	C.P.	#6-350	None	4½	14⅞	32	2	2	3	2½	1	¾
U5168-XTL-150*	4	150	8	C.P.	#6-350	None	4½	14⅞	32	2	2	3	2½	1	¾
U5168-XTL-200*	4	200	8	C.P.	#6-350	None	4½	14⅞	32	2	2	3	2½	1	¾
U5168-XTL-100-KK*	4	100	10	C.P.	#6-350	Horn	4½	14⅞	32	2	2	3	2½	1	¾
U5168-XTL-150-KK*	4	150	8	C.P.	#6-350	Horn	4½	14⅞	32	2	2	3	2½	1	¾
U5168-XTL-200-KK*	4	200	8	C.P.	#6-350	Horn	4½	14⅞	32	2	2	3	2½	1	¾
U5168-XTL-100-KK-5T*	5	100	10	C.P.	#6-350	Horn	4½	14⅞	32	2	2	3	2½	1	¾
U5168-XTL-150-KK-5T*	5	150	8	C.P.	#6-350	Horn	4½	14⅞	32	2	2	3	2½	1	¾
U5169-XTL-100	4	100	10	C.P.	#6-350	None	4½	14⅞	32	2	2	3	2½	1	¾
U5169-XTL-150	4	150	8	C.P.	#6-350	None	4½	14⅞	32	2	2	3	2½	1	¾
U5169-XTL-200	4	200	8	C.P.	#6-350	None	4½	14⅞	32	2	2	3	2½	1	¾
U5268-XTL-150*	4	150	20	C.P.	#6-350	None	4½	14⅞	32	2	2	3	2½	1	¾
U5268-XTL-200*	4	200	20	C.P.	#6-350	None	4½	14⅞	32	2	2	3	2½	1	¾
U5268-XTL-150-KK*	4	150	20	C.P.	#6-350	Horn	4½	14⅞	32	2	2	3	2½	1	¾
U5268-XTL-200-KK*	4	200	20	C.P.	#6-350	Horn	4½	14⅞	32	2	2	3	2½	1	¾
U5269-XTL-200	4	200	20	C.P.	#6-350	None	4½	14⅞	32	2	2	3	2½	1	¾

Notes

- **Hubs:** Supplied with (2) closing plates packed inside. Order hubs as a separate item. See accessory page for hub options.
- **Interior:** U5168 units have 8-circuit interior; U5268 units have 20-circuit interior
- **Fifth Terminal:** Order K5T and field install for 208Y/120 network systems. Installs in the 9 o'clock position only.
- **Branch Breakers:** Series rated 22K AIC with Milbank QNR2200H main installed.
- **Interlock Kit:** For generator auxiliary circuit breaker interlock, order K5815 for large QN with small frame Q; order K5820 for large frame QN with large frame QN; order K5830 for small frame Q with small frame Q.
- **Sub-Feed Lugs:** #6-350 kcmil sub-feed lugs provided on 8 and 10 circuit interior. **Not available on 20 circuit interior.**
- Amp rating limited to main breaker rating.

* Ringless

Please consult serving utility for their requirements prior to ordering or installing, as specifications and approvals vary by utility, and may require local electrical inspector approval. All installations must be installed by a licensed electrician and must comply with all national and local codes, laws and regulations. Milbank reserves the right to make changes in specifications and features shown without notice or obligation.



Heavy Duty Lever Bypass Meter Mains

320 Amp | 4 Terminal | Ringless



U5059-X-2/200

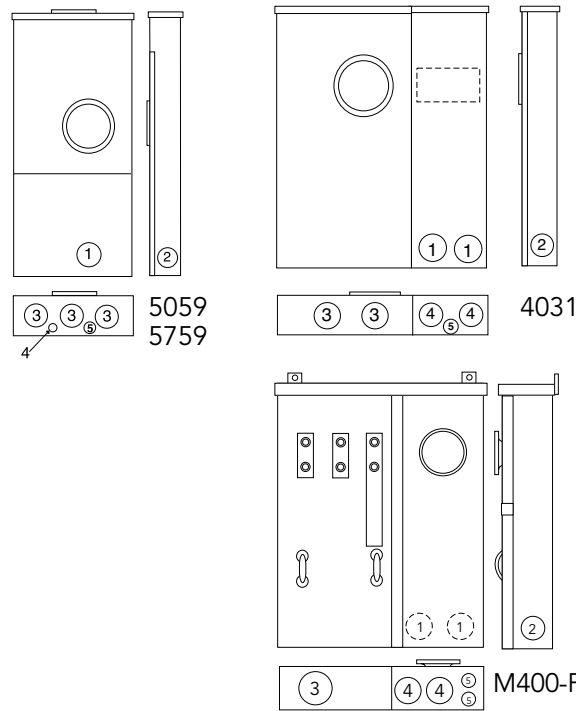

U4031-O-2/200

320 Amp | 4 Terminal | Ringless | 1Ø3W | 22K AIC Rating

Catalog Number	Terminal	Service	Primary Disconnect	Secondary Disconnect	Bypass	Dimensions			Knockouts				
						D"	W"	H"	1	2	3	4	5
U5759-X-2/200*2	4	OH/UG	200 Amp/2 Pole Circuit Breaker	200 Amp/2 Pole Circuit Breaker	None	4 ⁷ / ₈	15	42	2 ¹ / ₂	2 ¹ / ₂	3	¼	½
U5059-X-2/200 ²	4	OH/UG	200 Amp/2 Pole Circuit Breaker	200 Amp/2 Pole Circuit Breaker	Lever	4 ⁷ / ₈	15	42	2 ¹ / ₂	2 ¹ / ₂	3	¼	½
U4031-O-2/200 ²	4	UG	200 Amp/2 Pole Circuit Breaker	200 Amp/2 Pole Circuit Breaker	Lever	5 ³ / ₄	25	30	3	3	4	3	½
M400-PAR-UG**1	4	UG	200 Amp/2 Pole Circuit Breaker	See Note¹	Lever	6 ¹ / ₈	22 ¹ / ₈	36	2	2	4	2	¾

Notes

- **Amperage Rating:** 400 amp, 320 amp continuous.
- **Neutral:** Bonded neutral and ground factory installed.
- **Flush Mount:** Flush mounting available on underground units. Order catalog number **FK-M400-UG** separately.
- **Short Circuit Current Withstand Rating:** 22K AIC Standard.
- **Bypass:** Lever supplies clamping action and operates bypass device.
- **Fifth Terminal:** For field installed fifth terminal for the **U5059** & **U5759**, order separately catalog number **K3866**.
- **Conversion Kit:** To field convert **M400** UG units to OH, order **K4787-F**. Includes connectors (#2-600).

¹ 200 amp primary disconnect factory installed. Order secondary disconnect separately. Specify **UQFPH-100, 125, 150, 175** or **200**.

² **Line Side Connector Kits:** Two 1/2" studs per phase on 1-3/4" centers. Factory installed for the **U5759**, for the **U5059** order anti-rotation connector kit **K1540L** to accommodate #4-600 kcmil single or **K1350L** for twin 350 kcmil connectors.

* Lever supplies clamping action only—does NOT operate bypass on the **U5759**.

** **Lug Kit:** Mechanical lug kit available for **M400-APS-UG**, order **K4920** (#2-500).



Please consult serving utility for their requirements prior to ordering or installing, as specifications and approvals vary by utility, and may require local electrical inspector approval. All installations must be installed by a licensed electrician and must comply with all national and local codes, laws and regulations. Milbank reserves the right to make changes in specifications and features shown without notice or obligation.

Meter Main with Split Load

320 Amp | 4 Terminal | Ring Type

27
320 AMP
METER MAINS



M400-APS-BS

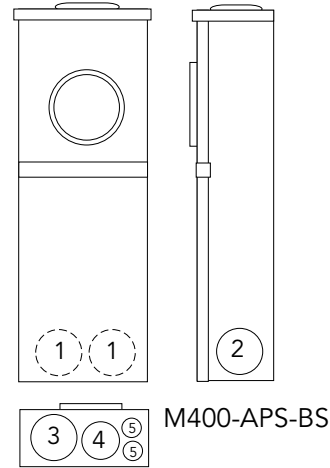

320 Amp | 4 Terminal | Ring Type | 1Ø3W | Type 3R | 120/240 Volt

Catalog Number	Terminal	Service	Primary Disconnect	Secondary Disconnect	Bypass	Dimensions			Knockouts					
						D"	W"	H"	1	2	3	4	5	6
M400-APS	4	OH	200 Amp/2 Pole Circuit Breaker	See Note ¹	None	6 ¹ / ₈	9 ¹ / ₂	47 ¹ / ₈	2	2	2	1 ¹ / ₂	3/4	—
M400-APS-BS	4	OH	200 Amp/2 Pole Circuit Breaker	See Note ¹	Link	6	11 ¹ / ₂	47	2 ¹ / ₂	2 ¹ / ₂	3	3	3/4	—

Notes

- **Amperage Rating:** 400 amp, 320 amp continuous.
- **Neutral:** Bonded neutral and ground factory Installed.
- **Line Side Connectors:** Connectors provided for 4-600 or twin 1/0-250.
- **Overhead:** Overhead units include one 3" hub.

¹ 200 amp primary disconnect factory installed. Order secondary disconnect separately. Specify **UQFPH-100, 125, 150, 175** or **200**.

Please consult serving utility for their requirements prior to ordering or installing, as specifications and approvals vary by utility, and may require local electrical inspector approval. All installations must be installed by a licensed electrician and must comply with all national and local codes, laws and regulations. Milbank reserves the right to make changes in specifications and features shown without notice or obligation.



Meter Main with Split Load

320 Amp | 4 Terminal | Ring Type



M400-UG-APS-F

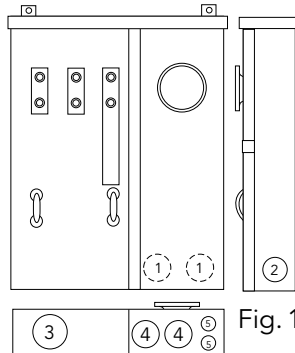

Fig. 1

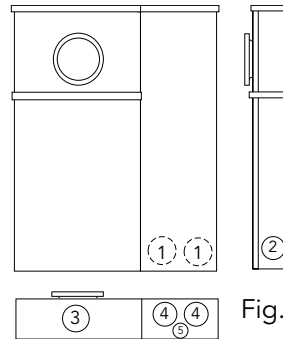

Fig. 2



U3251-O-200-CB

320 Amp | 4 Terminal | Ring Type | 1Ø3W | Type 3R | 120/240 VAC

Catalog Number	Terminal	Service	Primary Disconnect	Secondary Disconnect	Bypass	Dimensions			Knockouts					Fig.
						D"	W"	H"	1	2	3	4	5	
M400-UG-APS-F ¹	4	UG	200 Amp/2 Pole Circuit Breaker	See Note ¹	None	6½	22½	36	2	2	4	2	¾	1
M400-UG-APS-F-BS ¹	4	UG	200 Amp/2 Pole Circuit Breaker	See Note ¹	Link	6	29	41⅞	2	2	4	2	¾	1
M400-UG-APS-P ²	4	UG	200 Amp 2 Pole-T-Fuse	200 Amp 2 Pole-T-Fuse	None	6½	22½	36	2	2	4	2	¾	1
M400-UG-APS-LC ⁴	4	UG	200 Amp/2 Pole Circuit Breaker	200 Amp/2 Pole Circuit Breaker	None	6	29	41⅞	2½	1	4	2½	¾	2
M400-UG-APS-LC-BS ⁴	4	UG	200 Amp/2 Pole Circuit Breaker	200 Amp/2 Pole Circuit Breaker	Link	6	29	41⅞	2½	1	4	2½	¾	2
U3251-O-200-CB ³	4	UG	200 Amp/2 Pole Circuit Breaker	200 Amp/2 Pole Circuit Breaker	Link	6¾	24	40¼	3	3	4	3	⅞	2

Notes

- **Amperage Rating:** 400 amp, 320 amp continuous.
- **EUSERC:** Meets EUSERC requirements. Consult local utility for acceptability before ordering or installing.
- **Neutral:** Bonded neutral and ground factory installed.
- **Line Side Connectors:** Two 1/2" studs per phase on 1-3/4" centers.
- **Load Side Connectors:** 1/0-300
- **Flush Mount:** Flush mount kit included with M400-UG-APS-F, M400-UG-APS-FBS, M400-UG-APS-LC and M400-UG-APS-LC-BS. Available for other underground units. Order catalog number **FK-M400-UG** separately.
- **Short Circuit Current Withstand Rating:** 22K AIC standard, 200k aic standard on T-fuse models.
- **Lug Kit:** Mechanical lug kit available, order **K4920** (#2-500).
- **Conversion Kit:** To field convert M400 UG units to OH, order **K4787-F**.

¹ 200 amp primary disconnect factory installed. Order secondary disconnect separately. Specify **UQFPH-100, 125, 150, 175** or **200**.

² Two 200 amp T-fuse pull-outs factory installed as primary and secondary disconnects.

³ Two 200 amp 2-pole bolt-on **UQFBH** main breakers factory installed.

⁴ **Breakers:** Two 200 amp 2-pole main breakers factory installed, and semi-flush flange kit packed inside meter section. Universal Copper 24/40 Circuit interior accepts Challenger, GE, Murray, Siemens/ITE, and Cutler-Hammer/Westinghouse universal type plug-in branch circuit breakers.



Please consult serving utility for their requirements prior to ordering or installing, as specifications and approvals vary by utility, and may require local electrical inspector approval. All installations must be installed by a licensed electrician and must comply with all national and local codes, laws and regulations. Milbank reserves the right to make changes in specifications and features shown without notice or obligation.

Meter Main Combination

320 Amp | 4 Terminal | Ring Type



M401-UG

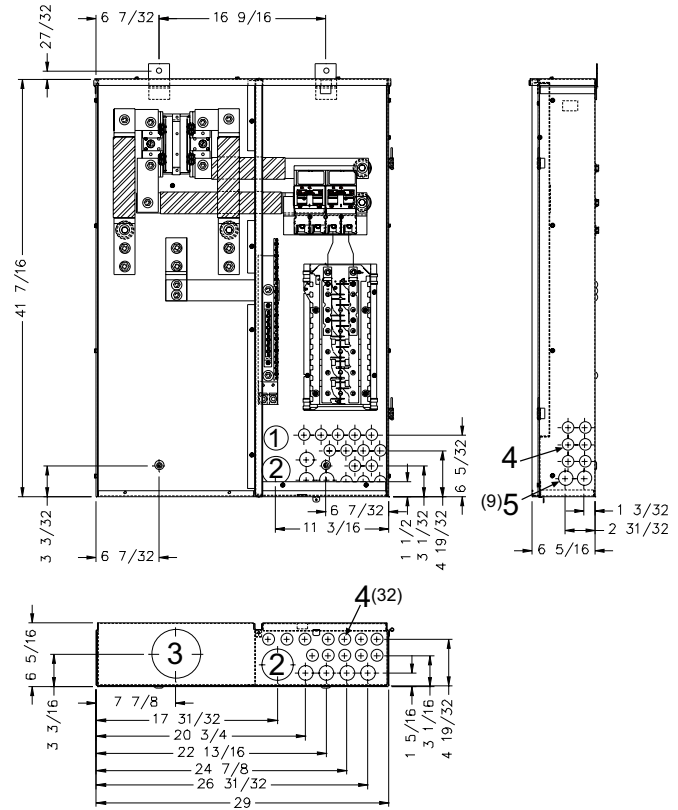
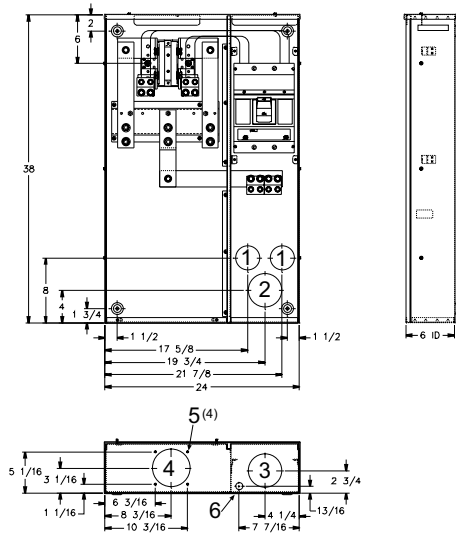

M400-UG-APS-LC
(see previous page for details)

320 Amp Main Breaker | 4 Terminal | Ring Type | 1Ø3W | Type 3R | 120/240 Volt

Catalog Number	Terminal	Service	Main Disconnect	Bypass	Connectors CU/AL		Dimensions			Knockouts					
					Line	Load	D"	W"	H"	1	2	3	4	5	6
M401-UG	4	UG	(1) 400 Amp 2 Pole Breaker	None	Studs	C.B.*	6	24	38	2½	3½	3½	4	¼	½
M401-UG-BS	4	UG	(1) 400 Amp 2 Pole Breaker	Link	Studs	C.B.*	6	24	38	2½	3½	3½	4	¼	½

Notes

- **Amperage Rating:** 400 amp, 320 amp continuous.
 - **Neutral:** Bonded neutral and ground factory installed.
 - **Load Side Connectors:** Two 1/2" studs per phase on 1-3/4" centers.
 - **Lug Kit:** Mechanical lug kit available, order **K4920** (#2-500).
 - **Flush Mount:** Flush mounting available on underground units. Order catalog number **FK-M400-UG** separately.
 - **Short Circuit Current Withstand Rating:** 22K AIC standard.
- * C.B. load side (1) or (2) copper conductors 3/0-500, (2) aluminum conductors 4/0-500 or (1) aluminum conductor 250-500.

Please consult serving utility for their requirements prior to ordering or installing, as specifications and approvals vary by utility, and may require local electrical inspector approval. All installations must be installed by a licensed electrician and must comply with all national and local codes, laws and regulations. Milbank reserves the right to make changes in specifications and features shown without notice or obligation.



Meter Main Combination

320 Amp | 4 Terminal | Ring Type



M404-UG-LC

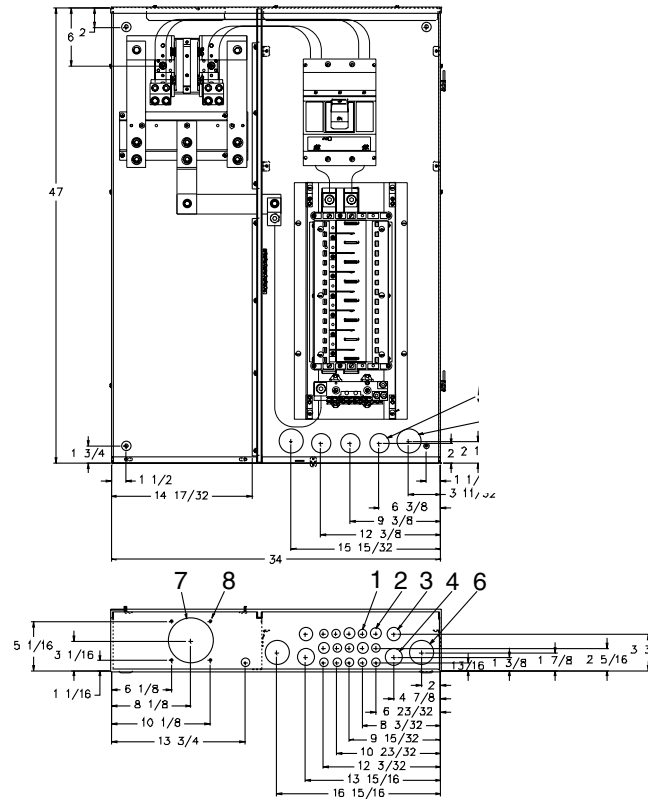

Knockouts

- 1 = (12) 1/2"
- 2 = (4) 1/2, 3/4"
- 3 = (4) 3/4, 1"
- 4 = (2) 1/2, 3/4, 1, 1-1/4"
- 5 = (3) 3/4, 1, 1-1/4, 1-1/2"
- 6 = (4) 1, 1 1/4, 1-1/2, 2"
- 7 = (1) 3, 3-1/2, 4"
- 8 = (4) 1/4" diameter hole

320 Amp Main With Circuit Load Center | 4 Terminal | Ring Type | 1Ø3W | 120/240 Volt

Catalog Number	Terminal	Service	Primary Disconnect	Secondary Disconnect	Bypass	Dimensions			Knockouts							
						D"	W"	H"	1	2	3	4	5	6	7	8
M404-UG-LC*	4	UG	400 Amp 2 Pole Breaker	NA	None	6	34	47	1/2	3/4	1	1 1/4	1 1/2	2	4	1/4
M404-UG-LC-BS*	4	UG	400 Amp 2 Pole Breaker	NA	Link	6	34	47	1/2	3/4	1	1 1/4	1 1/2	2	4	1/4

Notes

- **Amperage Rating:** 400 amp, 320 amp continuous.
- **Neutral:** Bonded neutral and ground factory installed.
- **Line Side Connectors:** Two 1/2" studs per phase on 1-3/4" centers.
- **Flush Mount:** Flush mounting available on underground units. Order catalog number **FK-M404-UGLC** separately.
- **Short Circuit Current Withstand Rating:** 22K AIC standard.
- **Lug Kit:** Mechanical lug kit available, order **K4920** (#2-500).
- **Branch Breakers:** Use Siemens, Cutler-Hammer, GE or Siemens/Murray breakers to maintain 22K rating.
- * Includes a 30-circuit load center.



Please consult serving utility for their requirements prior to ordering or installing, as specifications and approvals vary by utility, and may require local electrical inspector approval. All installations must be installed by a licensed electrician and must comply with all national and local codes, laws and regulations. Milbank reserves the right to make changes in specifications and features shown without notice or obligation.

Test Block Bypass/Safety Sockets

100 & 200 Amp | 4, 5 & 7 Terminal | Ring Type

31
100 & 200 AMP
SAFETY SOCKETS

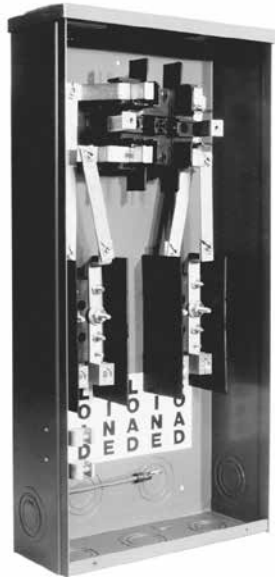

114TB

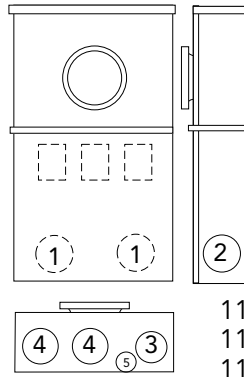

114TB
115TB
117TB

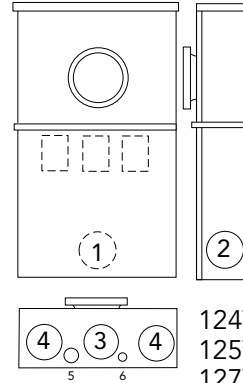

124TB
125TB
127TB



127TB

100 Amp | 4, 5 & 7 Terminal | Ring Type | 600 Volt Self-Contained | Socket Only

Catalog Number	Terminal	Service	Type of Service	Connectors CU/AL		Dimensions			Knockouts					
				Line & Load		D"	W"	H"	1	2	3	4	5	6
114TB*	4	OH/UG	1Ø3W*	#6-1/0		4 ⁵ / ₈	12	25	2	2	1½	2	½	—
115TB	5	OH/UG	3Ø3W	#6-1/0		4 ⁵ / ₈	12	25	2	2	1½	2	½	—
117TB	7	OH/UG	3Ø4W	#6-1/0		4 ⁵ / ₈	12	25	2	2	1½	2	½	—

200 Amp | 4, 5 & 7 Terminal | Ring Type | 600 Volt Self-Contained | Socket Only

Catalog Number	Terminal	Service	Type of Service	Connectors CU/AL		Dimensions			Knockouts					
				Line & Load		D"	W"	H"	1	2	3	4	5	6
124TB*	4	OH/UG	1Ø3W*	#1/0-250		6	14	30	2½	2½	3	3	¼	½, ¼
125TB	5	OH/UG	3Ø3W	#1/0-250		6	14	30	2½	2½	3	3	¼	½, ¼
127TB	7	OH/UG	3Ø4W	#1/0-250		6	14	30	2½	2½	3	3	¼	½, ¼

Notes

- **Hubs:** OH units use hub up to 2-1/2" (see accessory page). Units provided with closing plates.
 - **Sealing Rings:** Units furnished with MR-2 snap style sealing rings.
 - **Ring Protector:** Add suffix **-RP** to catalog number for factory installed ring protector (ex. **117TB** becomes **117TB-RP**).
- * For 3W (208Y/120) network service, install field mounted fifth terminal catalog number **105J**. See accessories page.

**SHORT CIRCUIT CURRENT WITHSTAND RATING UP TO 200K AIC
DEPENDENT ON OVERCURRENT PROTECTION DEVICE USED**

Please consult serving utility for their requirements prior to ordering or installing, as specifications and approvals vary by utility, and may require local electrical inspector approval. All installations must be installed by a licensed electrician and must comply with all national and local codes, laws and regulations. Milbank reserves the right to make changes in specifications and features shown without notice or obligation.



Test Block Bypass/MTB Series

100 Amp | 4, 5 & 7 Terminal | Ring Type | 10K AIC



U214MTB

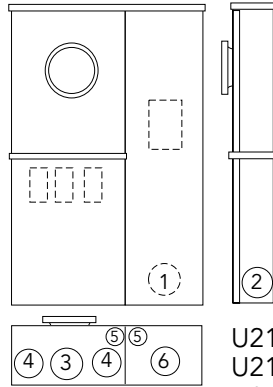

U214MTB
U215MTB
U217MTB

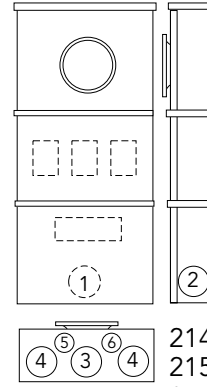

214MT
215MT
217MT



217MTB

100 Amp | 4, 5 & 7 Terminal | Ring Type | 240 Volt Self-Contained | Circuit Breaker

Catalog Number	Terminal	Service	Type of Service	Connectors CU/AL		Dimensions			Knockouts					
				Line	Load	D"	W"	H"	1	2	3	4	5	6
214MTB*	4	OH	1Ø3W*	#6-2/0	#14-1/0	4 ⁵ / ₈	12	34	2	2	2	1½	—	½
215MTB	5	OH	3Ø3W	#6-2/0	#14-1/0	4 ⁵ / ₈	12	34	2	2	2	1½	—	½
217MTB	7	OH	3Ø4W	#6-2/0	#14-1/0	4 ⁵ / ₈	12	34	2	2	2	1½	—	½
U214MTB*	4	OH/UG	1Ø3W*	#6-2/0	#14-1/0	4 ⁵ / ₈	18	25	2	2	2½	1½	¾	1½
U215MTB	5	OH/UG	3Ø3W	#6-2/0	#14-1/0	4 ⁵ / ₈	18	25	2	2	2½	1½	¾	1½
U217MTB	7	OH/UG	3Ø4W	#6-2/0	#14-1/0	4 ⁵ / ₈	18	25	2	2	2½	1½	¾	1½

Notes

- **Replacement Main Disconnects:** For replacement main disconnect see pages 42-43.
- **Hubs:** OH units use hub up to 2-1/2" (see accessory page). Units provided with closing plates.
- **Sealing Rings:** Units furnished with MR-2 snap style sealing rings.
- * For 3W (208Y/120) network service, install field mounted fifth terminal catalog number 105J. See accessories page.

These UL listed products are for use in areas requiring Electrical Utility Service Equipment Requirements Committee (EUSERC) compliance.



Please consult serving utility for their requirements prior to ordering or installing, as specifications and approvals vary by utility, and may require local electrical inspector approval. All installations must be installed by a licensed electrician and must comply with all national and local codes, laws and regulations. Milbank reserves the right to make changes in specifications and features shown without notice or obligation.

Test Block Bypass/MTB Series

100 Amp | 4 & 7 Terminal | Ring Type | 22K AIC

33
100 AMP
TEST BLOCK
BYPASS



U214MTB/22

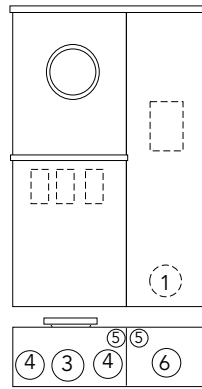

U214MTB/22
U217MTB/22

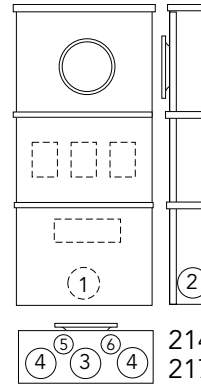

214MTB/2
217MTB/2



217MTB/2

100 Amp | 4 & 7 Terminal | Ring Type | 240 Volt Self-Contained | Circuit Breaker

Catalog Number	Terminal	Service	Type of Service	Connectors CU/AL		Dimensions			Knockouts					
				Line	Load	D"	W"	H"	1	2	3	4	5	6
214MTB/22*	4	OH	1Ø3W*	#6-2/0	#14-1/0	4 $\frac{5}{8}$	12	34	2	2	2	1 $\frac{1}{2}$	—	$\frac{1}{2}$
217MTB/22	7	OH	3Ø4W	#6-2/0	#14-1/0	4 $\frac{5}{8}$	12	34	2	2	2	1 $\frac{1}{2}$	—	$\frac{1}{2}$
U214MTB/22*	4	OH/UG	1Ø3W*	#6-2/0	#14-1/0	4 $\frac{5}{8}$	18	25	2	2	2 $\frac{1}{2}$	1 $\frac{1}{2}$	$\frac{3}{4}$	1 $\frac{1}{2}$
U217MTB/22	7	OH/UG	3Ø4W	#6-2/0	#14-1/0	4 $\frac{5}{8}$	18	25	2	2	2 $\frac{1}{2}$	1 $\frac{1}{2}$	$\frac{3}{4}$	1 $\frac{1}{2}$

Notes

- **Replacement Main Disconnects:** For replacement main disconnect see pages 42-43.
 - **Hubs:** OH units use hub up to 2-1/2" (see accessory page). Units provided with closing plates.
 - **Sealing Rings:** Units furnished with MR-2 snap style sealing rings.
- * For 3W (208Y/120) network service, install field mounted fifth terminal catalog number 105J. See accessories page.

*These UL listed products are for use in areas requiring
Electrical Utility Service Equipment Requirements Committee (EUSERC) compliance.*

Please consult serving utility for their requirements prior to ordering or installing, as specifications and approvals vary by utility, and may require local electrical inspector approval. All installations must be installed by a licensed electrician and must comply with all national and local codes, laws and regulations. Milbank reserves the right to make changes in specifications and features shown without notice or obligation.



34

100 AMP
TEST BLOCK
BYPASS

Test Block Bypass/MTB Series

100 Amp | 4, 5 & 7 Terminal | Ring Type | 14K AIC | 480 Volt



217MTB-48

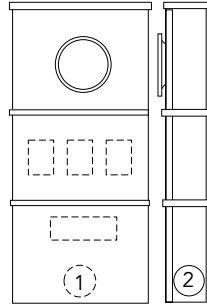

214MTB-48
215MTB-48
217MTB-48

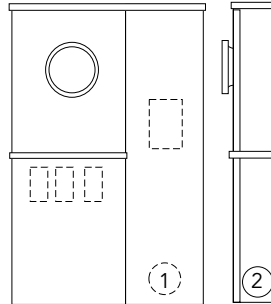

U214MTB-48
U215MTB-48
U217MTB-48



U214MTB-48

100 Amp | 4, 5 & 7 Terminal | Ring Type | 480 Volt Self-Contained | Circuit Breaker

Catalog Number	Terminal	Service	Type of Service	Connectors CU/AL		Dimensions			Knockouts					
				Line	Load	D"	W"	H"	1	2	3	4	5	6
214MTB-48*	4	OH	1Ø3W*	#6-2/0	#14-1/0	6	14	48	2½	2½	3	3	¼	½
215MTB-48	5	OH	3Ø3W	#6-2/0	#14-1/0	6	14	48	2½	2½	3	3	¼	½
217MTB-48	7	OH	3Ø4W	#6-2/0	#14-1/0	6	14	48	2½	2½	3	3	¼	½
U214MTB-48*	4	OH/UG	1Ø3W*	#6-2/0	#14-1/0	4⅝	18	25	2	2	2½	1½	½, ¾	1½
U217MTB-48	7	OH/UG	3Ø4W	#6-2/0	#14-1/0	4⅝	18	25	2	2	2½	1½	½, ¾	1½

Notes

- **Replacement Main Disconnects:** For replacement main disconnect see pages 42-43.
 - **Hubs:** OH units use hub up to 2-1/2" (see accessory page). Units provided with closing plates.
 - **Sealing Rings:** Units furnished with MR-2 snap style sealing rings.
- * For 3W (208Y/120) network service, install field mounted fifth terminal catalog number 105J. See accessories page.

These UL listed products are for use in areas requiring Electrical Utility Service Equipment Requirements Committee (EUSERC) compliance.



Please consult serving utility for their requirements prior to ordering or installing, as specifications and approvals vary by utility, and may require local electrical inspector approval. All installations must be installed by a licensed electrician and must comply with all national and local codes, laws and regulations. Milbank reserves the right to make changes in specifications and features shown without notice or obligation.

Test Block Bypass/MTB-P & MTB-P48 Series

35
100 AMP
TEST BLOCK
BYPASS

100 Amp | 4, 5 & 7 Terminal | Ring Type | 200K AIC



214MTB-P

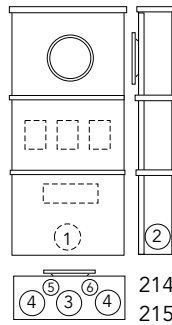

214MTB-P
215MTB-P
217MTB-P
214MTB-P48
215MTB-P48
217MTB-P48

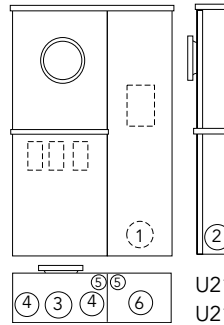

U214MTB-P
U215MTB-P
U217MTB-P
U214MTB-P48
U215MTB-P48
U217MTB-P48



U217MTB-P

100 Amp | 4, 5 & 7 Terminal | Ring Type | 240 Volt Self-Contained | T-Fuse Pullout

Catalog Number	Terminal	Service	Type of Service	Connectors CU/AL		Dimensions			Knockouts					
				Line	Load	D"	W"	H"	1	2	3	4	5	6
214MTB-P*	4	OH	1Ø3W*	#1/0-250	#14-1/0	6	14	48	2½	2½	3	3	¼	½
215MTB-P	5	OH	3Ø3W	#1/0-250	#14-1/0	6	14	48	2½	2½	3	3	¼	½
217MTB-P	7	OH	3Ø4W	#1/0-250	#14-1/0	6	14	48	2½	2½	3	3	¼	½
U214MTB-P*	4	OH/UG	1Ø3W*	#6-2/0	#14-1/0	4½	18	25	2	2	2½	1½	½, ¾	1½
U215MTB-P	5	OH/UG	3Ø3W	#6-2/0	#14-1/0	4½	18	25	2	2	2½	1½	½, ¾	1½
U217MTB-P	7	OH/UG	3Ø4W	#6-2/0	#14-1/0	4½	18	25	2	2	2½	1½	½, ¾	1½

100 Amp | 4, 5 & 7 Terminal | Ring Type | 480 Volt Self-Contained | T-Fuse Pullout

Catalog Number	Terminal	Service	Type of Service	Connectors CU/AL		Dimensions			Knockouts					
				Line	Load	D"	W"	H"	1	2	3	4	5	6
214MTB-P48*	4	OH	1Ø3W*	#6-2/0	#14-1/0	6	14	48	2½	2½	3	3	¼	½
215MTB-P48	5	OH	3Ø3W	#6-2/0	#14-1/0	6	14	48	2½	2½	3	3	¼	½
217MTB-P48	7	OH	3Ø4W	#6-2/0	#14-1/0	6	14	48	2½	2½	3	3	¼	½
U214MTB-P48*	4	OH/UG	1Ø3W*	#6-2/0	#14-1/0	4½	18	25	2	2	2½	1½	½, ¾	1½
U215MTB-P48	5	OH/UG	3Ø3W	#6-2/0	#14-1/0	4½	18	25	2	2	2½	1½	½, ¾	1½
U217MTB-P48	7	OH/UG	3Ø4W	#6-2/0	#14-1/0	4½	18	25	2	2	2½	1½	½, ¾	1½

Notes

- **Replacement Main Disconnects:** For replacement main disconnect see pages 42-43.
 - **Hubs:** OH units use hub up to 2-1/2" (see accessory page). Units provided with closing plates.
 - **Sealing Rings:** Units furnished with MR-2 snap style sealing rings.
 - **Pull-Outs:** For use with T-fuses only. Fuses are included with fused safety sockets.
- * For 3W (208Y/120) network service, install field mounted fifth terminal catalog number 105J. See accessories page.

These UL listed products are for use in areas requiring Electrical Utility Service Equipment Requirements Committee (EUSERC) compliance.

Please consult serving utility for their requirements prior to ordering or installing, as specifications and approvals vary by utility, and may require local electrical inspector approval. All installations must be installed by a licensed electrician and must comply with all national and local codes, laws and regulations. Milbank reserves the right to make changes in specifications and features shown without notice or obligation.



Test Block Bypass/MTB Series

200 Amp | 4, 5 & 7 Terminal | Ring Type | 10K AIC



227MTB

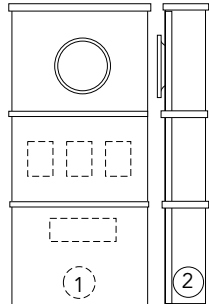

224MTB
227MTB

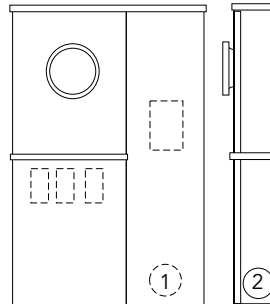

U224MTB
U227MTB



U224MTB

200 Amp | 4 & 7 Terminal | Ring Type | 240 Volt Self-Contained | Circuit Breaker

Catalog Number	Terminal	Service	Type of Service	Connectors CU/AL		Dimensions			Knockouts					
				Line	Load	D"	W"	H"	1	2	3	4	5	6
224MTB*	4	OH	1Ø3W*	#6-250	#2/0-250	6	14	48	2½	2½	3	3	½	¼
227MTB	7	OH	3Ø4W	#6-250	#2/0-250	6	14	48	2½	2½	3	3	½	¼
U224MTB*	4	OH/UG	1Ø3W*	#6-250	#2/0-250	6	22¾	30	2½	2½	2½	1½	½,¾	1½
U227MTB	7	OH/UG	3Ø4W	#6-250	#2/0-250	6	22¾	30	2½	2½	2½	1½	½,¾	1½

Notes

- **Replacement Main Disconnects:** For replacement main disconnect see pages 42-43.
- **Hubs:** OH units use hub up to 2-1/2" (see accessory page). Units provided with closing plates.
- **Sealing Rings:** Units furnished with MR-2 snap style sealing rings.
- * For 3W (208Y/120) network service, install field mounted fifth terminal catalog number 105J. See accessories page.

These UL listed products are for use in areas requiring Electrical Utility Service Equipment Requirements Committee (EUSERC) compliance.



Please consult serving utility for their requirements prior to ordering or installing, as specifications and approvals vary by utility, and may require local electrical inspector approval. All installations must be installed by a licensed electrician and must comply with all national and local codes, laws and regulations. Milbank reserves the right to make changes in specifications and features shown without notice or obligation.

Test Block Bypass/MTB Series

200 Amp | 4 & 7 Terminal | Ring Type | 22K AIC

37
200 AMP
TEST BLOCK
BYPASS



227MTB/22

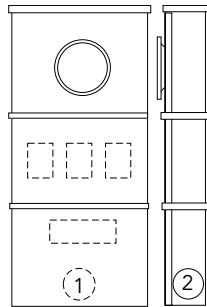

224MTB/22
227MTB/22

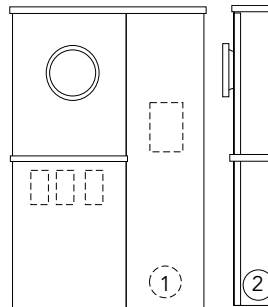

U224MTB/22
U227MTB/22



U224MTB/22

200 Amp | 4 & 7 Terminal | Ring Type | 240 Volt Self-Contained | Circuit Breaker

Catalog Number	Terminal	Service	Type of Service	Connectors CU/AL		Dimensions			Knockouts					
				Line	Load	D"	W"	H"	1	2	3	4	5	6
224MTB/22*	4	OH	1Ø3W*	#6-250	#2/0-250	6	14	48	2½	2½	3	3	½	¼
227MTB/22	7	OH	3Ø4W	#6-250	#2/0-250	6	14	48	2½	2½	3	3	½	¼
U224MTB/22*	4	OH/UG	1Ø3W*	#6-250	#2/0-250	6	22¾	30	2½	2½	2½	1½	½,¾	1½
U227MTB/22	7	OH/UG	3Ø4W	#6-250	#2/0-250	6	22¾	30	2½	2½	2½	1½	½,¾	1½

Notes

- **Replacement Main Disconnects:** For replacement main disconnect see pages 42-43.
 - **Hubs:** OH units use hub up to 2-1/2" (see accessory page). Units provided with closing plates.
 - **Sealing Rings:** Units furnished with MR-2 snap style sealing rings.
- * For 3W (208Y/120) network service, install field mounted fifth terminal catalog number 105J. See accessories page.

Please consult serving utility for their requirements prior to ordering or installing, as specifications and approvals vary by utility, and may require local electrical inspector approval. All installations must be installed by a licensed electrician and must comply with all national and local codes, laws and regulations. Milbank reserves the right to make changes in specifications and features shown without notice or obligation.



Test Block Bypass/MTB Series

200 Amp | 4 & 7 Terminal | Ring Type | 35K AIC | 480 Volt



227MTB-48

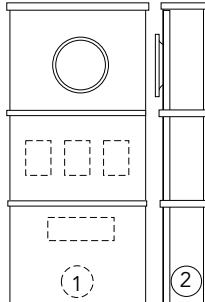

224MTB-48
227MTB-48

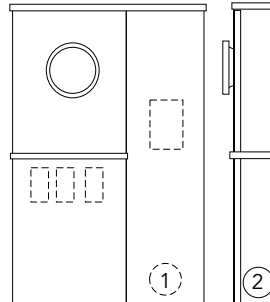

U224MTB-48
U227MTB-48



U224MTB-48

200 Amp | 4 & 7 Terminal | Ring Type | 480 Volt Self-Contained | Circuit Breaker

Catalog Number	Terminal	Service	Type of Service	Connectors CU/AL		Dimensions			Knockouts					
				Line	Load	D"	W"	H"	1	2	3	4	5	6
224MTB-48*	4	OH	1Ø3W*	#6-250	#2/0-250	6	22¾	30	2½	2½	3	2½	½	¼
U224MTB-48	4	OH/UG	1Ø3W*	#6-250	#2/0-250	6	22¾	30	2½	2½	3	2½	½	¼
227MTB-48	7	OH	3Ø4W	#6-250	#2/0-250	6	14	48	2½	2½	3	3	½	¼
U227MTB-48	7	OH/UG	3Ø4W	#6-250	#2/0-250	6	22¾	30	2½	2½	2½	1½	½¾	1½

Notes

- **Replacement Main Disconnects:** For replacement main disconnect see pages 42-43.
 - **Hubs:** OH units use hub up to 2-1/2" (see accessory page). Units provided with closing plates.
 - **Sealing Rings:** Units furnished with MR-2 snap style sealing rings.
- * For 3W (208Y/120) network service, install field mounted fifth terminal catalog number 105J. See accessories page.



Please consult serving utility for their requirements prior to ordering or installing, as specifications and approvals vary by utility, and may require local electrical inspector approval. All installations must be installed by a licensed electrician and must comply with all national and local codes, laws and regulations. Milbank reserves the right to make changes in specifications and features shown without notice or obligation.

Test Block Bypass/MTB-P & MTB-P48

200 Amp | Ring Type | 200K AIC

39
200 AMP
TEST BLOCK
BYPASS



224MTB-P

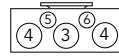
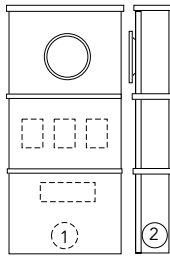

224MTB-P
225MTB-P
227MTB-P
224MTB-P48
225MTB-P48
227MTB-P48

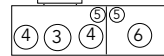
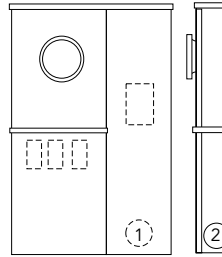

U224MTB-P
U227MTB-P
U224MTB-P48
U227MTB-P48



U227MTB-P

200 Amp | 4, 5 & 7 Terminal | Ring Type | 240 Volt Self-Contained | T-Fuse Pullout

Catalog Number	Terminal	Service	Type of Service	Connectors CU/AL		Dimensions			Knockouts					
				Line	Load	D"	W"	H"	1	2	3	4	5	6
224MTB-P*	4	OH	1Ø3W*	#6-250	#1/0-250	6	14	48	2½	2½	3	3	¼	½
225MTB-P	5	OH	3Ø3W	#6-250	#1/0-250	6	14	48	2½	2½	3	3	¼	½
227MTB-P	7	OH	3Ø4W	#6-250	#1/0-250	6	14	48	2½	2½	3	3	¼	½
U224MTB-P*	4	OH/UG	1Ø3W*	#6-250	#1/0-250	6	22¾	30	2½	2½	3	2½	½,¾	2½
U227MTB-P	7	OH/UG	3Ø4W	#6-250	#1/0-250	6	22¾	30	2½	2½	3	2½	½,¾	2½

200 Amp | 4, 5 & 7 Terminal | Ring Type | 480 Volt Self-Contained | T-Fuse Pullout

Catalog Number	Terminal	Service	Type of Service	Connectors CU/AL		Dimensions			Knockouts					
				Line	Load	D"	W"	H"	1	2	3	4	5	6
224MTB-P48*	4	OH	1Ø3W*	#6-250	#1/0-250	6	14	48	2½	2½	3	3	¼	½
225MTB-P48	5	OH	3Ø3W	#6-250	#1/0-250	6	14	48	2½	2½	3	3	¼	½
227MTB-P48	7	OH	3Ø4W	#6-250	#1/0-250	6	14	48	2½	2½	3	3	¼	½
U224MTB-P48*	4	OH/UG	1Ø3W*	#6-250	#1/0-250	6	22¾	30	2½	2½	3	2½	½,¾	2½
U227MTB-P48	7	OH/UG	3Ø4W	#6-250	#1/0-250	6	22¾	30	2½	2½	3	2½	½,¾	2½

Notes

- **Replacement Main Disconnects:** For replacement main disconnect see pages 42-43.
 - **Hubs:** OH units use hub up to 2-1/2" (see accessory page). Units provided with closing plates.
 - **Sealing Rings:** Units furnished with MR-2 snap style sealing rings.
 - **Pull-Outs:** For use with T-fuses only. Fuses are included with fused safety sockets.
- * For 3W (208Y/120) network service, install field mounted fifth terminal catalog number 105J. See accessories page.

Please consult serving utility for their requirements prior to ordering or installing, as specifications and approvals vary by utility, and may require local electrical inspector approval. All installations must be installed by a licensed electrician and must comply with all national and local codes, laws and regulations. Milbank reserves the right to make changes in specifications and features shown without notice or obligation.



Test Block Bypass/MTBL

All-In-One Series | 100 & 200 Amp | 10K & 200K AIC



U227MTBL

100 & 200 Amp | 240 Volt Meter Main | Circuit Breaker/T-Fuse Pullout

Catalog Number	Rating	No. Internal Circuits	Main Circuit Breaker Or Fuse Pullout	Dimensions			Bottom Knockouts	Back Knockouts
				D"	W"	H"		
U214MTBL*	100A, 120/240 VAC 1Ø3W	12/24	100A, 2P, 10K Milbank Q2100	4 $\frac{5}{8}$	25	24 $\frac{3}{4}$	Utility Section (1) ½" (3) 1¼", 1½", 2", 2½" Customer Section (3) ½", ¾" (1) ½", ¾", 1", 1¼" (2) ¾", 1", 1¼", 1½"	Customer Section (7) ½" (4) ½", ¾" (1) ¾", 1", 1¼", 1½"
U214MTBPL*	100A, 120/240 VAC 1Ø3W	12/24	100A, 2P, 200K Boltswitch PT223	4 $\frac{5}{8}$	25	24 $\frac{3}{4}$		
U217MTBL	100A, 240Δ/120; 208Y/120 VAC 3Ø4W	18/36	100A, 3P, 10K Siemens BQ3100	4 $\frac{5}{8}$	25	24 $\frac{3}{4}$		
U217MTBPL	100A, 240Δ/120; 208Y/120 VAC 3Ø4W	18/36	100A, 3P, 200K Boltswitch PT323	4 $\frac{5}{8}$	25	24 $\frac{3}{4}$		
U224MTBL*	200A, 120/240 VAC 1Ø3W	20/40	200A, 2P, 10K Milbank UQFP-200	6	27	30	Utility Section (1) ½", ¾" (2) 1¼", 1½", 2", 2½" (1) 2½", 3" Customer Section (11) ½" (2) ½", ¾" (1) ½", ¾", 1", 1¼" (2) ¾", 1", 1¼", 1½"	Customer Section (6) ½" (4) ½", ¾" (1) ¾", 1", 1¼", 1½"
U224MTBPL*	200A, 120/240 VAC 1Ø3W	20/40	200A, 2P, 200K Boltswitch PT224	6	27	30		
U227MTBL	200A, 240Δ/120; 208Y/120 VAC 3Ø4W	24/42	200A, 3P, 10K Siemens QJ23B200	6	27	30		
U227MTBPL	200A, 240Δ/120; 208Y/120 VAC 3Ø4W	24/42	200A, 3P, 200K Boltswitch PT324	6	27	30		

Notes

- **Line:** Underground or overhead service. Line Lug: 100A, 14-1/0 and 200A 1/0-250.
 - **Load:** Exit below load center only
 - **Branch Breakers:** Single phase units—approved for Siemens/ITE Type Q, Challenger, Cutler-Hammer/Westinghouse, General Electric, Murray. Three phase units—approved for Siemens/ITE Type Q.
 - **Hubs:** OH units use hub up to 2-1/2" (see accessory page). Units provided with closing plate.
 - **Pull-Outs:** For use with T-fuses only. Fuses are included with fused safety sockets.
- * For 208Y/120 applications, order field kit **105J** separately and install.



Please consult serving utility for their requirements prior to ordering or installing, as specifications and approvals vary by utility, and may require local electrical inspector approval. All installations must be installed by a licensed electrician and must comply with all national and local codes, laws and regulations. Milbank reserves the right to make changes in specifications and features shown without notice or obligation.

Test Block Bypass/MTBL

Knockout Information

Catalog Number	Knockouts				
	1	2	3	4	5
U214MTBL	2½	1½	1¼	¾	½
U217MTBL	2½	1½	1¼	¾	½
U227MTBL	3	2½	1½	¾	½
U227MTBPL	3	2½	1½	1¼	¾

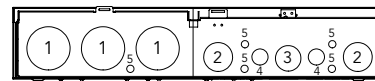
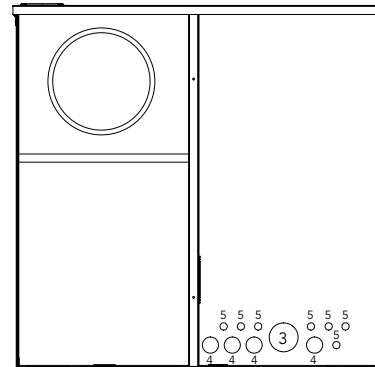

U214MTBL
U217MTBL

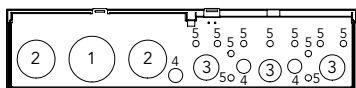
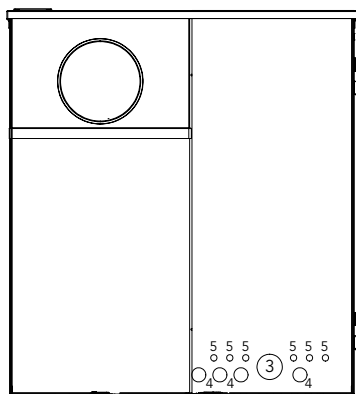

U227MTBL

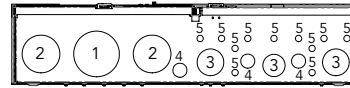
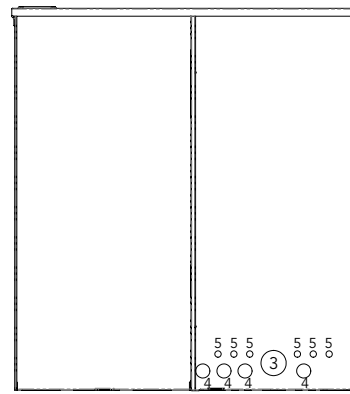

U227MTBPL

Please consult serving utility for their requirements prior to ordering or installing, as specifications and approvals vary by utility, and may require local electrical inspector approval. All installations must be installed by a licensed electrician and must comply with all national and local codes, laws and regulations. Milbank reserves the right to make changes in specifications and features shown without notice or obligation.



Replacement Circuit Breakers

Catalog Number	Circuit Breaker
214MTB	BQ2B100L
214MTB-48	ED42B100
214MTB/22	BQ2B100HL
U214MTB	BQ2B100L
U214MTB-48	ED42B100
U214MTB/22	BQ2B100HL
U214MTBL	Q2100
215MTB	BQ3B100L
215MTB-48	ED43B100L
U215MTB	BQ3B100L
U215MTB-48	ED43B100L
217MTB	BQ3B100L
217MTB48	ED43B100L
217MTB/22	BQ3B100HL
U217MTB	BQ3B100L
U217MTB-48	ED43B100L
U217MTB/22	BQ3B100HL
U217MTBL	BQ3B100L
224MTB	UQFB-200
224MTB/22	UQFBH-200
U224MTB	UQFB-200
U224MTB-48	FXD62B200
U224MTB/22	UQFBH-200
U224MTBL	UQFB-200
U225MTB	UQFB-3200

Catalog Number	Circuit Breaker
227MTB	UQFB-3200
227MTB-125	UQFB-3125
227MTB-150	UQFB-3150
227MTB-175	UQFB-3175
227MTB-48	FXD63B200L
227MTB/22	QJH23B200L
U227MTB	UQFB-3200
U227MTB-125	UQFB-3125
U227MTB-150	UQFB-3150
U227MTB-175	UQFB-3175
U227MTB-48	FXD63B200L
U227MTB/22	QJH23B200L
U227MTBL	QJ23B200

Lug Kits for Circuit Breakers

Siemens Circuit Breaker	Number of Lug Collars Required
ED42B100	(2) LN13100
ED43B100	(3) LN1E100
FXD62B200	(4) TA1FD350
FXD63B200	(6) TA1FD350
QJ22B200H	(2) TA1Q300
QJ23B200	(1) TA1Q300
QJH23B200L	(1) TA1Q300

Note

When replacing Siemens Circuit Breaker (FXD,ED,QJ) in safety sockets, lug collars must be ordered from Siemens separately.



Please consult serving utility for their requirements prior to ordering or installing, as specifications and approvals vary by utility, and may require local electrical inspector approval. All installations must be installed by a licensed electrician and must comply with all national and local codes, laws and regulations. Milbank reserves the right to make changes in specifications and features shown without notice or obligation.

Safety Socket Replacement

T-Fuse Pullouts

Replacement T-Fuse Pullouts

Catalog Number	Circuit Breaker	Mfg.	Part Number
214MTB-P	PT223	Boltswitch	707674-MO
214MTB-P48	PT263	Boltswitch	708564-MO
U214MTB-P	PT223	Boltswitch	707674-MO
U214MTB-P48	PT263	Boltswitch	708564-MO
U214MTBPL	PT223	Boltswitch	707674-MO
215MTB-P	PT323	Boltswitch	708565-MO
215MTB-P48	PT363	Boltswitch	708566-MO
U215MTB-P	PT323	Boltswitch	708565-MO
U215MTB-P48	PT363	Boltswitch	708566-MO
217MTB-P	PT323	Boltswitch	708565-MO
217MTB-P48	PT363	Boltswitch	708566-MO
U217MTB-P	PT323	Boltswitch	708565-MO
U217MTB-P48	PT363	Boltswitch	708566-MO
U217MTBPL	PT323	Boltswitch	708565-MO
224MTB-P	PT224	Boltswitch	707684-MO
224MTB-P48	PT264	Boltswitch	708567-MO
U224MTB-P	PT224	Boltswitch	707684-MO
U224MTB-P48	PT264	Boltswitch	708567-MO
U224MTBPL	PT224	Boltswitch	707684-MO
225MTB-P48	PT364	Boltswitch	708569-MO
U225MTBPL	PT324	Boltswitch	708568-MO
227MTB-P	PT323	Boltswitch	708568-MO
227MTB-P48	PT364	Boltswitch	708569-MO
U227MTB-P	PT324	Boltswitch	708568-MO
U227MTB-P48	PT364	Boltswitch	708569-MO
U227MTBPL	PT324	Boltswitch	708568-MO

Lug Kits for T-Fuse Pullouts

Part Number	Number of Lug Collars Required
707682-AC	(2) TK100P
708570-AC	(2) TK200P
707682-AC	(2) TK100P
708570-AC	(2) TK200P
707682-AC	(3) TK100P
708570-AC	(3) TK200P
707682-AC	(3) TK100P
708570-AC	(3) TK200P

Note

T-Fuse pullouts provided with load side lugs. Order line side lugs separately from above chart.

Please consult serving utility for their requirements prior to ordering or installing, as specifications and approvals vary by utility, and may require local electrical inspector approval. All installations must be installed by a licensed electrician and must comply with all national and local codes, laws and regulations. Milbank reserves the right to make changes in specifications and features shown without notice or obligation.



44

SAFETY SOCKET
& T-FUSE
REPLACEMENT

Safety Socket & T-Fuse Replacement



MS-27-TB



TB200-47

Tenant Meter Sockets

Catalog Number	Amp	Voltage/System
MS-24-TB	200	600V/1Ø3W
MS-25-TB	200	600V/3Ø3W
MS-27-TB	200	600V/3Ø4W

Replacement Test Blocks

Catalog Number	Amp	Phase
TB100-47	100	Phase A, B & C
TB100-5 Center Block Only	100	Phase B – 3Ø3W
TB200-47	200	Phase A, B & C
TB200-5 Center Block Only	200	Phase B – 3Ø3W
TB200-LL	200	Lug – Lug



PT324

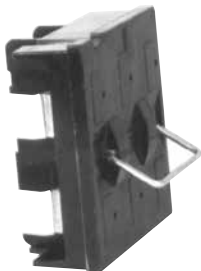

240 Volt Main Disconnects Pullout Switch (Uses Type "T" Fuse)

Catalog Number	Amp	Rating
PT223	100	2 Pole – 240 Volt
PT224	200	2 Pole – 240 Volt
PT323	100	3 Pole – 240 Volt
PT324	200	3 Pole – 240 Volt

480 Volt Main Disconnects Pullout Switch (Uses Type "T" Fuse)

Catalog Number	Amp	Rating
PT263	100	2 Pole – 480 Volt
PT264	200	2 Pole – 480 Volt
PT363	100	3 Pole – 480 Volt
PT364	200	3 Pole – 480 Volt

*These UL listed products are for use in areas requiring
Electrical Utility Service Equipment Requirements Committee (EUSERC) compliance.*



Please consult serving utility for their requirements prior to ordering or installing, as specifications and approvals vary by utility, and may require local electrical inspector approval. All installations must be installed by a licensed electrician and must comply with all national and local codes, laws and regulations. Milbank reserves the right to make changes in specifications and features shown without notice or obligation.

Underground Termination Boxes

600 VAC

45
UNDERGROUND
TERMINATION
BOXES



PB-012



PB-038



PB-011



PB-032

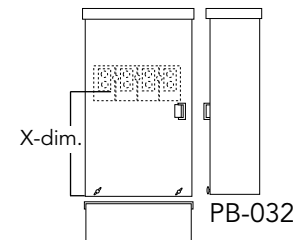
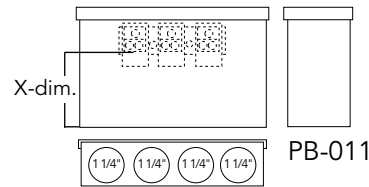
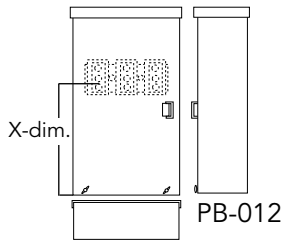

Underground Termination Boxes | 600 VAC

Catalog Number	Amp	Type of Service	Connectors CU/AL		Dimensions				Short Circuit Current Withstand Rating
			Line	Load	D"	W"	H"	X"	
PB-011*	100	1Ø3W	#14-1/0	#14-1/0	4	12	8½	3¾	10K Amp
PB-012	200	1Ø3W	#6-250	#6-250	6	12	26	14¼	10K Amp
PB-014** PB-014-NK	400	1Ø3W	½"x13 Studs	#4-600 Twin 1/0-250	6	16	36	22	50K Amp
PB-018** PB-018-NK	800	1Ø3W	½"x13 Studs**	#4-600 Twin 1/0-250	11	24	48	26	50K Amp
PB-032	200	3Ø4W	#6-250	#6-250	6	16	26	14¼/6	10K Amp
PB-034** PB-034-NK	400	3Ø4W	½"x13 Studs**	#4-600 Twin 1/0-250	6	16	36	22	50K Amp
PB-038**	800	3Ø4W	½"x13 Studs**	#4-600 Twin 1/0-250	11	24	48	26	50K Amp

Notes

- **Connectors and Bussing:** Extruded aluminum connectors and bus bars are tin plated.
- For no knockouts, add suffix -NK to the above catalog numbers.
- * No lift handles provided on the **PB-011**.
- ** 2 studs per lug position provided for 400 amp units. 4 studs per lug position provided for 800 amp units.

Please consult serving utility for their requirements prior to ordering or installing, as specifications and approvals vary by utility, and may require local electrical inspector approval. All installations must be installed by a licensed electrician and must comply with all national and local codes, laws and regulations. Milbank reserves the right to make changes in specifications and features shown without notice or obligation.



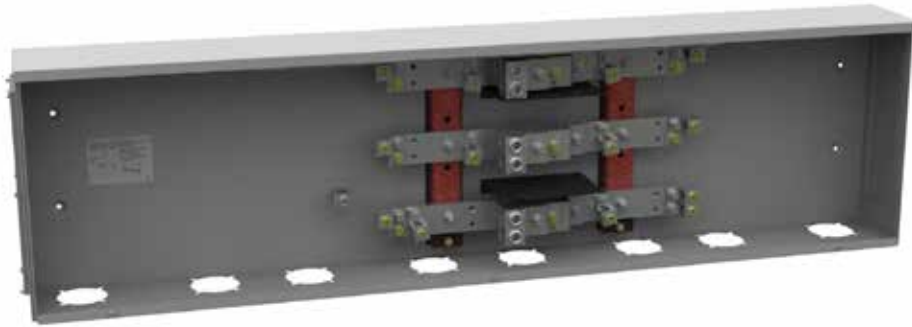

For Commercial Safety Socket Applications

Bussed Gutters | Type 3R | 1Ø3W | 600 VAC

Catalog Number	Meter Position	Amp	Dimensions			Length of Bus	Line Lugs Per Each Bus	Load Lugs Per Bus
			D"	W"	H"			
BC214	2	400	6	28 $\frac{5}{8}$	15 $\frac{1}{2}$	20" Bar	(1) 600	(2) 6-250
BC318	3	800	6	43	15 $\frac{1}{2}$	(2) 20" Bars	(2) 600	(3) 6-250
BC418	4	800	6	57 $\frac{1}{4}$	15 $\frac{1}{2}$	(2) 20" Bars	(2) 600	(4) 6-250
BC518	5	800	6	71 $\frac{5}{8}$	15 $\frac{1}{2}$	(2) 20" Bars	(2) 600	(5) 6-250
BC618	6	800	6	85 $\frac{7}{8}$	15 $\frac{1}{2}$	(2) 20" Bars	(2) 600	(6) 6-250

Bussed Gutters | Type 3R | 3Ø4W | 600 VAC

Catalog Number	Meter Position	Amp	Dimensions			Length of Bus	Line Lugs Per Each Bus	Load Lugs Per Bus
			D"	W"	H"			
BC234	2	400	6	28 $\frac{5}{8}$	15 $\frac{1}{2}$	20" Bar	(1) 600	(2) 6-250
BC338	3	800	6	43	15 $\frac{1}{2}$	(2) 20" Bars	(2) 600	(3) 6-250
BC438	4	800	6	57 $\frac{1}{4}$	15 $\frac{1}{2}$	(2) 20" Bars	(2) 600	(4) 6-250
BC538	5	800	6	71 $\frac{5}{8}$	15 $\frac{1}{2}$	(2) 20" Bars	(2) 600	(5) 6-250
BC638	6	800	6	85 $\frac{7}{8}$	15 $\frac{1}{2}$	(2) 20" Bars	(2) 600	(6) 6-250

Notes

- **Short Circuit Current Withstanding Rating:** Standard bracing is 42K AIC.
- **Connectors and Bussing:** Extruded aluminum connectors and bus bars are tin plated.
- **Cover:** Lift handles provided along with a cover sealing provision. A removable, sealable cover is provided at both ends for pull box assembly.
- **Hardware:** Meter socket mounting hardware included.
- Suitable for use on line side of service equipment.



Please consult serving utility for their requirements prior to ordering or installing, as specifications and approvals vary by utility, and may require local electrical inspector approval. All installations must be installed by a licensed electrician and must comply with all national and local codes, laws and regulations. Milbank reserves the right to make changes in specifications and features shown without notice or obligation.

Bussed Gutters

Type 3R | 3Ø4W | 600 VAC



- Enclosure without knockouts
- Tin plated aluminum bus bars
- Furnished with line lugs only
- Bus is drilled and tapped for easy installation of load lugs

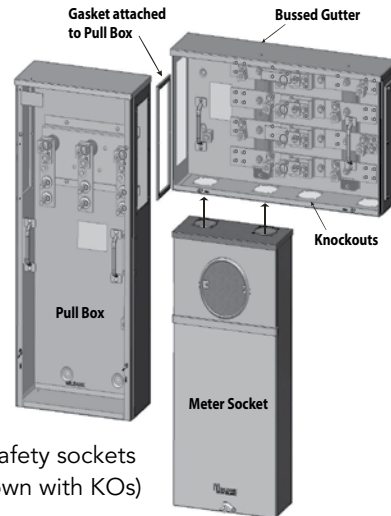

Typical application of safety sockets with multi-metering (shown with KOs)

Bussed Gutters | Type 3R | 1Ø4W | 600 VAC

Catalog Number	Meter Position	Amp	Dimensions			Length of Bus	Line Lugs Per Each Bus
			D"	W"	H"		
U3412-O	2	400	6	24	24	17" Bar	(1) 600
U3413-O	3	600	6	36	24	24" Bars	(2) 600
U3414-O	4	800	6	48	24	32" Bars	(3) 600
U3415-O	5	800	6	60	24	40" Bars	(3) 600
U3416-O	6	800	6	72	24	56" Bars	(3) 600

Bussed Gutters | Type 3R | 3Ø4W | 600 VAC

Catalog Number	Meter Position	Amp	Dimensions			Length of Bus	Line Lugs Per Each Bus
			D"	W"	H"		
U3462-O	2	400	6	24	24	17" Bar	(1) 600
U3463-O	3	600	6	36	24	24" Bars	(2) 600
U3464-O	4	800	6	48	24	32" Bars	(3) 600
U3465-O	5	800	6	60	24	40" Bars	(3) 600
U3466-O	6	800	6	72	24	56" Bars	(3) 600

Notes

- **Short Circuit Current Withstanding Rating:** The 400 and 600 amp units have a withstand rating of 50K amp, and the 800 amp units have a rating of 65K amp.
- Suitable for use on line side of service equipment.

Please consult serving utility for their requirements prior to ordering or installing, as specifications and approvals vary by utility, and may require local electrical inspector approval. All installations must be installed by a licensed electrician and must comply with all national and local codes, laws and regulations. Milbank reserves the right to make changes in specifications and features shown without notice or obligation.



48

100-125 AMP
MULTI-POSITION
SOCKETS

Multi-Position Sockets

100-125 Amp | 4 Terminal | Ringless | 300 VAC



U8032-XL

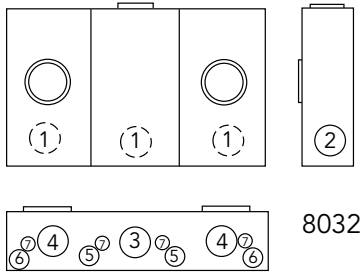

8032



U3522-XL-K1

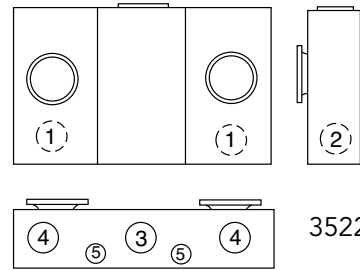

3522

100 Amp per Position | 4 Terminal | Multi-Position | Horizontal Gangs | Ringless

Catalog Number	Positions	Service	Hub	Connectors CU/AL		Dimensions			Knockouts						
				Line	Load	D"	W"	H"	1	2	3	4	5	6	7
U8032-XL	2	OH/UG	C.P.	#2-350	#6-2/0	4½	24½	16	2	2	2½	2	½	½	⅝
U8033-XL	3	OH/UG	C.P.	#2-350	#6-2/0	4½	32¾	16	2	2	2½	(3) 2	½	½	⅝
U8034-XL	4	OH/UG	C.P.	#2-350	#6-2/0	4½	40⅞	16	2	2	2½	(4) 2	½	½	⅝
U8035-XL	5	OH/UG	C.P.	#2-350	#6-2/0	4½	49⅙	16	2	2	2½	(5) 2	½	½	⅝
U8036-XL	6	OH/UG	C.P.	#2-350	#6-2/0	4½	57¼	16	2	2	2½	(6) 2	½	½	⅝

125 Amp per Position | 4 Terminal | Multi-Position | Horizontal Gangs | Ring Type

Catalog Number	Positions	Service	Hub	Connectors CU/AL		Dimensions			Knockouts					
				Line	Load	D"	W"	H"	1	2	3	4	5	6
U3522-XL-K1	2	OH/UG	C.P.	#2-350	#6-2/0	4½	24½	14	1½	1½	2½	2½	¼, ½	½
U3523-XL-K1	3	OH/UG	C.P.	#2-350	#6-2/0	4½	32¾	14	1½	1½	2½	(3) 2½	¼, ½	½
U3524-XL-K2	4	OH/UG	C.P.	#2-350	#6-2/0	4½	40⅞	14	1½	1½	2½	(4) 2½	¼, ½	½
U3525-XL-K2	5	UG	C.P.	#2-350	#6-2/0	4½	49⅙	14	1½	1½	2½	(5) 2½	¼, ½	½

Notes

- **Fifth Terminal:** For field mounted fifth terminal, order catalog number **5T8K2** (6 o'clock only on 100 amp units, 9 o'clock only on 125 amp units).
- **Hubs:** For proper hub selection, see the hub suffix chart on the accessory page.
- **Sealing Rings:** Ring type units are supplied with one **MR-4** screw type sealing ring per position.



Please consult serving utility for their requirements prior to ordering or installing, as specifications and approvals vary by utility, and may require local electrical inspector approval. All installations must be installed by a licensed electrician and must comply with all national and local codes, laws and regulations. Milbank reserves the right to make changes in specifications and features shown without notice or obligation.

50

125-200 AMP
MULTI-POSITION
METER MAINS

Multi-Position Meter Mains

125-200 Amp | 4 Terminal | Ringless | 120/240 VAC



U2854-X

125 Amp | Position



U2866-X

200 Amp | Position

VERTICAL

Catalog Number	Positions	Main Bus Rating	Connectors CU/AL
			Line
U2852-X	2	200 Amp	*3/8"-16 STUD
U2853-X	3	200 Amp	*3/8"-16 STUD

Catalog Number	Positions	Main Bus Rating	Connectors CU/AL
			Line
U2862-X	2	250 Amp	*3/8"-16 STUD
U2863-X	3	300 Amp	*3/8"-16 STUD

RECTANGULAR

125 Amp | Position

Catalog Number	Positions	Main Bus Rating	Connectors CU/AL
			Line
U2854-X	4	400 Amp	*3/8"-16 STUD
U2855-X	5	400 Amp	*3/8"-16 STUD
U2856-X	6	400 Amp	*3/8"-16 STUD

200 Amp | Position

Catalog Number	Positions	Main Bus Rating	Connectors CU/AL
			Line
U2864-X	4	400 Amp	*3/8"-16 STUD
U2865-X	5	400 Amp	*3/8"-16 STUD
U2866-X	6	400 Amp	*3/8"-16 STUD

Connector Kits

Size	Suffix	Kit Number	Compatible With	Wire Range
SINGLE	-K1	K1539	U2852-56 U2862-66	#6-350
	-K3	K1540	U2854-56 U2864-66	#4-600
TWIN	-K2	K1350	U2854-56 U2863-66	#6-350
	-K4	K1541	U2864-66	#2-600

Connectors: For line wire connector kits, order separately.

Fifth Terminal: For field mounted fifth terminal order catalog number **K2381**. Order one per meter position (9 o'clock position only).

Breakers: Units have provision for one double pole main per meter position. Breakers not included. Order as extra Milbank.

*To add lugs, refer to the connector kits available in the Connector Kits table.

Amp	Cutler-Hammer (Westinghouse)	Simens (ITE)	Siemens Murray/ Crouse-Hinds	G.E.	SQ-D
150-200	HQP/BR/WBJ	QN	MD	THQ	
≤125	QP/BR/HQP	QP	MP	THQ	Homeline



Please consult serving utility for their requirements prior to ordering or installing, as specifications and approvals vary by utility, and may require local electrical inspector approval. All installations must be installed by a licensed electrician and must comply with all national and local codes, laws and regulations. Milbank reserves the right to make changes in specifications and features shown without notice or obligation.

Multi-Position Meter Mains

125-200 Amp | 22K AIC Rated | 240 VAC

51

125-200 AMP
MULTI-POSITION
METER MAINS



U2852-X

CONDOMINIUM METERING BANKS

VERTICAL

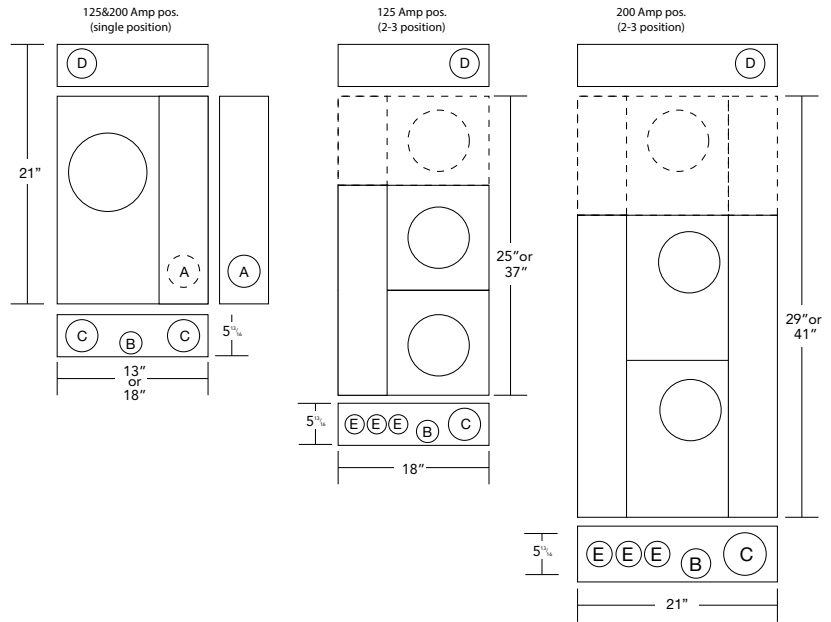

RECTANGULAR

Knockouts	
A	1 1/4"
B	1/4, 1/2"
C	3"
D	4"
E	2"

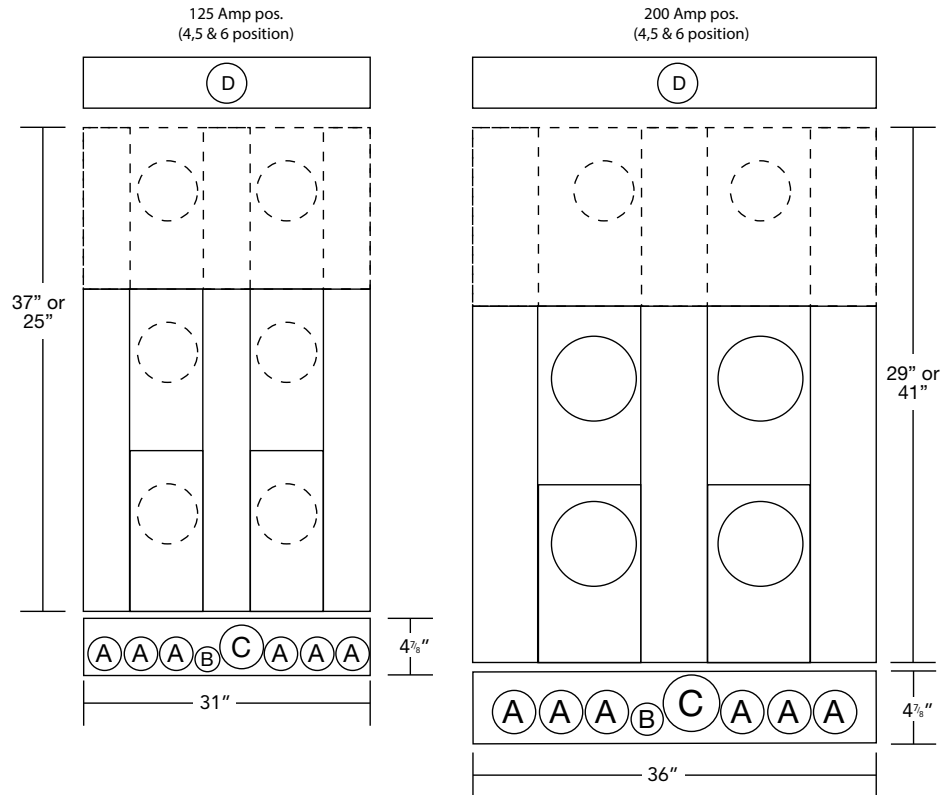

Please consult serving utility for their requirements prior to ordering or installing, as specifications and approvals vary by utility, and may require local electrical inspector approval. All installations must be installed by a licensed electrician and must comply with all national and local codes, laws and regulations. Milbank reserves the right to make changes in specifications and features shown without notice or obligation.



52

125-200 AMP
MULTI-POSITION
METER MAINS

Multi-Position Meter Mains

125-200 Amp | 22K AIC Rated | 240 VAC



U5882-X



U5884-X

4 Terminal | Multi-Position Meter Main | Ringless

Catalog Number	Amp	Positions	Service	Hub	Connectors CU/AL	Bypass	Dimensions			Weight (lbs.)
					Line		D"	W"	H"	
U5902-X	125	2	OH/UG	C.P.	3/8" x 16 Stud	None	5 1/8"	26 1/2"	30"	58
U5903-X	125	3	OH/UG	C.P.	3/8" x 16 Stud	None	5 1/8"	34 5/8"	30"	88
U5904-X	125	4	OH/UG	C.P.	3/8" x 16 Stud	None	5 1/8"	42 5/8"	30"	107
U5905-X	125	5	OH/UG	C.P.	3/8" x 16 Stud	None	5 1/8"	51 1/20"	30"	128
U5906-X	125	6	OH/UG	C.P.	3/8" x 16 Stud	None	5 1/8"	59 3/10"	30"	146
U5882-X	200	2	OH/UG	C.P.	3/8" x 16 Stud	None	5 1/8"	26 1/2"	30"	58
U5883-X	200	3	OH/UG	C.P.	3/8" x 16 Stud	None	5 1/8"	34 5/8"	30"	88
U5884-X	200	4	OH/UG	C.P.	3/8" x 16 Stud	None	5 1/8"	42 5/8"	30"	107
U5885-X	200	5	OH/UG	C.P.	3/8" x 16 Stud	None	5 1/8"	51 1/20"	30"	128
U5886-X	200	6	OH/UG	C.P.	3/8" x 16 Stud	None	5 1/8"	59 3/10"	30"	146

Notes

- **Knockouts:** See drawings on the next page.
- **Optional:** Factory installed breakers are available—consult factory.
- **AIC Rating:** All models are rated 22K AIC when used with approved breakers rated at 22K.
- **Hub:** Units supplied with one (1) closing plate. Order hubs separately, see accessories page.
- **Fifth Terminal:** For field installed fifth terminal, order **K5T**.
- **Connectors:** Socket is supplied with 3/8" - 16 hex head nuts with Belleville washers. For connector lug kits, order as extra from chart on the accessories page. Separate lug kits are required for line and load.

Breaker Chart - 10K AIC (unless noted 22K)

Manufacturer	Cutler Hammer	Siemens	G.E. (50 Amp Max)	Square D
125 Amp or Less	BR, HQP, QPGF	QP, QPH (22K)	THQL, THQL-GF	Homeline
150-200 Amp		QN, QNH (22K)	—	—



Please consult serving utility for their requirements prior to ordering or installing, as specifications and approvals vary by utility, and may require local electrical inspector approval. All installations must be installed by a licensed electrician and must comply with all national and local codes, laws and regulations. Milbank reserves the right to make changes in specifications and features shown without notice or obligation.

Multi-Position Meter Mains

U5902 & U5882 Series | Dimensional Information

53

125-200 AMP
MULTI-POSITION
METER MAINS

Knockouts				
1	2	3	4	5
3	2½	1	7/8	¼

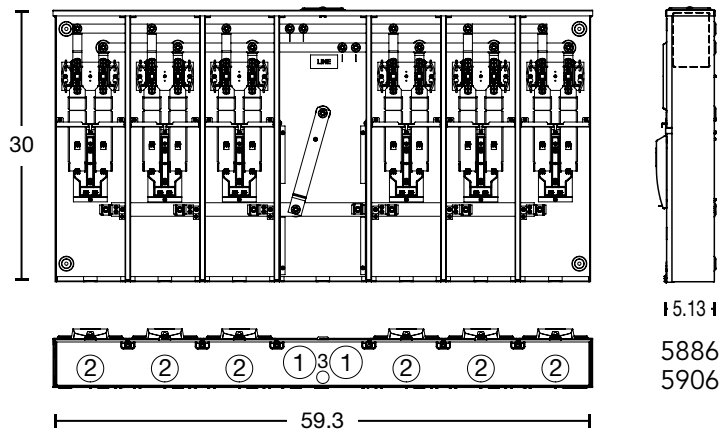
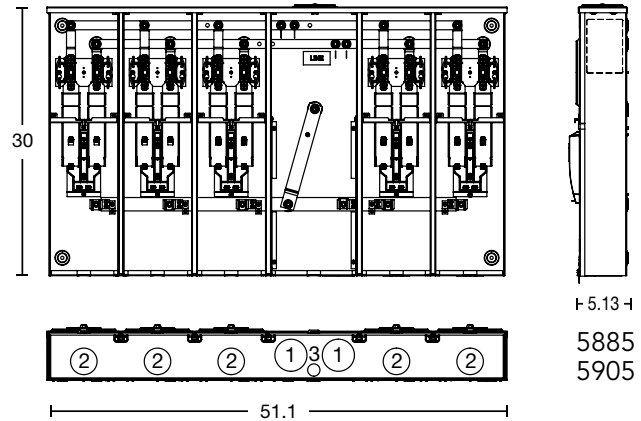
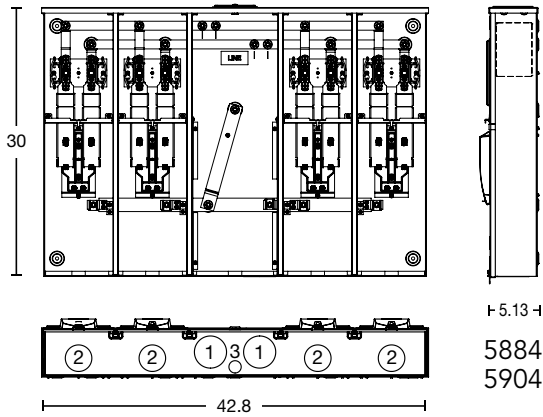
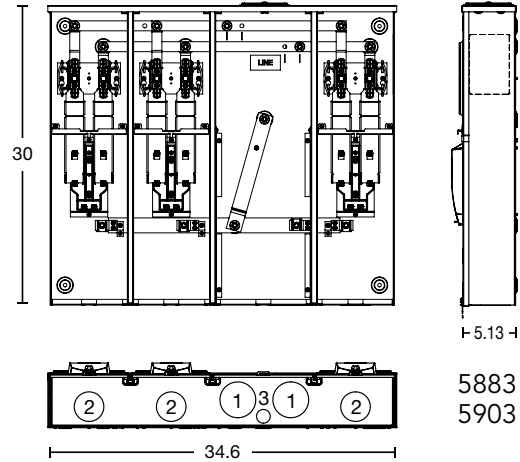
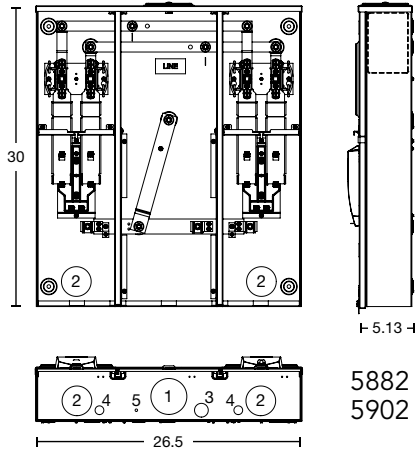

Please consult serving utility for their requirements prior to ordering or installing, as specifications and approvals vary by utility, and may require local electrical inspector approval. All installations must be installed by a licensed electrician and must comply with all national and local codes, laws and regulations. Milbank reserves the right to make changes in specifications and features shown without notice or obligation.





UC7582-XL

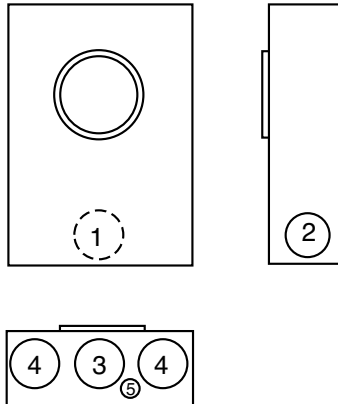

UC7237-RL

20 Amp | Ringless | Plunger Type Bypass | Overhead/Underground

Catalog Number	Terminal	Meter Form	Hub	Bypass	Connectors CU/AL		Dimensions			Knockouts				
					Line	Load	D"	W"	H"	1	2	3	4	5
UC1290-XL	5	3S	C.P.	Plunger*	#14 - #10		3 ⁵ / ₁₆	8	14	1 ¹ / ₂	1 ¹ / ₂	2	1 ¹ / ₄	1 ¹ / ₄
UC1299-XL	6	4S	C.P.	Plunger*	#14 - #10		3 ⁵ / ₁₆	8	14	1 ¹ / ₂	1 ¹ / ₂	2	1 ¹ / ₄	1 ¹ / ₄
UC7233-XL	7	7, 14, 15 & 24 S	C.P.	Plunger*	#14 - #10		3 ⁵ / ₁₆	8	14	1 ¹ / ₂	1 ¹ / ₂	2	1 ¹ / ₄	1 ¹ / ₄
UC7235-XL	8	5S	C.P.	Plunger*	#14 - #10		3 ⁵ / ₁₆	8	14	1 ¹ / ₂	1 ¹ / ₂	2	1 ¹ / ₄	1 ¹ / ₄
UC7237-XL	13	6, 8, 9S & (ALT) 10S	C.P.	Plunger*	#14 - #10		3 ⁵ / ₁₆	8	14	1 ¹ / ₂	1 ¹ / ₂	2	1 ¹ / ₄	1 ¹ / ₄

20 Amp | Ring Type | Plunger Type Bypass | Overhead/Underground

Catalog Number	Terminal	Meter Form	Hub	Bypass	Connectors CU/AL		Dimensions			Knockouts				
					Line	Load	D"	W"	H"	1	2	3	4	5
UC1291-RL	5	3S	H.O.	Plunger*	#14 - #10 Max		3 ⁵ / ₁₆	8	14	1 ¹ / ₂	1 ¹ / ₂	1 ¹ / ₄	1 ¹ / ₄	1 ¹ / ₄
UC1300-RL	6	4S	H.O.	Plunger*	#14 - #10 Max		3 ⁵ / ₁₆	8	14	1 ¹ / ₂	1 ¹ / ₂	1 ¹ / ₄	1 ¹ / ₄	1 ¹ / ₄
UC7544-RL	7	5S	H.O.	Plunger*	#14 - #10 Max		3 ⁵ / ₁₆	8	14	1 ¹ / ₂	1 ¹ / ₂	1 ¹ / ₄	1 ¹ / ₄	1 ¹ / ₄
UC7545-RL	8	6, 8, 9S & (ALT) 10S	H.O.	Plunger*	#14 - #10 Max		3 ⁵ / ₁₆	8	14	1 ¹ / ₂	1 ¹ / ₂	1 ¹ / ₄	1 ¹ / ₄	1 ¹ / ₄
UC7582-RL	13	6, 8, 9S & (ALT) 10S	C.P.	None	#14 - #10 Max		3 ⁵ / ₁₆	8	14	1 ¹ / ₂	1 ¹ / ₂	1 ¹ / ₄	1 ¹ / ₄	1 ¹ / ₄

Notes

- **Hubs:** For proper hub selection see the hub suffix chart on the accessory page.
- **Connectors:** Units are supplied with sleeve type connectors (#14-#2).
- * **Bypass:** Plunger type bypass automatically closes when meter is removed.



Please consult serving utility for their requirements prior to ordering or installing, as specifications and approvals vary by utility, and may require local electrical inspector approval. All installations must be installed by a licensed electrician and must comply with all national and local codes, laws and regulations. Milbank reserves the right to make changes in specifications and features shown without notice or obligation.

Current Transformer

20 Amp | 5, 6, 8, 13, & 15 Terminal | 600 VAC

55
CURRENT
TRANSFORMER



UC3438-XL



UC3426-XL

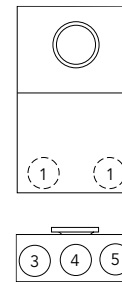
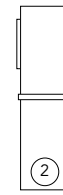
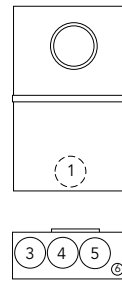

3425
3426
3428
3423
7636
7461

3435
3436
3438
3433
3434

20 Amp | Ringless | With Provision for Test Switch | Two-Piece Front

Catalog Number	Terminal	Meter Form	Service	Hub	Bypass	Connectors CU/AL		Dimensions			Knockouts					
						Line	Load	D"	W"	H"	1	2	3	4	5	6
UC3425-XL	5	3S	OH/UG	C.P.	None	#14 - #2		5½	12	20	1¼	1¼	1¼	1¼	1¼	¼, ½
UC3426-XL	6	4S	OH/UG	C.P.	None	#14 - #2		5½	12	20	1¼	1¼	1¼	1¼	1¼	¼, ½
UC3428-XL	8	5S	OH/UG	C.P.	None	#14 - #2		5½	12	20	1¼	1¼	1¼	1¼	1¼	¼, ½
UC3423-XL	13	6, 8, 9S & (ALT) 10S	OH/UG	C.P.	None	#14 - #2		5½	12	20	1¼	1¼	1¼	1¼	1¼	¼, ½

20 Amp | Ring Type | Test Switch Factory Prewired | Two-Piece Front

Approved for Tucson Electric Power

Catalog Number	Terminal	Service	Hub	Bypass	Connectors CU/AL		Dimensions			Knockouts						
					Line	Load	D"	W"	H"	1	2	3	4	5	6	
UC7636-YL-TGE-DES	6	OH	1¼	Test Switch	#14 - #2		4½	12	20	1¼	1¼	1¼	1¼	1¼	1¼	¼, ½
UC7461-YL-TGE-DES	13	OH	1¼	Test Switch	#14 - #2		4½	12	20	1¼	1¼	1¼	1¼	1¼	1¼	¼, ½

20 Amp | Ring Type | With Provision for Test Switch | EUSERC Compliant | Two-Piece Front

Catalog Number	Terminal	Service	Hub	Bypass	Connectors CU/AL		Dimensions			Knockouts						
					Line	Load	D"	W"	H"	1	2	3	4	5	6	
UC3435-XL	5	OH/UG	C.P.	None	#14 - #2		5½	12	20	2	2	2	2	2	2	-
UC3436-XL	6	OH/UG	C.P.	None	#14 - #2		5½	12	20	2	2	2	2	2	2	-
UC3438-XL	8	OH/UG	C.P.	None	#14 - #2		5½	12	20	2	2	2	2	2	2	-
UC3433-XL	13	OH/UG	C.P.	None	#14 - #2		5½	12	20	2	2	2	2	2	2	-
UC3434-XL	15	OH/UG	C.P.	None	#14 - #2		5½	12	20	2	2	2	2	2	2	-

Notes

- **Prewiring:** If factory prewiring is required consult factory before ordering. Please include meter socket catalog number, test switch number, meter form number, and a copy of your wiring diagram.
- **Test Switch Covers:** Units on this page can be used with clear lexan cover (except units **7636** and **7461**).
- **Connectors:** Units are supplied with sleeve type connectors (#14-#2).
- **Hubs:** For proper hub selection see the hub suffix chart in accessory section.

Please consult serving utility for their requirements prior to ordering or installing, as specifications and approvals vary by utility, and may require local electrical inspector approval. All installations must be installed by a licensed electrician and must comply with all national and local codes, laws and regulations. Milbank reserves the right to make changes in specifications and features shown without notice or obligation.



Current Transformer Test Switches

4, 7, & 10 Pole

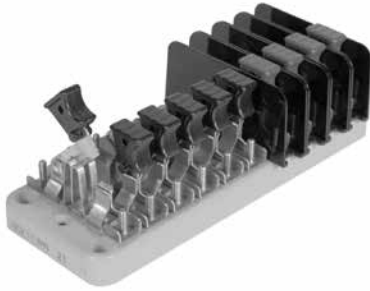

SWITCH BLADES

Two dimples coined into one side of the switch blade ensure positive contact in corrosive, sooty environments – even after years of inactivity.

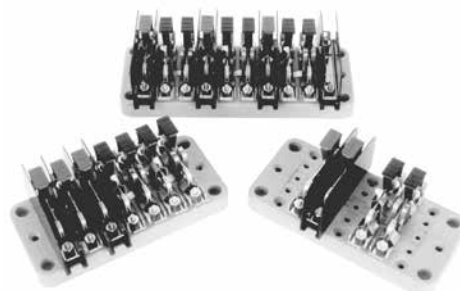

TEST SWITCH BASE

The base is molded from a high strength, fiberglass reinforced, thermoset polyester. This material is track resistant, flame retardant and has low water absorption qualities. Bases are available in 7 pole and 10 pole sizes.



POLARITY BARRIER

For maximum protection potential circuits are supplied with permanently mounted, rigid barriers made from high tensile strength, polycarbonate.

TEST SWITCH COVERS

Standard test switch covers are made from break resistant, clear, thermal plastic which has excellent tracking and moisture resistant properties. If covers are required, add suffix "-WC" (with cover) to the catalog number or order separately catalog number **K3388**. Black flush mount covers are also available. Order catalog number **K3388-BLK-FL**. 10 pole base only.

SWITCH JAWS

The switch blade jaw clips are constructed from spring grade copper alloy. The material and design ensure excellent contact which prevents overheating.

CURRENT CARRYING PARTS

Highly conductive copper and copper alloy materials are used on all current carrying parts. This ensures conductivity and deters corrosion. Spring grades are used where appropriate. Plating is available if required. Contact general offices to special order.

STANDARD COVER



K3388

Units must be
5-1/8" deep
for Cover

FLUSH MOUNT COVER BLACK



K3388-BLK-FL

Notes

- **Factory Installed:** For cover installed add the suffix **-WC** or **-WCFL** to the catalog number of desired test switch
- **Field Installed:** For field installed cover order kit number **K3388** or **K3388-BLK-FL**.

The MILBANK test switch is designed to meet the critical requirements of the electric utility industry. Not only do they meet EEI, ANSI C12.9, and UL standards but they combine several special features giving the MILBANK test switch increased safety, durability and reliability. One such feature is our unique switch blade contact points which cut through residue that builds up after years of service. Another distinction is our polarity barrier which is designed to be flexible as well as offer exceptional insulating qualities. Our test switches are constructed from the latest materials available using modern fabricating and assembly methods.



Please consult serving utility for their requirements prior to ordering or installing, as specifications and approvals vary by utility, and may require local electrical inspector approval. All installations must be installed by a licensed electrician and must comply with all national and local codes, laws and regulations. Milbank reserves the right to make changes in specifications and features shown without notice or obligation.

Current Transformer Test Switches

4, 7, & 10 Pole | 600 VAC | Per Ansi C12.9 Standard

57
CURRENT
TRANSFORMER
TEST SWITCHES

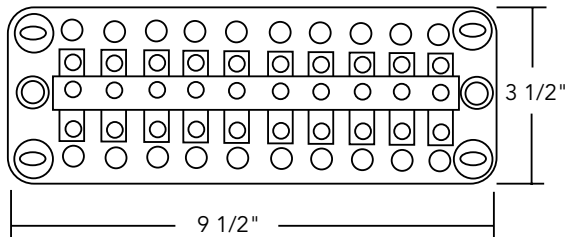
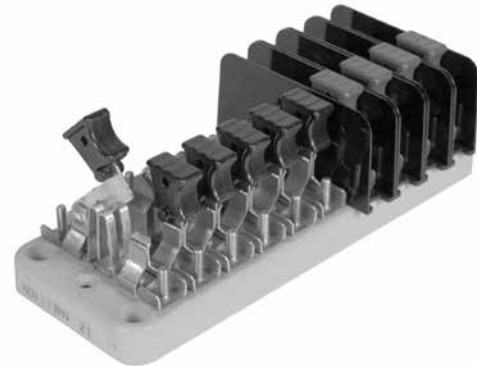
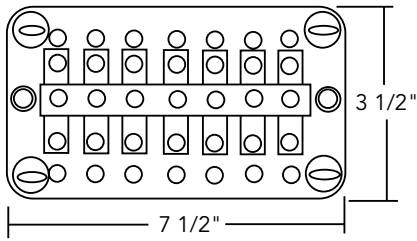

Catalog Number	4-POLE						
TS04-0101	X	P	Pn	X	C+	C	X
TS04-0104	X	C+	C	X	P	Pn	X

KEY	
P	Potential Switch
C+	Line side current switch with short circuit assembly
C	Load side current switch with test jack assembly
N	Neutral bar (no switch)
Pn	Neutral potential switch
X	Unused position on base
	Line side current switch with short circuit assembly

Catalog Number	7-POLE						
TS07-0105	P	P	Pn	C+	C	C+	C

Catalog Number	7-POLE ON A 10-POLE BASE									
TS07-0049	P	X	P	X	Pn	X	C+	C	C	C+
TS07-0106	X	P	C+	C	P	C+	C	Pn	X	X

CUSTOM POLE ARRANGEMENTS

The key may be used to diagram your own pole arrangement. Be sure to specify base size and whether all C+ line side, current switch/shunt circuit assemblies are to be bussed together. The catalog numbers shown above are connected in line-load pairs; therefore, if bussed is required, different catalog numbers will apply.

Catalog Number	10-POLE									
TS10-0109	P	P	P	Pn	C+	C	C+	C	C+	C
TS10-0110	P	C+	C	P	C+	C	P	C+	C	Pn
TS10-0111	P	P	P	Pn	C	C+	C	C+	C	C+
TS10-0112	C+	C	C+	C	C+	C	P	P	P	Pn
TS10-0016	P	P	P	PN	C	C+	C	C+	C	C+

Please consult serving utility for their requirements prior to ordering or installing, as specifications and approvals vary by utility, and may require local electrical inspector approval. All installations must be installed by a licensed electrician and must comply with all national and local codes, laws and regulations. Milbank reserves the right to make changes in specifications and features shown without notice or obligation.



Milbank Test Switch Worksheet



TEST SWITCH BASE

The base is molded from a high strength, fiberglass reinforced, thermoset polyester. This material is track-resistant, flame-retardant and has low water absorption qualities. Bases are available in two standard sizes following NEMA mounting classifications.

Customer Name: _____

Email: _____

Phone: _____

Handle Color Key							
BK	Black	P	Purple	Y	Yellow	GN	Green
R	Red	BL	Blue	W	White	BKS	BK/Stripe
BR	Brown	GR	Gray	O	Orange	WS	W/Stripe

Pole Position Chart

1	2	3	4	5	6	7	8	9	10

Special Features

Features	1	2	3	4	5	6	7	8	9	10

Engineering Information: _____

KEY	
P	Potential Switch
C+	Line side current switch with short circuit assembly
C	Load side current switch with test jack assembly
N	Neutral bar (no switch)
Pn	Neutral potential switch
X	Unused position on base
	Line side current switch with short circuit assembly

Custom Pole Arrangements: The key may be used to diagram your own pole arrangement. Be sure to specify base size and whether all C+ line side, current switch/shunt circuit assemblies are to be bussed together. The catalog numbers shown above are connected in line-load pairs; therefore, if bussed is required, different catalog numbers will apply.

Number of Poles

- 4
- 7
- 10
- Other _____

Test Switch Cover*

- Yes ___ Clear ___ Black
- No

Base Size

- 7-Pole
- 10-Pole

* Test switch covers are only available for 10-pole bases.



Please consult serving utility for their requirements prior to ordering or installing, as specifications and approvals vary by utility, and may require local electrical inspector approval. All installations must be installed by a licensed electrician and must comply with all national and local codes, laws and regulations. Milbank reserves the right to make changes in specifications and features shown without notice or obligation.

Current Transformer Cabinets

Door Mount CT Rated Socket & Type 3R

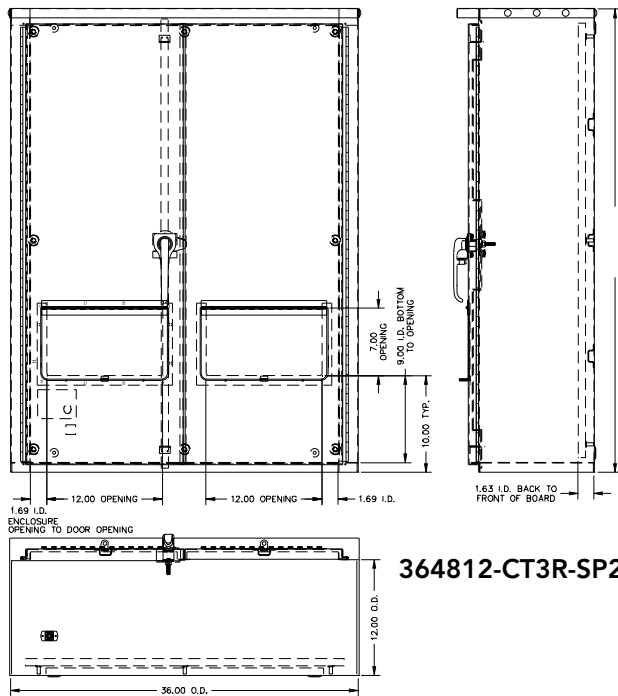

364812-CT3R-SP2

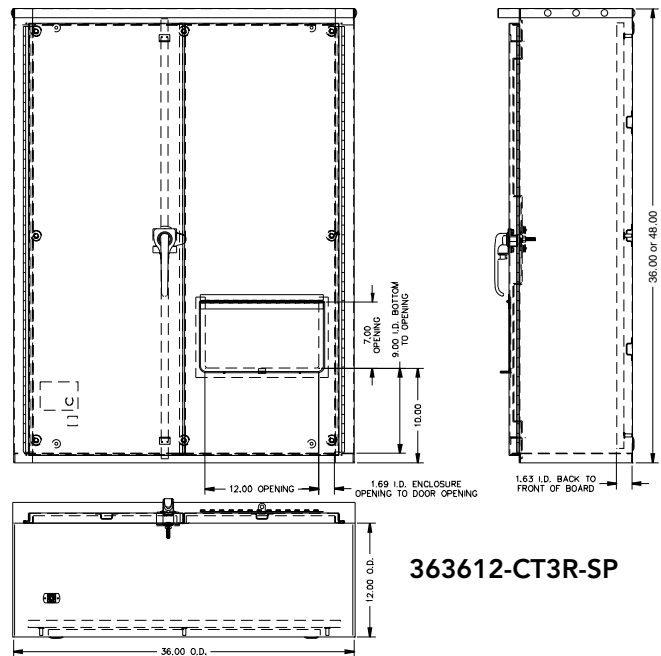

363612-CT3R-SP



Door Mount C.T. Rated Socket

Catalog Number	Terminal	Bypass	Amp	Connectors	Dimensions		
					D"	W"	H"
K4806-BP	13	Plunger	20 A	#14-4 Max	2½	7⅞	7½

Note

BP: The -BP suffix indicates plunger bypass.

Current Transformer Rated Cabinets – Type 3R

Catalog Number	Gauge of Steel	Dimensions			Panel Size		Panel & Backboard Catalog Numbers	
		D"	W"	H"	W" x H"	Painted Steel Panel	Wood Backboard	
243210-LC3R-SP	14	10	24	32	21	29	A-24P32	A-24P32W
323610-LC3R-SP	14	10	32	36	29	33	A-32P36	A-32P36W
363016-CT3R	14	16	36	30	33	27	A-36P30	A-36P30W
363612-CT3R-SP	14	12	36	36	33	33	A-36P36	A-36P36W Included
364812-CT3R-SP2	14	12	36	48	33	45	A-48P36	A-48P36W Included

Please consult serving utility for their requirements prior to ordering or installing, as specifications and approvals vary by utility, and may require local electrical inspector approval. All installations must be installed by a licensed electrician and must comply with all national and local codes, laws and regulations. Milbank reserves the right to make changes in specifications and features shown without notice or obligation.



Current Transformer Cabinets

Mounting Racks

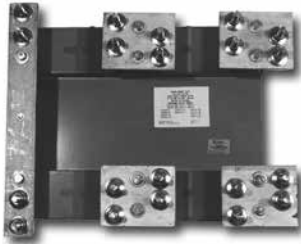

K4797



K4722

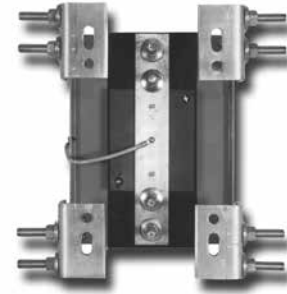

K4793/K4795

Current Transformer Enclosure Mounting Racks

Catalog Number	Code	AIC Rating	Amp	Volts	Type of Service	Termination Type
K4797	A4	50K	400	600	1Ø3W	1/2 x 13 Studs on 1-3/4" Centers
K4797	A	50K	800	600	1Ø3W	1/2 x 13 Studs on 1-3/4" Centers
K4798	B4	50K	400	600	3Ø4W	1/2 x 13 Studs on 1-3/4" Centers
K4798	B	50K	800	600	3Ø4W	1/2 x 13 Studs on 1-3/4" Centers
K4793	C	10K	201-400	600	1Ø3W	1/2 x 13 Studs on 1-3/4" Centers
K4795	D	10K	401-800	600	1Ø3W	1/2 x 13 Studs on 1-3/4" Centers
K4794	E	10K	201-400	600	3Ø4W	1/2 x 13 Studs on 1-3/4" Centers
K4796	F	10K	401-800	600	3Ø4W	1/2 x 13 Studs on 1-3/4" Centers
K4729	G	50K	800	600	1Ø3W	(3) #4 - 600 or (6) #1 - 250
K4722	H	50K	800	600	3Ø4W	(3) #4 - 600 or (6) #1 - 250
K4903	J	50K	400	600	1Ø3W	(1) #4 - 600 or (2) #1 - 250
K4904	K	50K	400	600	3Ø4W	(1) #4 - 600 or (2) #1 - 250
K5747	L	50K	800	600	3Ø4W	Line: 1/2 x 13 Studs on 1-3/4" Centers Load: (3) #4 - 600 or (6) #1 - 250
K5752	M	50K	800	600	1Ø3W	Line: 1/2 x 13 Studs on 1-3/4" Centers Load: (3) #4 - 600 or (6) #1 - 250

Note

- Match red code letter with the applicable CT Cabinet on pages 61 & 62.
- **1/2" Lug Kit:** order **K4200** (single, #4-600) or **K4223** (double, #6-350). Each Kit contains four connectors.



Please consult serving utility for their requirements prior to ordering or installing, as specifications and approvals vary by utility, and may require local electrical inspector approval. All installations must be installed by a licensed electrician and must comply with all national and local codes, laws and regulations. Milbank reserves the right to make changes in specifications and features shown without notice or obligation.

Current Transformer Cabinets

Screw Cover & Hinge Cover



CT363611-SC



CT203611-HC

Screw Cover

Catalog Number	C.T. Racks	Dimensions			Front Cover
		D"	W"	H"	
CT24329-SC	A4, C, D, G, J, M	9	24	32	1 Piece
CT242411-SC	G	11	24	24	1 Piece
CT243011-SC	A4, C, D, G, J, M	11	24	30	1 Piece
CT243611-SC	A4, C, D, G, J, M	11	24	36	1 Piece
CT244811-SC	A, C, D, G, J	11	24	48	1 Piece
CT303011-SC	A4, B4, C, D, E, F, G, H, J, K, L, M	11	30	30	1 Piece
CT303611-SC	A4, B4, C, D, E, F, G, H, J, K, L, M	11	30	36	1 Piece
CT363611-SC	A4, B4, C, D, E, F, G, H, J, K, L, M	11	36	36	1 Piece
CT364211-SC	A, B, C, D, E, F, G, H, J, K, L, M	11	36	42	2 Pieces
CT364811-SC	A, B, C, D, E, F, G, H, J, K, L, M	11	36	48	2 Pieces
CT424211-SC	A, B, C, D, E, F, G, H, J, K, L, M	11	42	42	2 Pieces
CT484811-SC	A, B, C, D, G, J, M	11	48	48	2 Pieces
CT303614-SC	A4, B4, C, D, E, F, G, H, J, K, L, M	14	30	36	2 Pieces
CT364814-SC	A, B, C, D, E, F, G, H, J, K, L, M	14	36	48	2 Pieces
CT484814-SC	A, B, C, D, E, F, G, H, J, K, L, M	14	48	48	2 Pieces

Hinge Cover

Catalog Number	C.T. Racks	Dimensions			Front Cover
		D"	W"	H"	
CT203611-HC	A4, C, D, J	11	20	36	1 Piece
CT243011-HC	A4, C, D, G, J, M	11	24	30	1 Piece
CT243611-HC	A4, C, D, G, J, M	11	24	36	1 Piece
CT244811-HC	A, C, D, G, J, M	11	24	48	1 Piece
CT303611-HC	A4, B4, C, D, E, F, G, H, J, K, L, M	11	30	36	1 Piece
CT304811-HC	A, B, B4, C, D, E, F, G, H, J, K, L, M	11	30	48	1 Piece
CT363611-HC	A4, B4, C, D, E, F, G, H, J, K, L, M	11	36	36	1 Piece
CT364811-HC	A, B, B4, C, D, E, F, G, H, J, K, L, M	11	36	48	1 Piece
CT484811-HC	A, B, C, D, J, M	11	48	48	2 Pieces
CT484814-HC	A, B, B4, C, D, E, F, G, H, J, K, L, M	14	48	48	2 Pieces

Note

- **Enclosure:** These units are rated Type 3R, powder coated, and constructed of galvanized steel.
- **Mounting Rack:** Select CT mounting rack by matching the appropriate letter in **CT rack column** on page 61 with applicable letter in **Code column** on page 60.
- **Mounting:** 1/4-20 welded studs.

Please consult serving utility for their requirements prior to ordering or installing, as specifications and approvals vary by utility, and may require local electrical inspector approval. All installations must be installed by a licensed electrician and must comply with all national and local codes, laws and regulations. Milbank reserves the right to make changes in specifications and features shown without notice or obligation.



Metered Transformer Cabinets

Screw Cover | Ring Type



U3565-O

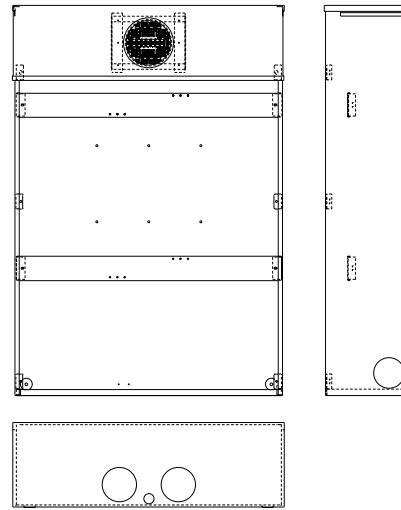

Metered Transformer Cabinets | Ring Type

Catalog Number	Terminal	Service	Meter Form	Hub	Dimensions			CT Racks
					D"	W"	H"	
U3319-R	5	OH	3S	H.O.	11	24	42	A, C, D, G, J, M
U3320-R	6	OH	4S	H.O.	11	24	42	A, C, D, G, J, M
U3321-R	8	OH	5S	H.O.	11	24	42	A, C, D, G, J, M
U3322-R	13	OH	6, 8, 9S & (ALT) 10S	H.O.	11	36	42	A, B, C, D, E, F, G, H, J, K, L, M
U3323-R	8	OH	5S	H.O.	11	36	42	A, B, C, D, E, F, G, H, J, K, L, M
U3555-R	15	OH	39S, 76S	H.O.	11	36	42	A, B, C, D, E, F, G, H, J, K, L, M
U3339-O	5	UG	3S	none	11	24	52	A, C, D, G, J, M
U3340-O	6	UG	4S	none	11	24	52	A, C, D, G, J, M
U3341-O	8	UG	5S	none	11	24	52	A, C, D, G, J, M
U3342-O	13	UG	6, 8, 9S & (ALT) 10S	none	11	36	52	A, B, C, D, E, F, G, H, J, K, L, M
U3343-O	8	UG	5S	none	11	36	52	A, B, C, D, E, F, G, H, J, K, L, M
U3565-O	15	UG	39S, 76S	none	11	36	52	A, B, C, D, E, F, G, H, J, K, L, M

Note

- **Meter Socket:** 20 amp current transformer meter socket built in.
- **Enclosure:** NEMA Type 3R with screw cover.
- **Current Transformer Mounting:** 1/4-20 welded studs.
- **Hubs:** For proper hub selection, see hub suffix chart in the accessory section.
- **Sealing Rings:** Supplied with **MR-4** screw type sealing ring.
- **Mounting Racks:** For mounting rack information refer to previous page. Select CT mounting rack by matching the appropriate letter in **CT rack column** on page 62 with applicable letter in **Code column** on page 60.



Please consult serving utility for their requirements prior to ordering or installing, as specifications and approvals vary by utility, and may require local electrical inspector approval. All installations must be installed by a licensed electrician and must comply with all national and local codes, laws and regulations. Milbank reserves the right to make changes in specifications and features shown without notice or obligation.

Service Pedestals

125 Amp | Mobile Home Metered | 120/240 VAC

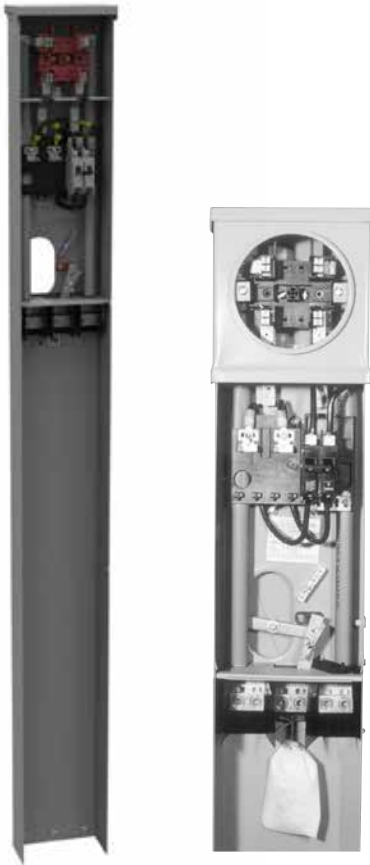

MPRV-100-MB-78

Standard Configurations

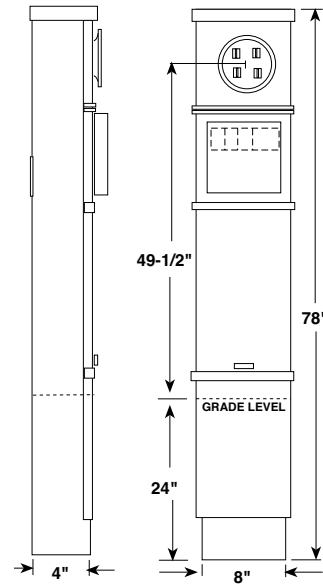
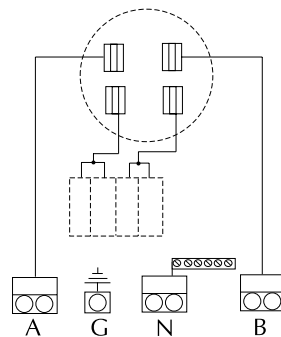
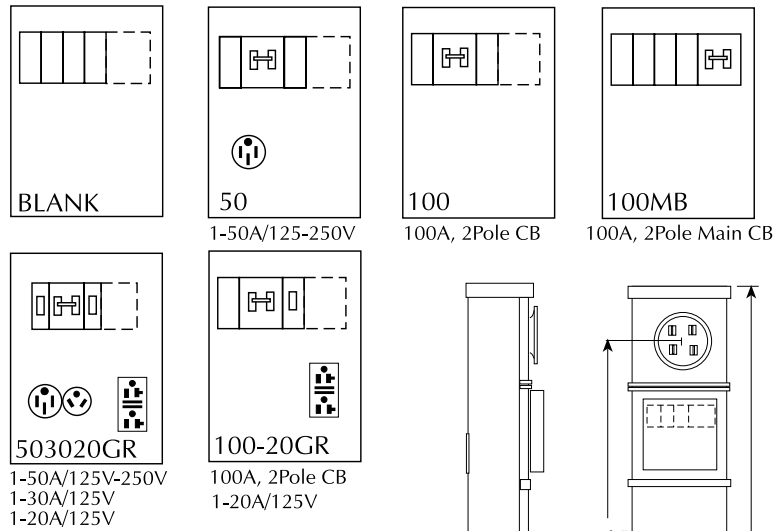

Single

Specifications

- UL listed 100 amp continuous duty meter socket.
- 120/240 volt single phase service.
- Twin line termination lugs #6-350 kcmil CU/AL per phase for looping.
- Space for four (4) single, or one double (240V C/B center- positions only) and two (2) single pole universal style, plug-in circuit breakers.
- Ringless version equipped with horn bypass as standard.
- For fifth terminal field installed order kit **105J** in the 3 o'clock or 9 o'clock position.
- Direct rear feed kit **PF-KR** included.
- For optional stabilizer foot, order **K5763**.
- Specify **MPRV-100-78** for 100 amp service pedestal with direct feed kit and 100 amp CB wired in parallel. Space for two additional single pole CBs provided. Series wiring available; specify **MPRV-100-MB-78**.
- **MR-2** sealing ring standard with ring type cover.
- No knockouts.

Catalog Number	Description
MPRV-BLANK-78	Ring type, parallel wired
MPRV-BLANK-78-R-5T	Ringless, horn bypass
MPRV-100-78	Ring type, parallel wired
MPRV-100-MB-78	Ring type, series wired
MPRV-100-20GR-78	Ring type, parallel wired
MPRV-50-78	Ring type
MPRV-503020GR-78	Ring type

Please consult serving utility for their requirements prior to ordering or installing, as specifications and approvals vary by utility, and may require local electrical inspector approval. All installations must be installed by a licensed electrician and must comply with all national and local codes, laws and regulations. Milbank reserves the right to make changes in specifications and features shown without notice or obligation.



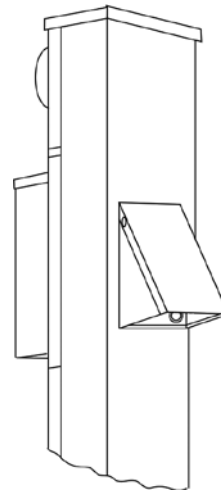
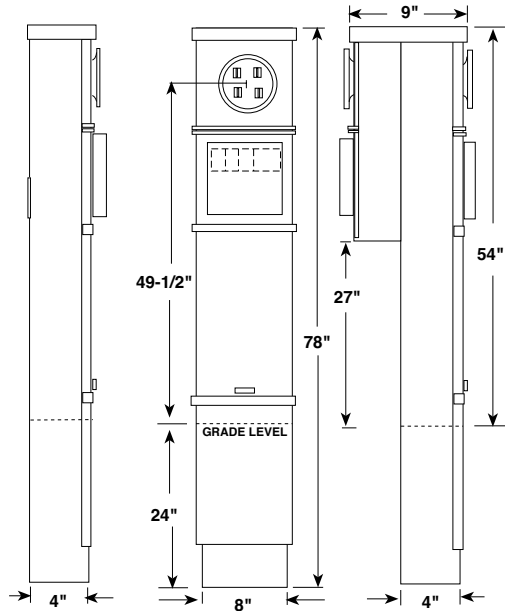

MPAP-200-78

Standard Configurations

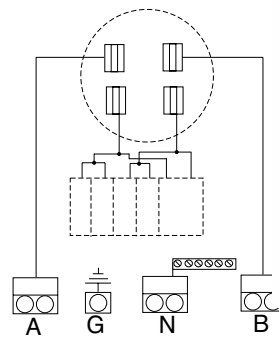
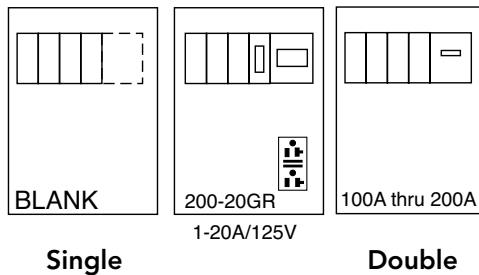

Catalog Number	Description
MPAP-BLANK-78	Ring type, parallel wired
MPAP-BLANK-78R	Ringless, horn bypass, parallel wired
MPAP-100-78	Ring type, parallel wired
MPAP-100-MB-78	Ring type, series wired
MPAP-200-78	Ring type, parallel wired
MPAP-200-MB-78	Ring type, series wired
MPAP-200-20GR-78	Ring type, parallel wired
MPAPD-BLANK-78	Ring type, parallel wired
MPAPD-BLANK-78R	Ringless, horn bypass, parallel wired

Specifications

- 120/240 volt single phase service.
- Twin line termination lugs #6-350 CU/AL per phase for looping.
- **UQFP** breaker provisions factory wired in parallel with branch breaker bus. Series wiring available. Specify **MB** after breaker rating, ex. **MPAP-200-MB**.
- Furnished with space for four single or one double (240V C/B center-positions only) and two single pole universal style, plug-in circuit breakers in addition to main.
- Ringless version equipped with horn bypass as standard.
- For fifth terminal field installed order kit **105J** in the 3 o'clock or 9 o'clock position.
- Direct rear feed kit **PF-KR** included.
- **MR-2** sealing ring standard with ring type cover.
- Series conversion kit order K4714

Notes

- Order K4714 for series wire kit.
- Order K5194 for parallel to series field conversion kit.
- Order K5193 for series to parallel field conversion kit.



Please consult serving utility for their requirements prior to ordering or installing, as specifications and approvals vary by utility, and may require local electrical inspector approval. All installations must be installed by a licensed electrician and must comply with all national and local codes, laws and regulations. Milbank reserves the right to make changes in specifications and features shown without notice or obligation.

Power Pedestals with Load Center

100 & 200 Amp Series MPRV & MPAP | Ring Type

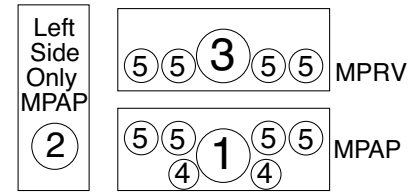
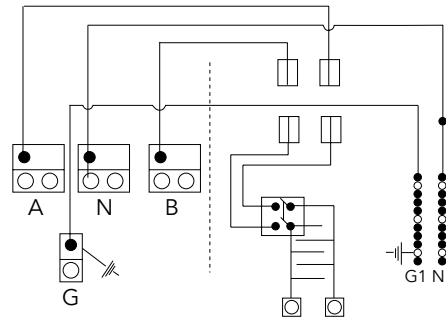
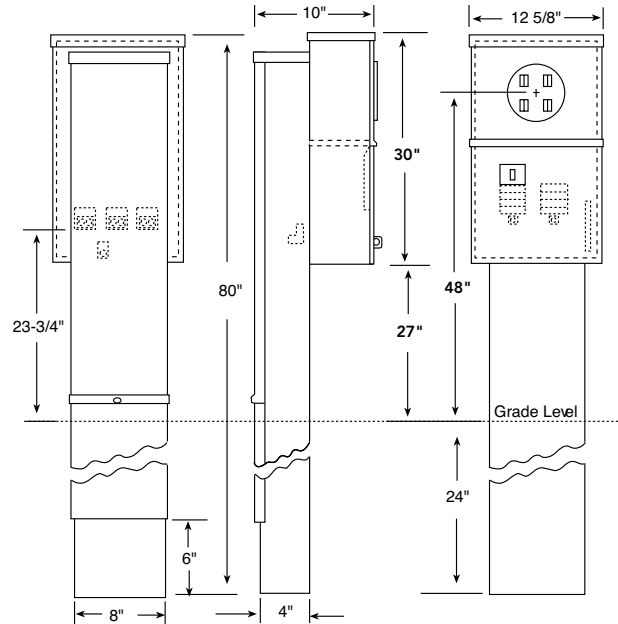

MPAP-200-MBLC-80

100 & 200 Amp | Load Center Power Outlets

Catalog Number	Description	Knockouts				
		1	2	3	4	5
MPRV-100-MBLC-80	100 Amp Metered Pedestal with (8) Circuit Load Center	2½	2	-	1¼	½, ¾
MPAP-200-MBLC-80	200 Amp Metered Pedestal with (8) Circuit Load Center	2½	2	-	1¼	½, ¾

Specifications

- UL listed 100/200 amp continuous duty meter socket.
- Approved for 120/240 volt single phase service.
- Twin line termination lugs #6-350 CU/AL per phase for looping. Rear termination.
- Space for (8) single, or (4) double and two single pole universal style plug-in circuit breakers.
- Series main breaker factory installed.
- Direct feed lugs standard.

Please consult serving utility for their requirements prior to ordering or installing, as specifications and approvals vary by utility, and may require local electrical inspector approval. All installations must be installed by a licensed electrician and must comply with all national and local codes, laws and regulations. Milbank reserves the right to make changes in specifications and features shown without notice or obligation.



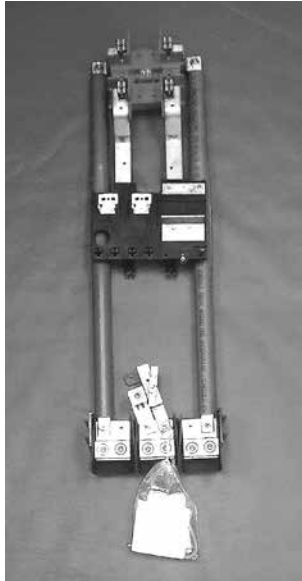

Catalog Number Z020-148-00-00
MPAP 200A interior rebuild kit

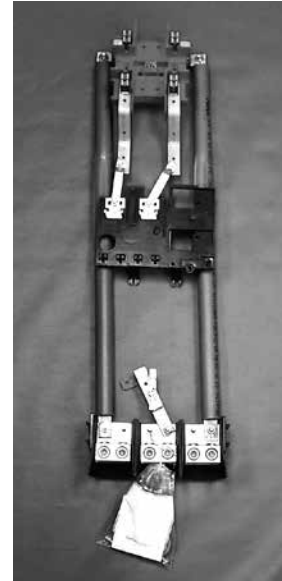

Catalog Number 020-147-00-00
MPRV 100A interior rebuild kit

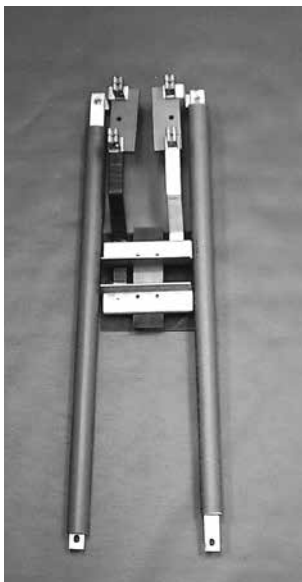

Catalog Number RBK-1
Unicorn MPP (pre-1969)
interior rebuild kit

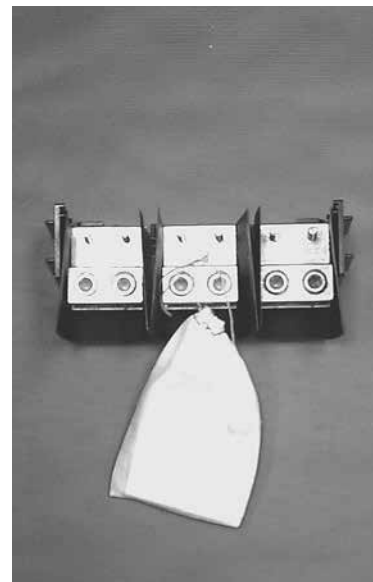

Catalog Number Z1050596
MPAP, MPRV & Unicorn MPP
lug landing assembly with grounding kit

**Above items sold as complete assemblies only.
Individual components not available.**



Please consult serving utility for their requirements prior to ordering or installing, as specifications and approvals vary by utility, and may require local electrical inspector approval. All installations must be installed by a licensed electrician and must comply with all national and local codes, laws and regulations. Milbank reserves the right to make changes in specifications and features shown without notice or obligation.

Replacement Parts

Mobile Home Rebuild Kits

67
REPLACEMENT
PARTS



Catalog Number PF-BL
MPAP/MPRV blank deadfront
with hinged cover



Catalog Number PF-KR
MPAP/MPRV rear connector kit



Lug Cover for MPAP/MPRV
Order Catalog Number **403456-SC**
(8-1/2" W X 20-1/2" H) for 72" pedestals
and Catalog Number **403457-SC** (8-1/2" W X 26-1/2" H)
for 78" pedestals.

Please consult serving utility for their requirements prior to ordering or installing, as specifications and approvals vary by utility, and may require local electrical inspector approval. All installations must be installed by a licensed electrician and must comply with all national and local codes, laws and regulations. Milbank reserves the right to make changes in specifications and features shown without notice or obligation.



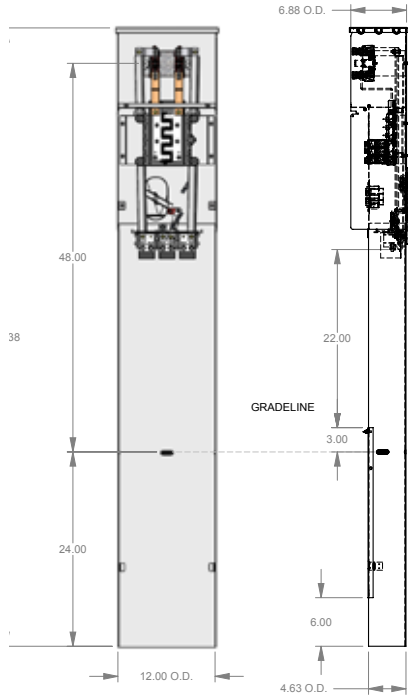

Features and Benefits

- Circuit breaker interior has provisions for twelve full one-inch poles (including main).
- Rating: 100 Amp, 120/240 VAC.
- Interiors will accept plug-in breakers. (GE, Cutler-Hammer, Siemens, SQD)
- Suitable for use as service equipment and mobile home service equipment.
- Rear Feed Kit included in Pedestal
- Twin 350 MCM line terminals (installed) provide optional loop-feed installation.
- 14 gauge corrosion resistant steel construction.
- Type 3R Raintight enclosure.
- Padlock provision.
- Total unit height is 76". Burial depth is 24". Installed height from ground is 48" to meter center.
- Standard color: gray powder coat finish.
- EUSERC compliant drawing number 307
- Pad Mount version available

Catalog Number	Configuration
U6276-O-10GR	(1) 20 amp 5-20R Duplex
U6276-O-54	(1) 50 amp 14-50R Duplex
U6276-O-41	(1) 20 amp 5-20R Duplex (1) 30 amp TT-30R
U6276-O-55	(1) 20 amp 5-20R Duplex (1) 50 amp 14-50GR
U6276-O-75	(1) 50 amp 14-50R (1) 30 amp TT30 (1) 20amp 5-20GR Duplex
U6276-O-100	(1) 100 amp breaker installed
U6276-O-100MB	(1) 100 Main Breaker series wired

Notes

- Contact Factory for additional options
- Extension Kit and Stabilizer Foot Available
- Replacement Parts available (covers, dead-fronts, receptacles, breakers).



Please consult serving utility for their requirements prior to ordering or installing, as specifications and approvals vary by utility, and may require local electrical inspector approval. All installations must be installed by a licensed electrician and must comply with all national and local codes, laws and regulations. Milbank reserves the right to make changes in specifications and features shown without notice or obligation.

Service Pedestals

200 Amp | U5240 & U5241 Series | Ring Type

69
SERVICE
PEDESTALS



U5240-O-200S

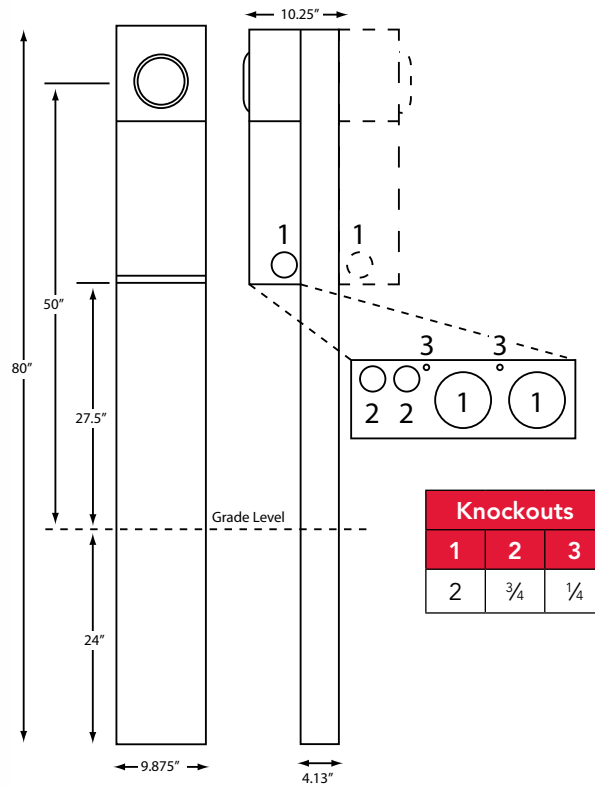

Specifications

- Twin line termination lugs #6-350 CU/AL per phase for looping.
- 200 amp maximum, 120/240 volt, single phase, three wire meter socket.
- Ring type meter socket with stainless steel screw-type sealing ring.
- Short circuit withstand rating 22K AIC.
- Type 3R construction for durable outdoor use, one piece post – lockable and sealable.
- ANSI 61 gray polyester powder coat finish.
- Wire terminations accept copper or aluminum conductors.
- Line & neutral: (2) #6-350 kcmil per phase
- Line ground: (4) #14-1/0
- Load: See Circuit Breaker
- Load neutral: (1) #6-350 kcmil.
- Load ground: (2) #14-1/0, (4) #14/6
- Milbank plug-in main circuit breaker. Available in 100, 125, 150 & 200 amp. Type **UQFPH-M**.
- Four-circuit plated copper interior accepts (2) 2-pole or (4) 1-pole standard plug-in type circuit breakers up to a total of 125 amp maximum. Acceptable manufacturers: Cutler-Hammer, GE or Siemens
- Factory or field-installable receptacle bridge and receptacle/circuit breaker kits available. See accessories.

Please consult serving utility for their requirements prior to ordering or installing, as specifications and approvals vary by utility, and may require local electrical inspector approval. All installations must be installed by a licensed electrician and must comply with all national and local codes, laws and regulations. Milbank reserves the right to make changes in specifications and features shown without notice or obligation.



200 Amp | 4 Terminal | Service Pedestals | Ring Type

Catalog Number	Powerheads	Mounting	Main Breaker	Main CB	Circuits	Dimensions		
						D"	W"	H"
U5240-O-100S	Single	Direct Burial	UQFPH-M-100	100	4	10¼	10	80
U5240-O-200S	Single	Direct Burial	UQFPH-M-200	200	4	10¼	10	80
U5240-O	Single	Direct Burial	Provision for UQFPH-M series	—	4	10¼	10	80
U5242-O-200S	Single	Pad Mount	UQFPH-M-200	200	4	10¼	10	56
U5242-O	Single	Pad Mount	Provision for UQFPH-M series	—	4	10¼	10	56
U5241-O-100S	Double	Direct Burial	(2) UQFPH-M-100	100	4	16	10	80
U5241-O-200S	Double	Direct Burial	(2) UQFPH-M-200	200	4	16	10	80
U5241-O	Double	Direct Burial	Provision for (2) UQFPH-M series	—	4	16	10	80
U5243-O	Double	Pad Mount	Provision for (2) UQFPH-M series	—	4	16	10	56

Accessories

Catalog Number	Description
K5415	Stabilizer foot with hardware
K5035	Pad mount kit with hardware for U5242 & U5243
K5T	5th terminal for 208y/120V 3-wire service
K5193	Bus kit to convert series-wired main breaker to parallel
K5194	Wire kit to convert parallel-wired main breaker to series
K3450	Telephone/CATV mounting bracket (mounts left or right)
K5039	Penta bolt utility cover

Notes

- Up to two receptacle/circuit breaker kits can be field-installed in each powerhead. Order mounting bridge and receptacle kits separately from above. For three receptacles or factory-installed kits, contact factory.
- **K5415** Stabilizer Foot sold separately. Recommended for double pedestals.
- Pad mount pedestals require **K5035** pad mount kit. Order separately.
- Receptacles and circuit breakers can be found in the accessories section.

Service Pedestals

200 Amp | Ringless

71
SERVICE
PEDESTAL



U5136-O-200S

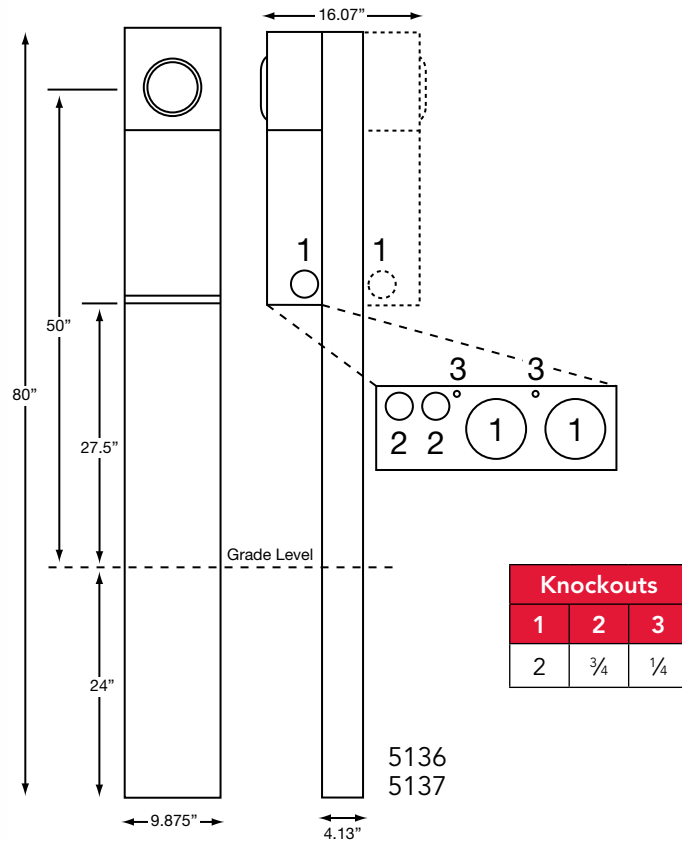

5136
5137

Specifications

- UL listed
- 200 amp maximum, 120/240 V, 1Ø3W
- Ringless type meter socket with stainless steel latch
- Short circuit withstand rating 22 KAIC
- Type 3R construction for durable outdoor use
- ANSI 61 gray polyester powder coat finish
- Wire terminations accept copper or aluminum conductors
- Line & Neutral: (2) #6-350 kcmil per phase, Line Ground: (4) #14-1/0
- Load (CB): 2/0 to 300 kcmil per pole
- Load neutral: (1) #6-350 kcmil
- Load ground: (2) #14-1/0, (4) #14/6
- Commercial grade, plug-in main circuit breaker. Available in 100, 125, 150 & 200 AMP. Type UQFP-H-M.
- 4 circuit plated copper interior accepts (2) 2-pole or (4) 1-pole standard plug-in type circuit breakers. Branch circuit rated to 125 amp max. Acceptable manufacturers: Milbank, Cutler-Hammer, GE or Siemens
- Twin line termination lugs #6-350 CU/AL per phase for looping.

Please consult serving utility for their requirements prior to ordering or installing, as specifications and approvals vary by utility, and may require local electrical inspector approval. All installations must be installed by a licensed electrician and must comply with all national and local codes, laws and regulations. Milbank reserves the right to make changes in specifications and features shown without notice or obligation.



100–200 Amp | Meter Main with Load Center Pedestals | Ringless

Catalog Number	Powerheads	Mounting	Amp	Main Breaker	Interior	Dimensions			Knockouts		
						D"	W"	H"	1	2	3
U5136-O-100S	Single	Direct Burial	100	UQFPH-M-100	4 circuit	10 $\frac{1}{4}$	10	80	2	1 $\frac{1}{2}$, 3 $\frac{3}{4}$	1 $\frac{1}{4}$
U5136-O-200S	Single	Direct Burial	200	UQFPH-M-200	4 circuit	10 $\frac{1}{4}$	10	80	2	1 $\frac{1}{2}$, 3 $\frac{3}{4}$	1 $\frac{1}{4}$
U5136-O	Single	Direct Burial	—	Provision for UQFPH-M series	4 circuit	10 $\frac{1}{4}$	10	80	2	1 $\frac{1}{2}$, 3 $\frac{3}{4}$	1 $\frac{1}{4}$
U5137-O-100S	Double	Direct Burial	100	(2) UQFPH-M-100	4 circuit	16 $\frac{1}{6}$	10	80	2	1 $\frac{1}{2}$, 3 $\frac{3}{4}$	1 $\frac{1}{4}$
U5137-O-200S	Double	Direct Burial	200	(2) UQFPH-M-200	4 circuit	16 $\frac{1}{6}$	10	80	2	1 $\frac{1}{2}$, 3 $\frac{3}{4}$	1 $\frac{1}{4}$
U5137-O	Double	Direct Burial	—	Provision for (2) UQFPH-M series	4 circuit	16 $\frac{1}{6}$	10	80	2	1 $\frac{1}{2}$, 3 $\frac{3}{4}$	1 $\frac{1}{4}$
U5138-O-200S	Single	Pad Mount	200	UQFPH-M-200	4 circuit	10 $\frac{1}{4}$	10	56	2	1 $\frac{1}{2}$, 3 $\frac{3}{4}$	1 $\frac{1}{4}$
U5138-O	Single	Pad Mount	—	Provision for UQFPH-M series	4 circuit	10 $\frac{1}{4}$	10	56	2	1 $\frac{1}{2}$, 3 $\frac{3}{4}$	1 $\frac{1}{4}$
U5139-O	Double	Pad Mount	—	Provision for UQFPH-M series	4 circuit	16 $\frac{1}{6}$	10	56	2	1 $\frac{1}{2}$, 3 $\frac{3}{4}$	1 $\frac{1}{4}$

Accessories

Catalog Number	Description
K5415	Stabilizer foot with hardware
K5035	Pad mount kit with hardware for U5138
K5T	5th terminal for 208y/120V 3-wire service
K5193	Bus kit to convert series-wired main breaker to parallel
K5194	Wire kit to convert parallel-wired main breaker to series
K3450	Telephone/CATV mounting bracket (mounts left or right)
K5039	Penta bolt utility cover

Notes

- **Parallel to Series Conversion:** For field converting from parallel wired to series wired order **K5194**.
- **Fifth Terminal:** For field installed fifth terminal, order **K5T**.
- **Stabilizer Foot:** For field installed stabilizer foot, order **K5415**.
- **Penta Bolt Locking:** For field installed pedestal fronts penta bolt locking, order **K5039**.
- **Pad Mount Units:** Pad mount pedestals require **K5035** pad mount kit. Order separately.
- Receptacles and circuit breakers can be found in the accessories section.



Please consult serving utility for their requirements prior to ordering or installing, as specifications and approvals vary by utility, and may require local electrical inspector approval. All installations must be installed by a licensed electrician and must comply with all national and local codes, laws and regulations. Milbank reserves the right to make changes in specifications and features shown without notice or obligation.

Service Pedestals

U5706 Series | Ringless

73
SERVICE
PEDESTALS

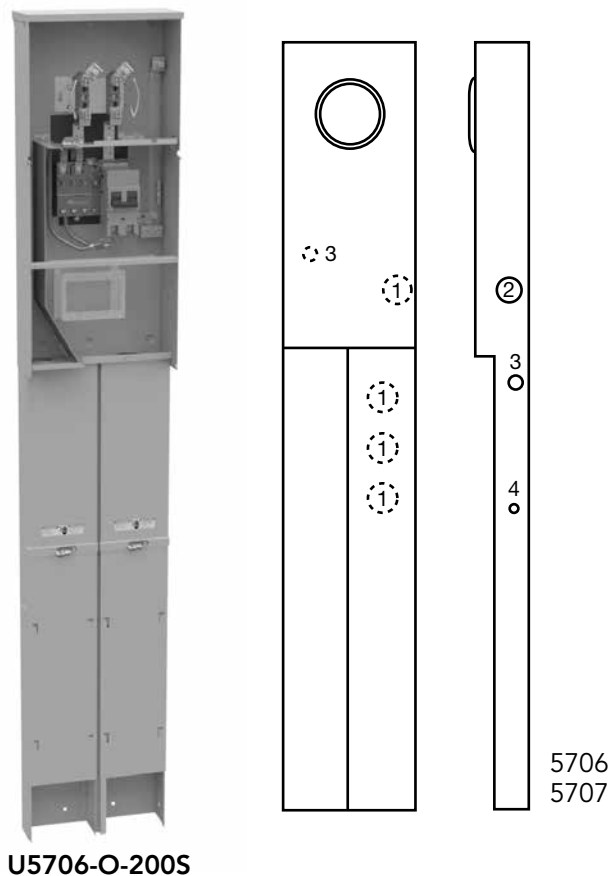

Specifications

- 200 amp, 1Ø, 120/240 volt, 22K AIC, underground service only.
 - U5706 has ringless meter socket available with or without horn bypass (-KK).
 - U5707 has ring type meter socket with MR-4 screw type meter ring.
 - Suitable for use as service equipment, mobile home service equipment and temporary power service equipment.
 - Direct burial pedestal suitable for free standing or structure mounted installation.
 - Separate line and load wireways are removable, lockable and sealable for security.
 - Left side is for utility connection. Right side is for customer underground load exit.
 - Convenient knockouts in post for through-wall load exit requirements.
 - Type 3R enclosure constructed with type G90 galvanized steel.
 - Repaintable light gray polyester powder coat finish.
 - Wire terminations accept copper or aluminum conductors: Line & Neutral: #6-350 Ground: (4) #14-1/0.
 - Main circuit breaker can be series or parallel connected.
 - Universal 4 circuit branch 125 amp interior (up to (2) 2-pole) accepts most manufacturers plug-in type circuit breakers. See wiring diagram.
- *Provisions for up to two Type 3R in-use receptacle.
- *Order receptacle and bridge separately. See ordering information.

Please consult serving utility for their requirements prior to ordering or installing, as specifications and approvals vary by utility, and may require local electrical inspector approval. All installations must be installed by a licensed electrician and must comply with all national and local codes, laws and regulations. Milbank reserves the right to make changes in specifications and features shown without notice or obligation.



200 Amp | 4 Terminal | Meter Main Pedestal | Ringless

Catalog Number	Service	Bypass	Connectors CU/AL		Dimensions			Knockouts			
			Line	Load	D"	W"	H"	1	2	3	4
U5706-O-200S	UG	None	#6-350	CB	5½	14	80	2½	2	1	¼,½
U5706-O-200S-KK	UG	Horn	#6-350	CB	5½	14	80	2½	2	1	¼,½

200 Amp | 4 Terminal | Meter Main Pedestal | Ring Type

Catalog Number	Service	Bypass	Connectors CU/AL		Dimensions			Knockouts			
			Line	Load	D"	W"	H"	1	2	3	4
U5707-O-200S	UG	None	#6-350	CB	5½	14	80	2½	2	1	¼,½

Notes

- **Fifth Terminal:** For field installed fifth terminal, order **K5T**.
- **Receptacles:** Maximum of two receptacles can be added. Contact Milbank for details.
- **Post Extension Kit:** To increase pedestal height, order field-installed post extension kit **K5708**.
- **Series-to-Parallel Field Conversion:** For field conversion from series to parallel wired, order kit **K5193**.
- **Branch Circuit Breakers (Four Additional Single Pole Spaces):** Branch interior accepts most manufacturers' small frame plug-in type circuit breakers (GE, Siemens, Cutler Hammer). Load center's four left stabs are rated up to 125 amp total.

Accessories



K5400-BRIDGE-1POS



K5400-BRIDGE-2POS



UQFPH-M-200

Temporary Power

75
TEMPORARY
POWER

U4908 & U4909 Underground Service Power Outlet



U4909-O-11GR

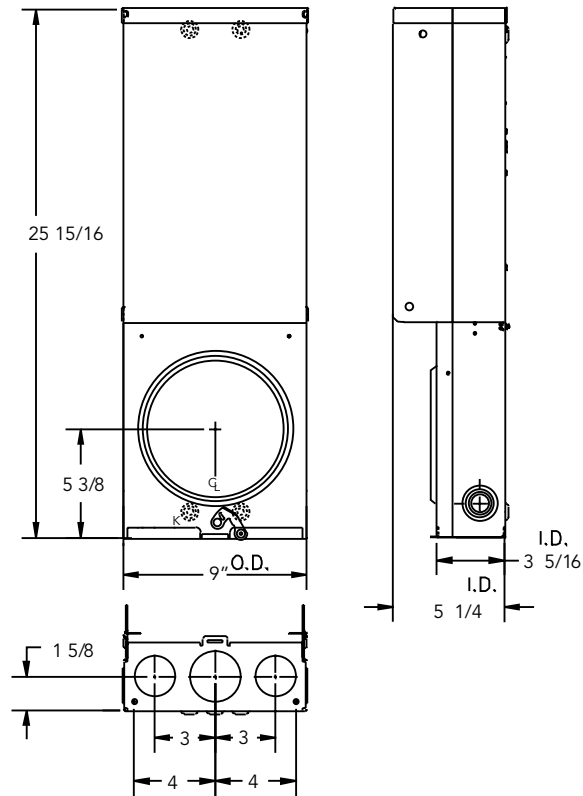

Specifications

- Available in ringless style (**U4908** series) or ring type (**U4909** series).
- UL listed 100 amp, 120/240 Volt – 1Ø Underground Service Power Outlets.
- Short circuit current withstand rating 10K RMS symmetrical amperes.
- Type 3R welded enclosure for durable outdoor use.
- Enclosure constructed with galvanized 16 gauge steel.
- ANSI 61 gray polyester powder coat finish.
- Convenient concentric knock-out configurations and mounting embosses.
- Wire terminations accept copper or aluminum conductors.
Service – Line & Neutral: (1) #6-2/0 Load Ground: (2) 1/0-#14 & (4) #6-#14
Load Neutral: (2) 1/0-#14 & (4) #6-#14 Service Ground: #2-#8
- Six circuit plated copper interior accepts standard plug-in type circuit breakers.
- Three position **self-grounded** receptacle bridge accepts most standard NEMA receptacles with mounting plates.
- Four terminal, ringless meter socket with stainless steel locking hasp. Ring type socket has aluminum **MR-2** snap action sealing ring.
- Lockable hinge cover and deadfront are removable for installation and maintenance. Stay-open hinge cover has safety interlock on deadfront. Deadfront must be removed before hinge cover can be removed.
- Tamper proof fastening available.

Please consult serving utility for their requirements prior to ordering or installing, as specifications and approvals vary by utility, and may require local electrical inspector approval. All installations must be installed by a licensed electrician and must comply with all national and local codes, laws and regulations. Milbank reserves the right to make changes in specifications and features shown without notice or obligation.



U4908 & U4909 Standard Configurations

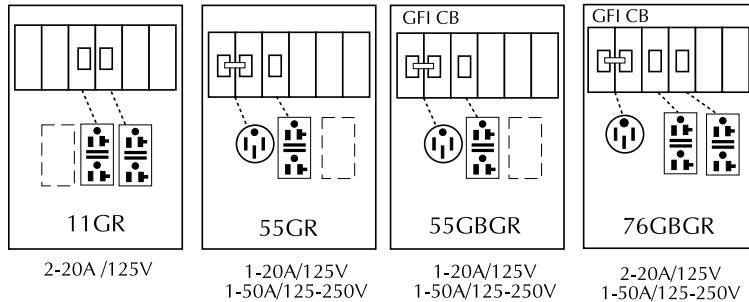

Ordering Information

Catalog Number	Socket Type	Description
• U4908-O	Ringless	Order base model and up to three factory installed receptacle/breaker kit separately from list below. Other kits available. Consult factory.
• U4908-O-11GR	Ringless	
• U4908-O-55GBGR	Ringless	
• U4909-O	Ring type	Order base model and up to three factory installed receptacle/breaker kit separately from list below. Other kits available. Consult factory.
• U4909-O-11GR	Ring type	
• U4909-O-55GBGR	Ring type	

Note: Flat cover may not close completely with twist locking devices in use.

Order slope-front 3R cover #1107681 separately to use with twist lock type receptacles.

- Stock item – availability subject to prior sale.
- Non-stock items – minimum order quantity required.

Temporary Power

Series U5001 Unmetered Service Mount Power Outlet

77
TEMPORARY
POWER



U5001-RL-01

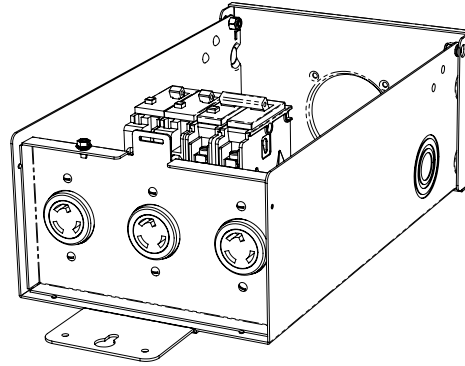

Specifications

- UL listed 125 amp, 120/240 Volt, 1Ø Power Outlet.
- Short circuit current withstand rating 10K RMS symmetrical amperes.
- Type 3R welded enclosure for durable outdoor use.
- ANSI 61 gray polyester powder coat finish.
- Wire terminations accept copper or aluminum conductors.
Line: 1/0-#4 Ground/Neutral: (4) 1/0-#14 & (11) #14-#6
- Six circuit plated copper interior accepts standard plug-in type circuit breakers.
- Components factory wired with stranded copper wire.
- Lockable hinge cover and deadfront are removable for installation and maintenance.
- U5001-RL-01 includes:
 - (1) L6-30 (1) 30 Amp, 2P, 240V GFI Breaker
 - (2) L5-20 (2) 20 Amp, 1P, 120V GFI Breaker

Please consult serving utility for their requirements prior to ordering or installing, as specifications and approvals vary by utility, and may require local electrical inspector approval. All installations must be installed by a licensed electrician and must comply with all national and local codes, laws and regulations. Milbank reserves the right to make changes in specifications and features shown without notice or obligation.





U5865-XL-38GBGRW

Specifications

- UL listed 125 amp, 120/240 Volt, 1Ø Power Outlet.
- Short circuit current withstand rating 10K RMS symmetrical amperes.
- Type 3R welded enclosure for durable outdoor use.
- ANSI 61 gray polyester powder coat finish.
- Wire terminations accept copper or aluminum conductors.
Line & Line Neutral: 250-#6
- Six circuit plated copper interior accepts standard plug-in type circuit breakers.
- Components factory wired with stranded copper wire.
- Lockable hinge cover and deadfront are removable for installation and maintenance.
- **U5865-XL-38GBGRW** includes:
 - (1) L6-30 (1) 30A, 2P, 240V GFI Breaker
 - (2) L5-20 GFI receptacles (2) 20A, IP, 120V Breaker

Temporary Power

Series U5001 Unmetered Service Mount Power Outlet

Catalog Number	Circuit Breaker Description
Q115	15 Amp – 1 Pole – 120/240 – Plug-In Circuit Breaker
Q120	20 Amp – 1 Pole – 120/240 – Plug-In Circuit Breaker
Q130	30 Amp – 1 Pole – 120/240 – Plug-In Circuit Breaker
Q220	20 Amp – 1 Pole – 120/240 – Plug-In Circuit Breaker
Q250	50 Amp – 2 Pole – 120/240 – Plug-In Circuit Breaker
Q2100	100 Amp – 2 Pole – 120/240 – Plug-In Circuit Breaker
708784-MO	20 Amp – GFCI – 1 Pole – 120/240 – Plug-In Circuit Breaker
708785-MO	30 Amp – GFCI – 1 Pole – 120/240 – Plug-In Circuit Breaker
707915-MO	50 Amp – GFCI – 1 Pole – 120/240 – Plug-In Circuit Breaker
703997-MO	50 Amp – Quad – 2 Pole – 120/240 – Circuit Breaker

Catalog Number	Receptacle Description
708777-MO	20 Amp – 120V – NEMA 5-20R – Duplex Receptacle
708080-MO	20 Amp – 120V – NEMA 5-20 – GFCI Duplex Receptacle
704995-MO	20 Amp – 250V – NEMA 6-20R – Single Receptacle
701776-MO	30 Amp – 120V – NEMA TT-30R – Travel Trailer Receptacle
706761-MO	50 Amp – 120V – 3 Pole – 3 Wire – NEMA 10-50R – Receptacle
Z700911-MO	50 Amp – 120/250V – 3 Pole – 4 Wire – NEMA 14-50R – Receptacle

Catalog Number	Lug Landings & Breaker Base Description
Z1050596	MPRV/MPAP – Lug Landing (Twin #6-350 KCMIL)
Z020-148-00-00-0	MPAP – Complete Interior Assembly

Note

- The following brand names may be supplied when replacement circuit breakers are ordered:
Cutler-Hammer/ Westinghouse – QP, BQC, BD, BR. Siemens/ITE – Q, QT. General Electric – TQ, THQ, THQL.
Challenger – C, Q, QC, QP. Contact sales office for brand specific requirements.

Please consult serving utility for their requirements prior to ordering or installing, as specifications and approvals vary by utility, and may require local electrical inspector approval. All installations must be installed by a licensed electrician and must comply with all national and local codes, laws and regulations. Milbank reserves the right to make changes in specifications and features shown without notice or obligation.



Surface Mount Power Outlets

Millennium Series | 120/240 VAC



U5000-XL-75

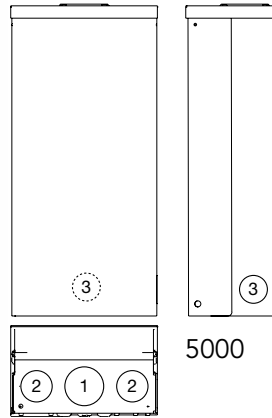

5000



U5100-XL-75

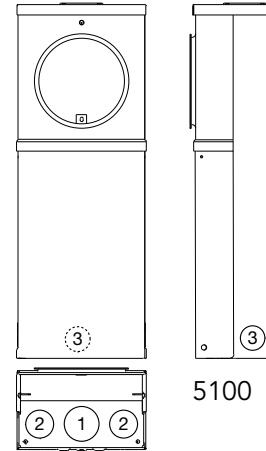

5100

125 Amp | Surface Mount Power Outlets

Catalog Number	Metered/Unmetered	Receptacle Configuration	Circuit Breaker Configuration	Loop Feed	Connectors Line	Dimensions			Knockouts		
						D"	W"	H"	1	2	3
U5000-XL	Unmetered	—	—	Yes	(2) 1/0-#12	5½	9⅞	19¼	2	1½	1¼
U5000-XL-41	Unmetered	A	X	Yes	(2) 1/0-#12	5½	9⅞	19¼	2	1½	1¼
U5000-XL-55	Unmetered	B	Y	Yes	(2) 1/0-#12	5½	9⅞	19¼	2	1½	1¼
U5000-XL-75	Unmetered	C	Z	Yes	(2) 1/0-#12	5½	9⅞	19¼	2	1½	1¼
U5100-XL	Metered	—	—	No	#6-250	5½	9⅞	25	2	1½	1¼
U5100-XL-41	Metered	A	X	No	#6-250	5½	9⅞	25	2	1½	1¼
U5100-XL-55	Metered	B	Y	No	#6-250	5½	9⅞	25	2	1½	1¼
U5100-XL-75	Metered	C	Z	No	#6-250	5½	9⅞	25	2	1½	1¼

Receptacle Configurations

A	B	C
(1) TT30R, (1) 5-20R GFI	(1) 14-50R, (1) 5-20R GFI	(1) 14-50R, (1) TT30R, (1) 5-20R GFI

Circuit Breaker Configurations

X	Y	Z
(1) 30A, 1P, 120V (1) 20A, 1P, 120V	(1) 50A, 2P, 120/240V (1) 20A, 1P, 120V	(1) 50A, 2P, 120/240V (1) 30A, 1P, 120V (1) 20A, 1P, 120V

NOTE

These units are typically used for submetering applications.

Contact factory for additional configurations not shown here.



Please consult serving utility for their requirements prior to ordering or installing, as specifications and approvals vary by utility, and may require local electrical inspector approval. All installations must be installed by a licensed electrician and must comply with all national and local codes, laws and regulations. Milbank reserves the right to make changes in specifications and features shown without notice or obligation.

Power Outlet Pedestals

Millennium Series | 120/240 VAC

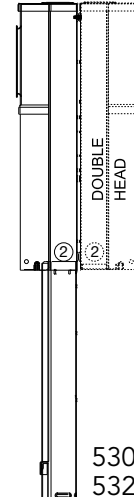
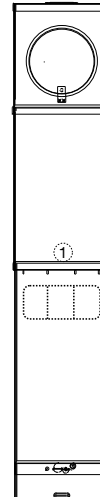
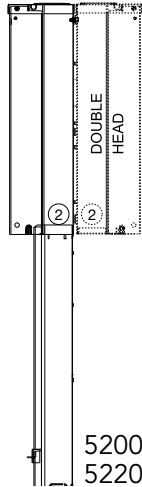
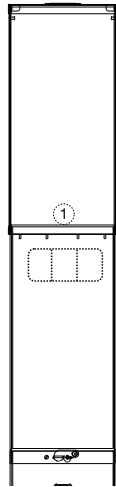

U5200-XL-75

U5300-O-75

125 Amp | Power Outlet Pedestals

Catalog Number	Double Head Catalog Number	Metered/Unmetered	Receptacle Configuration	Circuit Breaker Configuration	Dimensions			Mounting Type
					D"	W"	H"	
U5200-XL	U5220-XL	Unmetered	—	—	5 ⁵ / ₁₆	9 ⁷ / ₈	64 ¹ / ₂	Direct Burial
U5200-XL-41	U5220-XL-41	Unmetered	A	X	5 ⁵ / ₁₆	9 ⁷ / ₈	64 ¹ / ₂	Direct Burial
U5200-XL-55	U5220-XL-55	Unmetered	B	Y	5 ⁵ / ₁₆	9 ⁷ / ₈	64 ¹ / ₂	Direct Burial
U5200-XL-75	U5220-XL-75	Unmetered	C	Z	5 ⁵ / ₁₆	9 ⁷ / ₈	64 ¹ / ₂	Direct Burial
U5300-O	U5320-O	Metered	—	—	5 ⁵ / ₁₆	9 ⁷ / ₈	70 ¹ / ₄	Direct Burial
U5300-O-41	U5320-O-41	Metered	A	X	5 ⁵ / ₁₆	9 ⁷ / ₈	70 ¹ / ₄	Direct Burial
U5300-O-55	U5320-O-55	Metered	B	Y	5 ⁵ / ₁₆	9 ⁷ / ₈	70 ¹ / ₄	Direct Burial
U5300-O-75	U5320-O-75	Metered	C	Z	5 ⁵ / ₁₆	9 ⁷ / ₈	70 ¹ / ₄	Direct Burial

Notes

- **Receptacle Configurations** - Reference chart on page 79.

NOTE

These units are typically used for submetering applications. Contact factory for additional configurations not shown here. Pad mount is available. Contact factory for information.

Please consult serving utility for their requirements prior to ordering or installing, as specifications and approvals vary by utility, and may require local electrical inspector approval. All installations must be installed by a licensed electrician and must comply with all national and local codes, laws and regulations. Milbank reserves the right to make changes in specifications and features shown without notice or obligation.



Replacement Receptacle Plates

For Millennium Series Products

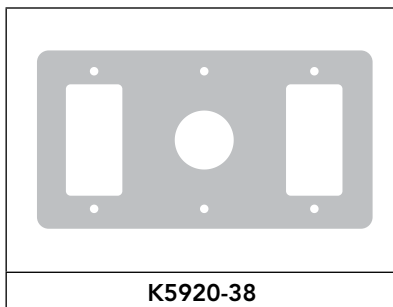
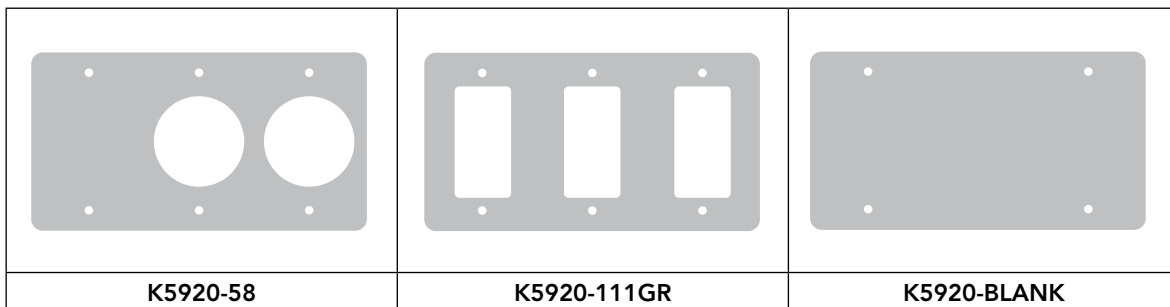
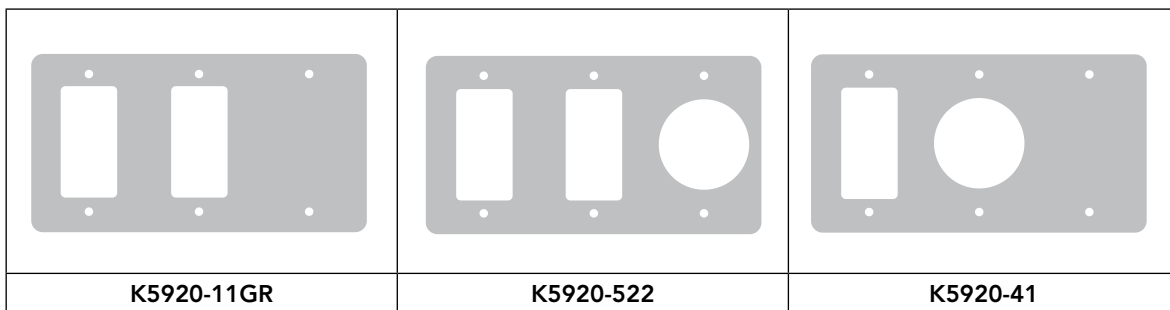
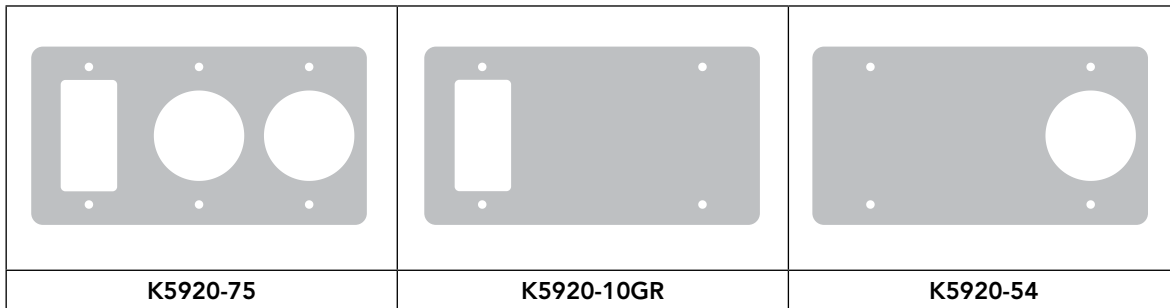

Notes

- For application details, consult factory.



Please consult serving utility for their requirements prior to ordering or installing, as specifications and approvals vary by utility, and may require local electrical inspector approval. All installations must be installed by a licensed electrician and must comply with all national and local codes, laws and regulations. Milbank reserves the right to make changes in specifications and features shown without notice or obligation.

Lighting Accessories

For Millennium Series Products

Internal LED Light Kits for Unmetered Power Outlets (U5000 & U5200)

Application	Internal light kit for unmetered power outlets	
LED Features	Includes new LED light, lamp shield and opaque hinge cover lens. Factory wired to 20 amp GFI circuit. May be wired to separate 20 amp circuit breaker. Order Q120 separately. Cover on unmetered power outlet is 19 1/8" in height.	
Ordering	Order with -LD suffix (after catalog number) for factory installed. Order catalog number K6212 for field installed.	

Internal Fluorescent Light Kits for Unmetered Power Outlets (U5000 & U5200)

Application	Internal light kit for unmetered power outlets	
Fluorescent Features	Includes 5-watt fluorescent lamp socket, ballast, lamp shield and opaque hinge cover lens. Factory wired to 20 amp GFI circuit. May be wired to separate 20 amp circuit breaker. Order Q120 separately. Cover on unmetered power outlet is 19 1/8" in height.	
Ordering	Order with -L suffix (after catalog number) for factory installed. Order catalog number K5411 for field installed.	

Photoelectric Light Control Kit

Application	Photoelectric light control kit for K5411 light kits.	
Features	2.5 amp, 120 volt photo electrical control wired in series with K5411 light kits.	
Ordering	Order with -LPC suffix for factory installed light and PE control. Order catalog number K5413 for field installed.	

WARNING!

Always disconnect power prior to installing these devices.

Please consult serving utility for their requirements prior to ordering or installing, as specifications and approvals vary by utility, and may require local electrical inspector approval. All installations must be installed by a licensed electrician and must comply with all national and local codes, laws and regulations. Milbank reserves the right to make changes in specifications and features shown without notice or obligation.



Internal Light Kits for Metered Power Outlets (U5100 & U5300)

Application	Internal light kit for metered power outlets	
LED Features	Includes new LED light , lamp shield and opaque hinge cover lens. Factory wired to 20 amp GFI circuit. May be wired to separate 20 amp circuit breaker. Order Q120 separately. Cover on metered power outlet is 15¼" in height.	
Ordering	Order with -LD suffix (after catalog number) for factory installed. Order catalog number K6213 for field installed.	

Application	Internal light kit for metered power outlets	
Fluorescent Features	Includes 5-watt fluorescent lamp socket, ballast, lamp shield and opaque hinge cover lens. Factory wired to 20 amp GFI circuit. May be wired to separate 20 amp circuit breaker. Order Q120 separately. Cover on metered power outlet is 15¼" in height.	
Ordering	Order with -L suffix (after catalog number) for factory installed. Order catalog number K5412 for field installed.	

Photoelectric Light Control Kit

Application	Photoelectric light control kit for K5412 light kits.	
Features	2.5 amp, 120 volt photo electrical control wired in series with K5412 light kits.	
Ordering	Order with -LPC suffix for factory installed light and PE control. Order catalog number K5413 for field installed.	

WARNING!

Always disconnect power prior to installing these devices.

Telecom and Pedestal Accessories

For Millennium Series Products

85

TELECOM AND
PEDESTAL
ACCESSORIES

Telephone and Cable TV Kit

Application	Mounts to rear of pedestal series U5200 and U5300 . May also be adaptable to a wooden or similar structure.	 <p>K4709-02-3R K4709-02</p>
Features	Single: 16" galvanized raceway, (1) RJ11 telephone jack and (1) Type F coaxial CATV jack. Dual: 16" galvanized raceway, (2) RJ11 telephone jacks and (1) Type F coaxial CATV jack. Includes mounting hardware and instructions.	
Ordering	Single line telephone and cable TV kit order K4709-02 .	
Note	Confirm acceptability with Cable TV and Telephone provider before ordering or installing these devices.	

Water Shroud with Hardware

Application	Used to cover water pipe and provide means to mount hose bib to rear of pedestal.	
Features	Includes mounting hardware and instructions. Matches K4709 kits when mounted side-by-side.	
Ordering	Order catalog number K4709-WS .	

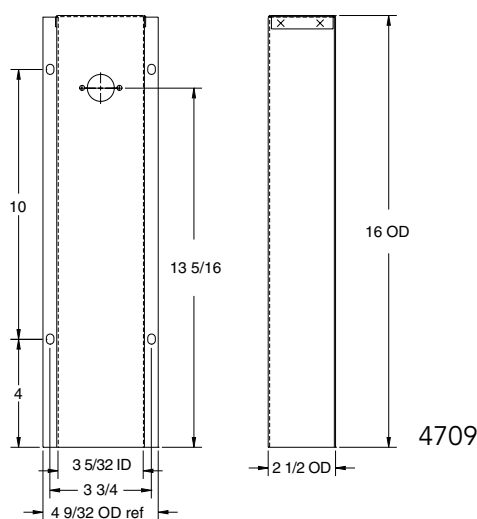

Please consult serving utility for their requirements prior to ordering or installing, as specifications and approvals vary by utility, and may require local electrical inspector approval. All installations must be installed by a licensed electrician and must comply with all national and local codes, laws and regulations. Milbank reserves the right to make changes in specifications and features shown without notice or obligation.



Pedestal Mounting Accessories

For Millennium Series Products

Field-Installed Pad Mount Kit

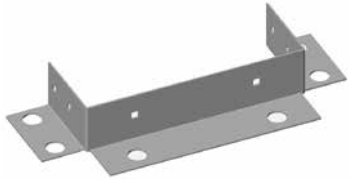
Application	Field installed pad mount kit with (6) 3/4" mounting holes.	
Features	Includes 1/4-20 stainless steel hardware to attach pad mount base to post. Anchor bolt kit sold separately (order catalog number K5421).	
Ordering	Order catalog number K5410 .	

Stabilizer Foot with Hardware

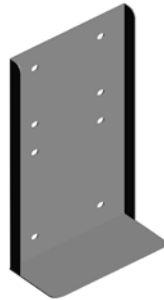
Application	Stabilizes direct burial type posts in unstable soil conditions.	
Features	Includes 1/4-20 hardware to attach to U5200 and U5300 pedestals.	
Ordering	Order catalog number K5415 .	

Anchor Bolt Kit

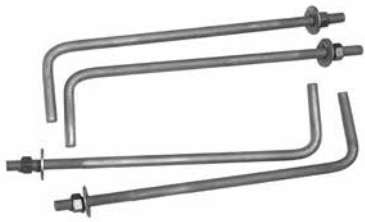
Application	Concrete anchor bolt kit designed to attach pad mount base to concrete.	
Features	(4) sets of zinc-plated 5/8-11 x 10" bolt with 2" toe. Includes nut and flat washer.	
Ordering	Order catalog number K5421 .	

Metering & Receptacle Accessories

For Millennium Series Products

Field-Installed Meter Kits





Application	Field installed meter kit for U5000 and U5200 power outlets.	
Features	100 amp cast meter socket, CL200 E-Z Read Meter, sealing ring, security seal, 1" Milbank hub, nipple and mounting screws. See CL200 for Watt-hour meter specification.	
Ordering	Order catalog number K4800-01 mechanical meter kit , or K4800-D digital meter kit .	

E-Z Read Watt-Hour Meter

Application	200 amp E-Z read watt-hour meter designed to be field installed on the U5100 and U5300 metered power outlets.	
Features	200 amp form 2S 120/240 volt. Numeric readout in full kilowatt increments. No "tenths" dial; digital readout option available. Remanufactured within 1% accuracy.	
Ordering	Order catalog number CL200-D .	

CL200-D
Digital

Single Receptacle Only Power Outlet

Application	Overhead/underground power outlet receptacle, suitable for RV, temporary service, campground, marina and boatyard equipment.			
Features	Type 3R, 120/240 volt single phase. Lockable cover. Breaker not included (in receptacle box).			
Ordering	Order catalog number from chart below.			
Receptacle Options	 P-10GWR 20A 5-20GR 120V GFI	 P-13 30A TT-30R 120V	 P-54 50A 14-50R 120/240V	

WARNING!

Always disconnect power prior to installing these devices.

Please consult serving utility for their requirements prior to ordering or installing, as specifications and approvals vary by utility, and may require local electrical inspector approval. All installations must be installed by a licensed electrician and must comply with all national and local codes, laws and regulations. Milbank reserves the right to make changes in specifications and features shown without notice or obligation.





Replacement Parts & Accessories

For Millennium Series Products

			
Q120 20 Amp, 1 pole circuit breaker	708784-MO 20 Amp, 1 pole GFI circuit breaker	Q130 30 Amp, 1 pole circuit breaker	Q250 50 Amp, 2 pole circuit breaker

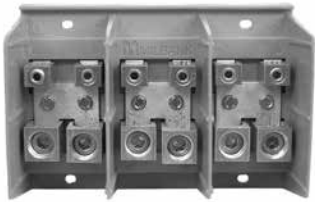
Main Breaker Kit Part number	Metered/Unmetered Surface Mount/ Pedestal	Amp
K5400-100MBM	Metered	100
K5400-100MBU	Unmetered	100

		
Z918466-AC Lug landing base	Z917602-AC Circuit breaker base (6-circuit)	Z915141-AC Left or right meter block assembly









Please consult serving utility for their requirements prior to ordering or installing, as specifications and approvals vary by utility, and may require local electrical inspector approval. All installations must be installed by a licensed electrician and must comply with all national and local codes, laws and regulations. Milbank reserves the right to make changes in specifications and features shown without notice or obligation.

Replacement Parts & Accessories

For Millennium Series Products

89
REPLACEMENT
PARTS &
ACCESSORIES

		
Z918449-AC (19" unmetered) Z918447-AC (15" metered) <i>Hinge cover</i>	Z818052-SC (19" unmetered) Z818480-SC (15" metered) <i>Deadfront</i>	MR-2 <i>Snap action sealing ring</i>

		
Z708080-MO <i>20 Amp GFI receptacle</i> NEMA 5-20GR	Z701776-MO <i>30 Amp receptacle</i> NEMA TT-30	Z708767-MO <i>50 Amp receptacle</i> NEMA 14-50R

Please consult serving utility for their requirements prior to ordering or installing, as specifications and approvals vary by utility, and may require local electrical inspector approval. All installations must be installed by a licensed electrician and must comply with all national and local codes, laws and regulations. Milbank reserves the right to make changes in specifications and features shown without notice or obligation.





Specifications

- 600 to 1200 amp, 120/240 Volt, 1Ø distribution bus accepts up to (6) 2 pole, 200 amp circuit breakers. Order from chart below.
- Costly main breaker not required per NEC 230-71.
- Economical alternative to costly wall hung or strut-mounted panel boards and load centers.
- Low profile, aesthetic design can be located near utility transformers or fed from a main service to a convenient location.
- Pad mounted Type 3R powder coated aluminum enclosure – standard color is gray.
- Hinge door and lift off rear service door are lockable and sealable for security.

NOTE: Consult local code enforcement for pad size requirements. Order catalog number **CP-24-PDMNT-CALT** pad mount base or catalog number **CP-ABK5/8** anchor bolt kit separately.

Circuit Breakers

Catalog Number	Amp	Phase	Volts	Connectors CU/AL		Dimensions		
				Line	Load	D"	W"	H"
CP3B-AUX-1200	1200	1Ø	120/240	(3) 1-600 kcmil/Ø or (3) 2-250 kcmil/Ø	See Circuit Breaker	17	24	41

Circuit Breakers

200 Amp Frame | Plug-In | 10K AIC | Two-Pole | Common Trip



2-Pole Rating	10K AIC Plug-In	Package Quantity	Connectors CU/AL	
			Line	Load
100	UQFP-100	1	#3-#1	#1-1/0
125	UQFP-125	1	#3-#1	#1-1/0
150	UQFP-150	1	1/0-300	2/0-300
175	UQFP-175	1	1/0-300	2/0-300
200	UQFP-200	1	1/0-300	2/0-300
225	UQFP-225	1	1/0-300	2/0-300

Recreational Vehicle

600-1200 Amp | Pad mounted Panel Board



U4540-XL

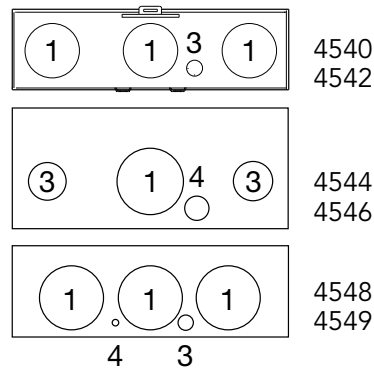
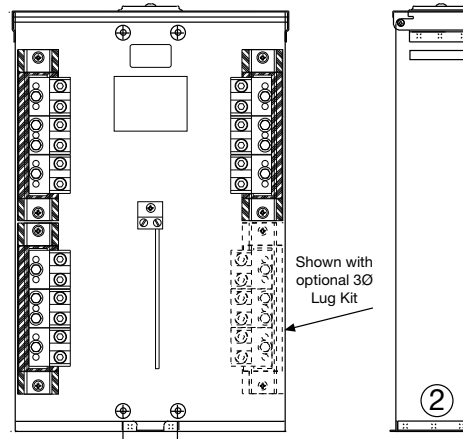

Terminal Boxes | 1Ø & 3Ø | 120/240 Volt

Catalog Number	Amp	Phase	Volts	Hub	1Ø to 3Ø Kit	Connectors CU7AL	Dimensions			Knockouts				
							D"	W"	H"	1	2	3	4	5
U4544-XL	100	1	120/240	C.P.	K4543	(6) #12-1/0	4 1/8	9 13/16	18	—	2	2	1	1/4, 1/2
U4546-XL	100	3	600	C.P.	N/A	(6) #12-1/0	4 1/8	9 13/16	18	—	2	2	1	1/4, 1/2
U4540-XL	200	1	120/240	C.P.	K4539	(6) #6-350	4 1/8	14 13/16	23	—	1 1/4	2 1/2	2 1/2	1/4, 1/2
U4542-XL	200	3	600	C.P.	N/A	(6) #6-350	4 1/8	14 13/16	23	—	1 1/4	2 1/2	2 1/2	1/4, 1/2
U4548-RXL	400	1	120/240	C.P.	K4547	(3) #6-350 or (2) #4-600	5	15 1/2	27	3	3	3	1/4, 1/2	1/4
U4549-RXL	400	3	600	C.P.	N/A	(3) #6-350 or (2) #4-600	5	15 1/2	27	3	3	3	1/4, 1/2	1/4

Notes

- **Hub:** Standard hub opening on top with closing plate attached.
- **Features:** UL listed pad lockable Type 3R enclosure.
- **3Ø 120/240V application:** Field-installable 3Ø lug kit converts 1Ø unit to 3Ø unit.

Please consult serving utility for their requirements prior to ordering or installing, as specifications and approvals vary by utility, and may require local electrical inspector approval. All installations must be installed by a licensed electrician and must comply with all national and local codes, laws and regulations. Milbank reserves the right to make changes in specifications and features shown without notice or obligation.



Dry Type Transformers

With Distribution for RV & Mobile Home Park Applications

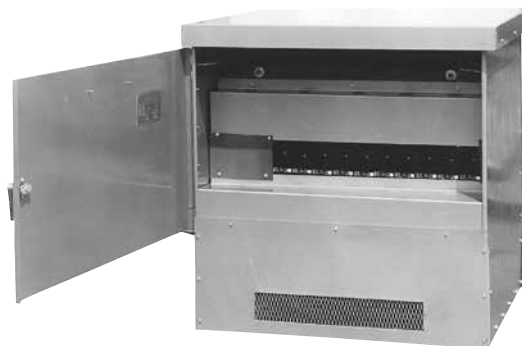

480 Volts to 120/240 Single Phase		
Catalog Number	KVA	Weight
10URMD*	100	1050 lbs.
16URMD*	167½	1400 lbs.
20URMD*	200	1650 lbs.
25URMD	250	1950 lbs.

* UL listed

2400 Volts to 120/240 Single Phase		
Catalog Number	KVA	Weight
10URMD24	100	1050 lbs.
16URMD24	167½	1400 lbs.
20URMD24	200	1650 lbs.
25URMD24	250	1950 lbs.

Voltage	Dimensions		
	A	B	C
480V, A	48"	38"	40"
2400V, A	48"	41"	53"

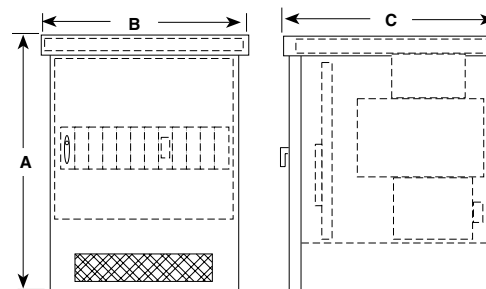
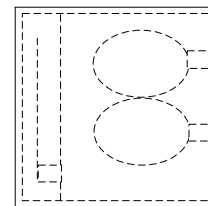

Specifications

- Built in accordance with NEMA, ASA and AIEEE standards. Designed and tested to withstand 150% of rated load for two continuous hours. Consult local utility for acceptance of this product.
- Integrated design of the enclosure, core and coil, and secondary distribution panel permits convenient vertical line and load terminations.
- Primary and/or secondary main circuit breaker protection available. Consult local utility for 480 volt overcurrent protection requirements. Single fuse primary overcurrent protection provided on 2400 volt and above units.
- Other primary voltages available: 4160, 4800, 7200, 7960, & 12,470. Consult factory. Not UL listed.

Core and Coil

- Aluminum wound (Copper available)
- Standard voltage taps @ 2FCAN and 4FCBN
- Rated at 150° C temperature rise

Distribution Bus

- 1600 amp tin plated aluminum
- Space available for up to (12) circuit breakers – 1600 amp maximum
- Uses Milbank type UQFP-100 through 200 amp circuit breakers (See page 117-118)

Enclosure

- Type 3R enclosure
- Powder coated galvanized steel (aluminum available)
- Lockable primary and secondary doors
- Lifting hooks and fork lift slots provided



Please consult serving utility for their requirements prior to ordering or installing, as specifications and approvals vary by utility, and may require local electrical inspector approval. All installations must be installed by a licensed electrician and must comply with all national and local codes, laws and regulations. Milbank reserves the right to make changes in specifications and features shown without notice or obligation.

Commercial Pedestals

Attractive | Easy to Install | Secure | Cost-Effective

Milbank Commercial Pedestals are pad-mounted, weatherproof electrical enclosures consisting of a utility pull section with optional meter socket, and a customer section containing distribution and control equipment. Milbank Commercial Pedestals are an attractive, secure, easy to install and cost-effective solution when underground remote site power distribution and control equipment is required, replacing unsightly and inefficient strut and backboard structures.



Strut and backboard



Commercial pedestal

UL Listed as Industrial Control Equipment (File E113855)

Standard Features

- Type 3R rain resistant, vandal-resistant cabinet of polyurethane powder coated steel (aluminum or stainless steel also available)
- UL listed as enclosed industrial control equipment (UL508)
- Isolated lockable & sealable utility metering and lug landing sections
- Lockable customer section for distribution and control equipment with internal deadfront
- Print pocket inside customer section door contains wiring schematics and installation instructions
- Most load centers are UL listed for use with various manufacturers' circuit breakers
- All stainless steel external hardware (screws, bolts, hinges, handles, hasps and sealing screws)

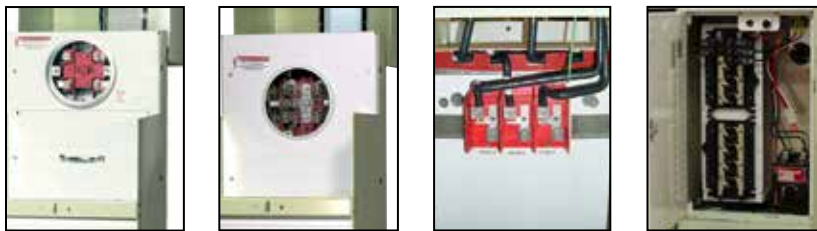

Please consult serving utility for their requirements prior to ordering or installing, as specifications and approvals vary by utility, and may require local electrical inspector approval. All installations must be installed by a licensed electrician and must comply with all national and local codes, laws and regulations. Milbank reserves the right to make changes in specifications and features shown without notice or obligation.





Applications

These units are ideal for controlling and metering:

- Traffic signals
- Street lighting
- Power distribution for EV charging stations
- Irrigation and sprinkler systems
- Cell towers and telephone vaults
- Pump stations
- Temporary power for fairgrounds, swap meets, outdoor markets, portable offices, holiday lights, etc.
- Outdoor lighting for athletic fields, tennis and basketball courts, parking lots, landscaping and subdivision entrances, etc.

Available Factory-Installed Options

- Meter sockets: ring type or ringless, up to 400 amp
- Main and branch breakers or T fuses
- Distribution: copper load centers and panel boards
- Clocks, timers and relays
- Photoelectric cells and controls
- Power receptacles: pin and sleeve, twist lock or straight blade
- Contactors: definite purpose, electrical or mechanically held, IEC and mercury types
- Surge protection and lightning arrestors
- Reserve inlet generator receptacle with interlocked circuit breakers
- Motor starters and relays
- Push button controls
- Thermostat controls, fans and heating strips
- Power blocks and terminal blocks
- Steel, aluminum and plywood backboards
- Transformers
- Interlock devices for circuit breakers
- Available in steel, aluminum (raw painted or anodized) or stainless steel construction with powder coated finish available in eight standard colors or special-ordered RAL colors
- Available for applications up to 400 amp, 120V, 208V, 240V, 277V, 480V - 1Ø or 3Ø

Accessories



K3865
Fifth terminal kit for use with ringless meter sockets

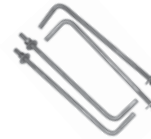

CP-ABK5/8
Anchor bolt kit (includes four 5/8 - 13 x 18" anchor bolts)



105J
Fifth terminal kit for use with ring-type meter sockets



CP-TC7D
7-day time clock kit
CP-TC24H
24-hour time clock kit
CP-TCWIRE
Male 4-pin connector and wiring harness for use with time clocks other than above

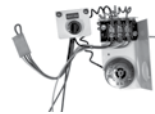

CP-PE-HOA-3POS
HOA switch for field installation



CP-16PDMNT-CALT
16" pedestal mounting base
CP-24PDMNT-CALT
24" pedestal mounting base (includes mounting hardware)



Please consult serving utility for their requirements prior to ordering or installing, as specifications and approvals vary by utility, and may require local electrical inspector approval. All installations must be installed by a licensed electrician and must comply with all national and local codes, laws and regulations. Milbank reserves the right to make changes in specifications and features shown without notice or obligation.

Commercial Pedestals

Main Load Center Series | Custom Designs Available

CP3B "ML" Series

Main Load Center Series

1Ø3 wire 120/240V or 208Y/120V

Application: remote site service for multiple loads

Milbank Main Load Center Commercial Pedestals are designed to handle the vast majority of all requirements in a standard, stocked configuration.

- All units feature a load center with a plug-on, back-fed main breaker.
- Load center has 16 positions for the 100 amp pedestals and 24 circuits for the 200 amp pedestals.
- Both sizes include sub-feed lugs to allow feeding an external panel.

If your application requires turning loads on based on "dusk-to-dawn" requirements, be sure to see the Milbank Switched Load Center Commercial Pedestal products on the following page.

Features

These units include everything required for remote site service:

- NEMA 3R construction.
- Expandable: load centers allow for future expansion without costly modifications.
- All units feature 200 amp meter socket with optional field-installable fifth terminal kit available.
- 22K amp interrupting capacity (AIC) standard.
- Optional mounting base can be embedded in concrete for fast, easy installation.
- Separate sealable and lockable utility termination section.
- Separate sealable and lockable metering section.
- Separate sealable and lockable customer section with a load center for "always on" loads that include a main circuit breaker, 20 (125 or 200 amp model) or 14 (100 amp model) blank breaker spaces and a circuit directory to document configuration.

Note
All meter form and bypass options available to meet utility requirements.



Typical Applications
Remote site service for multiple loads.

Standard Pedestals	Optional Fifth Terminal Kit	Main CB		Load Center Circuits	Meter Socket Type
		Amp	Spaces		
CP3B11115A22	105J	100	1,2	16	Ring type with test/bypass blocks
CP3B12119A22	105J	200	1,2,3 4	24	Ring type with test/bypass blocks
CP3B51115A22	K3865	100	1,2	16	Ringless socket with lever bypass
CP3B52119A22	K3865	200	1,2,3,4	24	Ringless socket with lever bypass

Notes

- Chart shows standard, stocked items. Other options and features are available. Contact factory for options, details and availability.

Please consult serving utility for their requirements prior to ordering or installing, as specifications and approvals vary by utility, and may require local electrical inspector approval. All installations must be installed by a licensed electrician and must comply with all national and local codes, laws and regulations. Milbank reserves the right to make changes in specifications and features shown without notice or obligation.



CP3B "SL" Series

Switched Load Center Series
1Ø3 wire 120/240V or 208Y/120V

Milbank Switched Load Center Commercial Pedestals are designed not only to provide power for various loads, but also to switch specific loads on and off under certain conditions. A photoelectric cell is used for these controlled loads, and an optional time clock is also available.

Features

These units include everything required for remote site service:

- NEMA 3R construction.
- Expandable: load centers allow for future expansion without costly modifications.
- All units feature 200 amp meter socket with optional field-installable fifth terminal kit available.
- 22K amp interrupting capacity (AIC) standard.
- Optional mounting base can be embedded in concrete for fast, easy installation.
- Separate sealable and lockable utility termination section.
- Separate sealable and lockable metering section.
- Separate sealable and lockable customer section with a control circuit including PE receptacle, Lexan® window, glare shield, Hand-Off-Auto (HOA) switch, contractor controlling a 16-circuit load center for controlled loads, a pre-mounted DIN rail and pre-wired connector to add an optional "plug-and-play" time clock kit for PE on and TC off operation and a circuit directory to document configuration.
- A load center for "always on" loads that includes a main circuit breaker, a control power circuit breaker, a switched load center main breaker, nine (125 or 200 amp model) or 11 (100 amp model) blank breaker spaces and a circuit directory to document configuration.

Note
All meter form and bypass options available to meet utility requirements.



Typical Applications
Traffic signals, parking lots, highways & athletic field lighting

Standard Pedestals	Optional Fifth Terminal Kit	Main CB		Contactor amperage	Meter Socket Type
		Amp	Spaces		
CP3B11110A22SL1	105J	100	1,3	60	Ring type with test/bypass blocks
CP3B12110A22SL1	150J	200	1,2,3,4	100	Ring type with test/bypass blocks
CP3B51110A22SL1	K3865	100	1,3	60	Ringless socket with lever bypass
CP3B52110A22SL1	K3865	200	1,2,3,4	100	Ringless socket with lever bypass

Notes

- Chart shows standard, stocked items. Other options and features are available. Contact factory for options, details and availability.



Please consult serving utility for their requirements prior to ordering or installing, as specifications and approvals vary by utility, and may require local electrical inspector approval. All installations must be installed by a licensed electrician and must comply with all national and local codes, laws and regulations. Milbank reserves the right to make changes in specifications and features shown without notice or obligation.

Commercial Pedestals

400 Amp Series



Milbank 400 Amp Commercial Pedestals are designed to provide a weather and vandal resistant metered enclosure for various loads and distribution. Each pedestal has been designed to handle a wide range of applications using standard, stocked configurations.

- Choice of a single main breaker or twin service disconnect breakers gives flexibility to the pedestal design.
- Optional distribution with feed-through lugs below the service disconnect breakers allows the pedestal to handle numerous applications.
- Typical applications include remote homes where the metering is best located at the curb side or other remote area. The pedestal can also provide power to secondary residence, on-site business, workshop, irrigation, lighting, security or other secondary load.
- Available in custom colors to match home or landscaping.

Features

These units include everything required for remote service:

- Type 3R construction
- Main circuit breaker or dual service disconnects
- Expandable: load center units allow for future expansion without costly modifications
- Optional mounting base can be embedded in concrete for fast, easy installation
- Separate sealable and lockable utility termination section with lug termination
- Separate sealable and lockable metering section
- A separate sealable and lockable customer section with a circuit directory and a print pocket to hold all documentation
- Meter socket options include ring type with bypass studs, ringless with heavy duty lever bypass, or K-Type bolt-on

Typical Applications

Remote site service for residential and commercial job sites.

Standard Pedestals	Optional fifth Terminal Kit	Main CB	Load Center Circuits	Meter Socket Type
CP3B1411JB	N/A	320 Amp (400 max)	0	Ring-type with test/bypass studs
CP3B14120B	N/A	2-200 Amp	(2) 12 circuit ¹	Ring-type with test/bypass studs
CP3B54120B22	K3865	2-200 Amp	(2) 12 circuit ¹	Ringless with lever bypass
CP3B5411JB22	K3865	320 Amp (400 max)	0	Ringless with lever bypass

Notes

- Chart shows standard, stocked items. Other options and features are available. Contact factory for options, details and availability.
- Stud utility landing is standard. Lug kits are available from factory.
- Units with load centers have (2) #6-250 sub-feed lugs on each load center. (Each load center is 200 amp rated and UL listed with: Siemens, General Electric and Cutler-Hammer plug-in style circuit breakers.)

Please consult serving utility for their requirements prior to ordering or installing, as specifications and approvals vary by utility, and may require local electrical inspector approval. All installations must be installed by a licensed electrician and must comply with all national and local codes, laws and regulations. Milbank reserves the right to make changes in specifications and features shown without notice or obligation.



Commercial Pedestals

CP3B "IR" Irrigation Control Series



Milbank "IR" Series Irrigation Pedestals install quickly and simply—often in less than an hour with a single technician—a fraction of the time typically needed for strut farm and other installation set ups. Additionally, the pedestal comes pre-wired, so the technician simply drops in the pre-drilled concrete box pad, fastens the pedestal and runs the wires. Prewired landing lugs are provided in a separate utility side so that there is no more need to wrestle with hard-to-bend wires. Simply run the utility wire up and land on the lugs. With both the motor starter and disconnect in the same enclosure, all the controls are housed in a safe, lockable pedestal that protects against vandalism and energy theft.

Features

- 3Ø4W, 480Y/277 volt
- One technician can install in under an hour with use of Milbank's pre-drilled box pad
- All units are UL listed and service entrance rated
- Fused disconnect with accessible handle through the deadfront
- HOA and push button start
- Separate accessible utility side with pre-wired landing lugs
- NEMA rated starters (sizes 1-5)
- Soft start units sizes 30HP-150HP
- 30 amp fuse block for pivot pre-wired in the unit
- White powder coated paint finish helps keep components cooler
 - Options include:
 - Hour meter
 - Chemical injection receptacle
 - Multiple injection receptacle
 - Multiple 30 amp fuse blocks possible

Typical Applications

Power pedestal for irrigation systems or other pump control applications.

Standard Pedestals	Exterior Cabinet	NEMA Rating
CP3B0281UMWIR04	White	4
CP3B0281UMWIR03	White	3
CP3B0181UMWIR02	White	2

Notes

- Chart shows standard, stocked items. Other options and features are available. Contact factory for options, details and availability.



Please consult serving utility for their requirements prior to ordering or installing, as specifications and approvals vary by utility, and may require local electrical inspector approval. All installations must be installed by a licensed electrician and must comply with all national and local codes, laws and regulations. Milbank reserves the right to make changes in specifications and features shown without notice or obligation.

Commercial Pedestals

CP3B "BBS" Battery Backup Series



Milbank BBS Series Commercial Pedestals are designed to provide battery backup power for various loads, and to switch specific loads on and off under certain conditions; a photoelectric cell or time clock to control lighting circuits, as an example. Metered and unmetered power distribution options are available. The back-up power pedestal is designed to handle the vast majority of today's back-up power requirements. By using 19" rack design, shelves can be adjusted to accommodate the required batteries and manufactures DC to AC inverters, transfer switches and other related equipment. This design gives the user a wide range of design and configuration options. Complete turnkey, ready to power-up pedestals are offered along with basic units ready to accept batteries and inverters supplied by others.

Features

- Type 3R construction
- 100 through 320 amp meter socket with the option of either a ring type socket (conforms to EUSERC 308) with or without test/bypass blocks or a heavy duty ringless socket with lever bypass
- Separate sealable utility termination compartment
- An isolated separate customer section with service disconnects, power distribution options and power control
- 19" wide rack in customer compartment for easy layout of equipment
- Battery trays
- Thermostat with cooling fan
- Filtered louvers for heat rise flow through ventilation
- Three point door latch (key or pad lockable)

Typical Applications

Metered emergency uninterrupted power for traffic intersections, wireless, phone and communications equipment, parking lots, camera and security locations

Options

- Manual bypass switch
- Transfer switch for generator power back-up
- Generator inlet receptacles 30 through 200 amp
- Pad lockable provision for receptacles
- Police access door
- Metered load center distribution
- Unmetered load center distribution
- Photo electric controls (for street lighting)
- Time clocks
- HOA switches
- Contactors
- GFI duplex receptacles
- Thermostat for heating control
- Heating pads or elements
- Roll out shelves for batteries
- Surge arrestors and lighting arrestors

Please consult serving utility for their requirements prior to ordering or installing, as specifications and approvals vary by utility, and may require local electrical inspector approval. All installations must be installed by a licensed electrician and must comply with all national and local codes, laws and regulations. Milbank reserves the right to make changes in specifications and features shown without notice or obligation.



Commercial Pedestals

CP3B "Power Transfer" Series



Milbank Power Transfer Series Pedestals provide unmetered AC power, distribution, surge suppression, mechanical interlock and stand-by generator receptacle—all in a neat, compact pedestal.

Features

- 120/240V 1Ø3W through 277/480V 3Ø4W ratings
- Metered or unmetered units
- Choice of EUSERC ring type or ringless meter sockets
- 60 amp through 400 amp ratings
- UL listed Type 3R rated
- Pad lockable, isolated utility compartments
- 20 amp GFI convenience receptacle
- Lockable recessed generator receptacle door
- Utility and generator indicator light options
- All stainless steel hardware
- Galvanized steel, aluminum or stainless steel cabinet options
- Custom designs available



Typical Applications

Traffic intersections, cell sites, cable TV, pump and lift stations requiring utility power with backup generator power

Typical Applications

Traffic intersections, cell sites, cable TV, pump and lift stations requiring utility power with backup generator power



Please consult serving utility for their requirements prior to ordering or installing, as specifications and approvals vary by utility, and may require local electrical inspector approval. All installations must be installed by a licensed electrician and must comply with all national and local codes, laws and regulations. Milbank reserves the right to make changes in specifications and features shown without notice or obligation.

Commercial Pedestals

CP3BB "CT Metered" Series

101
COMMERCIAL
PEDESTALS



Milbank CT Metered Series Commercial Pedestals are designed to be used where a smaller service package would be a better choice over large 3R rated combination switchboards. These pedestals have amperage ratings of 400 to 800 amp at voltages up through 480 volt three phase.

Features

- UL listed, freestanding Type 3R service
- A low profile CT pedestal
- All utility equipment is isolated in separated pad lockable and sealable compartments
- Separate customer compartment designed to hold distribution and control equipment
- Dead front customer construction
- Optional mounting base
- Optional construction in steel, aluminum and stainless steel.
- Wide choice of powder paint colors

Typical Applications

Large homes, pumping & lift stations, motor control, water treatment plants, EV charging stations, commercial buildings, large remote service requirements, commercial and industrial control systems

Please consult serving utility for their requirements prior to ordering or installing, as specifications and approvals vary by utility, and may require local electrical inspector approval. All installations must be installed by a licensed electrician and must comply with all national and local codes, laws and regulations. Milbank reserves the right to make changes in specifications and features shown without notice or obligation.





Milbank Slimline Series Commercial Pedestals provide a sleeker, smaller footprint, with wireway access on the side of the unit rather than the back, allowing maximum flexibility to place the pedestal in tighter spaces.

Features

- UL listed as service equipment
- 100 or 200 amp
- Vandal-resistant, secure and attractive design
- Customer compartment with distribution and control equipment with swing dead front door, secured with both a hasp/latch and draw latch outer door
- Utility metering compartment protected with a hinged hood, increasing resistance to meter vandalism
- Small footprint
- Wireway located on left side of pedestal for utility incoming wire, allowing pedestal to be mounted with back very close to a wall (14")
- Available in 12" and 20" widths and 50" and 63" (metered) and 43" (unmetered) heights
- Includes a print pocket for plans and drawings
- 200 amp main available
- Voltage range: 120V–480V
- Compatible with both ringless and ring type meter sockets, 4–7 terminals
- Available in a wide array of colors, including but not limited to all ANSI powder coated paint colors upon request
- Pedestal mounting base option saves time and labor to install on a cement pad—no anchor bolts required
- Powder coated G90 galvanized steel, raw, anodized or powder coated aluminum and stainless steel exterior options

"Slimline" Series Direct Bury Extension



- No need for concrete
- Bolts directly to unit
- Easy, modular design
- Ships in a smaller package
- Increases project flexibility
- Easier to handle and install
- Utilizes stabilizer feet to prevent leaning over time
- Pedestal and extension can be installed within 45 minutes

Notes

- 14 gauge steel
- Only available for 12" pedestals

Typical Applications



Roadway lighting and signage, wastewater treatment facilities, parks and landscaping, and any application where physical space is at a premium



Please consult serving utility for their requirements prior to ordering or installing, as specifications and approvals vary by utility, and may require local electrical inspector approval. All installations must be installed by a licensed electrician and must comply with all national and local codes, laws and regulations. Milbank reserves the right to make changes in specifications and features shown without notice or obligation.

Commercial Pedestals

Accessories

			
<p>CP-ABK5/8 Anchor bolt kit (includes four 5/8-13" x 18" anchor bolts)</p>	<p>K3865 Fifth terminal kit for use with ringless lever bypass meter sockets</p>	<p>CP-TC7D 7-day time clock kit CP-TC24H 24-hour time clock kit CP-TCWIRE Male 4-pin connector and wiring harness for use with time clocks other than shown</p>	<p>105J Fifth terminal kit for use with ring type meter sockets</p>
			
<p>CP-16PDMNT-CALT Pedestal mounting base for 16" pedestal CP-24PDMNT-CALT Pedestal mounting base for 24" pedestal (includes mounting hardware) CP-32PDMNT Pedestal mounting base for 32" pedestal (includes mounting hardware)</p>	<p>CP-PE-HOA-3POS HOA (Hand-Off-Auto) switch for field installation</p>	<p>CP-PE-TYP5-2POS Two position PE control kit</p>	

Please consult serving utility for their requirements prior to ordering or installing, as specifications and approvals vary by utility, and may require local electrical inspector approval. All installations must be installed by a licensed electrician and must comply with all national and local codes, laws and regulations. Milbank reserves the right to make changes in specifications and features shown without notice or obligation.



Commercial Pedestals

16" Metered & Unmetered Drawings

"A" Style 16" Metered Commercial Pedestal

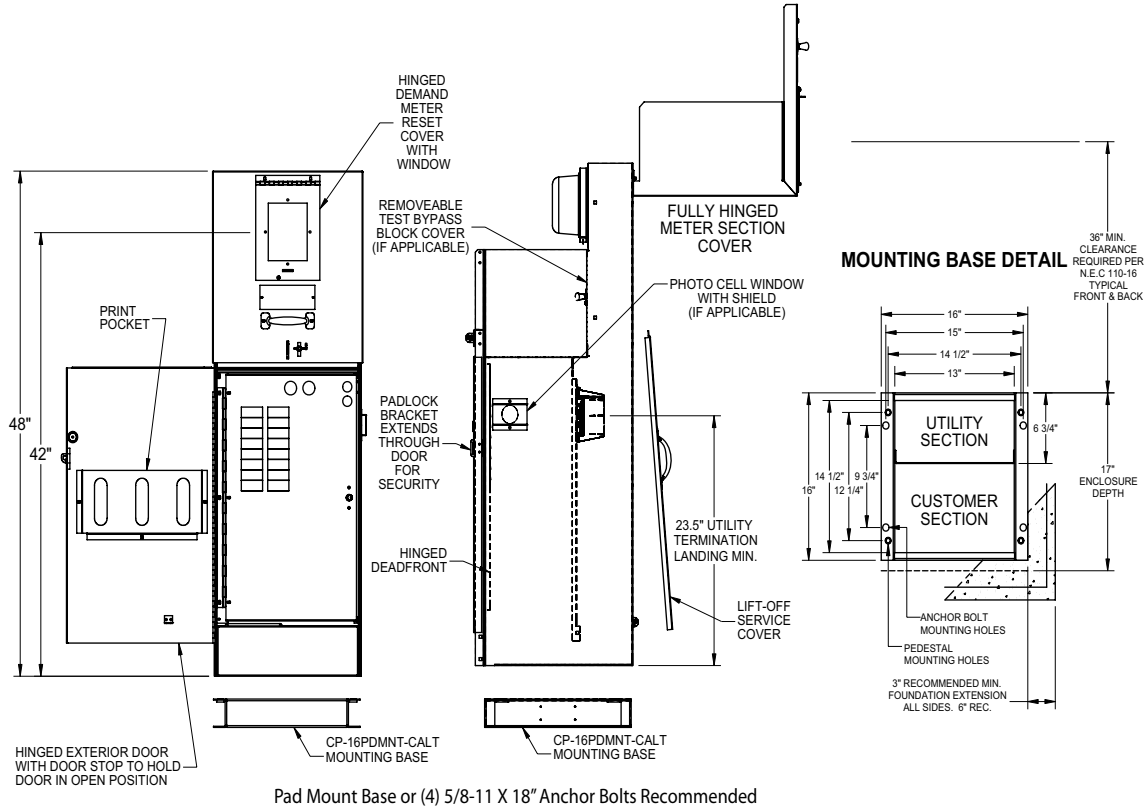

"E" Style 16" Unmetered Commercial Pedestal | Low Profile

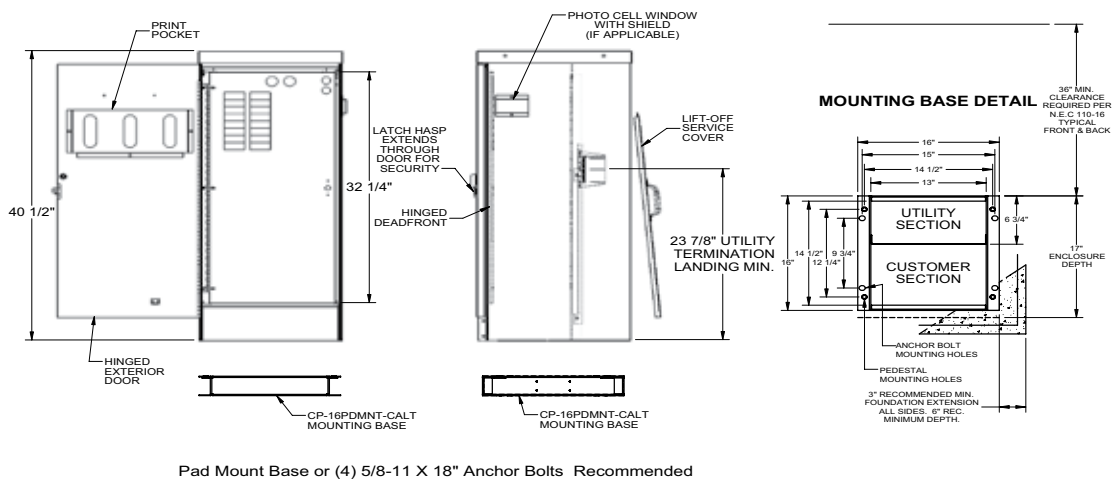

Please consult serving utility for their requirements prior to ordering or installing, as specifications and approvals vary by utility, and may require local electrical inspector approval. All installations must be installed by a licensed electrician and must comply with all national and local codes, laws and regulations. Milbank reserves the right to make changes in specifications and features shown without notice or obligation.

Commercial Pedestals

24" Metered & Unmetered Drawings

"B" Style 24" Metered Commercial Pedestal (with one or two meters)

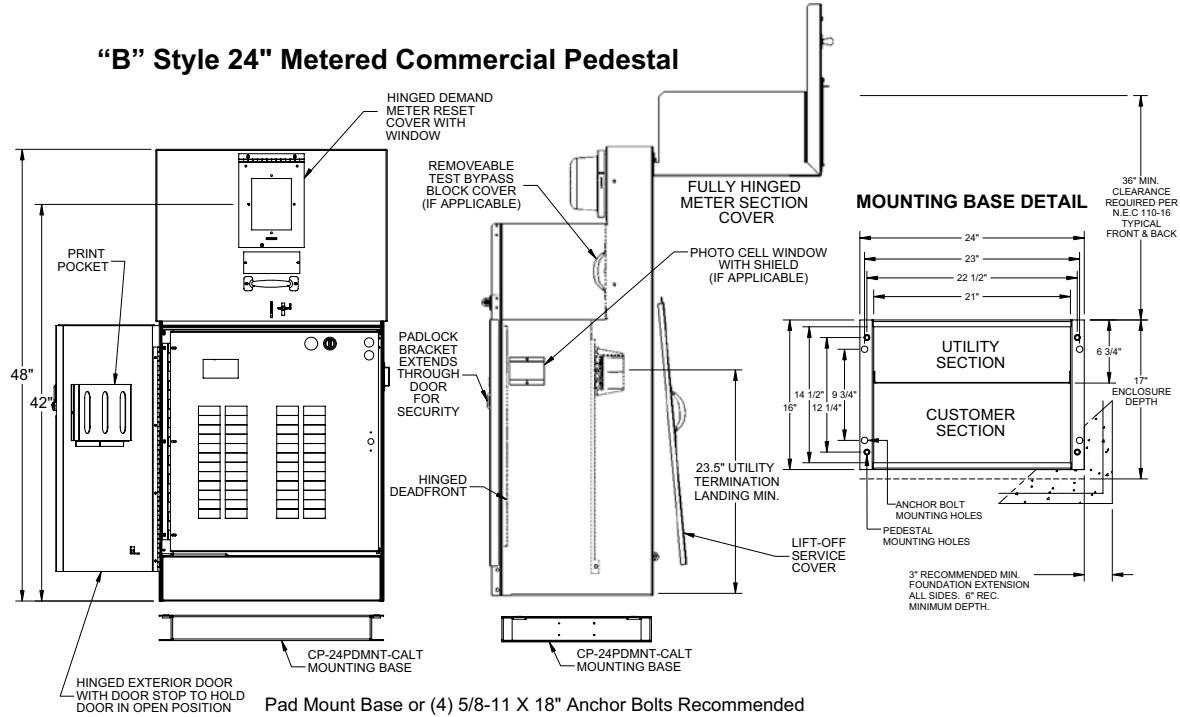

"M" Style 24" Unmetered Commercial Pedestal

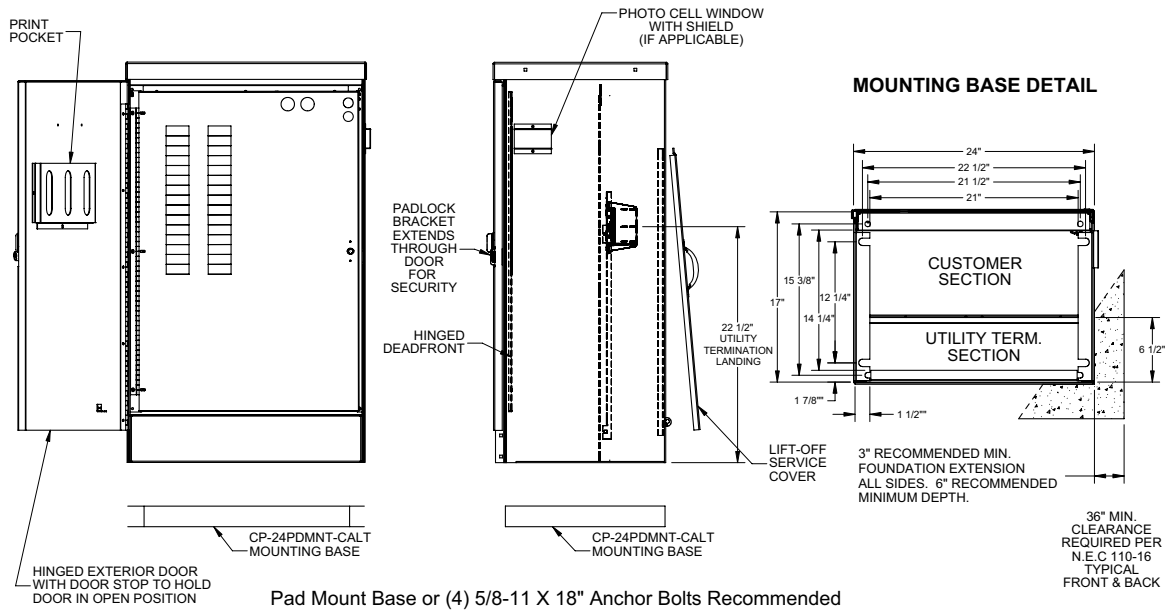

Please consult serving utility for their requirements prior to ordering or installing, as specifications and approvals vary by utility, and may require local electrical inspector approval. All installations must be installed by a licensed electrician and must comply with all national and local codes, laws and regulations. Milbank reserves the right to make changes in specifications and features shown without notice or obligation.



"K" Style 32" Metered Commercial Pedestal (with one or two meters)

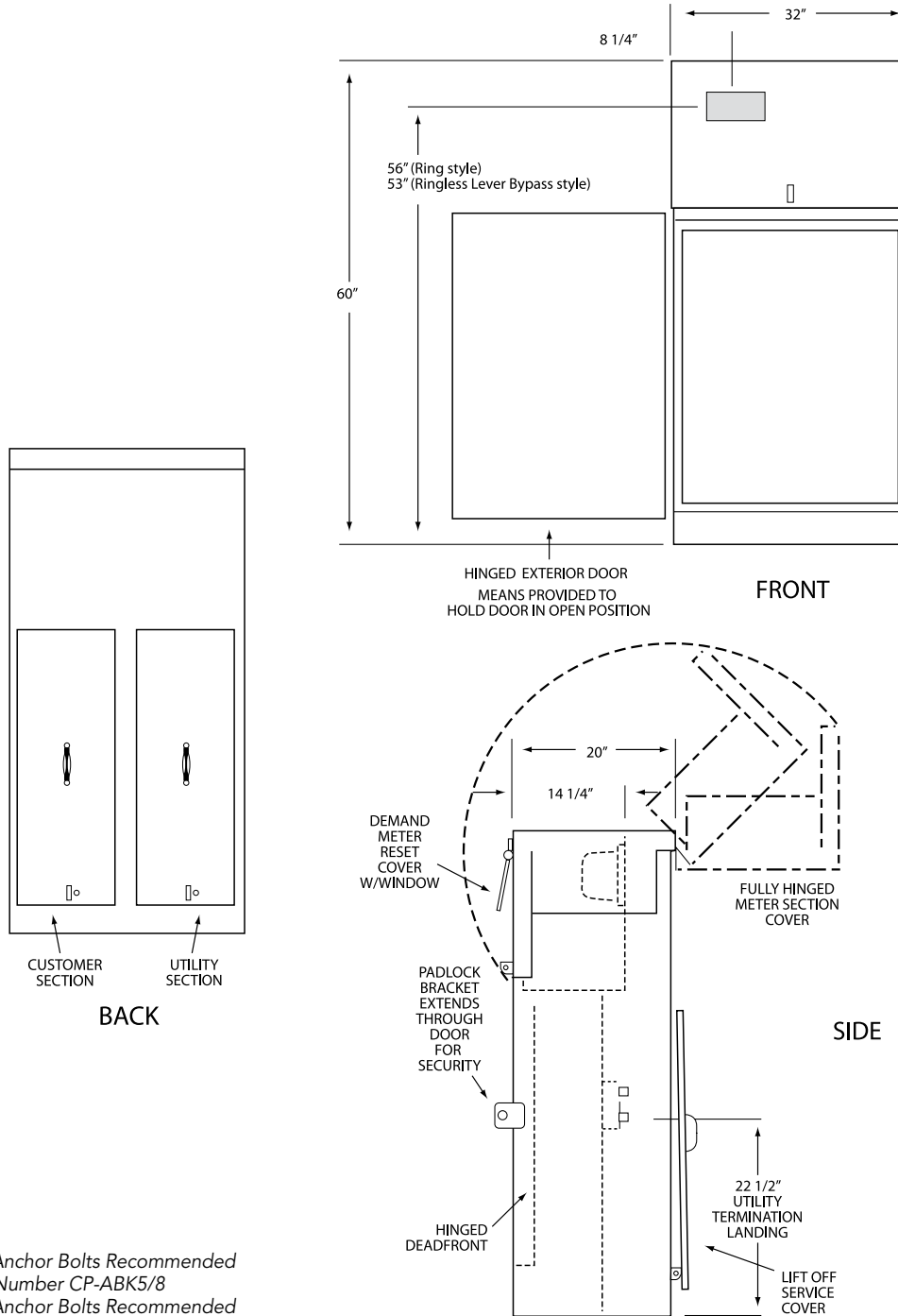

(4) 5/8-11 X 18" Anchor Bolts Recommended
Catalog Number CP-ABK5/8
(4) 5/8-11 X 18" Anchor Bolts Recommended



Please consult serving utility for their requirements prior to ordering or installing, as specifications and approvals vary by utility, and may require local electrical inspector approval. All installations must be installed by a licensed electrician and must comply with all national and local codes, laws and regulations. Milbank reserves the right to make changes in specifications and features shown without notice or obligation.

Commercial Pedestals

32" Unmetered Drawings

107
COMMERCIAL
PEDESTALS

"Q" Style 32" Unmetered Commercial Pedestal

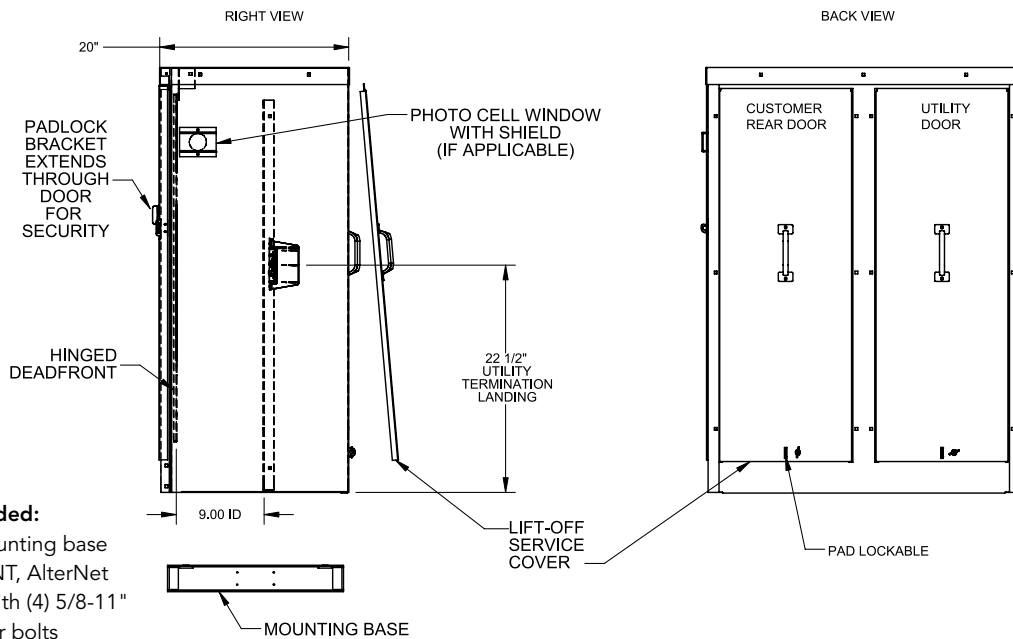
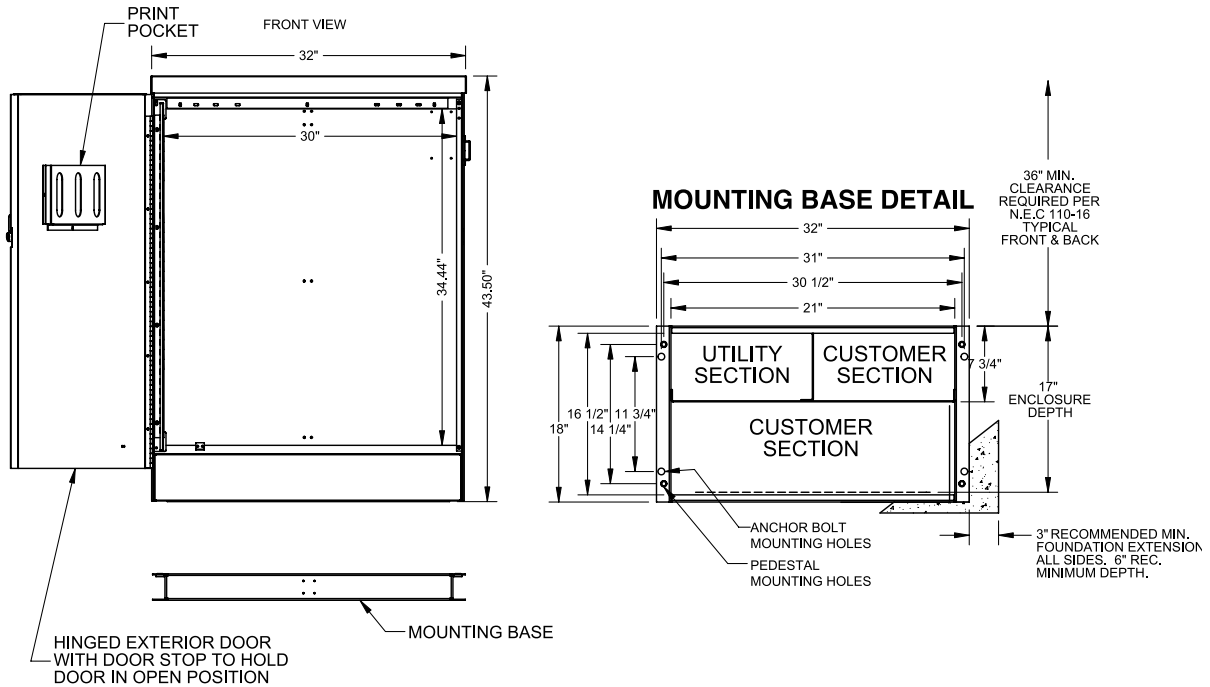

Recommended:
Milbank mounting base
CP-32PDMNT, AlterNet
mounting with (4) 5/8-11"
x 18" anchor bolts

Please consult serving utility for their requirements prior to ordering or installing, as specifications and approvals vary by utility, and may require local electrical inspector approval. All installations must be installed by a licensed electrician and must comply with all national and local codes, laws and regulations. Milbank reserves the right to make changes in specifications and features shown without notice or obligation.



"D" Style Metered Commercial Pedestal

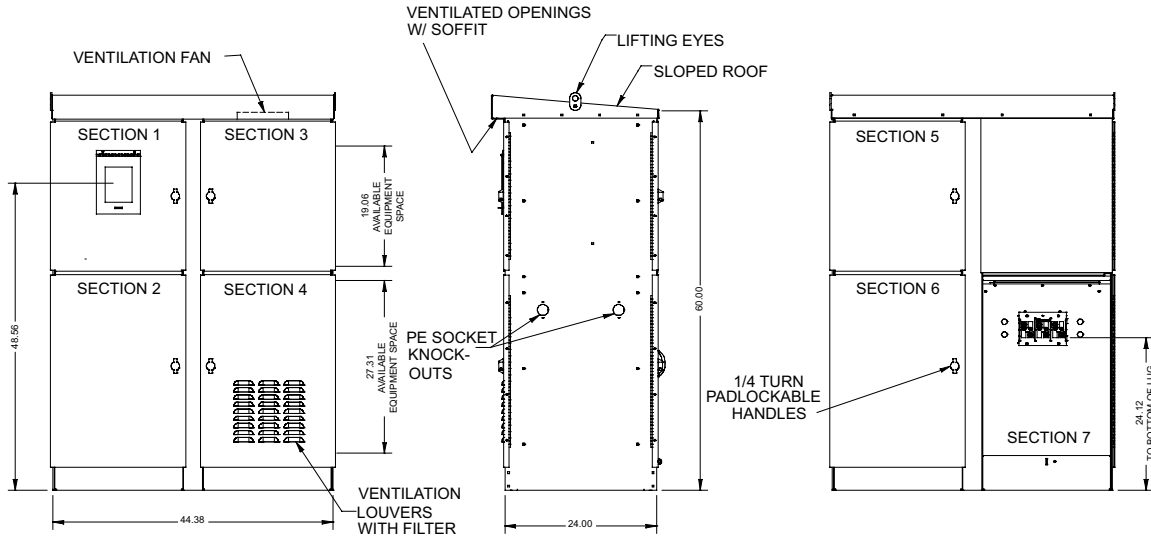

"C" Style 54" Metered Commercial Pedestal

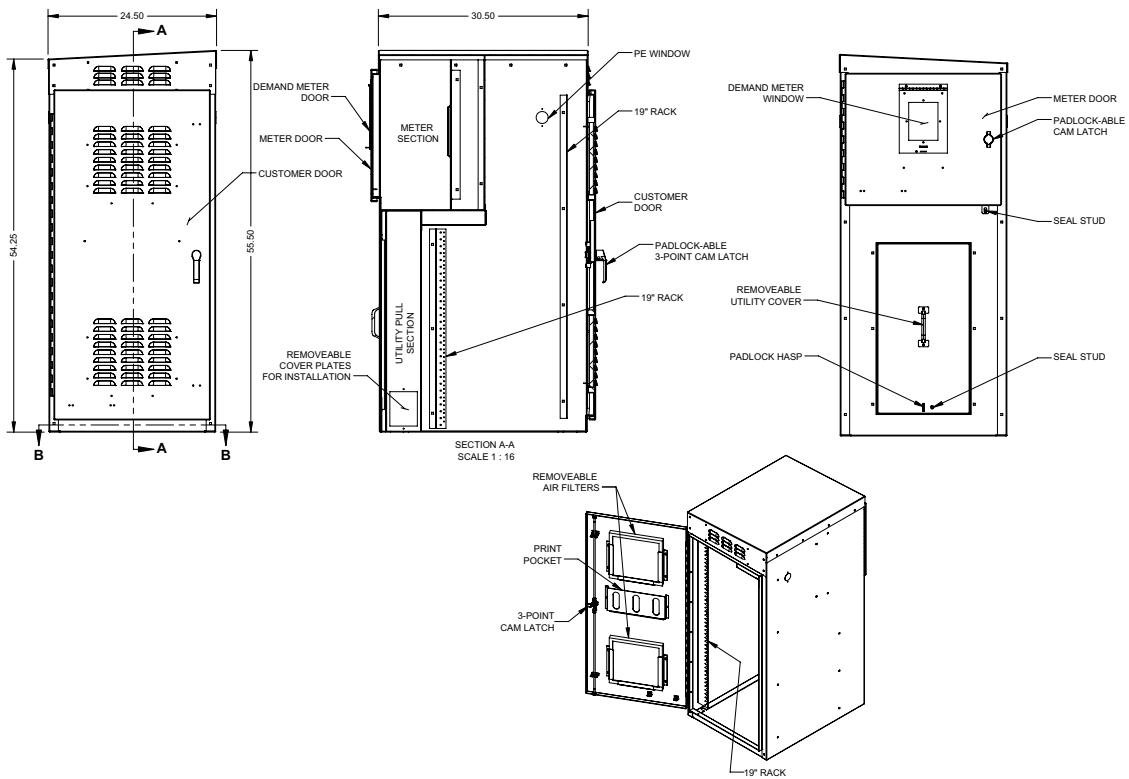

Please consult serving utility for their requirements prior to ordering or installing, as specifications and approvals vary by utility, and may require local electrical inspector approval. All installations must be installed by a licensed electrician and must comply with all national and local codes, laws and regulations. Milbank reserves the right to make changes in specifications and features shown without notice or obligation.

Commercial Pedestals

Slimline "A" Style Drawing

109
COMMERCIAL
PEDESTALS

"A" Style Slimline Metered Commercial Pedestal

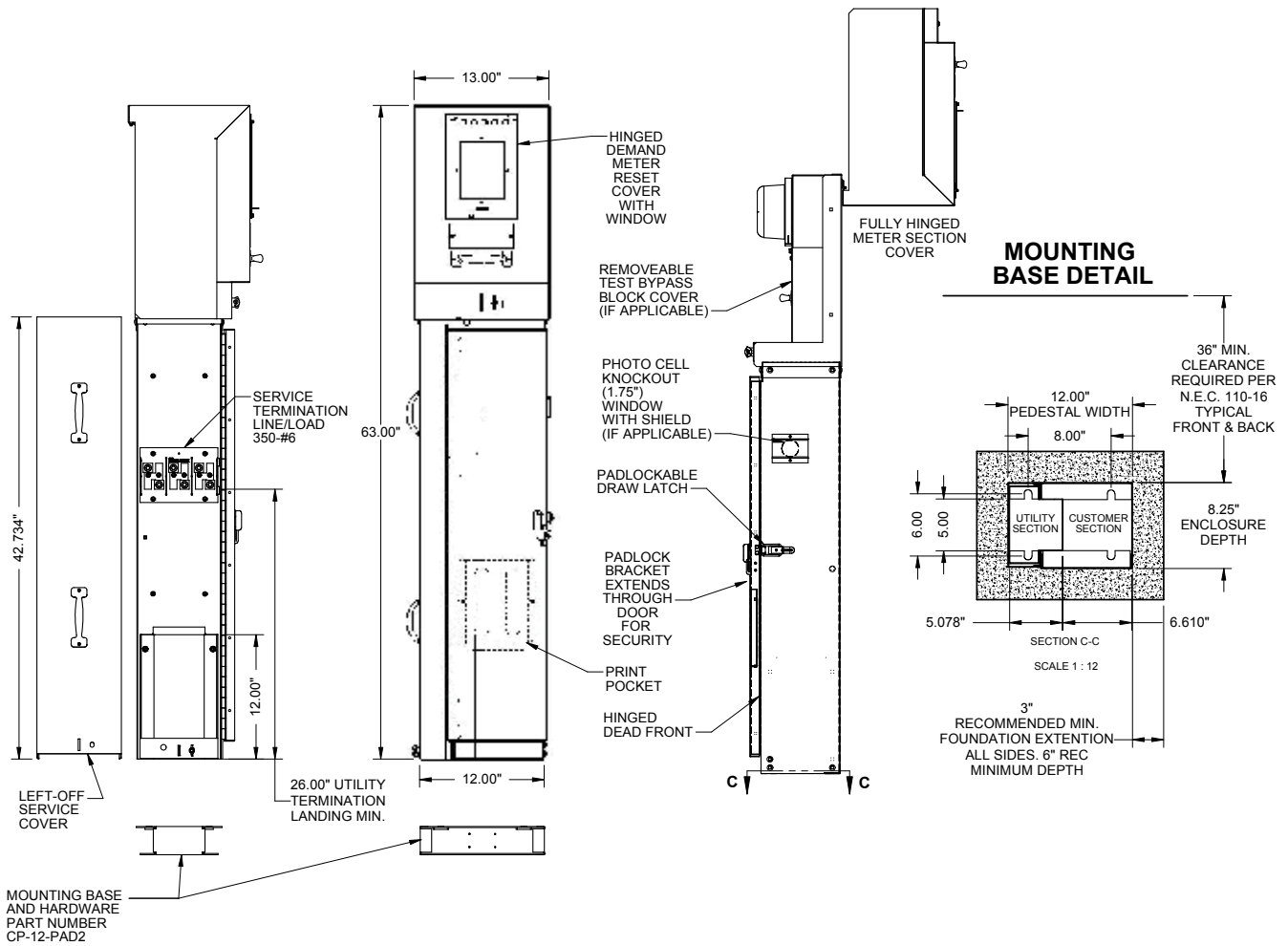

Please consult serving utility for their requirements prior to ordering or installing, as specifications and approvals vary by utility, and may require local electrical inspector approval. All installations must be installed by a licensed electrician and must comply with all national and local codes, laws and regulations. Milbank reserves the right to make changes in specifications and features shown without notice or obligation.



"B" Style Slimline Metered Commercial Pedestal

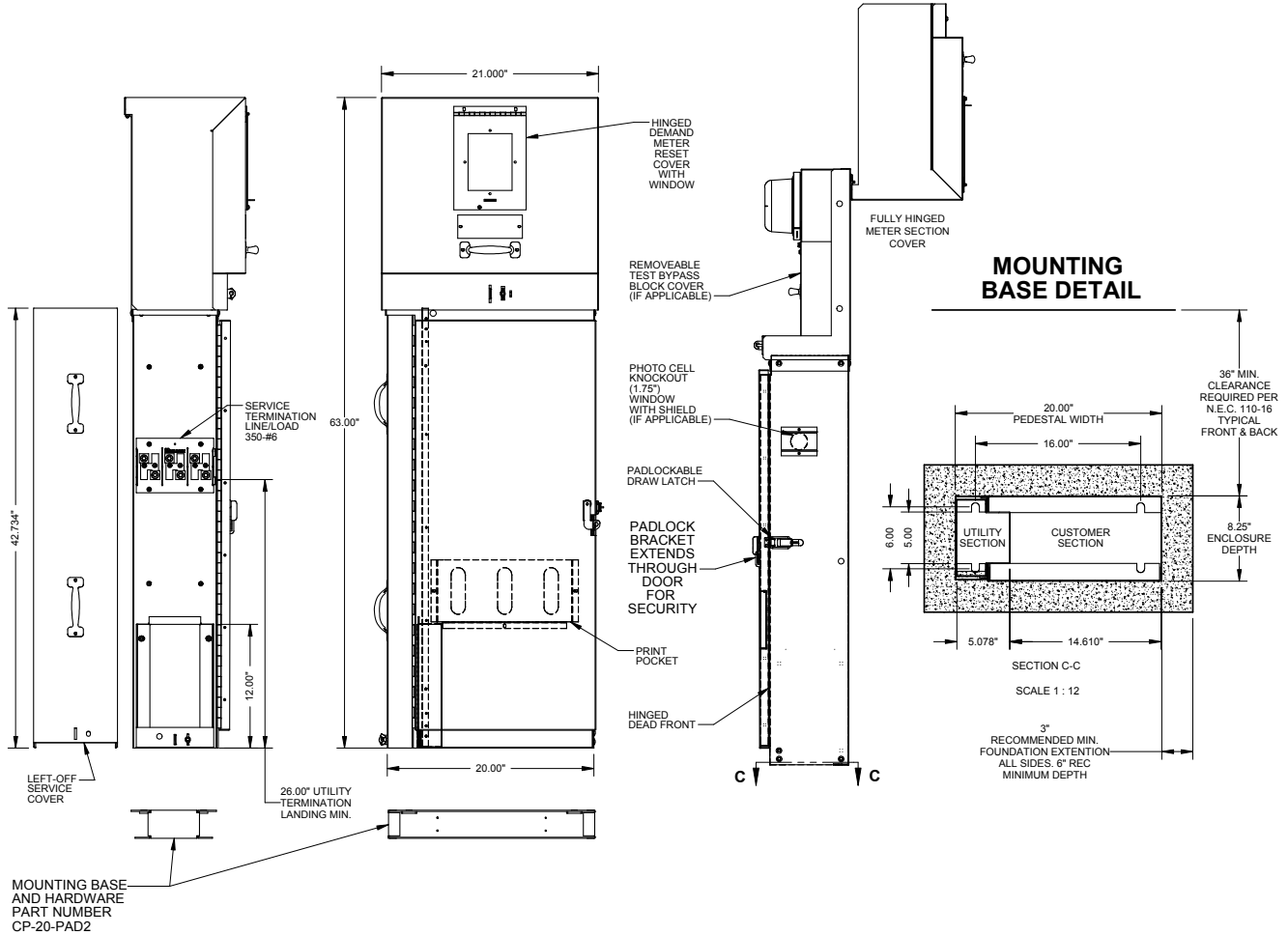

Please consult serving utility for their requirements prior to ordering or installing, as specifications and approvals vary by utility, and may require local electrical inspector approval. All installations must be installed by a licensed electrician and must comply with all national and local codes, laws and regulations. Milbank reserves the right to make changes in specifications and features shown without notice or obligation.

Commercial Pedestals

Slimline "I" Style Drawing

111
COMMERCIAL
PEDESTALS

"I" Style Slimline Metered Commercial Pedestal

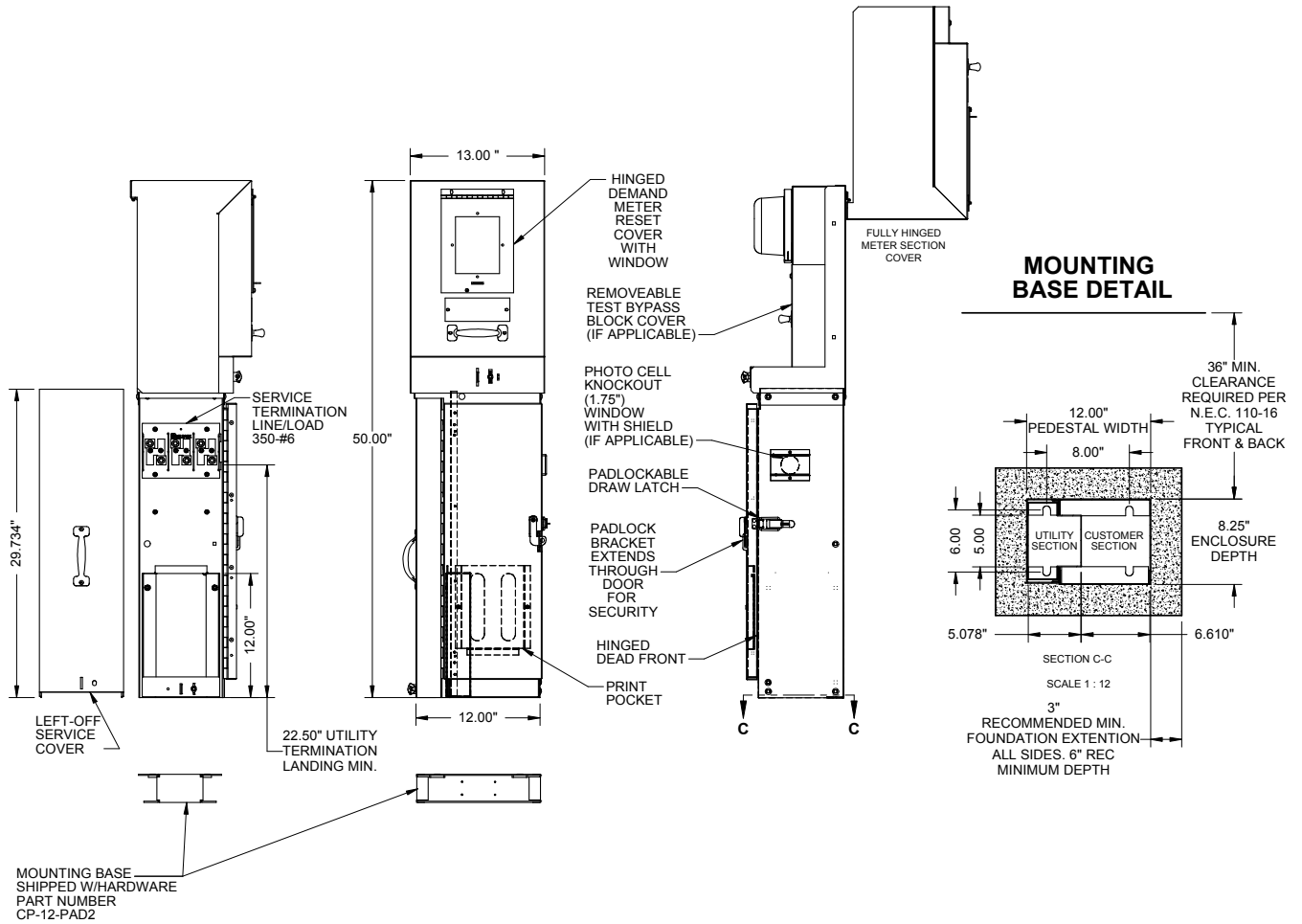

Please consult serving utility for their requirements prior to ordering or installing, as specifications and approvals vary by utility, and may require local electrical inspector approval. All installations must be installed by a licensed electrician and must comply with all national and local codes, laws and regulations. Milbank reserves the right to make changes in specifications and features shown without notice or obligation.



"J" Style Slimline Metered Commercial Pedestal

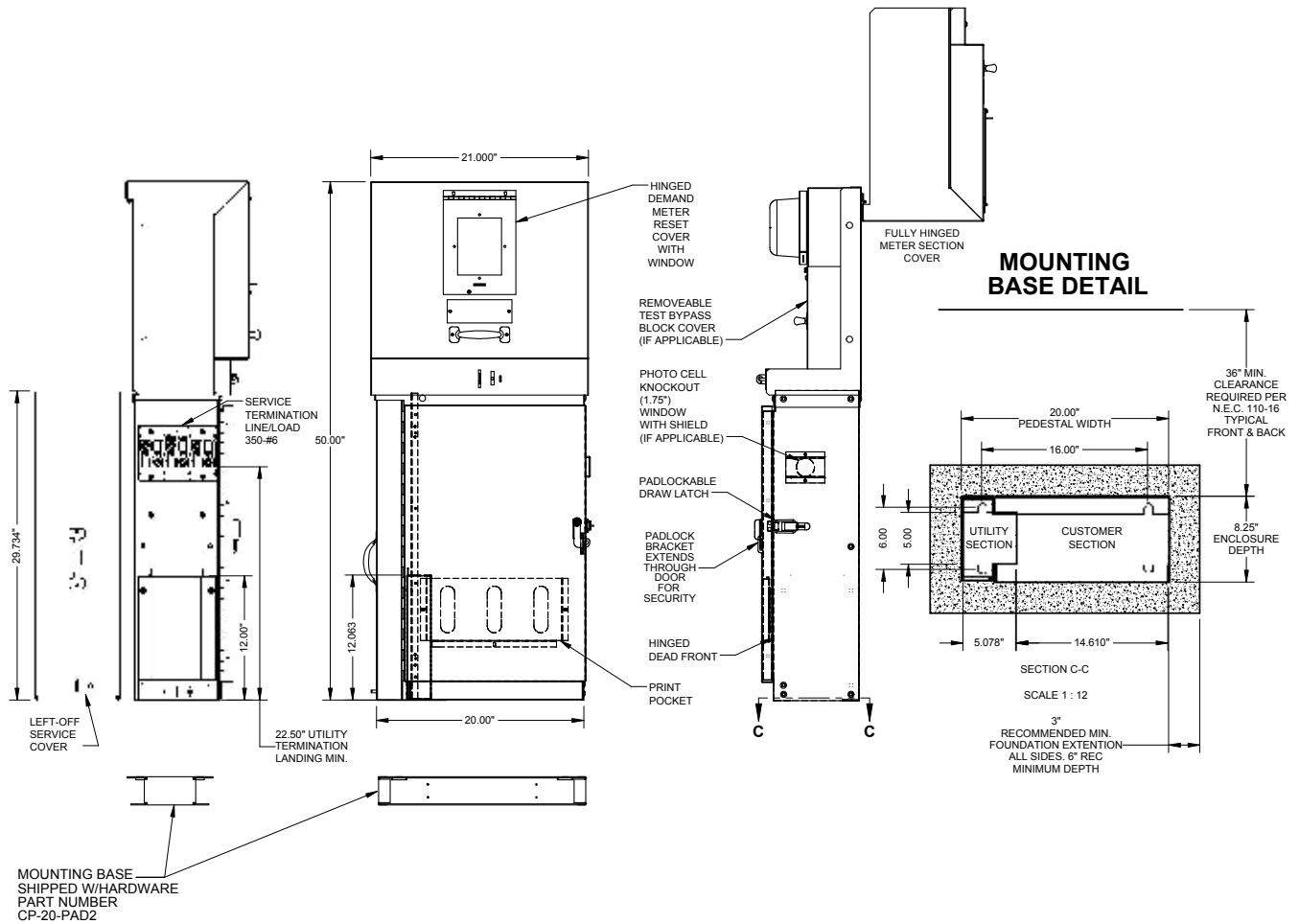

Please consult serving utility for their requirements prior to ordering or installing, as specifications and approvals vary by utility, and may require local electrical inspector approval. All installations must be installed by a licensed electrician and must comply with all national and local codes, laws and regulations. Milbank reserves the right to make changes in specifications and features shown without notice or obligation.

Commercial Pedestals

Product Worksheet

113

COMMERCIAL
PEDESTALS
PRODUCT
WORKSHEET

Please answer all of the questions listed below. Any additional information regarding application and/or future requirements will enable Milbank to configure the best product for your project.

Distributor: _____ Phone: _____ Fax: _____

Contact Name: _____ Application: _____

Milbank Representative: _____ Salesmen: _____

Project Name & Location: _____

Agency Specifications: (DOT-City-Other) _____

Unit amperage: _____ Voltage: _____ Phase: _____ Wire: _____

Meter socket (200 Amp) RING-TYPE RINGLESS Fifth Terminal? NO YES (at _____ o'clock)

Meter socket (200 Amp) RING-TYPE RINGLESS Fifth Terminal? NO YES (at _____ o'clock)

Main breaker requirements: Amp: _____ Poles: _____ KAIC: _____

Main breaker requirements: Amp: _____ Poles: _____ KAIC: _____

Interior #1 0-42 circuits _____ Load center _____ Panel board _____ Metered? YES NO

Interior #2 0-42 circuits _____ Load center _____ Panel board _____ Metered? YES NO

Branch breakers: Amp: _____ Poles: _____ KAIC: _____ Label & Special Requirements:

Qty _____ Breakers _____

Qty _____ Breakers _____

Qty _____ Breakers _____

Qty _____ Breakers _____

Qty _____ Breakers _____

Qty _____ Breakers _____

Controls:

Qty _____ Time Clock: 24 Hr _____ 7 Day _____ 365 Day Astro _____ Description: _____

Qty _____ Photo Electric Control Receptacle

Qty _____ Test switch: 2 Pos. _____ 3 Pos. _____ HOA Type _____ Other _____

Qty _____ Control Transformer _____ Voltage _____ VA Size (required for all 277/480v)

Contractors:

Type: Lighting - LT/Definite Purpose - DP/Mechanical Held - MH/Mercury - MV/IEC - IC

Qty _____ Type _____ Amp _____ Poles _____ Coil voltage _____ Other _____

Qty _____ Type _____ Amp _____ Poles _____ Coil voltage _____ Other _____

Qty _____ Type _____ Amp _____ Poles _____ Coil voltage _____ Other _____

Cabinet/Finish requirements: Alum - Untreated = AO/Alum Anodized = AL/Stainless Steel = SS

Aluminum - Painted = A / GALVANIZED STEEL PAINTED (standard) _____ (specify paint below):

MINT GREEN (standard) = G / PINE GREEN = PG / Dark Green = DG / Black = BK / Desert Tan = DT

White = W / Gray = P / Summerland Gray = SG / Other: (RAL finish number) _____

Other Requirements: _____

Please send any drawings, plans, specifications, and load/panel board schedules with worksheet.

Please consult serving utility for their requirements prior to ordering or installing, as specifications and approvals vary by utility, and may require local electrical inspector approval. All installations must be installed by a licensed electrician and must comply with all national and local codes, laws and regulations. Milbank reserves the right to make changes in specifications and features shown without notice or obligation.



NEMA Commercial Enclosures

Milbank's line of commercial enclosures includes the full gamut of styles and sizes; everything from junction boxes to transformer cabinets, telephone cabinets to wireway.

Type 1 Enclosures

Milbank's Type 1 enclosures are designed for indoor use to provide a degree of protection to personnel against access to hazardous parts and to provide a degree of protection of the equipment inside the enclosure against ingress of solid foreign objects, such as falling dirt.

Type 3R Enclosures

Milbank's Type 3R enclosures are designed for either indoor or outdoor use to provide a degree of protection from harmful effects on the equipment due to the ingress of water (rain, sleet, snow) and that will be undamaged by the external formation of ice on the enclosure.

Wireway

Milbank's wide range of wireway is available in many styles and sizes and its wide range of fittings allows it to smoothly transition to and from competitors' products.

NEMA Industrial Enclosures

Milbank's line of industrial enclosures include junction boxes, wiring trough, push-button enclosures and modular enclosures. Milbank also excels in special designs; nearly any type, size or color of enclosure you need, we can make!

Type 12 Enclosures

Enclosures constructed without knockouts for indoor use to provide a degree of protection to personnel against access to hazardous parts, and protect components against falling dirt, circulating dust and lint, and dripping or splashing water.

Type 4 Enclosures

Enclosures constructed for either indoor or outdoor use to provide a degree of protection to personnel against access to hazardous parts; protect equipment against falling dirt and windblown dust; protect against rain, sleet, snow, splashing water, and hose directed water; and is resistant to damage by the external formation of ice on the enclosure.

Industrial Enclosure Specials

Milbank specializes in custom enclosure projects, offering an almost limitless amount of styles, options, colors and sizes. Milbank will meet your needs and specifications and deliver a custom enclosure that protects your crucial electric equipment.

Thermal Management

Protect components housed in enclosures from damage caused by overheating, freezing, humidity and condensation with these thermal management products.



Please consult serving utility for their requirements prior to ordering or installing, as specifications and approvals vary by utility, and may require local electrical inspector approval. All installations must be installed by a licensed electrician and must comply with all national and local codes, laws and regulations. Milbank reserves the right to make changes in specifications and features shown without notice or obligation.

Accessories

Hubs and Closing Plates

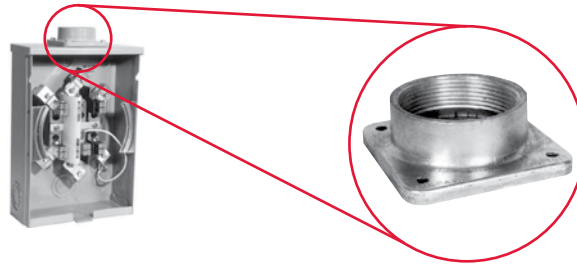
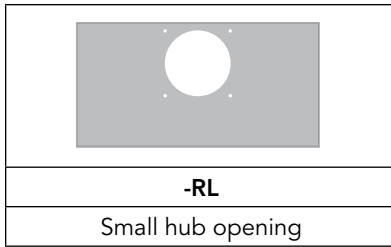

-WL A7514	-YL A7515	-ZL A7516	-DL A7517	-EL A7518	-XL A7551
1" hub	1 1/4" hub	1 1/2" hub	2" hub	2 1/2" hub	Small closing plate

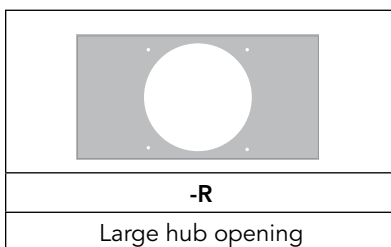

-F A8110	-G A8111	-H A8112	-X A9064	-RRL S8324
3" hub	3 1/2" hub	4" hub	Large closing plate	Large hub opening adapted to small hub opening

Notes



- **Suffix:** Add to catalog number for factory installation of hub.
- **Packaging:** Individually packed units for field installation.
- **Abbreviations:** H.O. (hub opening), C.P. (closing plate).

Please consult serving utility for their requirements prior to ordering or installing, as specifications and approvals vary by utility, and may require local electrical inspector approval. All installations must be installed by a licensed electrician and must comply with all national and local codes, laws and regulations. Milbank reserves the right to make changes in specifications and features shown without notice or obligation.



Connector Kits, Closing Kits & Generator Interlock



Connector Kits — For Use with 3/8"-16 Stud Type Units Only

					
Single			Twin		
Suffix	Part #	(3 per set) - 1Ø	Suffix	Part #	(3 per set) - 1Ø
K1	K1539	6-350	K2	K1350	6-350
K3	K1540	4-600 or (2) 1/0-250	K2L	K1350L	6-350 (non rotating)
K3L	K1540L	4-600 or (2) 1/0-250 (non rotating)	K4	K1541	4-600
Suffix	Part #	(4 per set) - 3Ø	Suffix	Part #	(4 per set) - 3Ø
K5	K3082	6-350	K6	K3442	6-350
K7	K3441	4-600 or (2) 1/0-250	K8	K3083	4-600

Bypass Link



Closing Covers

	
Meter Closing Plate (Ring Type/Ringless)	Metal Closing Plate (For Ringless Sockets)
6003 - Gray Plastic	CP-21
6116 - Clear Plastic	

Generator Interlock

K5815 - large QN with small frame Q
K5820 - large frame QN with large frame QN
K5830 - small frame Q to small frame Q

Disconnect Sleeve



Anti-Inversion Clip





Isolated Neutral Kit



Accessories

Fifth Terminal, Tap Connectors & Block Assemblies

Fifth Terminal

		
5T8K2 - 100-200 Amp "Plug-In"	K5T - 200 Amp (Block with Square Hole)	K3865 - Heavy Duty Jaw Clamping (K3866 without Neutral Wire)

Tap Connectors (3 per set)

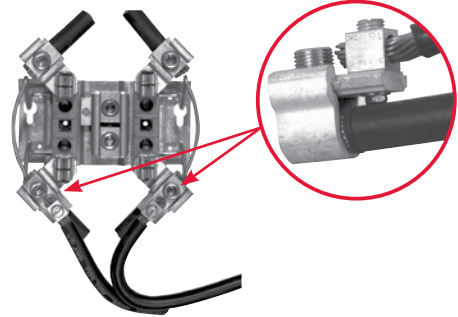
	Replaces the load or line side slide-in nut assembly on Milbank 200 amp sockets. Allows for a 100 amp tap location in addition to the #6-350 kcmil load-side connector. K5022 includes safety barrier extensions for applications over 300 VAC. Three lugs per kit.
K4977-INT - Internal Hex	
K4977-EXT - External Hex	
K5022-INT - Internal Hex (set of 4 with barrier)	

Triplex Ground

K1190 (For factory installed triplex ground, add suffix -TG to catalog number)

100 Amp Blocks *(single sockets only)*

BL7474 - Block Assembly
BL7499 - Horn Bypass Block Assembly
Z904486-AO - Nut Assembly
Z90327486-AO - Horn Bypass Nut Assembly
Z802965-AC - Neutral without Nut
Z901925-AC - Hex Nut Set Screw

200 Amp Blocks *(single sockets only)*

K4527 - Internal Hex Block Assembly (with meter support)
K4528 - External Hex Block Assembly (with meter support)
K4529 - Internal Hex Horn Bypass Block Assembly (with meter support)
K4530 - External Hex Horn Bypass Block Assembly (with meter support)
Z916265-AO - Internal Nut Assembly
Z916264-AO - External Nut Assembly
Z814898-AC - Neutral without Nut

Please consult serving utility for their requirements prior to ordering or installing, as specifications and approvals vary by utility, and may require local electrical inspector approval. All installations must be installed by a licensed electrician and must comply with all national and local codes, laws and regulations. Milbank reserves the right to make changes in specifications and features shown without notice or obligation.



UQFP Plug-In Series Circuit Breakers



UQFP



UQFP-M

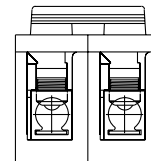
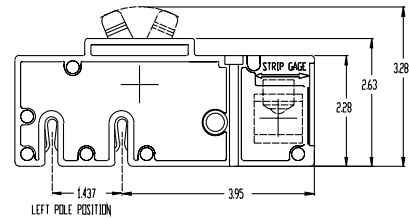
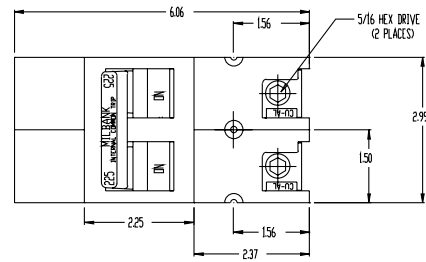

200 Amp Frame | Plug-In | 10K AIC & 22K AIC | Two-Pole | Common Trip

Amp	10K AIC Plug-In	22K AIC Plug-In	10K AIC Plug-In	22K AIC Plug-In	Connectors CU/AL	
					Line	Load
100	UQFP-100	UQFPH-100	UQFP-M-100	UQFPH-M-100	#3-#1	#1-1/0
125	UQFP-125	UQFPH-125	UQFP-M-125	UQFPH-M-125	#3-#1	#1-1/0
150	UQFP-150	UQFPH-150	UQFP-M-150	UQFPH-M-150	1/0-300	2/0-300
200	UQFP-200	UQFPH-200	UQFP-M-200	UQFPH-M-200	1/0-300	2/0-300

Notes

- **UL listed:** For use with 60°C or 75°C wire.
- **UQFP:** For parallel main circuit breaker applications.
- **UQFP-M:** For series main circuit breaker applications. Split load tab features allow for feed through capability.
- **Standard Packaging:** 5 units per 16 lb. carton.



Please consult serving utility for their requirements prior to ordering or installing, as specifications and approvals vary by utility, and may require local electrical inspector approval. All installations must be installed by a licensed electrician and must comply with all national and local codes, laws and regulations. Milbank reserves the right to make changes in specifications and features shown without notice or obligation.

Accessories

UQFB Plug-In Series Circuit Breakers



UQFB-X1



UQFB-X



UQFB



UQFB-X-MOD

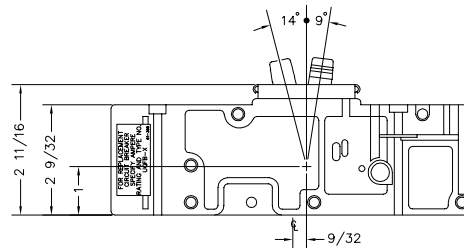
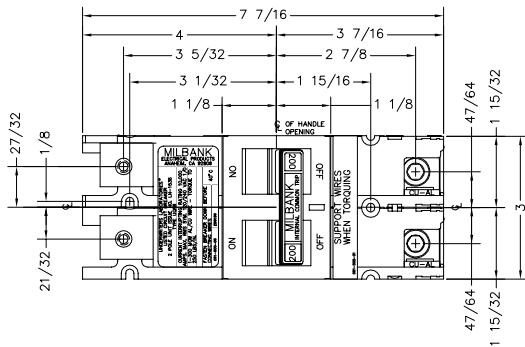

200 Amp Frame | Bolt-On | 10K AIC & 22K AIC | Two-Pole | Common Trip

Amp	10K AIC Bolt-On	22K AIC Bolt-On	10K AIC Bolt-On	Connectors CU/AL	
				Line	Load
100	UQFB-100	UQFBH-100	UQFB-100-X1	#3-#1	#1-1/0
125	UQFB-125	UQFBH-125	UQFB-125-X1	#3-#1	#1-1/0
150	UQFB-150	UQFBH-150	UQFB-150-X1	1/0-300	2/0-300
175	UQFB-175	UQFBH-175	UQFB-175-X1	1/0-300	2/0-300
200	UQFB-200	UQFBH-200	UQFB-200-X1	1/0-300	2/0-300

Notes

- **UL listed:** For use with 60°C or 75°C wire.
- **UQFB:** (2) 1/0-300 kcmil lugs provided on load and line side (cable-in, cable-out).
- **UQFB3:** Three pole available. Consult factory.
- **UQFB-X:** (2) 1/0-300 kcmil lugs provided on load side and (2) line bar bus connections on line side.
- **UQFB-M:** For series main circuit breaker applications. Split load tab features allow for feed through capability.
- **UQFB-X-MOD:** Replacement circuit breaker with line barriers removed.
- **Standard Packaging:** 5 units per 16 lb. carton.

Please consult serving utility for their requirements prior to ordering or installing, as specifications and approvals vary by utility, and may require local electrical inspector approval. All installations must be installed by a licensed electrician and must comply with all national and local codes, laws and regulations. Milbank reserves the right to make changes in specifications and features shown without notice or obligation.



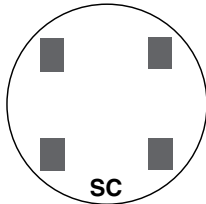

SC
2 and 3-WIRE FORMS
1S & 2S

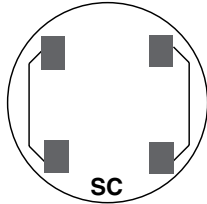

SC
2 and 3-WIRE FORMS
1S & 2S with BYPASS

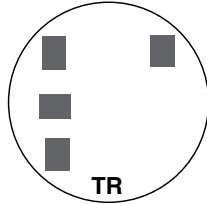

TR
2-WIRE FORM 3S
5th Term. 9 o'clock

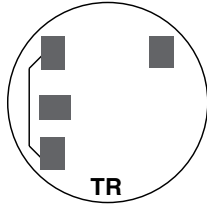

TR
2-WIRE FORM 3S
with BYPASS

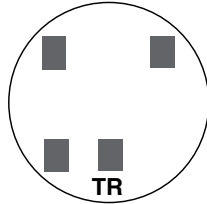

TR
2-WIRE FORM 3S
5th Term. 6 o'clock

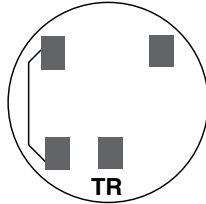

TR
2-WIRE FORM 3S
with BYPASS

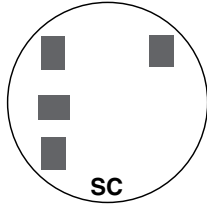

SC
2 ELEMENT
3-WIRE NETWORK
FORM 12S 5th
TERM. 9 o'clock

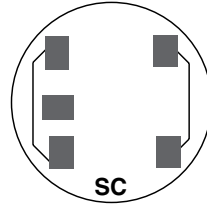

SC
2 ELEMENT 3-WIRE
NETWORK FORM 12S
with BYPASS
5th Term. 9 o'clock

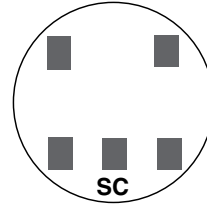

SC
2 ELEMENT
3-WIRE NETWORK
FORM 12S 5th
TERM. 6 o'clock

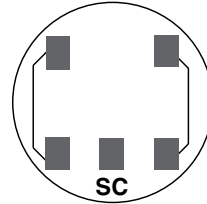

SC
2 ELEMENT 3-WIRE
NETWORK FORM 12S
with BYPASS
5th Term. 6 o'clock

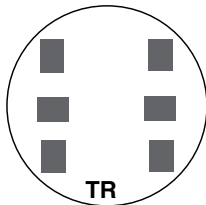

TR
3-WIRE FORM 4S

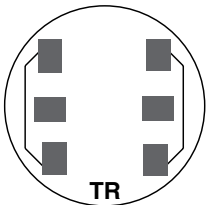

TR
3-WIRE FORM 4S
WITH BYPASS

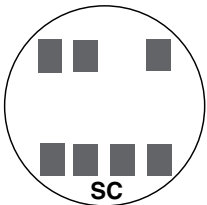

SC
2 or 3 ELEMENT
3Ø4W Y or
Y FORM 14S
FORM 15S
Y FORM 16S

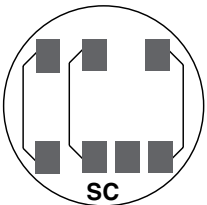

SC
2 or 3 ELEMENT
3Ø4W Y or
FORMS 14S & 15S
with BYPASS

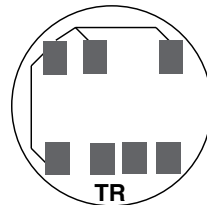

TR
2 ELEMENT
3Ø4W Y or
Y FORM 7S
FORM 24S
with BYPASS

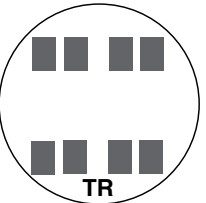

TR
2 ELEMENT
2Ø3W, 2Ø4W, 3Ø3W
FORM 5S

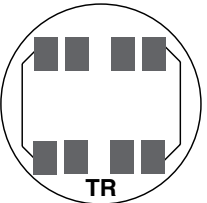

TR
2 ELEMENT Ø3W,
2Ø4W, 3Ø3W
FORM 5S with
BYPASS

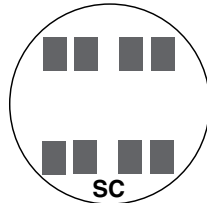

SC
2 ELEMENT
2Ø3W, 2Ø4W, 3Ø3W
FORM 13S

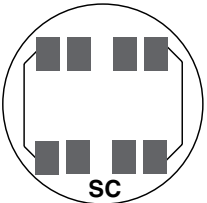

SC
2 or 3 ELEMENT
2Ø3W, 2Ø4W, 3Ø3W
FORM 13S with
BYPASS

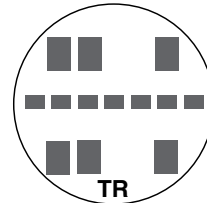

TR
2 or 3 ELEMENT
3Ø4W Y or
Y FORM 9S
FORM 8S

TR = TRANSFORMER RATED
SC = SELF CONTAINED

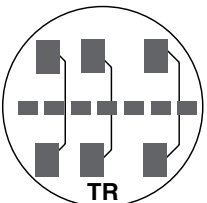

TR
2 or 3 ELEMENT
3Ø4W Y or
FORMS 8S & 9S
FORMS 8S & 9S
with BYPASS

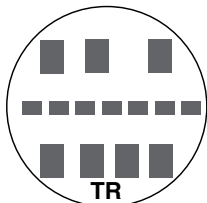

TR
2 ELEMENT
3Ø4W Y
FORM 6S

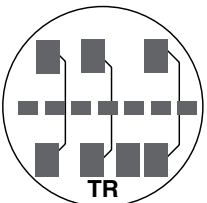

TR
2 ELEMENT
3Ø4W Y
FORM 6S
with BYPASS



Please consult serving utility for their requirements prior to ordering or installing, as specifications and approvals vary by utility, and may require local electrical inspector approval. All installations must be installed by a licensed electrician and must comply with all national and local codes, laws and regulations. Milbank reserves the right to make changes in specifications and features shown without notice or obligation.

Meter Forms

Reference Information

DIAGRAM A
1Ø2W with 1 P.T. & 1 C.T.
Single Stator Meter (2W1Ø) - Form 3S
5T Socket, Test Switch #TS04-0101

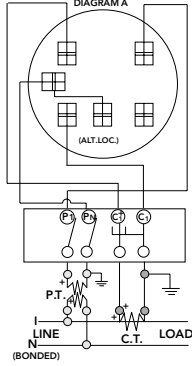

DIAGRAM B
1Ø3W with 1 C.T.
Single Stator Meter (2W1Ø) - Form 3S
5T Socket, Test Switch #TS04-0101

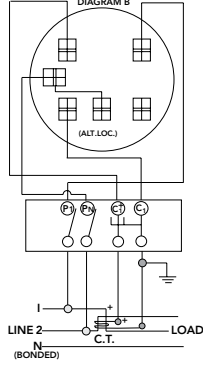

DIAGRAM C
1Ø3W with 2 C.T.'s
Single Stator Meter (3W1Ø) - Form 4S
6T Socket, Test Switch #TS07-0105

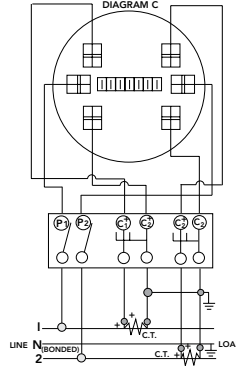

DIAGRAM D
1Ø3W or 3W Network with 2 C.T.'s
2 Stator Meter - Form 5S
8T Socket, Test Switch #TS07-0105

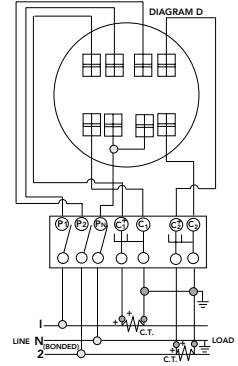

DIAGRAM E
3Ø3W "A" with 2 P.T.'s & 2 C.T.'s
2 Stator Meter - Form 5S
8T Socket, Test Switch #TS07-0105

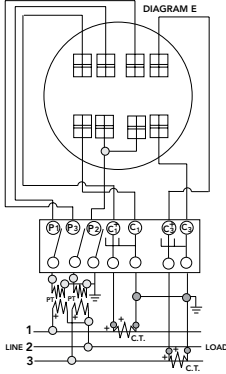

DIAGRAM F
3Ø3W "A" with 2 C.T.'s
2 Stator Meter - Form 5S
8T Socket, Test Switch #TS07-0105

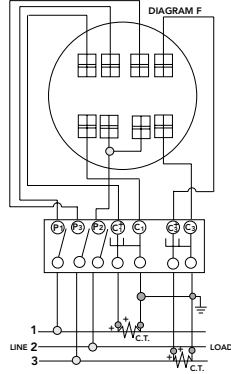

DIAGRAM G
3Ø4W "Y" with 3 C.T.'s
2 1/2 Stator Meter - Form 6S
13T Socket, Test Switch #TS10-0109

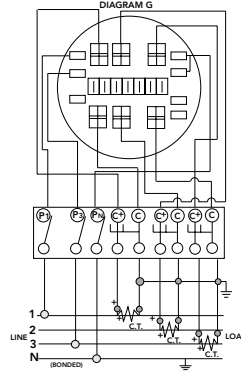

DIAGRAM H
3Ø4W "Y" with 2 P.T.'s & 3 C.T.'s
2 1/2 Stator Meter - Form 6S
13T Socket, Test Switch #TS10-0109

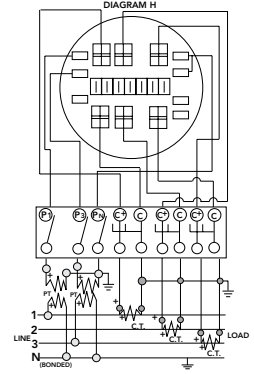

DIAGRAM I
3Ø4W "Y" or "A" with 3 C.T.'s
"Y" 3 Stator Meter - Form 9S
"A" 2 Stator Meter - Form 8S
13T Socket, Test Switch #TS10-0109

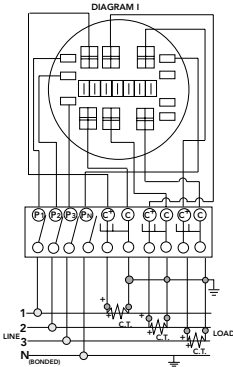
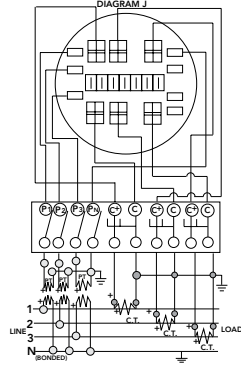

DIAGRAM J
3Ø4W "Y" with 3 P.T.'s & 3 C.T.'s
3 Stator Meter - Form 9S
13T Socket, Test Switch #TS10-0109



Prewiring: If standard factory prewiring is required, refer to wiring diagrams on this page. Determine appropriate diagram and send a copy with order. If custom factory prewiring is required, specify on order. Be sure to include meter socket catalog number, test switch make and catalog number, meter form number and provide a copy of your wiring diagram.

Please consult serving utility for their requirements prior to ordering or installing, as specifications and approvals vary by utility, and may require local electrical inspector approval. All installations must be installed by a licensed electrician and must comply with all national and local codes, laws and regulations. Milbank reserves the right to make changes in specifications and features shown without notice or obligation.



Important Note

In addition to national and local electrical codes, many utilities have specific requirements for metering equipment. Always consult the serving utility for their specifications and requirements prior to ordering or installing Milbank meter mounting equipment.

Before Energizing

1. Give equipment a thorough visual examination to determine that:
 - A. No shipping or installation damage exists.
 - B. Proper clearances have been maintained.
 - C. All connections have been made.
 - D. Equipment is clean and dry.
2. Make a thorough examination to:
 - A. Verify tightness of all bolted connections (see table below).
 - B. Manually operate all circuit breakers, switches, relays, etc.
 - C. Check rigidity of all mountings, bus bars and components.
 - D. Use test equipment to check continuity of circuitry and integrity of insulation.
3. All switches and circuit breakers should be in the "off" position.
4. Verify that manual meter bypass (if applicable) is in non-bypass position.
5. Install cover and/or close doors.
6. If installation is not being energized at this time, follow "after-energizing" steps listed below. These steps will secure the installation in case of accidental energization.

When Energizing

Use caution and follow established safety procedures:

- 1) Wear safety apparel.
- 2) Use safety equipment.
- 3) Take action to prevent injury to yourself and others in the event of failure of the installation.
- 4) Take action to prevent/decrease damage to property in the event of failure of the installation.
- 5) If you are unsure how to safely energize the installation, get someone who is knowledgeable to do it.

After Energizing

Secure the installation:

- 1) To prevent accidental contact with energized parts, cover all openings with approved filler devices.
- 2) To prevent unauthorized access, secure all covers and/or doors with approved security devices.
- 3) Attach/post information to advise others of potential hazards associated with the installation.

Recommended Torque for General Applications*

Nominal Size	Joint Description		Head Type	Torque (Inch Lbs.)
	Screw	Nut		
10	Brass	Brass Nut or Extruded Hole	All	20-25 inch lbs.
10	Steel	Copper or Aluminum Busbar ≤ 1/8"	All	25-30 inch lbs.
10	Steel	Steel Nut or Extruded Hole; CU or AL Busbar > 1/8"	All	30-35 inch lbs.
12	Steel	Aluminum Extruded Hole	All	30-35 inch lbs.
12	Steel	Steel Nut or Extruded Hole	All	40-50 inch lbs.
1/4	Steel	Aluminum Extruded Hole	All	40-50 inch lbs.
1/4	Steel	Steel Nut or Extruded Hole; CU or AL Busbar	All	50-60 inch lbs.
5/16	Steel	Aluminum Extruded Hole	Hex	60-70 inch lbs.
5/16	Steel	Steel Nut or Extruded Hole; CU or AL Busbar	Hex	100-150 inch lbs.
3/8	Steel	Steel Nut	Hex	150-200 inch lbs.
1/2	Steel	Steel Nut	Hex	200-250 inch lbs.

* Interior labels typically indicate the required torque for wire connectors and studs, and should be referenced first.
CU: Copper
AL: Aluminum



Please consult serving utility for their requirements prior to ordering or installing, as specifications and approvals vary by utility, and may require local electrical inspector approval. All installations must be installed by a licensed electrician and must comply with all national and local codes, laws and regulations. Milbank reserves the right to make changes in specifications and features shown without notice or obligation.

Materials & Finishes

Reference Information

Materials

Steel Quality

The meter equipment listed in this catalog is made of galvanized steel (AISI* G90) to afford the best possible weather proofing.
*American Iron and Steel Institute.

Steel Sheet

16 gauge, galvanized, sheet: 1 1/4 oz./ sq.ft. class zinc-coated. (AISI G90)
14 gauge, galvanized, sheet: 1 1/4 oz./ sq.ft. class zinc-coated.

Aluminum Extrusion

Wire-Terminal: Alloy; 6061-T6, Tin-plated for CU/AL wire.
Bus Bar: Alloy; 6101-O & 6063-O

Aluminum Sheet

3000 series aluminum sheet, H14, or 5052 series aluminum sheet, H32. Where applicable thicknesses range from .064-.125

Copper Sheet & Bus

Electrolytic copper with tin plating in most applications.

Insulating Materials

- In most units, support bases for current-carrying components are molded from fiberglass reinforced high-strength, track resistant, thermoset polyester molding compounds.
- Clear or black safety shields and polarity barriers are molded from high-strength, track resistant, polycarbonate molding compounds.
- Various sheet insulating materials, as appropriate for the application are utilized in the fabrication of flat, formed and punched component parts and barriers.

Finish

Process

Light gray state-of-the-art electrostatically applied powder paint offers a durable, non-fading finish. For further information concerning the chemical analysis of the weather resistant finish, please contact the factory.

Metal Fasteners

Zinc-coated with a chromate dip.

Ratings & Compliance

Ratings & Compliance

All Milbank electrical enclosures in this catalog are rated "Type 3R Enclosure" unless specified otherwise on the product's page. All enclosures with a UL designation are constructed per the appropriate UL Standard and may be installed per the National Electric Code. UL procedure files associated with the UL Standards are listed as follows: Meter Sockets (UL 414, File E30202), Test Switches (UL 414, File E62531), Power Outlets (UL 231, File E90945), Panelboards (UL 67, File E32628) and Pullout Switches (UL 1429, File E133062). Additional standards are utilized as applicable: Meter Sockets (ANSI C12.7), Test Switches (ANSI C12.9) and Panelboards (NEMA PB-1).

Please consult serving utility for their requirements prior to ordering or installing, as specifications and approvals vary by utility, and may require local electrical inspector approval. All installations must be installed by a licensed electrician and must comply with all national and local codes, laws and regulations. Milbank reserves the right to make changes in specifications and features shown without notice or obligation.



6003.....	116	BC214.....	46	K3082.....	116
6116.....	116	BC234.....	46	K3083.....	116
020-147-00-00-0.....	65	BC318.....	46	K3441.....	116
105J.....	103	BC338.....	46	K3442.....	116
10URMD.....	92	BC418.....	46	K3865.....	103
10URMD24.....	92	BC438.....	46	K3865.....	117
114TB.....	31	BC518.....	46	K3866.....	117
115TB.....	31	BC538.....	46	K4527.....	117
117TB.....	31	BC618.....	46	K4528.....	117
124TB.....	31	BC638.....	46	K4529.....	117
125TB.....	31	BL7474.....	117	K4530.....	117
127TB.....	31	BL7499.....	117	K4709-02.....	85
16URMD.....	92	CL200-D.....	87	K4709-02-3R.....	85
16URMD24.....	92	CP-16PDMNT-CALT.....	103	K4722.....	60
20URMD.....	92	CP-21.....	116	K4729.....	60
20URMD24.....	92	CP-24PDMNT-CALT.....	103	K4793.....	60
214MTB.....	32	CP-32PDMNT.....	103	K4794.....	60
214MTB/22.....	33	CP3B0181UMWIR02.....	98	K4795.....	60
214MTB-48.....	34	CP3B0281UMWIR03.....	98	K4796.....	60
214MTB-P.....	35	CP3B0281UMWIR04.....	98	K4797.....	60
214MTB-P48.....	35	CP3B11110A22SL1.....	96	K4797.....	60
215MTB.....	32	CP3B11115A22.....	95	K4798.....	60
215MTB-48.....	34	CP3B12110A22SL1.....	96	K4798.....	60
215MTB-P.....	35	CP3B12119A22.....	95	K4800-D.....	87
215MTB-P48.....	35	CP3B1411jb.....	97	K4802.....	116
217MTB.....	32	CP3B14120b.....	97	K4806-BP.....	59
217MTB/22.....	33	CP3B51110A22SL1.....	96	K4903.....	60
217MTB-48.....	34	CP3B51115A22.....	95	K4904.....	60
217MTB-P.....	35	CP3B52110A22SL1.....	96	K4977-EXT.....	117
217MTB-P48.....	35	CP3B52119A22.....	95	K4977-INT.....	117
224MTB.....	36	CP3B5411Jb22.....	97	K5022-INT.....	117
224MTB/22.....	37	CP3B54120b22.....	97	K5400-100MBM.....	88
224MTB-48.....	38	CP3B-AUX-1200.....	90	K5400-100MBU.....	88
224MTB-P.....	39	CP-ABK5/8.....	103	K5410.....	86
224MTB-P48.....	39	CP-PE-HOA-3POS.....	103	K5411.....	83
225MTB-P.....	39	CP-PE-TYP5-2POS.....	103	K5412.....	84
225MTB-P48.....	39	CP-TC24H.....	103	K5413.....	83
227MTB.....	36	CP-TC7D.....	103	K5415.....	86
227MTB/22.....	37	CP-TCWIRE.....	103	K5421.....	86
227MTB-48.....	38	CT203611-HC.....	61	K5747.....	60
227MTB-P.....	39	CT242411-SC.....	61	K5752.....	60
227MTB-P48.....	39	CT243011-HC.....	61	K5815.....	116
243210-LC3R-SP.....	59	CT243011-SC.....	61	K5820.....	116
25URMD.....	92	CT24329-SC.....	61	K5830.....	116
25URMD24.....	92	CT243611-HC.....	61	K5920-10GR.....	82
323610-LC3R-SP.....	59	CT243611-SC.....	61	K5920-111GR.....	82
363016-CT3R.....	59	CT244811-HC.....	61	K5920-11GR.....	82
363612-CT3R-SP.....	59	CT244811-SC.....	61	K5920-38.....	82
364812-CT3R-SP2.....	59	CT303011-SC.....	61	K5920-41.....	82
403456-SC.....	67	CT303611-HC.....	61	K5920-522.....	82
518K2.....	117	CT303611-SC.....	61	K5920-54.....	82
701776-MO.....	89	CT303614-SC.....	61	K5920-58.....	82
703997-MO.....	79	CT304811-HC.....	61	K5920-75.....	82
704995-MO.....	79	CT363611-HC.....	61	K5920-BLANK.....	82
706761-MO.....	79	CT363611-SC.....	61	K5T.....	117
707915-MO.....	79	CT364211-SC.....	61	K6212.....	83
708080-MO.....	89	CT364811-HC.....	61	K6213.....	84
708777-MO.....	79	CT364811-SC.....	61	K8180.....	116
708784-MO.....	88	CT364814-SC.....	61	M400-aps.....	27
708785-MO.....	79	CT424211-SC.....	61	M400-aps-BS.....	27
A7514.....	115	CT484811-HC.....	61	M400-PAR-UG.....	26
A7515.....	115	CT484811-SC.....	61	M400-UG-APS-F.....	28
A7516.....	115	CT484814-HC.....	61	M400-UG-APS-F-BS.....	28
A7517.....	115	CT484814-SC.....	61	M400-UG-APS-LC.....	28
A7518.....	115	K1047.....	116	M400-UG-APS-LC-BS.....	28
A7551.....	115	K1190.....	117	M400-UG-APS-P.....	28
A8110.....	115	K1350.....	116	M401-UG.....	29
A8111.....	115	K1350L.....	116	M401-UG-BS.....	29
A8112.....	115	K1539.....	116	M404-UG-LC.....	30
A9064.....	115	K1540.....	116	M404-UG-LC-BS.....	30
AP2300-03.....	10	K1540L.....	116	M5-144.....	116
AP2300-04.....	10	K1541.....	116	MPAP-100-78.....	64



Please consult serving utility for their requirements prior to ordering or installing, as specifications and approvals vary by utility, and may require local electrical inspector approval. All installations must be installed by a licensed electrician and must comply with all national and local codes, laws and regulations. Milbank reserves the right to make changes in specifications and features shown without notice or obligation.

MPAP-100-MB-78.....	64	U214MTB/22.....	33	U3532-X-K1.....	49
MPAP-200-20GR-78.....	64	U214MTB-48.....	34	U3533-X-K3.....	49
MPAP-200-78.....	64	U214MTBL.....	40	U3534-X-K3.....	49
MPAP-200-MB-78.....	64	U214MTB-P.....	35	U3548-X.....	21
MPAP-200-MBLC-80.....	65	U214MTB-P48.....	35	U3555-R.....	62
MPAP-BLANK-78.....	64	U214MTBPL.....	40	U3565-O.....	62
MPAP-BLANK-78R.....	64	U215MTB.....	32	U3574-RL-200.....	24
MPAPD-BLANK-78.....	64	U215MTB-P.....	35	U3577-RL-200.....	24
MPAPD-BLANK-78R.....	64	U215MTB-P48.....	35	U3584-O-200.....	24
MPRV-100-20GR-78.....	63	U217MTB.....	32	U3587-O-200.....	24
MPRV-100-78.....	63	U217MTB/22.....	33	U3802.....	7
MPRV-100-MB-78.....	63	U217MTB-48.....	34	U3812.....	7
MPRV-100-MBLC-80.....	65	U217MTBL.....	40	U3822-20GWR.....	8
MPRV-503020GR-78.....	63	U217MTB-P.....	35	U3832.....	7
MPRV-50-78.....	63	U217MTB-P48.....	35	U3852-XL.....	17
MPRV-BLANK-78.....	63	U217MTBPL.....	40	U3862.....	7
MPRV-BLANK-78-R-5T.....	63	U224MTB.....	36	U4013-X.....	22
MR-2.....	89	U224MTB/22.....	37	U4015-O.....	14
MS-24-TB.....	44	U224MTB-48.....	38	U4031-O-2/200.....	26
MS-25-TB.....	44	U224MTBL.....	40	U4175-RL-BLG.....	11
MS-27-TB.....	44	U224MTB-P.....	39	U4517-DL-M4.....	14
PB-011.....	45	U224MTB-P48.....	39	U4518-O-W.....	14
PB-012.....	45	U224MTBPL.....	40	U4518-XL-W.....	14
PB-014.....	45	U227MTB.....	36	U4540-XL.....	91
PB-014-NK.....	45	U227MTB/22.....	37	U4542-XL.....	91
PB-018.....	45	U227MTB-48.....	38	U4544-XL.....	91
PB-018-NK.....	45	U227MTBL.....	40	U4546-XL.....	91
PB-032.....	45	U227MTB-P.....	39	U4548-RXL.....	91
PB-034.....	45	U227MTB-P48.....	39	U4549-RXL.....	91
PB-034-NK.....	45	U227MTBPL.....	40	U4881-O.....	9
PB-038.....	45	U2594-X.....	22	U4881-O-50GB.....	9
PF-BL.....	67	U2827-X.....	22	U4881-O-60GB.....	9
PF-KR.....	67	U2852-X.....	50	U4909-O-11GR.....	75
PT223.....	44	U2853-X.....	50	U5000-XL.....	80
PT224.....	44	U2854-X.....	50	U5000-XL-41.....	80
PT263.....	44	U2855-X.....	50	U5000-XL-55.....	80
PT264.....	44	U2856-X.....	50	U5000-XL-75.....	80
PT323.....	44	U2862-X.....	50	U5001-RL-01.....	77
PT324.....	44	U2863-X.....	50	U5056-O.....	21
PT363.....	44	U2864-X.....	50	U5059-x-2/200.....	26
PT364.....	44	U2865-X.....	50	U5100-XL.....	80
Q115.....	79	U2866-X.....	50	U5100-XL-41.....	80
Q120.....	79	U3251-O-200-CB.....	28	U5100-XL-55.....	80
Q130.....	79	U3319-R.....	62	U5100-XL-75.....	80
Q2100.....	79	U3320-R.....	62	U5136-O.....	72
Q220.....	79	U3321-R.....	62	U5136-O-100S.....	72
Q250.....	79	U3322-R.....	62	U5136-O-200S.....	72
RBK-1.....	65	U3323-R.....	62	U5137-O.....	72
S8324.....	115	U3328-RXL.....	14	U5137-O-100S.....	72
TB100-47.....	44	U3339-O.....	62	U5137-O-200S.....	72
TB100-5.....	44	U3340-O.....	62	U5138-O.....	72
TB200-47.....	44	U3341-O.....	62	U5138-O-200S.....	72
TB200-5.....	44	U3342-O.....	62	U5139-O.....	72
TB200-LL.....	44	U3343-O.....	62	U5168-XTL-100.....	25
U1060-RL.....	13	U3412-O.....	47	U5168-XTL-100-KK.....	25
U1079-R.....	20	U3413-O.....	47	U5168-XTL-100-KK-5T.....	25
U1129-O-K3L-K2L.....	20	U3414-O.....	47	U5168-XTL-150.....	25
U1211-RXL.....	17	U3415-O.....	47	U5168-XTL-150-KK.....	25
U1252-X-K1.....	49	U3416-O.....	47	U5168-XTL-150-KK-5T.....	25
U1253-X-K3.....	49	U3462-O.....	47	U5168-XTL-200.....	25
U1254-X-K3.....	49	U3463-O.....	47	U5168-XTL-200-KK.....	25
U1255-X-K4.....	49	U3464-O.....	47	U5169-XTL-100.....	25
U1256-X-K4.....	49	U3465-O.....	47	U5169-XTL-150.....	25
U1431-R.....	20	U3466-O.....	47	U5169-XTL-200.....	25
U1432-O.....	20	U3504-XL.....	16	U5200-XL.....	81
U1527-O.....	13	U3507-XL.....	16	U5200-XL-41.....	81
U1681-RL.....	12	U3514-XL.....	16	U5200-XL-55.....	81
U1797-O-K3L-K2L.....	20	U3517-XL.....	16	U5200-XL-75.....	81
U1819-X.....	20	U3522-XL-K1.....	48	U5240-O.....	70
U1980-O.....	13	U3523-XL-K1.....	48	U5240-O-100S.....	70
U2120-X.....	22	U3524-XL-K2.....	48	U5240-O-200S.....	70
U214MTB.....	32	U3525-XL-K2.....	48	U5241-O.....	70

Please consult serving utility for their requirements prior to ordering or installing, as specifications and approvals vary by utility, and may require local electrical inspector approval. All installations must be installed by a licensed electrician and must comply with all national and local codes, laws and regulations. Milbank reserves the right to make changes in specifications and features shown without notice or obligation.



U5241-O-100S.....	70	UC3426-XL.....	55
U5241-O-200S.....	70	UC3428-XL.....	55
U5242-O.....	70	UC3433-XL.....	55
U5242-O-200S.....	70	UC3434-XL.....	55
U5243-O.....	70	UC3435-XL.....	55
U5268-XTL-150.....	25	UC3436-XL.....	55
U5268-XTL-150-KK.....	25	UC3438-XL.....	55
U5268-XTL-200.....	25	UC7233-XL.....	54
U5268-XTL-200-KK.....	25	UC7235-XL.....	54
U5269-XTL-200.....	25	UC7237-XL.....	54
U5300-O.....	81	UC7461-YL-TGE-DES.....	55
U5300-O-41.....	81	UC7544-RL.....	54
U5300-O-55.....	81	UC7545-RL.....	54
U5300-O-75.....	81	UC7582-RL.....	54
U5706-O-200S.....	74	UC7636-YL-TGE-DES.....	55
U5706-O-200S-KK.....	74	UF4015-KO.....	15
U5707-O-200S.....	74	UF4517-KO.....	15
U5759-x-2/200.....	26	UF4518-KO.....	15
U5865-XL-38GBGRW.....	78	UF4969-KO.....	15
U5882-X.....	52	UQFB-100.....	119
U5883-X.....	52	UQFB-100-X1.....	119
U5884-X.....	52	UQFB-125.....	119
U5885-X.....	52	UQFB-125-X1.....	119
U5886-X.....	52	UQFB-150.....	119
U5902-X.....	52	UQFB-150-X1.....	119
U5903-X.....	52	UQFB-175.....	119
U5904-X.....	52	UQFB-175-X1.....	119
U5905-X.....	52	UQFB-200.....	119
U5906-X.....	52	UQFB-200-X1.....	119
U5929-XL-INS.....	11	UQFBH-100.....	119
U5934-XL-BLG.....	11	UQFBH-125.....	119
U5971-XL-100.....	23	UQFBH-150.....	119
U5971-XL-200.....	23	UQFBH-175.....	119
U6087-XL.....	11	UQFBH-200.....	119
U6087-XL-INS.....	11	UQFP-100.....	118
U6276-O-100.....	68	UQFP-125.....	118
U6276-O-100MB.....	68	UQFP-150.....	118
U6276-O-10GR.....	68	UQFP-200.....	118
U6276-O-41.....	68	UQFPH-100.....	118
U6276-O-54.....	68	UQFPH-125.....	118
U6276-O-55.....	68	UQFPH-150.....	118
U6276-O-75.....	68	UQFPH-200.....	118
U7021-RL-TG.....	13	UQFPH-M-100.....	118
U7040-XL-TG.....	13	UQFPH-M-125.....	118
U7043-XL-TG.....	13	UQFPH-M-150.....	118
U7422-RXL.....	18	UQFPH-M-200.....	118
U7423-RXL.....	18	UQFP-M-100.....	118
U7487-O.....	12	UQFP-M-125.....	118
U7487-RL.....	12	UQFP-M-150.....	118
U7490-O.....	12	UQFP-M-200.....	118
U7490-RL.....	12	USE-AP-200-MB.....	23
U7573-RL.....	18	USE-AP-200-ML.....	23
U8032-XL.....	48	Z020-148-00-00-0.....	65
U8033-XL.....	48	Z020-148-00-00-0.....	79
U8034-XL.....	48	Z1050596.....	65
U8035-XL.....	48	Z1050596.....	79
U8036-XL.....	48	Z700911-MO.....	79
U8100-RL.....	18	Z708767-MO.....	89
U9319-XL.....	17	Z802965-AC.....	117
U9320-RXL.....	18	Z814898-AC.....	117
U9550-RRL.....	19	Z818052-SC.....	89
U9551-RXL.....	19	Z818480-SC.....	89
U9700-RRL.....	19	Z901925-AC.....	117
U9701-RXL.....	19	Z90327486-AO.....	117
U9800-RRL.....	19	Z904486-AO.....	117
U9801-RXL.....	19	Z915141-AC.....	88
UC1290-XL.....	54	Z916264-AO.....	117
UC1291-RL.....	54	Z916265-AO.....	117
UC1299-XL.....	54	Z917602-AC.....	88
UC1300-RL.....	54	Z918447-AC.....	89
UC3423-XL.....	55	Z918449-AC.....	89
UC3425-XL.....	55	Z918466-AC.....	88



Please consult serving utility for their requirements prior to ordering or installing, as specifications and approvals vary by utility, and may require local electrical inspector approval. All installations must be installed by a licensed electrician and must comply with all national and local codes, laws and regulations. Milbank reserves the right to make changes in specifications and features shown without notice or obligation.

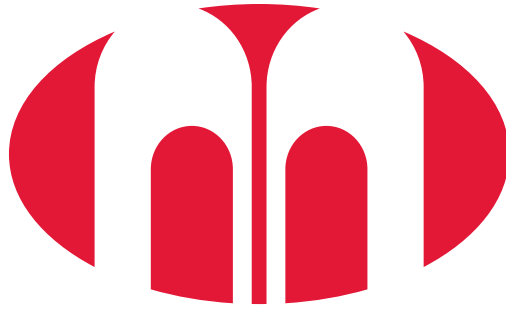

MILBANK[®]

ENERGY AT WORK

