

Arrow Hart heavy-duty straight blade decorator receptacles

Project Name:	Prepared By:
Project Number:	Date:
Catalog Number:	Type:

Description

2-Pole, 3-Wire Grounding
 15A 125V/AC;
 20A 125V/AC
 NEMA 5-15, 5-20

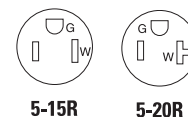

6352



TR6352

Design features

- Tamper resistant receptacles provide compliance with NEC® Article 406.11 that states that all receptacles installed in dwelling units must be tamper resistant
- Black tamper resistant shutters on TR models create a seamless look, while ensuring code compliance and preventing the insertion of foreign objects
- Durable impact and chemical resistant nylon face is virtually unbreakable (excluding 6252 and 6352)
- Terminal screws are backed out and ready to wire
- Extra-long and extra-wide mounting straps
- Terminals accept up to #10 solid or stranded wire

Table 1. Heavy-duty decorator receptacles



Rating		NEMA	Description	Color suffix	Catalog no.	
A	V/AC					
15	125	5-15R	Duplex receptacle, back & side wire	B, BK, GY, LA, V, W	□ 6252__	
			Single receptacle, back & side wire	V, W	□ 6250__*	
20	125	5-20R	Duplex receptacle, back & side wire	B, BK, GY, LA, V, W	□ 6352__	
			Single receptacle, back & side wire	B, V, W	□ 6350__*	

* UL Listed & CSA certified

Table 2. Tamper resistant heavy-duty decorator receptacles



Rating		NEMA	Description	Color suffix	Catalog no.	
A	V/AC					
15	125	5-15R	Decorator duplex receptacle, back & side wire	GY, LA, V, W	□ TR6252__	
			Decorator single receptacle, back & side wire	B, BK, V, W	□ TR6250__	
20	125	5-20R	Decorator duplex receptacle, back & side wire	B, BK, GY, LA, V, W	□ TR6352__	
			Decorator single receptacle, back & side wire	LA, V, W	□ TR6350__*	

* Not Fed Spec



Powering Business Worldwide

Compliances, specifications and availability are subject to change without notice.

Project Name:	Prepared By:
Project Number:	Date:
Catalog Number:	Type:

Applications

Heavy-duty grade duplex receptacles are challenged on a daily basis to provide a consistent, reliable means of connectivity in a wide variety of environments. The applications vary greatly by environment, and provide challenges from impact and chemical resistance to environmental extremes such as heat and moisture. The breadth of the Arrow Hart heavy-duty straight blade receptacle line provides solutions for all environments and applications.

Table 3. Specifications

Catalog No.	6252, 6250, 6352, 6350 Series	TR6250, TR6252, TR6350, TR6352 Series
Device type	Decorator heavy-duty grade receptacles	Tamper resistant decorator heavy-duty grade receptacles
Wiring type	Back & side wire	Back & side wire
Testing & code compliance	<ul style="list-style-type: none"> • cULus • NOM • UL listed (6250 & 6350) • CSA (6250 & 6350) • Complies with NEMA WD-1 & NEMA WD-6 	<ul style="list-style-type: none"> • cULus • NOM • Fed spec (except TR6350) • Complies with NEMA WD-1 & NEMA WD-6
Environmental specifications	Flammability: meets ul 94 requirements; v2 rated Temperature rating: -20°C to 70°C (-4°F to 158°F)	Flammability: meets ul 94 requirements; v2 rated Temperature rating: -20°C to 70°C (-4°F to 158°F)
Electrical specifications	Dielectric voltage: withstands 2000v per ul 498 Current interrupting: yes, at full-rated current Temperature rise: max. 30°C (86°F) after 250 cycles of overload @ 200% of rated current (dc).	Dielectric voltage: withstands 2000v per ul 498 Current interrupting: yes, at full-rated current Temperature rise: standard - max. 30°C (86°F) after 100 cycles of overload @ 150% of rated current (dc). Fed. Spec. - Max. 30°C (86°F) after 250 cycles of overload @ 200% of rated current (dc)
Mechanical specifications	Terminal accommodation: #14 - 10 awg Voltage ratings: permanently marked on device	Terminal accommodation: #14 - 10 awg Voltage ratings: permanently marked on device

Table 4. Materials

Catalog No.	6250, 6350 Series	6252, 6352 Series	TR6250, TR6252, TR6350, TR6352 Series
Face	Nylon	Nylon	Nylon
Base	Nylon	PVC	Nylon
Strap	0.050" thick galvanized steel	0.046" thick galvanized steel	0.050" thick galvanized steel
Auto ground	Phosphor bronze staple	Phosphor bronze staple	Phosphor bronze staple
Line contacts	0.037" thick 3-leaf brass	0.030" thick 3-leaf brass	0.030" thick 3-leaf brass
Ground contact	Riveted	Riveted	Riveted
Terminal screws	#8-32 Steel, brass plated hot, neutral screw nickel plated	#8-32 Steel, brass plated hot, neutral screw nickel plated	#8-32 Steel, brass plated hot, neutral screw nickel plated
Ground screw	#8-32 Steel (green)	#8-32 Steel (green)	#8-32 steel (green)
Tamper resistant shutters	N/A	N/A	Reliable Delrin® shutter assembly

Table 5. Color ordering information

For ordering devices, include Cat. No. followed by the color code: B (Brown), BK (Black), GY (Gray) LA (Light Almond), V (Ivory), W (White)

B	BK	GY	LA	V	W
Brown	Black	Gray	Lt. Almond	Ivory	White

Project Name:	Prepared By:
Project Number:	Date:
Catalog Number:	Type:

Product dimensions

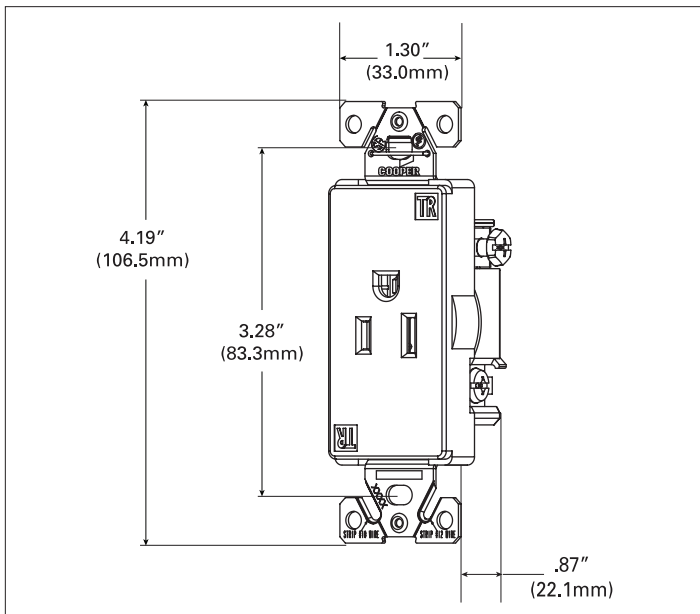

Figure 1. TR6250 Line art with dimensions

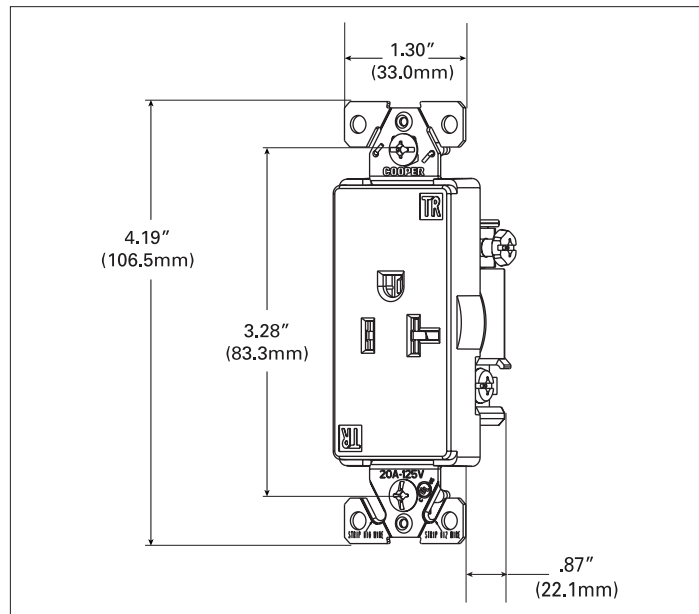

Figure 2. TR6350 Line art with dimensions

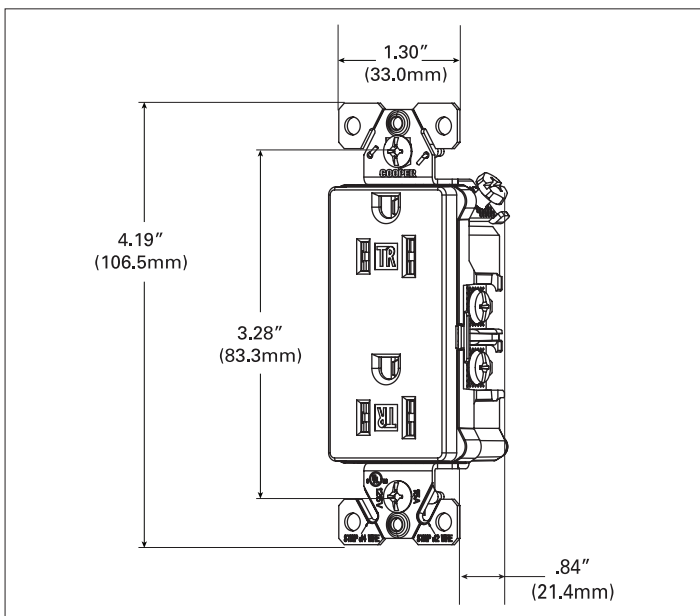

Figure 3. TR6252 Line art with dimensions

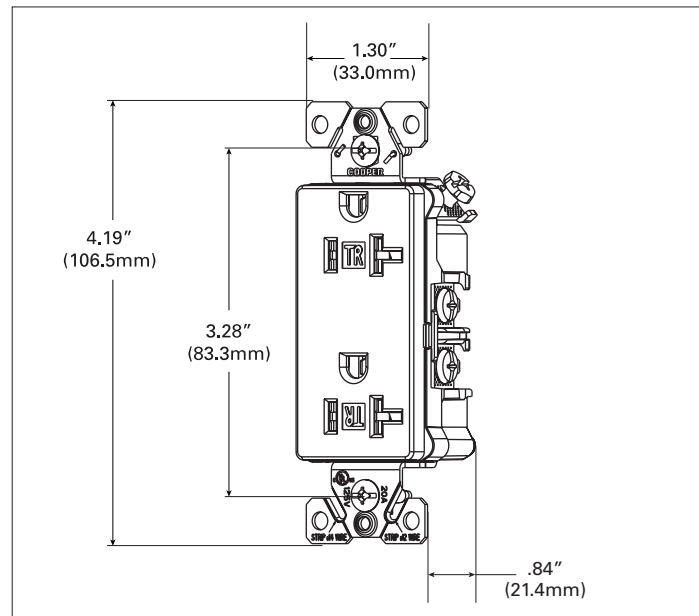









Figure 4. TR6352 Line art with dimensions

Project Name:	Prepared By:
Project Number:	Date:
Catalog Number:	Type:

Certifications & compliances

Catalog No.							
6252	•			•	•	•	
6250		•		•	•	•	
6352	•			•	•	•	
6350		•		•	•		
TR6250	•			•	•		
TR6252	•		•			•	•
TR6350	•					•	
TR6352	•		•			•	•

KEY:  cULus  UL  Fed Spec  Indicates USMCA compliant
 CSA  NOM  Arrowlink

Compliances, specifications and availability are subject to change without notice.

Electrical Sector
203 Cooper Circle
Peachtree City, GA 30269
United States
Eaton.com
Eaton.com/wiringdevices

Electrical Sector
Canada Operations
5925 McLaughlin Road
Mississauga, Ontario, L5R 1B8
Canada
EatonCanada.ca
Eaton.com/wiringdevices

Electrical Sector
Mexico Operations
Carr. Tlalnepantla -
Cuautitlan Km 17.8 s/n
Col. Villa Jardin esq.
Cerrada 8 de Mayo
Cuautitlan, Mexico CP 54800
Mexico
Eaton.mx
Eaton.com/wiringdevices

Arrow Hart heavy-duty straight blade decorator receptacles

Project Name:	Prepared By:
Project Number:	Date:
Catalog Number:	Type:

Description

2-Pole, 3-Wire Grounding
 15A 125V/AC;
 20A 125V/AC
 NEMA 5-15, 5-20

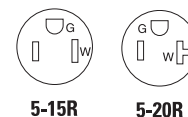

6352



TR6352

Design features

- Tamper resistant receptacles provide compliance with NEC® Article 406.11 that states that all receptacles installed in dwelling units must be tamper resistant
- Black tamper resistant shutters on TR models create a seamless look, while ensuring code compliance and preventing the insertion of foreign objects
- Durable impact and chemical resistant nylon face is virtually unbreakable (excluding 6252 and 6352)
- Terminal screws are backed out and ready to wire
- Extra-long and extra-wide mounting straps
- Terminals accept up to #10 solid or stranded wire

Table 1. Heavy-duty decorator receptacles



Rating		NEMA	Description	Color suffix	Catalog no.	
A	V/AC					
15	125	5-15R	Duplex receptacle, back & side wire	B, BK, GY, LA, V, W	□ 6252__	•
			Single receptacle, back & side wire	V, W	□ 6250__*	•
20	125	5-20R	Duplex receptacle, back & side wire	B, BK, GY, LA, V, W	□ 6352__	•
			Single receptacle, back & side wire	B, V, W	□ 6350__*	•

* UL Listed & CSA certified

Table 2. Tamper resistant heavy-duty decorator receptacles



Rating		NEMA	Description	Color suffix	Catalog no.	
A	V/AC					
15	125	5-15R	Decorator duplex receptacle, back & side wire	GY, LA, V, W	□ TR6252__	•
			Decorator single receptacle, back & side wire	B, BK, V, W	□ TR6250__	•
20	125	5-20R	Decorator duplex receptacle, back & side wire	B, BK, GY, LA, V, W	□ TR6352__	•
			Decorator single receptacle, back & side wire	LA, V, W	□ TR6350__*	

* Not Fed Spec



Powering Business Worldwide

Compliances, specifications and availability are subject to change without notice.

Project Name:	Prepared By:
Project Number:	Date:
Catalog Number:	Type:

Applications

Heavy-duty grade duplex receptacles are challenged on a daily basis to provide a consistent, reliable means of connectivity in a wide variety of environments. The applications vary greatly by environment, and provide challenges from impact and chemical resistance to environmental extremes such as heat and moisture. The breadth of the Arrow Hart heavy-duty straight blade receptacle line provides solutions for all environments and applications.

Table 3. Specifications

Catalog No.	6252, 6250, 6352, 6350 Series	TR6250, TR6252, TR6350, TR6352 Series
Device type	Decorator heavy-duty grade receptacles	Tamper resistant decorator heavy-duty grade receptacles
Wiring type	Back & side wire	Back & side wire
Testing & code compliance	<ul style="list-style-type: none"> • cULus • NOM • UL listed (6250 & 6350) • CSA (6250 & 6350) • Complies with NEMA WD-1 & NEMA WD-6 	<ul style="list-style-type: none"> • cULus • NOM • Fed spec (except TR6350) • Complies with NEMA WD-1 & NEMA WD-6
Environmental specifications	Flammability: meets ul 94 requirements; v2 rated Temperature rating: -20°C to 70°C (-4°F to 158°F)	Flammability: meets ul 94 requirements; v2 rated Temperature rating: -20°C to 70°C (-4°F to 158°F)
Electrical specifications	Dielectric voltage: withstands 2000v per ul 498 Current interrupting: yes, at full-rated current Temperature rise: max. 30°C (86°F) after 250 cycles of overload @ 200% of rated current (dc).	Dielectric voltage: withstands 2000v per ul 498 Current interrupting: yes, at full-rated current Temperature rise: standard - max. 30°C (86°F) after 100 cycles of overload @ 150% of rated current (dc). Fed. Spec. - Max. 30°C (86°F) after 250 cycles of overload @ 200% of rated current (dc)
Mechanical specifications	Terminal accommodation: #14 - 10 awg Voltage ratings: permanently marked on device	Terminal accommodation: #14 - 10 awg Voltage ratings: permanently marked on device

Table 4. Materials

Catalog No.	6250, 6350 Series	6252, 6352 Series	TR6250, TR6252, TR6350, TR6352 Series
Face	Nylon	Nylon	Nylon
Base	Nylon	PVC	Nylon
Strap	0.050" thick galvanized steel	0.046" thick galvanized steel	0.050" thick galvanized steel
Auto ground	Phosphor bronze staple	Phosphor bronze staple	Phosphor bronze staple
Line contacts	0.037" thick 3-leaf brass	0.030" thick 3-leaf brass	0.030" thick 3-leaf brass
Ground contact	Riveted	Riveted	Riveted
Terminal screws	#8-32 Steel, brass plated hot, neutral screw nickel plated	#8-32 Steel, brass plated hot, neutral screw nickel plated	#8-32 Steel, brass plated hot, neutral screw nickel plated
Ground screw	#8-32 Steel (green)	#8-32 Steel (green)	#8-32 steel (green)
Tamper resistant shutters	N/A	N/A	Reliable Delrin® shutter assembly

Table 5. Color ordering information

For ordering devices, include Cat. No. followed by the color code: B (Brown), BK (Black), GY (Gray) LA (Light Almond), V (Ivory), W (White)

B	BK	GY	LA	V	W
Brown	Black	Gray	Lt. Almond	Ivory	White

Project Name:	Prepared By:
Project Number:	Date:
Catalog Number:	Type:

Product dimensions

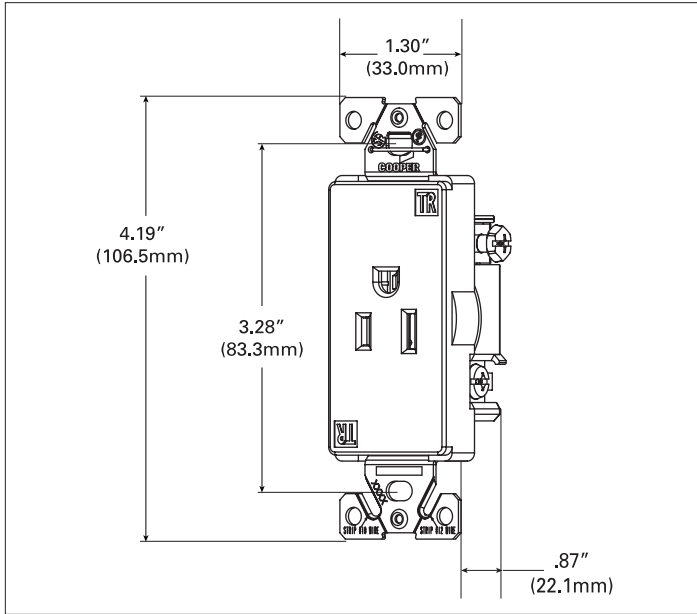

Figure 1. TR6250 Line art with dimensions

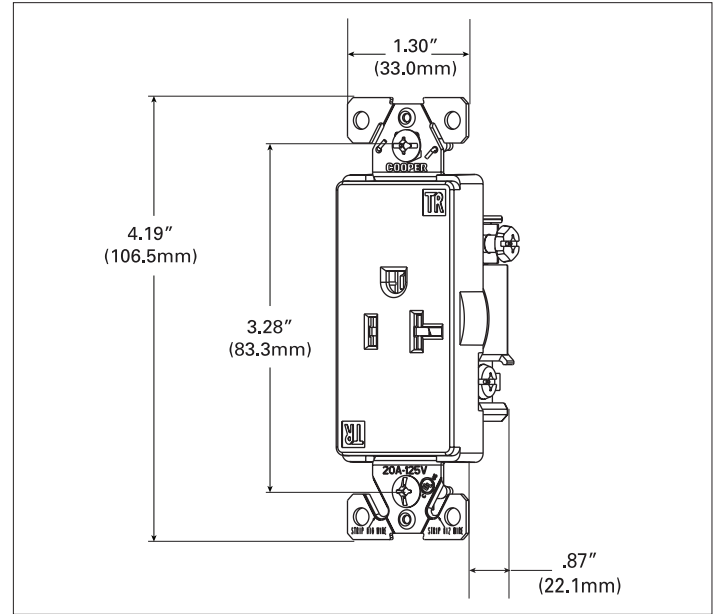

Figure 2. TR6350 Line art with dimensions

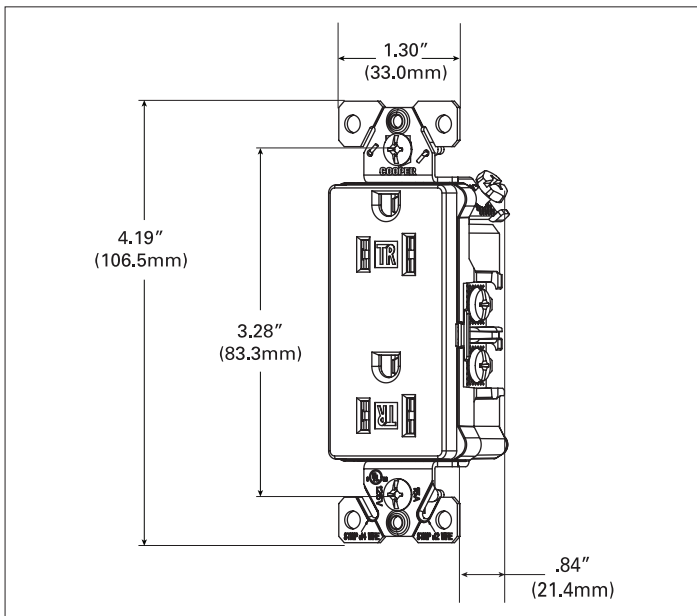

Figure 3. TR6252 Line art with dimensions

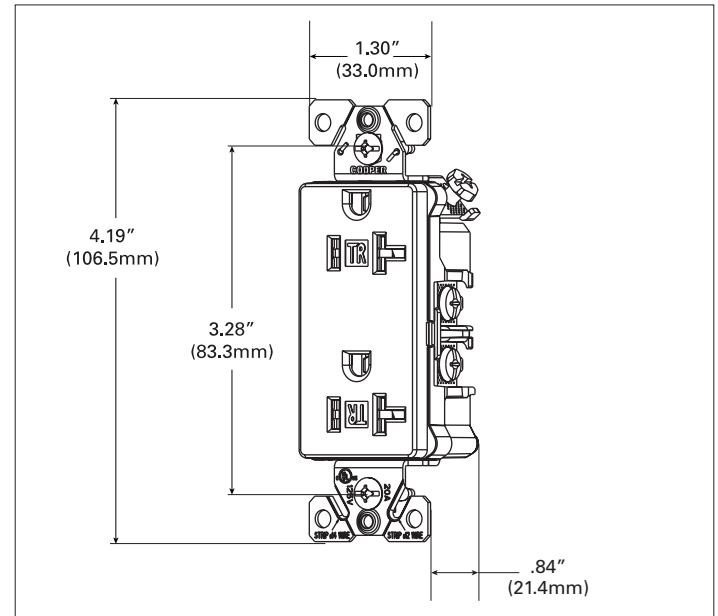









Figure 4. TR6352 Line art with dimensions

Project Name:	Prepared By:
Project Number:	Date:
Catalog Number:	Type:

Certifications & compliances

Catalog No.							
6252	•			•	•	•	
6250		•		•	•	•	
6352	•			•	•	•	
6350		•		•	•		
TR6250	•			•		•	
TR6252	•		•			•	•
TR6350	•					•	
TR6352	•		•			•	•

KEY:  cULus  UL  Fed Spec  Indicates USMCA compliant
 CSA  NOM  Arrowlink

Compliances, specifications and availability are subject to change without notice.

Electrical Sector
203 Cooper Circle
Peachtree City, GA 30269
United States
Eaton.com
Eaton.com/wiringdevices

Electrical Sector
Canada Operations
5925 McLaughlin Road
Mississauga, Ontario, L5R 1B8
Canada
EatonCanada.ca
Eaton.com/wiringdevices

Electrical Sector
Mexico Operations
Carr. Tlalhepantla -
Cuautitlan Km 17.8 s/n
Col. Villa Jardin esq.
Cerrada 8 de Mayo
Cuautitlan, Mexico CP 54800
Mexico
Eaton.mx
Eaton.com/wiringdevices