

Contents

| | |
|--|------------|
| CABLE STAPLES | 2 |
| ROUND CABLE STAPLES | 7 |
| STAINLESS STEEL CABLE STAPLES | 9 |
| STAINLESS STEEL STRAPS | 11A |
| PLASTIC STAPLES | 12 |
| COAXIAL STAPLES | 12 |
| LOW VOLTAGE INSULATED STAPLES | 13 |
| LOW VOLTAGE PLASTIC STAPLES | 13 |
| SERVICE ENTRANCE KITS | 14 |
| DRIVE STRAPS | 15 |
| PLASTIC CONDUIT STRAPS | 15 |
| THIN WALL CONDUIT STRAPS | 16 |
| FOLD OVER STRAPS | 16 |
| SERVICE ENTRANCE CABLE STRAPS | 17 |
| SERVICE ENTRANCE ROUND CABLE STRAPS | 17 |
| MIDGET STRAPS | 18 |
| NON-WATERTIGHT CONNECTORS | 19 |
| WATERTIGHT CONNECTORS | 19 |
| CABLE CONNECTORS | 20 |
| WEATHER CAPS | 22 |
| SILL PLATES | 23 |
| FISH WIRE | 23 |
| BOX SUPPORTS | 24 |
| STUD SAFETY PLATES | 24 |
| WIRE CONNECTORS | 25 |
| CLAMSHELLS | 26 |
| STAINLESS STEEL CLAMSHELLS | 27 |

CABLE STAPLES

All Staple Sizes Are Inside Dimensions

SN 40

1/2" Wide, 1" Long, Low Carbon Steel

Armored Cable 14/2 And 14/3

Metal Clad 14/2 And 14/3

Non-metallic Sheathed 14/2 Through 10/3

Underground Feeder 14/2 And 12/2

| CATALOG NUMBER | UPC # 780227 | UNIT QUANTITY | MASTER CARTON | MASTER WEIGHT |
|----------------|-----------------|---------------|---------------|---------------|
| SN 40 500 | 72403 | 500 | 10000 | 45 |
| SN 40 5M | 72405 | 5000 | BUCKET | 23 |
| SN 40 J 1500 | 72404 | 1500 JAR | 9000 | 41 |
| SN 40 10M | 72407 | 10000 | BUCKET | 45 |
| SN 40 15M | 72409 | 15000 | BUCKET | 63 |



SN 40 B

1/2" Wide, 1" Long, Zinc Plated Low Carbon Steel



Armored Cable 14/2 And 14/3

Metal Clad 14/2 And 14/3

Non-metallic Sheathed 14/2 Through 10/3

Underground Feeder 14/2 And 12/2

| CATALOG NUMBER | UPC # 780227 | UNIT QUANTITY | MASTER CARTON | MASTER WEIGHT |
|----------------|-----------------|---------------|---------------|---------------|
| SN 40 B 100 | 71966 | 100 | 10000 | 45 |
| SN 40 B 500 | 71968 | 500 | 10000 | 45 |
| SN 40 BJ 1500 | 71969 | 1500 JAR | 9000 | 41 |
| SN 40 B 5M | 71970 | 5000 | BUCKET | 23 |
| SN 40 B 10M | 71975 | 10000 | BUCKET | 45 |
| SN 40 B 15M | 71977 | 15000 | BUCKET | 63 |



SN 40 IB

1/2" Wide, 1" Long, Zinc Plated Low Carbon Steel, LDPE Blue Plastic Insulator



Armored Cable 14/2 And 14/3

Metal Clad 14/2 And 14/3

Non-metallic Sheathed 14/2 Through 10/3

Underground Feeder 14/2 And 12/2

| CATALOG NUMBER | UPC # 780227 | UNIT QUANTITY | MASTER CARTON | MASTER WEIGHT |
|----------------|-----------------|---------------|---------------|---------------|
| SN 40 IB 100 | 71981 | 100 | 5000 | 27 |
| SN 40 IB 500 | 71984 | 500 | 5000 | 27 |
| SN 40 IBJ 500 | 71983 | 500 JAR | 5000 | 27 |
| SN 40 IB 2500 | 71980 | 2500 | BUCKET | 13 |
| SN 40 IB 5M | 71985 | 5000 | BUCKET | 26 |



SN 100

9/16" Wide, 1-1/4" Long, Low Carbon Steel

Armored Cable 14/2 Through 10/3

Metal Clad 14/2 Through 10/3

Non-metallic Sheathed 12/3 Through 10/3

Underground Feeder 14/3 And 12/3

| CATALOG NUMBER | UPC # 780227 | UNIT QUANTITY | MASTER CARTON | MASTER WEIGHT |
|----------------|-----------------|---------------|---------------|---------------|
| SN 100 500 | 72993 | 500 | 5000 | 37 |
| SN 100 J 1M | 72983 | 1000 JAR | 6000 | 42 |
| SN 100 5M | 72985 | 5000 | BUCKET | 35 |
| SN 100 10M | 72997 | 10000 | BUCKET | 70 |



SN 100 B

9/16" Wide, 1-1/4" Long, Zinc Plated Low Carbon Steel



Armored Cable 14/2 Through 10/3

Metal Clad 14/2 Through 10/3

Non-metallic Sheathed 12/3 Through 10/3

Underground Feeder 14/3 And 12/3

| CATALOG NUMBER | UPC # 780227 | UNIT QUANTITY | MASTER CARTON | MASTER WEIGHT |
|----------------|-----------------|---------------|---------------|---------------|
| SN 100 B 100 | 71986 | 100 | 5000 | 37 |
| SN 100 B 500 | 71995 | 500 | 5000 | 37 |
| SN 100 BJ 1M | 71987 | 1000 JAR | 6000 | 44 |
| SN 100 B 4M | 71990 | 4000 | BUCKET | 30 |



SN 100 IB

9/16" Wide, 1-1/4" Long, Zinc Plated Low Carbon Steel, LDPE Yellow Plastic Insulator

Armored Cable 14/2 Through 10/3
 Non-metallic Sheathed 14/2 Through 10/3
 Non-metallic Sheathed 14/3 Parallel (Flat)

Metal Clad 14/2 Through 10/3
 Underground Feeder 14/2 Through 12/3

| CATALOG NUMBER | UPC # | UNIT QUANTITY | MASTER CARTON | MASTER WEIGHT |
|----------------|-------|---------------|---------------|---------------|
| SN 100 IB 100 | 72610 | 100 | 2000 | 18 |
| SN 100 IB 250 | 72613 | 250 | 2500 | 22 |
| SN 100 IB 3M | 72615 | 3000 | BUCKET | 27 |



SN 150 B

1/2" Wide, 1-1/2" Long, Zinc Plated Low Carbon Steel,
 Extra Long For Securing Up To Two Cables



One Cable

Non-metallic Sheathed 14/2 Through 10/3
 Underground Feeder 14/2 And 12/2

Two Cables

Non-metallic Sheathed 14/2 Through 12/3
 Underground Feeder 14/2 And 12/2

| CATALOG NUMBER | UPC # | UNIT QUANTITY | MASTER CARTON | MASTER WEIGHT |
|----------------|-------|---------------|---------------|---------------|
| SN 150 B 100 | 75025 | 100 | 5000 | 44 |
| SN 150 B 500 | 75030 | 500 | 5000 | 44 |
| SN 150 B 2500 | 75035 | 2500 | BUCKET | 22 |



SN 150 IB

1/2" Wide, 1-1/2" Long, Zinc Plated Low Carbon Steel,
 LDPE Red Plastic Insulator, Extra Long For Securing Up To Two Cables



One Cable

Non-metallic Sheathed 14/2 Through 10/3
 Underground Feeder 14/2 And 12/2

Two Cables

Non-metallic Sheathed 14/2 Through 12/3
 Underground Feeder 14/2 And 12/2

| CATALOG NUMBER | UPC # | UNIT QUANTITY | MASTER CARTON | MASTER WEIGHT |
|----------------|-------|---------------|---------------|---------------|
| SN 150 IB 100 | 75027 | 100 | 5000 | 51 |
| SN 150 IB 250 | 75028 | 250 | 2500 | 25 |
| SN 150 IB 3M | 75026 | 3000 | BUCKET | 29 |



SN 300 B

13/16" Wide, 1-3/8" Long, Zinc Plated Low Carbon Steel



Armored Cable 8/3 Metal Clad 8/3 SE Cable 8/2 Through 6/3
 Non-metallic Sheathed 8/3 Through 6/3 Underground Feeder 10/3

| CATALOG NUMBER | UPC # | UNIT QUANTITY | MASTER CARTON | MASTER WEIGHT |
|----------------|-------|---------------|---------------|---------------|
| SN 300 B 100 | 73302 | 100 | 5000 | 65 |



SN 300 IB

13/16" Wide, 1-3/8" Long, Zinc Plated Low Carbon Steel, LDPE Grey Plastic Insulator



Armored Cable 8/3 Metal Clad 8/3 SE Cable 8/2 Through 6/3
 Non-metallic Sheathed 8/3 Through 6/3 Underground Feeder 10/3

| CATALOG NUMBER | UPC # | UNIT QUANTITY | MASTER CARTON | MASTER WEIGHT |
|----------------|-------|---------------|---------------|---------------|
| SN 300 IB 100 | 73305 | 100 | 1000 | 16 |
| SN 300 IBJ 175 | 75312 | 175 | 1750 | 29 |



SN 350 B

1-1/16" Wide, 1-7/16" Long, Zinc Plated Low Carbon Steel



SE Cable 4/3 SEU Through 2/3 SER

| CATALOG NUMBER | UPC # | UNIT QUANTITY | MASTER CARTON | MASTER WEIGHT |
|----------------|-------|---------------|---------------|---------------|
| SN 350 B 100 | 73350 | 100 | 2000 | 30 |



SN 350 IB

1-1/16" Wide, 1-7/16" Long, Zinc Plated Low Carbon Steel, LDPE Grey Plastic Insulator

SE Cable 4/3 SEU Through 2/3 SER

| CATALOG NUMBER | UPC # | UNIT QUANTITY | MASTER CARTON | MASTER WEIGHT |
|----------------|-------|---------------|---------------|---------------|
| SN 350 IB 50 | 73356 | 50 | 1000 | 18 |



#1 IN FASTENING THE POWER

SN 400 B

1-11/32" Wide, 1-7/8" Long, Zinc Plated Low Carbon Steel



SE Cable 3 No. 2/0 SEU SE Cable 3 No. 2/0 SER

| CATALOG NUMBER | UPC # | UNIT QUANTITY | MASTER CARTON | MASTER WEIGHT |
|----------------|-------|---------------|---------------|---------------|
| SN 400 B 100 | 73400 | 100 | 1000 | 32 |



SN 450 B

1-3/16" Wide, 2-1/4" Long, Zinc Plated Low Carbon Steel



Armored Cable 2/3 SE Cable 3 No. 1/0 SER Underground Feeder 6/3

| CATALOG NUMBER | UPC # | UNIT QUANTITY | MASTER CARTON | MASTER WEIGHT |
|----------------|-------|---------------|---------------|---------------|
| SN 450 B 100 | 73450 | 100 | 1000 | 35 |



SN 500 B

1-5/8" Wide, 2-1/8" Long, Zinc Plated Low Carbon Steel



SE Cable 3 No. 4/0 SEU SE Cable 3 No. 4/0 SER

| CATALOG NUMBER | UPC # | UNIT QUANTITY | MASTER CARTON | MASTER WEIGHT |
|----------------|-------|---------------|---------------|---------------|
| SN 500 B 100 | 73500 | 100 | 1000 | 37 |



ROUND CABLE STAPLES

SN 600

1-1/16" Wide, 2-1/16" Long, Zinc Plated Low Carbon Steel

4/3 SER Cable 2/3 SER Cable 3/4" EMT 1/2" Greenfield

| CATALOG NUMBER | UPC # | UNIT QUANTITY | MASTER CARTON | MASTER WEIGHT |
|----------------|-------|---------------|---------------|---------------|
| SN 600 100 | 74600 | 100 | 1000 | 29 |



SN 700

1-11/32" Wide, 2-11/32" Long, Zinc Plated Low Carbon Steel

2/0 SER Cable 1" EMT 1" Greenfield

| CATALOG NUMBER | UPC # | UNIT QUANTITY | MASTER CARTON | MASTER WEIGHT |
|----------------|-------|---------------|---------------|---------------|
| SN 700 100 | 74700 | 100 | 1000 | 35 |



SN 800

1-3/16" Wide, 2-3/16" Long, Zinc Plated Low Carbon Steel

2/3 BX 1" EMT 1" Greenfield 2/3 SER Cable

| CATALOG NUMBER | UPC # | UNIT QUANTITY | MASTER CARTON | MASTER WEIGHT |
|----------------|-------|---------------|---------------|---------------|
| SN 800 100 | 74800 | 100 | 1000 | 38 |



SN 900

1-5/8" Wide, 2-5/8" Long, Zinc Plated Low Carbon Steel

4/0 SER Cable 1" And 1-1/4" EMT Large BX And NM Greenfield

| CATALOG NUMBER | UPC # | UNIT QUANTITY | MASTER CARTON | MASTER WEIGHT |
|----------------|-------|---------------|---------------|---------------|
| SN 900 100 | 74900 | 100 | 1000 | 40 |



SN 1000

1-1/4" Wide, 2-3/4" Long, Zinc Plated Low Carbon Steel
Heavy Duty; Ideal For Wood Reels And Multiple Wiring

Large Metal Clad And Non-metallic Cable Greenfield

| CATALOG NUMBER | UPC # | UNIT QUANTITY | MASTER CARTON | MASTER WEIGHT |
|----------------|-------|---------------|---------------|---------------|
| SN 1000 20 | 75000 | 20 | 400 | 32 |



STAINLESS STEEL CABLE STAPLES

For Use On Pressure Treated Lumber And Exterior Applications

SN 40 B SS

1/2" Wide, 1" Long, Stainless Steel



Armored Cable 14/2 And 14/3 Metal Clad 14/2 And 14/3
 Non-metallic Sheathed 14/2 Through 10/3 Underground Feeder 14/2 And 12/2

| CATALOG NUMBER | UPC # | UNIT QUANTITY | MASTER CARTON | MASTER WEIGHT |
|----------------|-------|---------------|---------------|---------------|
| SN 40 B SS 100 | 10035 | 100 | 10000 | 45 |



SN 40 IB SS

1/2" Wide, 1" Long, Stainless Steel, LDPE Blue Plastic Insulator



Armored Cable 14/2 And 14/3 Metal Clad 14/2 And 14/3
 Non-metallic Sheathed 14/2 Through 10/3 Underground Feeder 14/2 And 12/2

| CATALOG NUMBER | UPC # | UNIT QUANTITY | MASTER CARTON | MASTER WEIGHT |
|-----------------|-------|---------------|---------------|---------------|
| SN 40 IB SS 100 | 10030 | 100 | 5000 | 27 |



SN 100 B SS

9/16" Wide, 1-1/4" Long, Stainless Steel



Armored Cable 14/2 Through 10/3 Metal Clad 14/2 Through 10/3
 Non-metallic Sheathed 12/3 Through 10/3 Underground Feeder 14/3 And 12/3

| CATALOG NUMBER | UPC # | UNIT QUANTITY | MASTER CARTON | MASTER WEIGHT |
|-----------------|-------|---------------|---------------|---------------|
| SN 100 B SS 100 | 71997 | 100 | 5000 | 37 |



SN 100 IB SS

9/16" Wide, 1-1/4" Long, Stainless Steel, LDPE Yellow Plastic Insulator

Armored Cable 14/2 Through 10/3 Metal Clad 14/2 Through 10/3
 Non-metallic Sheathed 14/2 Through 10/3 Underground Feeder 14/2 Through 12/3
 Non-metallic Sheathed 14/3 Parallel (Flat)

| CATALOG NUMBER | UPC # | UNIT QUANTITY | MASTER CARTON | MASTER WEIGHT |
|------------------|-------|---------------|---------------|---------------|
| SN 100 IB SS 100 | 72617 | 100 | 2000 | 18 |



SN 150 B SS

1/2" Wide, 1-1/2" Long, Stainless Steel
 Extra Long For Securing Up To Two Cables

One Cable Two Cables
 Non-metallic Sheathed 14/2 Through 10/3 Non-metallic Sheathed 14/2 Through 12/3
 Underground Feeder 14/2 And 12/2 Underground Feeder 14/2 And 12/2

| CATALOG NUMBER | UPC # | UNIT QUANTITY | MASTER CARTON | MASTER WEIGHT |
|-----------------|-------|---------------|---------------|---------------|
| SN 150 B SS 100 | 75041 | 100 | 5000 | 44 |



SN 150 IB SS

1/2" Wide, 1-1/2" Long, Stainless Steel, LDPE Red Plastic Insulator
 Extra Long For Securing Up To Two Cables

One Cable Two Cables
 Non-metallic Sheathed 14/2 Through 10/3 Non-metallic Sheathed 14/2 Through 12/3
 Underground Feeder 14/2 And 12/2 Underground Feeder 14/2 And 12/2

| CATALOG NUMBER | UPC # | UNIT QUANTITY | MASTER CARTON | MASTER WEIGHT |
|------------------|-------|---------------|---------------|---------------|
| SN 150 IB SS 100 | 75031 | 100 | 5000 | 51 |



SN 300 B SS

13/16" Wide, 1-3/8" Long, Stainless Steel



Armored Cable 8/3 Metal Clad 8/3 SE Cable 8/2 Through 6/3
 Non-metallic Sheathed 8/3 Through 6/3 Underground Feeder 10/3

| CATALOG NUMBER | UPC # | UNIT QUANTITY | MASTER CARTON | MASTER WEIGHT |
|-----------------|-------|---------------|---------------|---------------|
| SN 300 B SS 100 | 73303 | 100 | 5000 | 65 |



SN 300 IB SS

13/16" Wide, 1-3/8" Long, Stainless Steel
 LDPE Grey Plastic Insulator



Armored Cable 8/3 Metal Clad 8/3 SE Cable 8/2 Through 6/3
 Non-metallic Sheathed 8/3 Through 6/3 Underground Feeder 10/3

| CATALOG NUMBER | UPC # | UNIT QUANTITY | MASTER CARTON | MASTER WEIGHT |
|------------------|-------|---------------|---------------|---------------|
| SN 300 IB SS 100 | 73308 | 100 | 1000 | 16 |



SN 350 B SS

1-1/16" Wide, 1-7/16" Long, Stainless Steel



SE Cable 4/3 SEU Through 2/3 SER

| CATALOG NUMBER | UPC # | UNIT QUANTITY | MASTER CARTON | MASTER WEIGHT |
|-----------------|-------|---------------|---------------|---------------|
| SN 350 B SS 100 | 73353 | 100 | 2000 | 30 |



SN 350 IB SS

1-1/16" Wide, 1-7/16" Long, Stainless Steel
 LDPE Grey Plastic Insulator

SE Cable 4/3 SEU Through 2/3 SER

| CATALOG NUMBER | UPC # | UNIT QUANTITY | MASTER CARTON | MASTER WEIGHT |
|-----------------|-------|---------------|---------------|---------------|
| SN 350 IB SS 50 | 73354 | 50 | 1000 | 18 |





STAINLESS STEEL MIDGET STRAPS

1-Hole Strap

| CATALOG NUMBER | UPC # | CABLE SIZE | A | B | C | UNIT QTY | MASTER CARTON | MASTER WEIGHT |
|----------------|-------|----------------------------------|------|------|-------|----------|---------------|---------------|
| M 25 SS 100 | 69127 | 1/4" TUBING, #6 & #4 GROUND WIRE | 3/8" | 1/4" | 3/16" | 100 | 2000 | 18 |
| M 30 SS 100 | 69126 | 14/2 TO 12/2 UF & NM SHEATHED | 1/2" | 1/4" | 3/16" | 100 | 2000 | 23 |
| M 50 SS 100 | 69128 | 14/2 TO 10/3 MC | 5/8" | 1/2" | 3/16" | 100 | 2000 | 31 |

A = INSIDE WIDTH
 B = INSIDE HEIGHT
 C = HOLE DIAMETER

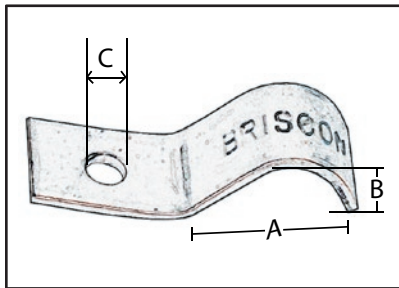



PLASTIC SADDLES

Plastic Saddles, Zinc Plated Nails Resist Rust And Corrosion

| CATALOG NUMBER | UPC # 780227 | CABLE SIZE | SADDLE COLOR | A | B | C | UNIT QTY | MASTER CARTON | MASTER WEIGHT |
|----------------|-----------------|----------------------------------|--------------|--------|--------|--------|----------|---------------|---------------|
| PS 50 100 | 72512 | 14/2 THROUGH 12/3 NM SHEATHED | WHITE | 1/2" | 3/16" | 1-1/4" | 100 | 2000 | 11 |
| PS 75 100 | 72517 | 14/2 THROUGH 10/3 NM SHEATHED | WHITE | 3/4" | 3/16" | 1-1/4" | 100 | 2000 | 11 |
| PS 300 100 | 41735 | 6/3 SEU | GREY | 3/4" | 3/8" | 1-3/4" | 100 | 1000 | 14 |
| PS 300 R 100 | 41740 | 6/3 SER | GREY | 3/4" | 3/4" | 1-3/4" | 100 | 1000 | 15 |
| PS 350 50 | 41745 | 2/3 SEU | GREY | 1" | 1/2" | 1-3/4" | 50 | 500 | 8 |
| PS 350 R 50 | 41750 | 2/3 SER | GREY | 1" | 1" | 2" | 50 | 500 | 12 |
| PS 400 R 50 | 41753 | 2/0 SER | GREY | 1-1/4" | 1-1/4" | 2-1/2" | 50 | 500 | 15 |
| PS 500 50 | 41755 | 4/0 SEU | GREY | 1-1/2" | 1" | 2" | 50 | 500 | 12 |
| PS 500 R 25 | 41760 | 4/0 SER | GREY | 1-1/2" | 1-1/2" | 2" | 25 | 250 | 9 |

A = INSIDE WIDTH
B = INSIDE HEIGHT
C = NAIL LENGTH

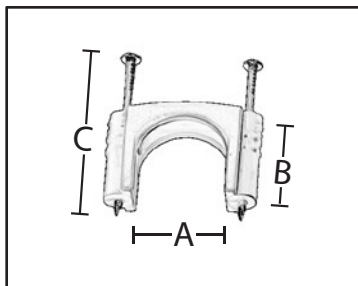

COAXIAL STAPLES

Use With RG-59, RG-6, Category 5 And Other Cables Up to 1/4"
Zinc Plated Nail And Staple Resist Rust And Corrosion

| CATALOG NUMBER | UPC# 780227 | DESCRIPTION WIDTH x LENGTH | UNIT QUANTITY | MASTER CARTON | MASTER WEIGHT |
|----------------|----------------|-------------------------------|------------------|------------------|------------------|
| CX 90 100 | 75050 | 1/2" x 1" STAPLE | 100 | 5000 | 34 |
| CX 90 J 500 | 75056 | 1/2" x 1" STAPLE | 500 JAR | 5000 | 34 |
| PS 90 B 100 | 72522 | 1/4" x 1" 1-NAIL BLACK | 100 | 10000 | 26 |
| PS 90 BJ 500 | 72524 | 1/4" x 1" 1-NAIL BLACK | 500 JAR | 5000 | 13 |
| PS 90 W 100 | 72523 | 1/4" x 1" 1-NAIL WHITE | 100 | 10000 | 26 |
| PS 90 WJ 500 | 72525 | 1/4" x 1" 1-NAIL WHITE | 500 JAR | 5000 | 13 |



LOW VOLTAGE INSULATED STAPLES

Low Voltage Staples For Use With Bell, Speaker, Thermostat And Telephone Wire
All Sizes: Standard Package 1000 Staples; Approximate Weight 2 Pounds/1000

| CATALOG NUMBER | UPC # 780227 | UNIT QUANTITY | SIZE | DIMENSIONS WIDTH x LENGTH | FINISH |
|----------------|-----------------|---------------|------|------------------------------|----------|
| #1 COPPER 100 | 71137 | 100 | # 1 | 3/16" x 1/2" | COPPERED |
| #3 COPPER 100 | 71337 | 100 | # 3 | 3/16" x 3/4" | COPPERED |
| #5 BROWN 40 | 71512 | 40 | # 5 | 1/4" x 5/8" | BROWN |
| #5 COPPER 100 | 71537 | 100 | # 5 | 1/4" x 5/8" | COPPERED |
| #5 WHITE 40 | 71516 | 40 | # 5 | 1/4" x 5/8" | WHITE |
| #6 COPPER 100 | 71637 | 100 | # 6 | 1/4" x 3/4" | COPPERED |
| #7 COPPER 100 | 71737 | 100 | # 7 | 1/4" x 7/8" | COPPERED |

LOW VOLTAGE PLASTIC STAPLES

Low Voltage Staples For Use With Bell, Speaker, Thermostat And Telephone Wire
Zinc Plated Nail Resists Rust And Corrosion



| CATALOG NUMBER | UPC # 780227 | DESCRIPTION WIDTH x LENGTH | UNIT QUANTITY | MASTER CARTON | MASTER WEIGHT |
|----------------|-----------------|-------------------------------|---------------|---------------|---------------|
| PS 80 W 100 | 72541 | 3/16" x 1" 1-NAIL WHITE | 100 | 10000 | 26 |
| PS 80 B 100 | 72531 | 3/16" x 1" 1-NAIL BLACK | 100 | 10000 | 26 |

SERVICE ENTRANCE KITS

Conveniently Packed For Fast Counter Service
Die Cast Or Plastic Weather Cap

SE 1 100 AMP

For 2/3 SEU Cable

CATALOG NUMBER: SE 1
UPC# 78022743950
MASTER CARTON: 10 KITS
MASTER WEIGHT: 13 lbs.

KIT CONTAINS:

- 1 #100 PLASTIC WEATHER CAP
- 10 4S2A CABLE STRAPS
- 1 WC 1252 1-1/4" WT CONNECTOR
- 2 125 SM 1-1/4" CONNECTORS
- 1 SP 28 SILL PLATE



SE 2 200 AMP

For 4/0 SEU Cable

CATALOG NUMBER: SE 2
UPC# 78022743960
MASTER CARTON: 10 KITS
MASTER WEIGHT: 35 lbs.

KIT CONTAINS:

- 1 #200 PLASTIC WEATHER CAP
- 10 4S0 2 CABLE STRAPS
- 1 WC 2004 2" WT CONNECTOR
- 2 200 SM 2" CONNECTORS
- 1 SP 40 SILL PLATE

SE 1 D 100 AMP

For 2/3 SEU Cable

CATALOG NUMBER: SE 1 D
UPC# 78022743955
MASTER CARTON: 10 KITS
MASTER WEIGHT: 13 lbs.

KIT CONTAINS:

- 1 DC 100 DIE CAST WEATHER CAP
- 10 4S2A CABLE STRAPS
- 1 WC 1252 1-1/4" WT CONNECTOR
- 2 125 SM 1-1/4" CONNECTORS
- 1 SP 28 SILL PLATE

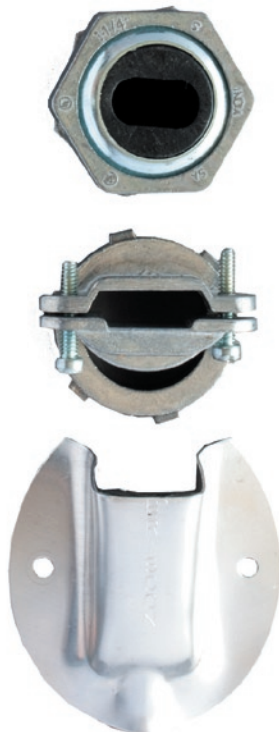

SE 2 D 200 AMP

For 4/0 SEU Cable

CATALOG NUMBER: SE 2 D
UPC# 78022743965
MASTER CARTON: 10 KITS
MASTER WEIGHT: 35 lbs.

KIT CONTAINS:

- 1 DC 200 DIE CAST WEATHER CAP
- 10 4S0 2 CABLE STRAPS
- 1 WC 2004 2" WT CONNECTOR
- 2 200 SM 2" CONNECTORS
- 1 SP 40 SILL PLATE

SE 1

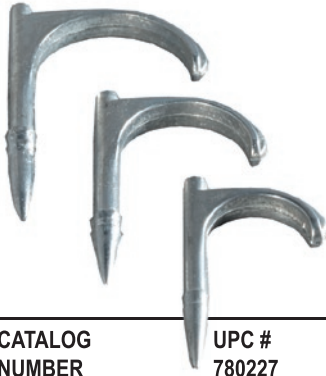

DRIVE STRAPS

Pressure Cast Zinc Drive Strap

| CATALOG NUMBER | UPC # 780227 | EMT SIZE | RIGID SIZE | A | B | C | UNIT QUANTITY | MASTER CARTON | MASTER WEIGHT |
|----------------|-----------------|----------|------------|--------|------|--------|---------------|---------------|---------------|
| T5 100 | 35801 | 1/2" | 3/8" | 3/4" | 3/8" | 1-3/4" | 100 | 2000 | 35 |
| T7 100 | 35802 | 3/4" | 1/2" | 1" | 1/2" | 2" | 100 | 2000 | 44 |
| T10 100 | 35803 | 1" | 3/4" | 1-1/4" | 5/8" | 2-1/2" | 100 | 1000 | 30 |

A = INSIDE WIDTH
B = INSIDE HEIGHT
C = NAIL LENGTH

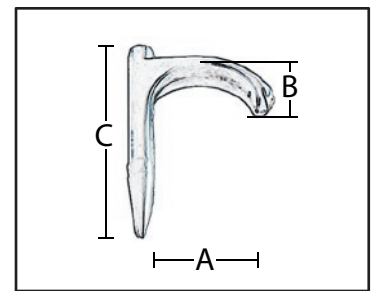

PLASTIC CONDUIT STRAPS

Grey Plastic 2-Hole Strap

| CATALOG NUMBER | UPC # 780227 | SIZE | A | B | C | UNIT QUANTITY | MASTER CARTON | MASTER WEIGHT |
|----------------|-----------------|--------|---------|---------|------|---------------|---------------|---------------|
| PS 5 50 | 41700 | 1/2" | 7/8" | 7/8" | 1/4" | 50 | 500 | 5 |
| PS 7 50 | 41710 | 3/4" | 1" | 1" | 1/4" | 50 | 500 | 6 |
| PS 10 50 | 41715 | 1" | 1-3/16" | 1-3/16" | 1/4" | 50 | 500 | 8 |
| PS 12 25 | 41720 | 1-1/4" | 1-5/8" | 1-5/8" | 1/4" | 25 | 250 | 5 |
| PS 15 25 | 41725 | 1-1/2" | 1-7/8" | 1-7/8" | 1/4" | 25 | 250 | 7 |
| PS 20 10 | 41730 | 2" | 2-3/8" | 2-3/8" | 1/4" | 10 | 100 | 5 |
| PS 25 5 | 41731 | 2-1/2" | 3" | 3" | 3/8" | 5 | 50 | 5 |
| PS 30 | 41732 | 3" | 3-1/2" | 3-1/2" | 3/8" | 1 | 25 | 3 |
| PS 40 | 41734 | 4" | 4-1/2" | 4-1/2" | 3/8" | 1 | 25 | 3 |

A = INSIDE WIDTH
B = INSIDE HEIGHT
C = HOLE DIAMETER

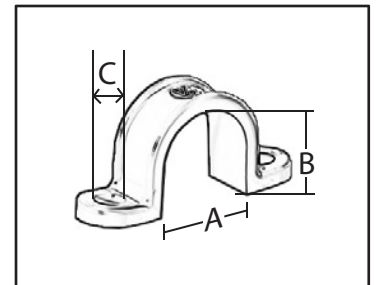

#1 IN FASTENING THE POWER



THIN WALL CONDUIT STRAPS

Galvanized Steel 1-Hole EMT Strap, Snap On Type

| CATALOG NUMBER | UPC # 780227 | SIZE | A | B | C | UNIT QUANTITY | MASTER CARTON | MASTER WEIGHT |
|----------------|--------------|--------|--------|--------|-------|---------------|---------------|---------------|
| TW 5 100 | 31601 | 1/2" | 3/4" | 3/4" | 1/4" | 100 | 1000 | 30 |
| TW 7 100 | 31602 | 3/4" | 7/8" | 7/8" | 1/4" | 100 | 1000 | 37 |
| TW 10 50 | 31603 | 1" | 1-1/8" | 1-1/8" | 1/4" | 50 | 500 | 25 |
| TW 12 20 | 31604 | 1-1/4" | 1-1/2" | 1-1/4" | 1/4" | 20 | 200 | 19 |
| TW 15 20 | 31605 | 1-1/2" | 1-3/4" | 1-5/8" | 5/16" | 20 | 200 | 33 |
| TW 20 10 | 31606 | 2" | 2-1/8" | 1-7/8" | 3/8" | 10 | 100 | 17 |

A = INSIDE WIDTH
B = INSIDE HEIGHT
C = HOLE DIAMETER

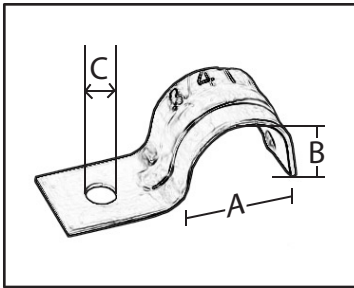

FOLD OVER STRAPS

Aluminum 1-Hole Strap. Fast And Easy Installation For Service Entrance Cable

| CATALOG NUMBER | UPC # 780227 | CABLE SIZE | A | B | C | UNIT QUANTITY | MASTER CARTON | MASTER WEIGHT |
|----------------|--------------|------------|--------|------|------|---------------|---------------|---------------|
| SC 15 100 | 43902 | 8/3 & 6/3 | 3/4" | 1/2" | 1/4" | 100 | 1000 | 12 |
| SC 20 100 | 43903 | 4/3 | 7/8" | 1/2" | 1/4" | 100 | 1000 | 13 |
| SC 25 100 | 43905 | 2/3 | 1" | 5/8" | 1/4" | 100 | 1000 | 17 |
| SC 35 50 | 43907 | 2/0 | 1-3/8" | 3/4" | 1/4" | 50 | 500 | 15 |
| SC 40 50 | 43909 | 4/0 | 1-1/2" | 3/4" | 1/4" | 50 | 500 | 15 |

A = INSIDE WIDTH
B = INSIDE HEIGHT
C = HOLE DIAMETER

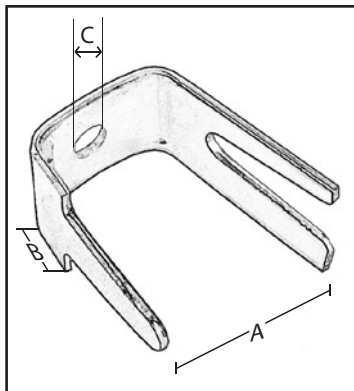



SERVICE ENTRANCE CABLE STRAPS

| CATALOG NUMBER | UPC # 780227 | MATERIAL | # HOLES | CABLE SIZE | A | B | C | UNIT QTY | MASTER CARTON | MASTER WEIGHT |
|----------------|--------------|------------------|---------|------------|--------|--------|-------|----------|---------------|---------------|
| 6S1 100 | 41503 | GALVANIZED STEEL | 1 | 4/3 & 6/3 | 7/8" | 1/2" | 7/32" | 100 | 1000 | 17 |
| 4S1 100 | 41505 | GALVANIZED STEEL | 1 | 2/3 | 1" | 5/8" | 1/4" | 100 | 1000 | 34 |
| 1S0 50 | 41506 | GALVANIZED STEEL | 1 | 1/0 | 1-1/4" | 3/4" | 5/16" | 50 | 500 | 30 |
| 2S0 50 | 41507 | GALVANIZED STEEL | 1 | 2/0 | 1-3/8" | 3/4" | 5/16" | 50 | 500 | 32 |
| 4S0 50 | 41509 | GALVANIZED STEEL | 1 | 4/0 | 1-5/8" | 3/4" | 5/16" | 50 | 500 | 32 |
| 6S2 100 | 41603 | GALVANIZED STEEL | 2 | 4/3 & 6/3 | 7/8" | 1/2" | 7/32" | 100 | 1000 | 26 |
| 4S2 100 | 41605 | GALVANIZED STEEL | 2 | 2/3 | 1" | 5/8" | 7/32" | 100 | 1000 | 27 |
| 4S2A 100 | 41608 | ALUMINUM | 2 | 2/3 | 1" | 5/8" | 7/32" | 100 | 1000 | 11 |
| 1S0 2 50 | 43606 | ALUMINUM | 2 | 1/0 | 1-1/4" | 11/16" | 1/4" | 50 | 500 | 12 |
| 2S0 2 50 | 43607 | ALUMINUM | 2 | 2/0 | 1-3/8" | 3/4" | 1/4" | 50 | 500 | 12 |
| 4S0 2 50 | 43609 | ALUMINUM | 2 | 4/0 | 1-1/2" | 3/4" | 1/4" | 50 | 500 | 13 |

A = INSIDE WIDTH
 B = INSIDE HEIGHT
 C = HOLE DIAMETER

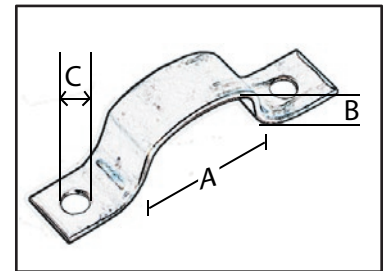

SERVICE ENTRANCE ROUND CABLE STRAPS

Aluminum 2-Hole Strap

| CATALOG NUMBER | UPC # 780227 | CABLE SIZE | A | B | C | UNIT QUANTITY | MASTER CARTON | MASTER WEIGHT |
|----------------|--------------|------------|--------|--------|------|---------------|---------------|---------------|
| 5S0 2 50 | 43608 | 2/3 SER | 15/16" | 15/16" | 1/4" | 50 | 500 | 11 |
| 6S0 2 25 | 43612 | 4/0 SER | 1-1/2" | 1-1/2" | 1/4" | 25 | 250 | 9 |

A = INSIDE WIDTH
 B = INSIDE HEIGHT
 C = HOLE DIAMETER

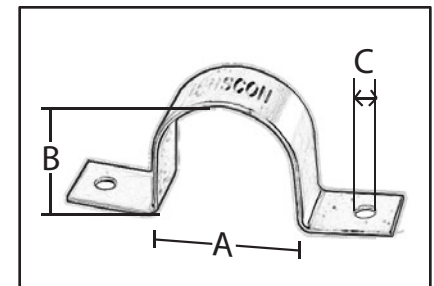

#1 IN FASTENING THE POWER



MIDGET STRAPS

Galvanized Steel 1-Hole Strap

| CATALOG NUMBER | UPC # | CABLE SIZE | A | B | C | UNIT QTY | MASTER CARTON | MASTER WEIGHT |
|----------------|-------|----------------------------------|------|------|-------|----------|---------------|---------------|
| M 25 100 | 69124 | 1/4" TUBING, #6 & #4 GROUND WIRE | 3/8" | 1/4" | 3/16" | 100 | 2000 | 18 |
| M 30 100 | 69123 | 14/2 TO 12/2 UF & NM SHEATHED | 1/2" | 1/4" | 3/16" | 100 | 2000 | 23 |
| M 50 100 | 69125 | 14/2 TO 10/3 MC | 5/8" | 1/2" | 3/16" | 100 | 2000 | 31 |

A = INSIDE WIDTH
 B = INSIDE HEIGHT
 C = HOLE DIAMETER

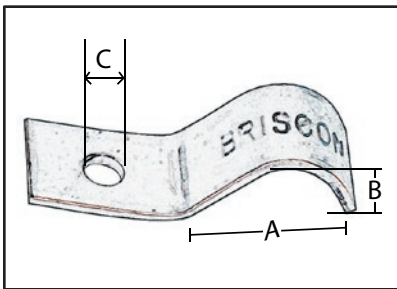



NON-WATERTIGHT CONNECTORS

Non-metallic And Service Entrance Cable; Oval Or Round
Zinc Die Cast 2-Screw Clamp Type

| CATALOG NUMBER | UPC # 780227 | SIZE | CABLE SIZE | KNOCKOUT SIZE | UNIT QUANTITY | MASTER CARTON | MASTER WEIGHT |
|----------------|-----------------|--------|-------------|---------------|---------------|---------------|---------------|
| 75 SM/SMR 25 | 45602 | 3/4" | 6/3 SEU/SER | 3/4" | 25 | 250 | 21 |
| 100 SM 25 | 45503 | 1" | 4/3 SEU | 1" | 25 | 250 | 38 |
| 100 SMR 25 | 45603 | 1" | 4/3 SER | 1" | 25 | 250 | 37 |
| 125 SM 10 | 45504 | 1-1/4" | 2/3 SEU | 1-1/4" | 10 | 100 | 25 |
| 125 SMR 10 | 45604 | 1-1/4" | 2/3 SER | 1-1/4" | 10 | 100 | 19 |
| 150 SM 10 | 45505 | 1-1/2" | 2/0 SEU | 1-1/2" | 10 | 100 | 33 |
| 150 SMR 10 | 45605 | 1-1/2" | 2/0 SER | 1-1/2" | 10 | 100 | 30 |
| 200 SM 5 | 45506 | 2" | 4/0 SEU | 2" | 5 | 50 | 28 |
| 200 SMR 5 | 45606 | 2" | 4/0 SER | 2" | 5 | 50 | 21 |



WATERTIGHT CONNECTORS

Service Entrance Cable

| CATALOG NUMBER | UPC # 780227 | SIZE | CABLE SIZE | GROMMET OPENING | | UNIT QUANTITY | MASTER CARTON | MASTER WEIGHT |
|----------------|-----------------|--------|------------|-----------------|---------------|---------------|---------------|---------------|
| | | | | MINIMUM | MAXIMUM | | | |
| WC 1006 15 | 45702 | 1" | 6/3 SEU | 0.32" x 0.50" | 0.40" x 0.63" | 15 | 150 | 35 |
| WC 1004 15 | 45703 | 1" | 4/3 SEU | 0.40" x 0.71" | 0.50" x 0.77" | 15 | 150 | 35 |
| WC 1252 15 | 45705 | 1-1/4" | 2/3 SEU | 0.51" x 0.93" | 0.59" x 0.98" | 15 | 150 | 60 |
| WC 1252N 15 | 45715 | 1-1/4" | 2/3 SEU | 0.57" x 1.05" | 0.65" x 1.09" | 15 | 150 | 60 |
| WC 1502 6 | 45707 | 1-1/2" | 2/0 SEU | 0.70" x 1.20" | 0.86" x 1.34" | 6 | 60 | 40 |
| WC 1503 6 | 45708 | 1-1/2" | 3/0 SEU | 0.75" x 1.30" | 0.87" x 1.37" | 6 | 60 | 40 |
| WC 2002 6 | 45717 | 2" | 2/0 SEU | 0.70" x 1.20" | 0.86" x 1.34" | 6 | 60 | 55 |
| WC 2003 6 | 45718 | 2" | 3/0 SEU | 0.75" x 1.30" | 0.87" x 1.37" | 6 | 60 | 55 |
| WC 2004 6 | 45709 | 2" | 4/0 SEU | 0.84" x 1.43" | 0.90" x 1.50" | 6 | 60 | 55 |

CABLE CONNECTORS

2 NC

Zinc Die Cast, 2-Screw Clamp Type, For (2) 14/2 Through (1) 10/2 Non-metallic Sheathed

| CATALOG NUMBER | UPC # | SIZE | KNOCKOUT SIZE | UNIT QUANTITY | MASTER CARTON | MASTER WEIGHT |
|----------------|-------|------|---------------|---------------|---------------|---------------|
| 2 NC 100 | 45111 | 3/8" | 1/2" | 100 | 1000 | 47 |



1 AC

Zinc Die Cast, 1 Set Screw Type, For 3/8" Flex And Metal Clad Cable

| CATALOG NUMBER | UPC # | SIZE | KNOCKOUT SIZE | UNIT QUANTITY | MASTER CARTON | MASTER WEIGHT |
|----------------|-------|------|---------------|---------------|---------------|---------------|
| 1 AC 100 | 45311 | 3/8" | 1/2" | 100 | 1000 | 45 |



90 M

Zinc Die Cast, 90° Angle, 2-Screw Clamp Type, For 3/8" Flex And Metal Clad Cable

| CATALOG NUMBER | UPC # | SIZE | KNOCKOUT SIZE | UNIT QUANTITY | MASTER CARTON | MASTER WEIGHT |
|----------------|-------|------|---------------|---------------|---------------|---------------|
| 90 M 25 | 45191 | 3/8" | 1/2" | 25 | 250 | 23 |



2 BX

Zinc Die Cast, 1-Screw Saddle Type, For 3/8" Flex And Metal Clad Cable

| CATALOG NUMBER | UPC # | SIZE | KNOCKOUT SIZE | UNIT QUANTITY | MASTER CARTON | MASTER WEIGHT |
|----------------|-------|------|---------------|---------------|---------------|---------------|
| 2 BX 50 | 45123 | 3/8" | 1/2" | 50 | 500 | 36 |



25 SM

Zinc Die Cast, Set Screw Type
Combination Coupling For EMT To Flex And Metal Clad Cable

| CATALOG NUMBER | UPC # | SIZE | UNIT QUANTITY | MASTER CARTON | MASTER WEIGHT |
|----------------|-------|------|---------------|---------------|---------------|
| 25 SM 25 | 87760 | 3/8" | 25 | 250 | 17 |



50 SM

Zinc Die Cast, Duplex Connector 1-Screw Clamp Type
For Non-metallic, Flex And Metal Clad Cable

| CATALOG NUMBER | UPC # | SIZE | KNOCKOUT SIZE | UNIT QUANTITY | MASTER CARTON | MASTER WEIGHT |
|----------------|-------|------|---------------|---------------|---------------|---------------|
| 50 SM 25 | 87765 | 3/8" | 1/2" | 25 | 250 | 28 |



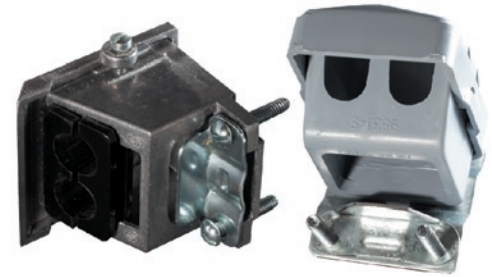

WEATHER CAPS Service Entrance Cable

Plastic Cap With Galvanized Steel Bracket And Clamp

| CATALOG NUMBER | UPC # | CABLE SIZE | UNIT QUANTITY | MASTER CARTON | MASTER WEIGHT |
|----------------|-------|------------|---------------|---------------|---------------|
| # 100 6 | 47905 | 2/3 | 6 | 60 | 15 |
| # 150 25 | 47907 | 2/0 | 1 | 25 | 13 |
| # 200 25 | 47909 | 4/0 | 1 | 25 | 12 |

Aluminum Die Cast Cap With Galvanized Steel Clamp

| CATALOG NUMBER | UPC # | CABLE SIZE | UNIT QUANTITY | MASTER CARTON | MASTER WEIGHT |
|----------------|-------|-----------------|---------------|---------------|---------------|
| DC 100 5 | 66100 | 8/3 THROUGH 2/3 | 5 | 50 | 14 |
| DC 200 25 | 66200 | 1/0 THROUGH 4/0 | 1 | 25 | 24 |

Rigid Conduit And EMT

A Sleeve Is Furnished With Each Cap For Adaptation To EMT

| CATALOG NUMBER | UPC # | CONDUIT SIZE | UNIT QUANTITY | MASTER CARTON | MASTER WEIGHT |
|----------------|-------|--------------|---------------|---------------|---------------|
| 5 WC | 27701 | 1/2" | 1 | 20 | 3 |
| 7 WC | 27702 | 3/4" | 1 | 20 | 4 |
| 10 WC | 27703 | 1" | 1 | 10 | 2 |
| 12 WC | 27704 | 1-1/4" | 1 | 10 | 3 |
| 15 WC | 27705 | 1-1/2" | 1 | 5 | 2 |
| 20 WC | 27706 | 2" | 1 | 5 | 5 |





SP 28

SILL PLATES

Complete With Duct Seal Compound And Zinc Plated Combination Head Screws

| CATALOG NUMBER | UPC # 780227 | MATERIAL | SEU CABLE SIZE | UNIT QUANTITY | MASTER CARTON | MASTER WEIGHT |
|----------------|-----------------|---------------|----------------|---------------|---------------|---------------|
| SP 46 10 | 42903 | ALUMINUM | 4/3 & 6/3 | 10 | 100 | 10 |
| SP 28 10 | 42905 | ALUMINUM | 2/3 & 3/3 | 10 | 100 | 10 |
| SP 28P 10 | 42908 | PLASTIC | 2/3 & 3/3 | 10 | 100 | 10 |
| SP 40 25 | 42909 | CAST ALUMINUM | 2/0 & 4/0 | 1 | 25 | 22 |



SP 40

FISH WIRE

Finest Quality

Flat, Oil Tempered Spring Steel, Flexible And Easy To Fish

0.125" Wide x 0.060" Thick

Individually Bagged 10 Bags Per Master Carton

FW 25 Bulk Packed; 25 Coils Per Carton

| CATALOG NUMBER | UPC # 780227 | LENGTH | MASTER WEIGHT |
|----------------|-----------------|--------|---------------|
| FW 25 | 85711 | 25' | 16 |
| FW 50 | 85721 | 50' | 13 |
| FW 100 | 85731 | 100' | 26 |
| FW 200 | 85741 | 200' | 52 |



#1 IN FASTENING THE POWER



BOX SUPPORTS

Galvanized Steel

| CATALOG NUMBER | UPC # 780227 | DIMENSIONS | | | UNIT QUANTITY | MASTER CARTON | MASTER WEIGHT |
|------------------------|-----------------|------------|--------|--------|------------------|--------------------|---------------|
| | | A | B | C | | | |
| BS 1 100 STANDARD | 75070 | 5-1/4" | 2-1/8" | 1-1/2" | 100 (50) PAIR | 1000 (500) PAIR | 22 |
| BS 2 100 EXTRA LONG | 75072 | 5-1/4" | 3" | 2-1/4" | 100 (50) PAIR | 1000 (500) PAIR | 33 |

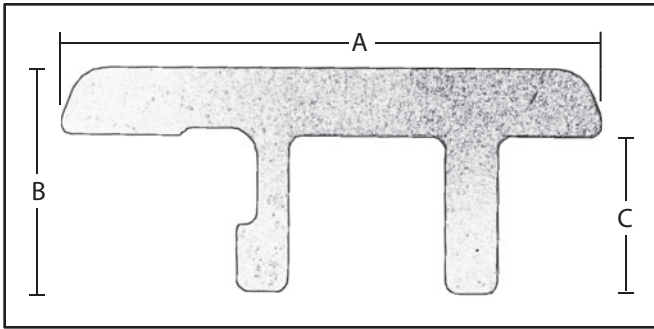

STUD SAFETY PLATES

16 Gauge Steel

| CATALOG NUMBER | UPC # 780227 | DIMENSIONS WIDTH x LENGTH | UNIT QUANTITY | MASTER CARTON | MASTER WEIGHT |
|------------------------|-----------------|------------------------------|---------------|---------------|---------------|
| | | | | | |
| SSP 2 50 EXTRA LONG | 85737 | 1-5/8" x 5" | 50 | 200 | 27 |

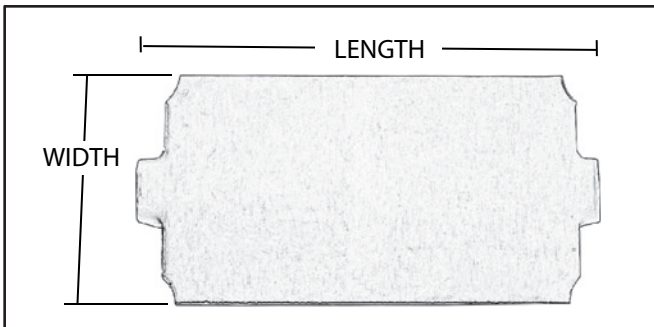



WIRE CONNECTORS

Color Coded For Easy Identification
Wire Spring Insert For Secure Connections

Three Sizes For Combinations From #10 Through #18 AWG
Rated At 600 Volts, Fixtures And Signs 1000 Volts
Temperature Rated At 105°C

| CATALOG NUMBER | UPC # | SIZE | COLOR | UNIT QUANTITY | MASTER CARTON | MASTER WEIGHT |
|----------------|-------|--------|--------|---------------|---------------|---------------|
| SWC 100 | 69111 | SMALL | ORANGE | 100 | 5000 | 12 |
| MWC 100 | 69121 | MEDIUM | YELLOW | 100 | 5000 | 18 |
| LWC 100 | 69131 | LARGE | RED | 100 | 2000 | 17 |

CLAMSHELLS

Briscon Quality And Name Recognition, Clamshells For Retail And Counter Sales,
Convenient Packaging For Both The Customer And Sales Person

Packaged 100 Clamshells Per Master Case

| CATALOG NUMBER | UPC # 780227 | DESCRIPTION WIDTH x LENGTH | PARTS PER PACKAGE | MASTER WEIGHT |
|----------------|-----------------|--|-------------------|---------------|
| SN 40 B 25 | 72401 | 1/2" x 1" ZINC PLATED STAPLE | 25 | 15 |
| SN 40 IB 20 | 71930 | 1/2" x 1" ZINC PLATED INSULATED STAPLE | 20 | 15 |
| SN 150 B 15 | 75036 | 1/2" x 1-1/2" ZINC PLATED STAPLE | 15 | 17 |
| SN 150 IB 10 | 75032 | 1/2" x 1-1/2" ZINC PLATED STAPLE | 10 | 19 |
| SN 100 B 15 | 72990 | 9/16" x 1-1/4" ZINC PLATED STAPLE | 15 | 14 |
| SN 100 IB 15 | 72611 | 9/16" x 1-1/4" ZINC PLATED INSULATED STAPLE | 15 | 15 |
| SN 300 B 10 | 73304 | 13/16" x 1-3/8" ZINC PLATED STAPLE | 10 | 16 |
| SN 300 IB 10 | 73306 | 13/16" x 1-3/8" ZINC PLATED INSULATED STAPLE | 10 | 19 |
| SN 350 B 10 | 73352 | 1-1/16" x 1-7/16" ZINC PLATED STAPLE | 10 | 19 |
| SN 350 IB 5 | 73357 | 1-1/16" x 1-7/16" ZINC PLATED INSULATED STAPLE | 5 | 14 |
| PS 50 20 | 72510 | 1/2" 2-NAIL PLASTIC STAPLE | 20 | 15 |
| PS 75 15 | 72515 | 3/4" 2-NAIL PLASTIC STAPLE | 15 | 13 |
| CX 90 20 | 75053 | 1/2" x 1" ZINC PLATED COAXIAL STAPLE | 20 | 19 |
| PS 90 B 25 | 72520 | 1-NAIL COAXIAL 1/4" BLACK PLASTIC STAPLE | 25 | 9 |
| PS 90 W 25 | 72521 | 1-NAIL COAXIAL 1/4" WHITE PLASTIC STAPLE | 25 | 9 |
| PS 80 B 25 | 72530 | 3/16" x 1" 1-NAIL BLACK LOW VOLTAGE PLASTIC STAPLE | 25 | 9 |
| PS 80 B 100 | 72531 | 3/16" x 1" 1-NAIL BLACK LOW VOLTAGE PLASTIC STAPLE | 100 | 26 |
| PS 80 W 25 | 72540 | 3/16" x 1" 1-NAIL WHITE LOW VOLTAGE PLASTIC STAPLE | 25 | 9 |
| PS 80 W 100 | 72541 | 3/16" x 1" 1-NAIL WHITE LOW VOLTAGE PLASTIC STAPLE | 100 | 26 |
| #5 BROWN 40 BP | 71512 | 1/4" x 5/8" BROWN LOW VOLTAGE INSULATED STAPLE | 40 | 11 |
| #5 WHITE 40 BP | 71516 | 1/4" x 5/8" WHITE LOW VOLTAGE INSULATED STAPLE | 40 | 11 |

STAINLESS STEEL CLAMSHELLS

For Use On Pressure Treated Lumber And Exterior Applications

Packaged 100 Clamshells Per Master Case

| CATALOG NUMBER | UPC # | DESCRIPTION WIDTH x LENGTH | PARTS PER PACKAGE | MASTER WEIGHT |
|-----------------|-------|--|-------------------|---------------|
| SN 40 B SS 25 | 10036 | 1/2" x 1" STAINLESS STEEL STAPLE | 25 | 15 |
| SN 40 IB SS 20 | 10031 | 1/2" x 1" STAINLESS STEEL INSULATED STAPLE | 20 | 15 |
| SN 100 B SS 15 | 71988 | 9/16" x 1-1/4" STAINLESS STEEL STAPLE | 15 | 14 |
| SN 100 IB SS 15 | 72616 | 9/16" x 1-1/4" STAINLESS STEEL INSULATED STAPLE | 15 | 15 |
| SN 150 B SS 15 | 75042 | 1/2" x 1-1/2" STAINLESS STEEL STAPLE | 15 | 17 |
| SN 150 IB SS 10 | 75033 | 1/2" x 1-1/2" STAINLESS STEEL INSULATED STAPLE | 10 | 19 |
| SN 300 B SS 10 | 73309 | 13/16" x 1-3/8" STAINLESS STEEL STAPLE | 10 | 16 |
| SN 300 IB SS 10 | 73310 | 13/16" x 1-3/8" STAINLESS STEEL INSULATED STAPLE | 10 | 19 |
| SN 350 B SS 10 | 73358 | 1-1/16" x 1-7/16" STAINLESS STEEL STAPLE | 10 | 19 |
| SN 350 IB SS 5 | 73355 | 1-1/16" x 1-7/16" STAINLESS STEEL INSULATED STAPLE | 5 | 14 |



Contents

| | |
|--|------------|
| CABLE STAPLES | 2 |
| ROUND CABLE STAPLES | 7 |
| STAINLESS STEEL CABLE STAPLES | 9 |
| STAINLESS STEEL STRAPS | 11A |
| PLASTIC STAPLES | 12 |
| COAXIAL STAPLES | 12 |
| LOW VOLTAGE INSULATED STAPLES | 13 |
| LOW VOLTAGE PLASTIC STAPLES | 13 |
| SERVICE ENTRANCE KITS | 14 |
| DRIVE STRAPS | 15 |
| PLASTIC CONDUIT STRAPS | 15 |
| THIN WALL CONDUIT STRAPS | 16 |
| FOLD OVER STRAPS | 16 |
| SERVICE ENTRANCE CABLE STRAPS | 17 |
| SERVICE ENTRANCE ROUND CABLE STRAPS | 17 |
| MIDGET STRAPS | 18 |
| NON-WATERTIGHT CONNECTORS | 19 |
| WATERTIGHT CONNECTORS | 19 |
| CABLE CONNECTORS | 20 |
| WEATHER CAPS | 22 |
| SILL PLATES | 23 |
| FISH WIRE | 23 |
| BOX SUPPORTS | 24 |
| STUD SAFETY PLATES | 24 |
| WIRE CONNECTORS | 25 |
| CLAMSHELLS | 26 |
| STAINLESS STEEL CLAMSHELLS | 27 |

CABLE STAPLES

All Staple Sizes Are Inside Dimensions

SN 40

1/2" Wide, 1" Long, Low Carbon Steel

Armored Cable 14/2 And 14/3

Metal Clad 14/2 And 14/3

Non-metallic Sheathed 14/2 Through 10/3

Underground Feeder 14/2 And 12/2

| CATALOG NUMBER | UPC # 780227 | UNIT QUANTITY | MASTER CARTON | MASTER WEIGHT |
|----------------|-----------------|---------------|---------------|---------------|
| SN 40 500 | 72403 | 500 | 10000 | 45 |
| SN 40 5M | 72405 | 5000 | BUCKET | 23 |
| SN 40 J 1500 | 72404 | 1500 JAR | 9000 | 41 |
| SN 40 10M | 72407 | 10000 | BUCKET | 45 |
| SN 40 15M | 72409 | 15000 | BUCKET | 63 |



SN 40 B

1/2" Wide, 1" Long, Zinc Plated Low Carbon Steel



Armored Cable 14/2 And 14/3

Metal Clad 14/2 And 14/3

Non-metallic Sheathed 14/2 Through 10/3

Underground Feeder 14/2 And 12/2

| CATALOG NUMBER | UPC # 780227 | UNIT QUANTITY | MASTER CARTON | MASTER WEIGHT |
|----------------|-----------------|---------------|---------------|---------------|
| SN 40 B 100 | 71966 | 100 | 10000 | 45 |
| SN 40 B 500 | 71968 | 500 | 10000 | 45 |
| SN 40 BJ 1500 | 71969 | 1500 JAR | 9000 | 41 |
| SN 40 B 5M | 71970 | 5000 | BUCKET | 23 |
| SN 40 B 10M | 71975 | 10000 | BUCKET | 45 |
| SN 40 B 15M | 71977 | 15000 | BUCKET | 63 |



SN 40 IB

1/2" Wide, 1" Long, Zinc Plated Low Carbon Steel, LDPE Blue Plastic Insulator



Armored Cable 14/2 And 14/3

Metal Clad 14/2 And 14/3

Non-metallic Sheathed 14/2 Through 10/3

Underground Feeder 14/2 And 12/2

| CATALOG NUMBER | UPC # 780227 | UNIT QUANTITY | MASTER CARTON | MASTER WEIGHT |
|----------------|--------------|---------------|---------------|---------------|
| SN 40 IB 100 | 71981 | 100 | 5000 | 27 |
| SN 40 IB 500 | 71984 | 500 | 5000 | 27 |
| SN 40 IBJ 500 | 71983 | 500 JAR | 5000 | 27 |
| SN 40 IB 2500 | 71980 | 2500 | BUCKET | 13 |
| SN 40 IB 5M | 71985 | 5000 | BUCKET | 26 |



SN 100

9/16" Wide, 1-1/4" Long, Low Carbon Steel

Armored Cable 14/2 Through 10/3

Metal Clad 14/2 Through 10/3

Non-metallic Sheathed 12/3 Through 10/3

Underground Feeder 14/3 And 12/3

| CATALOG NUMBER | UPC # 780227 | UNIT QUANTITY | MASTER CARTON | MASTER WEIGHT |
|----------------|--------------|---------------|---------------|---------------|
| SN 100 500 | 72993 | 500 | 5000 | 37 |
| SN 100 J 1M | 72983 | 1000 JAR | 6000 | 42 |
| SN 100 5M | 72985 | 5000 | BUCKET | 35 |
| SN 100 10M | 72997 | 10000 | BUCKET | 70 |



SN 100 B

9/16" Wide, 1-1/4" Long, Zinc Plated Low Carbon Steel



Armored Cable 14/2 Through 10/3

Metal Clad 14/2 Through 10/3

Non-metallic Sheathed 12/3 Through 10/3

Underground Feeder 14/3 And 12/3

| CATALOG NUMBER | UPC # 780227 | UNIT QUANTITY | MASTER CARTON | MASTER WEIGHT |
|----------------|--------------|---------------|---------------|---------------|
| SN 100 B 100 | 71986 | 100 | 5000 | 37 |
| SN 100 B 500 | 71995 | 500 | 5000 | 37 |
| SN 100 BJ 1M | 71987 | 1000 JAR | 6000 | 44 |
| SN 100 B 4M | 71990 | 4000 | BUCKET | 30 |



SN 100 IB

9/16" Wide, 1-1/4" Long, Zinc Plated Low Carbon Steel, LDPE Yellow Plastic Insulator

Armored Cable 14/2 Through 10/3
 Non-metallic Sheathed 14/2 Through 10/3
 Non-metallic Sheathed 14/3 Parallel (Flat)

Metal Clad 14/2 Through 10/3
 Underground Feeder 14/2 Through 12/3

| CATALOG NUMBER | UPC # | UNIT QUANTITY | MASTER CARTON | MASTER WEIGHT |
|----------------|-------|---------------|---------------|---------------|
| SN 100 IB 100 | 72610 | 100 | 2000 | 18 |
| SN 100 IB 250 | 72613 | 250 | 2500 | 22 |
| SN 100 IB 3M | 72615 | 3000 | BUCKET | 27 |



SN 150 B

1/2" Wide, 1-1/2" Long, Zinc Plated Low Carbon Steel,
 Extra Long For Securing Up To Two Cables



One Cable

Non-metallic Sheathed 14/2 Through 10/3
 Underground Feeder 14/2 And 12/2

Two Cables

Non-metallic Sheathed 14/2 Through 12/3
 Underground Feeder 14/2 And 12/2

| CATALOG NUMBER | UPC # | UNIT QUANTITY | MASTER CARTON | MASTER WEIGHT |
|----------------|-------|---------------|---------------|---------------|
| SN 150 B 100 | 75025 | 100 | 5000 | 44 |
| SN 150 B 500 | 75030 | 500 | 5000 | 44 |
| SN 150 B 2500 | 75035 | 2500 | BUCKET | 22 |



SN 150 IB

1/2" Wide, 1-1/2" Long, Zinc Plated Low Carbon Steel,
 LDPE Red Plastic Insulator, Extra Long For Securing Up To Two Cables



One Cable

Non-metallic Sheathed 14/2 Through 10/3
 Underground Feeder 14/2 And 12/2

Two Cables

Non-metallic Sheathed 14/2 Through 12/3
 Underground Feeder 14/2 And 12/2

| CATALOG NUMBER | UPC # | UNIT QUANTITY | MASTER CARTON | MASTER WEIGHT |
|----------------|-------|---------------|---------------|---------------|
| SN 150 IB 100 | 75027 | 100 | 5000 | 51 |
| SN 150 IB 250 | 75028 | 250 | 2500 | 25 |
| SN 150 IB 3M | 75026 | 3000 | BUCKET | 29 |



SN 300 B

13/16" Wide, 1-3/8" Long, Zinc Plated Low Carbon Steel



Armored Cable 8/3 Metal Clad 8/3 SE Cable 8/2 Through 6/3
 Non-metallic Sheathed 8/3 Through 6/3 Underground Feeder 10/3

| CATALOG NUMBER | UPC # | UNIT QUANTITY | MASTER CARTON | MASTER WEIGHT |
|----------------|-------|---------------|---------------|---------------|
| SN 300 B 100 | 73302 | 100 | 5000 | 65 |



SN 300 IB

13/16" Wide, 1-3/8" Long, Zinc Plated Low Carbon Steel, LDPE Grey Plastic Insulator



Armored Cable 8/3 Metal Clad 8/3 SE Cable 8/2 Through 6/3
 Non-metallic Sheathed 8/3 Through 6/3 Underground Feeder 10/3

| CATALOG NUMBER | UPC # | UNIT QUANTITY | MASTER CARTON | MASTER WEIGHT |
|----------------|-------|---------------|---------------|---------------|
| SN 300 IB 100 | 73305 | 100 | 1000 | 16 |
| SN 300 IBJ 175 | 75312 | 175 | 1750 | 29 |



SN 350 B

1-1/16" Wide, 1-7/16" Long, Zinc Plated Low Carbon Steel



SE Cable 4/3 SEU Through 2/3 SER

| CATALOG NUMBER | UPC # | UNIT QUANTITY | MASTER CARTON | MASTER WEIGHT |
|----------------|-------|---------------|---------------|---------------|
| SN 350 B 100 | 73350 | 100 | 2000 | 30 |



SN 350 IB

1-1/16" Wide, 1-7/16" Long, Zinc Plated Low Carbon Steel, LDPE Grey Plastic Insulator

SE Cable 4/3 SEU Through 2/3 SER

| CATALOG NUMBER | UPC # | UNIT QUANTITY | MASTER CARTON | MASTER WEIGHT |
|----------------|-------|---------------|---------------|---------------|
| SN 350 IB 50 | 73356 | 50 | 1000 | 18 |



#1 IN FASTENING THE POWER

SN 400 B

1-11/32" Wide, 1-7/8" Long, Zinc Plated Low Carbon Steel



SE Cable 3 No. 2/0 SEU SE Cable 3 No. 2/0 SER

| CATALOG NUMBER | UPC # | UNIT QUANTITY | MASTER CARTON | MASTER WEIGHT |
|----------------|-------|---------------|---------------|---------------|
| SN 400 B 100 | 73400 | 100 | 1000 | 32 |



SN 450 B

1-3/16" Wide, 2-1/4" Long, Zinc Plated Low Carbon Steel



Armored Cable 2/3 SE Cable 3 No. 1/0 SER Underground Feeder 6/3

| CATALOG NUMBER | UPC # | UNIT QUANTITY | MASTER CARTON | MASTER WEIGHT |
|----------------|-------|---------------|---------------|---------------|
| SN 450 B 100 | 73450 | 100 | 1000 | 35 |



SN 500 B

1-5/8" Wide, 2-1/8" Long, Zinc Plated Low Carbon Steel



SE Cable 3 No. 4/0 SEU SE Cable 3 No. 4/0 SER

| CATALOG NUMBER | UPC # | UNIT QUANTITY | MASTER CARTON | MASTER WEIGHT |
|----------------|-------|---------------|---------------|---------------|
| SN 500 B 100 | 73500 | 100 | 1000 | 37 |



ROUND CABLE STAPLES

SN 600

1-1/16" Wide, 2-1/16" Long, Zinc Plated Low Carbon Steel

4/3 SER Cable 2/3 SER Cable 3/4" EMT 1/2" Greenfield

| CATALOG NUMBER | UPC # | UNIT QUANTITY | MASTER CARTON | MASTER WEIGHT |
|----------------|-------|---------------|---------------|---------------|
| SN 600 100 | 74600 | 100 | 1000 | 29 |



SN 700

1-11/32" Wide, 2-11/32" Long, Zinc Plated Low Carbon Steel

2/0 SER Cable 1" EMT 1" Greenfield

| CATALOG NUMBER | UPC # | UNIT QUANTITY | MASTER CARTON | MASTER WEIGHT |
|----------------|-------|---------------|---------------|---------------|
| SN 700 100 | 74700 | 100 | 1000 | 35 |



SN 800

1-3/16" Wide, 2-3/16" Long, Zinc Plated Low Carbon Steel

2/3 BX 1" EMT 1" Greenfield 2/3 SER Cable

| CATALOG NUMBER | UPC # | UNIT QUANTITY | MASTER CARTON | MASTER WEIGHT |
|----------------|-------|---------------|---------------|---------------|
| SN 800 100 | 74800 | 100 | 1000 | 38 |



SN 900

1-5/8" Wide, 2-5/8" Long, Zinc Plated Low Carbon Steel

4/0 SER Cable 1" And 1-1/4" EMT Large BX And NM Greenfield

| CATALOG NUMBER | UPC # | UNIT QUANTITY | MASTER CARTON | MASTER WEIGHT |
|----------------|-------|---------------|---------------|---------------|
| SN 900 100 | 74900 | 100 | 1000 | 40 |



SN 1000

1-1/4" Wide, 2-3/4" Long, Zinc Plated Low Carbon Steel
Heavy Duty; Ideal For Wood Reels And Multiple Wiring

Large Metal Clad And Non-metallic Cable Greenfield

| CATALOG NUMBER | UPC # | UNIT QUANTITY | MASTER CARTON | MASTER WEIGHT |
|----------------|-------|---------------|---------------|---------------|
| SN 1000 20 | 75000 | 20 | 400 | 32 |



STAINLESS STEEL CABLE STAPLES

For Use On Pressure Treated Lumber And Exterior Applications

SN 40 B SS

1/2" Wide, 1" Long, Stainless Steel



Armored Cable 14/2 And 14/3 Metal Clad 14/2 And 14/3
 Non-metallic Sheathed 14/2 Through 10/3 Underground Feeder 14/2 And 12/2

| CATALOG NUMBER | UPC # | UNIT QUANTITY | MASTER CARTON | MASTER WEIGHT |
|----------------|-------|---------------|---------------|---------------|
| SN 40 B SS 100 | 10035 | 100 | 10000 | 45 |



SN 40 IB SS

1/2" Wide, 1" Long, Stainless Steel, LDPE Blue Plastic Insulator



Armored Cable 14/2 And 14/3 Metal Clad 14/2 And 14/3
 Non-metallic Sheathed 14/2 Through 10/3 Underground Feeder 14/2 And 12/2

| CATALOG NUMBER | UPC # | UNIT QUANTITY | MASTER CARTON | MASTER WEIGHT |
|-----------------|-------|---------------|---------------|---------------|
| SN 40 IB SS 100 | 10030 | 100 | 5000 | 27 |



SN 100 B SS

9/16" Wide, 1-1/4" Long, Stainless Steel



Armored Cable 14/2 Through 10/3 Metal Clad 14/2 Through 10/3
 Non-metallic Sheathed 12/3 Through 10/3 Underground Feeder 14/3 And 12/3

| CATALOG NUMBER | UPC # | UNIT QUANTITY | MASTER CARTON | MASTER WEIGHT |
|-----------------|-------|---------------|---------------|---------------|
| SN 100 B SS 100 | 71997 | 100 | 5000 | 37 |



SN 100 IB SS

9/16" Wide, 1-1/4" Long, Stainless Steel, LDPE Yellow Plastic Insulator

Armored Cable 14/2 Through 10/3 Metal Clad 14/2 Through 10/3
 Non-metallic Sheathed 14/2 Through 10/3 Underground Feeder 14/2 Through 12/3
 Non-metallic Sheathed 14/3 Parallel (Flat)

| CATALOG NUMBER | UPC # | UNIT QUANTITY | MASTER CARTON | MASTER WEIGHT |
|------------------|-------|---------------|---------------|---------------|
| SN 100 IB SS 100 | 72617 | 100 | 2000 | 18 |



SN 150 B SS

1/2" Wide, 1-1/2" Long, Stainless Steel
 Extra Long For Securing Up To Two Cables

One Cable Two Cables
 Non-metallic Sheathed 14/2 Through 10/3 Non-metallic Sheathed 14/2 Through 12/3
 Underground Feeder 14/2 And 12/2 Underground Feeder 14/2 And 12/2

| CATALOG NUMBER | UPC # | UNIT QUANTITY | MASTER CARTON | MASTER WEIGHT |
|-----------------|-------|---------------|---------------|---------------|
| SN 150 B SS 100 | 75041 | 100 | 5000 | 44 |



SN 150 IB SS

1/2" Wide, 1-1/2" Long, Stainless Steel, LDPE Red Plastic Insulator
 Extra Long For Securing Up To Two Cables

One Cable Two Cables
 Non-metallic Sheathed 14/2 Through 10/3 Non-metallic Sheathed 14/2 Through 12/3
 Underground Feeder 14/2 And 12/2 Underground Feeder 14/2 And 12/2

| CATALOG NUMBER | UPC # | UNIT QUANTITY | MASTER CARTON | MASTER WEIGHT |
|------------------|-------|---------------|---------------|---------------|
| SN 150 IB SS 100 | 75031 | 100 | 5000 | 51 |



SN 300 B SS

13/16" Wide, 1-3/8" Long, Stainless Steel



Armored Cable 8/3 Metal Clad 8/3 SE Cable 8/2 Through 6/3
 Non-metallic Sheathed 8/3 Through 6/3 Underground Feeder 10/3

| CATALOG NUMBER | UPC # | UNIT QUANTITY | MASTER CARTON | MASTER WEIGHT |
|-----------------|-------|---------------|---------------|---------------|
| SN 300 B SS 100 | 73303 | 100 | 5000 | 65 |



SN 300 IB SS

13/16" Wide, 1-3/8" Long, Stainless Steel
 LDPE Grey Plastic Insulator



Armored Cable 8/3 Metal Clad 8/3 SE Cable 8/2 Through 6/3
 Non-metallic Sheathed 8/3 Through 6/3 Underground Feeder 10/3

| CATALOG NUMBER | UPC # | UNIT QUANTITY | MASTER CARTON | MASTER WEIGHT |
|------------------|-------|---------------|---------------|---------------|
| SN 300 IB SS 100 | 73308 | 100 | 1000 | 16 |



SN 350 B SS

1-1/16" Wide, 1-7/16" Long, Stainless Steel



SE Cable 4/3 SEU Through 2/3 SER

| CATALOG NUMBER | UPC # | UNIT QUANTITY | MASTER CARTON | MASTER WEIGHT |
|-----------------|-------|---------------|---------------|---------------|
| SN 350 B SS 100 | 73353 | 100 | 2000 | 30 |



SN 350 IB SS

1-1/16" Wide, 1-7/16" Long, Stainless Steel
 LDPE Grey Plastic Insulator

SE Cable 4/3 SEU Through 2/3 SER

| CATALOG NUMBER | UPC # | UNIT QUANTITY | MASTER CARTON | MASTER WEIGHT |
|-----------------|-------|---------------|---------------|---------------|
| SN 350 IB SS 50 | 73354 | 50 | 1000 | 18 |





STAINLESS STEEL MIDGET STRAPS

1-Hole Strap

| CATALOG NUMBER | UPC # | CABLE SIZE | A | B | C | UNIT QTY | MASTER CARTON | MASTER WEIGHT |
|----------------|-------|----------------------------------|------|------|-------|----------|---------------|---------------|
| M 25 SS 100 | 69127 | 1/4" TUBING, #6 & #4 GROUND WIRE | 3/8" | 1/4" | 3/16" | 100 | 2000 | 18 |
| M 30 SS 100 | 69126 | 14/2 TO 12/2 UF & NM SHEATHED | 1/2" | 1/4" | 3/16" | 100 | 2000 | 23 |
| M 50 SS 100 | 69128 | 14/2 TO 10/3 MC | 5/8" | 1/2" | 3/16" | 100 | 2000 | 31 |

A = INSIDE WIDTH
 B = INSIDE HEIGHT
 C = HOLE DIAMETER

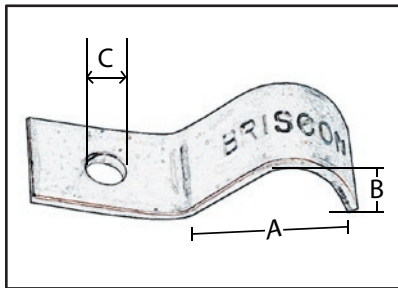



PLASTIC STAPLES

Plastic Saddles, Zinc Plated Nails Resist Rust And Corrosion

| CATALOG NUMBER | UPC # 780227 | CABLE SIZE | SADDLE COLOR | A | B | C | UNIT QTY | MASTER CARTON | MASTER WEIGHT |
|----------------|-----------------|----------------------------------|--------------|--------|--------|--------|----------|---------------|---------------|
| PS 50 100 | 72512 | 14/2 THROUGH 12/3 NM SHEATHED | WHITE | 1/2" | 3/16" | 1-1/4" | 100 | 2000 | 11 |
| PS 75 100 | 72517 | 14/2 THROUGH 10/3 NM SHEATHED | WHITE | 3/4" | 3/16" | 1-1/4" | 100 | 2000 | 11 |
| PS 300 100 | 41735 | 6/3 SEU | GREY | 3/4" | 3/8" | 1-3/4" | 100 | 1000 | 14 |
| PS 300 R 100 | 41740 | 6/3 SER | GREY | 3/4" | 3/4" | 1-3/4" | 100 | 1000 | 15 |
| PS 350 50 | 41745 | 2/3 SEU | GREY | 1" | 1/2" | 1-3/4" | 50 | 500 | 8 |
| PS 350 R 50 | 41750 | 2/3 SER | GREY | 1" | 1" | 2" | 50 | 500 | 12 |
| PS 400 R 50 | 41753 | 2/0 SER | GREY | 1-1/4" | 1-1/4" | 2-1/2" | 50 | 500 | 15 |
| PS 500 50 | 41755 | 4/0 SEU | GREY | 1-1/2" | 1" | 2" | 50 | 500 | 12 |
| PS 500 R 25 | 41760 | 4/0 SER | GREY | 1-1/2" | 1-1/2" | 2" | 25 | 250 | 9 |

A = INSIDE WIDTH
B = INSIDE HEIGHT
C = NAIL LENGTH

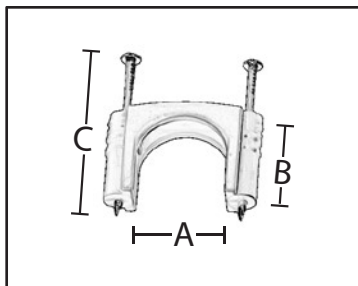

COAXIAL STAPLES

Use With RG-59, RG-6, Category 5 And Other Cables Up to 1/4"
Zinc Plated Nail And Staple Resist Rust And Corrosion

| CATALOG NUMBER | UPC# 780227 | DESCRIPTION WIDTH x LENGTH | UNIT QUANTITY | MASTER CARTON | MASTER WEIGHT |
|----------------|----------------|-------------------------------|------------------|------------------|------------------|
| CX 90 100 | 75050 | 1/2" x 1" STAPLE | 100 | 5000 | 34 |
| CX 90 J 500 | 75056 | 1/2" x 1" STAPLE | 500 JAR | 5000 | 34 |
| PS 90 B 100 | 72522 | 1/4" x 1" 1-NAIL BLACK | 100 | 10000 | 26 |
| PS 90 BJ 500 | 72524 | 1/4" x 1" 1-NAIL BLACK | 500 JAR | 5000 | 13 |
| PS 90 W 100 | 72523 | 1/4" x 1" 1-NAIL WHITE | 100 | 10000 | 26 |
| PS 90 WJ 500 | 72525 | 1/4" x 1" 1-NAIL WHITE | 500 JAR | 5000 | 13 |



LOW VOLTAGE INSULATED STAPLES

Low Voltage Staples For Use With Bell, Speaker, Thermostat And Telephone Wire
All Sizes: Standard Package 1000 Staples; Approximate Weight 2 Pounds/1000

| CATALOG NUMBER | UPC # 780227 | UNIT QUANTITY | SIZE | DIMENSIONS WIDTH x LENGTH | FINISH |
|----------------|-----------------|---------------|------|------------------------------|----------|
| #1 COPPER 100 | 71137 | 100 | # 1 | 3/16" x 1/2" | COPPERED |
| #3 COPPER 100 | 71337 | 100 | # 3 | 3/16" x 3/4" | COPPERED |
| #5 BROWN 40 | 71512 | 40 | # 5 | 1/4" x 5/8" | BROWN |
| #5 COPPER 100 | 71537 | 100 | # 5 | 1/4" x 5/8" | COPPERED |
| #5 WHITE 40 | 71516 | 40 | # 5 | 1/4" x 5/8" | WHITE |
| #6 COPPER 100 | 71637 | 100 | # 6 | 1/4" x 3/4" | COPPERED |
| #7 COPPER 100 | 71737 | 100 | # 7 | 1/4" x 7/8" | COPPERED |

LOW VOLTAGE PLASTIC STAPLES

Low Voltage Staples For Use With Bell, Speaker, Thermostat And Telephone Wire
Zinc Plated Nail Resists Rust And Corrosion



| CATALOG NUMBER | UPC # 780227 | DESCRIPTION WIDTH x LENGTH | UNIT QUANTITY | MASTER CARTON | MASTER WEIGHT |
|----------------|-----------------|-------------------------------|---------------|---------------|---------------|
| PS 80 W 100 | 72541 | 3/16" x 1" 1-NAIL WHITE | 100 | 10000 | 26 |
| PS 80 B 100 | 72531 | 3/16" x 1" 1-NAIL BLACK | 100 | 10000 | 26 |

SERVICE ENTRANCE KITS

Conveniently Packed For Fast Counter Service
Die Cast Or Plastic Weather Cap

SE 1 100 AMP

For 2/3 SEU Cable

CATALOG NUMBER: SE 1
UPC# 78022743950
MASTER CARTON: 10 KITS
MASTER WEIGHT: 13 lbs.

KIT CONTAINS:

- 1 #100 PLASTIC WEATHER CAP
- 10 4S2A CABLE STRAPS
- 1 WC 1252 1-1/4" WT CONNECTOR
- 2 125 SM 1-1/4" CONNECTORS
- 1 SP 28 SILL PLATE



SE 2 200 AMP

For 4/0 SEU Cable

CATALOG NUMBER: SE 2
UPC# 78022743960
MASTER CARTON: 10 KITS
MASTER WEIGHT: 35 lbs.

KIT CONTAINS:

- 1 #200 PLASTIC WEATHER CAP
- 10 4S0 2 CABLE STRAPS
- 1 WC 2004 2" WT CONNECTOR
- 2 200 SM 2" CONNECTORS
- 1 SP 40 SILL PLATE

SE 1 D 100 AMP

For 2/3 SEU Cable

CATALOG NUMBER: SE 1 D
UPC# 78022743955
MASTER CARTON: 10 KITS
MASTER WEIGHT: 13 lbs.

KIT CONTAINS:

- 1 DC 100 DIE CAST WEATHER CAP
- 10 4S2A CABLE STRAPS
- 1 WC 1252 1-1/4" WT CONNECTOR
- 2 125 SM 1-1/4" CONNECTORS
- 1 SP 28 SILL PLATE

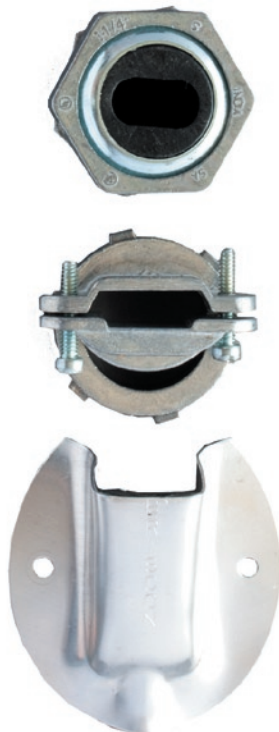

SE 2 D 200 AMP

For 4/0 SEU Cable

CATALOG NUMBER: SE 2 D
UPC# 78022743965
MASTER CARTON: 10 KITS
MASTER WEIGHT: 35 lbs.

KIT CONTAINS:

- 1 DC 200 DIE CAST WEATHER CAP
- 10 4S0 2 CABLE STRAPS
- 1 WC 2004 2" WT CONNECTOR
- 2 200 SM 2" CONNECTORS
- 1 SP 40 SILL PLATE

SE 1

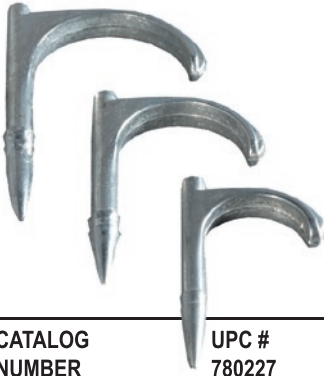

DRIVE STRAPS

Pressure Cast Zinc Drive Strap

| CATALOG NUMBER | UPC # 780227 | EMT SIZE | RIGID SIZE | A | B | C | UNIT QUANTITY | MASTER CARTON | MASTER WEIGHT |
|----------------|-----------------|----------|------------|--------|------|--------|---------------|---------------|---------------|
| T5 100 | 35801 | 1/2" | 3/8" | 3/4" | 3/8" | 1-3/4" | 100 | 2000 | 35 |
| T7 100 | 35802 | 3/4" | 1/2" | 1" | 1/2" | 2" | 100 | 2000 | 44 |
| T10 100 | 35803 | 1" | 3/4" | 1-1/4" | 5/8" | 2-1/2" | 100 | 1000 | 30 |

A = INSIDE WIDTH
B = INSIDE HEIGHT
C = NAIL LENGTH

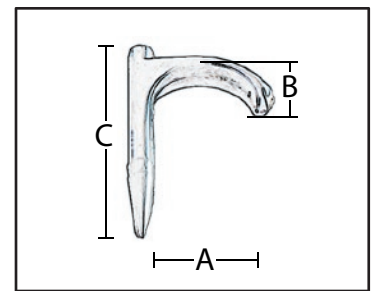

PLASTIC CONDUIT STRAPS

Grey Plastic 2-Hole Strap

| CATALOG NUMBER | UPC # 780227 | SIZE | A | B | C | UNIT QUANTITY | MASTER CARTON | MASTER WEIGHT |
|----------------|-----------------|--------|---------|---------|------|---------------|---------------|---------------|
| PS 5 50 | 41700 | 1/2" | 7/8" | 7/8" | 1/4" | 50 | 500 | 5 |
| PS 7 50 | 41710 | 3/4" | 1" | 1" | 1/4" | 50 | 500 | 6 |
| PS 10 50 | 41715 | 1" | 1-3/16" | 1-3/16" | 1/4" | 50 | 500 | 8 |
| PS 12 25 | 41720 | 1-1/4" | 1-5/8" | 1-5/8" | 1/4" | 25 | 250 | 5 |
| PS 15 25 | 41725 | 1-1/2" | 1-7/8" | 1-7/8" | 1/4" | 25 | 250 | 7 |
| PS 20 10 | 41730 | 2" | 2-3/8" | 2-3/8" | 1/4" | 10 | 100 | 5 |
| PS 25 5 | 41731 | 2-1/2" | 3" | 3" | 3/8" | 5 | 50 | 5 |
| PS 30 | 41732 | 3" | 3-1/2" | 3-1/2" | 3/8" | 1 | 25 | 3 |
| PS 40 | 41734 | 4" | 4-1/2" | 4-1/2" | 3/8" | 1 | 25 | 3 |

A = INSIDE WIDTH
B = INSIDE HEIGHT
C = HOLE DIAMETER

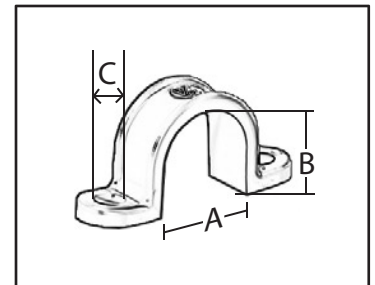

#1 IN FASTENING THE POWER



THIN WALL CONDUIT STRAPS

Galvanized Steel 1-Hole EMT Strap, Snap On Type

| CATALOG NUMBER | UPC # 780227 | SIZE | A | B | C | UNIT QUANTITY | MASTER CARTON | MASTER WEIGHT |
|----------------|--------------|--------|--------|--------|-------|---------------|---------------|---------------|
| TW 5 100 | 31601 | 1/2" | 3/4" | 3/4" | 1/4" | 100 | 1000 | 30 |
| TW 7 100 | 31602 | 3/4" | 7/8" | 7/8" | 1/4" | 100 | 1000 | 37 |
| TW 10 50 | 31603 | 1" | 1-1/8" | 1-1/8" | 1/4" | 50 | 500 | 25 |
| TW 12 20 | 31604 | 1-1/4" | 1-1/2" | 1-1/4" | 1/4" | 20 | 200 | 19 |
| TW 15 20 | 31605 | 1-1/2" | 1-3/4" | 1-5/8" | 5/16" | 20 | 200 | 33 |
| TW 20 10 | 31606 | 2" | 2-1/8" | 1-7/8" | 3/8" | 10 | 100 | 17 |

A = INSIDE WIDTH
B = INSIDE HEIGHT
C = HOLE DIAMETER

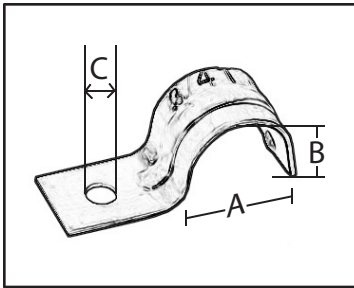

FOLD OVER STRAPS

Aluminum 1-Hole Strap. Fast And Easy Installation For Service Entrance Cable

| CATALOG NUMBER | UPC # 780227 | CABLE SIZE | A | B | C | UNIT QUANTITY | MASTER CARTON | MASTER WEIGHT |
|----------------|--------------|------------|--------|------|------|---------------|---------------|---------------|
| SC 15 100 | 43902 | 8/3 & 6/3 | 3/4" | 1/2" | 1/4" | 100 | 1000 | 12 |
| SC 20 100 | 43903 | 4/3 | 7/8" | 1/2" | 1/4" | 100 | 1000 | 13 |
| SC 25 100 | 43905 | 2/3 | 1" | 5/8" | 1/4" | 100 | 1000 | 17 |
| SC 35 50 | 43907 | 2/0 | 1-3/8" | 3/4" | 1/4" | 50 | 500 | 15 |
| SC 40 50 | 43909 | 4/0 | 1-1/2" | 3/4" | 1/4" | 50 | 500 | 15 |

A = INSIDE WIDTH
B = INSIDE HEIGHT
C = HOLE DIAMETER

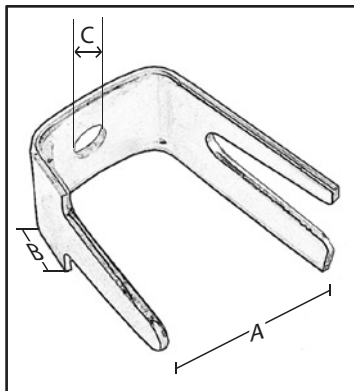

#1 IN FASTENING THE POWER



SERVICE ENTRANCE CABLE STRAPS

| CATALOG NUMBER | UPC # 780227 | MATERIAL | # HOLES | CABLE SIZE | A | B | C | UNIT QTY | MASTER CARTON | MASTER WEIGHT |
|----------------|--------------|------------------|---------|------------|--------|--------|-------|----------|---------------|---------------|
| 6S1 100 | 41503 | GALVANIZED STEEL | 1 | 4/3 & 6/3 | 7/8" | 1/2" | 7/32" | 100 | 1000 | 17 |
| 4S1 100 | 41505 | GALVANIZED STEEL | 1 | 2/3 | 1" | 5/8" | 1/4" | 100 | 1000 | 34 |
| 1S0 50 | 41506 | GALVANIZED STEEL | 1 | 1/0 | 1-1/4" | 3/4" | 5/16" | 50 | 500 | 30 |
| 2S0 50 | 41507 | GALVANIZED STEEL | 1 | 2/0 | 1-3/8" | 3/4" | 5/16" | 50 | 500 | 32 |
| 4S0 50 | 41509 | GALVANIZED STEEL | 1 | 4/0 | 1-5/8" | 3/4" | 5/16" | 50 | 500 | 32 |
| 6S2 100 | 41603 | GALVANIZED STEEL | 2 | 4/3 & 6/3 | 7/8" | 1/2" | 7/32" | 100 | 1000 | 26 |
| 4S2 100 | 41605 | GALVANIZED STEEL | 2 | 2/3 | 1" | 5/8" | 7/32" | 100 | 1000 | 27 |
| 4S2A 100 | 41608 | ALUMINUM | 2 | 2/3 | 1" | 5/8" | 7/32" | 100 | 1000 | 11 |
| 1S0 2 50 | 43606 | ALUMINUM | 2 | 1/0 | 1-1/4" | 11/16" | 1/4" | 50 | 500 | 12 |
| 2S0 2 50 | 43607 | ALUMINUM | 2 | 2/0 | 1-3/8" | 3/4" | 1/4" | 50 | 500 | 12 |
| 4S0 2 50 | 43609 | ALUMINUM | 2 | 4/0 | 1-1/2" | 3/4" | 1/4" | 50 | 500 | 13 |

A = INSIDE WIDTH
 B = INSIDE HEIGHT
 C = HOLE DIAMETER

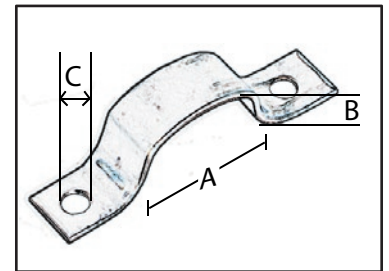

SERVICE ENTRANCE ROUND CABLE STRAPS

Aluminum 2-Hole Strap

| CATALOG NUMBER | UPC # 780227 | CABLE SIZE | A | B | C | UNIT QUANTITY | MASTER CARTON | MASTER WEIGHT |
|----------------|--------------|------------|--------|--------|------|---------------|---------------|---------------|
| 5S0 2 50 | 43608 | 2/3 SER | 15/16" | 15/16" | 1/4" | 50 | 500 | 11 |
| 6S0 2 25 | 43612 | 4/0 SER | 1-1/2" | 1-1/2" | 1/4" | 25 | 250 | 9 |

A = INSIDE WIDTH
 B = INSIDE HEIGHT
 C = HOLE DIAMETER

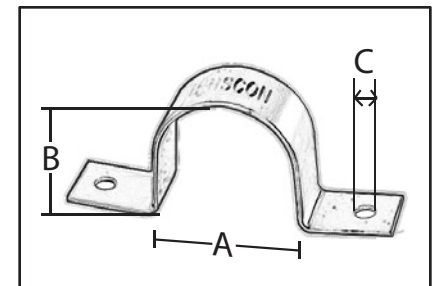

#1 IN FASTENING THE POWER



MIDGET STRAPS

Galvanized Steel 1-Hole Strap

| CATALOG NUMBER | UPC # | CABLE SIZE | A | B | C | UNIT QTY | MASTER CARTON | MASTER WEIGHT |
|----------------|-------|----------------------------------|------|------|-------|----------|---------------|---------------|
| M 25 100 | 69124 | 1/4" TUBING, #6 & #4 GROUND WIRE | 3/8" | 1/4" | 3/16" | 100 | 2000 | 18 |
| M 30 100 | 69123 | 14/2 TO 12/2 UF & NM SHEATHED | 1/2" | 1/4" | 3/16" | 100 | 2000 | 23 |
| M 50 100 | 69125 | 14/2 TO 10/3 MC | 5/8" | 1/2" | 3/16" | 100 | 2000 | 31 |

A = INSIDE WIDTH
 B = INSIDE HEIGHT
 C = HOLE DIAMETER

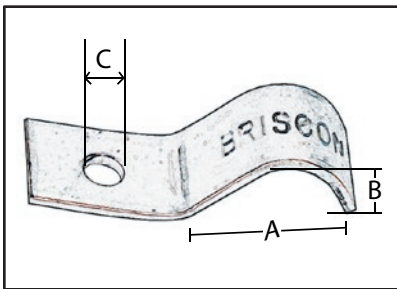



NON-WATERTIGHT CONNECTORS

Non-metallic And Service Entrance Cable; Oval Or Round
Zinc Die Cast 2-Screw Clamp Type

| CATALOG NUMBER | UPC # 780227 | SIZE | CABLE SIZE | KNOCKOUT SIZE | UNIT QUANTITY | MASTER CARTON | MASTER WEIGHT |
|----------------|-----------------|--------|-------------|---------------|---------------|---------------|---------------|
| 75 SM/SMR 25 | 45602 | 3/4" | 6/3 SEU/SER | 3/4" | 25 | 250 | 21 |
| 100 SM 25 | 45503 | 1" | 4/3 SEU | 1" | 25 | 250 | 38 |
| 100 SMR 25 | 45603 | 1" | 4/3 SER | 1" | 25 | 250 | 37 |
| 125 SM 10 | 45504 | 1-1/4" | 2/3 SEU | 1-1/4" | 10 | 100 | 25 |
| 125 SMR 10 | 45604 | 1-1/4" | 2/3 SER | 1-1/4" | 10 | 100 | 19 |
| 150 SM 10 | 45505 | 1-1/2" | 2/0 SEU | 1-1/2" | 10 | 100 | 33 |
| 150 SMR 10 | 45605 | 1-1/2" | 2/0 SER | 1-1/2" | 10 | 100 | 30 |
| 200 SM 5 | 45506 | 2" | 4/0 SEU | 2" | 5 | 50 | 28 |
| 200 SMR 5 | 45606 | 2" | 4/0 SER | 2" | 5 | 50 | 21 |



WATERTIGHT CONNECTORS

Service Entrance Cable

| CATALOG NUMBER | UPC # 780227 | SIZE | CABLE SIZE | GROMMET OPENING | | UNIT QUANTITY | MASTER CARTON | MASTER WEIGHT |
|----------------|-----------------|--------|------------|-----------------|---------------|---------------|---------------|---------------|
| | | | | MINIMUM | MAXIMUM | | | |
| WC 1006 15 | 45702 | 1" | 6/3 SEU | 0.32" x 0.50" | 0.40" x 0.63" | 15 | 150 | 35 |
| WC 1004 15 | 45703 | 1" | 4/3 SEU | 0.40" x 0.71" | 0.50" x 0.77" | 15 | 150 | 35 |
| WC 1252 15 | 45705 | 1-1/4" | 2/3 SEU | 0.51" x 0.93" | 0.59" x 0.98" | 15 | 150 | 60 |
| WC 1252N 15 | 45715 | 1-1/4" | 2/3 SEU | 0.57" x 1.05" | 0.65" x 1.09" | 15 | 150 | 60 |
| WC 1502 6 | 45707 | 1-1/2" | 2/0 SEU | 0.70" x 1.20" | 0.86" x 1.34" | 6 | 60 | 40 |
| WC 1503 6 | 45708 | 1-1/2" | 3/0 SEU | 0.75" x 1.30" | 0.87" x 1.37" | 6 | 60 | 40 |
| WC 2002 6 | 45717 | 2" | 2/0 SEU | 0.70" x 1.20" | 0.86" x 1.34" | 6 | 60 | 55 |
| WC 2003 6 | 45718 | 2" | 3/0 SEU | 0.75" x 1.30" | 0.87" x 1.37" | 6 | 60 | 55 |
| WC 2004 6 | 45709 | 2" | 4/0 SEU | 0.84" x 1.43" | 0.90" x 1.50" | 6 | 60 | 55 |

CABLE CONNECTORS

2 NC

Zinc Die Cast, 2-Screw Clamp Type, For (2) 14/2 Through (1) 10/2 Non-metallic Sheathed

| CATALOG NUMBER | UPC # | SIZE | KNOCKOUT SIZE | UNIT QUANTITY | MASTER CARTON | MASTER WEIGHT |
|----------------|-------|------|---------------|---------------|---------------|---------------|
| 2 NC 100 | 45111 | 3/8" | 1/2" | 100 | 1000 | 47 |



1 AC

Zinc Die Cast, 1 Set Screw Type, For 3/8" Flex And Metal Clad Cable

| CATALOG NUMBER | UPC # | SIZE | KNOCKOUT SIZE | UNIT QUANTITY | MASTER CARTON | MASTER WEIGHT |
|----------------|-------|------|---------------|---------------|---------------|---------------|
| 1 AC 100 | 45311 | 3/8" | 1/2" | 100 | 1000 | 45 |



90 M

Zinc Die Cast, 90° Angle, 2-Screw Clamp Type, For 3/8" Flex And Metal Clad Cable

| CATALOG NUMBER | UPC # | SIZE | KNOCKOUT SIZE | UNIT QUANTITY | MASTER CARTON | MASTER WEIGHT |
|----------------|-------|------|---------------|---------------|---------------|---------------|
| 90 M 25 | 45191 | 3/8" | 1/2" | 25 | 250 | 23 |



2 BX

Zinc Die Cast, 1-Screw Saddle Type, For 3/8" Flex And Metal Clad Cable

| CATALOG NUMBER | UPC # | SIZE | KNOCKOUT SIZE | UNIT QUANTITY | MASTER CARTON | MASTER WEIGHT |
|----------------|-------|------|---------------|---------------|---------------|---------------|
| 2 BX 50 | 45123 | 3/8" | 1/2" | 50 | 500 | 36 |



25 SM

Zinc Die Cast, Set Screw Type
Combination Coupling For EMT To Flex And Metal Clad Cable

| CATALOG NUMBER | UPC # | SIZE | UNIT QUANTITY | MASTER CARTON | MASTER WEIGHT |
|----------------|-------|------|---------------|---------------|---------------|
| 25 SM 25 | 87760 | 3/8" | 25 | 250 | 17 |



50 SM

Zinc Die Cast, Duplex Connector 1-Screw Clamp Type
For Non-metallic, Flex And Metal Clad Cable

| CATALOG NUMBER | UPC # | SIZE | KNOCKOUT SIZE | UNIT QUANTITY | MASTER CARTON | MASTER WEIGHT |
|----------------|-------|------|---------------|---------------|---------------|---------------|
| 50 SM 25 | 87765 | 3/8" | 1/2" | 25 | 250 | 28 |



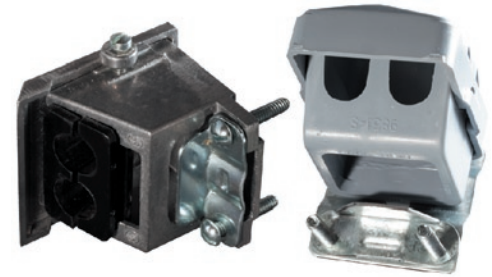

WEATHER CAPS Service Entrance Cable

Plastic Cap With Galvanized Steel Bracket And Clamp

| CATALOG NUMBER | UPC # | CABLE SIZE | UNIT QUANTITY | MASTER CARTON | MASTER WEIGHT |
|----------------|-------|------------|---------------|---------------|---------------|
| # 100 6 | 47905 | 2/3 | 6 | 60 | 15 |
| # 150 25 | 47907 | 2/0 | 1 | 25 | 13 |
| # 200 25 | 47909 | 4/0 | 1 | 25 | 12 |

Aluminum Die Cast Cap With Galvanized Steel Clamp

| CATALOG NUMBER | UPC # | CABLE SIZE | UNIT QUANTITY | MASTER CARTON | MASTER WEIGHT |
|----------------|-------|-----------------|---------------|---------------|---------------|
| DC 100 5 | 66100 | 8/3 THROUGH 2/3 | 5 | 50 | 14 |
| DC 200 25 | 66200 | 1/0 THROUGH 4/0 | 1 | 25 | 24 |

Rigid Conduit And EMT

A Sleeve Is Furnished With Each Cap For Adaptation To EMT

| CATALOG NUMBER | UPC # | CONDUIT SIZE | UNIT QUANTITY | MASTER CARTON | MASTER WEIGHT |
|----------------|-------|--------------|---------------|---------------|---------------|
| 5 WC | 27701 | 1/2" | 1 | 20 | 3 |
| 7 WC | 27702 | 3/4" | 1 | 20 | 4 |
| 10 WC | 27703 | 1" | 1 | 10 | 2 |
| 12 WC | 27704 | 1-1/4" | 1 | 10 | 3 |
| 15 WC | 27705 | 1-1/2" | 1 | 5 | 2 |
| 20 WC | 27706 | 2" | 1 | 5 | 5 |





SP 28

SILL PLATES

Complete With Duct Seal Compound And Zinc Plated Combination Head Screws

| CATALOG NUMBER | UPC # 780227 | MATERIAL | SEU CABLE SIZE | UNIT QUANTITY | MASTER CARTON | MASTER WEIGHT |
|----------------|-----------------|---------------|----------------|---------------|---------------|---------------|
| SP 46 10 | 42903 | ALUMINUM | 4/3 & 6/3 | 10 | 100 | 10 |
| SP 28 10 | 42905 | ALUMINUM | 2/3 & 3/3 | 10 | 100 | 10 |
| SP 28P 10 | 42908 | PLASTIC | 2/3 & 3/3 | 10 | 100 | 10 |
| SP 40 25 | 42909 | CAST ALUMINUM | 2/0 & 4/0 | 1 | 25 | 22 |



SP 40

FISH WIRE

Finest Quality

Flat, Oil Tempered Spring Steel, Flexible And Easy To Fish

0.125" Wide x 0.060" Thick

Individually Bagged 10 Bags Per Master Carton

FW 25 Bulk Packed; 25 Coils Per Carton

| CATALOG NUMBER | UPC # 780227 | LENGTH | MASTER WEIGHT |
|----------------|-----------------|--------|---------------|
| FW 25 | 85711 | 25' | 16 |
| FW 50 | 85721 | 50' | 13 |
| FW 100 | 85731 | 100' | 26 |
| FW 200 | 85741 | 200' | 52 |



#1 IN FASTENING THE POWER



BOX SUPPORTS

Galvanized Steel

| CATALOG NUMBER | UPC # | DIMENSIONS | | | UNIT QUANTITY | MASTER CARTON | MASTER WEIGHT |
|------------------------|-------|------------|--------|--------|------------------|--------------------|---------------|
| | | A | B | C | | | |
| BS 1 100 STANDARD | 75070 | 5-1/4" | 2-1/8" | 1-1/2" | 100 (50) PAIR | 1000 (500) PAIR | 22 |
| BS 2 100 EXTRA LONG | 75072 | 5-1/4" | 3" | 2-1/4" | 100 (50) PAIR | 1000 (500) PAIR | 33 |

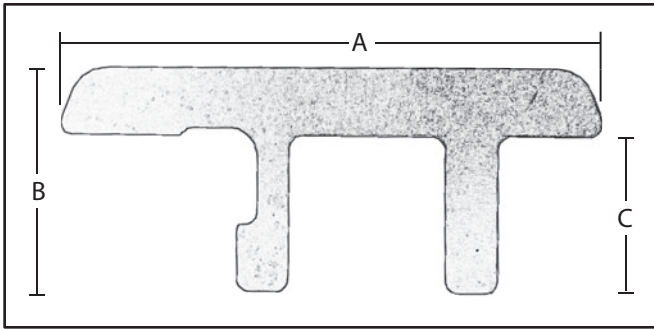

STUD SAFETY PLATES

16 Gauge Steel

| CATALOG NUMBER | UPC # | DIMENSIONS WIDTH x LENGTH | UNIT QUANTITY | MASTER CARTON | MASTER WEIGHT |
|------------------------|-------|------------------------------|---------------|---------------|---------------|
| | | | | | |
| SSP 2 50 EXTRA LONG | 85737 | 1-5/8" x 5" | 50 | 200 | 27 |

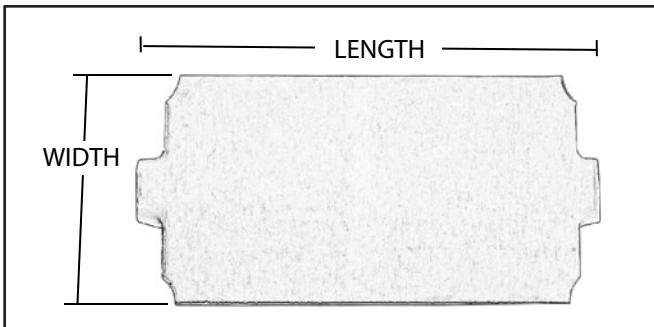



WIRE CONNECTORS

Color Coded For Easy Identification
Wire Spring Insert For Secure Connections

Three Sizes For Combinations From #10 Through #18 AWG
Rated At 600 Volts, Fixtures And Signs 1000 Volts
Temperature Rated At 105°C

| CATALOG NUMBER | UPC # | SIZE | COLOR | UNIT QUANTITY | MASTER CARTON | MASTER WEIGHT |
|----------------|-------|--------|--------|---------------|---------------|---------------|
| SWC 100 | 69111 | SMALL | ORANGE | 100 | 5000 | 12 |
| MWC 100 | 69121 | MEDIUM | YELLOW | 100 | 5000 | 18 |
| LWC 100 | 69131 | LARGE | RED | 100 | 2000 | 17 |

CLAMSHELLS

Briscon Quality And Name Recognition, Clamshells For Retail And Counter Sales,
Convenient Packaging For Both The Customer And Sales Person

Packaged 100 Clamshells Per Master Case

| CATALOG NUMBER | UPC # 780227 | DESCRIPTION WIDTH x LENGTH | PARTS PER PACKAGE | MASTER WEIGHT |
|----------------|-----------------|--|-------------------|---------------|
| SN 40 B 25 | 72401 | 1/2" x 1" ZINC PLATED STAPLE | 25 | 15 |
| SN 40 IB 20 | 71930 | 1/2" x 1" ZINC PLATED INSULATED STAPLE | 20 | 15 |
| SN 150 B 15 | 75036 | 1/2" x 1-1/2" ZINC PLATED STAPLE | 15 | 17 |
| SN 150 IB 10 | 75032 | 1/2" x 1-1/2" ZINC PLATED STAPLE | 10 | 19 |
| SN 100 B 15 | 72990 | 9/16" x 1-1/4" ZINC PLATED STAPLE | 15 | 14 |
| SN 100 IB 15 | 72611 | 9/16" x 1-1/4" ZINC PLATED INSULATED STAPLE | 15 | 15 |
| SN 300 B 10 | 73304 | 13/16" x 1-3/8" ZINC PLATED STAPLE | 10 | 16 |
| SN 300 IB 10 | 73306 | 13/16" x 1-3/8" ZINC PLATED INSULATED STAPLE | 10 | 19 |
| SN 350 B 10 | 73352 | 1-1/16" x 1-7/16" ZINC PLATED STAPLE | 10 | 19 |
| SN 350 IB 5 | 73357 | 1-1/16" x 1-7/16" ZINC PLATED INSULATED STAPLE | 5 | 14 |
| PS 50 20 | 72510 | 1/2" 2-NAIL PLASTIC STAPLE | 20 | 15 |
| PS 75 15 | 72515 | 3/4" 2-NAIL PLASTIC STAPLE | 15 | 13 |
| CX 90 20 | 75053 | 1/2" x 1" ZINC PLATED COAXIAL STAPLE | 20 | 19 |
| PS 90 B 25 | 72520 | 1-NAIL COAXIAL 1/4" BLACK PLASTIC STAPLE | 25 | 9 |
| PS 90 W 25 | 72521 | 1-NAIL COAXIAL 1/4" WHITE PLASTIC STAPLE | 25 | 9 |
| PS 80 B 25 | 72530 | 3/16" x 1" 1-NAIL BLACK LOW VOLTAGE PLASTIC STAPLE | 25 | 9 |
| PS 80 B 100 | 72531 | 3/16" x 1" 1-NAIL BLACK LOW VOLTAGE PLASTIC STAPLE | 100 | 26 |
| PS 80 W 25 | 72540 | 3/16" x 1" 1-NAIL WHITE LOW VOLTAGE PLASTIC STAPLE | 25 | 9 |
| PS 80 W 100 | 72541 | 3/16" x 1" 1-NAIL WHITE LOW VOLTAGE PLASTIC STAPLE | 100 | 26 |
| #5 BROWN 40 BP | 71512 | 1/4" x 5/8" BROWN LOW VOLTAGE INSULATED STAPLE | 40 | 11 |
| #5 WHITE 40 BP | 71516 | 1/4" x 5/8" WHITE LOW VOLTAGE INSULATED STAPLE | 40 | 11 |

STAINLESS STEEL CLAMSHELLS

For Use On Pressure Treated Lumber And Exterior Applications

Packaged 100 Clamshells Per Master Case

| CATALOG NUMBER | UPC # | DESCRIPTION WIDTH x LENGTH | PARTS PER PACKAGE | MASTER WEIGHT |
|-----------------|-------|--|-------------------|---------------|
| SN 40 B SS 25 | 10036 | 1/2" x 1" STAINLESS STEEL STAPLE | 25 | 15 |
| SN 40 IB SS 20 | 10031 | 1/2" x 1" STAINLESS STEEL INSULATED STAPLE | 20 | 15 |
| SN 100 B SS 15 | 71988 | 9/16" x 1-1/4" STAINLESS STEEL STAPLE | 15 | 14 |
| SN 100 IB SS 15 | 72616 | 9/16" x 1-1/4" STAINLESS STEEL INSULATED STAPLE | 15 | 15 |
| SN 150 B SS 15 | 75042 | 1/2" x 1-1/2" STAINLESS STEEL STAPLE | 15 | 17 |
| SN 150 IB SS 10 | 75033 | 1/2" x 1-1/2" STAINLESS STEEL INSULATED STAPLE | 10 | 19 |
| SN 300 B SS 10 | 73309 | 13/16" x 1-3/8" STAINLESS STEEL STAPLE | 10 | 16 |
| SN 300 IB SS 10 | 73310 | 13/16" x 1-3/8" STAINLESS STEEL INSULATED STAPLE | 10 | 19 |
| SN 350 B SS 10 | 73358 | 1-1/16" x 1-7/16" STAINLESS STEEL STAPLE | 10 | 19 |
| SN 350 IB SS 5 | 73355 | 1-1/16" x 1-7/16" STAINLESS STEEL INSULATED STAPLE | 5 | 14 |



