

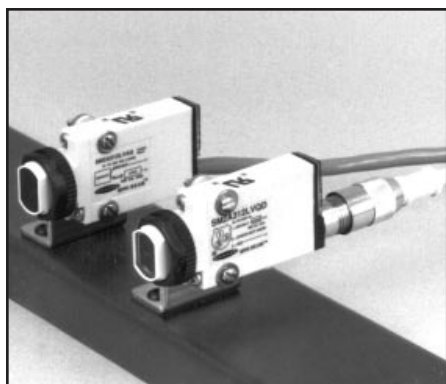

MINI-BEAM[®] SM2A312LV, SM2A312LVAG and SM2A312LP

Self-contained AC-operated Retroreflective Mode Sensors



- Compact, modulated, self-contained retroreflective sensors for 24-240V ac operation
- Choose standard visible model for highest excess gain and greatest range, or polarized models for detection of shiny objects
- Switch-selectable for light-operate or dark operate
- highly repeatable; 4 millisecond response
- SPST SCR solid-state output switches up to 300 mA; low leakage current and saturation voltage
- Physically and electrically interchangeable with 18 mm barrel-type photoelectrics

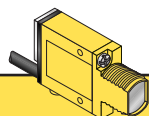

AC MINI-BEAM Retroreflective Mode

Models	Range	Cable	Supply Voltage	Output Type	Excess Gain	Beam Pattern
Non-Polarized						
SM2A312LV SM2A312LVQD	5 m (15 ft)	2 m (6.5 ft) 3-Pin Micro QD	24-240V ac	SPST Solid-state 2-Wire		
Polarized						
SM2A312LVAG SM2A312LVAGQD	50 mm to 2 m (2 in to 7 ft)	2 m (6.5 ft) 3-Pin Micro QD	24-240V ac	SPST Solid-state 2-Wire		
Extended Range Polarized*						
SM2A312LP SM2A312LPQD	10 mm to 3 m (0.4 in to 10 ft)	2 m (6.5 ft) 3-Pin Micro QD	24-240V ac	SPST Solid-state 2-Wire		

Note: May not perform with some non-Banner retroreflective targets.

MINI-BEAM Installation and Alignment

Proper operation of these sensors requires that they be mounted securely and aligned properly. For best results, final-mount these sensors in an 18 mm hole by their threaded barrel or use one of the available mounting brackets, (see pages 6 - 7).

- 1) Begin with the sensor at the desired distance from the retro target and at the approximate position where it will be mounted. An object at the sensing position should pass through the “core” of the sensor’s light beam.
- 2) *Switch the sensor to light-operate mode (see Note, below).* Apply power to the sensor, and advance the sensor’s 15-turn GAIN control to maximum (clockwise end of rotation). If the sensor is “seeing” the reflected light beam, the alignment LED should be “on”. Move the sensor up-down-right-left to find the center of the movement zone within which the LED indicator remains lit. (Alternatively, the retro target may be moved.) Reducing the GAIN setting (if necessary) will reduce the size of the movement zone and make more precise alignment possible.
- 3) Repeat the alignment motions after each GAIN reduction. When you are satisfied that you have obtained optimum alignment, mount the sensor (or reflector) solidly in that position. Increase the receiver GAIN to maximum. Test the system by placing the object to be detected into the sensing position. The LED indicator should go “off”. (If it does, alignment is complete, and you may now switch the sensor to dark-operate if the application requires it.) If the LED of an “LV” model sensor does not go “off”, the sensor is reacting to light reflected from the object (called “proxing”).

If proxing occurs, reduce the GAIN setting until the alignment indicator goes “off”, plus two additional full turns. Remove the object from the sensing position and check that the alignment indicator LED comes “on.” Confirm that the LED goes “off” when the object is replaced.

Proxing can be avoided by mounting the sensor so that its light beam is not perpendicular to any flat reflective surface on the object to be detected (an angle of 10 to 15 degrees is usually sufficient). Also, at distances of a few feet or more, using more than one reflector may increase sensing contrast between object-present and object-absent.

Retroreflective Mode Alignment

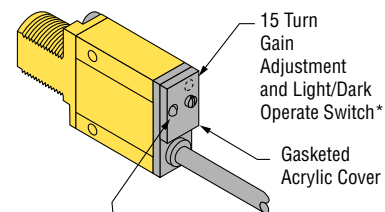
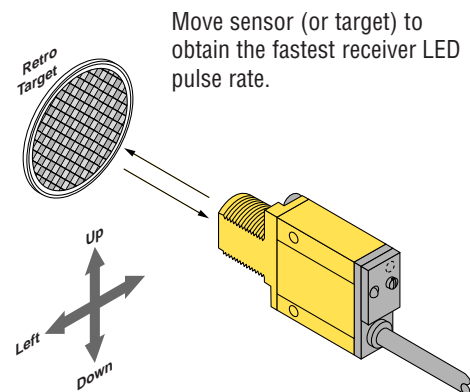

Alignment indicator LED lights when the sensor’s output is conducting.

* Note regarding Light/Dark operate switch:

- Turn switch *fully* clockwise for light operate (sensor outputs conduct when object is absent)
- Turn switch *fully* counterclockwise for dark operate (sensor outputs conduct when object is present)

MINI-BEAM[®] Sensors SM2A312LV, SM2A312LVAG and SM2A312LP

AC MINI-BEAM Product Specifications	
Supply Voltage and Current	24 to 240V ac (50 to 60 Hz); 250V ac max.
Output Configuration	SPST SCR solid-state relay with either normally closed or normally open contact (light/dark operate selectable); 2-wire hookup
Output Rating	Minimum load current 5 mA; maximum steady-state load capability 300 mA to 50° C ambient (122° F), 100 mA to 70° C ambient (158° F) Inrush Capability 3 amps for 1 second (non-repetitive); 10 amps for 1 cycle (non-repetitive). Off State Leakage Current less than 1.7mA rms On State Voltage Drop ≤5 volts at 300 mA load, ≤10 volts at 15 mA load.
Output Protection Circuitry	Protected against false pulse on power-up and inductive load transients.
Output Response Time	4 milliseconds “on” and “off.” “Off” response time does not include load response time of up to 1/2 ac cycle (8.3 milliseconds). Response time specification of load should be considered when important. (300 millisecond delay on power-up).
Repeatability	1.3 milliseconds. Response time and repeatability specifications are independent of signal strength.
Adjustments	LIGHT/DARK OPERATE select switch, and 15-turn slotted brass screw GAIN (sensitivity) adjustment potentiometer (clutched at both ends of travel). Both controls are located on rear panel of sensor and protected by a gasketed, clear acrylic cover.
Indicators	Red indicator LED on rear of sensor is “ON” when the load is energized
Construction	Reinforced VALOX [®] housing, totally encapsulated, o-ring sealing, acrylic lenses, and stainless steel screws.
Environmental Rating	Meets NEMA standards 1, 2, 3, 3S, 4, 4X, 12, and 13; IEC IP66
Connections	PVC-jacketed 2-conductor 2 m (6.5ft) or 9 m (30ft) cables, or 3-pin micro-style quick disconnect (QD) fitting are available. QD cables are ordered separately. See page 8.
Operating Temperature	Temperature: -20 to +70° C (-4 to +158° F) Maximum relative humidity: 90% at 50° C (non-condensing)
Application Notes	i) ac MINI-BEAMs may be destroyed from overload conditions ii) Use on low voltage requires careful analysis of the load to determine if the leakage current or on-state voltage of the sensor will interfere with proper operation of the load iii) The false-pulse protection feature may cause momentary drop-out of the load when the sensor is wired in series or parallel with mechanical switch contacts
Certifications	

VALOX[®] is a registered trademark of General Electric Company

For MINI-BEAM:

- i) 9 m (30 ft) cables are available by adding suffix “W/30” to the model number of any cabled sensor (e.g. - SM2A312LP W/30)
- ii) A 150 mm (6 in) long pigtail cable with attached QD connector is available by adding suffix “QDP” to the model number (e.g. - SM2A312LPQDP).
- iii) A model with a QD connector requires an optional mating cable (see accessories, page 8).

MINI-BEAM AC Hookup Diagrams

AC Sensors with Attached Cable

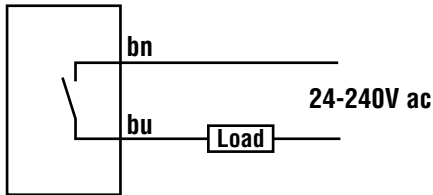

AC Sensors with Quick Disconnect (3-Pin Micro-Style)

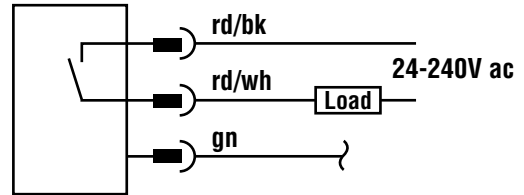

3-Pin Micro-Style Pin-out (Cable Connector Shown)

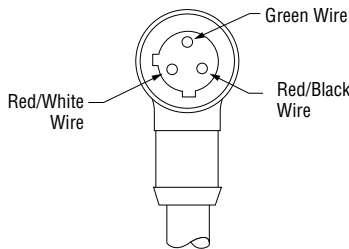

Quick Disconnect (QD) Option

AC MINI-BEAM sensors are sold with either a 2 m (6.5 ft) or a 9 m (30 ft) attached PVC-covered cable, or with a 3-pin micro-style QD cable fitting.

AC QD sensors are identified by the letters “QD” in their model number suffix. Mating cables for QD MINI-BEAM sensors are model MQDC-315 (straight connector) or MQDC-315RA (right-angled connector). Cables are supplied in a standard length of 5 m (15 ft). For more information on QD cables, see page 8.

MINI-BEAM Dimension Information

MINI-BEAM AC Sensor with Integral Cable

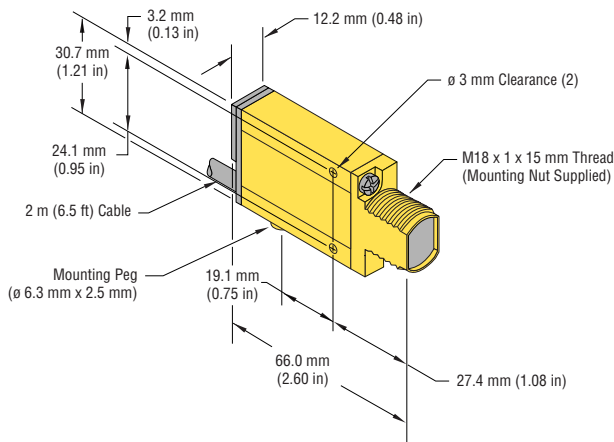

MINI-BEAM AC Sensor with Quick-Disconnect

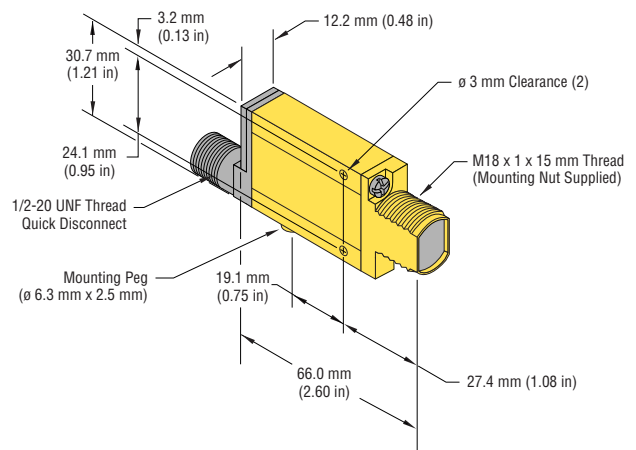

MINI-BEAM® Sensors SM2A312LV, SM2A312LVAG and SM2A312LP

MINI-BEAM MODIFICATIONS			
Model Suffix	Modification	Description	Example of Model Number
W/30	9 meter (30 ft) cable	All MINI-BEAM sensors may be ordered with an integral 9 m (30 ft) cable in place of the standard 2 m (6.5 ft) cable	SM2A312LP W/30
QDP	Pigtail Quick Disconnect	All MINI-BEAMs may be built with a 150 mm (6 in) long integral cable which is terminated with the appropriate QD connector.	SM2A312LPQDP



REPLACEMENT LENS ASSEMBLIES		
MINI-BEAM lens assemblies are field-replaceable.		
Model	Description	
UC-300AG	Replacement lens for LVAG	
UC-300L	Replacement lens for LV	
UC-300LP	Replacement lens for LP	

RETROREFLECTIVE TARGETS

Banner offers a wide selection of high-quality retroreflective targets. See the Banner Photoelectric Sensors Catalog.

MINI-BEAM® Sensors SM2A312LV, SM2A312LVAG and SM2A312LP

Mounting Brackets		
Model	Description	Dimensions
SMB312S	Stainless steel 2-axis, side mounting bracket	
SMB312B	Stainless steel 2-axis, bottom mounting bracket Includes SMB12F (below)	
SMB312F	<ul style="list-style-type: none"> A mounting foot used to attach to bottom surface of any MINI-BEAM sensor to a flat mounting surface Attaches securely beneath the MINI-BEAM sensor's barrel using a special extra-long upper cover mounting screw (supplied) 	

MINI-BEAM® Sensors SM2A312LV, SM2A312LVAG and SM2A312LP

Mounting Brackets		
Model	Description	Dimensions
SMB312PD	<ul style="list-style-type: none"> Stainless steel 18 mm barrel-mounting bracket 	<p>Technical drawing of the SMB312PD mounting bracket. It includes three views: a front view showing a barrel with a 15° and 20° taper, a side view showing a 90° bend, and a top view showing a circular hole. Dimensions are provided in millimeters and inches.</p> <ul style="list-style-type: none"> Front View: R 5.1 mm (0.20 in), R 24.1 mm (0.95 in), 15°, 20°, 31.8 mm (1.25 in), 4.6 mm (0.18 in), 4.6 mm Slot (0.18 in), 2.5 mm (0.10 in), 45.5 mm (1.79 in), 40.6 mm (1.60 in). Top View: 15.2 mm (0.60 in), R 3.1 mm (0.12 in) (2), 18.42 mm (0.725 in).
SMB18C	<ul style="list-style-type: none"> 18 mm split clamp black VALOX® bracket Stainless steel mounting hardware included 	<p>Technical drawing of the SMB18C mounting bracket. It includes a front view and a side view. Dimensions are provided in millimeters and inches. Hardware labels include Nut Plate and M5 x 0.8 x 60 mm Screw (2).</p> <ul style="list-style-type: none"> Front View: 40.0 mm (1.60 in), 42.4 mm (1.67 in), 14.0 mm (0.55 in), 30.0 mm (1.18 in), 21.1 mm (0.83 in), 2.5 mm (0.10 in). Side View: 13 mm (0.5 in).
SMB18S	<ul style="list-style-type: none"> 18 mm swivel, black VALOX® bracket Stainless steel mounting hardware included 	<p>Technical drawing of the SMB18S mounting bracket. It includes a front view and a side view. Dimensions are provided in millimeters and inches. Hardware labels include Spacer (If Required), Nut Plate, and M5 x 0.8 x 60 mm Screw (2).</p> <ul style="list-style-type: none"> Front View: 46.0 mm (1.81 in), 44.5 mm (1.75 in), 13.0 mm (0.50 in), 36.0 mm (1.42 in), 25.4 mm (1.00 in), 2.5 mm (0.10 in). Side View: 10.9 mm (0.43 in), 6.4 mm (0.25 in).

MINI-BEAM® Sensors SM2A312LV, SM2A312LVAG and SM2A312LP

Micro-Style Quick Disconnect Cables

Cable: PVC jacket, polyurethane connector body, chrome-plated brass coupling nut
Conductors: 22 or 20 AWG high-flex stranded, PVC insulation, gold-plated contacts
Temperature: -40 to +80°C (-40 to +176°F)
Voltage Rating: 250V ac/300V dc (3-pin), 125V ac/150V dc (4-pin)



Style	Model	Length	Used with:	Dimensions	Pin-out
3-Pin Straight	MQDC-306 MQDC-315 MQDC-330	2 m (6.5 ft) 5 m (15 ft) 9 m (30 ft)	• MINI-BEAM ac SM2A312 series		
3-Pin Right-angle	MQDC-306RA MQDC-315RA MQDC-330RA	2 m (6.5 ft) 5 m (15 ft) 9 m (30 ft)			



WARRANTY: Banner Engineering Corporation warrants its products to be free from defects for one year. Banner Engineering Corporation will repair or replace, free of charge, any product of its manufacture found to be defective at the time it is returned to the factory during the warranty period. This warranty does not cover damage or liability for the improper application of Banner products. This warranty is in lieu of any other warranty either expressed or implied.



WARNING These photoelectric presence sensors do NOT include the self-checking redundant circuitry necessary to allow their use in personnel safety applications. A sensor failure or malfunction can result in either an energized or a de-energized sensor output condition.

Never use these products as sensing devices for personnel protection. Their use as a safety device may create an unsafe condition which could lead to serious injury or death.

Only MINI-SCREEN®, MULTI-SCREEN®, MICRO-SCREEN™, MACHINE-GUARD and PERIMETER-GUARD Systems, and other systems so designated, are designed to meet OSHA and ANSI machine safety standards for point-of-operation guarding devices. No other Banner sensors or controls are designed to meet these standards, and they must NOT be used as sensing devices for personnel protection.



MINI-BEAM[®] SM2A312LV, SM2A312LVAG and SM2A312LP

Self-contained AC-operated Retroreflective Mode Sensors

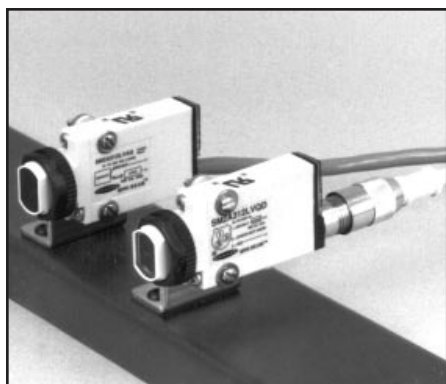

- Compact, modulated, self-contained retroreflective sensors for 24-240V ac operation
- Choose standard visible model for highest excess gain and greatest range, or polarized models for detection of shiny objects
- Switch-selectable for light-operate or dark operate
- highly repeatable; 4 millisecond response
- SPST SCR solid-state output switches up to 300 mA; low leakage current and saturation voltage
- Physically and electrically interchangeable with 18 mm barrel-type photoelectrics

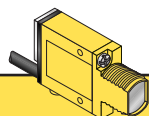

AC MINI-BEAM Retroreflective Mode

Models	Range	Cable	Supply Voltage	Output Type	Excess Gain	Beam Pattern
Non-Polarized						
SM2A312LV SM2A312LVQD	5 m (15 ft)	2 m (6.5 ft) 3-Pin Micro QD	24-240V ac	SPST Solid-state 2-Wire		
Polarized						
SM2A312LVAG SM2A312LVAGQD	50 mm to 2 m (2 in to 7 ft)	2 m (6.5 ft) 3-Pin Micro QD	24-240V ac	SPST Solid-state 2-Wire		
Extended Range Polarized*						
SM2A312LP SM2A312LPQD	10 mm to 3 m (0.4 in to 10 ft)	2 m (6.5 ft) 3-Pin Micro QD	24-240V ac	SPST Solid-state 2-Wire		

Note: May not perform with some non-Banner retroreflective targets.

MINI-BEAM Installation and Alignment

Proper operation of these sensors requires that they be mounted securely and aligned properly. For best results, final-mount these sensors in an 18 mm hole by their threaded barrel or use one of the available mounting brackets, (see pages 6 - 7).

- 1) Begin with the sensor at the desired distance from the retro target and at the approximate position where it will be mounted. An object at the sensing position should pass through the “core” of the sensor’s light beam.
- 2) *Switch the sensor to light-operate mode (see Note, below).* Apply power to the sensor, and advance the sensor’s 15-turn GAIN control to maximum (clockwise end of rotation). If the sensor is “seeing” the reflected light beam, the alignment LED should be “on”. Move the sensor up-down-right-left to find the center of the movement zone within which the LED indicator remains lit. (Alternatively, the retro target may be moved.) Reducing the GAIN setting (if necessary) will reduce the size of the movement zone and make more precise alignment possible.
- 3) Repeat the alignment motions after each GAIN reduction. When you are satisfied that you have obtained optimum alignment, mount the sensor (or reflector) solidly in that position. Increase the receiver GAIN to maximum. Test the system by placing the object to be detected into the sensing position. The LED indicator should go “off”. (If it does, alignment is complete, and you may now switch the sensor to dark-operate if the application requires it.) If the LED of an “LV” model sensor does not go “off”, the sensor is reacting to light reflected from the object (called “proxing”).

If proxing occurs, reduce the GAIN setting until the alignment indicator goes “off”, plus two additional full turns. Remove the object from the sensing position and check that the alignment indicator LED comes “on.” Confirm that the LED goes “off” when the object is replaced.

Proxing can be avoided by mounting the sensor so that its light beam is not perpendicular to any flat reflective surface on the object to be detected (an angle of 10 to 15 degrees is usually sufficient). Also, at distances of a few feet or more, using more than one reflector may increase sensing contrast between object-present and object-absent.

Retroreflective Mode Alignment

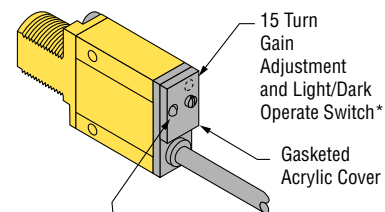
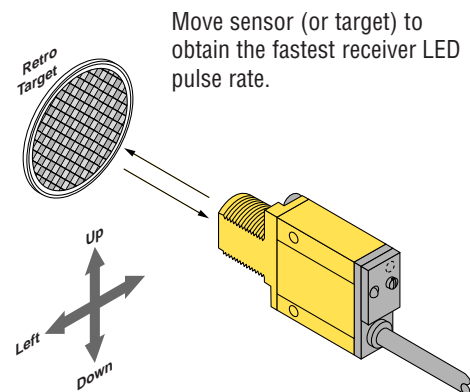

Alignment indicator LED lights when the sensor’s output is conducting.

* Note regarding Light/Dark operate switch:

- Turn switch *fully* clockwise for light operate (sensor outputs conduct when object is absent)
- Turn switch *fully* counterclockwise for dark operate (sensor outputs conduct when object is present)

MINI-BEAM[®] Sensors SM2A312LV, SM2A312LVAG and SM2A312LP

AC MINI-BEAM Product Specifications	
Supply Voltage and Current	24 to 240V ac (50 to 60 Hz); 250V ac max.
Output Configuration	SPST SCR solid-state relay with either normally closed or normally open contact (light/dark operate selectable); 2-wire hookup
Output Rating	Minimum load current 5 mA; maximum steady-state load capability 300 mA to 50° C ambient (122° F), 100 mA to 70° C ambient (158° F) Inrush Capability 3 amps for 1 second (non-repetitive); 10 amps for 1 cycle (non-repetitive). Off State Leakage Current less than 1.7mA rms On State Voltage Drop ≤5 volts at 300 mA load, ≤10 volts at 15 mA load.
Output Protection Circuitry	Protected against false pulse on power-up and inductive load transients.
Output Response Time	4 milliseconds “on” and “off.” “Off” response time does not include load response time of up to 1/2 ac cycle (8.3 milliseconds). Response time specification of load should be considered when important. (300 millisecond delay on power-up).
Repeatability	1.3 milliseconds. Response time and repeatability specifications are independent of signal strength.
Adjustments	LIGHT/DARK OPERATE select switch, and 15-turn slotted brass screw GAIN (sensitivity) adjustment potentiometer (clutched at both ends of travel). Both controls are located on rear panel of sensor and protected by a gasketed, clear acrylic cover.
Indicators	Red indicator LED on rear of sensor is “ON” when the load is energized
Construction	Reinforced VALOX [®] housing, totally encapsulated, o-ring sealing, acrylic lenses, and stainless steel screws.
Environmental Rating	Meets NEMA standards 1, 2, 3, 3S, 4, 4X, 12, and 13; IEC IP66
Connections	PVC-jacketed 2-conductor 2 m (6.5ft) or 9 m (30ft) cables, or 3-pin micro-style quick disconnect (QD) fitting are available. QD cables are ordered separately. See page 8.
Operating Temperature	Temperature: -20 to +70° C (-4 to +158° F) Maximum relative humidity: 90% at 50° C (non-condensing)
Application Notes	i) ac MINI-BEAMs may be destroyed from overload conditions ii) Use on low voltage requires careful analysis of the load to determine if the leakage current or on-state voltage of the sensor will interfere with proper operation of the load iii) The false-pulse protection feature may cause momentary drop-out of the load when the sensor is wired in series or parallel with mechanical switch contacts
Certifications	

VALOX[®] is a registered trademark of General Electric Company

For MINI-BEAM:

- i) 9 m (30 ft) cables are available by adding suffix “W/30” to the model number of any cabled sensor (e.g. - SM2A312LP W/30)
- ii) A 150 mm (6 in) long pigtail cable with attached QD connector is available by adding suffix “QDP” to the model number (e.g. - SM2A312LPQDP).
- iii) A model with a QD connector requires an optional mating cable (see accessories, page 8).

MINI-BEAM AC Hookup Diagrams

AC Sensors with Attached Cable

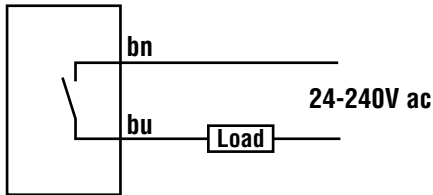

AC Sensors with Quick Disconnect (3-Pin Micro-Style)

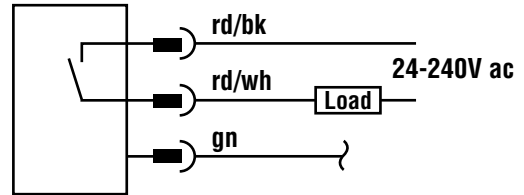

3-Pin Micro-Style Pin-out (Cable Connector Shown)

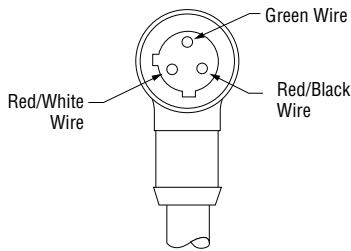

Quick Disconnect (QD) Option

AC MINI-BEAM sensors are sold with either a 2 m (6.5 ft) or a 9 m (30 ft) attached PVC-covered cable, or with a 3-pin micro-style QD cable fitting.

AC QD sensors are identified by the letters “QD” in their model number suffix. Mating cables for QD MINI-BEAM sensors are model MQDC-315 (straight connector) or MQDC-315RA (right-angled connector). Cables are supplied in a standard length of 5 m (15 ft). For more information on QD cables, see page 8.

MINI-BEAM Dimension Information

MINI-BEAM AC Sensor with Integral Cable

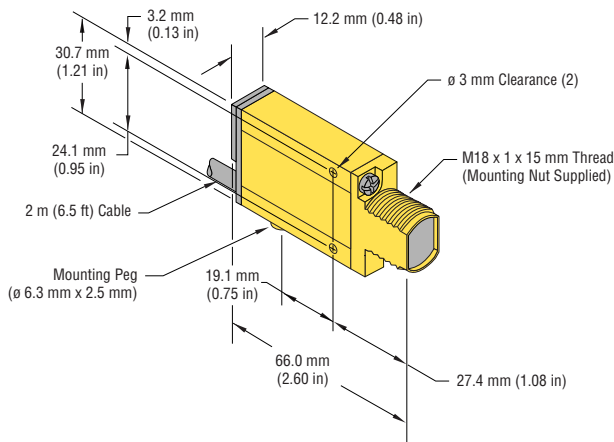

MINI-BEAM AC Sensor with Quick-Disconnect

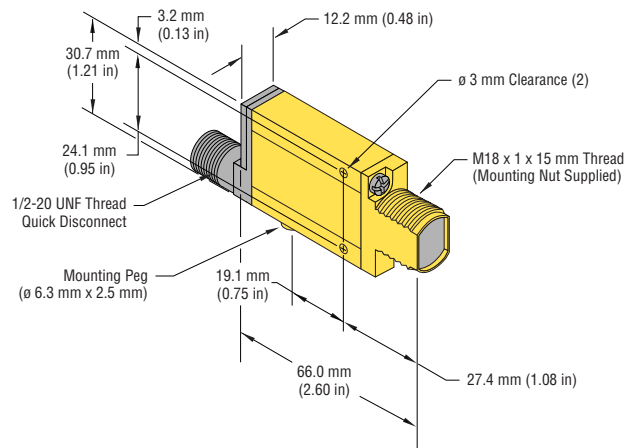

MINI-BEAM® Sensors SM2A312LV, SM2A312LVAG and SM2A312LP

MINI-BEAM MODIFICATIONS			
Model Suffix	Modification	Description	Example of Model Number
W/30	9 meter (30 ft) cable	All MINI-BEAM sensors may be ordered with an integral 9 m (30 ft) cable in place of the standard 2 m (6.5 ft) cable	SM2A312LP W/30
QDP	Pigtail Quick Disconnect	All MINI-BEAMs may be built with a 150 mm (6 in) long integral cable which is terminated with the appropriate QD connector.	SM2A312LPQDP



REPLACEMENT LENS ASSEMBLIES		
MINI-BEAM lens assemblies are field-replaceable.		
Model	Description	
UC-300AG	Replacement lens for LVAG	
UC-300L	Replacement lens for LV	
UC-300LP	Replacement lens for LP	

RETROREFLECTIVE TARGETS

Banner offers a wide selection of high-quality retroreflective targets. See the Banner Photoelectric Sensors Catalog.

MINI-BEAM® Sensors SM2A312LV, SM2A312LVAG and SM2A312LP

Mounting Brackets		
Model	Description	Dimensions
SMB312S	Stainless steel 2-axis, side mounting bracket	
SMB312B	Stainless steel 2-axis, bottom mounting bracket Includes SMB12F (below)	
SMB312F	<ul style="list-style-type: none"> A mounting foot used to attach to bottom surface of any MINI-BEAM sensor to a flat mounting surface Attaches securely beneath the MINI-BEAM sensor's barrel using a special extra-long upper cover mounting screw (supplied) 	

MINI-BEAM® Sensors SM2A312LV, SM2A312LVAG and SM2A312LP

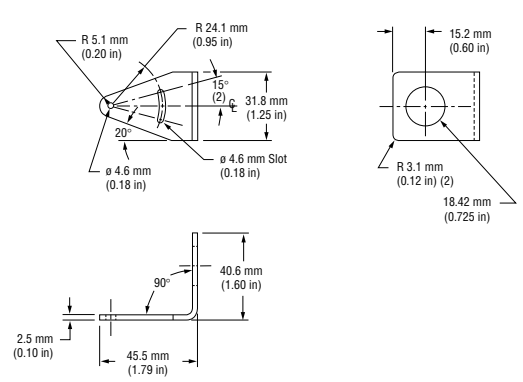
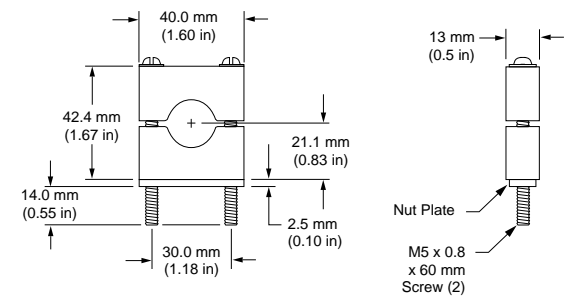
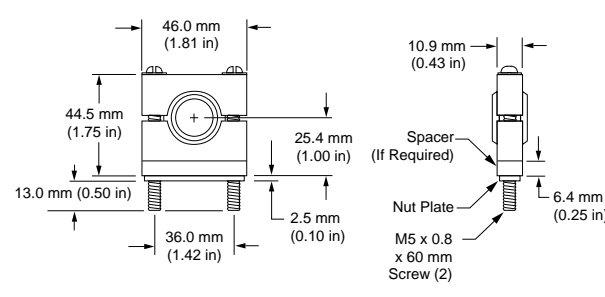
Mounting Brackets		
Model	Description	Dimensions
SMB312PD	<ul style="list-style-type: none"> Stainless steel 18 mm barrel-mounting bracket 	
SMB18C	<ul style="list-style-type: none"> 18 mm split clamp black VALOX® bracket Stainless steel mounting hardware included 	
SMB18S	<ul style="list-style-type: none"> 18 mm swivel, black VALOX® bracket Stainless steel mounting hardware included 	

MINI-BEAM® Sensors SM2A312LV, SM2A312LVAG and SM2A312LP

Micro-Style Quick Disconnect Cables

Cable: PVC jacket, polyurethane connector body, chrome-plated brass coupling nut
Conductors: 22 or 20 AWG high-flex stranded, PVC insulation, gold-plated contacts
Temperature: -40 to +80°C (-40 to +176°F)
Voltage Rating: 250V ac/300V dc (3-pin), 125V ac/150V dc (4-pin)



Style	Model	Length	Used with:	Dimensions	Pin-out
3-Pin Straight	MQDC-306 MQDC-315 MQDC-330	2 m (6.5 ft) 5 m (15 ft) 9 m (30 ft)	• MINI-BEAM ac SM2A312 series		
3-Pin Right-angle	MQDC-306RA MQDC-315RA MQDC-330RA	2 m (6.5 ft) 5 m (15 ft) 9 m (30 ft)			



WARRANTY: Banner Engineering Corporation warrants its products to be free from defects for one year. Banner Engineering Corporation will repair or replace, free of charge, any product of its manufacture found to be defective at the time it is returned to the factory during the warranty period. This warranty does not cover damage or liability for the improper application of Banner products. This warranty is in lieu of any other warranty either expressed or implied.



WARNING These photoelectric presence sensors do NOT include the self-checking redundant circuitry necessary to allow their use in personnel safety applications. A sensor failure or malfunction can result in either an energized or a de-energized sensor output condition.

Never use these products as sensing devices for personnel protection. Their use as a safety device may create an unsafe condition which could lead to serious injury or death.

Only MINI-SCREEN®, MULTI-SCREEN®, MICRO-SCREEN™, MACHINE-GUARD and PERIMETER-GUARD Systems, and other systems so designated, are designed to meet OSHA and ANSI machine safety standards for point-of-operation guarding devices. No other Banner sensors or controls are designed to meet these standards, and they must NOT be used as sensing devices for personnel protection.