

SM30 Series 30 mm Barrel Sensors



Datasheet

Opposed-Mode Infrared Photoelectric Sensors for Especially Demanding Applications



- Stainless steel or plastic barrel models
- Very high excess gain; 150 m (500 ft) sensing range; 880 nm Infrared LED
- Positive sealing eliminates even capillary leakage; lens is quad-ring sealed; exceeds NEMA 6P (IP67) ratings – ideal for equipment wash-down environments
- EZ-BEAM® technology provides reliable sensing without the need for adjustment
- Modulation frequency “A” is standard; frequencies “B” and “C” also available for preventing crosstalk in multiple-sensor applications (emitter and opposed receiver frequencies must match)
- AC- and DC-operated receiver models available; emitters feature Universal voltage
- Range for all models: 150 m (500 ft)



WARNING: Not To Be Used for Personnel Protection

Never use this device as a sensing device for personnel **protection**. Doing so could lead to serious injury or death. This device does not include the self-checking redundant circuitry necessary to allow its use in personnel safety applications. A sensor failure or malfunction can cause either an energized or de-energized sensor output condition.

Models

Modulation Frequency ¹			Housing	Cable ²	Power Supply	Output Type
A	B	C				
Emitter Models						
SMA30PEL	SMA30PELB	SMA30PELC	Plastic	2 m (6.5 ft) 2-wire Cable	Universal: 12 to 240 V ac, 10 to 30 V dc	-
SMA30PELQD	SMA30PELQDB	SMA30PELQDC		3-pin Mini-style QD ³		
SMA30SEL	SMA30SELB	SMA30SELC	Stainless Steel	2 m (6.5 ft) 3-wire Cable		
SMA30SELQD	SMA30SELQDB	SMA30SELQDC		3-pin Mini-style QD ³		
DC Receivers						
SM30PRL	SM30PRLB	SM30PRLC	Plastic	2 m (6.5 ft) 4-wire Cable	10 to 30 V dc	Bi-Modal™ NPN or PNP
SM30PRLQD	SM30PRLQDB	SM30PRLQDC		4-pin Mini-style QD		
SM30SRL	SM30SRLB	SM30SRLC	Stainless Steel	2 m (6.5 ft) 4-wire Cable		
SM30SRLQD	SM30SRLQDB	SM30SRLQDC		4-pin Mini-style QD		
AC Receivers						
SM2A30PRL	SM2A30PRLB	SM2A30PRLC	Plastic	2 m (6.5 ft) 2-wire Cable	24 to 240 V ac	SPST Solid-state, L.O.
SM2A30PRLQD	SM2A30PRLQDB	SM2A30PRLQDC		3-pin Mini-style QD ³		
SM2A30SRL	SM2A30SRLB	SM2A30SRLC	Stainless Steel	2 m (6.5 ft) 3-wire Cable		
SM2A30SRLQD	SM2A30SRLQDB	SM2A30SRLQDC		3-pin Mini-style QD ³		
SM2A30PRLNC	SM2A30PRLNCB	SM2A30PRLNCC	Plastic	2 m (6.5 ft) 2-wire Cable		SPST Solid-state, D.O.
SM2A30PRLNCQD	SM2A30PRLNCQDB	SM2A30PRLNCQDC		3-pin Mini-style QD ³		
SM2A30SRLNC	SM2A30SRLNCB	SM2A30SRLNCC	Stainless Steel	2 m (6.5 ft) 3-wire Cable		
SM2A30SRLNCQD	SM2A30SRLNCQDB	SM2A30SRLNCQDC		3-pin Mini-style QD ³		

¹ Any emitter and receiver shown here can be used together, if they have the same modulation frequency.

² Standard 2 m (6.5 ft) cable and integral QD models are listed. Models with a quick disconnect require a mating cordset. To order the 9 m (30 ft) PVC cable model, add the suffix "W/30" to the cabled model number. For example, SM30PRLBW/30.

³ AC models with QD require SM30CC model cables.



Wiring Diagrams

Key

- 1 = Brown (red/black for QD emitters/receivers)
- 3 = Blue (red/white for QD emitters/receivers)
- 4 = Green (green for QD emitters/receivers)

Emitters—Cabled

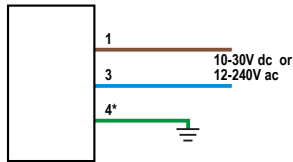

Emitters—QD

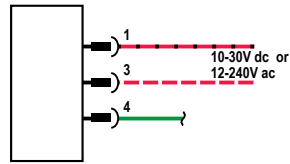

AC Receivers—Cabled

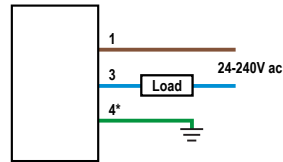

AC Receivers—QD

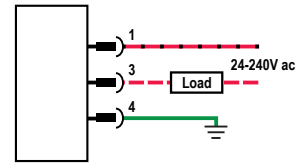

Note: AC emitters are not polarity-sensitive when powered by dc voltage. For QD emitters, use a SM30CC model cordset to match cable colors.

*Connect the green wire to earth ground whenever a stainless steel model is powered by ac voltage. (Cabled plastic models have no green wire.)

Key

- 1 = Brown
- 2 = White
- 3 = Blue
- 4 = Black

DC Receivers—NPN

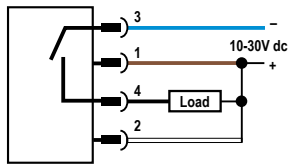

Light Operate

DC Receivers—PNP

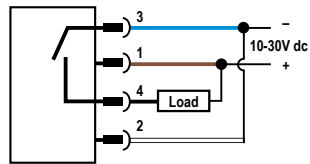

Dark Operate

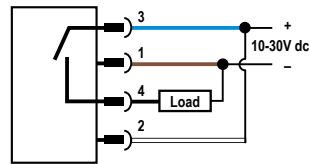

Light Operate

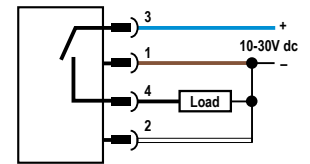

Dark Operate

Cabled wiring diagrams are functionally identical.

Specifications

Supply Voltage and Current

Emitters: 12 to 240V ac (50/60 Hz) or 10-30V dc at 20 mA, 10% maximum ripple
 DC Receivers: 10 to 30V dc at 10 mA maximum (exclusive of load); 10% maximum ripple
 AC Receivers: 24 to 240V ac (50/60 Hz)

Supply Protection Circuitry

Protected against reverse polarity and transient voltages

Output Configuration

DC Receivers: Bi-Modal™ output (PNP sourcing or NPN sinking). Selection of light/dark operate and sourcing or sinking configuration dependent on hookup.
 AC Receivers: SPST solid-state switch; light operate (LO) or dark operate (DO) dependent on model.

Output Rating

DC Receivers: 250 mA continuous
 Output saturation voltage (PNP & NPN configuration) < 1 volt at 10 mA and < 2 volts at 250 mA
 Off-state leakage current < 10 microamps
 AC Receivers: Maximum steady-state load capability is 500 mA
 Inrush capability: 10 amps for 1 second (non-repeating)
 Off-state leakage: current < 1.7 mA rms
 On-state voltage drop: < 3.5 volts rms across a 500 mA load; < 5 volts rms across a 15 mA load

Output Protection Circuitry

Outputs of dc receivers are short circuit protected

Output Response Time

10 milliseconds on/off

Repeatability

"A" frequency models: 1 ms
 "B" frequency models: 1.5 ms
 "C" frequency models: 2.3 ms

Indicators

Internal red LED, visible through the lens or from side of the sensor.
 Emitters: Red "Power ON" indicator LED
 DC Receivers: Lights whenever receiver sees its modulated light source
 AC Receivers: Lights whenever receiver's output is conducting

Construction

Fully epoxy-encapsulated tubular threaded housing, positive sealed at both ends, quad-ring sealed acrylic lens.
 Plastic models: 30 mm diameter thermoplastic polyester housing and jam nuts.
 Stainless Steel models: 30 mm diameter 303 stainless steel housing and jam nuts.

Environmental Rating

Exceeds NEMA 6P and IEC IP67

Connections

PVC-jacketed 2 m or 9 m cables or Mini-style quick-disconnect (QD) fitting are available. QD cables are ordered separately.

Operating Conditions

Temperature: -40 °C to +70 °C (-40 °F to +158 °F)
 90% at +50 °C maximum relative humidity (non-condensing)

Required Overcurrent Protection



WARNING: Electrical connections must be made by qualified personnel in accordance with local and national electrical codes and regulations.

Overcurrent protection is required to be provided by end product application per the supplied table.
 Overcurrent protection may be provided with external fusing or via Current Limiting, Class 2 Power Supply.
 Supply wiring leads < 24 AWG shall not be spliced.
 For additional product support, go to www.bannerengineering.com.

Supply Wiring (AWG)	Required Overcurrent Protection (Amps)
20	5.0
22	3.0
24	2.0
26	1.0
28	0.8
30	0.5

Certifications



Dimensions

All measurements are listed in millimeters [inches], unless noted otherwise.

Cabled Models

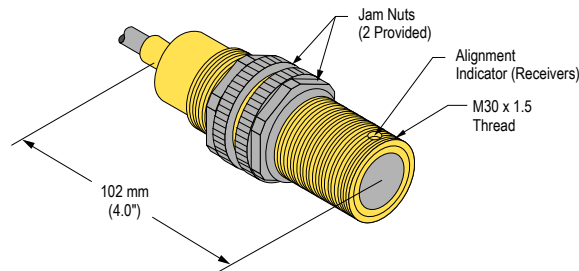

QD Models

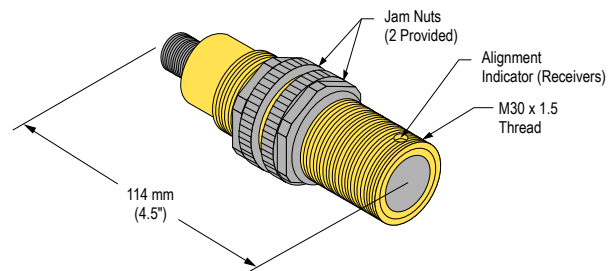

Performance Curves

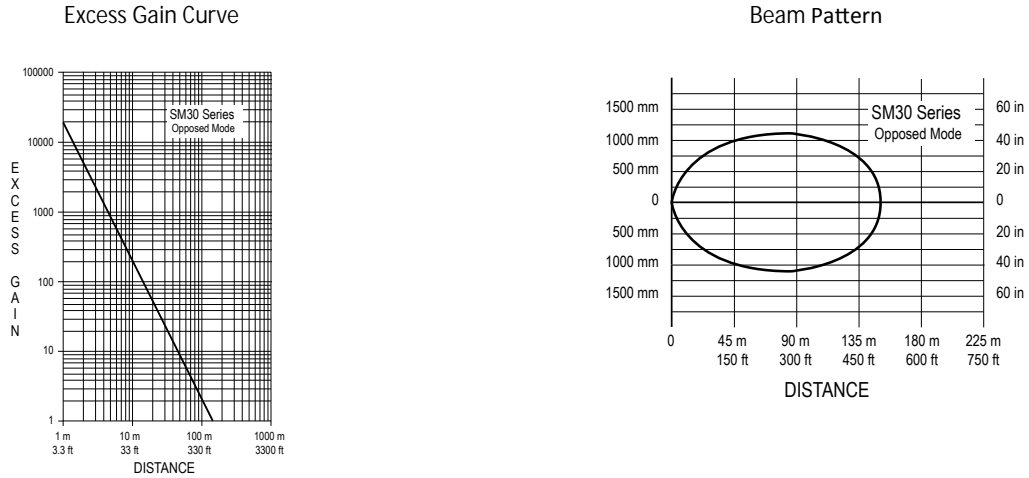

Accessories

Cordsets

3-Pin Mini-Style Cordsets				
Model	Length	Style	Dimensions	Pinout (Female)
SM30CC-306	1.83 m (6 ft)	Straight		<p>1 = Red/Black 3 = Red/White 4 = Green</p>
SM30CC-312	3.66 m (12 ft)			

4-Pin Mini-Style Cordsets				
Model	Length	Style	Dimensions	Pinout (Female)
MBCC-406	1.83 m (6 ft)	Straight		<p>1 = Brown 2 = White 3 = Blue 4 = Black</p>
MBCC-412	3.66 m (12 ft)			
MBCC-430	9.14 m (30 ft)			

Apertures

APG30S

Kit includes round apertures of 0.05 in, 0.12 in, and 0.70 in diameter; slotted widths of 1 mm (0.04 in), 0.10 in and 0.20 in.

Used with SM30 and SMI30 models.



Brackets

SMB30A

- Right-angle bracket with curved slot for versatile orientation
- Clearance for M6 (¼ in) hardware
- Mounting hole for 30 mm sensor
- 12-ga. stainless steel

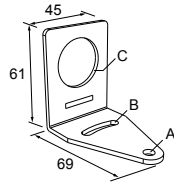

Hole center spacing: A to B=40
Hole size: A=ø 6.3, B= 27.1 x 6.3, C=ø 30.5

SMB30C

- 30 mm split clamp, black PBT bracket
- Stainless steel mounting hardware included
- Mounting hole for 30 mm sensor

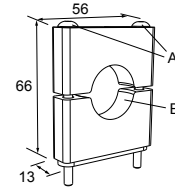

Hole center spacing: A=ø 45
Hole size: B=ø 27.2

SMB30MM

- 12-ga. stainless steel bracket with curved mounting slots for versatile orientation
- Clearance for M6 (¼ in) hardware
- Mounting hole for 30 mm sensor

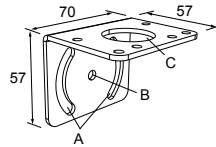

Hole center spacing: A = 51, A to B = 25.4
Hole size: A = 42.6 x 7, B = ø 6.4, C = ø 30.1

SMB30SC

- Swivel bracket with 30 mm mounting hole for sensor
- Black reinforced thermoplastic polyester
- Stainless steel mounting and swivel locking hardware included

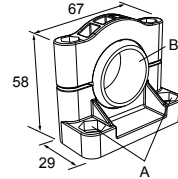

Hole center spacing: A=ø 50.8
Hole size: A=ø 7.0, B=ø 30.0

Banner Engineering Corp. Limited Warranty

Banner Engineering Corp. warrants its products to be free from defects in material and workmanship for one year following the date of shipment. Banner Engineering Corp. will repair or replace, free of charge, any product of its manufacture which, at the time it is returned to the factory, is found to have been defective during the warranty period. This warranty does not cover damage or liability for misuse, abuse, or the improper application or installation of the Banner product.

THIS LIMITED WARRANTY IS EXCLUSIVE AND IN LIEU OF ALL OTHER WARRANTIES WHETHER EXPRESS OR IMPLIED (INCLUDING, WITHOUT LIMITATION, ANY WARRANTY OF MERCHANTABILITY OR FITNESS FOR A PARTICULAR PURPOSE), AND WHETHER ARISING UNDER COURSE OF PERFORMANCE, COURSE OF DEALING OR TRADE USAGE.

This Warranty is exclusive and limited to repair or, at the discretion of Banner Engineering Corp., replacement. IN NO EVENT SHALL BANNER ENGINEERING CORP. BE LIABLE TO BUYER OR ANY OTHER PERSON OR ENTITY FOR ANY EXTRA COSTS, EXPENSES, LOSSES, LOSS OF PROFITS, OR ANY INCIDENTAL, CONSEQUENTIAL OR SPECIAL DAMAGES RESULTING FROM ANY PRODUCT DEFECT OR FROM THE USE OR INABILITY TO USE THE PRODUCT, WHETHER ARISING IN CONTRACT OR WARRANTY, STATUTE, TORT, STRICT LIABILITY, NEGLIGENCE, OR OTHERWISE.

Banner Engineering Corp. reserves the right to change, modify or improve the design of the product without assuming any obligations or liabilities relating to any product previously manufactured by Banner Engineering Corp. Any misuse, abuse, or improper application or installation of this product or use of the product for personal protection applications when the product is identified as not intended for such purposes will void the product warranty. Any modifications to this product without prior express approval by Banner Engineering Corp will void the product warranties. All specifications published in this document are subject to change: Banner reserves the right to modify product specifications or update documentation at any time. Specifications and product information in English supersede that which is provided in any other language. For the most recent version of any documentation, refer to: www.bannerengineering.com.

SM30 Series 30 mm Barrel Sensors



Datasheet

Opposed-Mode Infrared Photoelectric Sensors for Especially Demanding Applications



- Stainless steel or plastic barrel models
- Very high excess gain; 150 m (500 ft) sensing range; 880 nm Infrared LED
- Positive sealing eliminates even capillary leakage; lens is quad-ring sealed; exceeds NEMA 6P (IP67) ratings – ideal for equipment wash-down environments
- EZ-BEAM[®] technology provides reliable sensing without the need for adjustment
- Modulation frequency “A” is standard; frequencies “B” and “C” also available for preventing crosstalk in multiple-sensor applications (emitter and opposed receiver frequencies must match)
- AC- and DC-operated receiver models available; emitters feature Universal voltage
- Range for all models: 150 m (500 ft)



WARNING: Not To Be Used for Personnel Protection

Never use this device as a sensing device for personnel **protection**. Doing so could lead to serious injury or death. This device does not include the self-checking redundant circuitry necessary to allow its use in personnel safety applications. A sensor failure or malfunction can cause either an energized or de-energized sensor output condition.

Models

Modulation Frequency ¹			Housing	Cable ²	Power Supply	Output Type
A	B	C				
Emitter Models						
SMA30PEL	SMA30PELB	SMA30PELC	Plastic	2 m (6.5 ft) 2-wire Cable	Universal: 12 to 240 V ac, 10 to 30 V dc	-
SMA30PELQD	SMA30PELQDB	SMA30PELQDC		3-pin Mini-style QD ³		
SMA30SEL	SMA30SELB	SMA30SELC	Stainless Steel	2 m (6.5 ft) 3-wire Cable		
SMA30SELQD	SMA30SELQDB	SMA30SELQDC		3-pin Mini-style QD ³		
DC Receivers						
SM30PRL	SM30PRLB	SM30PRLC	Plastic	2 m (6.5 ft) 4-wire Cable	10 to 30 V dc	Bi-Modal™ NPN or PNP
SM30PRLQD	SM30PRLQDB	SM30PRLQDC		4-pin Mini-style QD		
SM30SRL	SM30SRLB	SM30SRLC	Stainless Steel	2 m (6.5 ft) 4-wire Cable		
SM30SRLQD	SM30SRLQDB	SM30SRLQDC		4-pin Mini-style QD		
AC Receivers						
SM2A30PRL	SM2A30PRLB	SM2A30PRLC	Plastic	2 m (6.5 ft) 2-wire Cable	24 to 240 V ac	SPST Solid-state, L.O.
SM2A30PRLQD	SM2A30PRLQDB	SM2A30PRLQDC		3-pin Mini-style QD ³		
SM2A30SRL	SM2A30SRLB	SM2A30SRLC	Stainless Steel	2 m (6.5 ft) 3-wire Cable		
SM2A30SRLQD	SM2A30SRLQDB	SM2A30SRLQDC		3-pin Mini-style QD ³		
SM2A30PRLNC	SM2A30PRLNCB	SM2A30PRLNCC	Plastic	2 m (6.5 ft) 2-wire Cable		SPST Solid-state, D.O.
SM2A30PRLNCQD	SM2A30PRLNCQDB	SM2A30PRLNCQDC		3-pin Mini-style QD ³		
SM2A30SRLNC	SM2A30SRLNCB	SM2A30SRLNCC	Stainless Steel	2 m (6.5 ft) 3-wire Cable		
SM2A30SRLNCQD	SM2A30SRLNCQDB	SM2A30SRLNCQDC		3-pin Mini-style QD ³		

¹ Any emitter and receiver shown here can be used together, if they have the same modulation frequency.

² Standard 2 m (6.5 ft) cable and integral QD models are listed. Models with a quick disconnect require a mating cordset. To order the 9 m (30 ft) PVC cable model, add the suffix "W/30" to the cabled model number. For example, SM30PRLBW/30.

³ AC models with QD require SM30CC model cables.



Wiring Diagrams

Key

- 1 = Brown (red/black for QD emitters/receivers)
- 3 = Blue (red/white for QD emitters/receivers)
- 4 = Green (green for QD emitters/receivers)

Emitters—Cabled

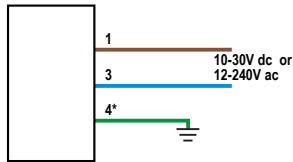

Emitters—QD

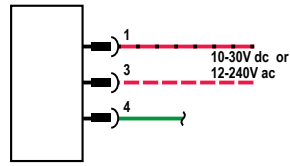

AC Receivers—Cabled

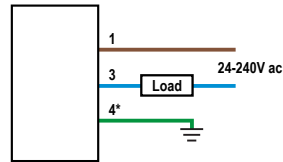

AC Receivers—QD

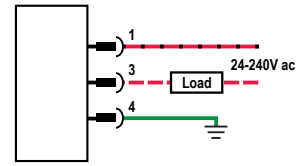

Note: AC emitters are not polarity-sensitive when powered by dc voltage. For QD emitters, use a SM30CC model cordset to match cable colors.

*Connect the green wire to earth ground whenever a stainless steel model is powered by ac voltage. (Cabled plastic models have no green wire.)

Key

- 1 = Brown
- 2 = White
- 3 = Blue
- 4 = Black

DC Receivers—NPN

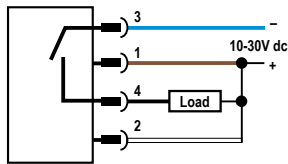

Light Operate

DC Receivers—PNP

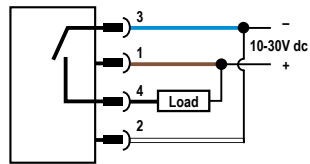

Dark Operate

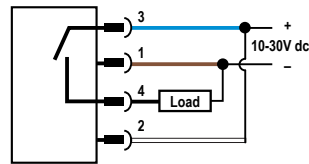

Light Operate

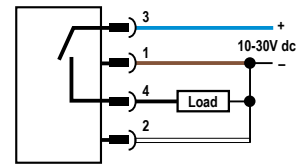

Dark Operate

Cabled wiring diagrams are functionally identical.

Specifications

Supply Voltage and Current

Emitters: 12 to 240V ac (50/60 Hz) or 10-30V dc at 20 mA, 10% maximum ripple
 DC Receivers: 10 to 30V dc at 10 mA maximum (exclusive of load); 10% maximum ripple
 AC Receivers: 24 to 240V ac (50/60 Hz)

Supply Protection Circuitry

Protected against reverse polarity and transient voltages

Output Configuration

DC Receivers: Bi-Modal™ output (PNP sourcing or NPN sinking). Selection of light/dark operate and sourcing or sinking configuration dependent on hookup.
 AC Receivers: SPST solid-state switch; light operate (LO) or dark operate (DO) dependent on model.

Output Rating

DC Receivers: 250 mA continuous
 Output saturation voltage (PNP & NPN configuration) < 1 volt at 10 mA and < 2 volts at 250 mA
 Off-state leakage current < 10 microamps
 AC Receivers: Maximum steady-state load capability is 500 mA
 Inrush capability: 10 amps for 1 second (non-repeating)
 Off-state leakage: current < 1.7 mA rms
 On-state voltage drop: < 3.5 volts rms across a 500 mA load; < 5 volts rms across a 15 mA load

Output Protection Circuitry

Outputs of dc receivers are short circuit protected

Output Response Time

10 milliseconds on/off

Repeatability

"A" frequency models: 1 ms
 "B" frequency models: 1.5 ms
 "C" frequency models: 2.3 ms

Indicators

Internal red LED, visible through the lens or from side of the sensor.
 Emitters: Red "Power ON" indicator LED
 DC Receivers: Lights whenever receiver sees its modulated light source
 AC Receivers: Lights whenever receiver's output is conducting

Construction

Fully epoxy-encapsulated tubular threaded housing, positive sealed at both ends, quad-ring sealed acrylic lens.
 Plastic models: 30 mm diameter thermoplastic polyester housing and jam nuts.
 Stainless Steel models: 30 mm diameter 303 stainless steel housing and jam nuts.

Environmental Rating

Exceeds NEMA 6P and IEC IP67

Connections

PVC-jacketed 2 m or 9 m cables or Mini-style quick-disconnect (QD) fitting are available. QD cables are ordered separately.

Operating Conditions

Temperature: -40 °C to +70 °C (-40 °F to +158 °F)
 90% at +50 °C maximum relative humidity (non-condensing)

Required Overcurrent Protection



WARNING: Electrical connections must be made by qualified personnel in accordance with local and national electrical codes and regulations.

Overcurrent protection is required to be provided by end product application per the supplied table.
 Overcurrent protection may be provided with external fusing or via Current Limiting, Class 2 Power Supply.
 Supply wiring leads < 24 AWG shall not be spliced.
 For additional product support, go to www.bannerengineering.com.

Supply Wiring (AWG)	Required Overcurrent Protection (Amps)
20	5.0
22	3.0
24	2.0
26	1.0
28	0.8
30	0.5

Certifications



Dimensions

All measurements are listed in millimeters [inches], unless noted otherwise.

Cabled Models

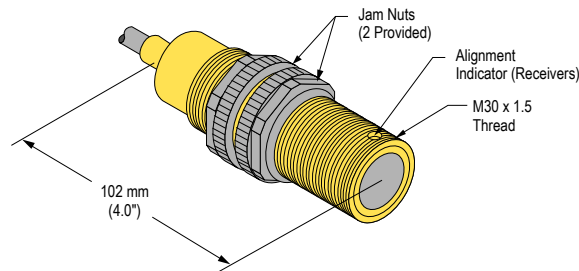

QD Models

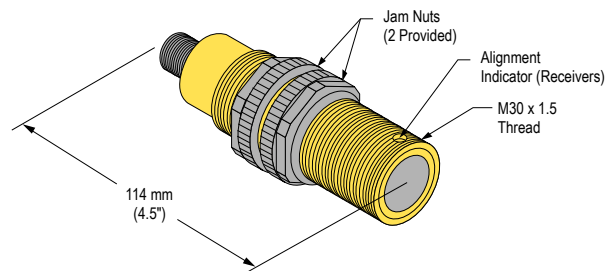

Performance Curves

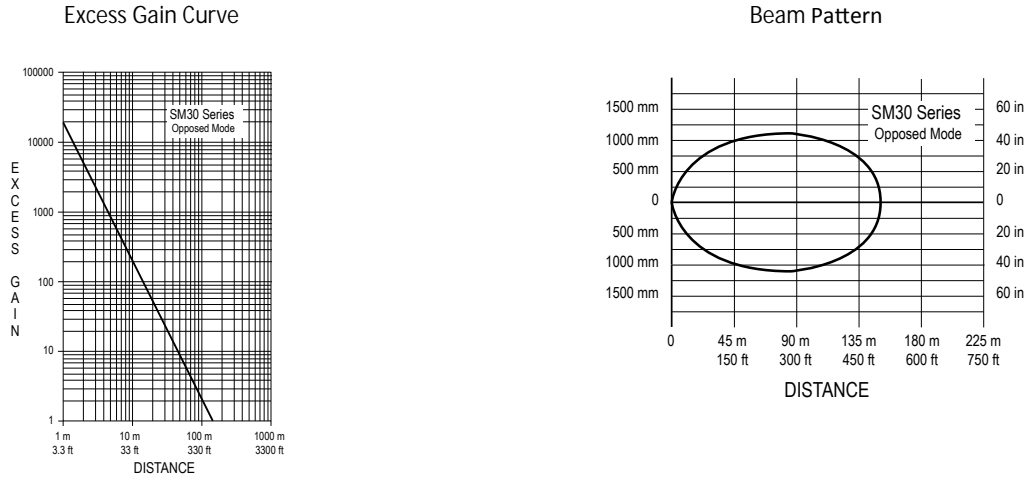

Accessories

Cordsets

3-Pin Mini-Style Cordsets				
Model	Length	Style	Dimensions	Pinout (Female)
SM30CC-306	1.83 m (6 ft)	Straight		<p>1 = Red/Black 3 = Red/White 4 = Green</p>
SM30CC-312	3.66 m (12 ft)			

4-Pin Mini-Style Cordsets				
Model	Length	Style	Dimensions	Pinout (Female)
MBCC-406	1.83 m (6 ft)	Straight		<p>1 = Brown 2 = White 3 = Blue 4 = Black</p>
MBCC-412	3.66 m (12 ft)			
MBCC-430	9.14 m (30 ft)			

Apertures

APG30S

Kit includes round apertures of 0.05 in, 0.12 in, and 0.70 in diameter; slotted widths of 1 mm (0.04 in), 0.10 in and 0.20 in.

Used with SM30 and SMI30 models.



Brackets

SMB30A

- Right-angle bracket with curved slot for versatile orientation
- Clearance for M6 (¼ in) hardware
- Mounting hole for 30 mm sensor
- 12-ga. stainless steel

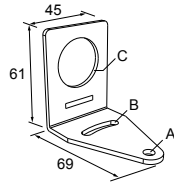

Hole center spacing: A to B=40
Hole size: A=Ø 6.3, B= 27.1 x 6.3, C=Ø 30.5

SMB30C

- 30 mm split clamp, black PBT bracket
- Stainless steel mounting hardware included
- Mounting hole for 30 mm sensor

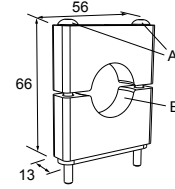

Hole center spacing: A=Ø 45
Hole size: B=Ø 27.2

SMB30MM

- 12-ga. stainless steel bracket with curved mounting slots for versatile orientation
- Clearance for M6 (¼ in) hardware
- Mounting hole for 30 mm sensor

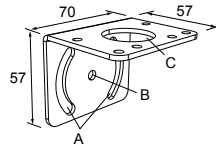

Hole center spacing: A = 51, A to B = 25.4
Hole size: A = 42.6 x 7, B = Ø 6.4, C = Ø 30.1

SMB30SC

- Swivel bracket with 30 mm mounting hole for sensor
- Black reinforced thermoplastic polyester
- Stainless steel mounting and swivel locking hardware included

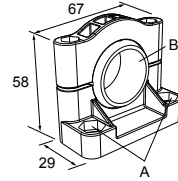

Hole center spacing: A=Ø 50.8
Hole size: A=Ø 7.0, B=Ø 30.0

Banner Engineering Corp. Limited Warranty

Banner Engineering Corp. warrants its products to be free from defects in material and workmanship for one year following the date of shipment. Banner Engineering Corp. will repair or replace, free of charge, any product of its manufacture which, at the time it is returned to the factory, is found to have been defective during the warranty period. This warranty does not cover damage or liability for misuse, abuse, or the improper application or installation of the Banner product.

THIS LIMITED WARRANTY IS EXCLUSIVE AND IN LIEU OF ALL OTHER WARRANTIES WHETHER EXPRESS OR IMPLIED (INCLUDING, WITHOUT LIMITATION, ANY WARRANTY OF MERCHANTABILITY OR FITNESS FOR A PARTICULAR PURPOSE), AND WHETHER ARISING UNDER COURSE OF PERFORMANCE, COURSE OF DEALING OR TRADE USAGE.

This Warranty is exclusive and limited to repair or, at the discretion of Banner Engineering Corp., replacement. IN NO EVENT SHALL BANNER ENGINEERING CORP. BE LIABLE TO BUYER OR ANY OTHER PERSON OR ENTITY FOR ANY EXTRA COSTS, EXPENSES, LOSSES, LOSS OF PROFITS, OR ANY INCIDENTAL, CONSEQUENTIAL OR SPECIAL DAMAGES RESULTING FROM ANY PRODUCT DEFECT OR FROM THE USE OR INABILITY TO USE THE PRODUCT, WHETHER ARISING IN CONTRACT OR WARRANTY, STATUTE, TORT, STRICT LIABILITY, NEGLIGENCE, OR OTHERWISE.

Banner Engineering Corp. reserves the right to change, modify or improve the design of the product without assuming any obligations or liabilities relating to any product previously manufactured by Banner Engineering Corp. Any misuse, abuse, or improper application or installation of this product or use of the product for personal protection applications when the product is identified as not intended for such purposes will void the product warranty. Any modifications to this product without prior express approval by Banner Engineering Corp will void the product warranties. All specifications published in this document are subject to change: Banner reserves the right to modify product specifications or update documentation at any time. Specifications and product information in English supersede that which is provided in any other language. For the most recent version of any documentation, refer to: www.bannerengineering.com.