

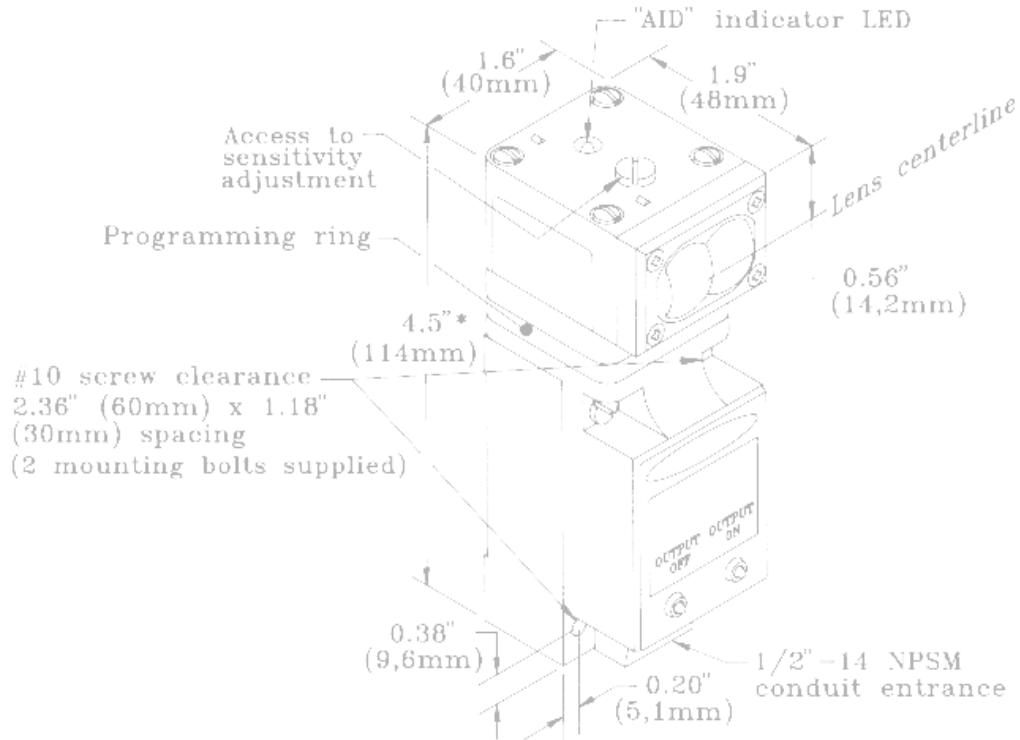

Product
Line
Specifications

MAXI-BEAM[®] Sensors

Highly versatile modularized photoelectric sensing controls



* 5.0" (127mm) with logic module and second programming ring installed.



- Highly versatile, self-contained, modularized photoelectric sensors; especially suited to industrial environments
- Wide selection of rotatable sensor heads, power blocks, and logic timing modules to suit any application
- Power blocks for AC or DC operation and for switching of AC or DC loads
- Sensor heads include patented AID[™] indicator device, which lights a top-mounted LED when the sensor "sees" its own modulated light source and pulses the LED at a rate proportional to the received light signal strength
- Status indicator LEDs on power block continuously indicate the state of the output circuit
- Models are available in all sensing modes

MAXI-BEAM[®]

Modular Sensors

Banner MAXI-BEAM sensors are highly versatile, self-contained, modularized photoelectric sensing controls that are ideally suited to industrial environments. The basic MAXI-BEAM is an ON/OFF switch consisting of three modules: a sensor head, a power block, and a wiring base.

The *sensor head* contains the complete modulated photoelectric amplifier as well as the emitter and receiver optoelements. A unique, patented, "programming ring" (supplied with each sensor head) enables you to program your choice of "light" or "dark" operate mode, sensing range, and response time. MAXI-BEAM sensor heads have an easily-accessible multi-turn SENSITIVITY control for precise adjustment of system gain. Interchangeable sensor heads are rotatable in 90-degree increments, and are available in opposed, retroreflective, diffuse, convergent, and fiber optic models. Each sensor head also includes Banner's exclusive, patented Alignment Indicating Device (AID[™], U.S. patent #4356393), which lights a top-mounted LED when the sensor "sees" its own modulated light source and pulses at a rate proportional to the received light signal strength.

The *power block* provides the interface between the sensor head and the external circuit. It contains the power supply for the MAXI-BEAM plus a switching device to interface with the circuit to be controlled. DC power block versions operate on 10 to 30V dc and have solid-state sourcing and sinking outputs rated at 250mA each (maximum). AC models are available for 120V or 240V ac operation, and are offered in both 2-wire and 3- or 4-wire formats. The plug-in design of the *wiring base* enables easy exchange of the entire sensing electronics without disturbing the field wiring. Status LEDs on the power block module continuously indicate the state of the output circuit.

Optional logic modules are available which easily convert the basic ON/OFF MAXI-BEAM into either a one-shot or delay logic function control. The logic module comes with a programming ring which is used to select one of several timing ranges for each logic function. Timing adjustments are made via two 15-turn clutched potentiometers, accessible from the outside. Once programmed, the logic module may be rotated in 90-degree increments to allow time adjustment access from the most convenient location.

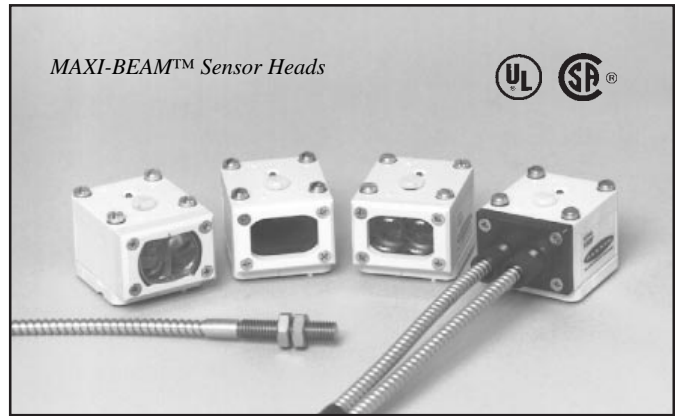

All MAXI-BEAM components are encapsulated within rugged, corrosion-resistant VALOX[®] housings which meet or exceed NEMA 1, 3, 4, 12, and 13 standards. Modules simply snap and bolt together, with no interwiring necessary. Module interfaces are o-ring and quad-ring sealed for the ultimate in dirt, dust, and moisture resistance. All MAXI-BEAM components (except for power block model RPBR) are totally solid-state for unlimited life. MAXI-BEAM assemblies have the same mounting configuration as Banner MULTI-BEAM sensors, and are physically interchangeable with heavy-duty industrial limit switches.

Most MAXI-BEAM sensors are CSA certified and UL listed. See the power block information on pages 8 to 13.



WARNING MAXI-BEAM photoelectric presence sensors do NOT include the self-checking redundant circuitry necessary to allow their use in personnel safety applications. A sensor failure or malfunction can result in *either* an energized or a de-energized sensor output condition.

Never use these products as sensing devices for personnel protection. Their use as a safety device may create an unsafe condition which could lead to serious injury or death.

Only MACHINE-GUARD and PERIMETER-GUARD Systems, and other systems so designated, are designed to meet OSHA and ANSI machine safety standards for point-of-operation guarding devices. No other Banner sensors or controls are designed to meet these standards, and they must NOT be used as sensing devices for personnel protection.

Composite Functional Schematic, MAXI-BEAM Sensors

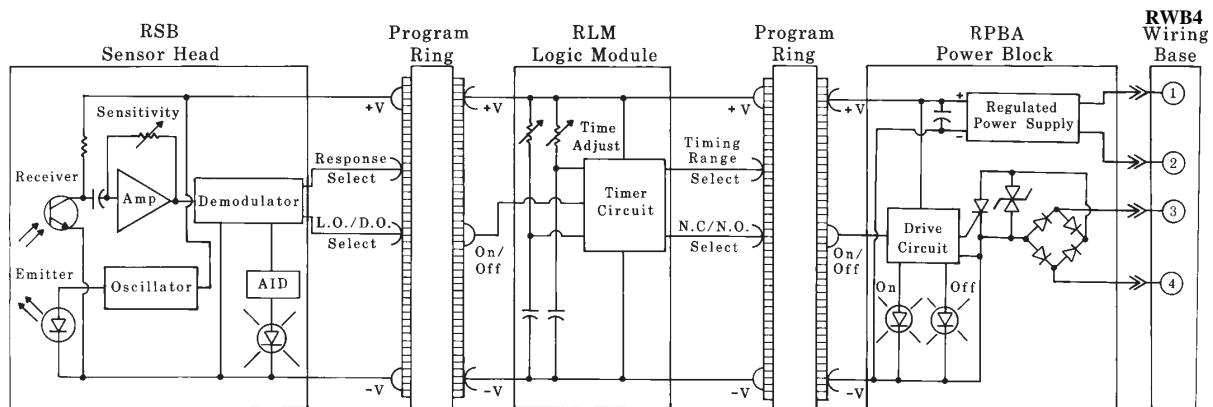

Selection of MAXI-BEAM Components

The modular design of the MAXI-BEAM allows you to create a sensor which is tailored to your exact requirements. To order a MAXI-BEAM, follow these steps:

1) SELECT A SENSOR HEAD (see pages 3-7).

Sensor heads are available for opposed, retroreflective, diffuse, convergent, and fiberoptic sensing modes.

2) SELECT A POWER BLOCK (see pages 8-13).

Power blocks are available for low voltage dc with either a solid-state or an electromechanical relay output. AC power blocks are available in either 2-wire design with solid-state output or 4-wire design with a choice of solid-state or electromechanical relay output.

3) SELECT A WIRING BASE (see page 8, top). Model RWB4 wiring base is used for all MAXI-BEAM assemblies (purchase separately).

4) SELECT A LOGIC MODULE, if needed (see pages 14-15).

MAXI-BEAMs operate in the ON/OFF mode (i.e. the output follows the action within the sensing beam) when no logic module is used. The addition of a programmable logic module can add process timing control as part of the MAXI-BEAM sensor assembly.

5) SELECT ACCESSORIES, as needed (see pages 15-16).

MAXI-BEAM Dimensions

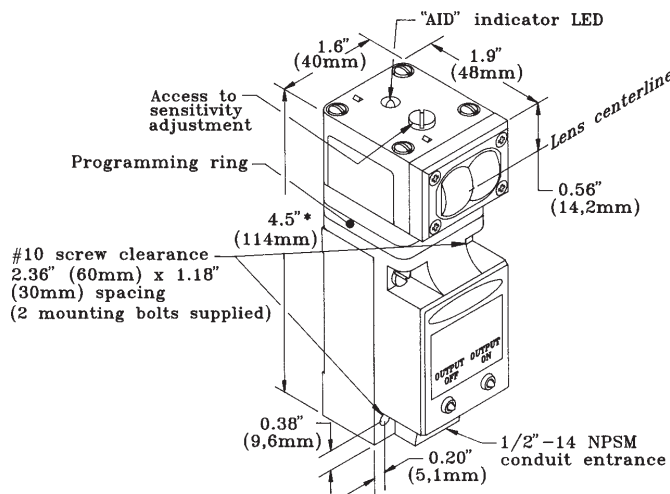

* 5.0" (127mm) with logic module and second programming ring installed.

Functional Schematic, MAXI-BEAM Sensor Head

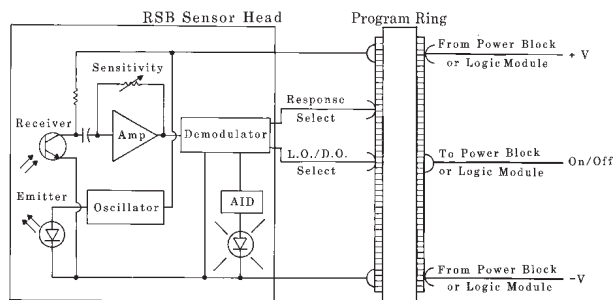

Exploded view, MAXI-BEAM Sensor

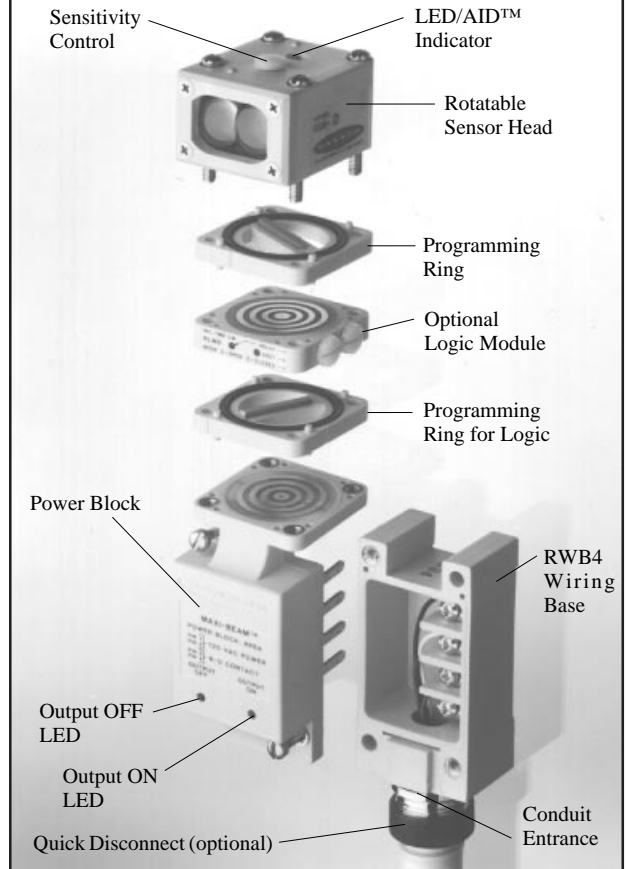

Specifications: MAXI-BEAM Sensor Heads

SUPPLY VOLTAGE:

Input power is supplied by the power block (see pages 8 to 13).

RESPONSE TIME:

Programmable for 10, 1, and 0.3 milliseconds (most models). See specifications on particular model. Independent of signal strength. NOTE: see power block specifications for information on additional output switching response delays.

REPEATABILITY OF RESPONSE:

See individual sensor specifications. NOTE: Response time and repeatability specifications are independent of signal strength.

SENSITIVITY ADJUSTMENT:

Easily accessible; located on top of sensor head beneath o-ring gasketed cover. 15-turn clutched control (rotate clockwise to increase gain).

ALIGNMENT INDICATOR:

Red LED on top of sensor head. Banner's exclusive "AID" circuit lights the LED when the sensor sees its own modulated light source and pulses the LED at a rate proportional to the received light signal strength.

CONSTRUCTION:

Reinforced molded VALOX® housing, molded acrylic lenses, o-ring and quad-ring gasketed components. Electronic components are fully epoxy-encapsulated. NEMA 1, 3, 4, 12, and 13.

OPERATING TEMPERATURE RANGE:

-40 to +70 degrees C (-40 to +158 degrees F).

FALSE-PULSE SUPPRESSION ON POWER-UP:

100 millisecond delay on power-up, all models.

MAXI-BEAM Sensor Heads

Sensing Mode

Models

Excess Gain

Beam Pattern



RSBE & RSBR
Range: 300 feet (90 m) in "HP" (high power) and 2W (2 wire) modes
Beam: infrared, 880nm;
 visible red tracer beam
Effective Beam: 0.5" dia.
Response:
 HP, 2W mode: 10ms on/5 off
 HS mode: 1ms on/0.5 off
 SP mode: 0.3ms on/off
Repeatability: HP, 2W=1.4ms; HS = 0.1ms; SP = 0.04ms

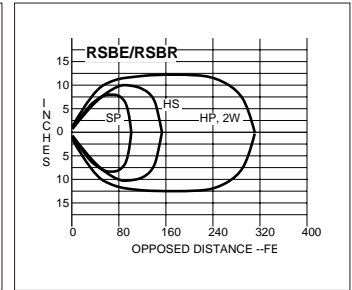
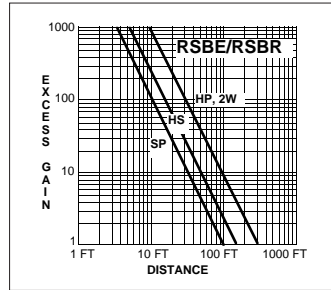

OPPOSED Mode



RSBESR & RSBRSR
Range: 15 feet (4.5m) in "HP" (high power) and 2W (2 wire) modes
Beam: infrared, 880nm
Response:
 HP, 2W modes: 10ms on/5 off
 HS mode: 1ms on/0.5 off
 SP mode: 0.3ms on/off
Repeatability: HP, 2W=1.4ms; HS = 0.1ms; SP = 0.04ms

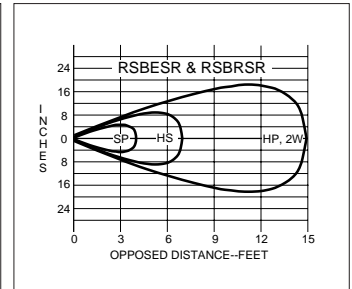
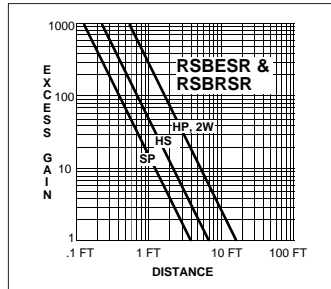

MAXI-BEAM emitters have a visible red "tracer beam". This beam is non-active, and is used as a means of visual alignment during installation. A retroreflector temporarily attached to the receiver lens provides an effective target for the tracer beam during alignment. The narrow beam of the RSBESR/RSBRSR pair is ideal for sensing small parts (effective beam diameter is 0.14 inch).

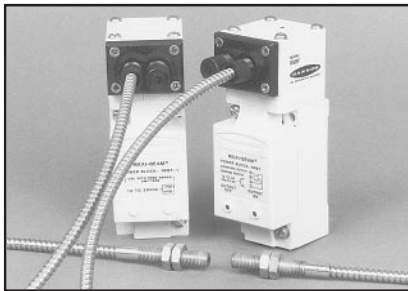

RSBEF & RSBRF
Range: see excess gain curves
Beam: infrared, 880nm.
Response:
 HP, 2W modes: 10ms
 HS mode: 1ms
 SP mode: 0.3ms on/off
Repeatability: HP, 2W=3.3ms; HS = 0.3ms; SP = 0.1ms

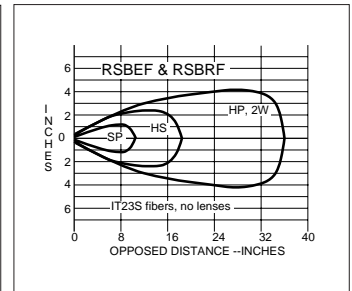
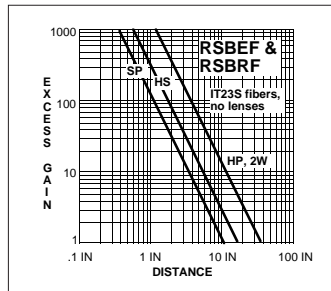

OPPOSED FIBER OPTIC Mode (glass fibers)

This sensor pair is designed for opposed mode operation using Banner glass fiber optics. Maximum range (HP mode) using L9 lenses is 12 feet. Maximum range using L16F lenses is 50 feet.



RSBLV
Range: 6 inches to 30 feet (9 m) in all program modes
Beam: visible red, 650nm
Response:
 HP, 2W, SP modes: 4ms
 HS mode: 1ms
Repeatability:
 HP, 2W, SP = 1.3ms; HS = 0.3ms

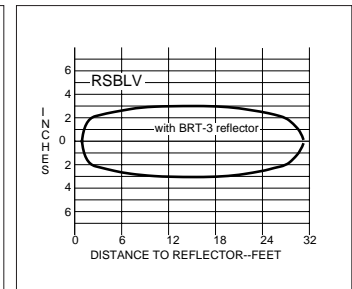
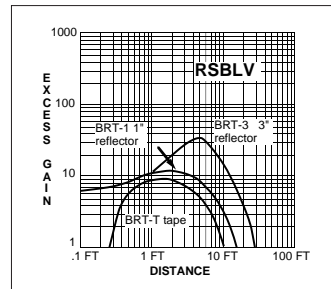

RETROREFLECTIVE Mode



RSBLVAG
 (anti-glare filter)
Range: 1 to 15 feet (4.5 m) in all program modes
Beam: visible red, 650nm; with polarizing filter
Response:
 HP, 2W, SP modes: 4ms
 HS mode: 1ms
Repeatability: HP, 2W, SP = 1.3ms; HS = 0.3ms

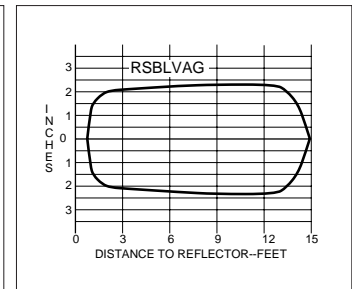
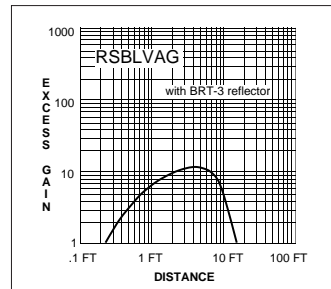

MAXI-BEAM Sensor Heads

Sensing Mode

Models

Excess Gain

Beam Pattern



RSBD

Range: 5 feet (1.5 m) in HP and 2W modes
Beam: infrared, 880nm
Response:
 HP, 2W modes: 10ms
 HS mode: 1ms
 SP mode: 0.3ms
Repeatability: HP, 2W= 3.3ms; HS = 0.3ms; SP = 0.1ms

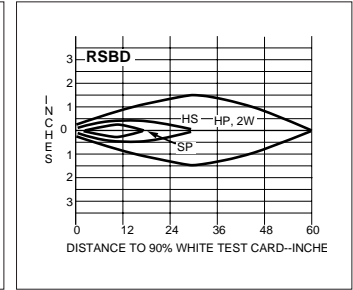
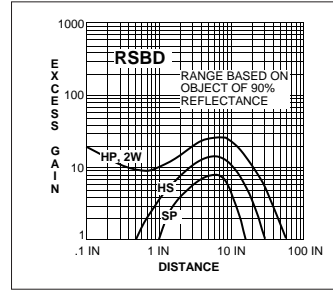

DIFFUSE Mode



RSBDSR (short range)

Range: 30 inches (76cm) in HP and 2W modes
Beam: infrared, 880nm
Response:
 HP, 2W modes: 10ms
 HS mode: 1ms
 SP mode: 0.3ms
Repeatability: HP, 2W= 3.3ms; HS = 0.3ms; SP = 0.1ms

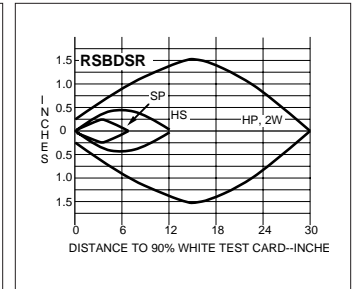
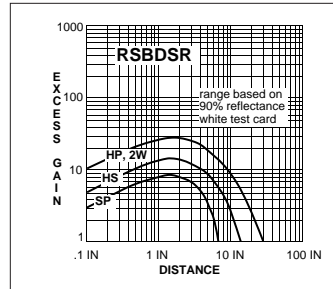

RSBC

Focus at 1.5 in. (38mm)
Beam: infrared, 940nm
Response:
 HP, 2W modes: 10ms
 HS mode: 1ms
 SP mode: 0.3ms
Repeatability:
 HP, 2W= 3.3ms; HS = 0.3ms; SP = 0.1ms

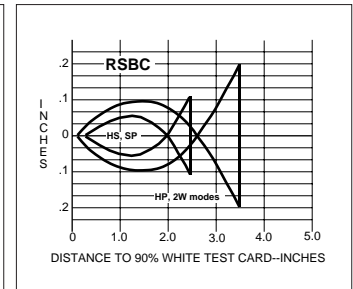
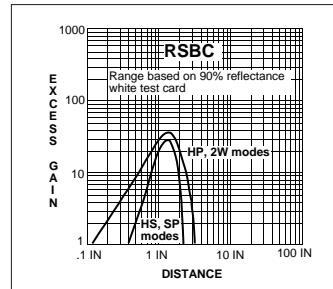

CONVERGENT Mode



RSBCV

Focus at 1.5 in. (38mm); performance equal in all program modes.
Beam: visible red, 650nm.
Response:
 HP, 2W, SP modes: 4ms
 HS mode: 1ms
Repeatability:
 HP, 2W, SP= 1.3ms; HS = 0.3ms

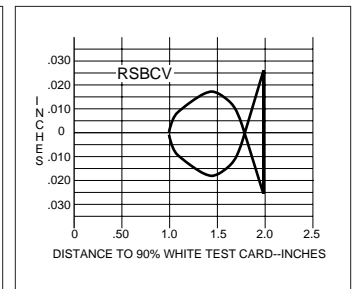
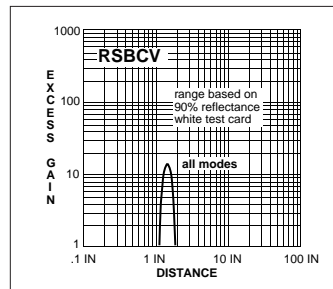

Powerful infrared beam reliably senses objects of low reflectivity. Ideal for counting the flow of radiused products at a fixed distance from the sensor.

Powerful visible red beam detects small objects only a fraction of an inch away from backgrounds. Useful in many high-contrast color registration applications.

FIXED-FIELD Mode

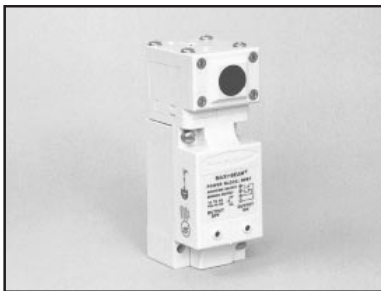

RSBFF models

Far limit cutoff at: 50mm (model RSBFF50) or 100mm (model RSBFF100)
Beam: infrared, 880nm.
Response:
 HP mode: 10ms
Repeatability:
 HP mode: 3.3ms

Fixed-field sensor heads have an emitter element and two differently-aimed receiver elements. This creates a high-gain sensing field able to detect objects of low reflectivity, and a sharp far-limit sensing cutoff of 50mm (2 inches) or 100mm (4 inches) which ignores backgrounds beyond cutoff.

These sensors are ideal for detecting a part or surface that is only a fraction of an inch in front of another surface.

RSBFFs may not be used with 2-wire power blocks.

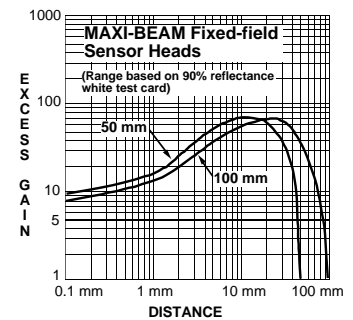

MAXI-BEAM Sensor Heads

Sensing Mode

Models

Excess Gain

Beam Pattern



RSBF

Range: see excess gain curves

Beam: infrared, 880nm

Response:

HP, 2W modes: 10ms

HS mode: 1ms

SP mode: 0.3ms

Repeatability:

HP, 2W = 3.3ms;

HS = 0.3ms;

SP = 0.1ms

FIBER OPTIC Mode

(glass fibers)

OPPOSED MODE

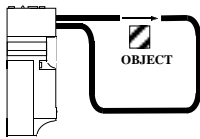

RETRO MODE

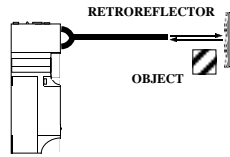

DIFFUSE MODE

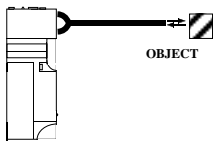

NOTE: if the retroreflective sensing mode is used in conjunction with the HP or 2W program mode, the GAIN control must be reduced from the factory setting in order to avoid optical feedback from the lens assembly.

For information on the complete line of Banner glass fiber optics, see Banner product catalog.

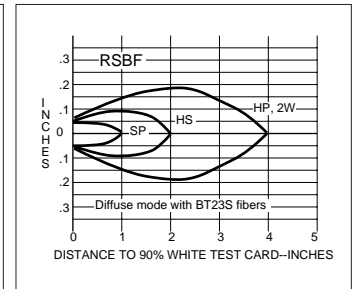
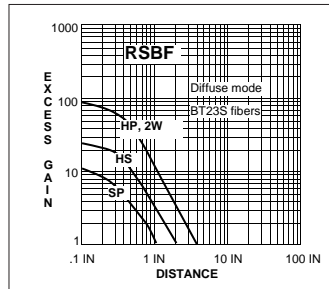
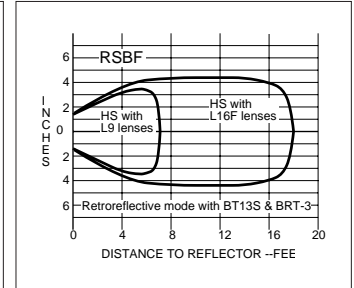
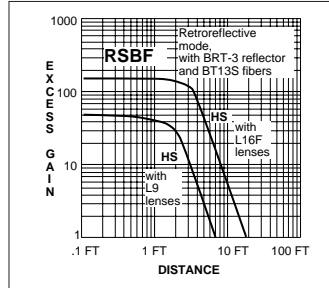
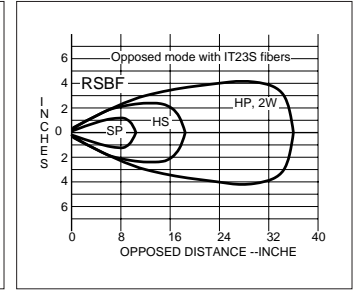
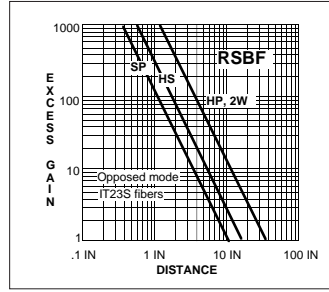

RSBFP

Range: see excess gain curves

Beam: visible red, 650nm.

Response:

HS mode only, 1ms on/off

Repeatability:

HS = 0.3ms

FIBER OPTIC Mode

(plastic fibers)

OPPOSED MODE

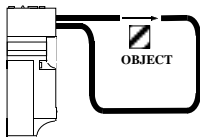

DIFFUSE MODE

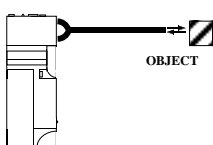

The model RSBFP will function only when programmed for the "HS" response mode.

The model RSBFP will not operate with 2-wire power blocks (models R2PBA and R2PBB).

For information on the complete line of Banner plastic fiber optics, see Banner product catalog.

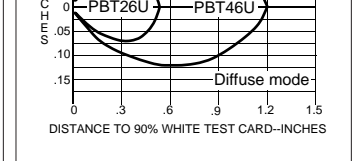
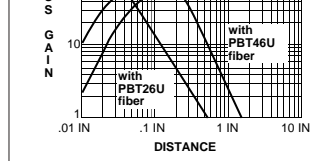
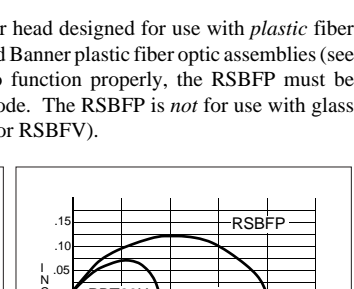
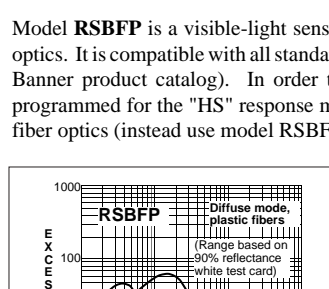
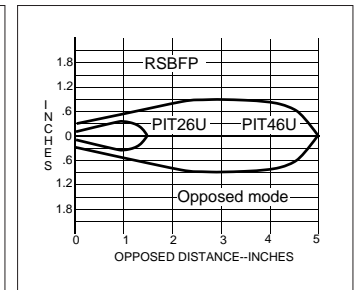
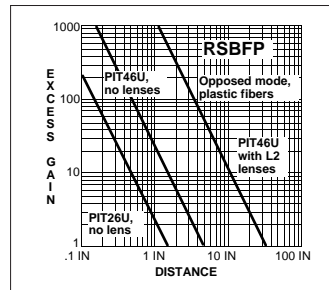

Model RSBFP is a visible-light sensor head designed for use with plastic fiber optics. It is compatible with all standard Banner plastic fiber optic assemblies (see Banner product catalog). In order to function properly, the RSBFP must be programmed for the "HS" response mode. The RSBFP is *not* for use with glass fiber optics (instead use model RSBF or RSBFV).

MAXI-BEAM Sensor Heads

Sensing Mode

Models

Excess Gain

Beam Pattern



RSBFV

Range: see excess gain curves

Beam: visible red, 650nm.

Response:

HS mode only, 1ms on/off

Repeatability:

HS = 0.3ms

The model RSBFV will function only when programmed for the "HS" response mode.

The model RSBFV will not operate with 2-wire power blocks (models R2PBA and R2PBB).

Model RSBFV is a visible-light sensor head designed for use with glass fiber optics. It is compatible with all standard Banner glass fiber optic assemblies (see Banner product catalog). In order to function properly, the RSBFV must be programmed for the "HS" response mode. The RSBFV is *not* for use with plastic fiber optics (instead use RSBFP).

FIBER OPTIC Mode (glass fibers)

OPPOSED MODE

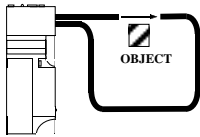

RETRO MODE

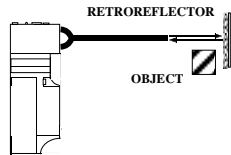

DIFFUSE MODE

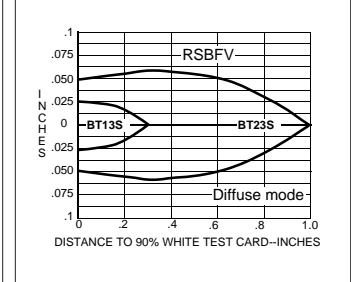
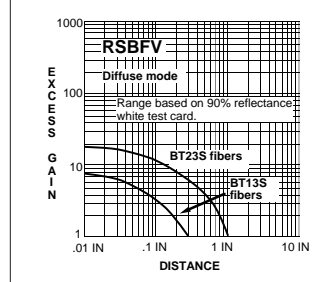
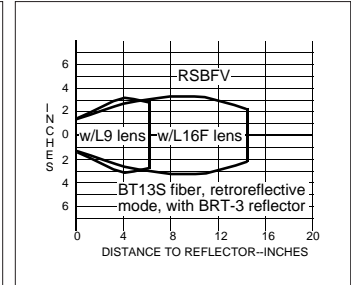
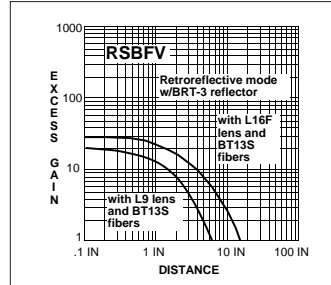
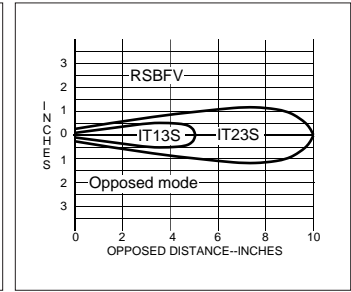
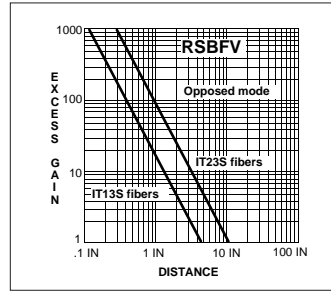
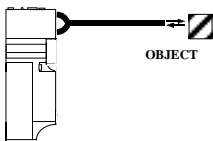

Programming the MAXI-BEAM Sensor Head

MAXI-BEAM sensor heads may be programmed for sensor response time (and range) and for LIGHT/DARK operate. Each sensor head is supplied with a programming ring which attaches below the the sensor head by a system of pegs. There are four programming notches around the perimeter of the ring. To program the sensor head, simply find the notch which will line up with the desired program combination (see diagram, right). NOTE: the programming ring may have to be turned upside-down in order to line up the notch with the program. If LIGHT OPERATE is selected, the MAXI-BEAM output will energize on a dark-to-light transition. If DARK OPERATE is selected, the MAXI BEAM output will energize on a light-to-dark transition. In the illustration, the MAXI-BEAM is set for high speed (HS) operation in the LIGHT OPERATE output state. See the information about each individual sensor head for the response time and range associated with each setting (HP, 2W, HS, SP). NOTE: when programming the RSBE, RSBSER, or RSBEF emitter, select the mode which is programmed for the receiver. EXCEPTION: if the receiver is programmed for the 2-wire (2W) mode, select high power (HP) on the emitter.

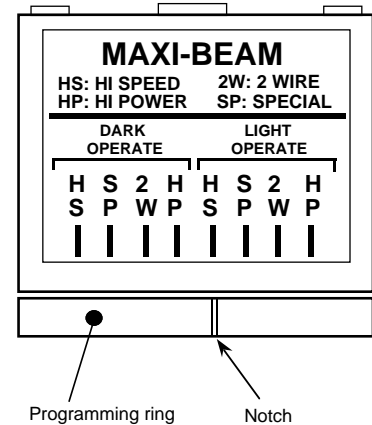

MAXI-BEAM Power Blocks and Wiring Base

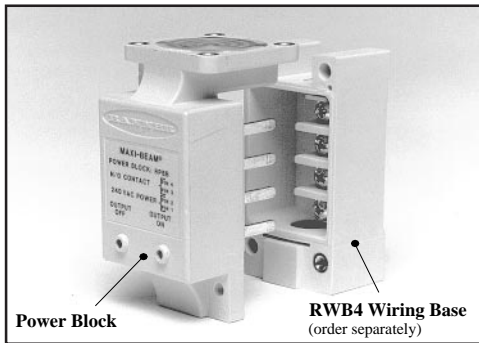

MAXI-BEAM power blocks provide regulated low voltage dc power to the sensor head and logic module (if one is used), and all power blocks (except emitter-only types) contain an output switch for interfacing to loads or to control circuitry.

Power blocks plug into the model **RWB4 wiring base** which has heavy-duty screw terminals that accept up to #12 gauge wire (no lugs are necessary). **The RWB4 wiring base is necessary for all MAXI-BEAM sensor assemblies (except sensors using the RPBTLM power block), and must be purchased separately.**

All power blocks, except the emitter-only types, include status LEDs which continuously indicate the state of the output circuit and input power. MAXI-BEAM power blocks are epoxy-encapsulated and rated for -40 to +70 degrees C (except models RPBR and RPBR2). All MAXI-BEAMs have circuitry to prevent false closure of the output on power-up.

DC Models

Connections

Functional Schematic

RPBT

UL LISTED NSF CERTIFIED

RPBT-1 (for emitters)

INPUT: 10 to 30V dc, 20mA, exclusive of load current; 10% maximum ripple.

OUTPUT: one open-collector NPN (current sinking) and one open-collector PNP (current sourcing) transistor. 250mA continuous, short-circuit and reverse polarity protected (both outputs).

ON-STATE VOLTAGE DROP:

PNP output: less than 1 volt at 10mA and less than 2 volts at 250mA.

NPN output: less than 200 millivolts at 10mA and less than 1 volt at 250mA.

OFF-STATE LEAKAGE CURRENT: less than 10 microamps.

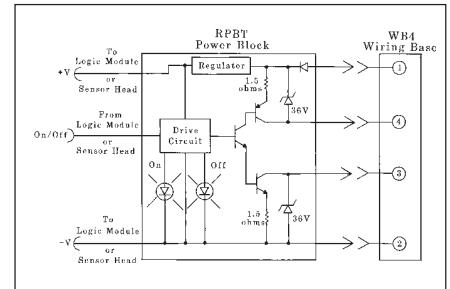
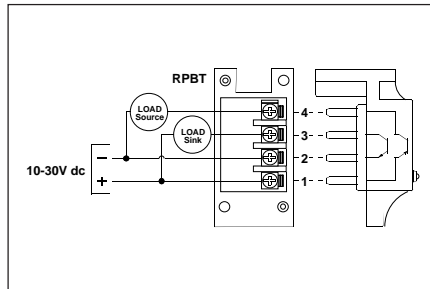

Power block RPBT is the one most often used in low voltage dc applications. There are two solid state output switches (transistors), each rated at 1/4 amp. The NPN output at terminal #3 of the wiring base sinks current to the negative side of the power supply. The PNP output at terminal #4 sources current to the load from the positive side of the power supply. Both outputs may be used simultaneously. Response time of a MAXI-BEAM which uses model RPBT is the response time which is programmed at the sensor head (plus logic delays, if any). Model RPBT-1 is the dc power block to use with model RSBE, RSBSR, and RSBEF emitter sensor heads. The RPBT-1 has no switching elements.

Hookup Diagrams for RPBT and RPBT-1 Power Blocks

Hookup to dc Relay or Solenoid (using sinking output)

When using the power block with current sinking (NPN) output, simple loads connect between terminal #3 and the positive supply (terminal #1).

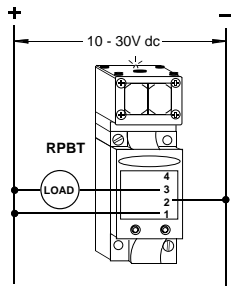

Hookup to dc Relay or Solenoid (using sourcing output)

When using the power block with current sourcing (PNP) output, simple loads connect between terminal #4 and dc common (terminal #2).

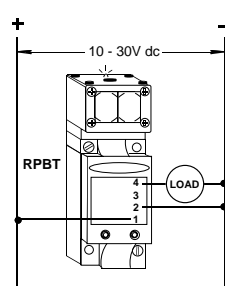

Hookup to Logic Gate (using sinking output)

A logic zero (0 volts dc) is applied to the GATE input when the MAXI-BEAM sinking output is energized. When de-energized, a logic one is applied. The logic supply must be common to the MAXI-BEAM supply negative.

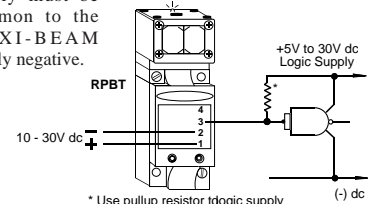

Hookup to a Programmable Controller requiring a current sink

Use MAXI-BEAM NPN output (terminal #3) to interface to PLCs and other logic devices requiring a current sink at the inputs. Connect terminal #3 of the power block to any input of the PLC. Also connect the negative of the MAXI-BEAM power supply (terminal #2) to the negative of the PLC power supply.

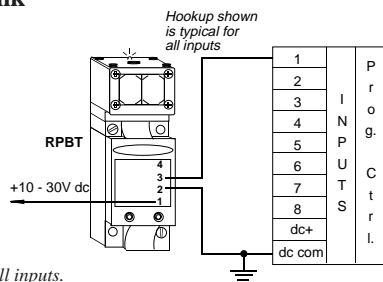

Hookup to a Programmable Controller requiring a current source

Use MAXI-BEAM PNP output (terminal #4) to interface to PLCs and other logic devices requiring a current source at the inputs. Connect terminal #4 of the power block to any input of the PLC. Connect the negative of the MAXI-BEAM power supply (terminal #2) to the negative of the PLC power supply.

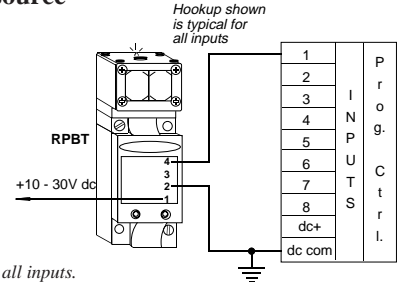

MAXI-BEAM Power Blocks and Wiring Base

Hookup Diagrams for RPBT and RPBT-1 Power Blocks (continued)

Parallel Hookup of RPBT Power Blocks to a Common Load

Any number of MAXI-BEAMs may be connected in parallel to a load to create "LIGHT-OR" (light operate mode) or "DARK-OR" (dark operate mode) multiple sensor logic. The diagram at the right shows the current sinking outputs of two MAXI-BEAMs connected in parallel to control a load which requires a current sink (power block terminal #3). For loads requiring a current source, connect the wires from the load instead between terminals #4 and #2 (common). NOTE: series connection of dc MAXI-BEAM sensors may be accomplished using power block model RPBR (see below).

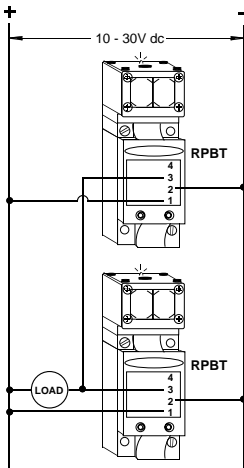

Hookup of a DC Emitter

MAXI-BEAM emitter only sensor heads use dc power block model RPBT-1, which connects directly across the dc supply as shown.

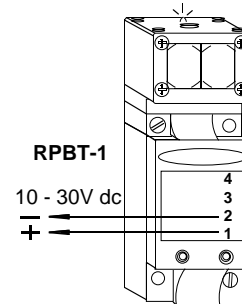

Hookup to MAXI-AMP Logic Module

The current sinking output of MAXI-BEAM power block RPBT may be connected directly to the input of CL Series MAXI-AMP modules. A MAXI-AMP which is powered by ac voltage offers a dc supply with enough capacity to power one MAXI-BEAM sensor, as is shown in this hookup diagram. When an emitter/receiver pair is used, the emitter should be powered from a separate power source (e.g. - use power block RPBA-1, etc.).

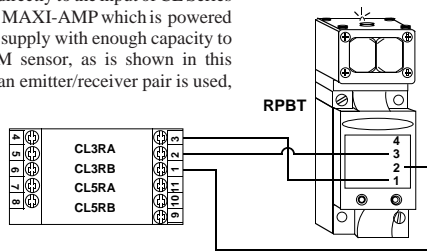

Hookup to MICRO-AMP Logic (MPS-15 Chassis)

The current sinking output of an RPBT power block may be connected directly to the primary input (terminal #7) or the other inputs of MICRO-AMP logic modules. The following logic modules may be used:

- MA4-2 One shot
- MA5 On/off delay
- MA4G 4-input "AND"
- MA4L Latch

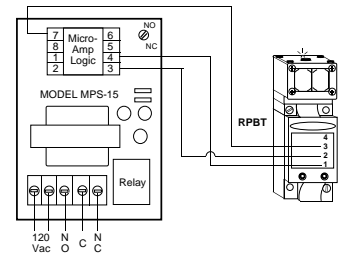

AC/DC Model

Connections

Functional Schematic

RPBR

INPUT: 12 to 30V dc, 40mA, exclusive of load current (at 30V dc); or 12 to 250V ac, 50/60Hz.

OUTPUT: SPST electromechanical relay contact. Contact rating: 250V ac max., 30V dc max., 5 amps max. (resistive load); install MOV across contact if switching inductive load. Contact response: 20ms open and close (NOTE: add to sensor head response). Mechanical life: 10,000,000 operations.

OPERATING TEMPERATURE: -40 to +50 degrees C (-40 to +122 degrees F).

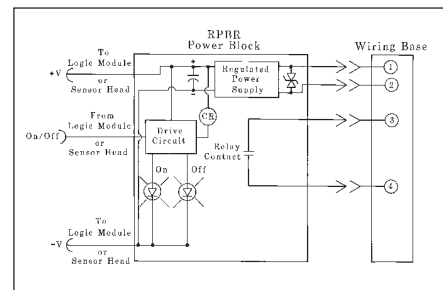
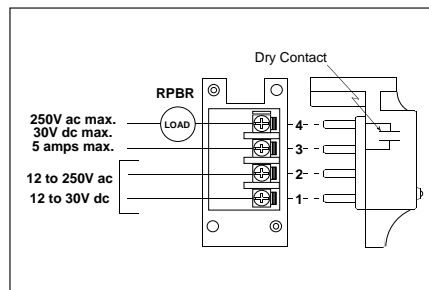

Model RPBR operates the MAXI-BEAM with either ac or dc. It offers an SPST "hard" relay contact between wiring base terminals #3 & #4, which allows the MAXI-BEAM sensor to directly interface with loads which draw high current. It also allows series connection ("AND" logic) with multiple dc sensors.

Application caution: power block models RPBR and RPBR2

Power block modules RPBR and RPBR2 use "partial phase firing" power conversion to enable their wide range of ac input voltage (12 to 250V ac). AC power is applied to the sensor for only a small portion of each ac half-cycle. The current demand during this period may be as high as 1 to 2 amps per sensor.

The collective current demand of several of these sensors on a common ac line is significant. If several sensors are wired *directly to the ac mains*, it is unlikely that any adverse effects will be noticed. On the other hand, problems may be noticed if several sensors are connected to a common circuit that is *isolated from the ac mains* by a transformer. The collective peak current demand may rob other components on the same circuit of enough power to function properly. In the worst case, a transformer with

inadequate reserve current capacity may overheat. Barring a transformer failure, the sensors themselves will operate normally.

As a general rule, if more than three or four MAXI-BEAM sensors using RPBR or RPBR2 power blocks must be connected to the same transformer-isolated ac circuit, consider the substitution of power block model **RPBAR2** (for 105-130V ac) or model **RPBBR2** (for 210-250V ac), which use conventional ac-to-dc power conversion circuitry. These power blocks connect exactly like model RPBR2, but do not exhibit the peak power demand of a phase-fired design. Output relay specifications are identical to model RPBR2. Contact your Banner representative or distributor for pricing and availability.

NOTE: Peak power demand is not an issue when the RPBR or RPBR2 are powered from direct current (12 to 30V dc).

MAXI-BEAM Power Blocks and Wiring Base

AC Models

Connections

Functional Schematic

RPBR2

INPUT: 12 to 160V dc, 40mA, exclusive of load current (at 30V dc); or 12 to 250V ac, 50/60Hz.

OUTPUT: SPDT electromechanical relay contacts. Contact rating: 250V ac max., 30V dc max., 5 amps max. (resistive load); install MOV across contact if switching inductive load. Contact response: 20ms open and close (NOTE: add to sensor head response). Mechanical life: 10,000,000 operations.

OPERATING TEMPERATURE: -40 to +50 degrees C (-40 to +122 degrees F).

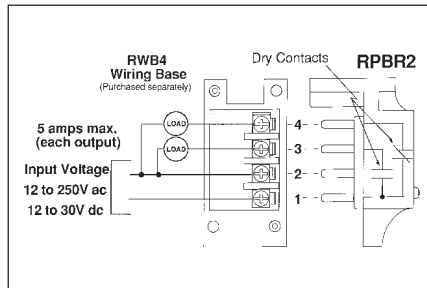

RPBR2 is an SPDT output version of model RPBR, with both contacts common to terminal #1. Terminal #3 is normally open; terminal #4 is normally closed. See application caution, page 9.

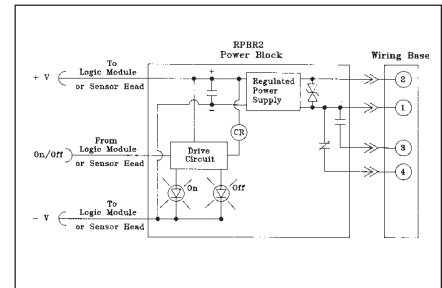

3- and 4-wire operation

RPBA

UL LISTED SP CERTIFIED

INPUT: 105 to 130V ac, 50/60Hz; 2 watts exclusive of load.

RPBB

UL LISTED SP CERTIFIED

INPUT: 210 to 250V ac, 50/60Hz; 2 watts exclusive of load.

OUTPUT: SPST solid-state switch for ac, 3/4 amp maximum (derated to 1/2 amp at 70 degrees C). Maximum inrush 10 amps for one second or 30 amps for one ac cycle (non-repeating). On-state voltage drop of less than 2.5V ac at full load. Off-state leakage current less than 100 microamps.

NOTE: ac loads require up to 8.3 milliseconds to turn OFF in addition to the response time of the sensor head and delay logic (if any).

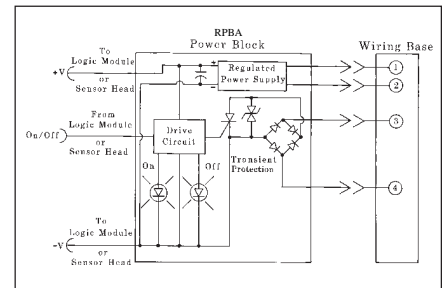
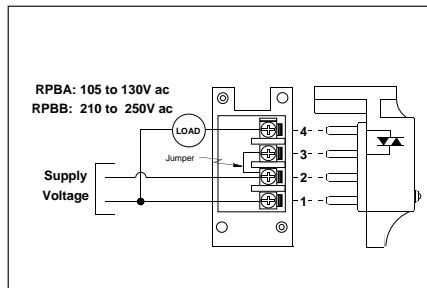

Power block models RPBA and RPBB are the most commonly used for ac MAXI-BEAM operation. As the typical hookup shows, they are intended to switch the same ac voltage as is used to power the MAXI-BEAM. However, both can switch any ac voltage that is lower than the supply voltage, as long as both ac circuits share a common neutral. Observe local codes whenever mixing ac voltages in a common wiring chamber.

These blocks are designed to handle the inrush current of ac inductive loads like motor starters and solenoids. There is no minimum load requirement, and they will interface directly to inputs of all ac programmable logic controllers (PLCs). Special order models **RPBAT** (120V ac) and **RPBBT** (240V ac) are available for interfacing to *dc* loads of up to 100 milliamps.

RPBA-1

UL LISTED SP CERTIFIED

For RSBE, RSBESR, and RSBEF emitters
INPUT: 105 to 130V ac, 50/60Hz; 2 watts.

RPBB-1

UL LISTED SP CERTIFIED

For RSBE, RSBESR, and RSBEF emitters
INPUT: 210 to 250V ac, 50/60Hz; 2 watts.

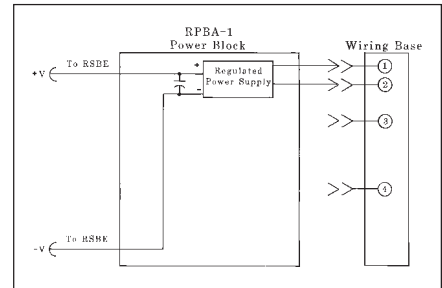
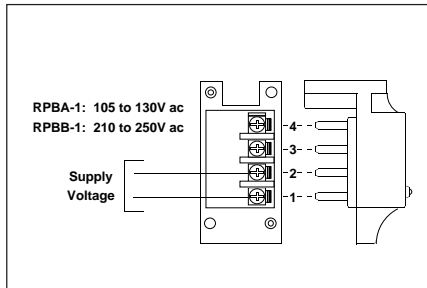

2-wire operation

R2PBA

UL LISTED SP CERTIFIED

INPUT: 105 to 130V ac, 50/60Hz; 2 watts exclusive of load

R2PBB

UL LISTED SP CERTIFIED

INPUT: 210 to 250V ac, 50/60Hz; 2 watts exclusive of load.

OUTPUT: SPST solid-state switch for ac, 3/4 amp maximum (derated to 1/2 amp at 70 degrees C). Maximum inrush 10 amps for one second (non-repeating).

On-state voltage drop: 5.2V rms at a 1/2 amp load; 14V rms at a load of 10 milliamps.

Off-state leakage current less than 1.7 milliamp (resistive or inductive load).

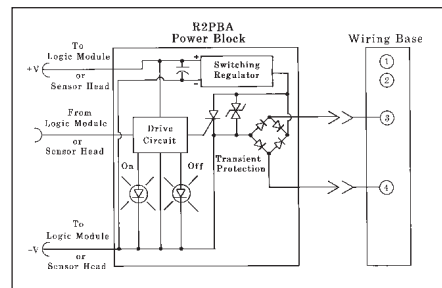
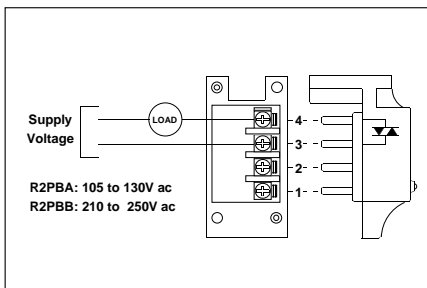

Power block models R2PBA and R2PBB both offer the simplicity of wiring which is associated with 2-wire sensor design. They wire directly in series with an ac load, exactly like a limit switch. Use of a 2-wire power block requires programming of the sensor head to the "2W" (2-wire) operating mode. As a result, MAXI-BEAM sensing response time is fixed at 10 milliseconds for 2-wire operation. There are some hookup considerations which are unique to 2-wire interfaces. See hookup information on page 12 for details.

MAXI-BEAM Power Blocks and Wiring Base

Hookup Diagrams for RPBA, RPBA-1, RPBB, & RPBB-1 Power Blocks

Hookup to a Simple Load

AC voltage is connected to terminals #1 and #2 to provide power to the MAXI-BEAM. The solid-state output switch behaves as if there were a contact between terminals #3 and #4. L1 is most conveniently applied to terminal #3 by jumpering terminals #1 and #3 inside the wiring base. Alternatively, the load could be installed between terminal #3 and L1, with L2 connected to terminal #4 by jumpering from #2 to #4.

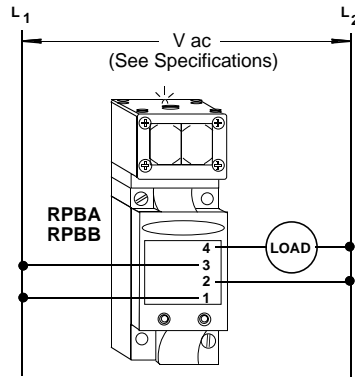

CAUTION: the output switch will be destroyed if the load is shorted.

Hookup of an ac Emitter

MAXI-BEAM emitter-only sensor heads use ac power block model RPBA-1 (120V ac) or RPBB-1 (220/240V ac) which connect directly across the line, as shown.

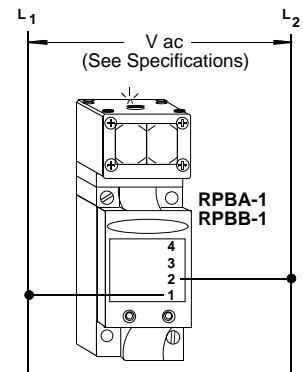

Hookup in Parallel or Series with Contacts or Switches

Any number of "hard" contacts may be wired in series or in parallel to MAXI-BEAMs which use power block model RPBA or RPBB.

This circuit illustrates a start-stop function in which CR can be energized only when the MAXI-BEAM output is energized. Once energized, CR is latched ON by its normally open contact. CR is reset by depressing the STOP switch.

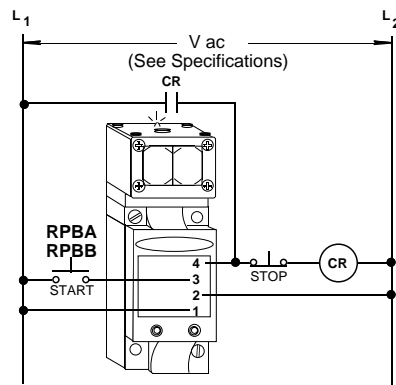

Hookup to Programmable Logic Controller (PLC)

Interfacing to a PLC I/O is direct with MAXI-BEAMs which use RPBA or RPBB. The off-state leakage current is only 100 microamps (0.1 milliamp) maximum.

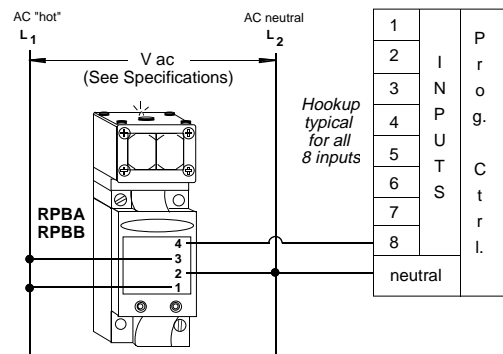

Hookup in Series with other MAXI-BEAMs

MAXI-BEAMs which use RPBA or RPBB power blocks may be wired in series for the "AND" logic function. The total voltage drop across the series will be the sum of the individual voltage drops across each power block (approximately 3 volts per block). With most loads, 10 or more sensors may be wired together in series.

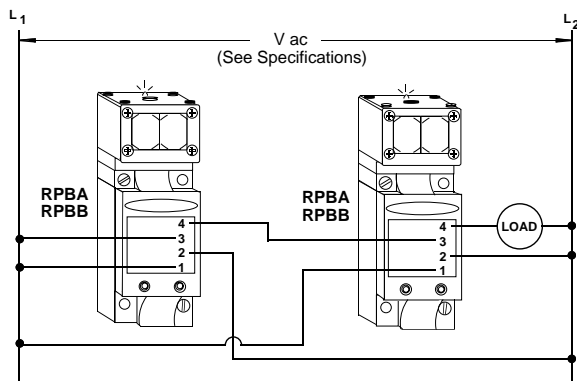

Hookup in Parallel with other MAXI-BEAMs

Any number of MAXI-BEAMs using RPBA or RPBB power blocks may be wired together in parallel to a load. Parallel sensor connection is usually used to yield "OR" logic (i.e.-if an event occurs at any sensor, the load is energized).

The total off-state leakage current through the load is the sum of the leakage currents of the individual power blocks. However, the maximum leakage current of MAXI-BEAM RPBA or RPBB power blocks is only 100 microamps. As a result, the installation of an artificial load resistor in parallel with the load is necessary only for very large numbers of sensors wired in parallel to a light (i.e.-high impedance) load.

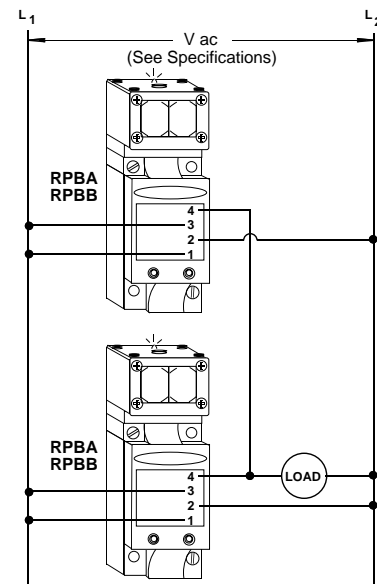

MAXI-BEAM Power Blocks and Wiring Base

Hookup Diagrams for R2PBA and R2PBB Power Blocks

Basic 2-wire Hookup

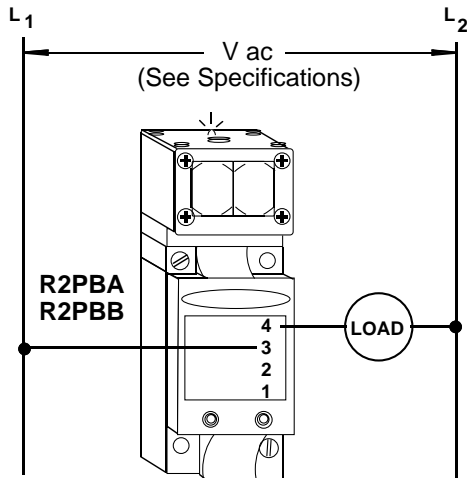

MAXI-BEAM sensors using power block R2PBA or R2PBB wire in series with an appropriate load. This combination, in turn, wires directly across the ac line. A 2-wire sensor may be connected exactly like a mechanical limit switch.

The MAXI-BEAM remains powered when the load is OFF by a residual current which flows through the load. This off-state leakage current is always less than 1.7 milliamps. The effect of this leakage current depends upon the characteristics of the load. The voltage which appears across the load in the OFF state is equal to the leakage current of the sensor multiplied by the resistance of the load:

$$V(\text{off}) = 1.7\text{mA} \times R(\text{load}).$$

If this resultant OFF state voltage is less than the guaranteed turn-off voltage of the load, then the interface is direct. If the OFF state voltage causes the load to stay ON, then an artificial load resistor must be connected in parallel with the load to lower its effective resistance. Most loads, including most programmable logic controller (PLC) inputs, will interface to 2-wire sensors with 1.7mA leakage current, without the need for an artificial load resistor.

There is no polarity requirement. Either wire may be connected to terminal #3, and the other to terminal #4.

CAUTION: all components of a MAXI-BEAM 2-wire sensor assembly will be destroyed if the load becomes a short circuit.

2-wire MAXI-BEAMs in Parallel

Multiple 2-wire MAXI-BEAMs may be wired together in parallel to a load for "OR" or "NAND" logic functions. When sensors are wired in parallel, the off-state leakage current through the load is equal to the sum of the leakage currents of the individual sensors. Consequently, loads with high resistance like small relays and electronic circuits may require artificial load resistors.

MAXI-BEAM sensors have a 100 millisecond power-up delay for protection against false outputs. When 2-wire MAXI-BEAMs are wired together in parallel, any power block which has an energized output will rob all other 2-wire power blocks of the voltage needed to operate the sensor. When the energized output drops, there will be a 0.1 second delay before any other MAXI-BEAM can energize. As a result, the load may momentarily drop out.

2-wire MAXI-BEAM sensors cannot wire in series with other 2-wire sensors. If series connection of 2-wire AC sensors is required, consider models within the VALU-BEAM or MINI-BEAM sensor families. 4-wire ac power blocks can wire in series (see RPBA, RPBB).

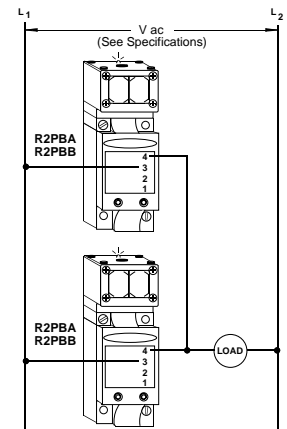

2-wire MAXI-BEAMs with Parallel Contacts

2-wire MAXI-BEAM sensors may be wired in parallel with mechanical switch or relay contacts. The load will energize when either a contact closes or the sensor output is energized. When a contact is closed, it shunts the operating current away from the MAXI-BEAM. As a result, when all of the contacts open, the MAXI-BEAMs 0.1 second power-up delay may cause a momentary drop-out of the load.

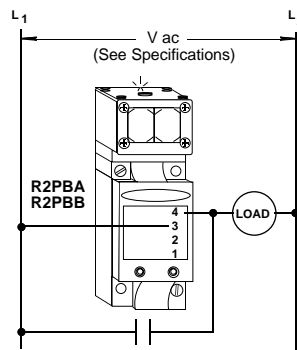

2-wire MAXI-BEAMs with Series Contacts

When 2-wire MAXI-BEAM sensors are connected in series with mechanical switch or relay contacts, the sensor will receive power to operate only when all of the contacts are closed. The false-pulse protection circuit of the MAXI-BEAM will cause a 0.1 second delay between the time that the last contact closes and the time that the load can energize.

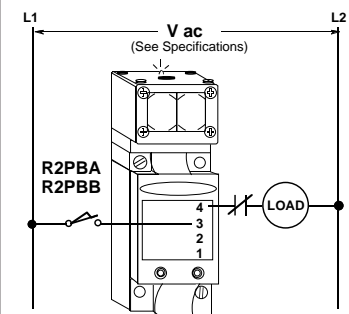

Hookup of 2-wire MAXI-BEAMs to a Programmable Logic Controller (PLC)

MAXI-BEAM 2-wire sensors operate with low (1.7mA) off-state leakage current. As a result, they will interface directly to most PLCs without the need for an artificial load resistor. If the off-state voltage (1.7mA x input resistance of PLC) is higher than the PLC sensing threshold, install a 10KΩ to 15KΩ, 5 watt resistor for each 2-wire sensor. The resistor connects between the input terminal and ac neutral.

If you have a question on hookup to a specific brand of PLC, contact the Banner Applications Department during normal business hours.

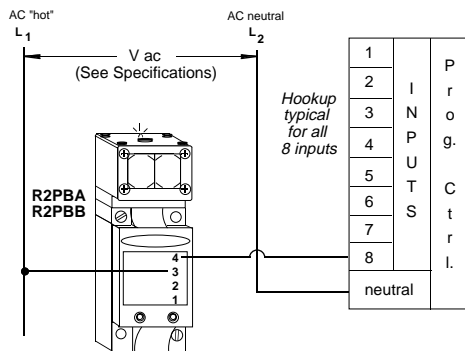

Photoelectric Latch with Manual Reset

ICR relay will latch ON whenever the 2-wire MAXI-BEAM output is energized. ICR is reset when the normally-closed pushbutton switch is pressed.

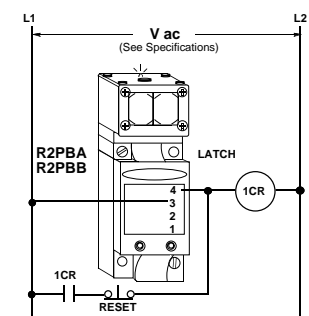

MAXI-BEAM Power Blocks

Model RPBTLM Low Profile DC Power Block

Model **RPBTLM** is a miniature dc power block for MAXI-BEAM sensors. It may be used with *any* of the MAXI-BEAM sensor head models. The RPBTLM is supplied with stainless steel hardware used for assembly of the MAXI-BEAM components. Components simply bolt together, with no interwiring necessary. The screws supplied are extra-long, and serve as a means to mount the complete MAXI-BEAM sensor assembly to an object or surface.

The RPBTLM may be attached to its sensor head at any of four 90-degree increments to allow the best cable exit direction (front, rear, or either side). A logic module may be added and can be independently rotated (in the same manner) for easiest access to the timing adjustments.

Outputs are in the bi-polar configuration: one current-sinking (NPN) *plus* one current-sourcing (PNP). This design permits direct interfacing of the MAXI-BEAM sensor to almost any type of dc logic input. Each output is rated for 150 mA. Either output may be used alone, or both may be used simultaneously. The outputs may be configured for either normally open or normally closed operation via the sensor head (or logic module) programming ring. The RPBTLM includes an LED indicator to show the output status.

The RPBTLM is completely solid-state and epoxy-encapsulated. It is gasketed to other MAXI-BEAM components by a quad-ring seal. See pages 3,7, and 14-15 for information on the assembly and programming of MAXI-BEAM sensors.



RPBTLM Dimensions

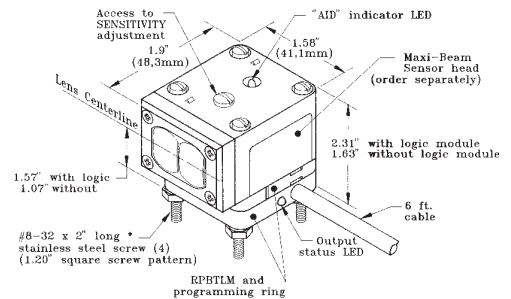

*NOTE: #8-32 x 2 1/2" long screws are also supplied with RPBTLM for assembly when a logic module is added.

Hookup Diagram

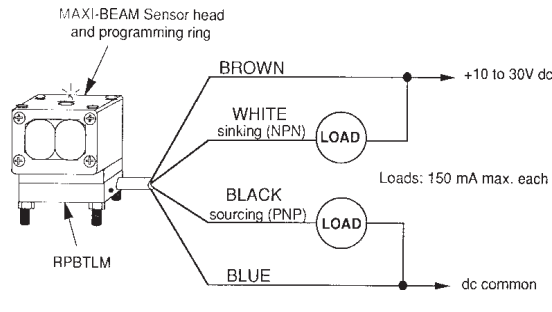

Specifications

INPUT: 10 to 30V dc, 10% maximum ripple.

OUTPUT CONFIGURATION: bi-polar. One current sinking (NPN) and one current sourcing (PNP) open-collector transistor switch.

OUTPUT RATING: 150mA maximum each output at 25°C (derated to 100mA at 70°C). Derate 1mA per °C.

OUTPUT PROTECTION: protected against false pulse on power-up, inductive load transients, power supply polarity reversal, and continuous overload or short-circuit of outputs.

Functional Schematic

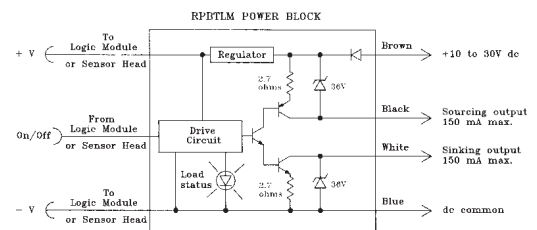

ON-STATE VOLTAGE DROP:

NPN output less than 200 millivolts at 10mA and less than one volt at 150mA. PNP output less than 1 volt at 10mA and less than 2 volts at 150mA.

OFF-STATE LEAKAGE CURRENT:

less than 1 microamp.

Model RPBU Power Block: universal power input and output

INPUT: 12-250V ac (50/60Hz) or 12-30V dc, 40mA exclusive of load at 30V dc. **OUTPUT:** Optically-isolated SPST solid-state relay; 240V ac or dc max., 100mA max. *On-state voltage drop* is 2 volts max. at 100mA (full rated load). DC hookup is without regard to polarity.

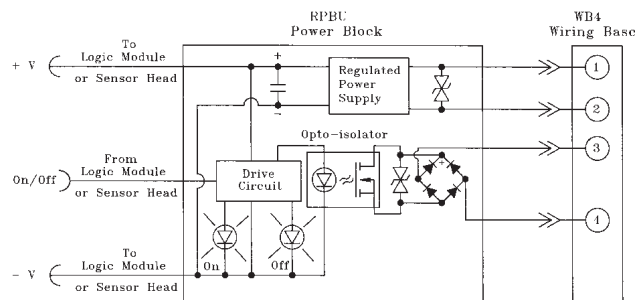
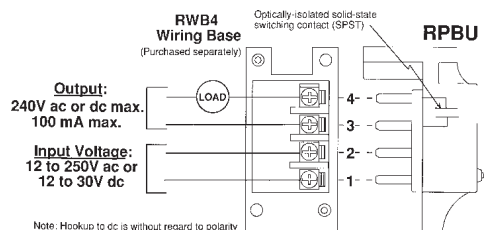

MAXI-BEAM Logic Modules



MAXI-BEAM sensors offer built-in timing logic with the addition of a logic module. There are two logic modules available. Model RLM5 is programmable for ON-DELAY, OFF-DELAY, and ON/OFF DELAY timing logic. Model RLM8 offers both ONE-SHOT and DELAYED ONE-SHOT functions. A programming ring is supplied with each logic module. Programming of the logic function, timing range, and output state is similar to sensor head programming.

Both logic modules feature 15-turn, clutched potentiometers for accurate timing adjustments. Once programmed, the logic module may be rotated in 90-degree increments to position the timing adjustments for easiest access. Logic modules are housed in the same tough molded VALOX® which is used for the other MAXI-BEAM components. The logic module and its programming ring simply slip between the MAXI-BEAM sensor head and power block (see photograph, page 3). The assembly is bolted together with no interwiring necessary. The component interfaces are quad-ring sealed.

MAXI-BEAM Logic Module Specifications

SUPPLY VOLTAGE: input power is supplied by the power block (see pages 8-13).

RESPONSE TIME:

RLM5: add sensor response delay of approximately 2% of maximum OFF-DELAY time.

RLM8: no added response time for ONE-SHOT mode.

TIMING ADJUSTMENTS: two 15-turn clutched potentiometers with brass element, accessible from outside of logic module, under o-ring gasketed cover screws.

TIMING REPEATABILITY: plus or minus 2% of the maximum time of the selected range, assuming conditions of constant operating temperature and power supply voltage.

TIMING RANGE: 15 second ranges: 0.5 to 15 seconds; 1 second ranges: 0.1 to 1 second; 0.1 second ranges: 0.01 to 0.1 second.

CONSTRUCTION: reinforced molded VALOX® housing, quad-ring gasketed. Electronics fully epoxy encapsulated. NEMA 1,3,4,12, 13.

OPERATING TEMPERATURE: -40 to +70 degrees C (-40 to +158 degrees F).

Model and Logic Functions

Programming

RLM5

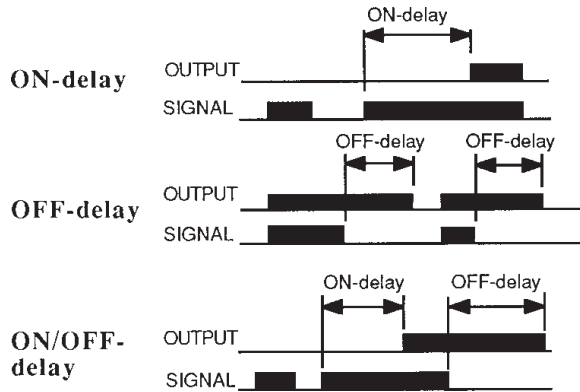

PROGRAM CHOICES:

- 1) Timing Logic Function:
 - a) ON-delay
 - b) OFF-delay
 - c) ON/OFF-delay
- 2) Timing Adjustment Range (see options below)
- 3) Output State:
 - a) normally open
 - b) normally closed

TO PROGRAM LOGIC MODULE:

- 1) Find the programming notch which lines up with the program choice. NOTE: the programming ring may have to be turned upside-down in order to find a notch that lines up with the desired program.
- 2) Press the programming ring and logic module together. They will be held together temporarily by their interlocking pegs.
- 3) Orient the logic module for easiest access to the timing adjustments, and assemble between the programming ring of the sensor head and the power block (see exploded view on page 3). Bolt all parts together with the long bolts that are supplied with the logic module.
- 4) Apply power to the MAXI-BEAM and adjust timing, using a small flat-blade screwdriver. Timing potentiometers are located behind the nylon o-ring gasketed cover screws.

Program Definition

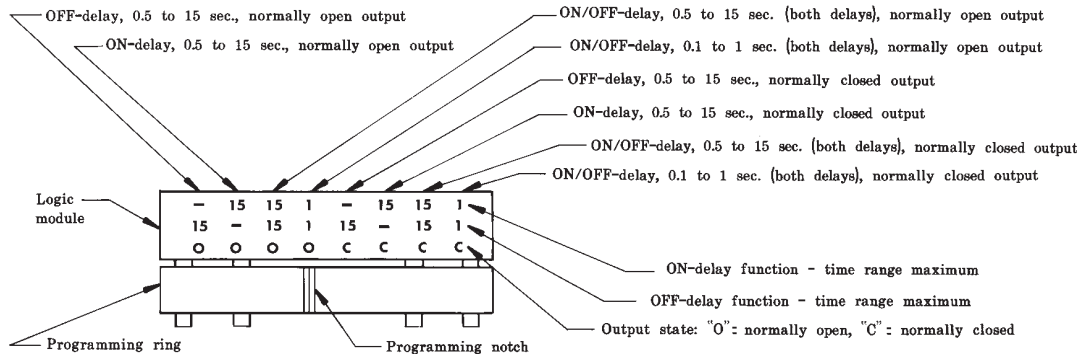

MAXI-BEAM Logic Modules

Model and Logic Functions

Programming

RLM8

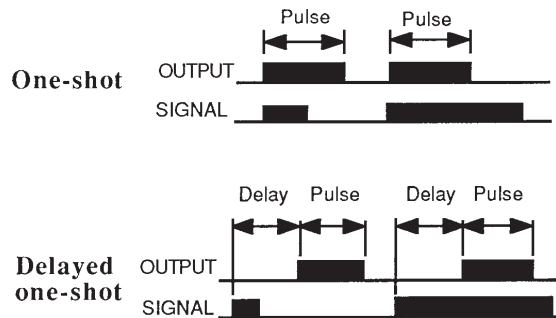

PROGRAM CHOICES:

- 1) Timing Logic Function:
 - a) ONE-SHOT
 - b) Delayed ONE-SHOT
- 2) Timing Adjustment Range (see options below)
- 3) Output State:
 - a) normally open
 - b) normally closed

TO PROGRAM LOGIC MODULE:

- 1) Find the programming notch which lines up with the program choice. NOTE: the programming ring may have to be turned upside-down in order to find a notch that lines up with the desired program.
- 2) Press the programming ring and logic module together. They will be held together temporarily by their interlocking pegs.
- 3) Orient the logic module for easiest access to the timing adjustments, and assemble between the programming ring of the sensor head and the power block (see exploded view on page 3). Bolt all parts together with the long bolts that are supplied with the logic module.
- 4) Apply power to the MAXI-BEAM and adjust timing, using a small flat-blade screwdriver. Timing potentiometers are located behind the nylon o-ring gas-ketted cover screws.

Program Definition

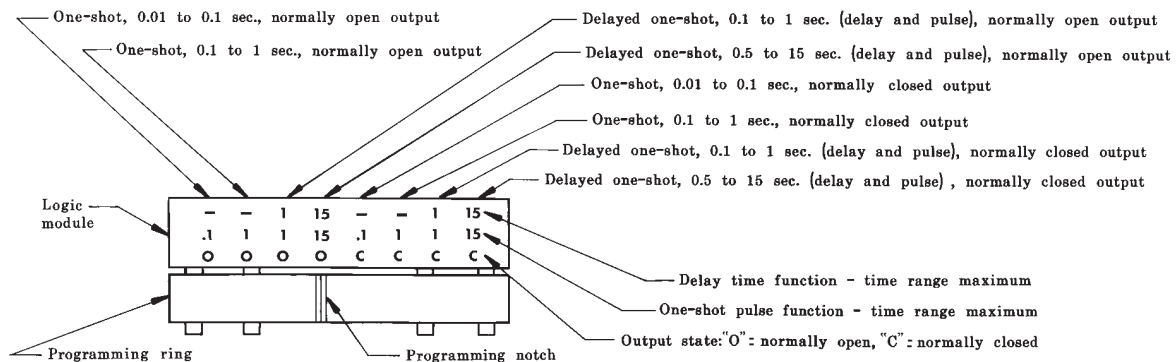

MAXI-BEAM Accessories

Replacement Upper Covers (Lens Assemblies)

An upper cover consists of the optical element for the MAXI-BEAM sensor head. An upper cover may be used as a replacement part or for modifying the optical response of a sensor. Upper cover assemblies include lens, replacement bezel, o-ring, and stainless steel screws.



Replacement Lenses

Sensor Head	Upper Cover
RSBE	RUC-L
RSBR	RUC-L
RSBLV	RUC-L
RSBLVAG	RUC-AG
RSBD	RUC-L
RSBDSR, ESR, & RSR	RUC-D
RSBC, CV	RUC-C
RSBF, FV	RUC-F
RSBFP	RUC-FP

Lens Interchangeability

CONVERSION FROM - TO	USE UPPER COVER	CONVERSION FROM - TO	USE UPPER COVER
RSBLV to RSBLVAG ...	RUC-AG	RSBLVAG to RSBLV ...	RUC-L
RSBLV to RSBCV	RUC-C	RSBCV to RSBLV	RUC-L
RSBD to RSBDSR	RUC-D	RSBDSR to RSBD	RUC-L
RSBD to RSBF	RUC-F	RSBF to RSBDSR	RUC-D
RSBDSR to RSBF	RUC-F		

MAXI-BEAM Accessories

Mounting Brackets

Model **SMB700** (right) is a general-purpose two-axis mounting bracket that is supplied with a cable gland assembly which is used to attach the MAXI-BEAM wiring base to the bracket. The gland assembly is threaded through the bracket and into the conduit entrance at the base of the scanner block. A large lockwasher is supplied to hold the scanner block firmly in place. The bracket is 11-gauge zinc plated steel.

Model **SMB700SS** is an 11-gauge stainless steel version of the SMB700. It is sold alone, without the cable gland assembly and lockwasher.

Model **SMB700F** (photo, below) is a flat, single-axis version of the SMB-700. It is sold without hardware.



Model **SMBLS** (not shown) is a two-part bracket assembly which allows adjustment in three directions. It consists of two 11-gauge zinc plated steel right-angle brackets which fasten together so that they rotate relative to each other. The MAXI-BEAM wiring base attaches to the upper bracket and slots are provided for vertical adjustment. The bottom bracket is a modified version of the SMB700. Assembly hardware and a cable gland are included.

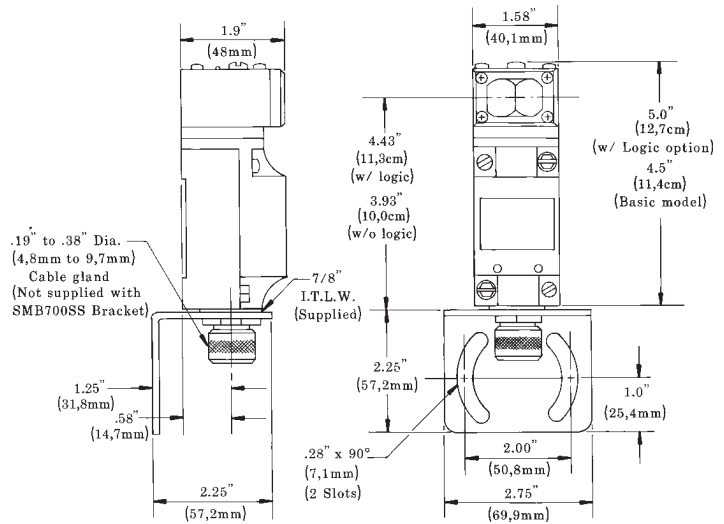

HF1-2NPS

This is a black nylon cable gland assembly for use with the **MAXI-BEAM** and other sensors having a 1/2-NPS conduit entrance. The flexible extension keeps the sensor cable from bending too sharply, and minimizes cable fatigue due to repeated flexing.

The HF1-2NPS includes a neoprene gland that accommodates cables with diameters from .20 to .35 inch for a liquid-tight seal.

This flexible gland assembly is resistant to gasoline, alcohol, oil, grease, solvents, and weak acids. It has a working temperature range of -30° to +100°C (-22 to +212°F). It is UL recognized and CSA certified.

The HF1-2NPS is sold in packages of 10 pieces.



SMB700M



Heavy-duty 1/4-inch (6mm) zinc plated steel bracket that allows the MAXI-BEAM to retrofit to installations of MICRO-SWITCH models MLS8 or MLS9 sensors. Includes cable gland and lockwasher.

SMB700P



Heavy duty 1/4-inch (6mm) zinc plated steel bracket that allows the MAXI-BEAM to retrofit to installations of PHOTOSWITCH series 42RLU and 42RPL sensors. Includes cable gland and lockwasher.

RF1-2NPS



Cable gland assembly for MAXI-BEAMs. Includes cord grips for .1 to .4 inch diameter cable. Bracket lockwasher is also included.

MBC-4

MBCC-412



MBC-4 is a 4-pin male industrial-duty connector that threads into the base of all MAXI-BEAMs. **MBCC-412** is a 12-foot long (3.6m) "SJT" type cable. It is interchangeable with standard industry types of several different manufacturers.



Product
Line
Specifications

MAXI-BEAM[®] Sensors

Highly versatile modularized photoelectric sensing controls

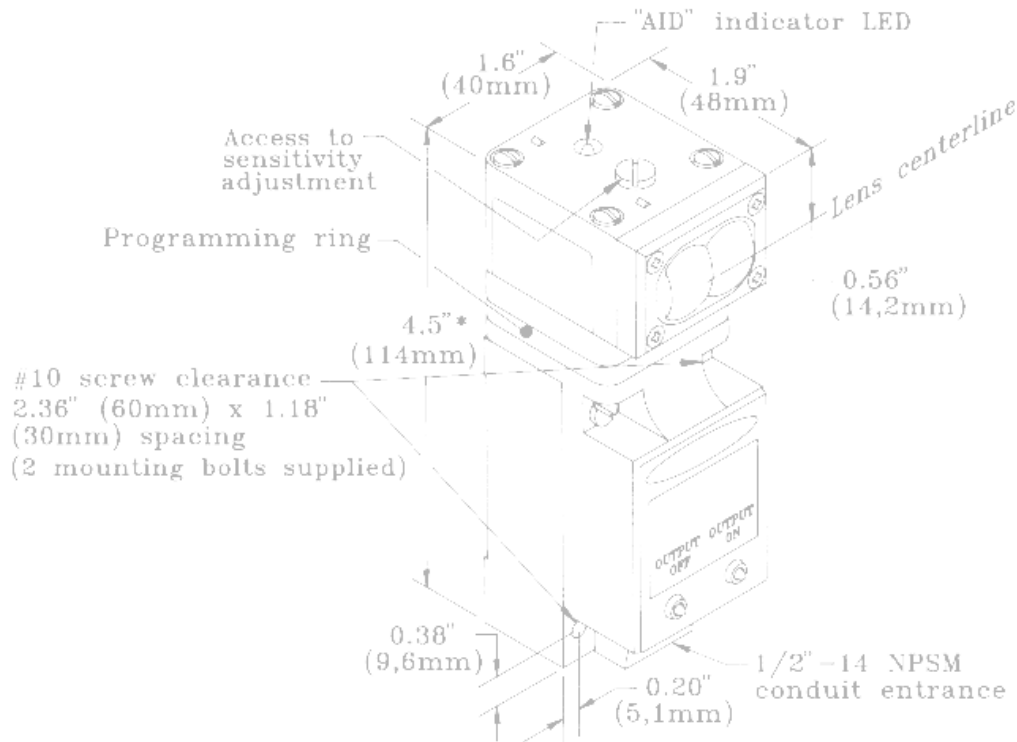

* 5.0" (127mm) with logic module and second programming ring installed.



- Highly versatile, self-contained, modularized photoelectric sensors; especially suited to industrial environments
- Wide selection of rotatable sensor heads, power blocks, and logic timing modules to suit any application
- Power blocks for AC or DC operation and for switching of AC or DC loads
- Sensor heads include patented AID™ indicator device, which lights a top-mounted LED when the sensor "sees" its own modulated light source and pulses the LED at a rate proportional to the received light signal strength
- Status indicator LEDs on power block continuously indicate the state of the output circuit
- Models are available in all sensing modes

MAXI-BEAM[®]

Modular Sensors

Banner MAXI-BEAM sensors are highly versatile, self-contained, modularized photoelectric sensing controls that are ideally suited to industrial environments. The basic MAXI-BEAM is an ON/OFF switch consisting of three modules: a sensor head, a power block, and a wiring base.

The *sensor head* contains the complete modulated photoelectric amplifier as well as the emitter and receiver optoelements. A unique, patented, "programming ring" (supplied with each sensor head) enables you to program your choice of "light" or "dark" operate mode, sensing range, and response time. MAXI-BEAM sensor heads have an easily-accessible multi-turn SENSITIVITY control for precise adjustment of system gain. Interchangeable sensor heads are rotatable in 90-degree increments, and are available in opposed, retroreflective, diffuse, convergent, and fiber optic models. Each sensor head also includes Banner's exclusive, patented Alignment Indicating Device (AID[™], U.S. patent #4356393), which lights a top-mounted LED when the sensor "sees" its own modulated light source and pulses at a rate proportional to the received light signal strength.

The *power block* provides the interface between the sensor head and the external circuit. It contains the power supply for the MAXI-BEAM plus a switching device to interface with the circuit to be controlled. DC power block versions operate on 10 to 30V dc and have solid-state sourcing and sinking outputs rated at 250mA each (maximum). AC models are available for 120V or 240V ac operation, and are offered in both 2-wire and 3- or 4-wire formats. The plug-in design of the *wiring base* enables easy exchange of the entire sensing electronics without disturbing the field wiring. Status LEDs on the power block module continuously indicate the state of the output circuit.

Optional logic modules are available which easily convert the basic ON/OFF MAXI-BEAM into either a one-shot or delay logic function control. The logic module comes with a programming ring which is used to select one of several timing ranges for each logic function. Timing adjustments are made via two 15-turn clutched potentiometers, accessible from the outside. Once programmed, the logic module may be rotated in 90-degree increments to allow time adjustment access from the most convenient location.

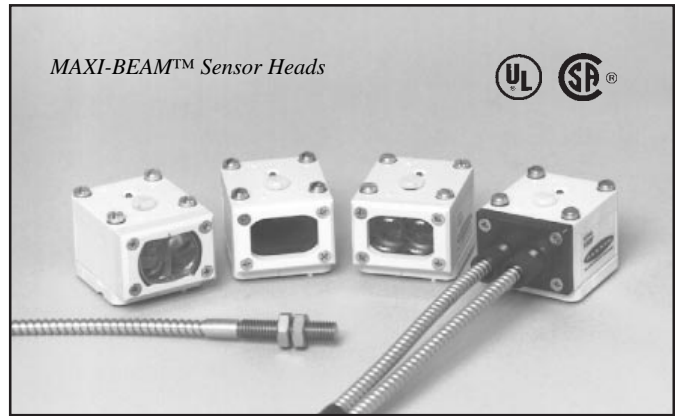

All MAXI-BEAM components are encapsulated within rugged, corrosion-resistant VALOX[®] housings which meet or exceed NEMA 1, 3, 4, 12, and 13 standards. Modules simply snap and bolt together, with no interwiring necessary. Module interfaces are o-ring and quad-ring sealed for the ultimate in dirt, dust, and moisture resistance. All MAXI-BEAM components (except for power block model RPBR) are totally solid-state for unlimited life. MAXI-BEAM assemblies have the same mounting configuration as Banner MULTI-BEAM sensors, and are physically interchangeable with heavy-duty industrial limit switches.

Most MAXI-BEAM sensors are CSA certified and UL listed. See the power block information on pages 8 to 13.



WARNING MAXI-BEAM photoelectric presence sensors do NOT include the self-checking redundant circuitry necessary to allow their use in personnel safety applications. A sensor failure or malfunction can result in *either* an energized or a de-energized sensor output condition.

Never use these products as sensing devices for personnel protection. Their use as a safety device may create an unsafe condition which could lead to serious injury or death.

Only MACHINE-GUARD and PERIMETER-GUARD Systems, and other systems so designated, are designed to meet OSHA and ANSI machine safety standards for point-of-operation guarding devices. No other Banner sensors or controls are designed to meet these standards, and they must NOT be used as sensing devices for personnel protection.

Composite Functional Schematic, MAXI-BEAM Sensors

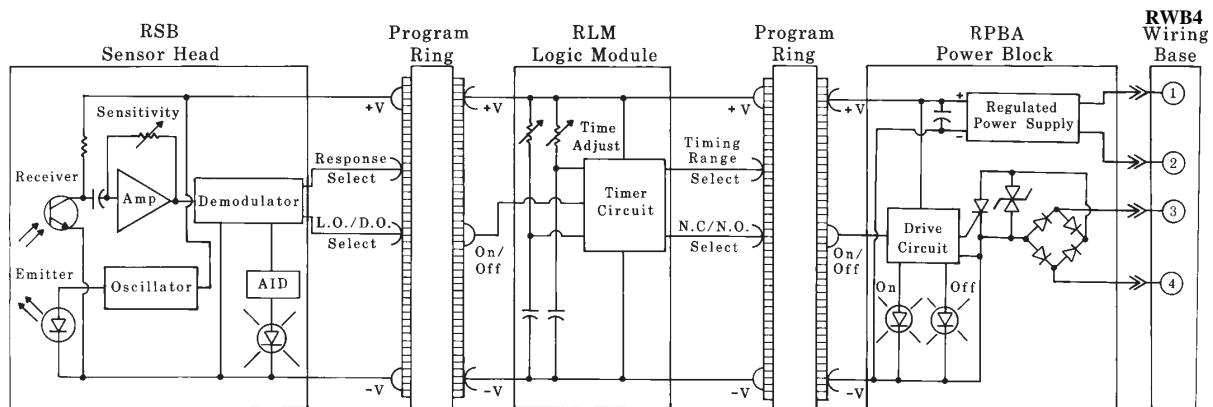

Selection of MAXI-BEAM Components

The modular design of the MAXI-BEAM allows you to create a sensor which is tailored to your exact requirements. To order a MAXI-BEAM, follow these steps:

- 1) SELECT A SENSOR HEAD** (see pages 3-7).
Sensor heads are available for opposed, retroreflective, diffuse, convergent, and fiberoptic sensing modes.
- 2) SELECT A POWER BLOCK** (see pages 8-13).
Power blocks are available for low voltage dc with either a solid-state or an electromechanical relay output. AC power blocks are available in either 2-wire design with solid-state output or 4-wire design with a choice of solid-state or electromechanical relay output.
- 3) SELECT A WIRING BASE** (see page 8, top). *Model RWB4 wiring base is used for all MAXI-BEAM assemblies (purchase separately).*
- 4) SELECT A LOGIC MODULE, if needed** (see pages 14-15).
MAXI-BEAMs operate in the ON/OFF mode (i.e. the output follows the action within the sensing beam) when no logic module is used. The addition of a programmable logic module can add process timing control as part of the MAXI-BEAM sensor assembly.
- 5) SELECT ACCESSORIES, as needed** (see pages 15-16).

MAXI-BEAM Dimensions

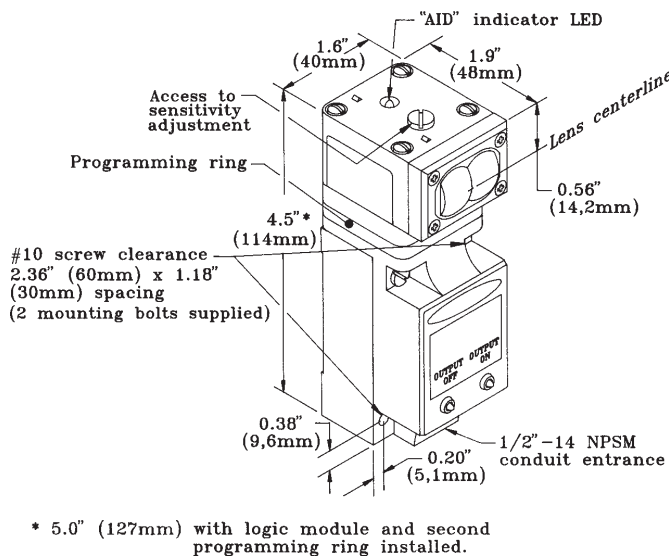

Functional Schematic, MAXI-BEAM Sensor Head

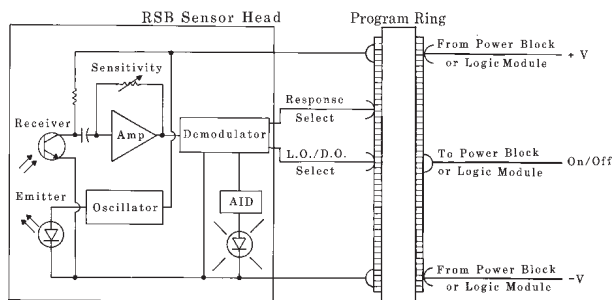

Exploded view, MAXI-BEAM Sensor

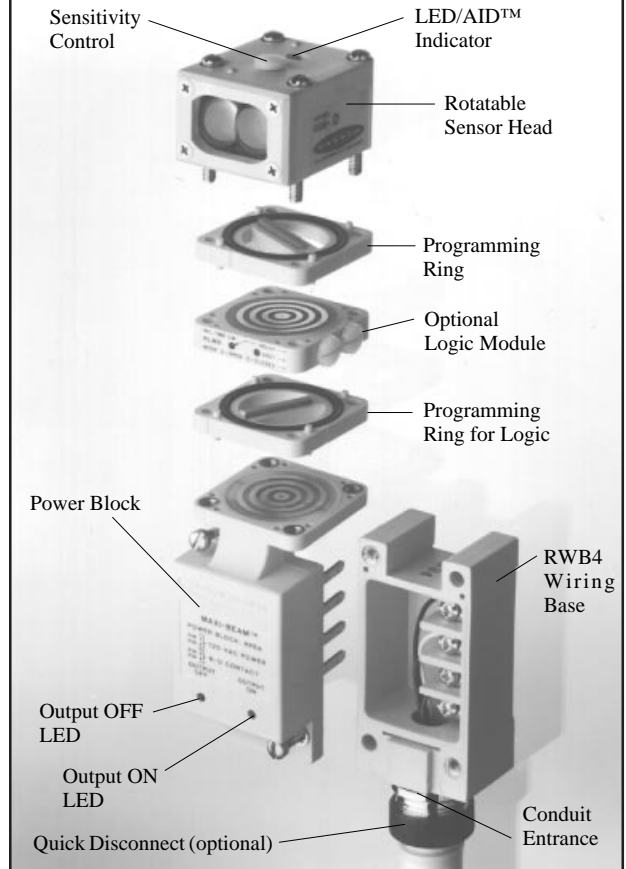

Specifications: MAXI-BEAM Sensor Heads

SUPPLY VOLTAGE:

Input power is supplied by the power block (see pages 8 to 13).

RESPONSE TIME:

Programmable for 10, 1, and 0.3 milliseconds (most models). See specifications on particular model. Independent of signal strength. NOTE: see power block specifications for information on additional output switching response delays.

REPEATABILITY OF RESPONSE:

See individual sensor specifications. NOTE: Response time and repeatability specifications are independent of signal strength.

SENSITIVITY ADJUSTMENT:

Easily accessible; located on top of sensor head beneath o-ring gasketed cover. 15-turn clutched control (rotate clockwise to increase gain).

ALIGNMENT INDICATOR:

Red LED on top of sensor head. Banner's exclusive "AID" circuit lights the LED when the sensor sees its own modulated light source and pulses the LED at a rate proportional to the received light signal strength.

CONSTRUCTION:

Reinforced molded VALOX® housing, molded acrylic lenses, o-ring and quad-ring gasketed components. Electronic components are fully epoxy-encapsulated. NEMA 1, 3, 4, 12, and 13.

OPERATING TEMPERATURE RANGE:

-40 to +70 degrees C (-40 to +158 degrees F).

FALSE-PULSE SUPPRESSION ON POWER-UP:

100 millisecond delay on power-up, all models.

MAXI-BEAM Sensor Heads

Sensing Mode

Models

Excess Gain

Beam Pattern



RSBE & RSBR
Range: 300 feet (90 m) in "HP" (high power) and 2W (2 wire) modes
Beam: infrared, 880nm; visible red tracer beam
Effective Beam: 0.5" dia.
Response:
 HP, 2W mode: 10ms on/5 off
 HS mode: 1ms on/0.5 off
 SP mode: 0.3ms on/off
Repeatability: HP, 2W= 1.4ms; HS = 0.1ms; SP = 0.04ms

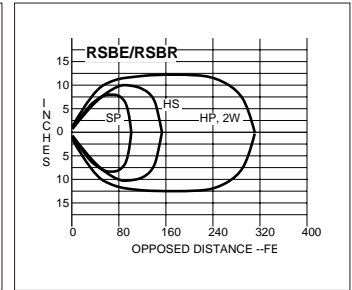
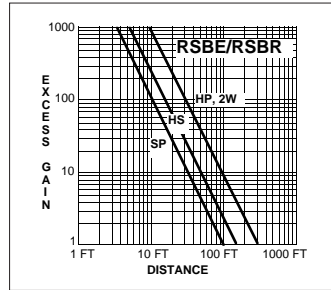

OPPOSED Mode



RSBESR & RSBRSR
Range: 15 feet (4.5m) in "HP" (high power) and 2W (2 wire) modes
Beam: infrared, 880nm
Response:
 HP, 2W modes: 10ms on/5 off
 HS mode: 1ms on/0.5 off
 SP mode: 0.3ms on/off
Repeatability: HP, 2W= 1.4ms; HS = 0.1ms; SP = 0.04ms

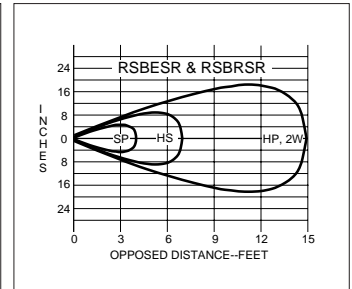
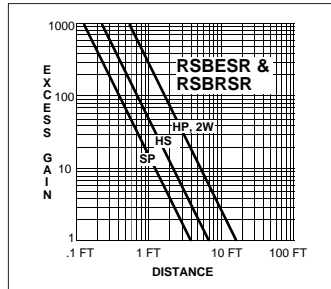

MAXI-BEAM emitters have a visible red "tracer beam". This beam is non-active, and is used as a means of visual alignment during installation. A retroreflector temporarily attached to the receiver lens provides an effective target for the tracer beam during alignment. The narrow beam of the RSBESR/RSBRSR pair is ideal for sensing small parts (effective beam diameter is 0.14 inch).

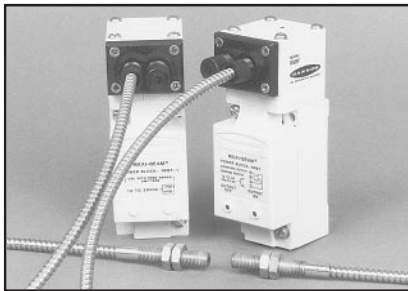

RSBEF & RSBRF
Range: see excess gain curves
Beam: infrared, 880nm.
Response:
 HP, 2W modes: 10ms
 HS mode: 1ms
 SP mode: 0.3ms on/off
Repeatability: HP, 2W= 3.3ms; HS = 0.3ms; SP = 0.1ms

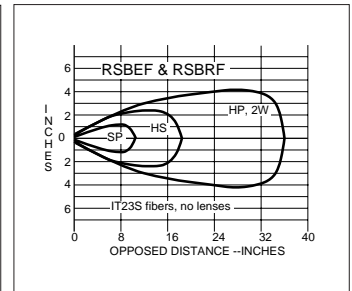
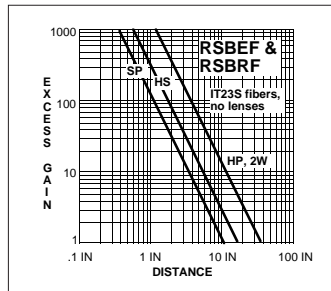

OPPOSED FIBER OPTIC Mode (glass fibers)

This sensor pair is designed for opposed mode operation using Banner glass fiber optics. Maximum range (HP mode) using L9 lenses is 12 feet. Maximum range using L16F lenses is 50 feet.



RSBLV
Range: 6 inches to 30 feet (9 m) in all program modes
Beam: visible red, 650nm
Response:
 HP, 2W, SP modes: 4ms
 HS mode: 1ms
Repeatability:
 HP, 2W, SP = 1.3ms; HS = 0.3ms

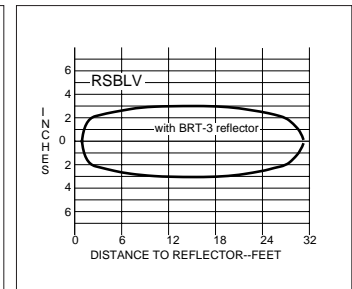
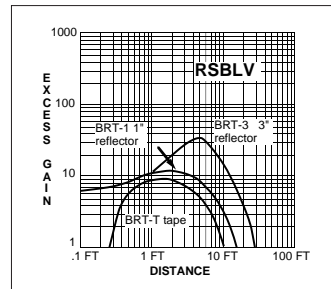

RETROREFLECTIVE Mode



RSBLVAG
 (anti-glare filter)
Range: 1 to 15 feet (4.5 m) in all program modes
Beam: visible red, 650nm; with polarizing filter
Response:
 HP, 2W, SP modes: 4ms
 HS mode: 1ms
Repeatability: HP, 2W, SP = 1.3ms; HS = 0.3ms

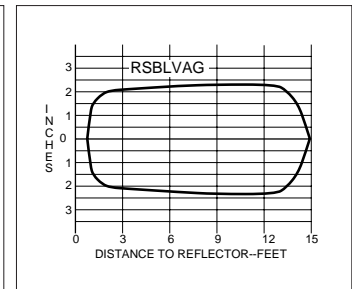
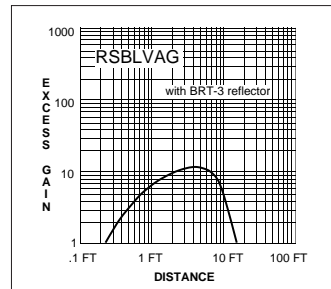

MAXI-BEAM Sensor Heads

Sensing Mode

Models

Excess Gain

Beam Pattern



RSBD

Range: 5 feet (1,5 m) in HP and 2W modes
Beam: infrared, 880nm
Response:
 HP, 2W modes: 10ms
 HS mode: 1ms
 SP mode: 0.3ms
Repeatability: HP, 2W= 3.3ms; HS = 0.3ms; SP = 0.1ms

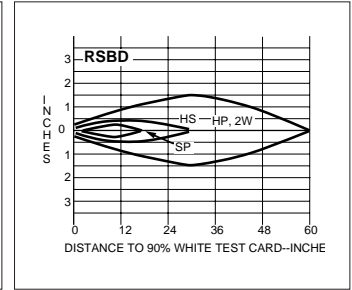
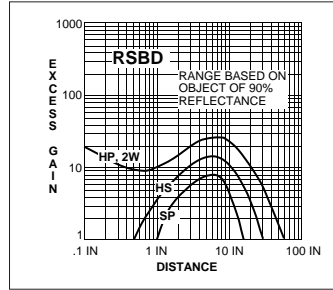

DIFFUSE Mode



RSBDSR (short range)

Range: 30 inches (76cm) in HP and 2W modes
Beam: infrared, 880nm
Response:
 HP, 2W modes: 10ms
 HS mode: 1ms
 SP mode: 0.3ms
Repeatability: HP, 2W= 3.3ms; HS = 0.3ms; SP = 0.1ms

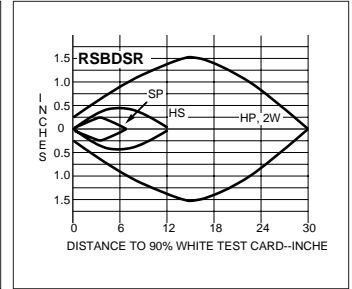
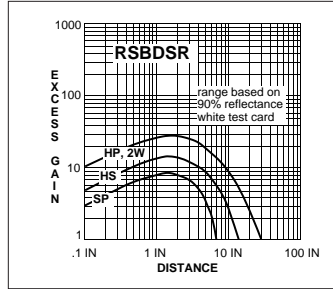

RSBC

Focus at 1.5 in. (38mm)
Beam: infrared, 940nm
Response:
 HP, 2W modes: 10ms
 HS mode: 1ms
 SP mode: 0.3ms
Repeatability:
 HP, 2W= 3.3ms; HS = 0.3ms; SP= 0.1ms

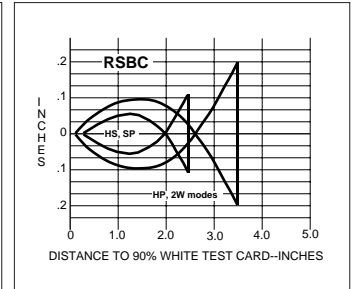
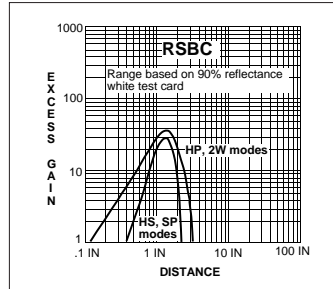

CONVERGENT Mode



RSBCV

Focus at 1.5 in. (38mm); performance equal in all program modes.
Beam: visible red, 650nm.
Response:
 HP, 2W, SP modes: 4ms
 HS mode: 1ms
Repeatability:
 HP, 2W, SP= 1.3ms; HS = 0.3ms

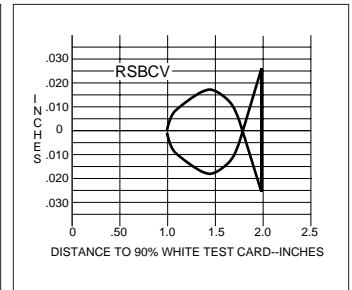
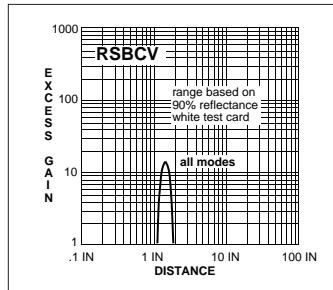

Powerful infrared beam reliably senses objects of low reflectivity. Ideal for counting the flow of radiused products at a fixed distance from the sensor.

Powerful visible red beam detects small objects only a fraction of an inch away from backgrounds. Useful in many high-contrast color registration applications.

FIXED-FIELD Mode

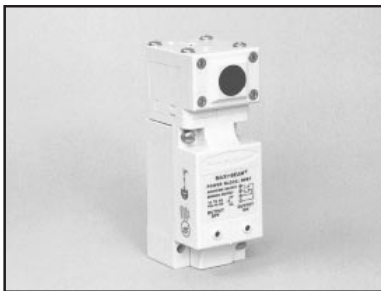

RSBFF models

Far limit cutoff at: 50mm (model RSBFF50) or 100mm (model RSBFF100)
Beam: infrared, 880nm.
Response:
 HP mode: 10ms
Repeatability:
 HP mode: 3.3ms

Fixed-field sensor heads have an emitter element and two differently-aimed receiver elements. This creates a high-gain sensing field able to detect objects of low reflectivity, and a sharp far-limit sensing cutoff of 50mm (2 inches) or 100mm (4 inches) which ignores backgrounds beyond cutoff.

These sensors are ideal for detecting a part or surface that is only a fraction of an inch in front of another surface.

RSBFFs may not be used with 2-wire power blocks.

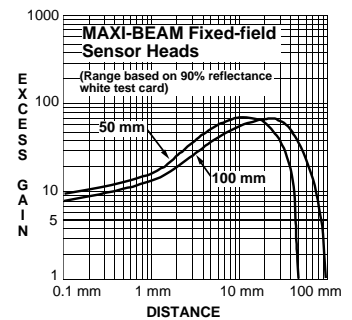

MAXI-BEAM Sensor Heads

Sensing Mode

Models

Excess Gain

Beam Pattern



RSBF

Range: see excess gain curves

Beam: infrared, 880nm

Response:

HP, 2W modes: 10ms

HS mode: 1ms

SP mode: 0.3ms

Repeatability:

HP, 2W = 3.3ms;

HS = 0.3ms;

SP = 0.1ms

FIBER OPTIC Mode

(glass fibers)

OPPOSED MODE

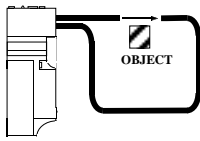

RETRO MODE

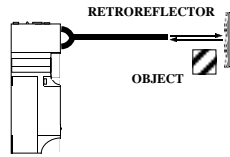

DIFFUSE MODE

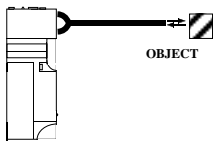

NOTE: if the retroreflective sensing mode is used in conjunction with the HP or 2W program mode, the GAIN control must be reduced from the factory setting in order to avoid optical feedback from the lens assembly.

For information on the complete line of Banner glass fiber optics, see Banner product catalog.

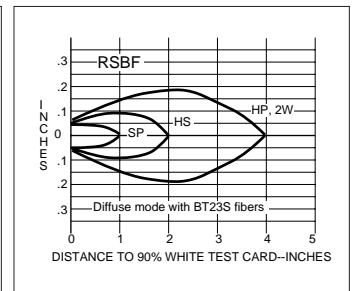
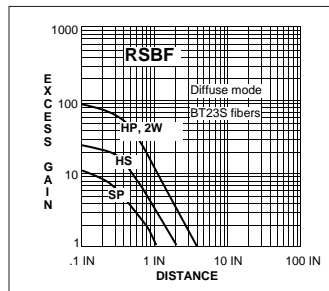
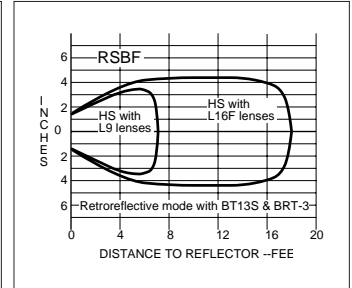
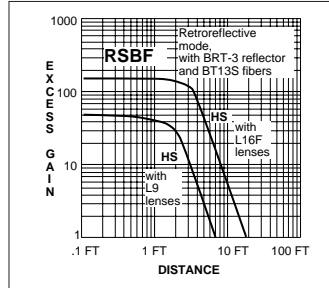
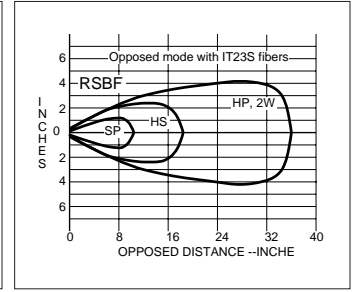
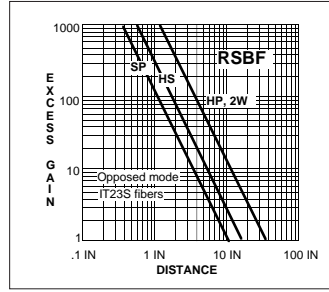

RSBFP

Range: see excess gain curves

Beam: visible red, 650nm.

Response:

HS mode only, 1ms on/off

Repeatability:

HS = 0.3ms

FIBER OPTIC Mode

(plastic fibers)

OPPOSED MODE

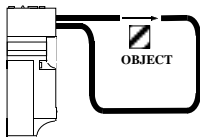

DIFFUSE MODE

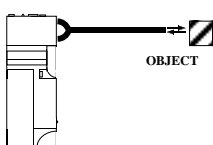

The model RSBFP will function only when programmed for the "HS" response mode.

The model RSBFP will not operate with 2-wire power blocks (models R2PBA and R2PBB).

For information on the complete line of Banner plastic fiber optics, see Banner product catalog.

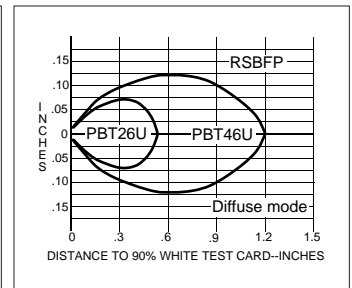
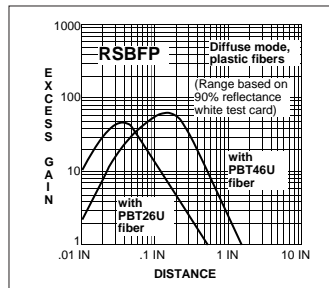
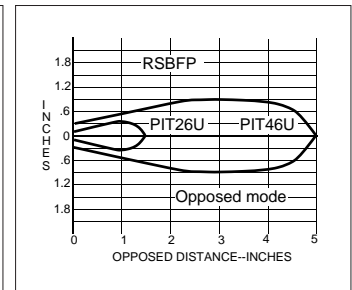
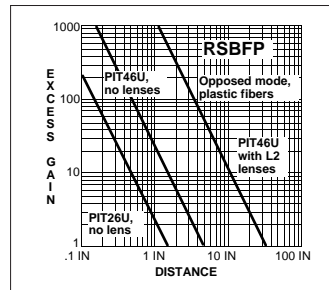

Model RSBFP is a visible-light sensor head designed for use with plastic fiber optics. It is compatible with all standard Banner plastic fiber optic assemblies (see Banner product catalog). In order to function properly, the RSBFP must be programmed for the "HS" response mode. The RSBFP is *not* for use with glass fiber optics (instead use model RSBF or RSBFV).

MAXI-BEAM Sensor Heads

Sensing Mode

Models

Excess Gain

Beam Pattern



RSBFV

Range: see excess gain curves

Beam: visible red, 650nm.

Response:

HS mode only, 1ms on/off

Repeatability:

HS = 0.3ms

The model RSBFV will function only when programmed for the "HS" response mode.

The model RSBFV will not operate with 2-wire power blocks (models R2PBA and R2PBB).

Model RSBFV is a visible-light sensor head designed for use with glass fiber optics. It is compatible with all standard Banner glass fiber optic assemblies (see Banner product catalog). In order to function properly, the RSBFV must be programmed for the "HS" response mode. The RSBFV is *not* for use with plastic fiber optics (instead use RSBFP).

FIBER OPTIC Mode (glass fibers)

OPPOSED MODE

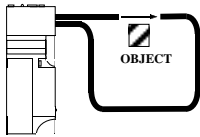

RETRO MODE

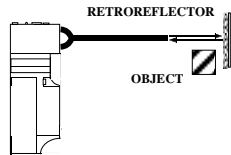

DIFFUSE MODE

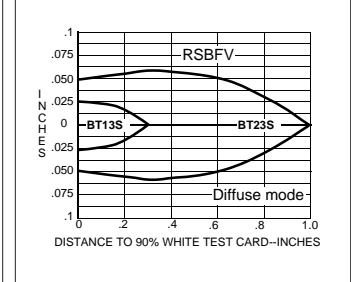
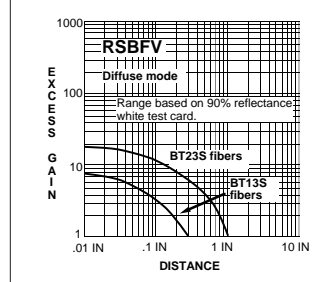
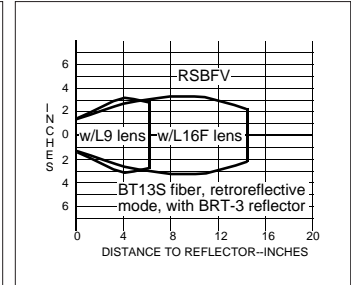
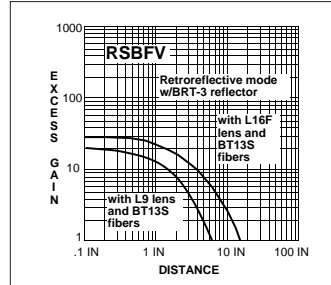
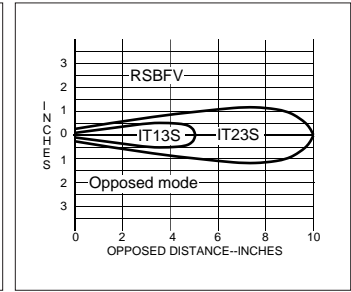
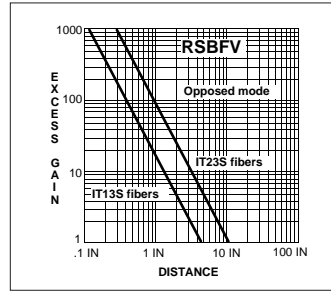
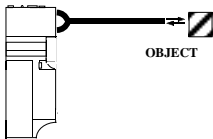

Programming the MAXI-BEAM Sensor Head

MAXI-BEAM sensor heads may be programmed for sensor response time (and range) and for LIGHT/DARK operate. Each sensor head is supplied with a programming ring which attaches below the the sensor head by a system of pegs. There are four programming notches around the perimeter of the ring. To program the sensor head, simply find the notch which will line up with the desired program combination (see diagram, right). NOTE: the programming ring may have to be turned upside-down in order to line up the notch with the program. If LIGHT OPERATE is selected, the MAXI-BEAM output will energize on a dark-to-light transition. If DARK OPERATE is selected, the MAXI BEAM output will energize on a light-to-dark transition. In the illustration, the MAXI-BEAM is set for high speed (HS) operation in the LIGHT OPERATE output state. See the information about each individual sensor head for the response time and range associated with each setting (HP, 2W, HS, SP). NOTE: when programming the RSBE, RSBSE, or RSBFE emitter, select the mode which is programmed for the receiver. EXCEPTION: if the receiver is programmed for the 2-wire (2W) mode, select high power (HP) on the emitter.

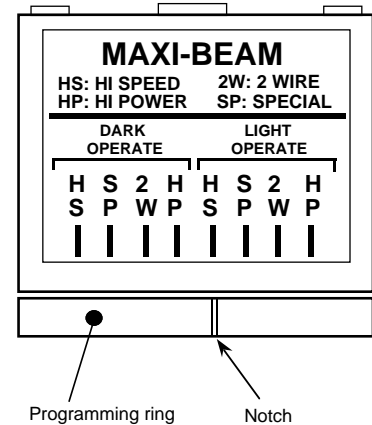

MAXI-BEAM Power Blocks and Wiring Base

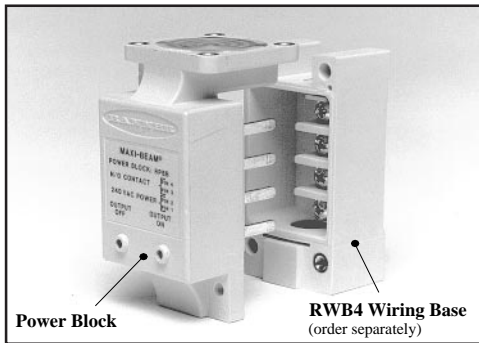

MAXI-BEAM power blocks provide regulated low voltage dc power to the sensor head and logic module (if one is used), and all power blocks (except emitter-only types) contain an output switch for interfacing to loads or to control circuitry.

Power blocks plug into the model **RWB4 wiring base** which has heavy-duty screw terminals that accept up to #12 gauge wire (no lugs are necessary). **The RWB4 wiring base is necessary for all MAXI-BEAM sensor assemblies (except sensors using the RPBTLM power block), and must be purchased separately.**

All power blocks, except the emitter-only types, include status LEDs which continuously indicate the state of the output circuit and input power. MAXI-BEAM power blocks are epoxy-encapsulated and rated for -40 to +70 degrees C (except models RPBR and RPBR2). All MAXI-BEAMs have circuitry to prevent false closure of the output on power-up.

DC Models

Connections

Functional Schematic

RPBT



RPBT-1 (for emitters)

INPUT: 10 to 30V dc, 20mA, exclusive of load current; 10% maximum ripple.

OUTPUT: one open-collector NPN (current sinking) and one open-collector PNP (current sourcing) transistor. 250mA continuous, short-circuit and reverse polarity protected (both outputs).

ON-STATE VOLTAGE DROP:

PNP output: less than 1 volt at 10mA and less than 2 volts at 250mA.

NPN output: less than 200 millivolts at 10mA and less than 1 volt at 250mA.

OFF-STATE LEAKAGE CURRENT: less than 10 microamps.

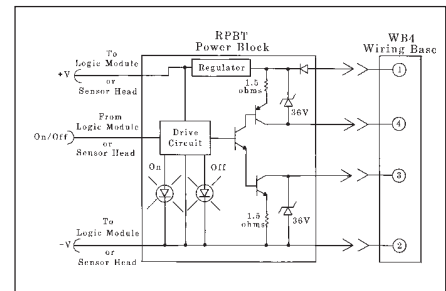
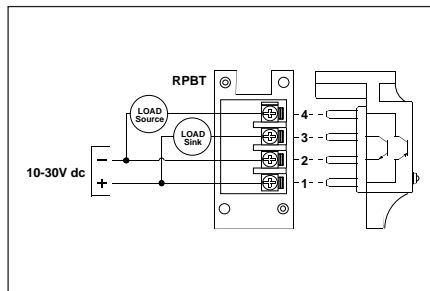

Power block RPBT is the one most often used in low voltage dc applications. There are two solid state output switches (transistors), each rated at 1/4 amp. The NPN output at terminal #3 of the wiring base sinks current to the negative side of the power supply. The PNP output at terminal #4 sources current to the load from the positive side of the power supply. Both outputs may be used simultaneously. Response time of a MAXI-BEAM which uses model RPBT is the response time which is programmed at the sensor head (plus logic delays, if any). Model RPBT-1 is the dc power block to use with model RSBE, RSBER, and RSBEF emitter sensor heads. The RPBT-1 has no switching elements.

Hookup Diagrams for RPBT and RPBT-1 Power Blocks

Hookup to dc Relay or Solenoid (using sinking output)

When using the power block with current sinking (NPN) output, simple loads connect between terminal #3 and the positive supply (terminal #1).

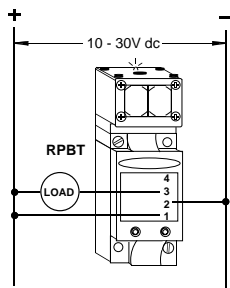

Hookup to dc Relay or Solenoid (using sourcing output)

When using the power block with current sourcing (PNP) output, simple loads connect between terminal #4 and dc common (terminal #2).

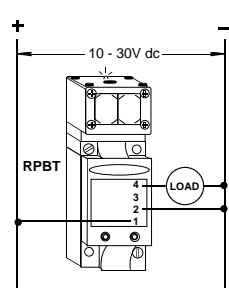

Hookup to Logic Gate (using sinking output)

A logic zero (0 volts dc) is applied to the GATE input when the MAXI-BEAM sinking output is energized. When de-energized, a logic one is applied. The logic supply must be common to the MAXI-BEAM supply negative.

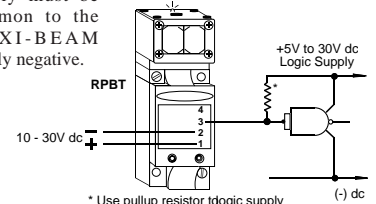

* Use pullup resistor to logic supply

Hookup to a Programmable Controller requiring a current sink

Use MAXI-BEAM NPN output (terminal #3) to interface to PLCs and other logic devices requiring a current sink at the inputs. Connect terminal #3 of the power block to any input of the PLC. Also connect the negative of the MAXI-BEAM power supply (terminal #2) to the negative of the PLC power supply.

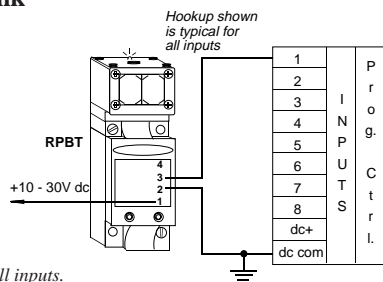

The hookup shown is typical for all inputs.

Hookup to a Programmable Controller requiring a current source

Use MAXI-BEAM PNP output (terminal #4) to interface to PLCs and other logic devices requiring a current source at the inputs. Connect terminal #4 of the power block to any input of the PLC. Connect the negative of the MAXI-BEAM power supply (terminal #2) to the negative of the PLC power supply.

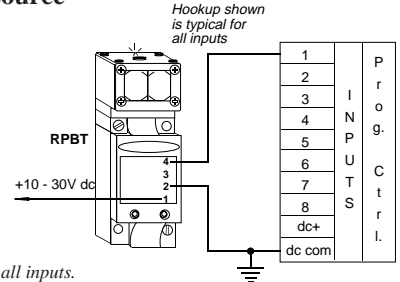

The hookup shown is typical for all inputs.

MAXI-BEAM Power Blocks and Wiring Base

Hookup Diagrams for RPBT and RPBT-1 Power Blocks (continued)

Parallel Hookup of RPBT Power Blocks to a Common Load

Any number of MAXI-BEAMS may be connected in parallel to a load to create "LIGHT-OR" (light operate mode) or "DARK-OR" (dark operate mode) multiple sensor logic. The diagram at the right shows the current sinking outputs of two MAXI-BEAMS connected in parallel to control a load which requires a current sink (power block terminal #3). For loads requiring a current source, connect the wires from the load instead between terminals #4 and #2 (common). NOTE: series connection of dc MAXI-BEAM sensors may be accomplished using power block model RPBR (see below).

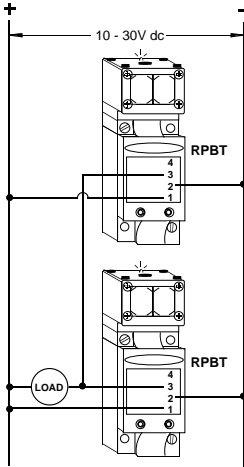

Hookup of a DC Emitter

MAXI-BEAM emitter only sensor heads use dc power block model RPBT-1, which connects directly across the dc supply as shown.

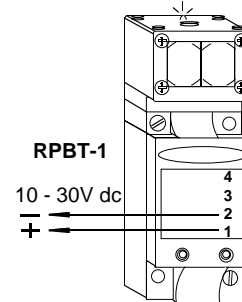

Hookup to MAXI-AMP Logic Module

The current sinking output of MAXI-BEAM power block RPBT may be connected directly to the input of CL Series MAXI-AMP modules. A MAXI-AMP which is powered by ac voltage offers a dc supply with enough capacity to power one MAXI-BEAM sensor, as is shown in this hookup diagram. When an emitter/receiver pair is used, the emitter should be powered from a separate power source (e.g. - use power block RPBA-1, etc.).

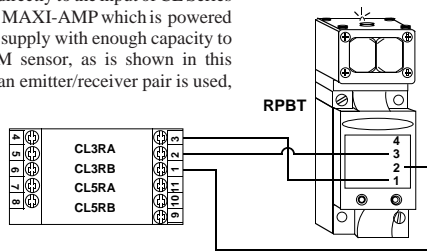

Hookup to MICRO-AMP Logic (MPS-15 Chassis)

The current sinking output of an RPBT power block may be connected directly to the primary input (terminal #7) or the other inputs of MICRO-AMP logic modules. The following logic modules may be used:

- MA4-2 One shot
- MA5 On/off delay
- MA4G 4-input "AND"
- MA4L Latch

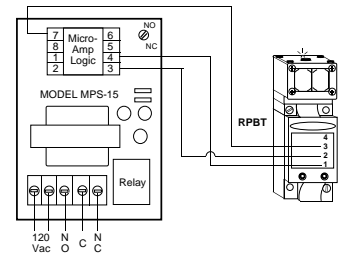

AC/DC Model

Connections

Functional Schematic

RPBR

INPUT: 12 to 30V dc, 40mA, exclusive of load current (at 30V dc); or 12 to 250V ac, 50/60Hz.

OUTPUT: SPST electromechanical relay contact. Contact rating: 250V ac max., 30V dc max., 5 amps max. (resistive load); install MOV across contact if switching inductive load. Contact response: 20ms open and close (NOTE: add to sensor head response). Mechanical life: 10,000,000 operations.

OPERATING TEMPERATURE: -40 to +50 degrees C (-40 to +122 degrees F).

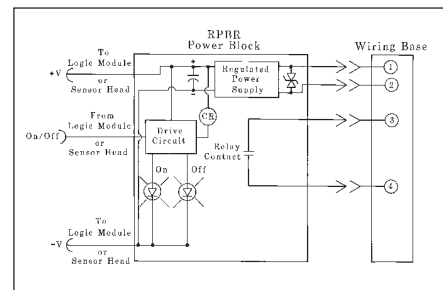
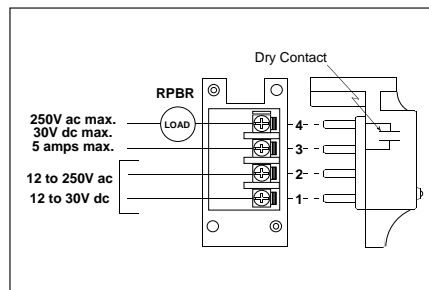

Model RPBR operates the MAXI-BEAM with either ac or dc. It offers an SPST "hard" relay contact between wiring base terminals #3 & #4, which allows the MAXI-BEAM sensor to directly interface with loads which draw high current. It also allows series connection ("AND" logic) with multiple dc sensors.

Application caution: power block models RPBR and RPBR2

Power block modules RPBR and RPBR2 use "partial phase firing" power conversion to enable their wide range of ac input voltage (12 to 250V ac). AC power is applied to the sensor for only a small portion of each ac half-cycle. The current demand during this period may be as high as 1 to 2 amps per sensor.

The collective current demand of several of these sensors on a common ac line is significant. If several sensors are wired *directly to the ac mains*, it is unlikely that any adverse effects will be noticed. On the other hand, problems may be noticed if several sensors are connected to a common circuit that is *isolated from the ac mains* by a transformer. The collective peak current demand may rob other components on the same circuit of enough power to function properly. In the worst case, a transformer with

inadequate reserve current capacity may overheat. Barring a transformer failure, the sensors themselves will operate normally.

As a general rule, if more than three or four MAXI-BEAM sensors using RPBR or RPBR2 power blocks must be connected to the same transformer-isolated ac circuit, consider the substitution of power block model **RPBAR2** (for 105-130V ac) or model **RPBBR2** (for 210-250V ac), which use conventional ac-to-dc power conversion circuitry. These power blocks connect exactly like model RPBR2, but do not exhibit the peak power demand of a phase-fired design. Output relay specifications are identical to model RPBR2. Contact your Banner representative or distributor for pricing and availability.

NOTE: Peak power demand is not an issue when the RPBR or RPBR2 are powered from direct current (12 to 30V dc).

MAXI-BEAM Power Blocks and Wiring Base

AC Models

Connections

Functional Schematic

RPBR2

INPUT: 12 to 160V dc, 40mA, exclusive of load current (at 30V dc); or 12 to 250V ac, 50/60Hz.

OUTPUT: SPDT electromechanical relay contacts. Contact rating: 250V ac max., 30V dc max., 5 amps max. (resistive load); install MOV across contact if switching inductive load. Contact response: 20ms open and close (NOTE: add to sensor head response). Mechanical life: 10,000,000 operations.

OPERATING TEMPERATURE: -40 to +50 degrees C (-40 to +122 degrees F).

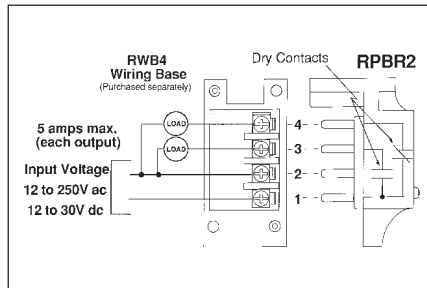

RPBR2 is an SPDT output version of model RPBR, with both contacts common to terminal #1. Terminal #3 is normally open; terminal #4 is normally closed. See application caution, page 9.

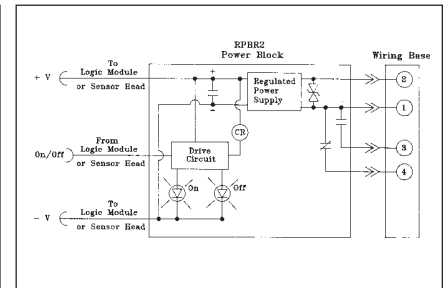

3- and 4-wire operation

RPBA

UL LISTED SP CERTIFIED

INPUT: 105 to 130V ac, 50/60Hz; 2 watts exclusive of load.

RPBB

UL LISTED SP CERTIFIED

INPUT: 210 to 250V ac, 50/60Hz; 2 watts exclusive of load.

OUTPUT: SPST solid-state switch for ac, 3/4 amp maximum (derated to 1/2 amp at 70 degrees C). Maximum inrush 10 amps for one second or 30 amps for one ac cycle (non-repeating). On-state voltage drop of less than 2.5V ac at full load. Off-state leakage current less than 100 microamps.

NOTE: ac loads require up to 8.3 milliseconds to turn OFF in addition to the response time of the sensor head and delay logic (if any).

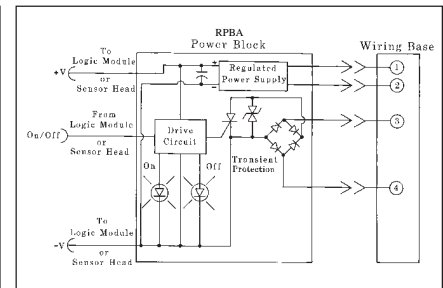
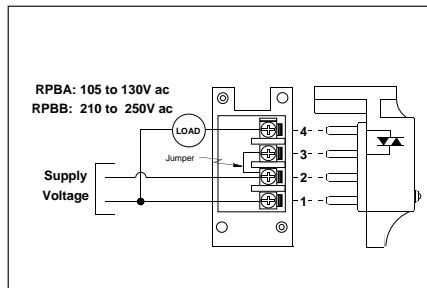

Power block models RPBA and RPBB are the most commonly used for ac MAXI-BEAM operation. As the typical hookup shows, they are intended to switch the same ac voltage as is used to power the MAXI-BEAM. However, both can switch any ac voltage that is lower than the supply voltage, as long as both ac circuits share a common neutral. Observe local codes whenever mixing ac voltages in a common wiring chamber.

These blocks are designed to handle the inrush current of ac inductive loads like motor starters and solenoids. There is no minimum load requirement, and they will interface directly to inputs of all ac programmable logic controllers (PLCs). Special order models **RPBAT** (120V ac) and **RPBBT** (240V ac) are available for interfacing to *dc* loads of up to 100 milliamps.

RPBA-1

UL LISTED SP CERTIFIED

For RSBE, RSBESR, and RSBEF emitters
INPUT: 105 to 130V ac, 50/60Hz; 2 watts.

RPBB-1

UL LISTED SP CERTIFIED

For RSBE, RSBESR, and RSBEF emitters
INPUT: 210 to 250V ac, 50/60Hz; 2 watts.

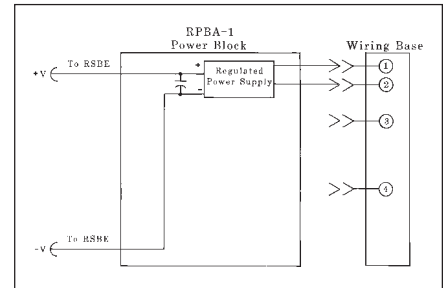
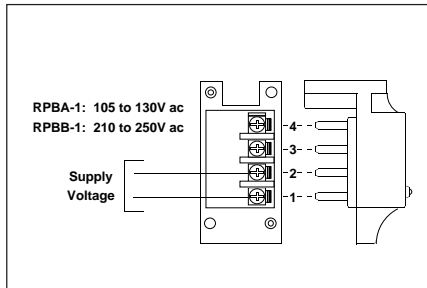

2-wire operation

R2PBA

UL LISTED SP CERTIFIED

INPUT: 105 to 130V ac, 50/60Hz; 2 watts exclusive of load

R2PBB

UL LISTED SP CERTIFIED

INPUT: 210 to 250V ac, 50/60Hz; 2 watts exclusive of load.

OUTPUT: SPST solid-state switch for ac, 3/4 amp maximum (derated to 1/2 amp at 70 degrees C). Maximum inrush 10 amps for one second (non-repeating).

On-state voltage drop: 5.2V rms at a 1/2 amp load; 14V rms at a load of 10 milliamps.

Off-state leakage current less than 1.7 milliamp (resistive or inductive load).

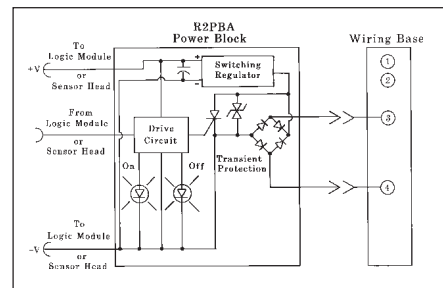
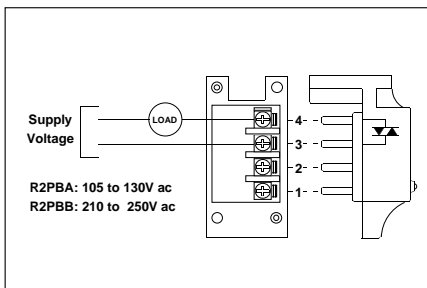

Power block models R2PBA and R2PBB both offer the simplicity of wiring which is associated with 2-wire sensor design. They wire directly in series with an ac load, exactly like a limit switch. Use of a 2-wire power block requires programming of the sensor head to the "2W" (2-wire) operating mode. As a result, MAXI-BEAM sensing response time is fixed at 10 milliseconds for 2-wire operation. There are some hookup considerations which are unique to 2-wire interfaces. See hookup information on page 12 for details.

MAXI-BEAM Power Blocks and Wiring Base

Hookup Diagrams for RPBA, RPBA-1, RPBB, & RPBB-1 Power Blocks

Hookup to a Simple Load

AC voltage is connected to terminals #1 and #2 to provide power to the MAXI-BEAM. The solid-state output switch behaves as if there were a contact between terminals #3 and #4. L1 is most conveniently applied to terminal #3 by jumpering terminals #1 and #3 inside the wiring base. Alternatively, the load could be installed between terminal #3 and L1, with L2 connected to terminal #4 by jumpering from #2 to #4.

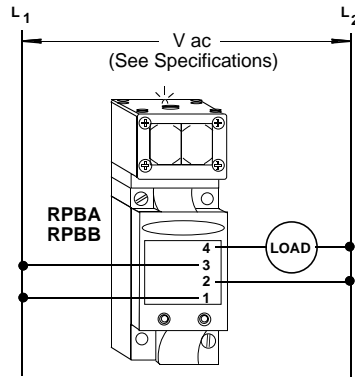

CAUTION: the output switch will be destroyed if the load is shorted.

Hookup of an ac Emitter

MAXI-BEAM emitter-only sensor heads use ac power block model RPBA-1 (120V ac) or RPBB-1 (220/240V ac) which connect directly across the line, as shown.

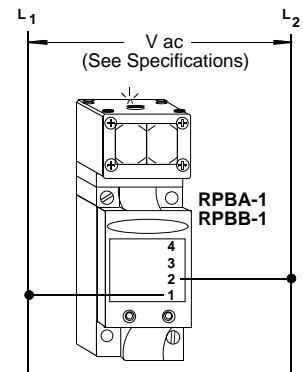

Hookup in Parallel or Series with Contacts or Switches

Any number of "hard" contacts may be wired in series or in parallel to MAXI-BEAMs which use power block model RPBA or RPBB.

This circuit illustrates a start-stop function in which CR can be energized only when the MAXI-BEAM output is energized. Once energized, CR is latched ON by its normally open contact. CR is reset by depressing the STOP switch.

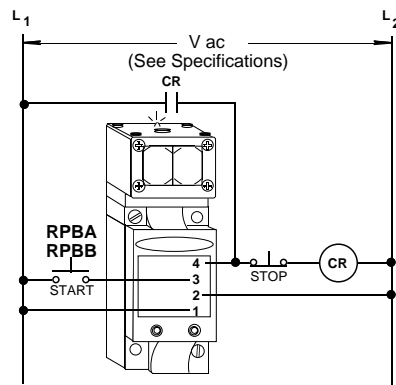

Hookup to Programmable Logic Controller (PLC)

Interfacing to a PLC I/O is direct with MAXI-BEAMs which use RPBA or RPBB. The off-state leakage current is only 100 microamps (0.1 milliamp) maximum.

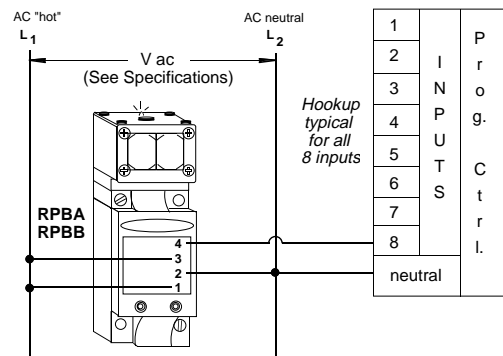

Hookup in Series with other MAXI-BEAMs

MAXI-BEAMs which use RPBA or RPBB power blocks may be wired in series for the "AND" logic function. The total voltage drop across the series will be the sum of the individual voltage drops across each power block (approximately 3 volts per block). With most loads, 10 or more sensors may be wired together in series.

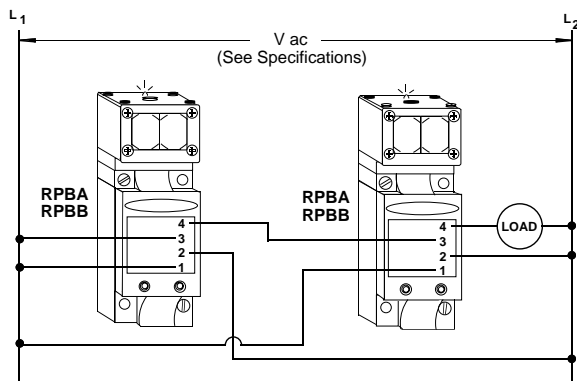

Hookup in Parallel with other MAXI-BEAMs

Any number of MAXI-BEAMs using RPBA or RPBB power blocks may be wired together in parallel to a load. Parallel sensor connection is usually used to yield "OR" logic (i.e.-if an event occurs at any sensor, the load is energized).

The total off-state leakage current through the load is the sum of the leakage currents of the individual power blocks. However, the maximum leakage current of MAXI-BEAM RPBA or RPBB power blocks is only 100 microamps. As a result, the installation of an artificial load resistor in parallel with the load is necessary only for very large numbers of sensors wired in parallel to a light (i.e.-high impedance) load.

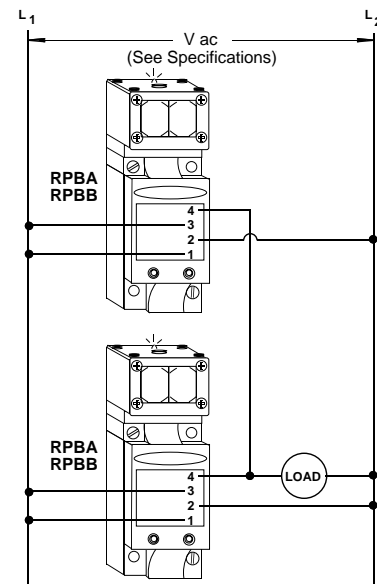

MAXI-BEAM Power Blocks and Wiring Base

Hookup Diagrams for R2PBA and R2PBB Power Blocks

Basic 2-wire Hookup

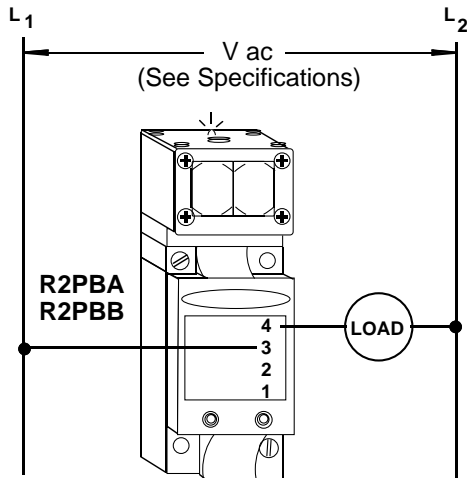

MAXI-BEAM sensors using power block R2PBA or R2PBB wire in series with an appropriate load. This combination, in turn, wires directly across the ac line. A 2-wire sensor may be connected exactly like a mechanical limit switch.

The MAXI-BEAM remains powered when the load is OFF by a residual current which flows through the load. This off-state leakage current is always less than 1.7 milliamps. The effect of this leakage current depends upon the characteristics of the load. The voltage which appears across the load in the OFF state is equal to the leakage current of the sensor multiplied by the resistance of the load:

$$V(\text{off}) = 1.7\text{mA} \times R(\text{load}).$$

If this resultant OFF state voltage is less than the guaranteed turn-off voltage of the load, then the interface is direct. If the OFF state voltage causes the load to stay ON, then an artificial load resistor must be connected in parallel with the load to lower its effective resistance. Most loads, including most programmable logic controller (PLC) inputs, will interface to 2-wire sensors with 1.7mA leakage current, without the need for an artificial load resistor.

There is no polarity requirement. Either wire may be connected to terminal #3, and the other to terminal #4.

CAUTION: all components of a MAXI-BEAM 2-wire sensor assembly will be destroyed if the load becomes a short circuit.

2-wire MAXI-BEAMs in Parallel

Multiple 2-wire MAXI-BEAMs may be wired together in parallel to a load for "OR" or "NAND" logic functions. When sensors are wired in parallel, the off-state leakage current through the load is equal to the sum of the leakage currents of the individual sensors. Consequently, loads with high resistance like small relays and electronic circuits may require artificial load resistors.

MAXI-BEAM sensors have a 100 millisecond power-up delay for protection against false outputs. When 2-wire MAXI-BEAMs are wired together in parallel, any power block which has an energized output will rob all other 2-wire power blocks of the voltage needed to operate the sensor. When the energized output drops, there will be a 0.1 second delay before any other MAXI-BEAM can energize. As a result, the load may momentarily drop out.

2-wire MAXI-BEAM sensors cannot wire in series with other 2-wire sensors. If series connection of 2-wire AC sensors is required, consider models within the VALU-BEAM or MINI-BEAM sensor families. 4-wire ac power blocks can wire in series (see RPBA, RPBB).

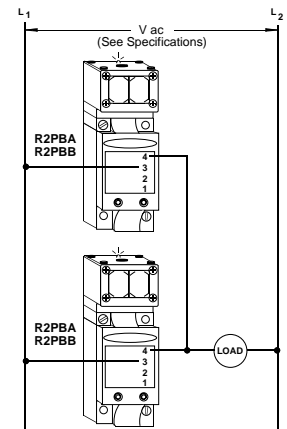

2-wire MAXI-BEAMs with Parallel Contacts

2-wire MAXI-BEAM sensors may be wired in parallel with mechanical switch or relay contacts. The load will energize when either a contact closes or the sensor output is energized. When a contact is closed, it shunts the operating current away from the MAXI-BEAM. As a result, when all of the contacts open, the MAXI-BEAMs 0.1 second power-up delay may cause a momentary drop-out of the load.

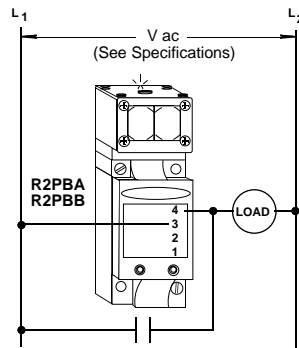

2-wire MAXI-BEAMs with Series Contacts

When 2-wire MAXI-BEAM sensors are connected in series with mechanical switch or relay contacts, the sensor will receive power to operate only when all of the contacts are closed. The false-pulse protection circuit of the MAXI-BEAM will cause a 0.1 second delay between the time that the last contact closes and the time that the load can energize.

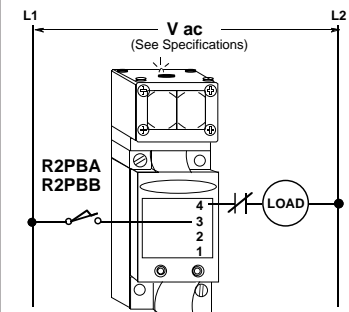

Hookup of 2-wire MAXI-BEAMs to a Programmable Logic Controller (PLC)

MAXI-BEAM 2-wire sensors operate with low (1.7mA) off-state leakage current. As a result, they will interface directly to most PLCs without the need for an artificial load resistor. If the off-state voltage (1.7mA x input resistance of PLC) is higher than the PLC sensing threshold, install a 10KΩ to 15KΩ, 5 watt resistor for each 2-wire sensor. The resistor connects between the input terminal and ac neutral.

If you have a question on hookup to a specific brand of PLC, contact the Banner Applications Department during normal business hours.

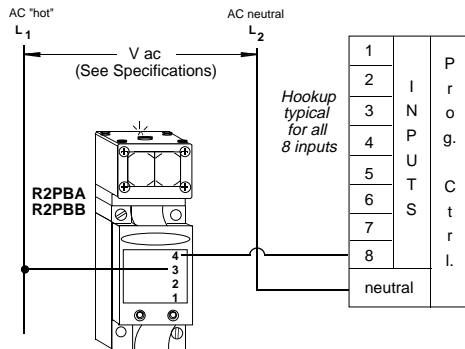

Photoelectric Latch with Manual Reset

ICR relay will latch ON whenever the 2-wire MAXI-BEAM output is energized. ICR is reset when the normally-closed pushbutton switch is pressed.

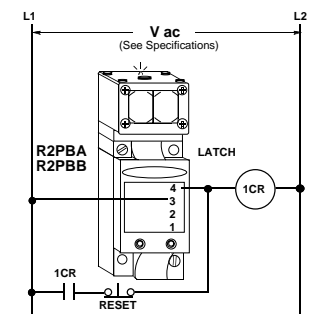

MAXI-BEAM Power Blocks

Model RPBTLM Low Profile DC Power Block

Model **RPBTLM** is a miniature dc power block for MAXI-BEAM sensors. It may be used with *any* of the MAXI-BEAM sensor head models. The RPBTLM is supplied with stainless steel hardware used for assembly of the MAXI-BEAM components. Components simply bolt together, with no interwiring necessary. The screws supplied are extra-long, and serve as a means to mount the complete MAXI-BEAM sensor assembly to an object or surface.

The RPBTLM may be attached to its sensor head at any of four 90-degree increments to allow the best cable exit direction (front, rear, or either side). A logic module may be added and can be independently rotated (in the same manner) for easiest access to the timing adjustments.

Outputs are in the bi-polar configuration: one current-sinking (NPN) *plus* one current-sourcing (PNP). This design permits direct interfacing of the MAXI-BEAM sensor to almost any type of dc logic input. Each output is rated for 150 mA. Either output may be used alone, or both may be used simultaneously. The outputs may be configured for either normally open or normally closed operation via the sensor head (or logic module) programming ring. The RPBTLM includes an LED indicator to show the output status.

The RPBTLM is completely solid-state and epoxy-encapsulated. It is gasketed to other MAXI-BEAM components by a quad-ring seal. See pages 3,7, and 14-15 for information on the assembly and programming of MAXI-BEAM sensors.



RPBTLM Dimensions

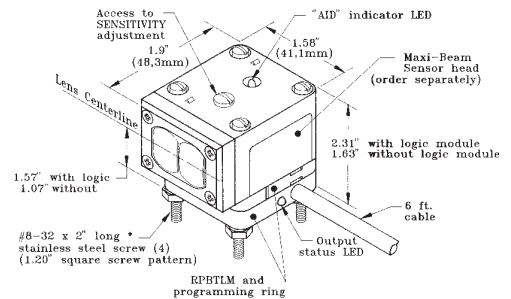

Hookup Diagram

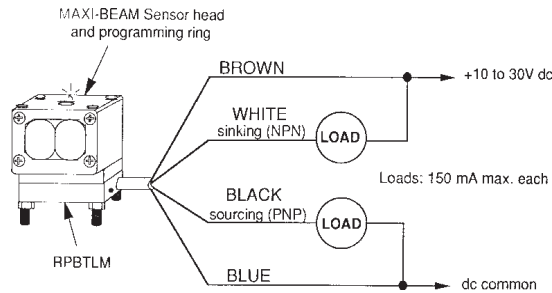

Specifications

INPUT: 10 to 30V dc, 10% maximum ripple.

OUTPUT CONFIGURATION: bi-polar. One current sinking (NPN) and one current sourcing (PNP) open-collector transistor switch.

OUTPUT RATING: 150mA maximum each output at 25°C (derated to 100mA at 70°C). Derate 1mA per °C.

OUTPUT PROTECTION: protected against false pulse on power-up, inductive load transients, power supply polarity reversal, and continuous overload or short-circuit of outputs.

Functional Schematic

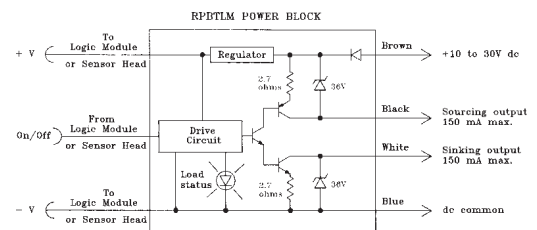

ON-STATE VOLTAGE DROP:

NPN output less than 200 millivolts at 10mA and less than one volt at 150mA. PNP output less than 1 volt at 10mA and less than 2 volts at 150mA.

OFF-STATE LEAKAGE CURRENT:

less than 1 microamp.

Model RPBU Power Block: universal power input and output

INPUT: 12-250V ac (50/60Hz) or 12-30V dc, 40mA exclusive of load at 30V dc. **OUTPUT:** Optically-isolated SPST solid-state relay; 240V ac or dc max., 100mA max. *On-state voltage drop* is 2 volts max. at 100mA (full rated load). DC hookup is without regard to polarity.

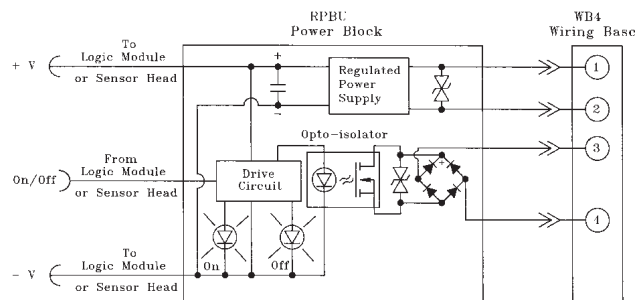
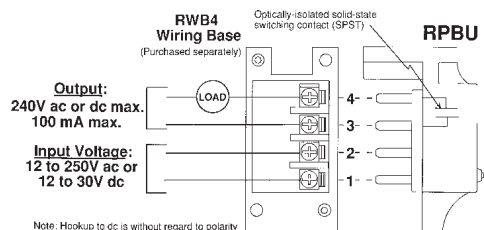

MAXI-BEAM Logic Modules



MAXI-BEAM sensors offer built-in timing logic with the addition of a logic module. There are two logic modules available. Model RLM5 is programmable for ON-DELAY, OFF-DELAY, and ON/OFF DELAY timing logic. Model RLM8 offers both ONE-SHOT and DELAYED ONE-SHOT functions. A programming ring is supplied with each logic module. Programming of the logic function, timing range, and output state is similar to sensor head programming.

Both logic modules feature 15-turn, clutched potentiometers for accurate timing adjustments. Once programmed, the logic module may be rotated in 90-degree increments to position the timing adjustments for easiest access. Logic modules are housed in the same tough molded VALOX® which is used for the other MAXI-BEAM components. The logic module and its programming ring simply slip between the MAXI-BEAM sensor head and power block (see photograph, page 3). The assembly is bolted together with no interwiring necessary. The component interfaces are quad-ring sealed.

MAXI-BEAM Logic Module Specifications

SUPPLY VOLTAGE: input power is supplied by the power block (see pages 8-13).

RESPONSE TIME:

RLM5: add sensor response delay of approximately 2% of maximum OFF-DELAY time.

RLM8: no added response time for ONE-SHOT mode.

TIMING ADJUSTMENTS: two 15-turn clutched potentiometers with brass element, accessible from outside of logic module, under o-ring gasketed cover screws.

TIMING REPEATABILITY: plus or minus 2% of the maximum time of the selected range, assuming conditions of constant operating temperature and power supply voltage.

TIMING RANGE: 15 second ranges: 0.5 to 15 seconds; 1 second ranges: 0.1 to 1 second; 0.1 second ranges: 0.01 to 0.1 second.

CONSTRUCTION: reinforced molded VALOX® housing, quad-ring gasketed. Electronics fully epoxy encapsulated. NEMA 1,3,4,12, 13.

OPERATING TEMPERATURE: -40 to +70 degrees C (-40 to +158 degrees F).

Model and Logic Functions

Programming

RLM5

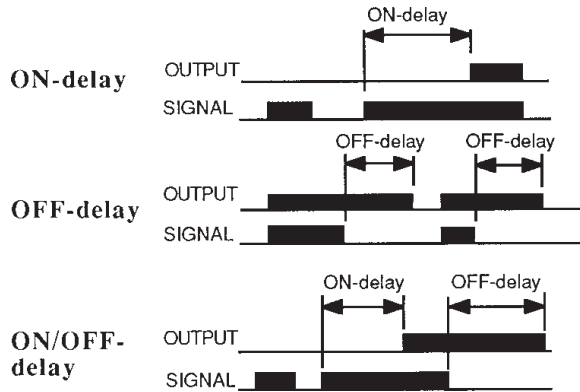

PROGRAM CHOICES:

- 1) Timing Logic Function:
 - a) ON-delay b) OFF-delay c) ON/OFF-delay
- 2) Timing Adjustment Range (see options below)
- 3) Output State:
 - a) normally open b) normally closed

TO PROGRAM LOGIC MODULE:

- 1) Find the programming notch which lines up with the program choice. NOTE: the programming ring may have to be turned upside-down in order to find a notch that lines up with the desired program.
- 2) Press the programming ring and logic module together. They will be held together temporarily by their interlocking pegs.
- 3) Orient the logic module for easiest access to the timing adjustments, and assemble between the programming ring of the sensor head and the power block (see exploded view on page 3). Bolt all parts together with the long bolts that are supplied with the logic module.
- 4) Apply power to the MAXI-BEAM and adjust timing, using a small flat-blade screwdriver. Timing potentiometers are located behind the nylon o-ring gasketed cover screws.

Program Definition

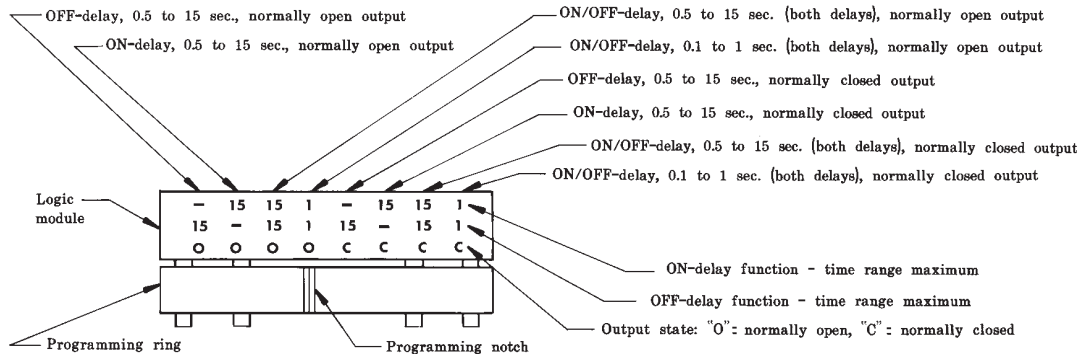

MAXI-BEAM Logic Modules

Model and Logic Functions

Programming

RLM8

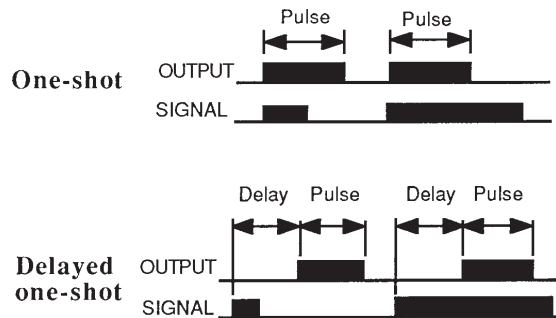

PROGRAM CHOICES:

- 1) Timing Logic Function:
 - a) ONE-SHOT
 - b) Delayed ONE-SHOT
- 2) Timing Adjustment Range (see options below)
- 3) Output State:
 - a) normally open
 - b) normally closed

TO PROGRAM LOGIC MODULE:

- 1) Find the programming notch which lines up with the program choice. NOTE: the programming ring may have to be turned upside-down in order to find a notch that lines up with the desired program.
- 2) Press the programming ring and logic module together. They will be held together temporarily by their interlocking pegs.
- 3) Orient the logic module for easiest access to the timing adjustments, and assemble between the programming ring of the sensor head and the power block (see exploded view on page 3). Bolt all parts together with the long bolts that are supplied with the logic module.
- 4) Apply power to the MAXI-BEAM and adjust timing, using a small flat-blade screwdriver. Timing potentiometers are located behind the nylon o-ring gas-ketted cover screws.

Program Definition

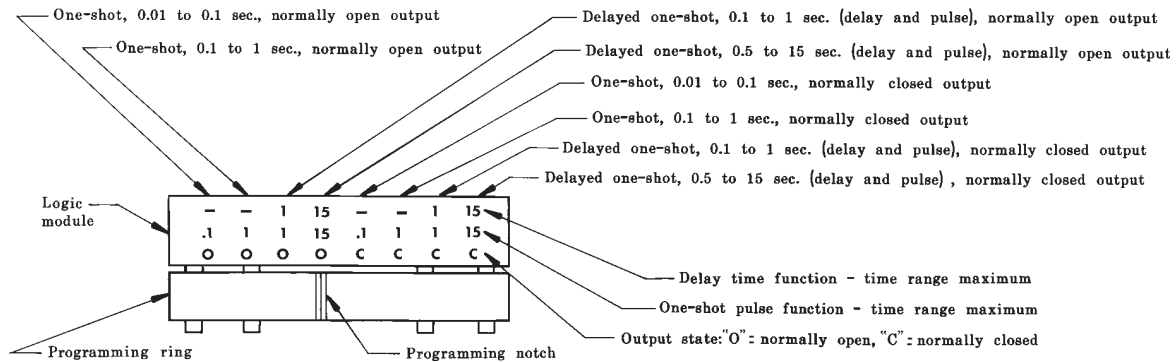

MAXI-BEAM Accessories

Replacement Upper Covers (Lens Assemblies)

An upper cover consists of the optical element for the MAXI-BEAM sensor head. An upper cover may be used as a replacement part or for modifying the optical response of a sensor. Upper cover assemblies include lens, replacement bezel, o-ring, and stainless steel screws.



Replacement Lenses

Sensor Head	Upper Cover
RSBE	RUC-L
RSBR	RUC-L
RSBLV	RUC-L
RSBLVAG	RUC-AG
RSBD	RUC-L
RSBDSR, ESR, & RSR	RUC-D
RSBC, CV	RUC-C
RSBF, FV	RUC-F
RSBFP	RUC-FP

Lens Interchangeability

CONVERSION FROM - TO	USE UPPER COVER	CONVERSION FROM - TO	USE UPPER COVER
RSBLV to RSBLVAG ...	RUC-AG	RSBLVAG to RSBLV ...	RUC-L
RSBLV to RSBCV	RUC-C	RSBCV to RSBLV	RUC-L
RSBD to RSBDSR	RUC-D	RSBDSR to RSBD	RUC-L
RSBD to RSBF	RUC-F	RSBF to RSBDSR	RUC-D
RSBDSR to RSBF	RUC-F		

MAXI-BEAM Accessories

Mounting Brackets

Model **SMB700** (right) is a general-purpose two-axis mounting bracket that is supplied with a cable gland assembly which is used to attach the MAXI-BEAM wiring base to the bracket. The gland assembly is threaded through the bracket and into the conduit entrance at the base of the scanner block. A large lockwasher is supplied to hold the scanner block firmly in place. The bracket is 11-gauge zinc plated steel.

Model **SMB700SS** is an 11-gauge stainless steel version of the SMB700. It is sold alone, without the cable gland assembly and lockwasher.

Model **SMB700F** (photo, below) is a flat, single-axis version of the SMB-700. It is sold without hardware.



Model **SMBLS** (not shown) is a two-part bracket assembly which allows adjustment in three directions. It consists of two 11-gauge zinc plated steel right-angle brackets which fasten together so that they rotate relative to each other. The MAXI-BEAM wiring base attaches to the upper bracket and slots are provided for vertical adjustment. The bottom bracket is a modified version of the SMB700. Assembly hardware and a cable gland are included.

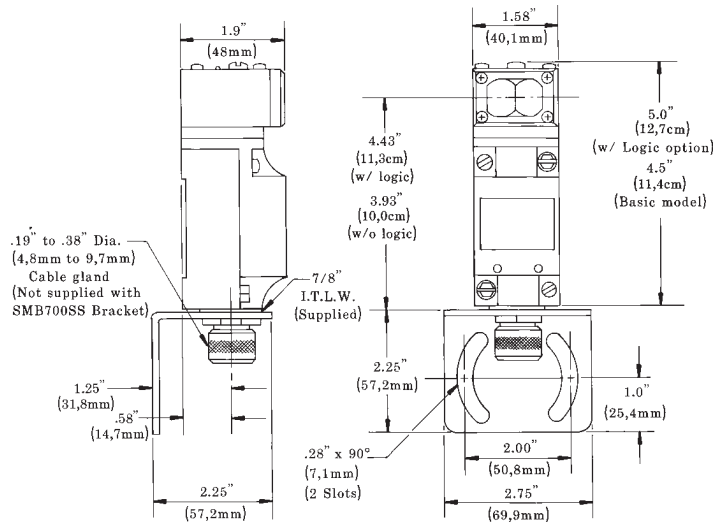

HF1-2NPS

This is a black nylon cable gland assembly for use with the **MAXI-BEAM** and other sensors having a 1/2-NPS conduit entrance. The flexible extension keeps the sensor cable from bending too sharply, and minimizes cable fatigue due to repeated flexing.

The HF1-2NPS includes a neoprene gland that accommodates cables with diameters from .20 to .35 inch for a liquid-tight seal.

This flexible gland assembly is resistant to gasoline, alcohol, oil, grease, solvents, and weak acids. It has a working temperature range of -30° to +100°C (-22 to +212°F). It is UL recognized and CSA certified.

The HF1-2NPS is sold in packages of 10 pieces.



SMB700M



Heavy-duty 1/4-inch (6mm) zinc plated steel bracket that allows the MAXI-BEAM to retrofit to installations of MICRO-SWITCH models MLS8 or MLS9 sensors. Includes cable gland and lockwasher.

SMB700P



Heavy duty 1/4-inch (6mm) zinc plated steel bracket that allows the MAXI-BEAM to retrofit to installations of PHOTOSWITCH series 42RLU and 42RPL sensors. Includes cable gland and lockwasher.

RF1-2NPS



Cable gland assembly for MAXI-BEAMs. Includes cord grips for .1 to .4 inch diameter cable. Bracket lockwasher is also included.

MBC-4

MBCC-412



MBC-4 is a 4-pin male industrial-duty connector that threads into the base of all MAXI-BEAMs. **MBCC-412** is a 12-foot long (3.6m) "SJT" type cable. It is interchangeable with standard industry types of several different manufacturers.