

LED Retrofit Collection  
RL and RA Series

**HALO**



**EATON**

*Powering Business Worldwide*

# RL4 Series



- Up to 700 lumens (lumens per selected CCT and CRI)
- Use to replace 60W PAR16, 50W PAR20 or 40W R20 lamp
- 2700K, 3000K, 3500K, 4000K, 5000K Correlated Color Temperature (CCT)
- 90 CRI
- 8W - 8.3W (Per CRI and CCT), 120V
- Halo matte white finish
- Push-N-Twist universal installation clips pre-installed
- Compatible with most 4" recessed housings
- Dimmable to 5% with select dimmers
- Damp and wet location listed (shower rated)
- Rated for IC, ICAT and may be used in Non-IC housings
- AIR-TITE™ certified per ASTM-E283
- Diffusing, regressed lens
- Five-year limited warranty

## RL4 Designer Trims (Order Separately)



**RL4TRMWHB**  
White (Paintable)

**RL4TRMWH**  
White (Paintable)

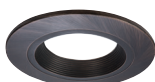

**RL4TRMTBZB**  
Tuscan Bronze

**RL4TRMTBZ**  
Tuscan Bronze

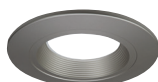

**RL4TRMSNB**  
Satin Nickel

**RL4TRMSN**  
Satin Nickel

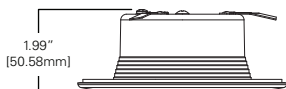

5.12"  
[130.13mm]

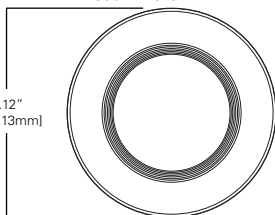

**OVER \$500<sup>A</sup> SAVINGS**

<sup>A</sup> Savings are over the life of the Halo RL4 luminaire.

Energy savings: \$383

Replacement lamp savings: \$166

Savings based on \$0.155 per kilowatt hour, average six hours use per day, 50,000 hours of lamp usage, and 60W PAR16 Halogen lamp lumen equivalent.

# 4" LED Retrofit Downlight

**Push-N-Twist**  
Universal Installation Clip



## Ordering Information

Sample Number: **RL460WH930PK**  
Order Halo housing separately.

### RL4 Models – 4" LED Retrofit Baffle - Trim

#### 90 CRI

- RL460WH927PK**= 90 CRI, 2700K
- RL460WH930PK**= 90 CRI, 3000K
- RL460WH935PK**= 90 CRI, 3500K
- RL460WH940PK**= 90 CRI, 4000K
- RL460WH950PK**= 90 CRI, 5000K

### LED Housings (Order Separately)

See Housing Compatibility, Page 12

### Accessories (Order Separately)

- RL4TRMSNB**=Satin Nickel Trim Ring
- RL4TRMTBZB**=Tuscan Bronze Trim Ring
- RL4TRMWHB**=White Paintable Trim Ring
- HE26LED**=Replacement screw base adapter (one included with unit)



**HE26LED**  
Edison Base Adapter  
for retrofit (included)

RL4 Energy Data	90 CRI
<b>Max. Lumens (5000K)</b>	600
<b>Input Voltage</b>	120V
<b>Input Frequency</b>	50/60 Hz
<b>Input Power</b>	8.0W - 8.3W (per CRI and CCT)
<b>Input Current</b>	0.075A - 0.0875A (Per input power)
<b>Power Factor</b>	>0.90
<b>THD</b>	<20%
<b>EMI/RFI</b>	FCC Title 47 CFR, Part 15, Class B (Consumer)
<b>Sound Rating</b>	Class A
<b>Minimum Starting Temp</b>	-30°C (-22°F)



Refer to ENERGY STAR® Certified Products List.

Can be used to comply with California Title 24 High Efficacy requirements.  
Certified to California Title 20 Appliance Efficiency Database.

# RL56 Series



- 600 Series: up to 671 lumens<sup>1</sup>  
900 Series: up to 1100 lumens<sup>1</sup>  
1200 Series: up to 1330 lumens<sup>1</sup>
- 600 Series: use to replace 65W BR30 or 50W PAR30 lamp  
900 Series: use to replace 75W PAR30 lamp  
1200 Series: use to replace 90W BR40 lamp
- 2700K, 3000K, 3500K, 4000K, 5000K CCT<sup>2</sup>
- 90 CRI
- 600 Series: 7.2W - 9.6W (per CRI and CCT), 120V  
900 Series: 13.5W, 120V  
1200 Series: 17.3W - 18.0W (per CRI and CCT), 120V
- Halo matte white finish
- Torsion springs pre-installed
- Optional Push-N-Twist universal installation two piece clips
- Compatible with most 5" and 6" standard and shallow recessed housings
- Dimmable to 5% with select dimmers
- Damp and wet location listed (shower rated)
- Rated for IC, ICAT and may be used in Non-IC housings
- AIR-TITE™ certified per ASTM-E283
- Diffusing, regressed lens
- Five-year limited warranty

1. Lumens per selected CCT and CRI  
2. CCT - Correlated Color Temperature

## RL56 Designer Trims (Order Separately)

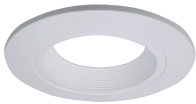

**RL56TRMWHB**  
White (Paintable)

**RL56TRMWH**  
White (Paintable)

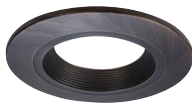

**RL56TRMTBZB**  
Tuscan Bronze

**RL56TRMTBZ**  
Tuscan Bronze

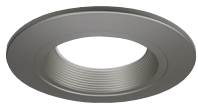

**RL56TRMSNB**  
Satin Nickel

**RL56TRMSN**  
Satin Nickel



<sup>A</sup> Savings are over the life of the Halo RL56 luminaire.  
Energy savings: \$430  
Replacement lamp savings: \$100  
Savings based on \$0.155 per kilowatt hour, average six hours use per day, 50,000 hours of lamp usage, and 65W BR30 Halogen lamp lumen equivalent.

**Torsion Springs**



Example:  
RL56-600 Series



**5 Inch housing position**



**6 Inch housing position**

**Push-N-Twist**  
Universal Installation Clip



Example:  
RL56-600 Series



To use the Push-N-Twist clips, the torsion springs must be removed. Do not remove the main bracket.

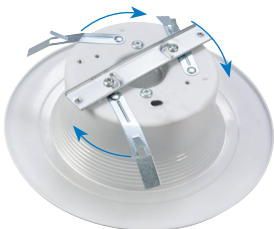

Once the torsion springs are removed, rotate the clips into position and install into the housing.

# RL56 Series

## Ordering Information

Sample Number: **RL560WH6927**

Order Halo housing separately.

### RL56 600 Series – 5"/6" LED Retrofit Baffle - Trim

#### 90 CRI

**RL560WH6927**= 90 CRI, 2700K

**RL560WH6930**= 90 CRI, 3000K

**RL560WH6935**= 90 CRI, 3500K

**RL560WH6940**= 90 CRI, 4000K

**RL560WH6950**= 90 CRI, 5000K

### RL56 900 Series – 5"/6" LED Retrofit Baffle - Trim

#### 90 CRI

**RL560WH9927**= 90 CRI, 2700K

**RL560WH9930**= 90 CRI, 3000K

**RL560WH9935**= 90 CRI, 3500K

**RL560WH9940**= 90 CRI, 4000K

**RL560WH9950**= 90 CRI, 5000K

### RL56 1200 Series – 5"/6" LED Retrofit Baffle - Trim

#### 90 CRI

**RL560WH12927**= 90 CRI, 2700K

**RL560WH12930**= 90 CRI, 3000K

**RL560WH12935**= 90 CRI, 3500K

**RL560WH12940**= 90 CRI, 4000K

**RL560WH12950**= 90 CRI, 5000K

## LED Housings (Order Separately)

See Housing Compatibility, Page 13

## Accessories (Order Separately)

**RL56TRMSNB**=Satin Nickel Trim Ring

**RL56TRMTBZB**=Tuscan Bronze Trim Ring

**RL56TRMWHB**=White Paintable Trim Ring

**OT400P**=Oversize Flat White Metal Trim Ring, 6" I.D. x 9-1/4" O.D. (Ring slips behind RL56 ring in stepped configuration.)

**OT403P**=Oversize White Plastic Trim Ring, 6" I.D. x 8" O.D. (Ring slips behind RL56 ring in stepped configuration.)

**TRM690WH**=Oversize Matte White Metal Trim Ring. Designed for RL56 ring to inset into oversize ring for an even (non-stepped) trim surface.

**HE26LED**=Replacement screw base adapter (one included with unit)



Refer to ENERGY STAR® Certified Products List.

Can be used to comply with California Title 24 High Efficacy requirements.  
Certified to California Title 20 Appliance Efficiency Database.

# 5" / 6" LED Retrofit Downlight 600, 900, 1200 Series

RL56 Energy Data	600 Series	900 Series
	90 CRI	90 CRI
Max. Lumens (4000K)	653	950
Input Voltage	120V	120V
Input Frequency	50/60 Hz	50/60 Hz
Input Power	7.2W - 9.6W (Per CRI and CCT)	13.5W
Input Current	0.15 A	0.15 A
Power Factor	>0.90	>0.90
THD	<20%	<20%
EMI/RFI	FCC Title 47 CFR, Part 15, Class B (Consumer)	FCC Title 47 CFR, Part 15, Class B (Consumer)
Sound Rating	Class A	Class A
Minimum Starting Temp	-30°C (-22°F)	-30°C (-22°F)

RL56 Energy Data	1200 Series
	90 CRI
Max. Lumens (5000K)	1330
Input Voltage	120V
Input Frequency	50/60 Hz
Input Power	17.3W - 18.0W (Per CRI and CCT)
Input Current	0.15 A
Power Factor	>0.90
THD	<20%
EMI/RFI	FCC Title 47 CFR, Part 15, Class B (Consumer)
Sound Rating	Class A
Minimum Starting Temp	-30°C (-22°F)

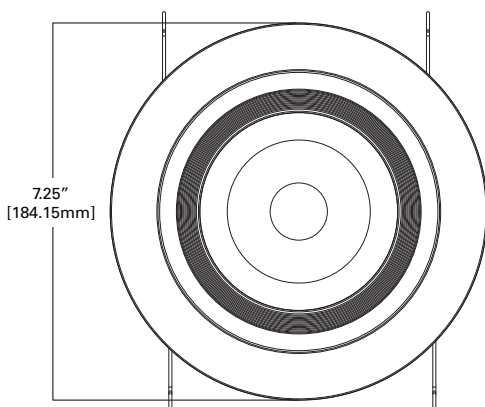
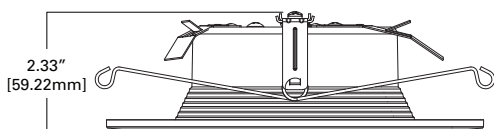

# RA4 Series

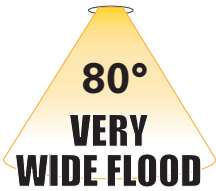

- Adjustable Gimbal for accent, task, grazing and downlighting
  - 35° Tilt, up to 360° rotation
- Beam distribution options
  - NFL - Narrow Flood (25°)
  - VWFL - Very Wide Flood (80°)
- Up to 640 lumens (lumens per selected CCT and CRI)
- Use to replace 40W R40 lamp (VWFL), or 60W PAR16 (NFL), or 50W PAR20 lamp (NFL)
- 2700K, 3000K Correlated Color Temperature (CCT)
- 90 CRI
- 10.0W, 120V
- Halo matte white finish
- Compatible with most 4" recessed housings
- Flexible mounting with friction blades
- Dimmable to 5% with select dimmers
- Damp location listed
- Rated for IC, ICAT and may be used in Non-IC housings
- Five-year limited warranty

\*Lumens per CCT and beam optic

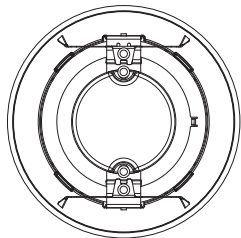
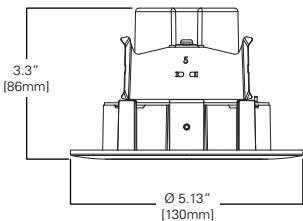



# 4" LED Retrofit Adjustable Gimbal

## Ordering Information

Sample Number: **RA406930WH**

Order Halo housing separately.

### RA4 Models – 4" LED Adjustable Gimbal

#### Very Wide Flood – VWFL Models

**RA406927WH**= 90 CRI, 2700K

**RA406930WH**= 90 CRI, 3000K

#### Narrow Flood – NFL Models

**RA406927NFLWH**= 90 CRI, 2700K

**RA406930NFLWH**= 90 CRI, 3000K

### LED Housings (Order Separately)

See Housing Compatibility, Page 12

### Accessories

**HE26LED**=Replacement screw base adapter (one included with unit)

RA4 Energy Data	NFL	VWFL
Max. Lumens (3000K)	640	615
Input Voltage	120V	
Input Frequency	50/60 Hz	
Input Power	10W	
Input Current	0.85 A	
Power Factor	>0.90	
THD	<20%	
EMI/RFI	FCC Title 47 CFR, Part 15, Class B (Consumer)	
Sound Rating	Class A	
Minimum Starting Temp	-30°C (-22°F)	

**OVER \$500<sup>Δ</sup>  
SAVINGS**

<sup>Δ</sup> Savings are over the life of the Halo RA4 luminaire.

Energy savings: \$387

Replacement lamp savings: \$166

Savings based on \$0.155 per kilowatt hour, average six hours use per day, 50,000 hours of lamp usage, and 60W PAR16 Halogen lamp lumen equivalent.



### 90 CRI



Refer to ENERGY STAR® Certified Products List. Can be used to comply with California Title 24 High Efficacy requirements. Certified to California Title 20 Appliance Efficiency Database.

# RA56 Series

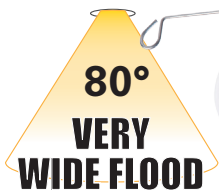

- Adjustable Gimbal for accent, task, grazing and downlighting
  - 35° Tilt, up to 360° rotation
- Beam distribution options
  - NFL - Narrow Flood (25°)
  - VWFL - Very Wide Flood (80°)
- Up to 670 lumens (lumens per selected CCT, CRI and beam optic.)
- Use to replace 65W BR30 lamp (VWFL) or 50W PAR30 lamp (NFL)
- 2700K, 3000K Correlated Color Temperature (CCT)
- 90 CRI
- 10.0W, 120V
- Halo matte white finish
- Compatible with most 5" and 6" standard and shallow recessed housings
- Flexible mounting with torsion springs or friction clips (included)
- Dimmable to 5% with select dimmers
- Damp location listed
- Listed use in IC, ICAT and may be used in Non-IC housings
- Five-year limited warranty

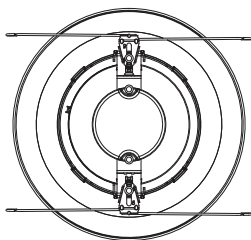
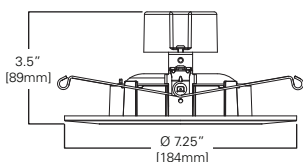

## Ordering Information

Sample Number: **RA5606930WH**

Order Halo housing separately.

### RA56 Models – 5"/6" LED Adjustable Gimbal

#### Very Wide Flood - VWFL Models

**RA5606927WH**= 90CRI, 2700K

**RA5606930WH**= 90CRI, 3000K

#### Narrow Flood - NFL Models

**RA5606927NFLWH**= 90CRI, 2700K

**RA5606930NFLWH**= 90CRI, 3000K

### LED Housings (Order Separately)

See Housing Compatibility, Page 13

### Accessories

**HE26LED**=Replacement screw base adapter (one included with unit)

**RL56CLIP**=Replacement kit of 5" and 6" Friction Clips for retrofitting into an existing housing without torsion spring receiving brackets. (One set of clips included with the unit.)

**OT400P**=Oversize Flat White Metal Trim Ring, 6" I.D. x 9-1/4" O.D. (ring slips behind RA56 ring in stepped configuration)

**OT403P**=Oversize White Plastic Trim Ring, 6" I.D. x 8" O.D. (ring slips behind RA56 ring in stepped configuration)

**TRM690WH**=Oversize Matte White Metal Trim Ring. Designed for RA56 ring to inset into oversize ring for an even (non-stepped) trim surface.

### Friction Clips

5" and 6" friction clips for retrofitting into an existing housing without torsion spring receiving brackets.

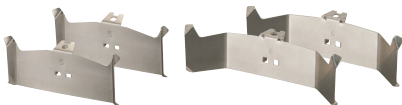

RA56 Energy Data	NFL	VWFL
<b>Max. Lumens (3000K)</b>	640	670
<b>Input Voltage</b>	120V	
<b>Input Frequency</b>	50/60 Hz	
<b>Input Power</b>	10W	
<b>Input Current</b>	0.85 A	
<b>Power Factor</b>	>0.90	
<b>THD</b>	<20%	
<b>EMI/RFI</b>	FCC Title 47 CFR, Part 15, Class B (Consumer)	
<b>Sound Rating</b>	Class A	
<b>Minimum Starting Temp</b>	-30°C (-22°F)	



<sup>A</sup> Savings are over the life of the Halo RA56 luminaire.

Energy savings: \$426

Replacement lamp savings: \$100

Savings based on \$0.155 per kilowatt hour, average six hours use per day, 50,000 hours of lamp usage, and 65W BR30 lamp lumen equivalent.



### 90 CRI



Refer to ENERGY STAR® Certified Products List. Can be used to comply with California Title 24 High Efficacy requirements. Certified to California Title 20 Appliance Efficiency Database.

# RL4 / RA4 Housing Compatibility

**RL4 and RA4 LED are rated for installation in 4" HALO®, All-Pro™ and other housings.**

**Halo LED<sup>1</sup>** H995ICAT, H995RICAT, H245ICAT, H245RICAT

**Halo** H99ICAT, H99RTAT, H99TAT

**Other Brands** The RL/RA Series is UL Certified for use with any 4" diameter recessed housing constructed of steel or aluminum with an internal volume that exceeds 62.3 in<sup>3</sup> in addition to those noted above.

1 Halo LED housings are non-screw base, high-efficacy code compliant.

## H995ICAT

4" LED, IC, AIR-TITE,  
New Construction Housing

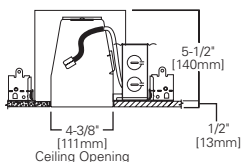

## H995RICAT

4" LED, IC, AIR-TITE,  
Remodel Housing

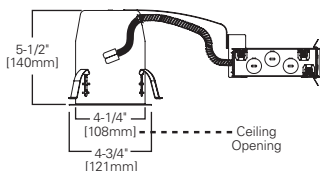

## H245ICAT

4" LED, Ultra-shallow, IC, AIR-TITE, New Construction Housing

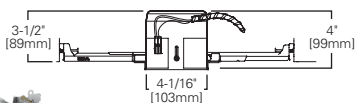
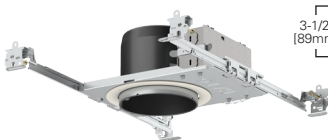

## H245RICAT

4" LED, Ultra-shallow, IC, AIR-TITE, Remodel Housing

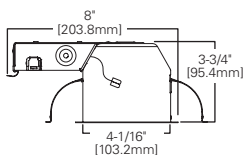

# RL56 / RA56 Housing Compatibility

**RL56 and RA56 LED are rated for installation in 5" and 6" HALO®, All-Pro™ and other housings.**

<b>Halo 5" LED<sup>1</sup></b>	H550ICAT, H550RICAT, E550ICAT, E550RICAT
<b>Halo 6" LED<sup>1</sup></b>	H750ICAT, H750RICAT, H750T, H750RINTD010, H750TCP, H2750ICAT, H2750RICAT, E750ICAT, E750RICAT
<b>Halo 5"</b>	H5ICAT, H5RICAT, H5ICATNB, H5T, H5RT, H25ICAT, H25ICATNB, E5TAT, E5RTAT, H5TNB, E5TATNB, E5ICAT, E5RICAT, E5ICATNB
<b>Halo 6"</b>	H7ICAT, H7RICAT, H7ICT, H7RICT, H7ICATNB, H7ICTNB, H7T, H7RT, H7TNB, H7TCP, H7UICT, H7UICAT, H27ICAT, H27RICAT, H27T, H27RT, E7ICAT, E7RICAT, E27ICAT, E27RICAT, E7ICATNB, E7TAT, E7RTAT, E7TATNB, E27TAT, E27RTAT
<b>Halo LED Retrofit</b>	ML7BXRFK, ML7E26RFK
<b>Other Brands*</b>	The RL/RA Series is UL Certified for use with any 5" / 6" diameter recessed housing constructed of steel or aluminum with an internal volume that exceeds 107.9 in <sup>3</sup> in addition to those noted above.

\*When using RL56 torsion springs or with RA56 torsion springs for retrofit some housings will not have torsion spring receiver brackets –use Halo ML7RAB retrofit adapter band (order separately)

1 Halo LED housings are non-screw base, high-efficacy code compliant.

## H750ICAT

6" LED, IC, AIR-TITE, Standard New Construction Housing

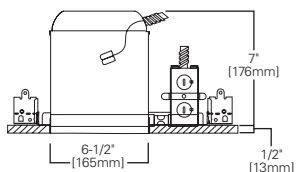

## H2750ICAT

6" LED, IC, AIR-TITE, Shallow New Construction Housing

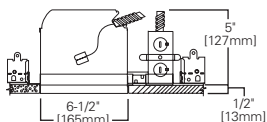

## H750RICAT

6" LED, IC, AIR-TITE, Standard Remodel Housing

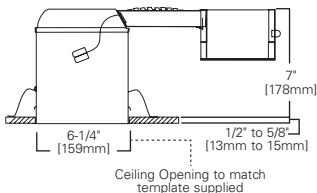

# Product and Photometric Data

## RL4 and RL56 - 600 Series

Cat No.	CRI	CCT	Lumens	Power (W)	LPW
RL460WH927PK	92	2700	530	8.0	66
RL460WH930PK	90	3000	570	8.0	71
RL460WH935PK	92	3500	550	8.0	69
RL460WH940PK	92	4000	560	8.0	67
RL460WH950PK	92	5000	600	8.2	73
RL560WH6927	92	2700	630	8.7	72
RL560WH6930	91	3000	645	8.8	73
RL560WH6935	92	3500	650	8.9	73
RL560WH6940	92	4000	690	9.2	75
RL560WH6950	90	5000	715	8.9	80

### RL56-600 Series Photometric\*

RL560WH6930		
Luminaire lumens		645
Input watts		8.8
LER (LPW)		73.3
Spacing Criteria	0-180	1.14
	90-270	1.14
	Diagonal	1.22
Beam angle (degrees)		87.8
Field angle (degrees)		139
Zonal lumen	Lumens	% Lumens
0-30	240	37.2
0-40	375	58.2
0-60	577	89.4
0-90	645	100

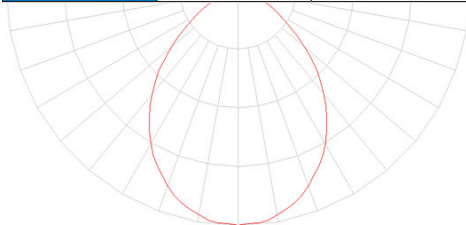

## RL56 - 900 SERIES

Cat No.	CRI	CCT	Lumens	Power (W)	LPW
RL560WH9927	92	2700	940	12.6	75
RL560WH9930	91	3000	930	12.8	73
RL560WH9935	92	3500	940	12.7	74
RL560WH9940	90	4000	1000	13.2	76
RL560WH9950	90	5000	1015	12.9	79

### RL56-900 Series Photometric\*

RL560WH9830		
Luminaire lumens		930
Input watts		12.8
LER (LPW)		72.7
Spacing Criteria	0-180	1.16
	90-270	1.16
	Diagonal	1.22
Beam angle (degrees)		88.9
Field angle (degrees)		140
Zonal lumen	Lumens	% Lumens
0-30	341	36.7
0-40	535	57.5
0-60	829	89.1
0-90	930	100

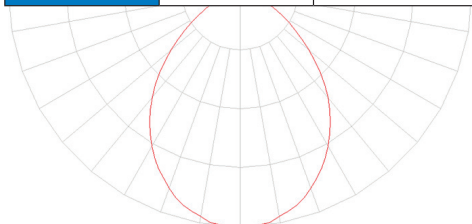

- Downlight distribution
- Maximum spacing criteria
- Optimized design for general downlighting
- Exceeds 86% of light between 0-60° cone-of-light zone
- ENERGY STAR® and California Title 24 - zonal and efficacy requirements

\*Additional photometric ies files available online.

# Product and Photometric Data

## RL56 - 1200 SERIES

Cat No.	CRI	CCT	Lumens	Power (W)	LPW
RL560WH12927	90	2700	1230	17.3	71
RL560WH12930	90	3000	1240	17.6	70
RL560WH12935	90	3500	1280	17.7	72
RL560WH12940	90	4000	1330	18	74
RL560WH12950	90	5000	1325	17.4	76

### RL56-1200 Series Photometric\*

RL560WH12930		
Luminaire lumens		1240
Input watts		17.6
LER (LPW)		70.5
Spacing Criteria	0-180	1.16
	90-270	1.16
	Diagonal	1.22
Beam angle (degrees)		89.1
Field angle (degrees)		140.1
Zonal lumen	Lumens	% Lumens
0-30	454	36.6
0-40	714	57.6
0-60	1105	89.1
0-90	1240	100

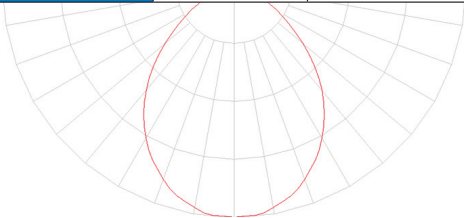



## RA4 and RA56 - Very Wide Flood Series

Cat No.	CRI	CCT	Lumens	Power (W)	LPW
RA406927WH	90	2700	600	10	60
RA406930WH	90	3000	615	10	62
RA5606927WH	90	2700	645	10	64
RA5606930WH	90	3000	670	10	67

### RA56 - Very Wide Flood Series Photometric\*

RA5606930WH		
Luminaire lumens		670
Input watts		10
LER (LPW)		67
Spacing Criteria	0-180	1.24
	90-270	1.24
	Diagonal	1.3
Beam angle (degrees)		97
Field angle (degrees)		147
Zonal lumen	Lumens	% Lumens
0-30	222	33%
0-40	358	53%
0-60	582	87%
0-90	1030	100%

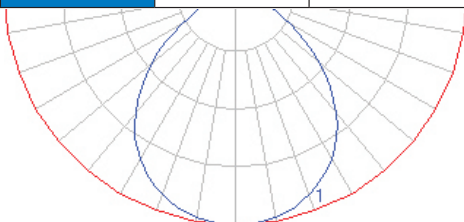

\*Additional photometric ies files available online.

# Product and Photometric Data

## RA4 and RA56 - Narrow Flood Series

Cat No.	CRI	CCT	Lumens	Power (W)	LPW
RA406927NFLWH	90	2700	640	10	64
RA406930NFLWH	90	3000	640	10	64
RA5606927NFLWH	90	2700	630	10	63
RA5606930NFLWH	90	3000	640	10	64

## RA56 - Narrow Flood Series Photometric\*

RA5606930NFLWH		
Luminaire lumens		640
Input watts		10
LER (LPW)		64
Spacing Criteria	0-180	0.38
	90-270	0.38
	Diagonal	0.38
Beam angle (degrees)		21
Field angle (degrees)		48
Zonal lumen	Lumens	% Lumens
0-30	542	85%
0-40	590	92%
0-60	627	98%
0-90	640	100%

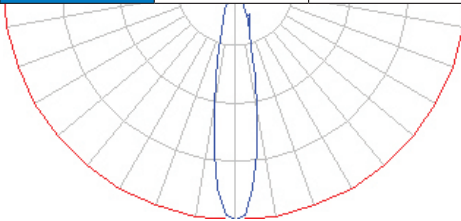

\*Additional photometric ies files available online.

## Lighting Control Solution

Eaton dimmers offer versatile options to set the mood and reduce energy consumption. These compatible LED dimmers are ideal for both residential and light commercial applications and are compatible with decorator (screwless) style devices and wallplates. Refer to [www.eaton.com](http://www.eaton.com) for additional information.



**Decorator**  
(DAL06P)



**Slide**  
(SAL06P)



**Toggle**  
(TAL06P)



## Eaton

1121 Highway 74 South  
Peachtree City, GA 30269  
P: 770-486-4800  
[www.eaton.com/lighting](http://www.eaton.com/lighting)

Canada Sales  
5925 McLaughlin Road  
Mississauga, Ontario L5R 1B8  
P: 905-501-3000  
F: 905-501-3172

### Our Lighting Product Lines

Halo  
Halo Commercial  
Portfolio  
IRiS  
RSA  
Metalux  
Corelite  
Neo-Ray  
Fail-Safe  
MWS  
Ametrix  
Shaper  
io  
Lumark  
McGraw-Edison  
Invue  
Lumière  
Streetworks  
AtLite  
Sure-Lites

### Our Controls Product Lines

Greengate  
iLumin  
Zero 88  
Fifth Light Technology  
iLight (International Only)

#### Eaton

1121 Highway 74 South  
Peachtree City, GA 30269  
P: 770-486-4800  
[www.eaton.com/lighting](http://www.eaton.com/lighting)

© 2017 Eaton  
All Rights Reserved  
Printed in USA  
Publication No. BR518044EN  
November 2017

Products, specifications and  
compliances are subject to  
change without notice.

Eaton is a registered trademark.

All other trademarks are property  
of their respective owners.



*Powering Business Worldwide*