

**DESCRIPTION**

The Halo RA4 LED Adjustable Gimbal series are retrofit LED Modules for 4" aperture recessed downlights. The RA4 gimbals feature adjustment of 35-degree tilt and up to 360-degree rotation. In addition the RA4 gimbals offer selection of narrow flood (NFL) and very wide flood (VWFL) models for beam distributions suitable for accent, task, grazing and general area lighting. The RA4 integral LED 120V driver is dimmable with most leading edge and trailing edge phase control dimmers.

Catalog #		Type
Project		
Comments		Date
Prepared by		

**SPECIFICATION FEATURES**

**MECHANICAL**

- Module includes LED, heat sink, reflector, lens optic, baffle reveal, and trim ring
- Durable die-cast aluminum construction
- Integrated heat sink design conducts heat away from the LED keeping the junction temperatures below specified maximums, even when installed in insulated ceiling environments
- Halo matte white paint finish
- 35-degree tilt
- Up to 360-degree rotation

**Optics**

**NARROW FLOOD - NFL**

- Precision acrylic lens
- Optical design creates a clean, uniform 25-degree beam distribution

**VERY WIDE FLOOD - VWFL**

- Impact-resistant polycarbonate
- Convex form for lamp-like appearance
- Diffusing, wide beam for even illumination

**MOUNTING**

**Friction Blades**

- Precision formed spring blades secure module with friction fit to compatible housings.
- Friction blade design allows the RA4 to be installed in any position within the housing aperture (360 degrees)

**Housing Compatibility**

See Housing Compatibility

**LED**

- Color Temperature (CCT)  
Options: 2700K, 3000K
- Color Rendering Index (CRI) 90
- LED is a chip on board design consisting of a multiple LED package with proximity phosphor coating to create one virtual white light source for a productive "cone of light"

**ELECTRICAL**

**Power Connections**

- LED connector is a non-screw base luminaire disconnect offering easy installation with the matching Halo H995 Series housings.
- LED Connector meets high-efficacy luminaire requirements for a non-screw base socket, and where required to qualify as a high-efficacy luminaire. (California Title-24)
- The included E26 medium screw-base Edison adapter provides easy retrofit of incandescent housings (see Housing Compatibility).

**Ground Connection**

- Separate grounding cable included on the module for attachment to the housing during installation.

**LED Driver**

- Dimmable driver is a 120 Volt, high efficiency, electronic power supply providing DC power to the LED.
- Driver meets FCC EMI/RFI Consumer Level limits for use in residential and commercial installations.
- Driver features high power factor, low THD, and has integral thermal protection in the event of over temperature or internal failure.
- Driver mounts externally to the module, allowing future replacement, if needed.

**Dimming**

- The Halo RA4 LED is designed for dimming capability to 10% in normal operation with standard 120V leading edge (LE) and trailing edge (TE) phase control dimmers.
- The LED module may also dim to 5% nominal using dimmers with low end trim adjustment. (Consult dimmer manufacturer for dimmer details. Note, some dimmers require a neutral in the wallbox.)

**Warranty**

Cooper Lighting provides a five year limited warranty on RA56 LED.

**Compliance Labels**

- UL/cUL Listed 1598 Luminaire (with listed Halo housings)
- UL Classified (with other housings - see Housing Compatibility)
- UL/cUL Listed for Damp Location
- May be installed in housings in direct contact with air permeable insulation\*\* and combustible material
- IP ingress protection rating  
NFL models: IP25  
VWFL models: IP34

**Qualification**

- ENERGY STAR® qualified residential and commercial\*
- Can be used for State of California Title 24 high efficacy luminaire compliance\*
- Can be used for Washington State Energy Code (WSEC) and International Energy Conservation Code (IECC) high efficacy luminaire Compliance

**IC (Insulated Ceiling)**

Listed UL/cUL 1598 with compatible housings, may be used to meet insulated ceiling\*\* requirements such as:  
 • Washington State Energy Code (WSEC)  
 • International Energy Conservation Code (IECC)  
 • New York State Energy Conservation Construction Code (NY-ECCC)  
 • State of California Title 24 "Recessed Luminaires in Insulated Ceilings."



**RA4 LED  
Very Wide Flood  
(VWFL)**



**RA4 LED  
Narrow Flood  
(NFL)  
4-Inch  
Adjustable Gimbals  
All-Purpose Recessed  
Retrofit Modules**

**FOR USE IN INSULATED  
CEILING AND NON-  
INSULATED  
CEILING RATED HOUSINGS**

**HIGH EFFICACY LED  
WITH INTEGRAL DRIVER -  
DIMMABLE**

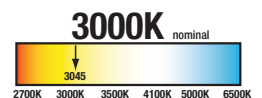
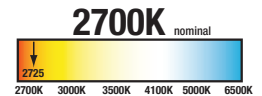

\*Qualified and compliant. Refer to ENERGY STAR® Qualified Products List and CEC (T24) Appliance Database for listings.

\*\* Not for use with housings in direct contact with spray foam insulation.

**ENERGY DATA**

Minimum Starting Temp: -30°C (-22°F)
EM/RFI: FCC Title 47 CFR, Part 15, Class B (Consumer)
Sound Rating: Class A standards
Input Voltage: 120V
Power Factor: >0.90
Input Frequency: 50/60Hz
THD: <20%
Input Power: 10W
Input Current: 85mA

Driver-Safety Agency Approvals:

- UL60950-1 Recognized
- LPS output
- UL8750 Compliant

Maximum IC (Insulated Ceiling) Ambient Continuous Operating Temperature: 25°C (77°F)

Maximum Non-IC (NON-Insulated Ceiling) Ambient Continuous Operating Temperature 40°C (104°F)

**DIMENSIONS**

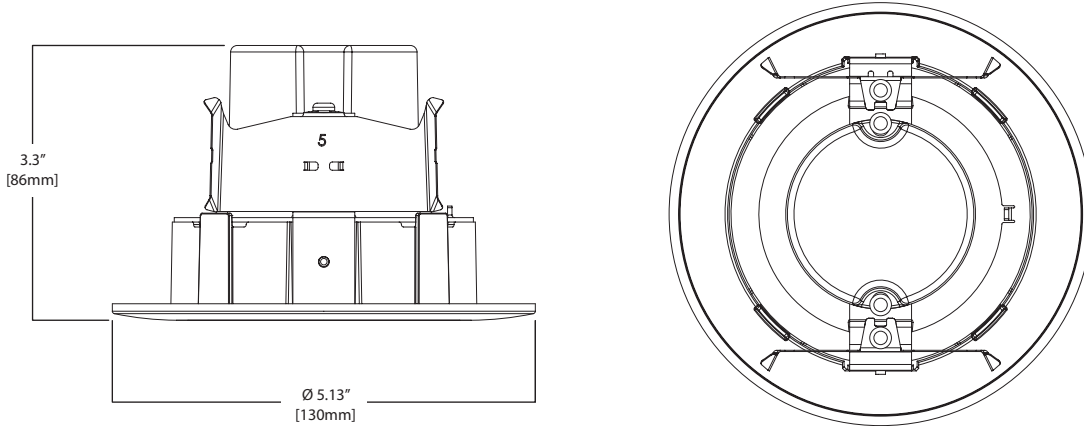

**LIGHTING FACTS**

**RA406927WH**  
2700K Source  
VWFL Beam

**Lighting facts**  
A Program of the U.S. DOE

Light Output (Lumens)	600
Watts	10
Lumens per Watt (Efficacy)	60
Color Accuracy Color Rendering Index (CRI)	90
Light Color Correlated Color Temperature (CCT)	2700 (Warm White)

Warm White 2700K 3000K Bright White 4500K Daylight 6500K

All results are according to IESNA LM-79-2008. Approved Method for the Electrical and Photometric Testing of Solid-State Lighting. The U.S. Department of Energy (DOE) verifies product test data and results.

Visit [www.lightingfacts.com](http://www.lightingfacts.com) for the Label Reference Guide.

Registration Number: F4QJMA646H (10/25/2013)  
Model Number: RA406927WH  
Type: Retrofit Kit - Downlight

**RA406930WH**  
3000K Source  
VWFL Beam

**Lighting facts**  
A Program of the U.S. DOE

Light Output (Lumens)	615
Watts	10
Lumens per Watt (Efficacy)	61
Color Accuracy Color Rendering Index (CRI)	90
Light Color Correlated Color Temperature (CCT)	3000 (Bright White)

Warm White 2700K 3000K Bright White 4500K Daylight 6500K

All results are according to IESNA LM-79-2008. Approved Method for the Electrical and Photometric Testing of Solid-State Lighting. The U.S. Department of Energy (DOE) verifies product test data and results.

Visit [www.lightingfacts.com](http://www.lightingfacts.com) for the Label Reference Guide.

Registration Number: F4QJ15CJ0B (10/25/2013)  
Model Number: RA406930WH  
Type: Retrofit Kit - Downlight

**RA406927NFLWH**  
2700K Source  
NFL Beam

**Lighting facts**  
A Program of the U.S. DOE

Light Output (Lumens)	640
Watts	10
Lumens per Watt (Efficacy)	64
Color Accuracy Color Rendering Index (CRI)	90
Light Color Correlated Color Temperature (CCT)	2700 (Warm White)

Warm White 2700K 3000K Bright White 4500K Daylight 6500K

All results are according to IESNA LM-79-2008. Approved Method for the Electrical and Photometric Testing of Solid-State Lighting. The U.S. Department of Energy (DOE) verifies product test data and results.

Visit [www.lightingfacts.com](http://www.lightingfacts.com) for the Label Reference Guide.

Registration Number: F4QJ-OTFN0L (10/25/2013)  
Model Number: RA406927NFLWH  
Type: Retrofit Kit - Downlight

**RA406930NFLWH**  
3000K Source  
NFL Beam

**Lighting facts**  
A Program of the U.S. DOE

Light Output (Lumens)	640
Watts	10
Lumens per Watt (Efficacy)	64
Color Accuracy Color Rendering Index (CRI)	90
Light Color Correlated Color Temperature (CCT)	3000 (Bright White)

Warm White 2700K 3000K Bright White 4500K Daylight 6500K

All results are according to IESNA LM-79-2008. Approved Method for the Electrical and Photometric Testing of Solid-State Lighting. The U.S. Department of Energy (DOE) verifies product test data and results.

Visit [www.lightingfacts.com](http://www.lightingfacts.com) for the Label Reference Guide.

Registration Number: F4QJ41D24Z (10/25/2013)  
Model Number: RA406930NFLWH  
Type: Retrofit Kit - Downlight

For further information refer to the Lighting Facts website at <http://lightingfacts.com/>.

**ORDERING INFORMATION**

**SAMPLE NUMBER:** RA406930WH

Complete unit includes RA4 LED and a compatible 4" housing; ordered separately.

RA4 Series	Accessory (order separately)
<p><b>Very Wide Flood - VWFL Models</b>  <b>RA406927WH</b>= 4" LED Adjustable Gimbal, 90CRI, 2700K, White, Very Wide Flood  <b>RA406930WH</b>= 4" LED Adjustable Gimbal, 90CRI, 3000K, White, Very Wide Flood</p> <p><b>Narrow Flood - NFL Models</b>  <b>RA406927NFLWH</b>= 4" LED Adjustable Gimbal, 90CRI, 2700K, White, Narrow Flood  <b>RA406930NFLWH</b>= 4" LED Adjustable Gimbal, 90CRI, 3000K, White, Narrow Flood</p>	<p><b>HE26LED</b>=Replacement screw base adapter (one included with unit)</p>

**LED Housing**

Series
<p><b>H995ICAT</b>= 4" LED Insulated Ceiling, AIR-TITE New Construction Housing with LED luminaire connector (high efficacy compliant)  <b>H995RICAT</b>= 4" LED Insulated Ceiling, AIR-TITE Remodel Housing with LED luminaire connector (high efficacy compliant)</p>

**HOUSING COMPATIBILITY**

<p><b>UL Listed</b>                      UL/cUL Listed for installation in the following Halo and All-Pro 4" recessed E26 screw based and LED dedicated housings.</p>	All-Pro™	ET400ATSB, ET400RATSB, EI400ATSB
	Halo®	H99ICAT, H99RTAT, H99TAT, H995ICAT, H995RICAT
<p><b>UL Classified</b>                      UL Classified for retrofit in the following 4" recessed E26 screw based housings.</p>	Utilitech	CR04ICAT
	Thomas®	PS4
	Lithonia Lighting®	L3, L3R
	Commercial Electric™	HBR2000B
	Juno®	TC1, TC1R
	Progress Lighting®	P830-TG, P832-TG

Juno®, Lithonia Lighting®, Thomas® Lighting, Progress® Lighting, Utilitech, and Commercial Electric™ and their product brand names, where identified above, are tradenames or trademarks of each respective company and Cooper Lighting makes no representations on these trademarks.

PHOTOMETRY

**RA406927WH**

Reflector Beam Angle = VWFL Beam  
(Very Wide Flood)

CCT = 2700K  
Spacing Criteria = 1.18  
Lumens per Watt = 60 Lm/W  
Test No. P121906  
Test Model: RA406927WH

Cone of Light Footcandles 0 deg Aiming Angle Horizontal Illuminance on Floor			
Distance to Illuminated Plane	Initial Nadir Footcandles	Beam (ft.)	
		L Length	W Width
5.5'	9.7	6.4	6.4
7'	6	8.2	8.2
8'	4.6	9.4	9.4
9'	3.6	10.6	10.6
10'	2.9	11.8	11.8

Cone of Light Footcandles 35 deg Aiming Angle Vertical Illuminance on Wall				
Distance to Illuminated Plane	Initial Nadir Footcandles	Beam (ft.)		CB
		L Length	W Width	
2'	43.5	2.1	2.4	2.9
3'	19.3	3.2	3.6	4.3
4'	10.9	4.2	4.8	5.7
5'	7	5.3	6	7.1
6'	4.8	6.4	7.4	8.6
8'	2.7	8.6	9.8	11.4
10'	1.7	10.8	12.2	14.3

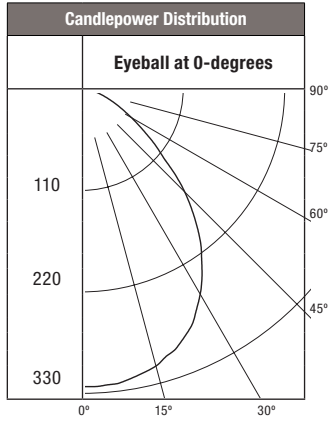

Candela Distribution	
Degrees Vertical	Candela
0*	293
5	293
15	283
25	257
35	206
45	144
55	79
65	40
75	18
85	6
90	0

Luminance (Average Candela/M <sup>2</sup> )	
Degree	Avg. 0° Luminance
45	43944
55	29652
65	20532
75	15132
85	14648

Zonal Lumen Summary		
Zone	Lumens	% Fixture
0-30	225	37.4
0-40	354	58.9
0-60	534	89.0
0-90	600	100

\*CBCP

**RA406930WH**

Reflector Beam Angle = VWFL Beam  
(Very Wide Flood)

CCT = 3000K  
Spacing Criteria = 1.18  
Lumens per Watt = 61.5 Lm/W  
Test No. P121908  
Test Model: RA406930WH

Cone of Light Footcandles 0 deg Aiming Angle Horizontal Illuminance on Floor			
Distance to Illuminated Plane	Initial Nadir Footcandles	Beam (ft.)	
		L Length	W Width
5.5'	9.9	6.4	6.4
7'	6.1	8.2	8.2
8'	4.7	9.4	9.4
9'	3.7	10.6	10.6
10'	3	11.8	11.8

Cone of Light Footcandles 35 deg Aiming Angle Vertical Illuminance on Wall				
Distance to Illuminated Plane	Initial Nadir Footcandles	Beam (ft.)		CB
		L Length	W Width	
2'	44.6	2.1	2.4	2.9
3'	19.8	3.2	3.6	4.3
4'	11.1	4.2	4.8	5.7
5'	7.1	5.3	6	7.1
6'	5	6.4	7.4	8.6
8'	2.8	8.6	9.8	11.4
10'	1.8	10.8	12.2	14.3

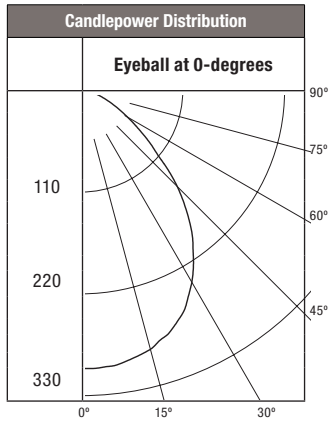

Candela Distribution	
Degrees Vertical	Candela
0*	301
5	300
15	290
25	263
35	211
45	147
55	81
65	41
75	19
85	6
90	0

Luminance (Average Candela/M <sup>2</sup> )	
Degree	Avg. 0° Luminance
45	45015
55	30407
65	21044
75	15551
85	14896

Zonal Lumen Summary		
Zone	Lumens	% Fixture
0-30	230	37.4
0-40	362	58.9
0-60	548	89.0
0-90	615	100

\*CBCP

PHOTOMETRY

**RA406927NFLWH**

Reflector Beam Angle = NFL Beam  
(Narrow Flood)

CCT = 2700K  
Spacing Criteria = 0.35  
Lumens per Watt = 64 Lm/W  
Test No. P121904  
Test Model: RA406927NFLWH

Cone of Light Footcandles 0 deg Aiming Angle Horizontal Illuminance on Floor				
Distance to Illuminated Plane	Initial Nadir Footcandles	Beam (ft.)		
		L Length	W Width	
5.5'	98.7	1.8	1.8	
7'	60.9	2.4	2.4	
8'	46.6	2.8	2.8	
9'	36.9	3	3	
10'	29.9	3.4	3.4	

Cone of Light Footcandles 35 deg Aiming Angle Vertical Illuminance on Wall				
Distance to Illuminated Plane	Initial Nadir Footcandles	Beam (ft.)		CB
		L Length	W Width	
2'	168	1.7	1	2.9
3'	74.7	2.6	1.6	4.3
4'	42	3.5	2.2	5.7
5'	26.9	4.4	2.8	7.1
6'	18.7	5.3	3.4	8.6
8'	10.5	7.1	4.4	11.4
10'	6.7	8.9	5.6	14.3

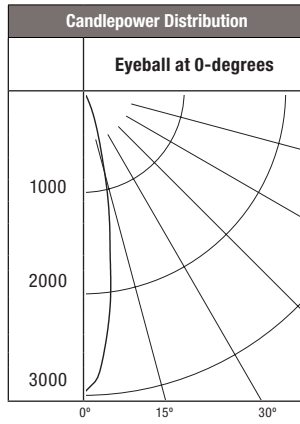

Candela Distribution	
Degrees Vertical	Candela
0*	2985
5	2531
15	836
25	223
35	62
45	27
55	14
65	6
75	2
85	0
90	0

Luminance (Average Candela/M²)	
Degree	Avg. 0° Luminance
45	6559
55	3723
65	1726
75	577
85	168

Zonal Lumen Summary		
Zone	Lumens	% Fixture
0-30	556	86.9
0-40	598	93.4
0-60	631	98.7
0-90	640	100

\*CBCP

**RA406930NFLWH**

Reflector Beam Angle = NFL Beam  
(Narrow Flood)

CCT = 3000K  
Spacing Criteria = 0.35  
Lumens per Watt = 64 Lm/W  
Test No. P121905  
Test Model: RA406930NFLWH

Cone of Light Footcandles 0 deg Aiming Angle Horizontal Illuminance on Floor				
Distance to Illuminated Plane	Initial Nadir Footcandles	Beam (ft.)		
		L Length	W Width	
5.5'	98.7	1.8	1.8	
7'	60.9	2.4	2.4	
8'	46.6	2.8	2.8	
9'	36.9	3	3	
10'	29.9	3.4	3.4	

Cone of Light Footcandles 35 deg Aiming Angle Vertical Illuminance on Wall				
Distance to Illuminated Plane	Initial Nadir Footcandles	Beam (ft.)		CB
		L Length	W Width	
2'	168	1.7	1	2.9
3'	74.7	2.6	1.6	4.3
4'	42	3.5	2.2	5.7
5'	26.9	4.4	2.8	7.1
6'	18.7	5.3	3.4	8.6
8'	10.5	7.1	4.4	11.4
10'	6.7	8.9	5.6	14.3

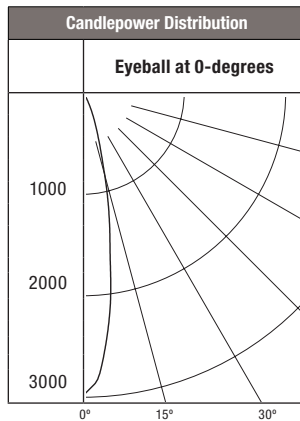

Candela Distribution	
Degrees Vertical	Candela
0*	2985
5	2531
15	836
25	223
35	62
45	27
55	14
65	6
75	2
85	0
90	0

Luminance (Average Candela/M²)	
Degree	Avg. 0° Luminance
45	6559
55	3723
65	1726
75	577
85	168

Zonal Lumen Summary		
Zone	Lumens	% Fixture
0-30	556	86.9
0-40	598	93.4
0-60	631	98.7
0-90	640	100

\*CBCP

**DESCRIPTION**

The Halo RA4 LED Adjustable Gimbal series are retrofit LED Modules for 4" aperture recessed downlights. The RA4 gimbals feature adjustment of 35-degree tilt and up to 360-degree rotation. In addition the RA4 gimbals offer selection of narrow flood (NFL) and very wide flood (VWFL) models for beam distributions suitable for accent, task, grazing and general area lighting. The RA4 integral LED 120V driver is dimmable with most leading edge and trailing edge phase control dimmers.

Catalog #		Type
Project		
Comments		Date
Prepared by		

**SPECIFICATION FEATURES**

**MECHANICAL**

- Module includes LED, heat sink, reflector, lens optic, baffle reveal, and trim ring
- Durable die-cast aluminum construction
- Integrated heat sink design conducts heat away from the LED keeping the junction temperatures below specified maximums, even when installed in insulated ceiling environments
- Halo matte white paint finish
- 35-degree tilt
- Up to 360-degree rotation

**Optics**

**NARROW FLOOD - NFL**

- Precision acrylic lens
- Optical design creates a clean, uniform 25-degree beam distribution

**VERY WIDE FLOOD - VWFL**

- Impact-resistant polycarbonate
- Convex form for lamp-like appearance
- Diffusing, wide beam for even illumination

**MOUNTING**

**Friction Blades**

- Precision formed spring blades secure module with friction fit to compatible housings.
- Friction blade design allows the RA4 to be installed in any position within the housing aperture (360 degrees)

**Housing Compatibility**

See Housing Compatibility

**LED**

- Color Temperature (CCT)  
Options: 2700K, 3000K
- Color Rendering Index (CRI) 90
- LED is a chip on board design consisting of a multiple LED package with proximity phosphor coating to create one virtual white light source for a productive "cone of light"

**ELECTRICAL**

**Power Connections**

- LED connector is a non-screw base luminaire disconnect offering easy installation with the matching Halo H995 Series housings.
- LED Connector meets high-efficacy luminaire requirements for a non-screw base socket, and where required to qualify as a high-efficacy luminaire. (California Title-24)
- The included E26 medium screw-base Edison adapter provides easy retrofit of incandescent housings (see Housing Compatibility).

**Ground Connection**

- Separate grounding cable included on the module for attachment to the housing during installation.

**LED Driver**

- Dimmable driver is a 120 Volt, high efficiency, electronic power supply providing DC power to the LED.
- Driver meets FCC EMI/RFI Consumer Level limits for use in residential and commercial installations.
- Driver features high power factor, low THD, and has integral thermal protection in the event of over temperature or internal failure.
- Driver mounts externally to the module, allowing future replacement, if needed.

**Dimming**

- The Halo RA4 LED is designed for dimming capability to 10% in normal operation with standard 120V leading edge (LE) and trailing edge (TE) phase control dimmers.
- The LED module may also dim to 5% nominal using dimmers with low end trim adjustment. (Consult dimmer manufacturer for dimmer details. Note, some dimmers require a neutral in the wallbox.)

**Warranty**

Cooper Lighting provides a five year limited warranty on RA56 LED.

**Compliance Labels**

- UL/cUL Listed 1598 Luminaire (with listed Halo housings)
- UL Classified (with other housings - see Housing Compatibility)
- UL/cUL Listed for Damp Location
- May be installed in housings in direct contact with air permeable insulation\*\* and combustible material
- IP ingress protection rating  
NFL models: IP25  
VWFL models: IP34

**Qualification**

- ENERGY STAR® qualified residential and commercial\*
- Can be used for State of California Title 24 high efficacy luminaire compliance\*
- Can be used for Washington State Energy Code (WSEC) and International Energy Conservation Code (IECC) high efficacy luminaire Compliance

**IC (Insulated Ceiling)**

Listed UL/cUL 1598 with compatible housings, may be used to meet insulated ceiling\*\* requirements such as:  
 • Washington State Energy Code (WSEC)  
 • International Energy Conservation Code (IECC)  
 • New York State Energy Conservation Construction Code (NY-ECCC)  
 • State of California Title 24 "Recessed Luminaires in Insulated Ceilings."



**RA4 LED  
Very Wide Flood  
(VWFL)**



**RA4 LED  
Narrow Flood  
(NFL)  
4-Inch  
Adjustable Gimbals  
All-Purpose Recessed  
Retrofit Modules**

**FOR USE IN INSULATED  
CEILING AND NON-  
INSULATED  
CEILING RATED HOUSINGS**

**HIGH EFFICACY LED  
WITH INTEGRAL DRIVER -  
DIMMABLE**

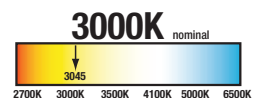
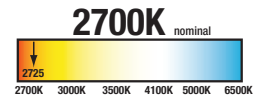

\*Qualified and compliant. Refer to ENERGY STAR® Qualified Products List and CEC (T24) Appliance Database for listings.

\*\* Not for use with housings in direct contact with spray foam insulation.

**ENERGY DATA**

Minimum Starting Temp: -30°C (-22°F)
EMV/RFI: FCC Title 47 CFR, Part 15, Class B (Consumer)
Sound Rating: Class A standards
Input Voltage: 120V
Power Factor: >0.90
Input Frequency: 50/60Hz
THD: <20%
Input Power: 10W
Input Current: 85mA

Driver-Safety Agency Approvals:

- UL60950-1 Recognized
- LPS output
- UL8750 Compliant

Maximum IC (Insulated Ceiling) Ambient Continuous Operating Temperature: 25°C (77°F)

Maximum Non-IC (NON-Insulated Ceiling) Ambient Continuous Operating Temperature 40°C (104°F)

**DIMENSIONS**

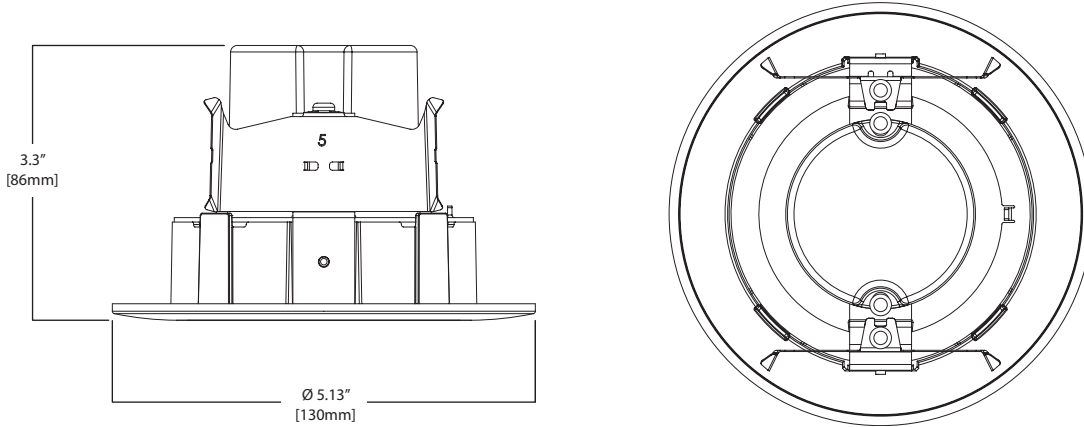

**LIGHTING FACTS**

**RA406927WH**  
2700K Source  
VWFL Beam

**Lighting Facts**  
A Program of the U.S. DOE

Light Output (Lumens)	600
Watts	10
Lumens per Watt (Efficacy)	60
Color Accuracy Color Rendering Index (CRI)	90
Light Color Correlated Color Temperature (CCT)	2700 (Warm White)

Warm White 2700K 3000K Bright White 4500K Daylight 6500K

All results are according to IESNA LM-79-2008. Approved Method for the Electrical and Photometric Testing of Solid-State Lighting. The U.S. Department of Energy (DOE) verifies product test data and results.

Visit [www.lightingfacts.com](http://www.lightingfacts.com) for the Label Reference Guide.

Registration Number: F4QJMA646H (10/25/2013)  
Model Number: RA406927WH  
Type: Retrofit Kit - Downlight

**RA406930WH**  
3000K Source  
VWFL Beam

**Lighting Facts**  
A Program of the U.S. DOE

Light Output (Lumens)	615
Watts	10
Lumens per Watt (Efficacy)	61
Color Accuracy Color Rendering Index (CRI)	90
Light Color Correlated Color Temperature (CCT)	3000 (Bright White)

Warm White 2700K 3000K Bright White 4500K Daylight 6500K

All results are according to IESNA LM-79-2008. Approved Method for the Electrical and Photometric Testing of Solid-State Lighting. The U.S. Department of Energy (DOE) verifies product test data and results.

Visit [www.lightingfacts.com](http://www.lightingfacts.com) for the Label Reference Guide.

Registration Number: F4QJ15CJ0B (10/25/2013)  
Model Number: RA406930WH  
Type: Retrofit Kit - Downlight

**RA406927NFLWH**  
2700K Source  
NFL Beam

**Lighting Facts**  
A Program of the U.S. DOE

Light Output (Lumens)	640
Watts	10
Lumens per Watt (Efficacy)	64
Color Accuracy Color Rendering Index (CRI)	90
Light Color Correlated Color Temperature (CCT)	2700 (Warm White)

Warm White 2700K 3000K Bright White 4500K Daylight 6500K

All results are according to IESNA LM-79-2008. Approved Method for the Electrical and Photometric Testing of Solid-State Lighting. The U.S. Department of Energy (DOE) verifies product test data and results.

Visit [www.lightingfacts.com](http://www.lightingfacts.com) for the Label Reference Guide.

Registration Number: F4QJ-OTFN0L (10/25/2013)  
Model Number: RA406927NFLWH  
Type: Retrofit Kit - Downlight

**RA406930NFLWH**  
3000K Source  
NFL Beam

**Lighting Facts**  
A Program of the U.S. DOE

Light Output (Lumens)	640
Watts	10
Lumens per Watt (Efficacy)	64
Color Accuracy Color Rendering Index (CRI)	90
Light Color Correlated Color Temperature (CCT)	3000 (Bright White)

Warm White 2700K 3000K Bright White 4500K Daylight 6500K

All results are according to IESNA LM-79-2008. Approved Method for the Electrical and Photometric Testing of Solid-State Lighting. The U.S. Department of Energy (DOE) verifies product test data and results.

Visit [www.lightingfacts.com](http://www.lightingfacts.com) for the Label Reference Guide.

Registration Number: F4QJ41D24Z (10/25/2013)  
Model Number: RA406930NFLWH  
Type: Retrofit Kit - Downlight

For further information refer to the Lighting Facts website at <http://lightingfacts.com/>.

**ORDERING INFORMATION**

**SAMPLE NUMBER:** RA406930WH

Complete unit includes RA4 LED and a compatible 4" housing; ordered separately.

RA4 Series	Accessory (order separately)
<p><b>Very Wide Flood - VWFL Models</b>                      RA406927WH= 4" LED Adjustable Gimbal, 90CRI, 2700K, White, Very Wide Flood                      RA406930WH= 4" LED Adjustable Gimbal, 90CRI, 3000K, White, Very Wide Flood</p> <p><b>Narrow Flood - NFL Models</b>                      RA406927NFLWH= 4" LED Adjustable Gimbal, 90CRI, 2700K, White, Narrow Flood                      RA406930NFLWH= 4" LED Adjustable Gimbal, 90CRI, 3000K, White, Narrow Flood</p>	<p><b>HE26LED</b>=Replacement screw base adapter (one included with unit)</p>

**LED Housing**

Series
<p><b>H995ICAT</b>= 4" LED Insulated Ceiling, AIR-TITE New Construction Housing with LED luminaire connector (high efficacy compliant)  <b>H995RICAT</b>= 4" LED Insulated Ceiling, AIR-TITE Remodel Housing with LED luminaire connector (high efficacy compliant)</p>

**HOUSING COMPATIBILITY**

<p><b>UL Listed</b>                      UL/cUL Listed for installation in the following Halo and All-Pro 4" recessed E26 screw based and LED dedicated housings.</p>	All-Pro™	ET400ATSB, ET400RATSB, EI400ATSB
	Halo®	H99ICAT, H99RTAT, H99TAT, H995ICAT, H995RICAT
<p><b>UL Classified</b>                      UL Classified for retrofit in the following 4" recessed E26 screw based housings.</p>	Utilitech	CR04ICAT
	Thomas®	PS4
	Lithonia Lighting®	L3, L3R
	Commercial Electric™	HBR2000B
	Juno®	TC1, TC1R
	Progress Lighting®	P830-TG, P832-TG

Juno®, Lithonia Lighting®, Thomas® Lighting, Progress® Lighting, Utilitech, and Commercial Electric™ and their product brand names, where identified above, are tradenames or trademarks of each respective company and Cooper Lighting makes no representations on these trademarks.



PHOTOMETRY

**RA406927WH**

Reflector Beam Angle = VWFL Beam  
(Very Wide Flood)

CCT = 2700K  
Spacing Criteria = 1.18  
Lumens per Watt = 60 Lm/W  
Test No. P121906  
Test Model: RA406927WH

Cone of Light Footcandles 0 deg Aiming Angle Horizontal Illuminance on Floor			
Distance to Illuminated Plane	Initial Nadir Footcandles	Beam (ft.)	
		L Length	W Width
5.5'	9.7	6.4	6.4
7'	6	8.2	8.2
8'	4.6	9.4	9.4
9'	3.6	10.6	10.6
10'	2.9	11.8	11.8

Cone of Light Footcandles 35 deg Aiming Angle Vertical Illuminance on Wall				
Distance to Illuminated Plane	Initial Nadir Footcandles	Beam (ft.)		CB
		L Length	W Width	
2'	43.5	2.1	2.4	2.9
3'	19.3	3.2	3.6	4.3
4'	10.9	4.2	4.8	5.7
5'	7	5.3	6	7.1
6'	4.8	6.4	7.4	8.6
8'	2.7	8.6	9.8	11.4
10'	1.7	10.8	12.2	14.3

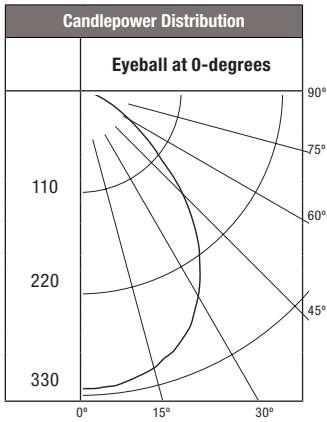

Candela Distribution	
Degrees Vertical	Candela
0*	293
5	293
15	283
25	257
35	206
45	144
55	79
65	40
75	18
85	6
90	0

Luminance (Average Candela/M <sup>2</sup> )	
Degree	Avg. 0° Luminance
45	43944
55	29652
65	20532
75	15132
85	14648

Zonal Lumen Summary		
Zone	Lumens	% Fixture
0-30	225	37.4
0-40	354	58.9
0-60	534	89.0
0-90	600	100

\*CBCP

**RA406930WH**

Reflector Beam Angle = VWFL Beam  
(Very Wide Flood)

CCT = 3000K  
Spacing Criteria = 1.18  
Lumens per Watt = 61.5 Lm/W  
Test No. P121908  
Test Model: RA406930WH

Cone of Light Footcandles 0 deg Aiming Angle Horizontal Illuminance on Floor			
Distance to Illuminated Plane	Initial Nadir Footcandles	Beam (ft.)	
		L Length	W Width
5.5'	9.9	6.4	6.4
7'	6.1	8.2	8.2
8'	4.7	9.4	9.4
9'	3.7	10.6	10.6
10'	3	11.8	11.8

Cone of Light Footcandles 35 deg Aiming Angle Vertical Illuminance on Wall				
Distance to Illuminated Plane	Initial Nadir Footcandles	Beam (ft.)		CB
		L Length	W Width	
2'	44.6	2.1	2.4	2.9
3'	19.8	3.2	3.6	4.3
4'	11.1	4.2	4.8	5.7
5'	7.1	5.3	6	7.1
6'	5	6.4	7.4	8.6
8'	2.8	8.6	9.8	11.4
10'	1.8	10.8	12.2	14.3

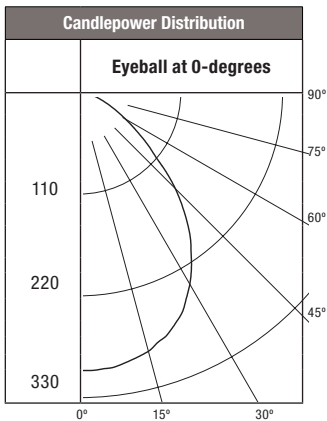

Candela Distribution	
Degrees Vertical	Candela
0*	301
5	300
15	290
25	263
35	211
45	147
55	81
65	41
75	19
85	6
90	0

Luminance (Average Candela/M <sup>2</sup> )	
Degree	Avg. 0° Luminance
45	45015
55	30407
65	21044
75	15551
85	14896

Zonal Lumen Summary		
Zone	Lumens	% Fixture
0-30	230	37.4
0-40	362	58.9
0-60	548	89.0
0-90	615	100

\*CBCP

PHOTOMETRY

**RA406927NFLWH**

Reflector Beam Angle = NFL Beam  
(Narrow Flood)

CCT = 2700K  
Spacing Criteria = 0.35  
Lumens per Watt = 64 Lm/W  
Test No. P121904  
Test Model: RA406927NFLWH

Cone of Light Footcandles 0 deg Aiming Angle Horizontal Illuminance on Floor			
Distance to Illuminated Plane	Initial Nadir Footcandles	Beam (ft.)	
		L Length	W Width
5.5'	98.7	1.8	1.8
7'	60.9	2.4	2.4
8'	46.6	2.8	2.8
9'	36.9	3	3
10'	29.9	3.4	3.4

Cone of Light Footcandles 35 deg Aiming Angle Vertical Illuminance on Wall				
Distance to Illuminated Plane	Initial Nadir Footcandles	Beam (ft.)		
		L Length	W Width	CB
2'	168	1.7	1	2.9
3'	74.7	2.6	1.6	4.3
4'	42	3.5	2.2	5.7
5'	26.9	4.4	2.8	7.1
6'	18.7	5.3	3.4	8.6
8'	10.5	7.1	4.4	11.4
10'	6.7	8.9	5.6	14.3

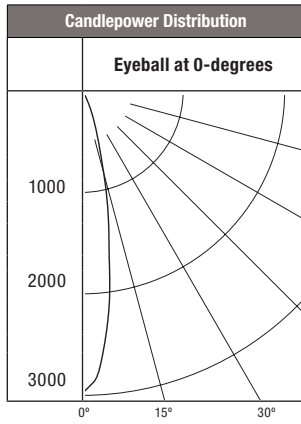

Candela Distribution	
Degrees Vertical	Candela
0*	2985
5	2531
15	836
25	223
35	62
45	27
55	14
65	6
75	2
85	0
90	0

Luminance (Average Candela/M²)	
Degree	Avg. 0° Luminance
45	6559
55	3723
65	1726
75	577
85	168

Zonal Lumen Summary		
Zone	Lumens	% Fixture
0-30	556	86.9
0-40	598	93.4
0-60	631	98.7
0-90	640	100

\*CBCP

**RA406930NFLWH**

Reflector Beam Angle = NFL Beam  
(Narrow Flood)

CCT = 3000K  
Spacing Criteria = 0.35  
Lumens per Watt = 64 Lm/W  
Test No. P121905  
Test Model: RA406930NFLWH

Cone of Light Footcandles 0 deg Aiming Angle Horizontal Illuminance on Floor			
Distance to Illuminated Plane	Initial Nadir Footcandles	Beam (ft.)	
		L Length	W Width
5.5'	98.7	1.8	1.8
7'	60.9	2.4	2.4
8'	46.6	2.8	2.8
9'	36.9	3	3
10'	29.9	3.4	3.4

Cone of Light Footcandles 35 deg Aiming Angle Vertical Illuminance on Wall				
Distance to Illuminated Plane	Initial Nadir Footcandles	Beam (ft.)		
		L Length	W Width	CB
2'	168	1.7	1	2.9
3'	74.7	2.6	1.6	4.3
4'	42	3.5	2.2	5.7
5'	26.9	4.4	2.8	7.1
6'	18.7	5.3	3.4	8.6
8'	10.5	7.1	4.4	11.4
10'	6.7	8.9	5.6	14.3

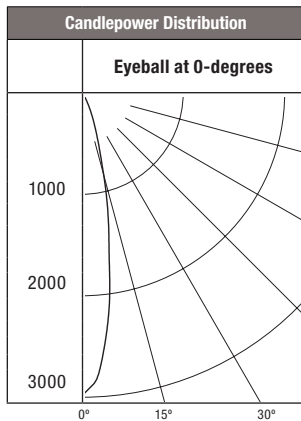

Candela Distribution	
Degrees Vertical	Candela
0*	2985
5	2531
15	836
25	223
35	62
45	27
55	14
65	6
75	2
85	0
90	0

Luminance (Average Candela/M²)	
Degree	Avg. 0° Luminance
45	6559
55	3723
65	1726
75	577
85	168

Zonal Lumen Summary		
Zone	Lumens	% Fixture
0-30	556	86.9
0-40	598	93.4
0-60	631	98.7
0-90	640	100

\*CBCP