

Circuit Breakers



Fuse Blocks and Fuse Holders



Rotary Disconnect Switches



1.1 Circuit Breakers

Product Overview	V9-T1-2
Series G Molded Case Circuit Breakers	V9-T1-5
Series G Motor Circuit Protectors	V9-T1-8
Series G Motor Protector Breakers	V9-T1-10
Universal Molded Case Circuit Breakers	V9-T1-13
QUICKLAG Type QC Miniature Circuit Breakers— Cable-In/Cable-Out Type QC	V9-T1-19
FAZ-NA UL 489 Circuit Breakers	V9-T1-25
FAZ UL 1077 Circuit Breakers	V9-T1-28
Series NRX Low Voltage Power Breakers	V9-T1-33
Magnum Low Voltage Power Breakers	V9-T1-36

1.2 Fuse Blocks and Fuse Holders

Product Overview	V9-T1-44
C350 Series	V9-T1-45

1.3 Rotary Disconnect Switches

Open Rotary Disconnects	V9-T1-46
Enclosed Rotary Disconnects	V9-T1-62

For our complete product offering, see Volume 4—Circuit Protection, CA08100005E and Volume 5—Motor Control and Protection, CA08100006E.

Product Overview

Circuit Breaker Selection Guide



Description	Series G Molded Case Circuit Breaker		Universal Molded Case Circuit Breakers		QUICKLAG® Type QC Miniature Circuit Breakers
	Page V9-T1-5		Page V9-T1-13		Page V9-T1-19
General Applications	Line protection—molded case switch, motor circuit protection (combination tested with Eaton starters and contactors) thermal-magnetic and electronic trip units.		Line protection—feeder and branch thermal-magnetic trip unit.		Used to provide branch circuit protection in cable-in/out panel or DIN rail mount applications.
Technical Data					
Maximum current rating	2500A		600A		100A
Maximum voltage—AC	690 Vac		480 Vac		240 Vac
Maximum voltage—DC	250 Vdc		250 Vdc		80 Vdc
Poles	1, 2, 3, 4		1, 2, 3		QC = 1, 2, 3, 4 QCD = 1, 2, 3 QCR/QCF = 1, 2, 3
Max. interrupting capacities See individual catalogs for limitations and back-up protection requirements.	Three-pole at 240V E = 200 kA J = 200 kA L = 200 kA	Three-pole at 480V E = 100 kA J = 200 kA L = 200 kA	Three-pole at 240V G = 25 kA (480/277) F = 25 kA J = 35 kA K = 35 kA L = 35 kA	Three-pole at 480V GI = 14 kA (480/277) GD = 22 kA F = 14 kA J = 20 kA K = 20 kA L = 20 kA	65 kA at 240 Vac 5 kA at 80 Vdc
Approvals	UL® 489 IEC 60947-2 CE	CSA® KEMA-KEUR CCC	UL 489CE IEC 60947-2	CE CSA	UL 489 CSA 22.2
Environmental Data					
Humidity	Non-condensing 100% relative humidity		Non-condensing 100% relative humidity		—
Shock	—		—		—
Vibration	—		—		—
Operating temperature	-20° to 70°C (-4° to 158°F) derating applies		-20° to 70°C (-4° to 158°F) derating applies		40°C (104°F)
Dielectric strength	Below 250A 6 kV Above 250A 8 kV		Below 250A 6 kV Above 250A 8 kV		1960 Vac (acc. to UL 489)
Insulation resistance	750 Vac		750 Vac		—
Endurance/life	250A: EG, JG = 8,000 operations 630A: LG = 6,000 operations		250A: Gi = 10,000 operations Fi = 8,000 operations 400A: Ji, Ki, Li = 6,000 operations		>10,000 operations
Approximate weight	E Three-pole—2.88 lbs (1.04 kg) J Three-pole—5.06 lbs (2.30 kg) L Three-pole—12.36 lbs (5.61 kg)		G Three-pole—2.10 lbs (0.95 kg) F Three-pole—4.5 lbs (2.0 kg) J Three-pole—12.50 lbs (5.7 kg) K Three-pole—11.50 lbs (5.2 kg)		QC Single-pole—0.36 lbs (162.8 g) Two-pole—0.61 lbs (274.9 g) Three-pole—1.14 lbs (518.3 g) QCD Single-pole—0.43 lbs (195.3 g) Two-pole—0.89 lbs (401.9 g) Three-pole—1.34 lbs (605.6 g) QCR Single-pole—0.22 lbs (97.9 g) Two-pole—0.48 lbs (215.8 g) Three-pole—0.70 lbs (315.6 g) QCF Single-pole—0.24 lbs (109.9 g) Two-pole—0.50 lbs (225.2 g) Three-pole—0.74 lbs (335.1 g)
Mounting configuration	Backpan, plug-in adapter, DIN rail (E)		Backpan, DIN rail (G)		Panel mount, front mount, 35 mm DIN rail mountable

For our complete product offering, see Volume 4—Circuit Protection, CA08100005E.

Circuit Breaker Selection Guide, continued



Description	FAZ-NA UL 489 Miniature Circuit Breakers Page V9-T1-25	FAZ UL 1077 Miniature Circuit Breakers— Supplementary Protectors Page V9-T1-28
General Applications	Used to provide branch circuit protection in cable-in/out DIN rail mount applications.	Used to provide overcurrent protection where branch protection (for example UL 489 MCCB) is already provided or not required. Replacement for fuses used as supplementary protectors.
Technical Data		
Maximum current rating	40A	63A
Maximum voltage—AC	480/277 Vac (240/415 Vac IEC)	480/277 Vac
Maximum voltage—DC	48 Vdc	65 Vac Single-pole 130 Vac Two-pole
Poles	1, 2, 3	1, 2, 3
Max. interrupting capacities See individual catalogs for limitations and back-up protection requirements.	10 kA UL/CSA; 15 kA IEC/EN 60947-2	IEC 240/415V 10 kA UL/CSA 120V 10 kA 240V 10 kA 277V 6 kA 480V 6 kA
Approvals	UL 489 CE; IEC/EN 60947-2 CSA 22.2	UL 1077 CE; IEC/EN 60947-2; IEC/EN 60898 CSA 22.2 235
Environmental Data		
Humidity	Acc. IEC 60068-2 (25° to 55°C/ 77° to 131°F, 90–95% RH)	—
Shock	Acc. IEC 60068-2-27 (40g half sine wave for 10 ms—3 axes) (15g half sine wave for 20 ms—3 axes)	—
Vibration	Acc. to IEC 60068-2-6 5–100 Hz/1.0 mm/0.7g (3 axes)	—
Operating temperature	30°C (86°F)	—
Dielectric strength	1960 Vac (acc. to UL 489)	—
Insulation resistance	100M ohms at 500 Vdc	—
Endurance/life	>20,000 operations	—
Approximate weight	Single-pole—0.27 lbs (121.0g) Two-pole—0.53 lbs (242.0g) Three-pole—0.80 lbs (363.0g)	Single-pole—0.26 lbs (120.0g) Two-pole—0.54 lbs (244.9g) Three-pole—0.83 lbs (376.5g)
Mounting contribution	35 mm DIN rail mountable	35 mm DIN rail mountable

For our complete product offering, see Volume 4—Circuit Protection, CA08100005E.

Circuit Breaker Selection Guide, continued



**Series NRX
Low Voltage Power Breakers**

Page V9-T1-33



**Magnum
Low Voltage Power Breakers**

Page V9-T1-36

Description

General Applications

Solution for where space is at a premium or when equipment dimensions are critical when upgrading or retrofitting current systems. Offering the power and performance of a power breaker in the compact size of a molded case breaker. With its reduced weight and compact dimensions, you can mount two times as many feeder breakers and reduce the overall enclosure density up to 50%.

Enables comprehensive solutions to meet and exceed the unique and wide-ranging requirements of today's global power distribution systems. Designed and engineered for ultimate custom configuration and application flexibility in metal enclosed switchgear and power distribution enclosures.

Technical Data

Maximum current rating	630–1600A	800–6300A
Maximum voltage—AC	220–690 Vac	Up to 690 Vac
Maximum voltage—DC	—	—
Poles	3, 4	3, 4
Max. interrupting capacities See individual catalogs for limitations and back-up protection requirements.	65 kAIC at 480 Vac Max. withstand capacities 42 kAIC	200 kA at 480 Vac Max. withstand capacities 100 kAIC CL fuseless 200 kA at 635 Vac with integral limiters

Approvals

UL 1006 Component UL 489 Component IEC 60947-2	UL 1066 IEC 60947-2 KEMA
------------------------------------------------------	--------------------------------

Environmental Data

Humidity	—	—
Shock	—	—
Vibration	—	—
Operating temperature	–25° to 70°C	–25° to 70°C
Dielectric strength	—	—
Insulation resistance	—	—
Endurance/life	10,000 electrical operations 20,000 mechanical operations	—
Approximate weight	Three-pole breaker + cassette—85 lbs (39 kg) Three-pole breaker—53 lbs (24 kg) Four-pole breaker + cassette—104 lbs (47 kg) Four-pole breaker—67 lbs (30 kg)	—
Mounting configuration	Rear-connected, front-connected, surface mounting, mounting bracket, fixed, drawout breaker with cassette	Fixed or drawout with cassette rear-connected, front-connected

For our complete product offering, see Volume 4—Circuit Protection, CA08100005E.

Series G Molded Case Circuit Breakers



Features

- Field-fit accessories
- Common accessories through 630A
- Space-saving footprint
- High-performance current limiting designs up to 200 kAIC at 480V
- Global ready: UL, CSA, CE, IEC, KEMA-KEUR listings
- Complete breaker includes frame, trip unit, standard terminals and mounting hardware

Catalog Number Selection

Series G® Molded Case Circuit Breakers

EG Frame

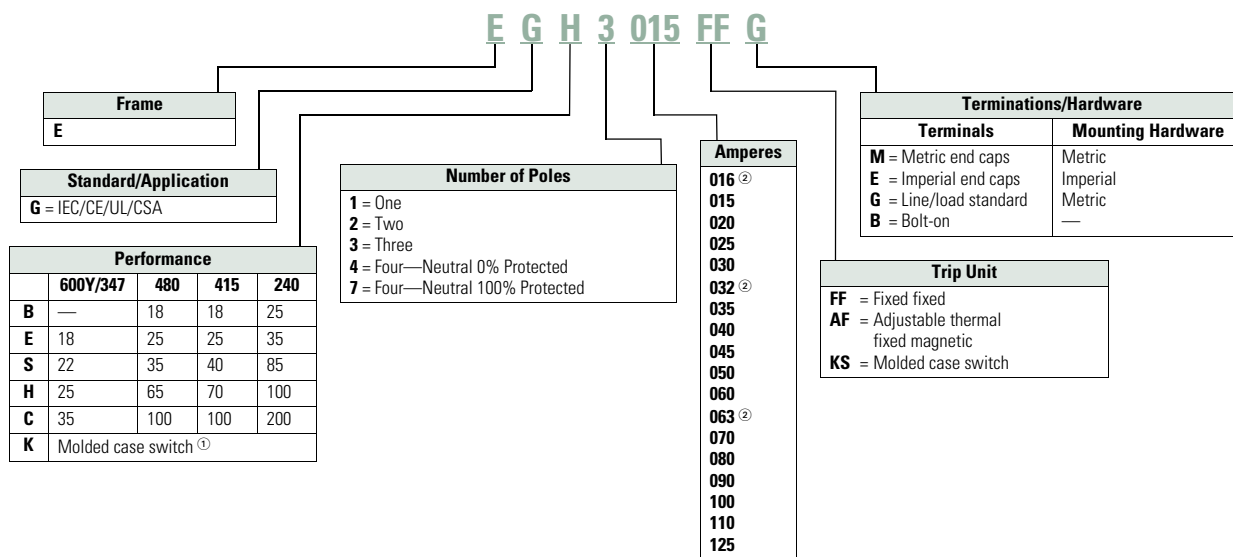

Notes

- ① Available only as 125 and 160A sizes.
- ② Is not UL rated.

1.1

Circuit Protection

Circuit Breakers

1

JG Frame

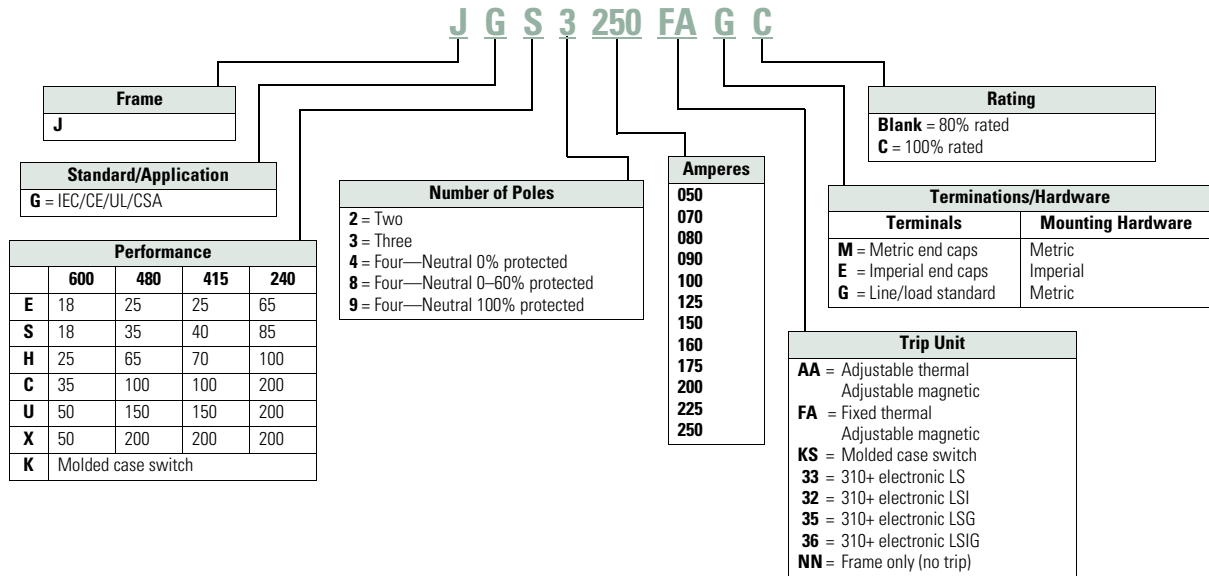

LG Frame

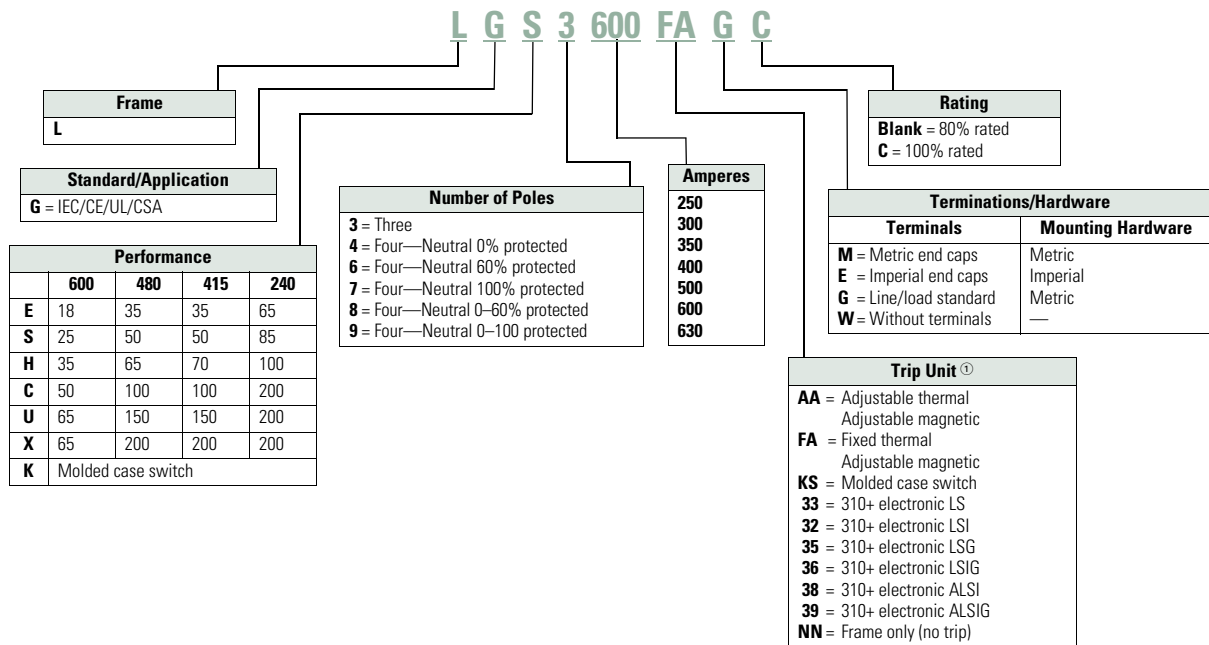

Note

① A = Arc reduction, L = Long, S = Short, I = Instantaneous, G = Ground.

Product Selection

Series G Molded Case Circuit Breakers

Approximate Dimensions are in Inches

EG Frame

Maximum Continuous Amperes at 40°C ① Three-Pole 3.00 W x 5.50 H x 2.99 D
Fixed Thermal
Fixed Magnetic

IC Rating: 25 kAIC at 415 and 480 Vac

15	EGE3015FFG
20	EGE3020FFG
25	EGE3025FFG
30	EGE3030FFG
35	EGE3035FFG
40	EGE3040FFG
45	EGE3045FFG
50	EGE3050FFG
60	EGE3060FFG
70	EGE3070FFG
80	EGE3080FFG
90	EGE3090FFG
100	EGE3100FFG
125	EGE3125FFG

Maximum Continuous Amperes at 40°C Three-Pole 3.00 W x 5.50 H x 2.99 D
Fixed Thermal
Fixed Magnetic

IC Rating: 70 kAIC at 415 Vac, 65 kAIC at 480 Vac

15	EGH3015FFG
20	EGH3020FFG
25	EGH3025FFG
30	EGH3030FFG
35	EGH3035FFG
40	EGH3040FFG
45	EGH3045FFG
50	EGH3050FFG
60	EGH3060FFG
70	EGH3070FFG
80	EGH3080FFG
90	EGH3090FFG
100	EGH3100FFG
125	EGH3125FFG

JG Frame

Maximum Continuous Amperes Three-Pole 4.13 W x 7.00 H x 3.57 D
Magnetic Range Fixed Thermal
Adjustable Magnetic

IC Rating: 25 kAIC at 415 and 480 Vac

70	350–700	JGE3070FAG
90	450–900	JGE3090FAG
100	500–1000	JGE3100FAG
125	625–1250	JGE3125FAG
150	750–1550	JGE3150FAG
175	875–1750	JGE3175FAG
200	1000–2000	JGE3200FAG
225	1125–2250	JGE3225FAG
250	1250–2500	JGE3250FAG

Maximum Continuous Amperes Three-Pole 4.13 W x 7.00 H x 3.57 D
Magnetic Range Fixed Thermal
Adjustable Magnetic

IC Rating: 70 kAIC at 415 Vac, 65 kAIC at 480 Vac

70	350–700	JGH3070FAG
90	450–900	JGH3090FAG
100	500–1000	JGH3100FAG
125	625–1250	JGH3125FAG
150	750–1550	JGH3150FAG
175	875–1750	JGH3175FAG
200	1000–2000	JGH3200FAG
225	1125–2250	JGH3225FAG
250	1250–2500	JGH3250FAG

LG Frame

Ampere Rating Three-Pole 5.48 W x 10.13 H x 4.09 D
Fixed Thermal
Adjustable Magnetic

IC Rating: 35 kAIC at 415 and 480 Vac

250	LGE3250FAG
300	LGE3300FAG
350	LGE3350FAG
400	LGE3400FAG
500	LGE3500FAG
600	LGE3600FAG

Ampere Rating Three-Pole 3.00 W x 5.50 H x 2.99 D
Fixed Thermal
Adjustable Magnetic

IC Rating: 70 kAIC at 415 Vac, 65 kAIC at 480 Vac

250	LGH3250FAG
300	LGH3300FAG
350	LGH3350FAG
400	LGH3400FAG
500	LGH3500FAG
600	LGH3600FAG

Note

① 16, 32, 63A are not UL listed ratings.

Series G Motor Circuit Protector



Features

- Instantaneous only protector
- Designed for use in combination with motor starters
- Adjustable to motor FLA
- UL recognized component, File E7819 motor circuit protectors

Product Selection

Series G Motor Circuit Protectors

EG Frame—480 Vac, 600Y/347 Vac Maximum

Continuous Amperes	Cam Setting	Motor Full Load Current Amperes ^①	MCP Trip Setting ^②	MCP Catalog Number
3	A	0.69–0.91	9	HMCPE003A0C
	B	1.1–1.3	15	
	C	1.6–1.7	21	
	D	2.0–2.2	27	
	E	2.3–2.5	30	
	F	2.6–2.8	33	
7	A	1.5–2.0	21	HMCPE007C0C
	B	2.6–3.1	35	
	C	3.7–3.9	49	
	D	4.8–5.2	63	
	E	5.3–5.7	70	
	F	5.8–6.1	77	
15	A	3.4–4.5	45	HMCPE015E0C
	B	5.7–6.8	75	
	C	8.0–9.1	105	
	D	10.4–11.4	135	
	E	11.5–12.6	150	
	F	12.7–13.0	165	
30	A	3.9–9.1	90	HMCPE030H1C
	B	11.5–13.7	150	
	C	16.1–18.3	210	
	D	20.7–22.9	270	
	E	23.0–25.2	300	
	F	25.3–26.1	330	

Continuous Amperes	Cam Setting	Motor Full Load Current Amperes ^①	MCP Trip Setting ^②	MCP Catalog Number
50	A	11.5–15.2	150	HMCPE050K2C
	B	19.2–22.9	250	
	C	26.9–30.6	350	
	D	34.6–38.3	450	
	E	38.4–42.1	500	
	F	42.2–43.5	550	
70	A	16.1–30.6	210	HMCPE070M2C
	B	26.9–32.2	350	
	C	37.6–42.9	490	
	D	48.4–53.7	630	
	E	53.8–59.1	700	
	F	59.2–60.9	770	
100	A	23.0–30.6	300	HMCPE100R3C
	B	38.4–46.0	500	
	C	53.8–61.4	700	
	D	69.2–76.8	900	
	E	76.9–84.5	1000	
	F	84.6–87.0	1100	
100	A	38.4–46.0	500	HMCPE100T3C
	B	57.6–65.2	750	
	C	76.9–84.5	1000	
	D	③	1250	
	E	③	1375	
	F	③	1500	

Notes

- ① Motor FLA ranges are typical. The corresponding trip setting is at 13 times the minimum FLA value shown. Where a 13 times setting is required for an intermediate FLA value, alternate cam settings and/or MCP ratings should be used.
- ② For DC applications, actual trip levels are approximately 40% higher than values shown.
- ③ Settings above 10 x I_n are for special applications, where the ampere rating of the disconnecting means cannot be less than 115% of the motor full load ampere rating.

JG Frame—600 Vac Maximum, 250 Vdc Maximum

Continuous Amperes	MCP Trip Range Amperes	MCP Catalog Number
250	500–1000	HMCPJ250D5L
	625–1250	HMCPJ250F5L
	750–1500	HMCPJ250G5L
	875–1750	HMCPJ250J5L
	1000–2000	HMCPJ250K5L
	1125–2250	HMCPJ250L5L
	1250–2500	HMCPJ250W5L

LG Frame—600 Vac Maximum, 250 Vdc Maximum

Continuous Amperes	MCP Trip Range Amperes	MCP Catalog Number
600	1250–2500	HMCP600L6G
	1500–3000	HMCP600N6G
	1750–3500	HMCP600R6G
	2000–4000	HMCP600X6G
	2250–4500	HMCP600Y6G
	2500–5000	HMCP600P6G
	3000–6000	HMCP600M6G

Series G Motor Protector Breakers**Features**

- Eliminates need for separate overload relay
- Can be used with contactor to eliminate need for overload relay and still create manual motor control
- Meets requirement for motor branch protection, including:
 - Disconnecting means
 - Branch circuit short-circuit protection
 - Overload protection
- UL 489 listed, IEC 60947-02 rated
- Phase unbalance, phase loss protection and high load alarm
- Optional pre-detection trip relay

Product Selection**Series G Motor Protector Breakers**

For pre-trip alarm option, order Style Number 5721B31G02.

**JG Frame Motor Protector Circuit Breakers,
250A Maximum Rated Current**

Continuous Amperes	35 kAIC Catalog Number	65 kAIC Catalog Number
50	JGMPS050G	JGMPH050G
100	JGMPS100G	JGMPH100G
160	JGMPS160G	JGMPH160G
250	JGMPS250G	JGMPH250G

**LG Frame Motor Protector Circuit Breakers,
630A Maximum Rated Current**

Continuous Amperes	50 kAIC Catalog Number	65 kAIC Catalog Number
250	LGMP250G	LGMPH250G
400	LGMP400G	LGMPH400G
600	LGMP600G	LGMPH600G
630 ^①	LGMP630G	LGMPH630G

Note

^① 630A is not a UL listed rating. 600A is the maximum UL or CSA rating for LG breaker.

Accessories

Field Fit Kit Catalog Numbers

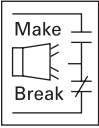
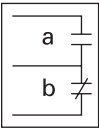
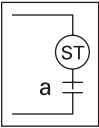
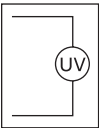
	Description	Pole Location	Frame— EG, JG and LG
Alarm Lockout	Alarm Lockout		
	Make/break	Right	ALM1M1BEPK ①
	2 make/2 break	Right	ALM2M2BEPK ②
Auxiliary Switch	Auxiliary Switch		
	1A, 1B	Right	AUX1A1BPK
	2A, 2B	Right	AUX2A2BPK
	Auxiliary Switch/Alarm Lockout		
	—	Right	AUXALRMEPK ③
Shunt Trip	Shunt Trip—Standard		
	120 Vac	Left	SNT120CPK ④
	240 Vac	Left	SNT120CPK ④
	12 Vdc	Left	SNT012CPK
	24 Vdc	Left	SNT060CPK
	48 Vdc	Left	SNT060CPK
	380–600 Vac	Left	SNT480CPK ⑤
Undervoltage Release Mechanism	Undervoltage Release Mechanism		
	110–127 Vac	Left	UVR120APK
	208–240 Vac	Left	UVR240APK
	24 Vac	Left	UVR024APK
	24 Vdc	Left	UVR024DPK
	48–60 Vdc	Left	UVR048DPK
	12 Vac/Vdc	Left	UVR012CPK
	48–60 Vac	Left	UVR048APK
	120 Vdc	Left	UVR125DPK
	220–250 Vdc	Left	UVR250DPK
	380–500 Vac	Left	UVR480APK
	525–600 Vac	Left	UVR600APK

Multiwire Connectors Ordering Information (Package of 3)

High SCCR ratings are available for Power Distribution blocks with Series G MCCBs. See **Tab 6**.

Maximum Amperes	Wires per Terminal	Wire Size Range AWG Cu	Frame	Kit Catalog Number
125	3	14–2	EG	3TA125E3K
125	6	14–6	EG	3TA125E6K
250	3	14–2	JG	3TA250FJ3
250	6	14–6	JG	3TA250FJ6

Terminal Shields

Location	Number of Poles	Frame	IP30 Protection Catalog Number
Line	3	EG	EFTS3K
Line	4	EG	EFTS4K
Line or load	2, 3	JG	FJTS3K
Line or load	4	JG	FJTS4K

Interphase Barriers (Package of 2)

Number of Poles	Frame	Catalog Number
3 or 4	EG	EIPBK
3	JG	FJIPBK
4	JG	FJIPBK4
3 or 4	LG	IPB3

Flex Shaft Handles

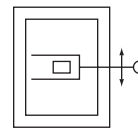

Flex Shaft Handle Mechanisms

Breaker Frame	Flexible Shaft Length in ft (m)	
	4 (1.2)	7 (2.1)
	Catalog Number	Catalog Number
EG	EHMFS04	EHMFS07
JG	JHMFS04	JHMFS07
LG	LHMFS04	LHMFS07

Universal Direct Handle Mechanism



Universal Direct Handle Mechanisms

Frame	With Interlock Catalog Number	Without Interlock Catalog Number
Black Handle Color		
EG	EHMCCBI	EHMCCB
JG	JHMCCBI	JHMCCB
LG	LHMCCBI	LHMCCB
Red Handle Color		
EG	EHMCCRI	EHMCCR
JG	JHMCCRI	JHMCCR
LG	LHMCCRI	LHMCCR

Notes

- ① Part number for JG and LG is ALM1M1BJPK.
- ② Part number for JG and LG is ALM2M2BJPK.
- ③ Part number for JG and LG is AUXALRMJPK.
- ④ 110–125 Vdc, 50/60 Hz.
- ⑤ 380–600 Vdc, 50/60 Hz.

1

Rotary Handle Mechanisms



High Performance Rotary Handle Mechanisms (Complete Kit Includes Handle, Shaft and Mechanism)

Color	Rating Type UL	IP	EG Frame ① Catalog Number	JG Frame Catalog Number	LG Frame Catalog Number
Black/blue	1/12/3R	20/54/55	EGHMVD06B	JGHMVD06B	LGHMVD06B
			EGHMVD12B	JGHMVD12B	LGHMVD12B
			EGHMVD24B	JGHMVD24B	LGHMVD24B
Red/yellow	1/12/3R	20/54/55	EGHMVD06R	JGHMVD06R	LGHMVD06R
			EGHMVD12R	JGHMVD12R	LGHMVD12R
			EGHMVD24R	JGHMVD24R	LGHMVD24R
Black/blue	4/4X	66	EGHMVD06BX	JGHMVD06BX	LGHMVD06BX
			EGHMVD12BX	JGHMVD12BX	LGHMVD12BX
			EGHMVD24BX	JGHMVD24BX	LGHMVD24BX
Red/yellow	4/4X	66	EGHMVD06RX	JGHMVD06RX	LGHMVD06RX
			EGHMVD12RX	JGHMVD12RX	LGHMVD12RX
			EGHMVD24RX	JGHMVD24RX	LGHMVD24RX

External Accessories

Description	Fit Type	Frame EG	JG	LG
Non-padlockable handle block	Field	EFHB	—	—
Padlockable handle block	Field	EFPHB	—	—
Padlockable handle block off-only	Field	EFPHBOFF	FJPHBOFF	LBHPOFF
Padlockable handle lock hasp	Field	EFPHL	FJPHL	LPHL
Padlockable handle lock hasp off-only	Field	EFPHLOFF	FJPHLOFF	LPHLOFF
Kirk key interlock kit ②③	Field	—	KYKJG	KYKLG
Castell key interlock kit ③④	Field	—	CTKJG	CTKLG
Slide bar interlock ⑤	Field	EFSBI	FJSBI	LGSBI
Walking beam interlock	Three-pole	EG3WBI	JG3WBI	LG3WBI
	Four-pole	EG4WBI	JG4WBI	LG4WBI
Electrical operator	120/240 Vac	MOPEG240C	MOPJG240C	MOPLG240C
	125 Vdc	MOPEG240C	MOPJG240C	MOPLG240C
Plug-in adapters	Three-pole	PAD3E	PAD3J	PAD3L
	Four-pole	PAD4E	PAD4J	PAD4L
Rear connecting studs	Field	EFRCSDL	FJRCSDL	3P-LRCS3WK
		EFRCSDS	FJRCSDS	4P-LRCS4WK
		EFRCSWL	FJRCSWL	—
		EFRCSWS	FJRCSWS	—

Notes

- ① Compatible with three-pole and four-pole EG breakers only.
- ② Provision only.
- ③ See Volume 4—Circuit Protection, CA08100005E, Tab 2, for bolt projection dimensions.
- ④ Castell bolt mounting hole must be 10 mm.
- ⑤ Requires two breakers.

Universal Molded Case Circuit Breakers



Features

- Universal design for both NEMA® (UL 489) and IEC (IEC 947-2) standards
- Suitable for 50°C application
- Factory-sealed thermal magnetic trip unit
- Standard interrupting ratings
- Includes mounting hardware and terminals

Catalog Number Selection

Universal Molded Case Circuit Breakers

Universal Molded Case

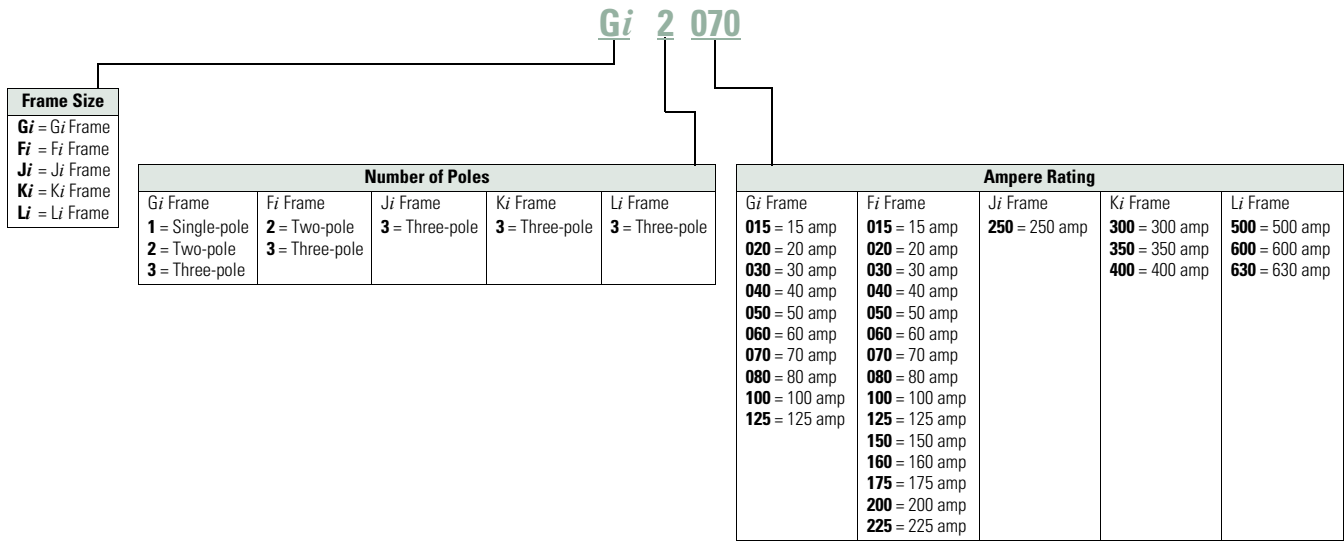

Product Selection

Universal Molded Case Circuit Breakers

Three-Pole

Approximate Dimensions are in Inches

Universal G Frame

Description	Amperes	Catalog Number ^①	
3 W x 4-7/8 H x 2-13/16 D (optional DIN rail kit available catalog number GDIN, package of ten)	15	Gi3015	
	20	Gi3020	
	25	Gi3025	
	30	Gi3030	
Voltage	Interrupting Rating		
380–415	18/5K	35	Gi3035
480/277	14K	40	Gi3040
		45	Gi3045
		50	Gi3050
		60	Gi3060

Universal F Frame

Description	Amperes	Catalog Number ^①	
4-1/8 W x 6 H x 3-3/8 D	15	Fi3015L	
	20	Fi3020L	
	30	Fi3030L	
	35	Fi3035L	
Voltage	Interrupting Rating		
415	18/9K	40	Fi3040L
480	20K	50	Fi3050L
		60	Fi3060L
		70	Fi3070L
		80	Fi3080L
		90	Fi3090L
		100	Fi3100L
		125	Fi3125L
		150	Fi3150L
		175	Fi3175L
		200	Fi3200L
		225	Fi3225L

Universal J Frame

Description	Amperes	Catalog Number ^①
4-1/8 W x 10 H x 4-1/16 D	225	Ji3225L
	250	Ji3250L
Voltage	Interrupting Rating	
415	25/13K	
480	20K	

Universal K Frame

Description	Amperes	Catalog Number ^①
5-1/2 W x 10-1/8 H x 4-1/16 D	300	Ki3300L
	350	Ki3350L
	400	Ki3400L
Voltage	Interrupting Rating	
415	25/13K	
480	20K	

Universal L Frame

Description	Amperes	Catalog Number ^①
8-1/4 W x 10-3/4 H x 4.37 D	500	Li3500
	600	Li3600
Voltage	Interrupting Rating	
415	25/13K	
480	20K	

Note

^① Metric mounting hardware.

Accessories

Internal Accessories

Auxiliary Switch (Right-Pole Mounted)

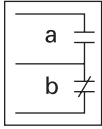

Bell Alarm (Right-Pole Mounted)

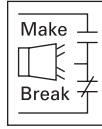

Shunt Trip (Left-Pole Mounted)

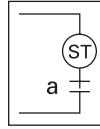

UVR (Left-Pole Mounted)

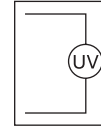

Configuration	Add This Suffix to Catalog Number	Configuration	Add This Suffix to Catalog Number	Voltage Range	Add This Suffix to Catalog Number	Voltage Range	Add This Suffix to Catalog Number
Universal G Frame							
1NO/1NC	A3	1 make/1 break	B3	24 Vac	S7	24 Vac 50/60 Hz	T2
2NO/2NC	A6			120 Vac	S1	48 Vac 50/60 Hz	T3
				240 Vac	S2	60 Vac 50/60 Hz	T4
				12 Vdc	S3	120 Vac 50/60 Hz	T1
				24 Vdc	S4	240 Vac 50/60 Hz	T8
						220 Vac 50 Hz	T7
						440 Vac 50 Hz	T11
						480 Vac 60 Hz	T12
Universal F Frame							
1NO/1NC	A06	1 make/1 break	B06	12–24 Vac/Vdc	S02	12 Vac	U02
2NO/2NC	A13			48–127 Vac or 48–60 Vdc	S06	24 Vac	U06
				208–380 Vac or 110–127 Vdc	S10	48 Vac/Vdc	U38
				415–600 Vac or 220–250 Vdc	S14	110–127 Vac	U14
						208–240 Vac	U18
						380–480 Vac	U22
						525–600 Vac	U26
						12 Vdc	U30
						24 Vdc	U34
						125 Vdc	U42
						220–250 Vdc	U46
Universal J Frame							
1NO/1NC	A06	1 make/1 break	B06	12–24 Vac/Vdc	S42	12 Vac	U06
2 NO/2NC	A13			48–60 Vac/Vdc	S50	24 Vac	U10
				110–240 Vac or 110–125 Vdc	S10	48–60 Vac	U14
				380–440 Vac or 220–50 Vdc	S14	110–127 Vac	U18
				480–600 Vac	S18	208–240 Vac	U22
						380–480 Vac	U26
						12 Vdc	T02
						24 Vdc	T06
						48–60 Vdc	T10
						110–125 Vdc	T14
						220–250 Vdc	T18

If both an auxiliary switch and bell alarm are required, add B13 to the catalog number (right-pole mounted). Auxiliary switch and bell alarm are 240V rated.

If both an auxiliary switch and bell alarm are required, add C05 to the catalog number (right-pole mounted). Auxiliary switch and bell alarm are 600V rated.

If both an auxiliary switch and bell alarm are required, add C05 to the catalog number (right-pole mounted). Auxiliary switch and bell alarm are 600V rated.

Internal Accessories, continued

Auxiliary Switch (Right-Pole Mounted)

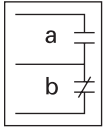

Bell Alarm (Right-Pole Mounted)

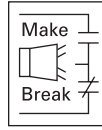

Shunt Trip (Left-Pole Mounted)

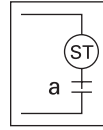

UVR (Left-Pole Mounted)

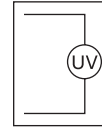

Configuration	Add This Suffix to Catalog Number	Configuration	Add This Suffix to Catalog Number	Voltage Range	Add This Suffix to Catalog Number	Voltage Range	Add This Suffix to Catalog Number	
Universal K Frame								
1NO/1NC	A06	1 make/1 break	B06	12–24 Vac/Vdc	S42	12 Vac	U06	
2NO/2NC	A13			48–60 Vac/Vdc	S50	24 Vac	U10	
If both an auxiliary switch and bell alarm are required, add C05 to the catalog number (right-pole mounted). Auxiliary switch and bell alarm are 600V rated.				110–240 Vac or 110–125 Vdc	S10	48–60 Vac	U14	
							110–127 Vac	U18
				380–440 Vac or 220–250 Vdc	S14	208–240 Vac	U22	
						380–480 Vac	U26	
				480–600 Vac	S18	12 Vdc	T02	
						24 Vdc	T06	
		48–60 Vdc	T10					
		110–125 Vdc	T14					
		220–250 Vdc	T18					
Universal L Frame								
1NO/1NC	A06	1 make/1 break	B06	12–24 Vac/Vdc	S02	12 Vac	U06	
2NO/2NC	A13			48–60 Vdc	S06	24 Vac	U10	
If both an auxiliary switch and bell alarm are required, add C05 to the catalog number (right-pole mounted). Auxiliary switch and bell alarm are 600V rated.				48–60 Vac	S86	48–60 Vac	U14	
				110–240 Vac	S10	110–127 Vac	U18	
				110–125 Vdc	S42	208–240 Vac	U22	
				380–440 Vac or 220–250 Vdc	S14	380–480 Vac	U26	
				480–600 Vac	S18	12 Vdc	T02	
						24 Vdc	T06	
		48–60 Vdc	T10					
		110–125 Vdc	T14					
		220–250 Vdc	T18					

Handle Mechanisms

Handle Mechanisms

Type 1/12 Universal Rotary

Ordering Information ^①



Shaft Length in Inches (mm)	Handle Color	Complete Catalog Number	Flange Flex Shaft Type 1, 3R, 12 Versions
Universal G Frame			
6 (152.4)	Black	GHMVD06B	3-ft length; order F0S03C
12 (304.8)	Black	GHMVD12B	4-ft length; order F0S04C
6 (152.4)	Red	GHMVD06R	5-ft length; order F0S05C
12 (304.8)	Red	GHMVD12R	6-ft length; order F0S06C
Universal F Frame			
6 (152.4)	Black	FHMVD06B	3-ft length; order F1S03C
12 (304.8)	Black	FHMVD12B	4-ft length; order F1S04C
6 (152.4)	Red	FHMVD06R	5-ft length; order F1S05C
12 (304.8)	Red	FHMVD12R	6-ft length; order F1S06C
			7-ft length; order F1S07C
			8-ft length; order F1S08C
			9-ft length; order F1S09C
			10-ft length; order F1S10C
Universal J Frame			
6 (152.4)	Black	JHMVD06B	3-ft length; order F2S03C
12 (304.8)	Black	JHMVD12B	4-ft length; order F2S04C
6 (152.4)	Red	JHMVD06R	5-ft length; order F2S05C
12 (304.8)	Red	JHMVD12R	6-ft length; order F2S06C
			7-ft length; order F2S07C
			8-ft length; order F2S08C
			9-ft length; order F2S09C
			10-ft length; order F2S10C
Universal K Frame			
6 (152.4)	Black	KHMVD06B	3-ft length; order F3S03C
12 (304.8)	Black	KHMVD12B	4-ft length; order F3S04C
6 (152.4)	Red	KHMVD06R	5-ft length; order F3S05C
12 (304.8)	Red	KHMVD12R	6-ft length; order F3S06C
			7-ft length; order F3S07C
			8-ft length; order F3S08C
			9-ft length; order F3S09C
			10-ft length; order F3S10C

Note

^① Only available as complete handle mechanism. Parts not sold separately.

Terminals and Termination Accessory Devices

Terminal/Termination Devices

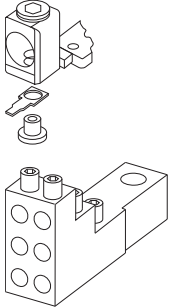

Universal G Frame

Terminals (Included with Breaker)		Optional Multiwire Lugs (Load End Only)	
15–20 A	25–100A	Three-Hole Version	Six-Hole Version
14–2 AWG Cu/Al	10–1/0 AWG Cu/Al	(3) 14–2 AWG Order 3TA100G3K	(6) 14–6 AWG Order 3TA100G6K
2.5–4 mm ² Cu/Al	4–50 mm ² Cu/Al		

Universal F Frame

Terminals (Included with Breaker)			Optional Multiwire Lugs (Load End Only)	
10–20A	25–100A	110–225A	Three-Hole Version	Six-Hole Version
14–10 AWG Cu/Al	14–1/0 AWG Cu/Al	4–4/0 AWG Cu/Al	(3) 14–2 AWG Order 3TA150F3K	(6) 14–6 AWG Order 3TA150F6K
2.5–4 mm ² Cu/Al	2.5–50 mm ² Cu/Al	25–95 mm ² Cu/Al		

Universal J Frame

Terminals (Included with Breaker)		Optional Multiwire Lugs (Load End Only)	
70–250A		Three-Hole Version	Six-Hole Version
4–350 kcmil AWG Cu/Al		(3) 14–2 AWG Order 3TA250J3K	(6) 14–6 AWG Order 3TA250J6K
25–150 mm ² Cu/Al			

Universal K Frame

Terminals (Included with Breaker)		Optional Multiwire Lugs (Load End Only)	
300–350A	400A	Three-Hole Version	Six-Hole Version
250–500 kcmil AWG Cu/Al	3/0–200 (2) AWG Cu/Al	(3) 12–2/0 AWG Order 3TA400K3K	(6) 14–2/0 AWG Order 3TA400K6K
120–240 mm ² Cu/Al	95–120 mm ² Cu/Al		

Universal L Frame

Terminals (Included with Breaker)		Optional Multiwire Lugs (Load End Only)	
500A	600A	Three-Hole Version	Six-Hole Version
(2) 250–300 kcmil Cu/Al	(2) 400–500 kcmil Cu/Al	—	—
120–150 mm ² Cu/Al	185–250 mm ² Cu/Al		

QUICKLAG Type QC Miniature Circuit Breakers—Cable-In/Cable-Out Type QC



Features

For Cable-In/Cable-Out Panel Mount Applications

- Single-, two-, three- and four-pole options
- Built and listed to UL 489
- All products UL and CSA listed
- All products 10–100A are HACR rated

Catalog Number Selection

QUICKLAG Type QC Miniature Circuit Breakers—Cable-In/Cable-Out Type QC

Type QC Miniature Circuit Breakers

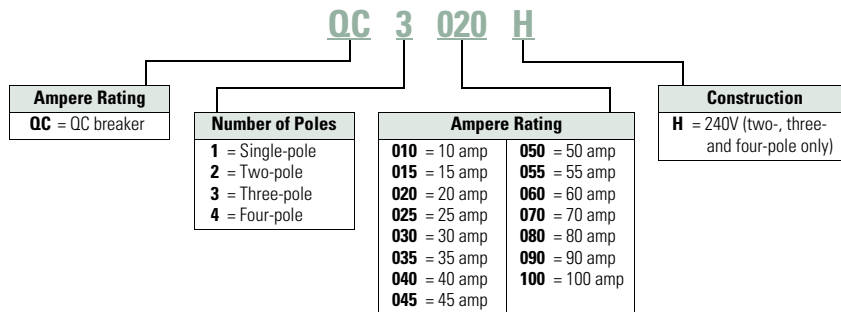

Product Selection

QUICKLAG Type QC 10,000 Ampere I.C. Thermal-Magnetic Breakers

Note: For non-automatic switches, see Volume 4—Circuit Protection, CA08100005E, Tab 1.

Continuous Ampere Rating at 40°C	Single-Pole, 120/240 Vac Catalog Number	Two-Pole, 120/240 Vac Catalog Number	Three-Pole, 240 Vac Catalog Number
10	QC1010	QC2010	—
15	QC1015 ①②	QC2015	QC3015H
20	QC1020 ①②	QC2020	QC3020H
30	QC1030	QC2030	QC3030H
40	QC1040	QC2040	QC3040H
50	QC1050	QC2050	QC3050H
60	—	QC2060	QC3060H
70	—	QC2070	QC3070H
100	QC1100	QC2100	QC3100H

Notes

- ① Switching duty rated for 120 Vac fluorescent light applications only.
- ② For special low-magnetic breaker, order QC1015L1 or QC1020L1.

1.1

Circuit Protection

Circuit Breakers

1

QUICKLAG Type QC Miniature Circuit Breakers—Cable-In/Cable-Out Type QCD



Features

For Cable-In/Cable-Out DIN rail Mount HVAC Applications

- Single-, two- and three-pole options
- Modular construction
- DIN mounted (symmetrical rail 35 in x 7.5 in DIN/EN 50 022)
- Flexible power feed connection: wire size, position
- Same breaker size for entire rating range
- Field-mountable accessories: finger-shroud proof, quick connect terminals, jumper units

Catalog Number Selection

QUICKLAG Type QC Miniature Circuit Breakers—Cable-In/Cable-Out Type QCD

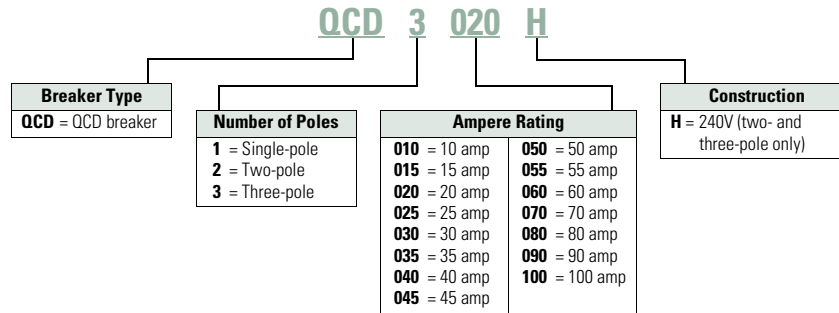

Product Selection

QUICKLAG Type QCD 10,000 Ampere I.C. Thermal-Magnetic Breakers

Continuous Ampere Rating at 40°C	Single-Pole, 120/240 Vac Catalog Number	Two-Pole, 120/240 Vac Catalog Number	Three-Pole, 240 Vac Catalog Number
10	QCD1010	QCD2010	—
15	QCD1015	QCD2015	QCD3015H
20	QCD1020	QCD2020	QCD3020H
30	QCD1030	QCD2030	QCD3030H
40	QCD1040	QCD2040	QCD3040H
50	QCD1050	QCD2050	QCD3050H
60	QCD1060	QCD2060	QCD3060H
70	—	QCD2070	QCD3070H
100	—	QCD2100	QCD3100H

QUICKLAG Type QC Miniature Circuit Breakers—Cable-In/Cable-Out 1/2-Inch Wide Types QCR, QCF



Features

When Space is at a Premium

- QCR: For DIN rail mount cable-in/cable-out applications
- QCF: For front-mount through-the-door cable-in/cable-out applications
- 1/2 in (12.7 mm) wide per pole
- Three-position handle: ON, tripped (center), OFF
- Thermal-magnetic protection
- Single-, two- and three-pole
- 10 kAIC at 120/240 Vac, 10–60A
- 10 kAIC at 240 Vac, 10–30A

Catalog Number Selection

QUICKLAG Type QC Miniature Circuit Breakers—Cable-In/Cable-Out 1/2-Inch Wide Types QCR, QCF

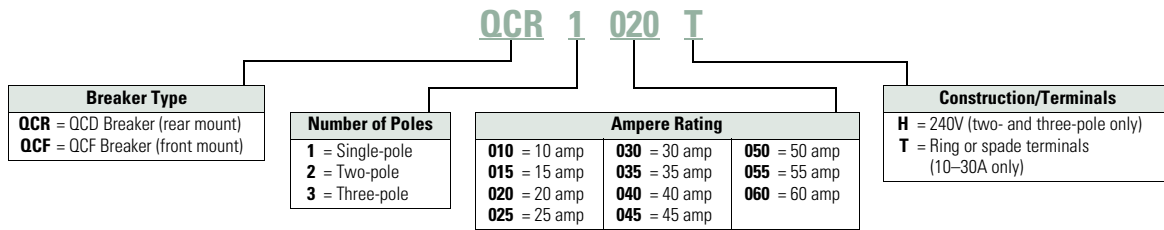

Product Selection

QUICKLAG Type QCR Breakers 10 kAIC Interrupting Ratings ①②③④

Continuous Ampere Rating at 40°C	Single-Pole 120/240 Vac Catalog Number	Two-Pole 120/240 Vac Catalog Number	Three-Pole 240 Vac Catalog Number
10	QCR1010 QCR1010T	QCR2010 QCR2010T	—
15	QCR1015 ⑤ QCR1015T ⑤	QCR2015 QCR2015T	QCR3015H QCR3015HT
20	QCR1020 ⑤ QCR1020T ⑤	QCR2020 QCR2020T	QCR3020H QCR3020HT
25	QCR1025 —	QCR2025 —	QCR3025H QCR3025HT
30	QCR1030 —	QCR2030 —	QCR3030H QCR3030HT
35	QCR1035	QCR2035	—
40	QCR1040	QCR2040	—
45	QCR1045	QCR2045	—
50	QCR1050	QCR2050	—
55	QCR1055	—	—
60 ⑥	QCR1060	QCR2060	—

QUICKLAG Type QCF Breakers 10 kAIC Interrupting Ratings ①②③

Continuous Ampere Rating at 40°C	Single-Pole 120/240 Vac Catalog Number	Two-Pole 120/240 Vac Catalog Number	Three-Pole 240 Vac Catalog Number
10	QCF1010 QCF1010T	QCF2010 QCF2010T	—
15	QCF1015 ⑤ —	QCF2015 —	QCF3015H QCF3015HT
20	QCF1020 ⑤ —	QCF2020 —	QCF3020H QCF3020HT
25	QCF1025 —	QCF2025 —	QCF3025H QCF3025HT
30	QCF1030 —	QCF2030 —	QCF3030H QCF3030HT
40	QCF1040	QCF2040	—
50	QCF1050	QCF2050	—
60 ⑤	QCF1060	QCF2060	—

Notes

- ① Standard breaker terminals are box type lugs.
- ② Breakers with "T" catalog number suffix are suitable for line and load side ring terminal connection (#10-32 plus/minus terminal screw provided).
- ③ Breakers with "P" catalog number suffix are suitable for terminating two 10 AWG quick-connect type terminals per phase on breaker load side.
- ④ Breakers with shunt trip (extra pole required on breaker right-hand side) are available on single-, two- and three-pole.
- ⑤ All 15 and 20A single-pole breakers are SWD (switching duty) rated for fluorescent lighting applications.
- ⑥ 60/75°C Cu/Al wire on all ratings except 60A, which requires Cu only conductor.

Accessories

Type QCR and QCF

Description	Catalog Number
Steel mounting clip mounts QCR breaker if individual mounting is required. Quantity two required for single- and two-pole and four required for three-pole breakers.	QCRMTGFT
Removable padlock device for single-pole QCR or QCF breaker.	QCRFPL1P
Removable padlock device for multi-pole QCR or QCF breaker.	QCRFPLMP
Padlock bracket assembly for QCR or QCF single- or multi-pole breakers (OFF only).	QCRFLOFF
Padlock bracket for QCR, lock-off only.	QCRPLOFF
QUICKLAG Type C Spacer	QCRSPACER

QUICKLAG Type C Spacer



QCR and QCF Ring or Spade Lug Terminals

QCR and QCF ring or spade lug terminals (10–30A ratings only). Factory installed line and load side terminals each equipped with a #10-32 screw suitable for terminating one 10 AWG wire with insulated ring or spade type terminal as shown.

Suffix "T"

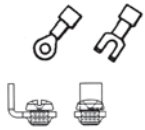

**QUICKLAG Type QC Miniature Circuit Breakers—Cable-In/Cable-Out
1/2-Inch Wide Types QCGF, QCGFEP**



Features

For Cable-In/Cable-Out Panel-Mount Applications

- QUICKLAG ground fault circuit breakers, Class A GFCI:
- Built and tested to UL 943
- 5 mA trip sensitivity
- QUICKLAG ground fault equipment protectors:
 - Built and tested to UL 1053
 - 30 mA trip sensitivity
- All products UL and CSA listed

Catalog Number Selection

**QUICKLAG Type QC Miniature Circuit Breakers—
Cable-In/Cable-Out Ground Fault and Equipment Protector Types QCGF, QCGFEP**

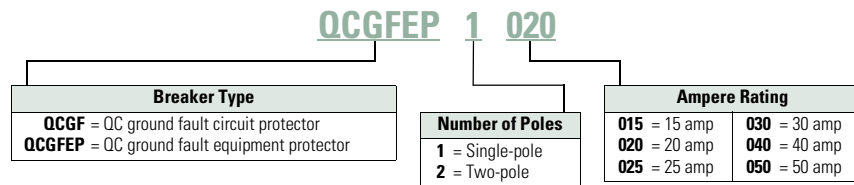



Product Selection

Types QCGF and QCGFEP Thermal-Magnetic Breakers

Continuous Ampere Rating at 40°C	Single-Pole, 120/240 Vac Catalog Number	Two-Pole, 120/240 Vac Catalog Number
Ground Fault Circuit Breakers—5 mA Sensitivity		
QUICKLAG Type: QCGF 10,000 Ampere I.C.		
15	QCGF1015	QCGF2015
20	QCGF1020	QCGF2020
30	QCGF1030	QCGF2030
40	QCGF1040	QCGF2040
50	—	QCGF2050
Ground Fault Equipment Protectors—30 mA Sensitivity		
QUICKLAG Type: QCGFEP 10,000 Ampere I.C.		
15	QCGFEP1015	QCGFEP2015
20	QCGFEP1020	QCGFEP2020
30	QCGFEP1030	QCGFEP2030
40	QCGFEP1040	QCGFEP2040
50	—	QCGFEP2050

Accessories

Type QC Miniature Circuit Breakers

	Accessory ^①	Description	Catalog Number
Handle Locks 	Handle locks: Non-padlockable ^②	QUICKLAG type P, B, C—single-pole	QL1NPL
		QUICKLAG type P, B, C—two-, three-pole	QL23NPL
	Handle locks: Padlockable	QUICKLAG type P, B, C—single-pole	QL1PL
		QUICKLAG type C—single-, two-, three-pole	QC123PL
		QUICKLAG type C—single-, two-, three-pole (off only)	QCD123PLOFF
Handle Tie 	Handle tie	QUICKLAG handle tie—single-pole	QL1HT
		QUICKLAG handle tie—three-pole	QL3HT
Hardware 	Mounting hardware	QUICKLAG type C face mounting clip	QCFLIP
		QUICKLAG type C face mounting plate—single-pole	QC1FP
		QUICKLAG type C face mounting plate—two-pole	QC2FP
		QUICKLAG type C face mounting plate—three-pole	QC3FP
		QUICKLAG type C face mounting plate and lock-off (off only)—two-pole ^③	QC2FPLOFF
		QUICKLAG type C face mounting plate and lock-off (off only)—three-pole	QC3FPLOFF
		QUICKLAG type C base mounting clamp	QCBCLIP
		QUICKLAG base mounting plate—six poles total	QC6BP
		QUICKLAG type C base mounting plate, six-poles total— heavy-duty screw-secured	QC6BPS
		QUICKLAG type C (QCD) two-way jumper unit with cover	QCDJ2
		QUICKLAG type C (QCD) four-way jumper unit with cover	QCDJ4
		QUICKLAG type C (QCD) six-way jumper unit with cover	QCDJ6
		QUICKLAG type C (QCD) two-way jumper unit, no cover	QCDJ2T
		QUICKLAG type C (QCD) four-way jumper unit, no cover	QCDJ4T
		QUICKLAG type C (QCD) six-way jumper unit, no cover	QCDJ6T
		QUICKLAG type QCD finger protection attachment	QCDFP
	QUICKLAG type C DIN rail adapter	QCDINADAPT	

Notes

- ① See **Page V9-T1-22** for QCR and QCF accessories.
- ② Can lock in ON or OFF position.
- ③ Suitable for ground fault breakers.

FAZ-NA UL 489 Circuit Breakers



Features

- UL 489 listed DIN rail mounted miniature circuit breakers up to 40A current rating
- Current limiting design provides fast short-circuit interruption that reduces let-through energy
- Thermal-magnetic overcurrent protection
 - Three levels of short-circuit protection, categorized by B, C and D curves
- Ring-tongue terminals available
- Complete line of accessories

Catalog Number Selection

FAZ-NA UL 489 Circuit Breakers

FAZ-NA UL 489

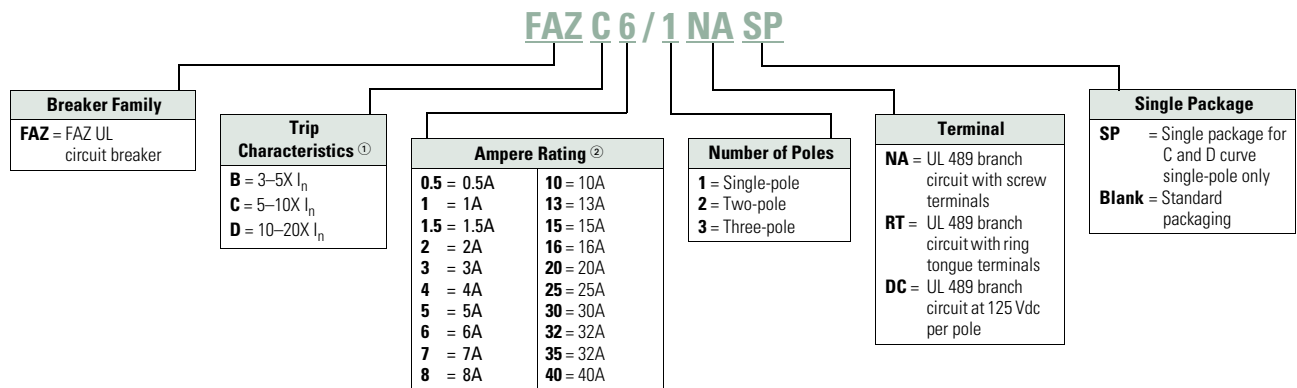

Notes

- ① I_n = Rated current for instantaneous trip characteristics.
- ② B curve starts at 1 ampere.

Product Selection

FAZ-NA UL 489 Circuit Breakers— 10 kAIC, 14 kAIC B Curve (15–25A)

Amperes	Single-Pole ^① Catalog Number	Two-Pole Catalog Number	Three-Pole Catalog Number
B Curve (3–5X I_n Current Rating)			
1	FAZ-B1/1-NA	FAZ-B1/2-NA	FAZ-B1/3-NA
1.5	FAZ-B1.5/1-NA	FAZ-B1.5/2-NA	FAZ-B1.5/3-NA
2	FAZ-B2/1-NA	FAZ-B2/2-NA	FAZ-B2/3-NA
3	FAZ-B3/1-NA	FAZ-B3/2-NA	FAZ-B3/3-NA
4	FAZ-B4/1-NA	FAZ-B4/2-NA	FAZ-B4/3-NA
5	FAZ-B5/1-NA	FAZ-B5/2-NA	FAZ-B5/3-NA
6	FAZ-B6/1-NA	FAZ-B6/2-NA	FAZ-B6/3-NA
7	FAZ-B7/1-NA	FAZ-B7/2-NA	FAZ-B7/3-NA
8	FAZ-B8/1-NA	FAZ-B8/2-NA	FAZ-B8/3-NA
10	FAZ-B10/1-NA	FAZ-B10/2-NA	FAZ-B10/3-NA
13	FAZ-B13/1-NA	FAZ-B13/2-NA	FAZ-B13/3-NA
15	FAZ-B15/1-NA	FAZ-B15/2-NA	FAZ-B15/3-NA
16	FAZ-B16/1-NA	FAZ-B16/2-NA	FAZ-B16/3-NA
20	FAZ-B20/1-NA	FAZ-B20/2-NA	FAZ-B20/3-NA
25	FAZ-B25/1-NA	FAZ-B25/2-NA	FAZ-B25/3-NA
30	FAZ-B30/1-NA	FAZ-B30/2-NA	FAZ-B30/3-NA
32	FAZ-B32/1-NA	FAZ-B32/2-NA	FAZ-B32/3-NA
35 ^②	FAZ-B35/1-NA	FAZ-B35/2-NA	FAZ-B35/3-NA
40 ^②	FAZ-B40/1-NA	FAZ-B40/2-NA	FAZ-B40/3-NA

FAZ-RT UL 489 Circuit Breakers with Ring-Tongue Terminals— 10 kAIC, 14 kAIC B Curve (15–25A)

Amperes	Single-Pole ^① Catalog Number	Two-Pole Catalog Number	Three-Pole Catalog Number
B Curve with Ring-Tongue Terminals (3–5X I_n Current Rating)			
1	FAZ-B1/1-RT	FAZ-B1/2-RT	FAZ-B1/3-RT
1.5	FAZ-B1.5/1-RT	FAZ-B1.5/2-RT	FAZ-B1.5/3-RT
2	FAZ-B2/1-RT	FAZ-B2/2-RT	FAZ-B2/3-RT
3	FAZ-B3/1-RT	FAZ-B3/2-RT	FAZ-B3/3-RT
4	FAZ-B4/1-RT	FAZ-B4/2-RT	FAZ-B4/3-RT
5	FAZ-B5/1-RT	FAZ-B5/2-RT	FAZ-B5/3-RT
6	FAZ-B6/1-RT	FAZ-B6/2-RT	FAZ-B6/3-RT
7	FAZ-B7/1-RT	FAZ-B7/2-RT	FAZ-B7/3-RT
8	FAZ-B8/1-RT	FAZ-B8/2-RT	FAZ-B8/3-RT
10	FAZ-B10/1-RT	FAZ-B10/2-RT	FAZ-B10/3-RT
13	FAZ-B13/1-RT	FAZ-B13/2-RT	FAZ-B13/3-RT
15	FAZ-B15/1-RT	FAZ-B15/2-RT	FAZ-B15/3-RT
16	FAZ-B16/1-RT	FAZ-B16/2-RT	FAZ-B16/3-RT
20	FAZ-B20/1-RT	FAZ-B20/2-RT	FAZ-B20/3-RT
25	FAZ-B25/1-RT	FAZ-B25/2-RT	FAZ-B25/3-RT
30	FAZ-B30/1-RT	FAZ-B30/2-RT	FAZ-B30/3-RT
32	FAZ-B32/1-RT	FAZ-B32/2-RT	FAZ-B32/3-RT
35 ^②	FAZ-B35/1-RT	FAZ-B35/2-RT	FAZ-B35/3-RT
40 ^②	FAZ-B40/1-RT	FAZ-B40/2-RT	FAZ-B40/3-RT

FAZ-NA UL 489 Circuit Breakers— 10 kAIC, 14 kAIC C Curve (15–25A)

Amperes	Single-Pole ^③ Catalog Number	Two-Pole Catalog Number	Three-Pole Catalog Number
C Curve (5–10X I_n Current Rating)			
0.5	FAZ-C0.5/1-NA-SP	FAZ-C0.5/2-NA	FAZ-C0.5/3-NA
1	FAZ-C1/1-NA-SP	FAZ-C1/2-NA	FAZ-C1/3-NA
1.5	FAZ-C1.5/1-NA-SP	FAZ-C1.5/2-NA	FAZ-C1.5/3-NA
2	FAZ-C2/1-NA-SP	FAZ-C2/2-NA	FAZ-C2/3-NA
3	FAZ-C3/1-NA-SP	FAZ-C3/2-NA	FAZ-C3/3-NA
4	FAZ-C4/1-NA-SP	FAZ-C4/2-NA	FAZ-C4/3-NA
5	FAZ-C5/1-NA-SP	FAZ-C5/2-NA	FAZ-C5/3-NA
6	FAZ-C6/1-NA-SP	FAZ-C6/2-NA	FAZ-C6/3-NA
7	FAZ-C7/1-NA-SP	FAZ-C7/2-NA	FAZ-C7/3-NA
8	FAZ-C8/1-NA-SP	FAZ-C8/2-NA	FAZ-C8/3-NA
10	FAZ-C10/1-NA-SP	FAZ-C10/2-NA	FAZ-C10/3-NA
13	FAZ-C13/1-NA-SP	FAZ-C13/2-NA	FAZ-C13/3-NA
15	FAZ-C15/1-NA-SP	FAZ-C15/2-NA	FAZ-C15/3-NA
16	FAZ-C16/1-NA-SP	FAZ-C16/2-NA	FAZ-C16/3-NA
20	FAZ-C20/1-NA-SP	FAZ-C20/2-NA	FAZ-C20/3-NA
25	FAZ-C25/1-NA-SP	FAZ-C25/2-NA	FAZ-C25/3-NA
30	FAZ-C30/1-NA-SP	FAZ-C30/2-NA	FAZ-C30/3-NA
32	FAZ-C32/1-NA-SP	FAZ-C32/2-NA	FAZ-C32/3-NA
35 ^②	FAZ-C35/1-NA-SP	FAZ-C35/2-NA	FAZ-C35/3-NA
40 ^②	FAZ-C40/1-NA-SP	FAZ-C40/2-NA	FAZ-C40/3-NA

FAZ-RT UL 489 Circuit Breakers with Ring-Tongue Terminals— 10 kAIC, 14 kAIC C Curve (15–25A)

Amperes	Single-Pole ^③ Catalog Number	Two-Pole Catalog Number	Three-Pole Catalog Number
C Curve with Ring-Tongue Terminals (5–10X I_n Current Rating)			
0.5	FAZ-C0.5/1-RT-SP	FAZ-C0.5/2-RT	FAZ-C0.5/3-RT
1	FAZ-C1/1-RT-SP	FAZ-C1/2-RT	FAZ-C1/3-RT
1.5	FAZ-C1.5/1-RT-SP	FAZ-C1.5/2-RT	FAZ-C1.5/3-RT
2	FAZ-C2/1-RT-SP	FAZ-C2/2-RT	FAZ-C2/3-RT
3	FAZ-C3/1-RT-SP	FAZ-C3/2-RT	FAZ-C3/3-RT
4	FAZ-C4/1-RT-SP	FAZ-C4/2-RT	FAZ-C4/3-RT
5	FAZ-C5/1-RT-SP	FAZ-C5/2-RT	FAZ-C5/3-RT
6	FAZ-C6/1-RT-SP	FAZ-C6/2-RT	FAZ-C6/3-RT
7	FAZ-C7/1-RT-SP	FAZ-C7/2-RT	FAZ-C7/3-RT
8	FAZ-C8/1-RT-SP	FAZ-C8/2-RT	FAZ-C8/3-RT
10	FAZ-C10/1-RT-SP	FAZ-C10/2-RT	FAZ-C10/3-RT
13	FAZ-C13/1-RT-SP	FAZ-C13/2-RT	FAZ-C13/3-RT
15	FAZ-C15/1-RT-SP	FAZ-C15/2-RT	FAZ-C15/3-RT
16	FAZ-C16/1-RT-SP	FAZ-C16/2-RT	FAZ-C16/3-RT
20	FAZ-C20/1-RT-SP	FAZ-C20/2-RT	FAZ-C20/3-RT
25	FAZ-C25/1-RT-SP	FAZ-C25/2-RT	FAZ-C25/3-RT
30	FAZ-C30/1-RT-SP	FAZ-C30/2-RT	FAZ-C30/3-RT
32	FAZ-C32/1-RT-SP	FAZ-C32/2-RT	FAZ-C32/3-RT
35 ^②	FAZ-C35/1-RT-SP	FAZ-C35/2-RT	FAZ-C35/3-RT
40 ^②	FAZ-C40/1-RT-SP	FAZ-C40/2-RT	FAZ-C40/3-RT

Notes

- ① Two-piece order. Quantities of two per box.
- ② 240 Vac rated only.
- ③ Option for single packaging on single-pole C and D curves only; add suffix SP when ordering.

**FAZ-NA UL 489 Circuit Breakers— 10 kAIC, 14 kAIC
D Curve (13–20A)**

Amperes	Single-Pole ^① Catalog Number	Two-Pole Catalog Number	Three-Pole Catalog Number
D Curve (10–20X I_n Current Rating)			
0.5	FAZ-D0.5/1-NA-SP	FAZ-D0.5/2-NA	FAZ-D0.5/3-NA
1	FAZ-D1/1-NA-SP	FAZ-D1/2-NA	FAZ-D1/3-NA
1.5	FAZ-D1.5/1-NA-SP	FAZ-D1.5/2-NA	FAZ-D1.5/3-NA
2	FAZ-D2/1-NA-SP	FAZ-D2/2-NA	FAZ-D2/3-NA
3	FAZ-D3/1-NA-SP	FAZ-D3/2-NA	FAZ-D3/3-NA
4	FAZ-D4/1-NA-SP	FAZ-D4/2-NA	FAZ-D4/3-NA
5	FAZ-D5/1-NA-SP	FAZ-D5/2-NA	FAZ-D5/3-NA
6	FAZ-D6/1-NA-SP	FAZ-D6/2-NA	FAZ-D6/3-NA
7	FAZ-D7/1-NA-SP	FAZ-D7/2-NA	FAZ-D7/3-NA
8	FAZ-D8/1-NA-SP	FAZ-D8/2-NA	FAZ-D8/3-NA
10	FAZ-D10/1-NA-SP	FAZ-D10/2-NA	FAZ-D10/3-NA
13	FAZ-D13/1-NA-SP	FAZ-D13/2-NA	FAZ-D13/3-NA
15	FAZ-D15/1-NA-SP	FAZ-D15/2-NA	FAZ-D15/3-NA
16	FAZ-D16/1-NA-SP	FAZ-D16/2-NA	FAZ-D16/3-NA
20	FAZ-D20/1-NA-SP	FAZ-D20/2-NA	FAZ-D20/3-NA
25	FAZ-D25/1-NA-SP	FAZ-D25/2-NA	FAZ-D25/3-NA
30	FAZ-D30/1-NA-SP	FAZ-D30/2-NA	FAZ-D30/3-NA
32	FAZ-D32/1-NA-SP	FAZ-D32/2-NA	FAZ-D32/3-NA
35 ^②	FAZ-D35/1-NA-SP	FAZ-D35/2-NA	FAZ-D35/3-NA
40 ^②	FAZ-D40/1-NA-SP	FAZ-D40/2-NA	FAZ-D40/3-NA

**FAZ-NA-DC UL 489 Circuit Breakers— 10 kAIC at
125 Vdc Per Pole**

Amperes	Single-Pole ^③ Catalog Number	Two-Pole Catalog Number
C Curve (5–10X I_n Current Rating)		
2	FAZ-C2/1-NA-DC-SP	FAZ-C2/2-NA-DC
3	FAZ-C3/1-NA-DC-SP	FAZ-C3/2-NA-DC
4	FAZ-C4/1-NA-DC-SP	FAZ-C4/2-NA-DC
5	FAZ-C5/1-NA-DC-SP	FAZ-C5/2-NA-DC
6	FAZ-C6/1-NA-DC-SP	FAZ-C6/2-NA-DC
7	FAZ-C7/1-NA-DC-SP	FAZ-C7/2-NA-DC
8	FAZ-C8/1-NA-DC-SP	FAZ-C8/2-NA-DC
10	FAZ-C10/1-NA-DC-SP	FAZ-C10/2-NA-DC
13	FAZ-C13/1-NA-DC-SP	FAZ-C13/2-NA-DC
15	FAZ-C15/1-NA-DC-SP	FAZ-C15/2-NA-DC
16	FAZ-C16/1-NA-DC-SP	FAZ-C16/2-NA-DC
20	FAZ-C20/1-NA-DC-SP	FAZ-C20/2-NA-DC
25	FAZ-C25/1-NA-DC-SP	FAZ-C25/2-NA-DC
30	FAZ-C30/1-NA-DC-SP	FAZ-C30/2-NA-DC
32	FAZ-C32/1-NA-DC-SP	FAZ-C32/2-NA-DC
35	FAZ-C35/1-NA-DC-SP	FAZ-C35/2-NA-DC
40	FAZ-C40/1-NA-DC-SP	FAZ-C40/2-NA-DC

Notes

- ① Option for single packaging on single-pole C and D curves only; add suffix SP when ordering.
 ② 240 Vac rated only.
 ③ Option for single packaging on single-pole C curves only; add suffix SP when ordering.

**FAZ-RT UL 489 Circuit Breakers with Ring-Tongue
Terminals— 10 kAIC, 14 kAIC D Curve (13–20A)**

Amperes	Single-Pole ^① Catalog Number	Two-Pole Catalog Number	Three-Pole Catalog Number
D Curve with Ring-Tongue Terminals (10–20X I_n Current Rating)			
0.5	FAZ-D0.5/1-RT-SP	FAZ-D0.5/2-RT	FAZ-D0.5/3-RT
1	FAZ-D1/1-RT-SP	FAZ-D1/2-RT	FAZ-D1/3-RT
1.5	FAZ-D1.5/1-RT-SP	FAZ-D1.5/2-RT	FAZ-D1.5/3-RT
2	FAZ-D2/1-RT-SP	FAZ-D2/2-RT	FAZ-D2/3-RT
3	FAZ-D3/1-RT-SP	FAZ-D3/2-RT	FAZ-D3/3-RT
4	FAZ-D4/1-RT-SP	FAZ-D4/2-RT	FAZ-D4/3-RT
5	FAZ-D5/1-RT-SP	FAZ-D5/2-RT	FAZ-D5/3-RT
6	FAZ-D6/1-RT-SP	FAZ-D6/2-RT	FAZ-D6/3-RT
7	FAZ-D7/1-RT-SP	FAZ-D7/2-RT	FAZ-D7/3-RT
8	FAZ-D8/1-RT-SP	FAZ-D8/2-RT	FAZ-D8/3-RT
10	FAZ-D10/1-RT-SP	FAZ-D10/2-RT	FAZ-D10/3-RT
13	FAZ-D13/1-RT-SP	FAZ-D13/2-RT	FAZ-D13/3-RT
15	FAZ-D15/1-RT-SP	FAZ-D15/2-RT	FAZ-D15/3-RT
16	FAZ-D16/1-RT-SP	FAZ-D16/2-RT	FAZ-D16/3-RT
20	FAZ-D20/1-RT-SP	FAZ-D20/2-RT	FAZ-D20/3-RT
25	FAZ-D25/1-RT-SP	FAZ-D25/2-RT	FAZ-D25/3-RT
30	FAZ-D30/1-RT-SP	FAZ-D30/2-RT	FAZ-D30/3-RT
32	FAZ-D32/1-RT-SP	FAZ-D32/2-RT	FAZ-D32/3-RT
35 ^②	FAZ-D35/1-RT-SP	FAZ-D35/2-RT	FAZ-D35/3-RT
40 ^②	FAZ-D40/1-RT-SP	FAZ-C40/2-RT	FAZ-D40/3-RT

FAZ UL 1077 Circuit Breakers



Features

- UL 1077 recognized DIN rail mounted supplemental protectors up to 63A
- Current limiting design provides fast short-circuit interruption that reduces let-through energy
- Thermal-magnetic overcurrent protection
 - Three levels of short-circuit protection, categorized by B, C and D curves
- Ideal replacement for fuses that are applied as supplemental protection
- Complete line of accessories

Catalog Number Selection

FAZ UL 1077 Circuit Breakers

FAZ UL 1077

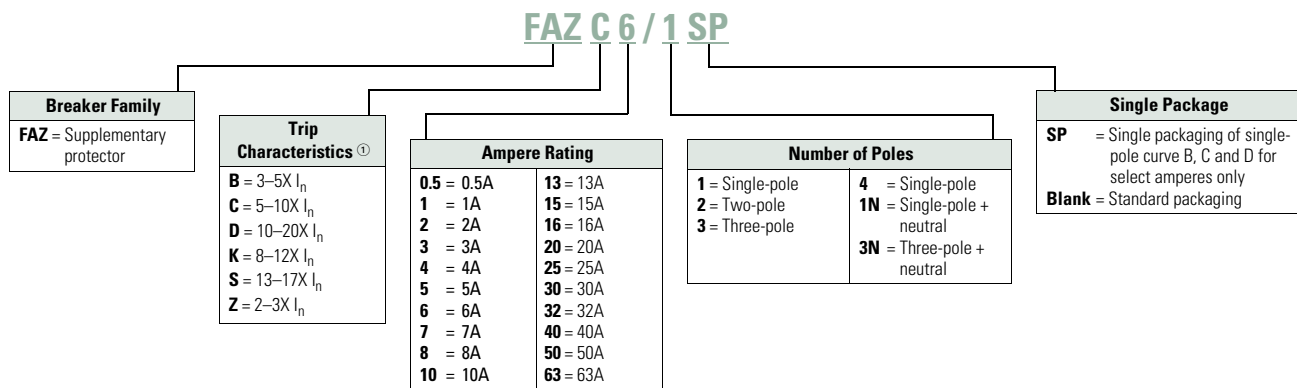

Note

① I_n = Rated current for instantaneous trip characteristics.

Product Selection

B Curve (3–5X I_n Current Rating)—Designed for Resistive or Slightly Inductive Loads ^①

Amperes	Single-Pole ^② Catalog Number	Two-Pole Catalog Number	Three-Pole Catalog Number
1	FAZ-B1/1-SP	FAZ-B1/2	FAZ-B1/3
2	FAZ-B2/1-SP	FAZ-B2/2	FAZ-B2/3
3	FAZ-B3/1-SP	FAZ-B3/2	FAZ-B3/3
4	FAZ-B4/1-SP	FAZ-B4/2	FAZ-B4/3
5	FAZ-B5/1-SP	FAZ-B5/2	FAZ-B5/3
6	FAZ-B6/1-SP	FAZ-B6/2	FAZ-B6/3
7	FAZ-B7/1-SP	FAZ-B7/2	FAZ-B7/3
8	FAZ-B8/1-SP	FAZ-B8/2	FAZ-B8/3
10	FAZ-B10/1-SP	FAZ-B10/2	FAZ-B10/3
12	FAZ-B12/1-SP	FAZ-B12/2	FAZ-B12/3
13	FAZ-B13/1-SP	FAZ-B13/2	FAZ-B13/3
15	FAZ-B15/1-SP	FAZ-B15/2	FAZ-B15/3
16	FAZ-B16/1-SP	FAZ-B16/2	FAZ-B16/3
20	FAZ-B20/1-SP	FAZ-B20/2	FAZ-B20/3
25	FAZ-B25/1-SP	FAZ-B25/2	FAZ-B25/3
30	FAZ-B30/1-SP	FAZ-B30/2	FAZ-B30/3
32	FAZ-B32/1-SP	FAZ-B32/2	FAZ-B32/3
40	FAZ-B40/1-SP	FAZ-B40/2	FAZ-B40/3
50	FAZ-B50/1-SP	FAZ-B50/2	FAZ-B50/3
63	FAZ-B63/1-SP	FAZ-B63/2	FAZ-B63/3

B Curve (3–5X I_n Current Rating)—Designed for Resistive or Slightly Inductive Loads, continued ^①

Amperes	Four-Pole	Single-Pole + Neutral	Three-Pole + Neutral
1	FAZ-B1/4	FAZ-B1/1N	FAZ-B1/3N
2	FAZ-B2/4	FAZ-B2/1N	FAZ-B2/3N
3	FAZ-B3/4	FAZ-B3/1N	FAZ-B3/3N
4	FAZ-B4/4	FAZ-B4/1N	FAZ-B4/3N
5	FAZ-B5/4	FAZ-B5/1N	FAZ-B5/3N
6	FAZ-B6/4	FAZ-B6/1N	FAZ-B6/3N
7	FAZ-B7/4	FAZ-B7/1N	FAZ-B7/3N
8	FAZ-B8/4	FAZ-B8/1N	FAZ-B8/3N
10	FAZ-B10/4	FAZ-B10/1N	FAZ-B10/3N
12	FAZ-B12/4	FAZ-B12/1N	FAZ-B12/3N
13	FAZ-B13/4	FAZ-B13/1N	FAZ-B13/3N
15	FAZ-B15/4	FAZ-B15/1N	FAZ-B15/3N
16	FAZ-B16/4	FAZ-B16/1N	FAZ-B16/3N
20	FAZ-B20/4	FAZ-B20/1N	FAZ-B20/3N
25	FAZ-B25/4	FAZ-B25/1N	FAZ-B25/3N
30	FAZ-B30/4	FAZ-B30/1N	FAZ-B30/3N
32	FAZ-B32/4	FAZ-B32/1N	FAZ-B32/3N
40	FAZ-B40/4	FAZ-B40/1N	FAZ-B40/3N
50	FAZ-B50/4	FAZ-B50/1N	FAZ-B50/3N
63	FAZ-B63/4	FAZ-B63/1N	FAZ-B63/3N

Notes

- ^① In North America, these switches are UL recognized and CSA Certified as supplementary protection devices. Per the intent of NEC (National Electrical Code), Article 240, and CEC (Canadian Electrical Code), Part 1 C22.1, supplementary breakers cannot be used as a substitute for the branch circuit protective device. They can be used to provide overcurrent protection within an appliance or other electrical equipment where branch circuit overcurrent protection is already provided, or is not required.
- ^② Option for single packaging on single-pole B, C and D curves only; add suffix SP when ordering.

1 C Curve (5–10X I_n Current Rating)—Designed Inductive Loads ^①

Amperes	Single-Pole ^② Catalog Number	Two-Pole Catalog Number	Three-Pole Catalog Number
0.5	FAZ-C0.5/1-SP	FAZ-C0.5/2	FAZ-C0.5/3
1	FAZ-C1/1-SP	FAZ-C1/2	FAZ-C1/3
1.6	FAZ-C1.6/1-SP	FAZ-C1.6/2	FAZ-C1.6/3
2	FAZ-C2/1-SP	FAZ-C2/2	FAZ-C2/3
3	FAZ-C3/1-SP	FAZ-C3/2	FAZ-C3/3
4	FAZ-C4/1-SP	FAZ-C4/2	FAZ-C4/3
5	FAZ-C5/1-SP	FAZ-C5/2	FAZ-C5/3
6	FAZ-C6/1-SP	FAZ-C6/2	FAZ-C6/3
7	FAZ-C7/1-SP	FAZ-C7/2	FAZ-C7/3
8	FAZ-C8/1-SP	FAZ-C8/2	FAZ-C8/3
10	FAZ-C10/1-SP	FAZ-C10/2	FAZ-C10/3
13	FAZ-C13/1-SP	FAZ-C13/2	FAZ-C13/3
15	FAZ-C15/1-SP	FAZ-C15/2	FAZ-C15/3
16	FAZ-C16/1-SP	FAZ-C16/2	FAZ-C16/3
20	FAZ-C20/1-SP	FAZ-C20/2	FAZ-C20/3
25	FAZ-C25/1-SP	FAZ-C25/2	FAZ-C25/3
30	FAZ-C30/1-SP	FAZ-C30/2	FAZ-C30/3
32	FAZ-C32/1-SP	FAZ-C32/2	FAZ-C32/3
40	FAZ-C40/1-SP	FAZ-C40/2	FAZ-C40/3
50	FAZ-C50/1-SP	FAZ-C50/2	FAZ-C50/3
63	FAZ-C63/1-SP	FAZ-C63/2	FAZ-C63/3

C Curve (5–10X I_n Current Rating)—Designed Inductive Loads, continued ^①

Amperes	Four-Pole	Single-Pole + Neutral	Three-Pole + Neutral
0.5	FAZ-C0.5/4	FAZ-C0.5/1N	FAZ-C0.5/3N
1	FAZ-C1/4	FAZ-C1/1N	FAZ-C1/3N
1.6	FAZ-C1.6/4	FAZ-C1.6/1N	FAZ-C1.6/3N
2	FAZ-C2/4	FAZ-C2/1N	FAZ-C2/3N
3	FAZ-C3/4	FAZ-C3/1N	FAZ-C3/3N
4	FAZ-C4/4	FAZ-C4/1N	FAZ-C4/3N
5	FAZ-C5/4	FAZ-C5/1N	FAZ-C5/3N
6	FAZ-C6/4	FAZ-C6/1N	FAZ-C6/3N
7	FAZ-C7/4	FAZ-C7/1N	FAZ-C7/3N
8	FAZ-C8/4	FAZ-C8/1N	FAZ-C8/3N
10	FAZ-C10/4	FAZ-C10/1N	FAZ-C10/3N
13	FAZ-C13/4	FAZ-C13/1N	FAZ-C13/3N
15	FAZ-C15/4	FAZ-C15/1N	FAZ-C15/3N
16	FAZ-C16/4	FAZ-C16/1N	FAZ-C16/3N
20	FAZ-C20/4	FAZ-C20/1N	FAZ-C20/3N
25	FAZ-C25/4	FAZ-C25/1N	FAZ-C25/3N
30	FAZ-C30/4	FAZ-C30/1N	FAZ-C30/3N
32	FAZ-C32/4	FAZ-C32/1N	FAZ-C32/3N
40	FAZ-C40/4	FAZ-C40/1N	FAZ-C40/3N
50	FAZ-C50/4	FAZ-C50/1N	FAZ-C50/3N
63	FAZ-C63/4	FAZ-C63/1N	FAZ-C63/3N

Notes

- ^① In North America, these switches are UL recognized and CSA Certified as supplementary protection devices. Per the intent of NEC (National Electrical Code), Article 240, and CEC (Canadian Electrical Code), Part 1 C22.1, supplementary breakers cannot be used as a substitute for the branch circuit protective device. They can be used to provide overcurrent protection within an appliance or other electrical equipment where branch circuit overcurrent protection is already provided, or is not required.
- ^② Option for single packaging on single-pole B, C and D curves only; add suffix SP when ordering.

D Curve (10–20X I_n Current Rating)—Designed for Inductive Loads ^①

Amperes	Single-Pole ^② Catalog Number	Two-Pole Catalog Number	Three-Pole Catalog Number
0.5	FAZ-D0.5/1-SP	FAZ-D0.5/2	FAZ-D0.5/3
1	FAZ-D1/1-SP	FAZ-D1/2	FAZ-D1/3
2	FAZ-D2/1-SP	FAZ-D2/2	FAZ-D2/3
3	FAZ-D3/1-SP	FAZ-D3/2	FAZ-D3/3
4	FAZ-D4/1-SP	FAZ-D4/2	FAZ-D4/3
5	FAZ-D5/1-SP	FAZ-D5/2	FAZ-D5/3
6	FAZ-D6/1-SP	FAZ-D6/2	FAZ-D6/3
7	FAZ-D7/1-SP	FAZ-D7/2	FAZ-D7/3
8	FAZ-D8/1-SP	FAZ-D8/2	FAZ-D8/3
10	FAZ-D10/1-SP	FAZ-D10/2	FAZ-D10/3
13	FAZ-D13/1-SP	FAZ-D13/2	FAZ-D13/3
15	FAZ-D15/1-SP	FAZ-D15/2	FAZ-D15/3
16	FAZ-D16/1-SP	FAZ-D16/2	FAZ-D16/3
20	FAZ-D20/1-SP	FAZ-D20/2	FAZ-D20/3
25	FAZ-D25/1-SP	FAZ-D25/2	FAZ-D25/3
30	FAZ-D30/1-SP	FAZ-D30/2	FAZ-D30/3
32	FAZ-D32/1-SP	FAZ-D32/2	FAZ-D32/3
40	FAZ-D40/1-SP	FAZ-D40/2	FAZ-D40/3
50 ^③	FAZ-D50/1-SP	FAZ-D50/2	FAZ-D50/3
63 ^③	FAZ-D63/1-SP	FAZ-D63/2	FAZ-D63/3

D Curve (10–20X I_n Current Rating)—Designed for Inductive Loads, continued ^①

Amperes	Four-Pole	Single-Pole + Neutral	Three-Pole + Neutral
0.5	FAZ-D0.5/4	FAZ-D0.5/1N	FAZ-D0.5/3N
1	FAZ-D1/4	FAZ-D1/1N	FAZ-D1/3N
2	FAZ-D2/4	FAZ-D2/1N	FAZ-D2/3N
3	FAZ-D3/4	FAZ-D3/1N	FAZ-D3/3N
4	FAZ-D4/4	FAZ-D4/1N	FAZ-D4/3N
5	FAZ-D5/4	FAZ-D5/1N	FAZ-D5/3N
6	FAZ-D6/4	FAZ-D6/1N	FAZ-D6/3N
7	FAZ-D7/4	FAZ-D7/1N	FAZ-D7/3N
8	FAZ-D8/4	FAZ-D8/1N	FAZ-D8/3N
10	FAZ-D10/4	FAZ-D10/1N	FAZ-D10/3N
13	FAZ-D13/4	FAZ-D13/1N	FAZ-D13/3N
15	FAZ-D15/4	FAZ-D15/1N	FAZ-D15/3N
16	FAZ-D16/4	FAZ-D16/1N	FAZ-D16/3N
20	FAZ-D20/4	FAZ-D20/1N	FAZ-D20/3N
25	FAZ-D25/4	FAZ-D25/1N	FAZ-D25/3N
30	FAZ-D30/4	FAZ-D30/1N	FAZ-D30/3N
32	FAZ-D32/4	FAZ-D32/1N	FAZ-D32/3N
40	FAZ-D40/4	FAZ-D40/1N	FAZ-D40/3N
50 ^③	FAZ-D50/4	FAZ-D50/1N	FAZ-D50/3N
63 ^③	FAZ-D63/4	FAZ-D63/1N	FAZ-D63/3N

Notes

- ^① In North America, these switches are UL recognized and CSA Certified as supplementary protection devices. Per the intent of NEC (National Electrical Code), Article 240, and CEC (Canadian Electrical Code), Part 1 C22.1, supplementary breakers cannot be used as a substitute for the branch circuit protective device. They can be used to provide overcurrent protection within an appliance or other electrical equipment where branch circuit overcurrent protection is already provided, or is not required.
- ^② Option for single packaging on single-pole B, C and D curves only; add suffix SP when ordering.
- ^③ IEC 60947-2 only.

Accessories

FAZ-NA UL 489 Breakers

Description	Catalog Number
Two-pole contact or auxiliary contact/trip indicating contact	Z-NHK ^①
Auxiliary contact	Z-IHK-NA
Shunt trip 110–415 Vac	FAZ-XAA-NA110-415VAC
Shunt trip 12–110 Vac	FAZ-XAA-NA12-110VAC
Padlock hasp	IS/SPE-1TE
Busbar—single-pole, 6 terminals ^{②③④⑤}	Z-SV/UL-16/1P-1TE/6
Busbar—single-pole, 12 terminals ^{②③④⑤}	Z-SV/UL-16/1P-1TE/12
Busbar—single-pole, 18 terminals ^{②③④⑤}	Z-SV/UL-16/1P-1TE/18
Busbar—two-pole, 6 terminals ^{②③④⑤}	Z-SV/UL-16/2P-2TE/6
Busbar—two-pole, 12 terminals ^{②③④⑤}	Z-SV/UL-16/2P-2TE/12
Busbar—two-pole, 18 terminals ^{②③④⑤}	Z-SV/UL-16/2P-2TE/18
Busbar—three-pole, 6 terminals ^{②③④⑤}	Z-SV/UL-16/3P-3TE/6
Busbar—three-pole, 12 terminals ^{②③④⑤}	Z-SV/UL-16/3P-3TE/12
Busbar—three-pole, 18 terminals ^{②③④⑤}	Z-SV/UL-16/3P-3TE/18
Three-pole busbar shroud	ZV-BS-UL
Extension terminal—35 mm ² (2–14 AWG)	Z-EK/35/UL
Bus connector—conductors up to 50 mm ² (~1/0 AWG)	Z-EB/50/UL

FAZ UL 1077 Auxiliary Contacts

Description	Rated Operational Voltage	Catalog Number
Standard Auxiliary Contacts		
1NO/1NC Installs on left side of FAZ or shunt trip Max. one per FAZ (1077) device Switches when FAZ is tripped electrically or manually	230 Vac	FAZ-XHIN11
1 changeover contact Installs on left side of FAZ or shunt trip Max. one per FAZ (1077) device Switches when FAZ is tripped electrically or manually	230 Vac	FAZ-XHINW1
Auxiliary/Trip Indicating Contact		
Small selector screw changes mode Two Form C (changeover) contacts Installs on left side of FAZ or shunt trip Auxiliary contacts switch when FAZ is tripped electrically or manually Trip indicating contact switches only when FAZ is tripped electrically	230 Vac	FAZ-XAM002
Undervoltage Trip		
Prevents FAZ from operating unless voltage is present	115 Vac	FAZ-XUA(115VAC)
Installs on left side of FAZ	230 Vac	FAZ-XUA(230VAC)
Includes test button	400 Vac	FAZ-XUA(400VAC)
Shunt Trip		
Allows remote trip of FAZ Installs on left side of FAZ	12–110 Vac 12–60 Vdc	FAZ-XAA-C-12-110VAC
	110–415 Vac 110–230 Vdc	FAZ-XAA-C-110-415VAC

FAZ UL 1077 Busbar System

Rated Operational Current	Number of Poles per Device	Number of Terminals	Catalog Number ^⑤
Without Auxiliary Contacts			
80A	1	57	BB-UL-18/1P-1M/57
	2	56	BB-UL-18/2P-2M/56
	3	57	BB-UL-18/3P-3M/57
100A	1	57	BB-UL-25/1P-1M/57
	2	56	BB-UL-25/2P-2M/56
	3	57	BB-UL-25/3P-3M/57
Auxiliary/Trip Indicating Contacts			
80A	1	37	BB-UL-18/1P-1.5M/37
	2	46	BB-UL-18/2P+AS-2.5M/46
	3	48	BB-UL-18/3P+AS-3.5M/48
100A	1	37	BB-UL-25/1P-1.5M/37
	2	46	BB-UL-25/2P+AS-2.5M/46
	3	48	BB-UL-25/3P+AS-3.5M/48

Pin Type Incoming Supply Terminals

Description	Catalog Number
Accommodates conductors from 6–35 mm ² /#10–2 AWG 4–5.5 Nm/35–50 lb-in / Two- and three-pole	BB-UL-TEP/35

Pin Type Incoming Supply Terminals—Single-Phase Only

Description	Catalog Number
Accommodates conductors from 6–35 mm ² /#10–2 AWG 4–5.5 Nm/35–50 lb-in	BB-UL-TEPA/35

Protective Accessories

Description	Catalog Number
For covering unused terminals	BB-IP/5
Prevents reactivation of the device during maintenance Holds one padlock	IS/SPE-1TE

Bus Incoming Supply Terminals

Description	Catalog Number
50 mm ² #14–1 AWG 75 Deg wire 115 A/Y, 480V UL 160 A/Y 690V IEC	BB-UL-TE/50

Busbar End Cap

Description	Poles	Catalog Number
Install after cutting busbar	2 and 3	BB-UL-EC/3
Protects end of busbar	1	BB-UL-EC/1

Notes

- ① Voltage of FAZ-NA circuit breaker is limited to 300V with this auxiliary contact installed.
- ② Do not cut commoning link.
- ③ A maximum of three commoning links may be used in conjunction. Each breaker connected to the commoning link must have the same number of poles for proper use.
- ④ Not for use with ring-tongue circuit breakers.
- ⑤ Bus may be center fed for high current capacity.

Series NRX Low Voltage Power Breakers**Series NRX™ Low Voltage Power Breakers****Features**

- Rogowski coil does not saturate like iron core sensors, and one sensor accommodates 200–1600A range. Never change a sensor, and NO CTs are required
- Tension clamp secondary terminals—10A continuous rating at 600V meets UL/CSA/RoHS and UL-94 V0. Mounted directly to fixed breaker or drawout cassette they reduce wiring and provide clean, organized wiring schemes
- Breaker mounted communication modules for INCOM™, Modbus® and PROFIBUS® mount directly to the cassette, reducing the space and room required for communication capability
- With the patent pending simple design of the fold-up cassette, all items in a cassette are replaceable without removing the cassette from the cell
- Plug-and-play accessories—no special tools needed. Accessories come with plug and wires ready to install

Catalog Number Selection

Series NRX Power Breakers (Exclusionary Rules Apply)

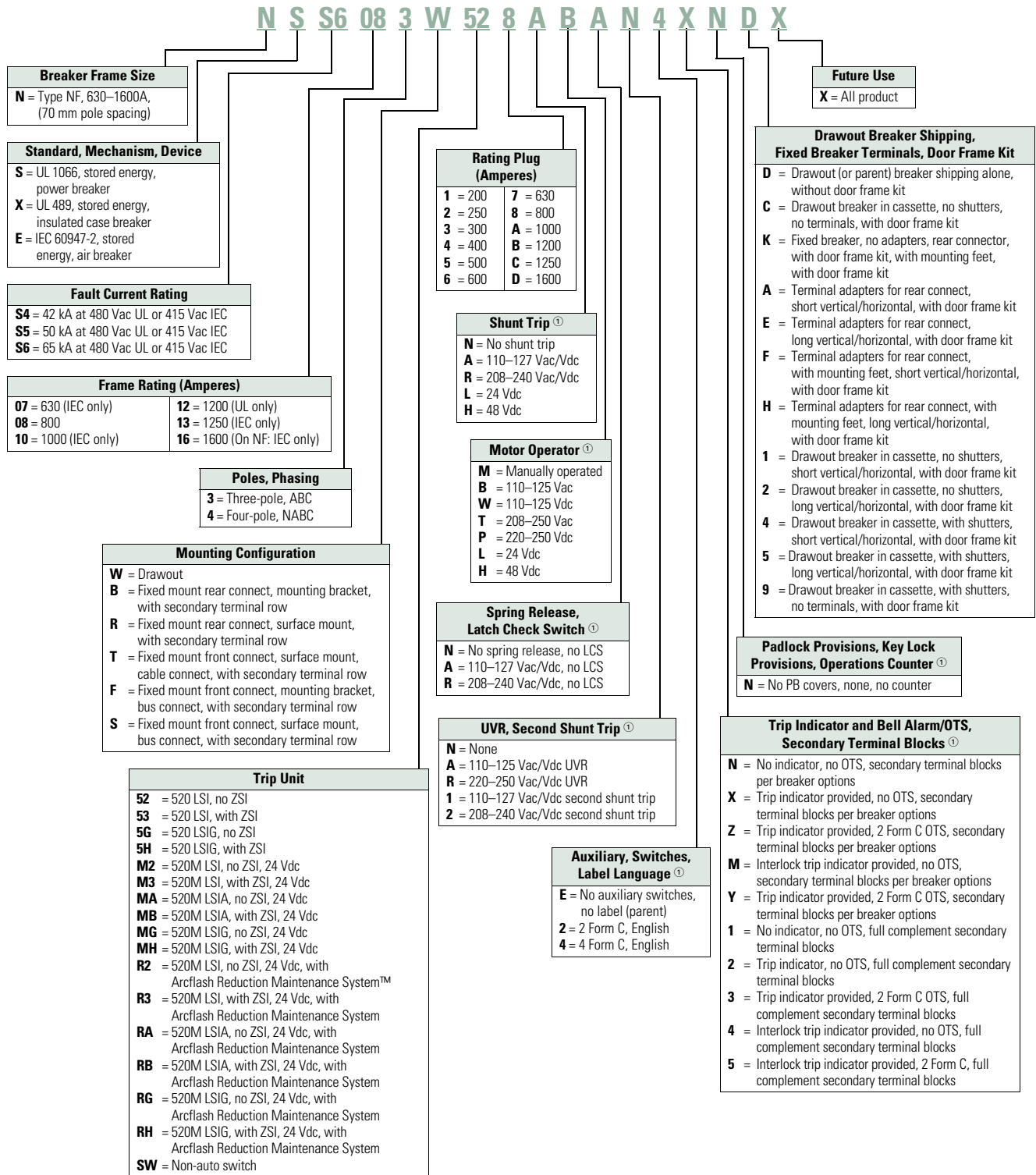

Note
 ① Contact Eaton for available voltages. Not all voltages are currently available.

Catalog Number Selection

Series NRX Cassettes

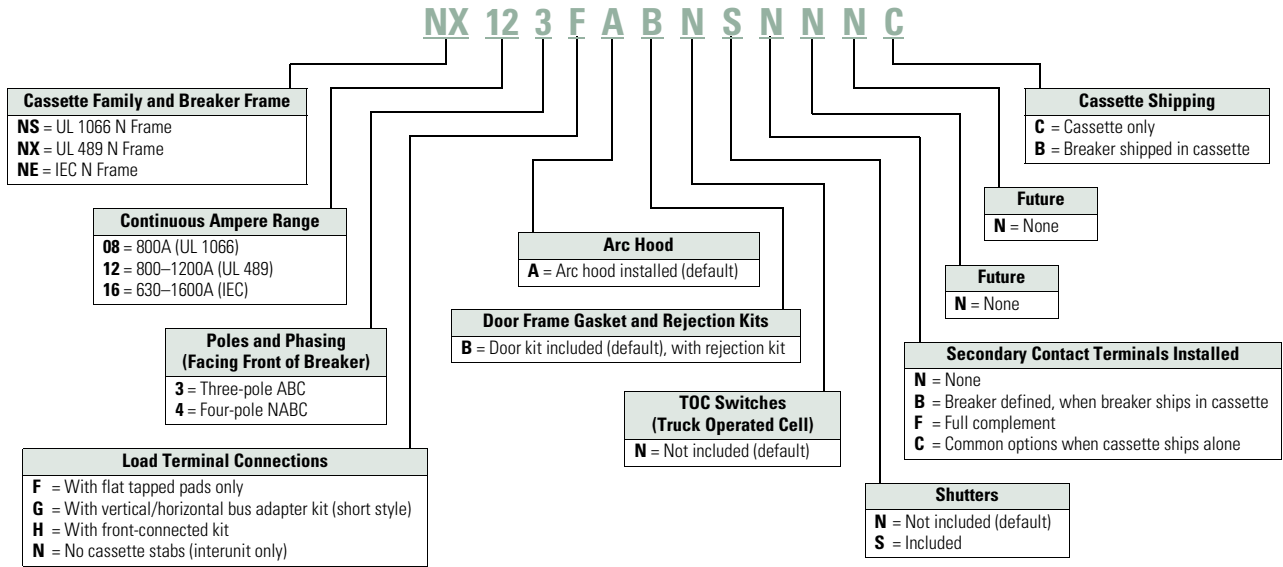

Product Selection

Series NRX Low Voltage Power Breakers

Breaker Frame	Industry Standard	Fault Current Rating (kAIC)	Frame Rating in Amperes	Poles	Mounting	Trip Unit	Rating Plug	Part Number ②
N	UL 1066	42	800	3	Drawout ①	520 LSI (No ZSI)	800	NSS4083W528
N	UL 1066	42	800	4	Fixed	520 LSI (No ZSI)	800	NSS4084B528
N	UL 1066	50	800	3	Drawout ①	520 LSI (No ZSI)	800	NSS5083W528
N	UL 1066	50	800	4	Fixed	520 LSI (No ZSI)	800	NSS5084B528
N	UL 1066	65	800	3	Drawout ①	520 LSI (No ZSI)	800	NSS6083W528
N	UL 1066	65	800	3	Fixed	520 LSI (No ZSI)	800	NSS6083B528
N	UL 1066	65	800	4	Drawout ①	520 LSI (No ZSI)	800	NSS6084W528
N	UL 1066	65	800	4	Fixed	520 LSI (No ZSI)	800	NSS6084B528
N	UL 489	42	800	3	Drawout ①	520 LSI (No ZSI)	800	NXS4083W528
N	UL 489	42	1200	4	Drawout ①	520 LSI (No ZSI)	1200	NXS4124W528
N	UL 489	50	800	3	Fixed	520 LSI (No ZSI)	800	NXS5083B528
N	UL 489	50	1200	4	Fixed	520 LSI (No ZSI)	1200	NXS5124B528
N	UL 489	65	800	3	Drawout ①	520 LSI (No ZSI)	800	NXS6083W528
N	UL 489	65	800	4	Fixed	520 LSI (No ZSI)	800	NSS6084B528
N	UL 489	65	1200	3	Drawout ①	520 LSI (No ZSI)	1200	NXS6123W528
N	UL 489	65	1200	4	Fixed	520 LSI (No ZSI)	1200	NXS6124B528
N	IEC	42	630	3	Drawout ①	520 LSI (No ZSI)	630	NES4073W527
N	IEC	42	1600	4	Drawout ①	520 LSI (No ZSI)	1600	NES4164W52D
N	IEC	50	630	3	Fixed	520 LSI (No ZSI)	630	NES5073B527
N	IEC	50	1600	4	Fixed	520 LSI (No ZSI)	1600	NES5164B52D
N	IEC	65	630	3	Drawout ①	520 LSI (No ZSI)	630	NES6073W527
N	IEC	65	800	4	Fixed	520 LSI (No ZSI)	800	NES6084B528
N	IEC	65	1250	3	Fixed	520 LSI (No ZSI)	1250	NES6133B52C
N	IEC	65	1600	4	Drawout ①	520 LSI (No ZSI)	1600	NES6164W52D

Notes

- ① See Page V9-T1-34 for cassette selection for drawout breakers.
- ② See selection above for accessories in positions 12–20.

Magnum Low Voltage Power Breakers**Features**

- Rated up to 6300A with interrupting ratings up to 200 kAIC and withstand ratings up to 100 kAIC
- Magnum® DS is UL 1066 listed for one-half second short-time withstand rating, and rated for 30 cycles. It is a switchgear class product to meet UL 1558 switchgear standards
- Magnum SB is a UL 1066 listed product with one-half second short-time withstand rating at three cycles to meet switchboard class product specifications, such as UL 891
- Magnum DS MDDX is the highest interrupting performance in a non-current limiting breaker construction rated up to 200 kAIC with 100 kAIC short-time withstand
- The Magnum DS, Magnum SB and Magnum IEC lines all offer the smallest double narrow 4000A frame available

Magnum Low Voltage Power Breakers

Catalog Number Selection

Magnum ANSI/UL Low Voltage Power Breakers

MD S 4 12 3 V E A 06 MU A W C H N E H K L A X

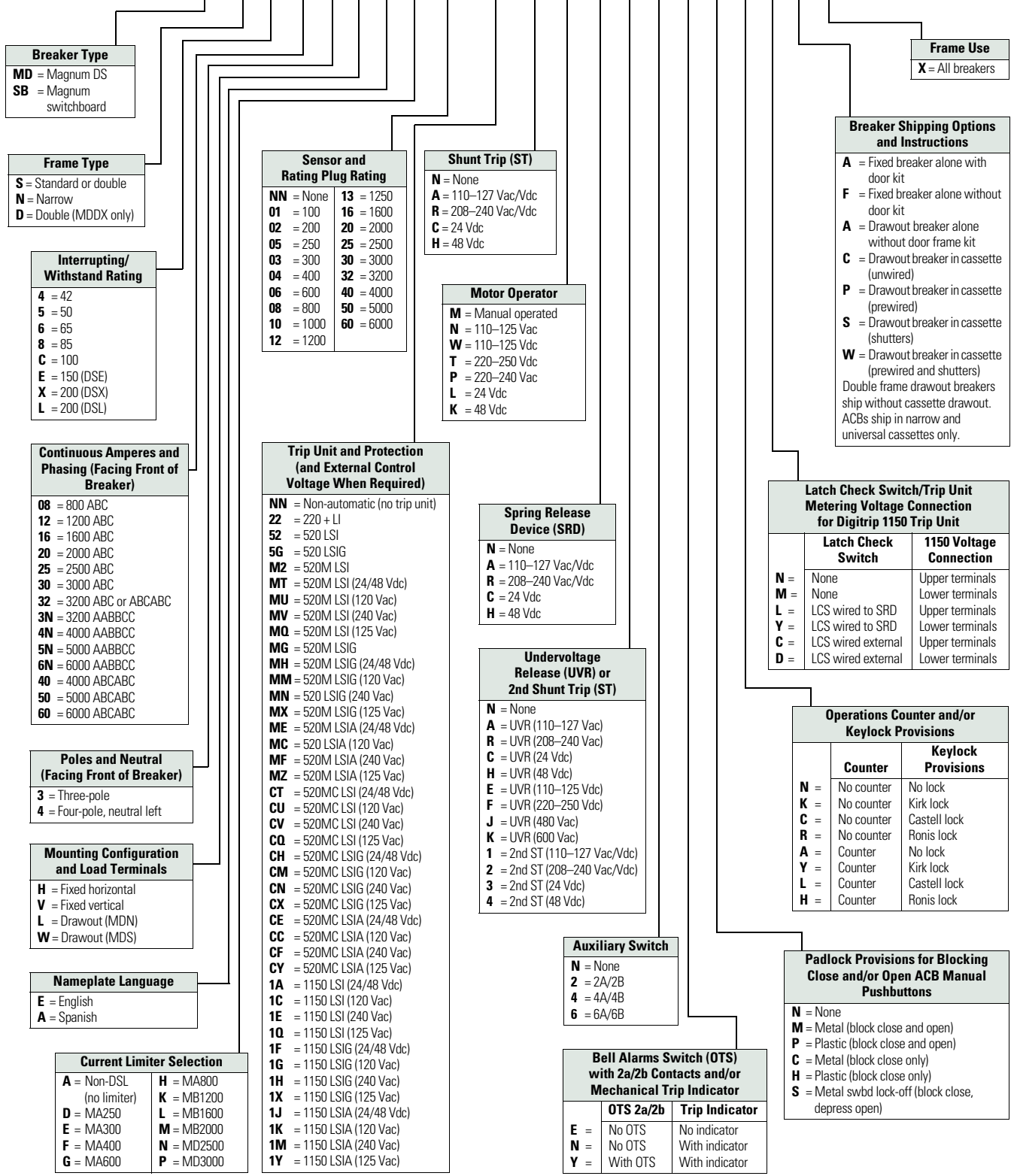

Breaker Type

MD = Magnum DS
SB = Magnum switchboard

Frame Type

S = Standard or double
N = Narrow
D = Double (MDDX only)

Interrupting/Withstand Rating

4 = 42
5 = 50
6 = 65
8 = 85
C = 100
E = 150 (DSE)
X = 200 (DSX)
L = 200 (DSL)

Continuous Amperes and Phasing (Facing Front of Breaker)

08 = 800 ABC
12 = 1200 ABC
16 = 1600 ABC
20 = 2000 ABC
25 = 2500 ABC
30 = 3000 ABC
32 = 3200 ABC or ABCABC
3N = 3200 AABBC
4N = 4000 AABBC
5N = 5000 AABBC
6N = 6000 AABBC
40 = 4000 ABCABC
50 = 5000 ABCABC
60 = 6000 ABCABC

Poles and Neutral (Facing Front of Breaker)

3 = Three-pole
4 = Four-pole, neutral left

Mounting Configuration and Load Terminals

H = Fixed horizontal
V = Fixed vertical
L = Drawout (MDN)
W = Drawout (MDS)

Nameplate Language

E = English
A = Spanish

Current Limiter Selection

A = Non-DSL (no limiter)	H = MA800
D = MA250	K = MB1200
E = MA300	L = MB1600
F = MA400	M = MB2000
G = MA600	N = MD2500
	P = MD3000

Sensor and Rating Plug Rating

NN = None	13 = 1250
01 = 100	16 = 1600
02 = 200	20 = 2000
05 = 250	25 = 2500
03 = 300	30 = 3000
04 = 400	32 = 3200
06 = 600	40 = 4000
08 = 800	50 = 5000
10 = 1000	60 = 6000
12 = 1200	

Shunt Trip (ST)

N = None
A = 110–127 Vac/Vdc
R = 208–240 Vac/Vdc
C = 24 Vdc
H = 48 Vdc

Motor Operator

M = Manual operated
N = 110–125 Vac
W = 110–125 Vdc
T = 220–250 Vdc
P = 220–240 Vac
L = 24 Vdc
K = 48 Vdc

Trip Unit and Protection (and External Control Voltage When Required)

NN = Non-automatic (no trip unit)
22 = 220 + LI
52 = 520 LSI
5G = 520 LSIG
M2 = 520M LSI
MT = 520M LSI (24/48 Vdc)
MU = 520M LSI (120 Vac)
MV = 520M LSI (240 Vac)
MQ = 520M LSI (125 Vac)
MG = 520M LSIG
MH = 520M LSIG (24/48 Vdc)
MM = 520M LSIG (120 Vac)
MN = 520 LSIG (240 Vac)
MX = 520M LSIG (125 Vac)
ME = 520M LSIA (24/48 Vdc)
MC = 520 LSIA (120 Vac)
MF = 520M LSIA (240 Vac)
MZ = 520M LSIA (125 Vac)
CT = 520MC LSI (24/48 Vdc)
CU = 520MC LSI (120 Vac)
CV = 520MC LSI (240 Vac)
CQ = 520MC LSI (125 Vac)
CH = 520MC LSIG (24/48 Vdc)
CM = 520MC LSIG (120 Vac)
CN = 520MC LSIG (240 Vac)
CX = 520MC LSIG (125 Vac)
CE = 520MC LSIA (24/48 Vdc)
CC = 520MC LSIA (120 Vac)
CF = 520MC LSIA (240 Vac)
CY = 520MC LSIA (125 Vac)
1A = 1150 LSI (24/48 Vdc)
1C = 1150 LSI (120 Vac)
1E = 1150 LSI (240 Vac)
1Q = 1150 LSI (125 Vac)
1F = 1150 LSIG (24/48 Vdc)
1G = 1150 LSIG (120 Vac)
1H = 1150 LSIG (240 Vac)
1X = 1150 LSIG (125 Vac)
1J = 1150 LSIA (24/48 Vdc)
1K = 1150 LSIA (120 Vac)
1M = 1150 LSIA (240 Vac)
1Y = 1150 LSIA (125 Vac)

Spring Release Device (SRD)

N = None
A = 110–127 Vac/Vdc
R = 208–240 Vac/Vdc
C = 24 Vdc
H = 48 Vdc

Undervoltage Release (UVR) or 2nd Shunt Trip (ST)

N = None
A = UVR (110–127 Vac)
R = UVR (208–240 Vac)
C = UVR (24 Vdc)
H = UVR (48 Vdc)
E = UVR (110–125 Vdc)
F = UVR (220–250 Vdc)
J = UVR (480 Vac)
K = UVR (600 Vac)
1 = 2nd ST (110–127 Vac/Vdc)
2 = 2nd ST (208–240 Vac/Vdc)
3 = 2nd ST (24 Vdc)
4 = 2nd ST (48 Vdc)

Auxiliary Switch

N = None
2 = 2A/2B
4 = 4A/4B
6 = 6A/6B

Bell Alarms Switch (OTS) with 2a/2b Contacts and/or Mechanical Trip Indicator

	OTS 2a/2b	Trip Indicator
E =	No OTS	No indicator
N =	No OTS	With indicator
Y =	With OTS	With indicator

Frame Use

X = All breakers

Breaker Shipping Options and Instructions

A = Fixed breaker alone with door kit
F = Fixed breaker alone without door kit
A = Drawout breaker alone without door frame kit
C = Drawout breaker in cassette (unwired)
P = Drawout breaker in cassette (prewired)
S = Drawout breaker in cassette (shutters)
W = Drawout breaker in cassette (prewired and shutters)
Double frame drawout breakers ship without cassette drawout. ACBs ship in narrow and universal cassettes only.

Latch Check Switch/Trip Unit Metering Voltage Connection for Digitrip 1150 Trip Unit

	Latch Check Switch	1150 Voltage Connection
N =	None	Upper terminals
M =	None	Lower terminals
L =	LCS wired to SRD	Upper terminals
Y =	LCS wired to SRD	Lower terminals
C =	LCS wired external	Upper terminals
D =	LCS wired external	Lower terminals

Operations Counter and/or Keylock Provisions

	Counter	Keylock Provisions
N =	No counter	No lock
K =	No counter	Kirk lock
C =	No counter	Castell lock
R =	No counter	Ronis lock
A =	Counter	No lock
Y =	Counter	Kirk lock
L =	Counter	Castell lock
H =	Counter	Ronis lock

Padlock Provisions for Blocking Close and/or Open ACB Manual Pushbuttons

N = None
M = Metal (block close and open)
P = Plastic (block close and open)
C = Metal (block close only)
H = Plastic (block close only)
S = Metal swbd lock-off (block close, depress open)

1.1

Circuit Protection

Circuit Breakers

1 Magnum ANSI/UL Low Voltage Air Circuit Breaker Cassettes

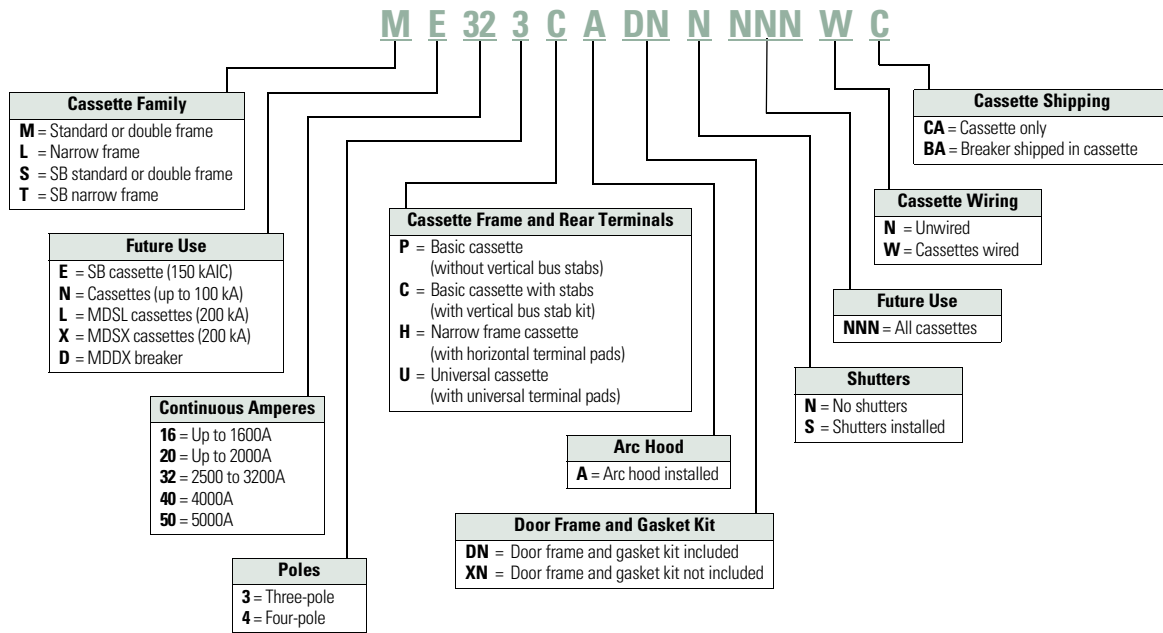

Magnum IEC Low Voltage Air Circuit Breakers

MW I 4 08 3 H E A - 02 22 A M A A 2 E M K L A X

Breaker Frame

I = Standard or double
N = Narrow
K = Special 1100 Vac ACB

Interrupting I_{cu}

4 = 40 kA
5 = 50 kA
6 = 65 kA
8 = 85 kA
C = 100 kA
2 = 25 kA (1100 Vac MWK)

Continuous Amperes and Phasing (Facing Front of Breaker)

08 = 800 ABC
10 = 1000 ABC
12 = 1250 ABC
16 = 1600 ABC
20 = 2000 ABC
25 = 2500 ABC
32 = 3200 ABC
4N = 4000 AABBC
5N = 5000 AABBC
6N = 6300 AABBC
40 = 4000 ABCABC
50 = 5000 ABCABC
60 = 6300 ABCABC

Poles and Neutral (Facing Front of Breaker)

3 = Three
4 = Four (neutral left)
R = Four (reserved for neutral right)

Mounting Configuration and Load Terminals

H = Fixed horizontal
V = Fixed vertical
L = Drawout horizontal

Nameplate Language

E = English
A = Spanish

Sensor and Rating Plug Rating

NN = None	13 = 1250
02 = 200	16 = 1600
05 = 250	20 = 2000
03 = 300	25 = 2500
04 = 400	30 = 3000
06 = 600	32 = 3200
07 = 630	40 = 4000
08 = 800	50 = 5000
10 = 1000	63 = 6300
12 = 1200	

Trip Unit Protection, (and External Control Voltage When Required)

NN = Non-automatic (no trip unit)
22 = 220 LI
52 = 520 LSI
5W = 520i LSIG
M2 = 520M LSI
MT = 520M LSI (24–48 Vdc)
MU = 520M LSI (120 Vac)
MV = 520M LSI (240 Vac)
MW = 520Mi LSIG
MJ = 520Mi LSIG (24–48 Vdc)
MK = 520Mi LSIG (120 Vac)
ML = 520Mi LSIG (240 Vac)
ME = 520M LSI/A (24–48 Vdc)
MC = 520M LSI/A (120 Vac)
MF = 520M LSI/A (240 Vac)
CT = 520MC LSI
CU = 520MC LSI
CV = 520MC LSI
CE = 520MC LSI/A
CC = 520MC LSI/A
CF = 520MC LSI/A
CJ = 520MCi LSIG
CK = 520MCi LSIG
CL = 520MCi LSIG
1W = 1150i LSI (24–48 Vdc)
1N = 1150i LSI (120 Vac)
1P = 1150i LSI (240 Vac)
1R = 1150i LSI/A (24–48 Vdc)
1S = 1150i LSI/A (120 Vac)
1T = 1150i LSI/A (240 Vac)

Auxiliary Switch

N = None
2 = 2A/2B
4 = 4A/4B
6 = 6A/6B

Shunt Trip Attachment (STA)

N = None
A = 110–127 Vac
R = 208–240 Vac
C = 24 Vdc
H = 48 Vdc

Motor Operator

M = Manual operated
N = 110–125 Vac
W = 110–125 Vdc
T = 220–250 Vdc
P = 220–250 Vac
L = 24 Vdc
K = 48 Vdc

Spring Release Device (SRD)

N = None
A = 110–127 Vac/Vdc
R = 208–240 Vac/Vdc
C = 24 Vdc
H = 48 Vdc

Undervoltage Release (UVR) or 2nd Shunt Trip Attachment (STA)

N = None
A = 110–127 Vac
R = 208–240 Vac
C = 24 Vdc
H = 48 Vdc
E = 110–125 Vdc
F = 220–250 Vdc
G = 32 Vdc
X = 380–415 Vac
J = 480 Vac
K = 600 Vac
1 = 2nd STA (110–127 Vac/Vdc)
2 = 2nd STA (208–250 Vac/Vdc)
3 = 2nd STA (24 Vdc)
4 = 2nd STA (48 Vdc)

Future Use

X = All ACBs

ACB Shipping Instructions

A = Fixed ACB with door kit
F = Fixed ACB without door kit
A = D/O ACB only without door kit
C = D/O ACB in cassette (unwired)
P = D/O ACB in cassette (prewired)
S = D/O ACB in cassette (shutters)
W = D/O ACB in cassette (prewired and shutters)
 Double frame D/O ACBs ship without cassette

Latch Checking Switch/Trip Unit Metering Voltage Connection for Digitrip 1150 Trip Unit

	Latch Check Switch	1150 Voltage Connection
N =	None	Upper terminals
M =	None	Lower terminals
L =	LCS wired to SRD	Upper terminals
Y =	LCS wired to SRD	Lower terminals
C =	LCS wired external	Upper terminals
D =	LCS wired external	Lower terminals

Operations Counter and/or Keylock Provisions

	Counter	Keylock Provisions
N =	No counter	No lock
K =	No counter	Kirk lock
C =	No counter	Castell lock
R =	No counter	Ronis lock
A =	Counter	No lock
T =	Counter	Kirk lock
L =	Counter	Castell lock
H =	Counter	Ronis lock

Padlock Provisions for Blocking Close and/or Open ACB Manual Pushbuttons

N = None
M = Metal (block close and open)
P = Plastic (block close and open)
C = Metal (block close only)
H = Plastic (block close only)

Bell Alarms Switch (OTS) with 2a/2b Contacts and/or Mechanical Trip Indicator

	OTS 2a/2b	Trip Indicator
E =	No OTS	No indicator
N =	No OTS	With indicator
Y =	With OT	With indicator

1.1

Circuit Protection

Circuit Breakers

1 Magnum IEC Low Voltage Air Circuit Breaker Cassettes

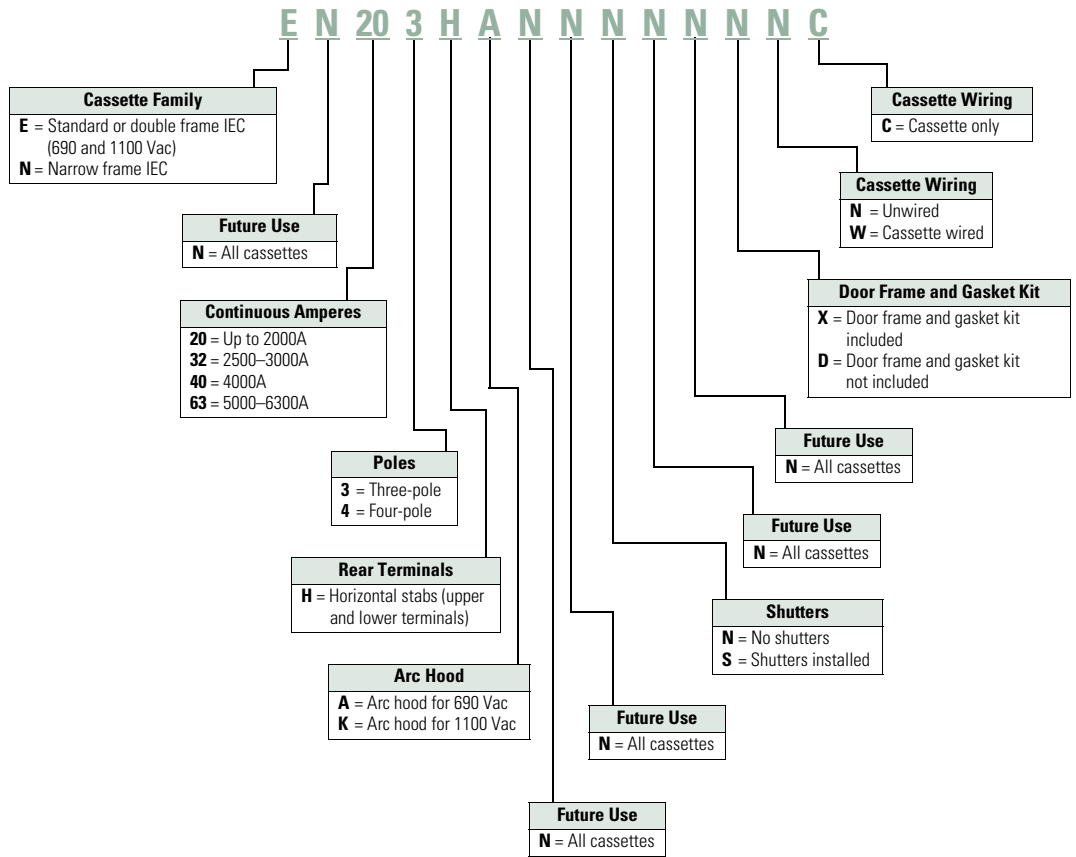

Product Selection

Magnum DS Switchgear Class UL 1066 Low Voltage Power Circuit Breakers

Frame Type	RMS Symmetrical Current Ratings kA 50/60 Hz ^①			Short Time Current Rating	Frame Amperes	Breaker Type ^②	
	Interrupting at 254 Vac	Interrupting at 508 Vac	Interrupting at 635 Vac				
Narrow	42	42	42	42	800	MDN-408	
	50	50	50	50		MDN-508	
	65	65	65	65		MDN-608	
	100	100	65	20		MDN-C08	
Standard	42	42	42	42	800	MDS-408	
	65	65	65	65		MDS-608	
	85	85	85	85		MDS-808	
	100	100	100	85		MDS-C08	
	200	200	200	—		MDS-L08 ^③	
Narrow	42	42	42	42	1600	MDN-416	
	50	50	50	50		MDN-516	
	65	65	65	65		MDN-616	
	100	100	65	30		MDN-C16	
Standard	65	65	65	65	1600	MDS-616	
	85	85	85	85		MDS-816	
	100	100	100	85		MDS-C16	
	200	200	200	—		MDS-L16 ^③	
	200	200	④	30		MDS-X16 ^⑤	
Narrow	65	65	65	65	2000	MDN-620	
	100	100	65	35		MDN-C20	
Standard	65	65	65	65	2000	MDS-620	
	85	85	85	85		MDS-820	
	100	100	100	85		MDS-C20	
	200	200	200	—		MDS-L20 ^③	
	200	200	④	30		MDS-X20 ^⑤	
	65	65	65	65		3200	MDS-632
85	85	85	85	MDS-832			
100	100	100	85	MDS-C32			
Double	200	200	④	50	3200	MDS-X32 ^⑤	
Double (N)	85	85	④	85	4000	MDN-840	
	100	100	④	100		MDN-C40	
Double	85	85	85	85	4000	MDS-840	
	100	100	100	100		MDS-C40	
	200	200	④	50		MDS-X40 ^⑤	
	200	200	④	100	4000	MDD-X40	
	85	85	85	85		5000	MDS-850
	100	100	100	100			MDS-C50
	200	200	④	50	6000	MDS-X50 ^{⑤⑦}	
	200	200	④	100		MDD-X50	
	100	100	100	100		MDS-C60 ^⑦	
	200	200	④	100		MDD-X60	

Notes

- ① Interrupting ratings shown based on breaker equipped with integral Digitrip RMS trip unit. Interruption ratings for non-automatic breakers are equal to the published short time current rating. These interruption ratings are based on the standard duty cycle consisting of an open operation, a 15-second interval and a close-open operation, in succession, with delayed tripping in case of short-delay devices. The standard duty cycle for short time ratings consists of maintaining the rated current for two periods of 1/2 seconds each, with a 15-second interval of zero current between the two periods.
- ② See **Page V9-T1-40** for selection of trip unit and accessories. See **Page V9-T1-40** for cassette selection for drawout breakers.
- ③ Magnum MDSL current limiting power circuit breaker with integral current limiters. Current limiter selected determines short time and maximum instantaneous trip rating. Maximum voltage rating is 600 Vac.
- ④ Product to be tested. Contact Eaton for product rating.
- ⑤ Magnum MDSX current limiting power circuit breaker with fast opening contacts.
- ⑥ Contact Eaton for availability.
- ⑦ Breaker applied in a tested fan-cooled enclosure.

Magnum SB Switchboard Class UL 1066 Insulated Case Low Voltage Power Circuit Breakers

Frame Type	RMS Symmetrical Current Ratings kA 50/60 Hz ^①			Short Time Current Rating	Frame Amperes	Breaker Type ^②
	Interrupting at 254 Vac	Interrupting at 508 Vac	Interrupting at 635 Vac			
Narrow	50	50	35	20	800	SBN-508
	65	65	42	20		SBN-608
	100	100	65	20		SBN-C08
Standard	65	65	65	20	800	SBS-608
	100	100	85	20		SBS-C08
	200	150	②	30		SBS-E08 ^③
Narrow	50	50	35	25	1200	SBN-512
	65	65	42	25		SBN-612
	100	100	65	25		SBN-C12
Standard	65	65	65	25	1200	SBS-612
	100	100	85	25		SBS-C12
	200	150	②	30		SBS-E12 ^③
Narrow	50	50	35	30	1600	SBN-516
	65	65	42	30		SBN-616
	100	100	65	30		SBN-C16
Standard	65	65	65	30	1600	SBS-616
	100	100	85	30		SBS-C16
	200	150	②	30		SBS-E16 ^③
Narrow	65	65	65	35	2000	SBN-620
	100	100	65	35		SBN-C20
Standard	65	65	65	35	2000	SBS-620
	100	100	85	35		SBS-C20
	200	150	②	30		SBS-E20 ^③
Narrow	65	65	65	45	2500	SBS-625
	100	100	85	45		SBS-C25
Double	200	150	②	50		SBS-E25 ^③
Standard	65	65	65	50	3000	SBS-630
	100	100	85	50		SBS-C30
Double	200	150	②	50		SBS-E30 ^③
Double (N)	85	85	③	85	4000	SBN-840
	100	100	③	100		SBN-C40
Double	85	85	85	85	5000	SBS-840
	100	100	100	100		SBS-C40
	200	150	②	50		SBS-E40 ^③
Double	85	85	85	85	5000	SBS-850
	100	100	100	100		SBS-C50
Double	200	150	②	50	6000	SBS-E50 ^{③④}
	100	100	100	100		SBS-C60 ^④

Notes

- ① Interrupting ratings shown based on breaker equipped with integral Digitrip RMS trip unit. Interruption ratings for non-automatic breakers are equal to the published short time current rating. These interruption ratings are based on the standard duty cycle consisting of an open operation, a 15-second interval and a close-open operation, in succession, with delayed tripping in case of short-delay devices. The standard duty cycle for short time ratings consists of maintaining the rated current for two periods of 1/2 seconds each, with a 15-second interval of zero current between the two periods.
- ② Product to be tested. Contact Eaton for product rating.
- ③ Magnum SBSE current limiting power circuit breaker with fast opening contacts.
- ④ Breaker applied in a tested fan-cooled enclosure.

Magnum IEC 60947-2 Rated Low Voltage Air Circuit Breakers

Frame Amperes	Breaker Type	Frame Type	rms Symmetrical Current Ratings kA ^①			Withstand Rating I _{CW} 1-Sec/3-Sec	Fixed Internal Inst. Trip	Available Current Sensor and Rating Plugs for Digitrip RMS Trip Unit (Establishes Breaker I _n Rating)
			Interrupting at 240 Vac I _{CU} = I _{CS}	Interrupting at 440 Vac I _{CU} = I _{CS}	Interrupting at 690 Vac I _{CU} = I _{CS}			
800	MWN-408	Narrow	40	40	40	40/—	—	200, 250, 300, 400, 630, 800
	MWN-508	Narrow	50	50	50	50/—	—	
	MWN-608	Narrow	65	65	65	65/40	—	
	MWI-608	Standard	65	65	65	65/—	—	
	MWI-808	Standard	85	85	85	85/65	—	
	MWI-C08	Standard	100	100	85	85/65	85	
1000	MWN-410	Narrow	40	40	40	40/—	—	200, 250, 300, 400, 630, 800, 1000
	MWN-510	Narrow	50	50	50	50/—	—	
	MWN-610	Narrow	65	65	65	65/40	—	
	MWI-610	Standard	65	65	65	65/—	—	
	MWI-810	Standard	85	85	85	85/65	—	
	MWI-C10	Standard	100	100	85	85/65	85	
1250	MWN-412	Narrow	40	40	40	40/—	—	200, 250, 300, 400, 630, 800, 1000, 1250
	MWN-512	Narrow	50	50	50	50/—	—	
	MWN-612	Narrow	65	65	65	65/40	—	
	MWI-612	Standard	65	65	65	65/—	—	
	MWI-812	Standard	85	85	85	85/65	—	
	MWI-C12	Standard	100	100	85	85/65	85	
1600	MWN-516	Narrow	50	50	50	50/—	—	200, 250, 300, 400, 630, 800, 1000, 1250, 1600
	MWN-616	Narrow	65	65	65	65/40	—	
	MWI-616	Standard	65	65	65	65/—	—	
	MWI-816	Standard	85	85	85	85/65	—	
	MWI-C16	Standard	100	100	85	85/65	85	
2000	MWN-520	Narrow	50	50	50	50/30	—	200, 250, 300, 400, 630, 800, 1000, 1250, 1600, 2000
	MWN-620	Narrow	65	65	65	65/40	—	
	MWI-620	Standard	65	65	65	65/50	—	
	MWI-820	Standard	85	85	85	85/65	—	
	MWI-C20	Standard	100	100	85	85/65	85	
2500	MWI-625	Standard	65	65	65	65/—	—	200, 250, 300, 400, 630, 800, 1000, 1250, 1600, 2000, 2500
	MWI-825	Standard	85	85	85	85/65	—	
	MWI-C25	Standard	100	100	85	85/65	85	
3200	MWI-632	Standard	65	65	65	65/50	—	200, 250, 300, 400, 630, 800, 1000, 1250, 1600, 2000, 2500, 3200
	MWI-832	Standard	85	85	85	85/65	—	
	MWI-C32	Standard	100	100	85	85/65	85	
4000	MWI-64N	Double	65	65	65	65/—	—	2000, 2500, 3200, 4000
	MWI-84N	Double	85	85	85	85/—	—	
	MWI-C4N	Double	100	100	100	100/—	—	
5000	MWI-85N	Double	85	85	85	85/—	—	2500, 3200, 4000, 5000
	MWI-C5N	Double	100	100	100	100/—	—	
6300	MWI-86N	Double	85	85	85	85/—	—	3200, 4000, 5000, 6300
	MWI-C6N	Double	100	100	100	100/—	—	

Note

^① Interrupting ratings shown based on breaker equipped with integral Digitrip RMS trip unit. Interruption ratings for non-automatic breakers are equal to the published breaker I_{CW} rating.

Product Overview**Fuse Blocks and Fuse Holders**

Description	C350 Series
	Page V9-T1-45
Technical Data	
Number of poles	Up to 3
Mounting	35 mm flat or 32 mm asymmetrical DIN rail (with optional adapter)
Terminal ratings	600V, 30A
Housing construction	Thermoplastic UL 94V0 flammability rating
Clip/terminal construction	Tin-plated copper alloy
Screw/pressure plate construction	Zinc-plated steel
Dielectric strength	1200V
Approvals	
	UL, CSA

For our complete product offering, see Volume 4—Circuit Protection, CA08100005E.

C350 Series Fuse Blocks and Fuse Holders



Features

- Space-saving design
- Rated 600V, 30A
- UL approved for motor loads

Product Selection

C350 Series

Fuse Blocks and Fuse Holders

Wire Termination	Number of Poles	250V			600V				
		30A Catalog Number	Carton Qty.	60A Catalog Number	Carton Qty.	30A Catalog Number	Carton Qty.	60A Catalog Number	Carton Qty.
Class H Fuse Holders									
Single collar (box lug)—sized to ampere rating	1	W231HA	10	W261HA	10	W631HA	10	W661HA	1
	2	W232HA	5	W262HA	5	W632HA	5	W662HA	1
	3	W233HA	5	W263HA	5	W633HA	1	W663HA	2
Class M Fuse Holders									
Combination of double quick-connect, 20A max., and binding head screw, #10 max., Cu/Al	1	—	—	—	—	WM631F	10	—	—
	2	—	—	—	—	WM632F	8	—	—
	3	—	—	—	—	WM633F	6	—	—
Combination of double quick-connect, 20A max., and pressure plate screw, #10 max., Cu only	1	—	—	—	—	WM631G	10	—	—
	2	—	—	—	—	WM632G	8	—	—
	3	—	—	—	—	WM633G	6	—	—
Class R Fuse Holders									
Single collar (box lug)—sized to ampere rating	1	WR231HA	10	—	—	WR631HA	10	—	—
	2	—	—	—	—	WR632HA	5	—	—
	3	WR233HA	5	WR263HA	1	WR633HA	5	WR663HA	5
Combination of double quick-connect, 20A max., and binding head screw, #10 max., Cu/Al	1	—	—	—	—	—	—	—	—
	2	—	—	—	—	WMR632F	1	—	—
	3	—	—	—	—	WMR633F	6	—	—
Combination of double quick-connect, 20A max., and pressure plate screw, #10 max., Cu only	1	—	—	—	—	WMR631G	10	—	—
	3	—	—	—	—	WMR633G	6	—	—
Class R Fuse Holder, Type WRR Control Transformer Fuse Block									
Combination of double quick-connect, 20A max., and pressure plate screw, #14–#10 Cu only	3	—	—	—	—	WRR633G	6	—	—

Open Rotary Disconnects

Product Overview

Rotary Disconnect Switch Selection Guide



**R5 Series
Non-Fusible 16–80A**



**R9 Series
Non-Fusible 30–100A Compact**



**R9 Series
Non-Fusible 100–1200A**

Description

Page V9-T1-48

Page V9-T1-50

Page V9-T1-52

Product Description

R5 Series (UL 508 listed) products are manually operated modular switches. Load break switching and isolation provide safety solutions for any low voltage circuit, particularly for machine and control circuits. The R5 Series products are manual motor controllers suitable as motor disconnect.

The R9 Series (UL 98 listed) non-fusible 30–100A compact range ensures making or breaking on load and safety isolation for low voltage electrical circuits, particularly for machine control circuits up to 600V.

The R9 Series (UL 98 listed) non-fusible 100–1200A are manually operated multipole load-break switches. Quick-make, quick-break design provides safety isolation for any low voltage circuit.

Approvals

UL 508 listed, Guide NLRV, File E165150
CSA C22.2 No. 14, File 217736
IEC 60947-3, EN 60947-3
CCC

UL 98, File E222859
CSA 22.2 No. 4, File 217736
IEC 60947-3
EN 60947-3

UL 98, File E222859
CSA 22.2 No. 4, File 217736
IEC 60947-3
EN 60947-3



**R9 Series
Fusible 30–800A**



**R9 Series
DC Rated Disconnects**



Manual Transfer Switches

Description

Page V9-T1-54

Page V9-T1-59

Page V9-T1-60

Product Description

R9 Series (UL 98 listed) Fusible 30–800A manual operated multi-pole fusible disconnect switches use double break contacts per pole that ensure complete isolation of the fuse when the switch is in the OFF position.

When installed with fuses, they provide protection for low voltage electrical installations against short circuit and overload.

UL listed disconnect switches 600 Vdc for photovoltaic applications 100 to 400A

R9 Series (UL 98 listed) DC rated disconnects are manually operated multi-pole load break switches. They provide safety isolation for any low voltage circuit in a photovoltaic application.

R9 Series (UL 98 listed) non-fusible disconnects are heavy-duty manual transfer switches, they transfer load manually between two low voltage circuits and provide safety disconnection.

These switches are extremely durable and are tested and approved for use in the most demanding applications as resistive load or total system applications.

Approvals

UL 98, File E222859 for 30 to 800A ratings
UL 489, File E305341 for H Frame switches
CSA 22.2 No. 4, File 217736
CSA 22.2 No. 5, File 217736, H Frame only
IEC 60947-1, EN 60947-1
IEC 60947-3, EN 60947-3
CE mark
NFPA® 79

UL 98, cULus®, File E222859
CSA 22.2 No. 4, File 217736 ①
IEC 60947-3
EN 60947-3
IEC 60-364-7-712 (Rules for the installations and sites special—photovoltaic applications)

UL 98, cULus, File E222859
UL 1008 (2011)
CSA 22.2 No. 4, File 217736
IEC 60947-3
EN 60947-3

Note

① Q4 2010

Catalog Number Selection

Disconnects

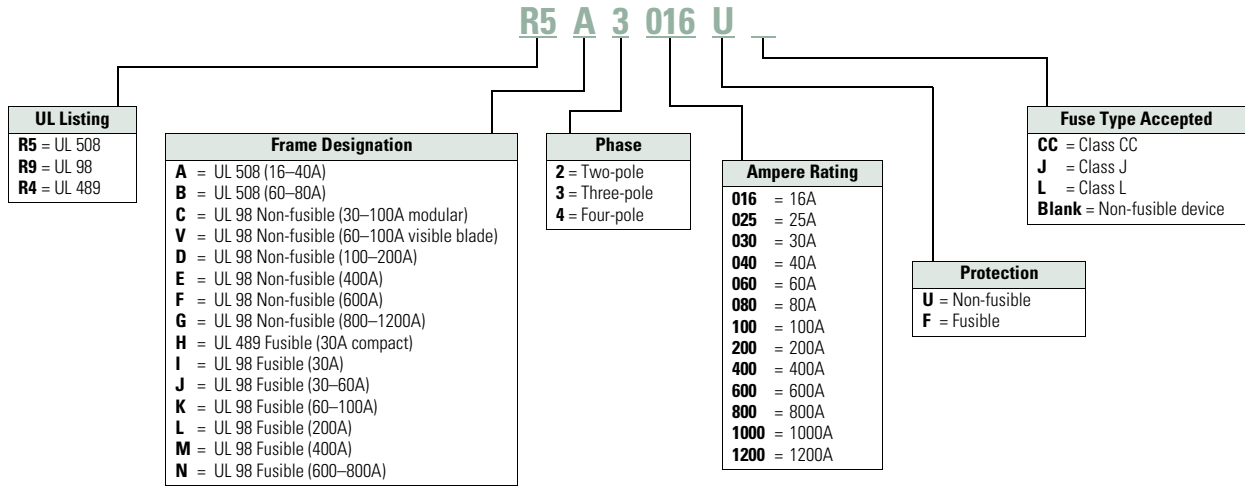

External Handles

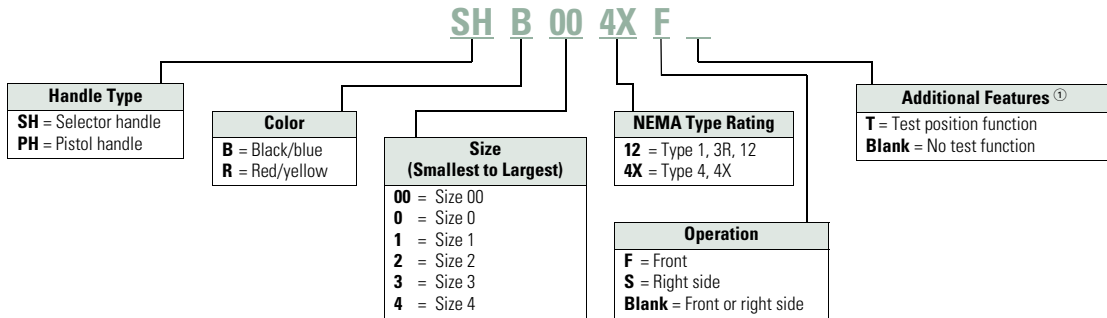

Shafts

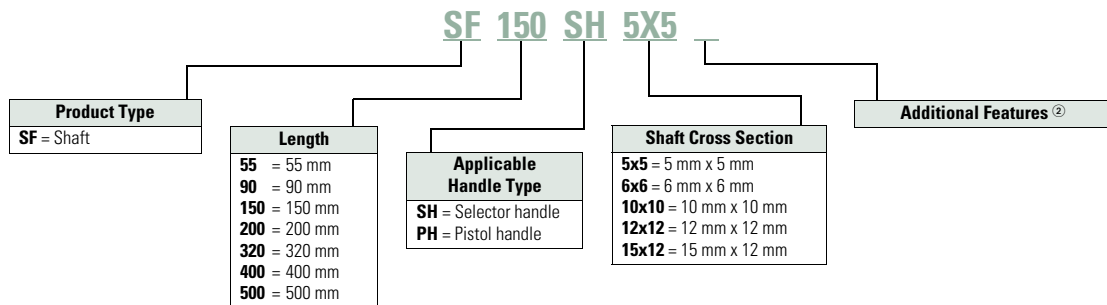

Notes

- ① **HV** at the end of some catalog numbers indicates use with H and V switches only. Not all handles are designed to go with all disconnects. Consult specific section of the catalog for available options.
- ② **H** at the end of some catalog numbers indicates use with H Frame switches only. Not all shafts are designed to go with all disconnects. Consult specific section of the catalog for available options.

1

R5 Series Non-Fusible 16–80A**Features**

- Up to 65 kAIC short-circuit rating
- Direct or external operation
- Compact footprint
- DIN rail or base mount
- Wide range of accessories
- Modular design
- Padlockable design (direct, toggle and external handles)

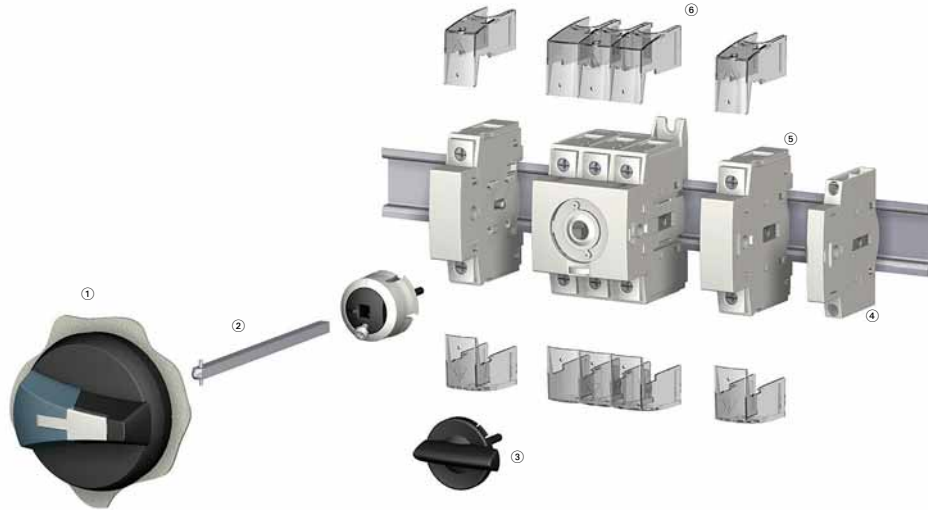
R5 Series Non-Fusible 16–80A**Product Identification**

- ① External front handle
- ② Shaft extension for external handle
- ③ Direct handle
- ④ Auxiliary contacts
- ⑤ Switched fourth-pole module
- ⑥ Terminal shroud

Note: For further details, please see the installation instructions supplied with each device.

Product Selection

Direct Operation



Switch body + Direct handle

External Operation



Switch body + Shaft + External handle

R5 Series



Ampere Rating	Three-Pole Toggle Switch Only ①	Three-Pole Rotary Switch Only	Direct Handle	Front and Right External Handle SH00 (Choose One)	Front and Right External Handle SH0 (Choose One)	Three-Position Front External Handle SH00 (Black) ②	Shaft for SH0 and SH00—5 x 5 mm—In (mm)
16	—	R5A3016U	DHR5	SH00 Black 3R, 12 SHB00N12	SH0 Black 3R, 12 SHB0N12	SH00 4, 4X I–0–II Open transition SHB00MTSOT	2.20 (55.5) SF55SH5X5
25	—	R5A3025U					
30	T5A3030U	R5A3030U					3.50 (90.0) SF90SH5X5
40	T5A3040U	R5A3040U					
60	T5B3060U	R5B3060U		SH00 Red 3R, 12 SHR00N12	SH0 Red 3R, 12 SHR0N12	SH00 4, 4X I–I–II–II Closed transition SHB00MTSCT	5.90 (150.0) SF150SH5X5
80	T5B3080U	R5B3080U		SH00 Black 4, 4X SHB00N4X	SH0 Black 4, 4X SHB0N4X		7.90 (200.0) SF200SH5X5
				SH00 Red 4, 4X SHR00N4X	SH0 Red 4, 4X SHR0N4X		12.60 (320.0) SF320SH5X5

Accessories



Ampere Rating	Switched Fourth-Pole Module	Unswitched Neutral Module	Auxiliary Contacts (Choose One)	Terminal Shrouds	Conversion Kit (Choose One) ②	Door Mounting Kit ③
16	S4PR516	UNMR5A	1NO + 1NC AC1NON	1P TS1R5A	6/8 pole CKR568	DMK
25	S4PR525					
30	S4PR530			3P TS3R5A	Changeover switch Open transition I–0–II	
40	S4PR540		2NO AC2N		MTSCKR50T	
60	S4PR560 ②	UNMR5B		1P TS1R5B		
80	S4PR580 ②			3P TS3R5B	Changeover switch Closed transition I–I–II–II MTSCKR5CT	

Notes

- ① Toggle version includes direct handle.
- ② Available Q2 2011.
- ③ Includes shaft and accessory cap.

1

Non-Fusible 30–100A Compact**Features**

- Rating three-pole from 30A to 100A
- Direct or external operation handle (padlockable in ON position)
- Double breaking per phase
- Small footprint

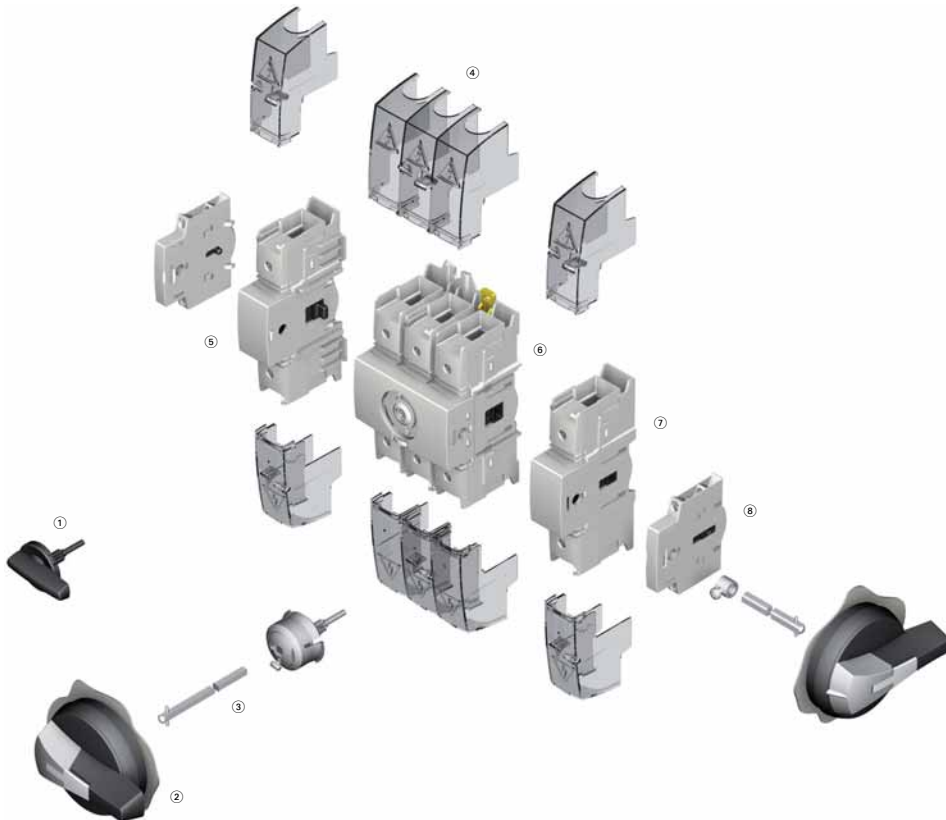
R9 Series Non-Fusible 30–100A Compact**Product Identification**

- ① Direct handle
- ② Door interlocked external handle
- ③ Shaft extension
- ④ Terminal shrouds
- ⑤ Unswitched neutral pole
- ⑥ Switch body
- ⑦ Switched fourth-pole module
- ⑧ Modular type auxiliary contacts

Note: For further details, please see the installation instructions supplied with each device.

Product Selection

Direct Operation



External Operation



R9 Series 30–100A

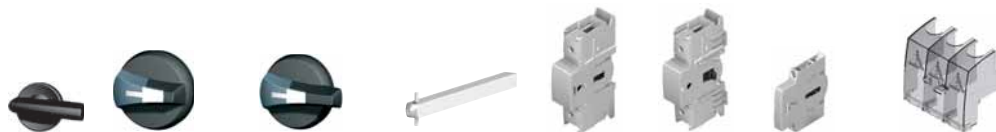

Ampere Rating (Frame)	Number of Poles	Switch Body Only	Direct Handle	Front and Right External Handle SH00 (Choose One)	Front and Right External Handle SH0 (Choose One)	Shaft for SH0 and SH00 Handles—In (mm) (Choose One)	Switched Fourth-Pole Module	Unswitched Neutral Module	Auxiliary Contacts (Choose One)	Terminal Shrouds (Choose One)
30 (C Frame)	3	R9C3030U	DHR9	SH00 Black 3R, 12 SHB00N12	SH0 Black 3R, 12 SHB0N12	2.20 (55.5) SF55SH5X5	S4PR930	Neutral UNMR9C	1NO + 1NC AC1N0NC	1P TS1R9
60 (C Frame)	3	R9C3060U		SH00 Red 3R, 12 SHR00N12	SH0 Red 3R, 12 SHR0N12	3.50 (90.0) SF90SH5X5	S4PR960		2NO AC2N	3P TS3R9CV
100 (C Frame)	3	R9C3100U		SH00 Black 4, 4X SHB00N4X	SH0 Black 4, 4X SHB0N4X	5.91 (150.0) SF150SH5X5	S4PR9100			
				SH00 Red 4 4X SHR00N4X	SH0 Red 4 4X SHR0N4X	7.87 (200.0) SF200SH5X5				
						12.60 (320.0) SF320SH5X5				

1

Non-Fusible 100–1200A**Features**

- High thermal and dynamic withstand ratings
- Arduous categories of applications
- High electrical and mechanical endurances

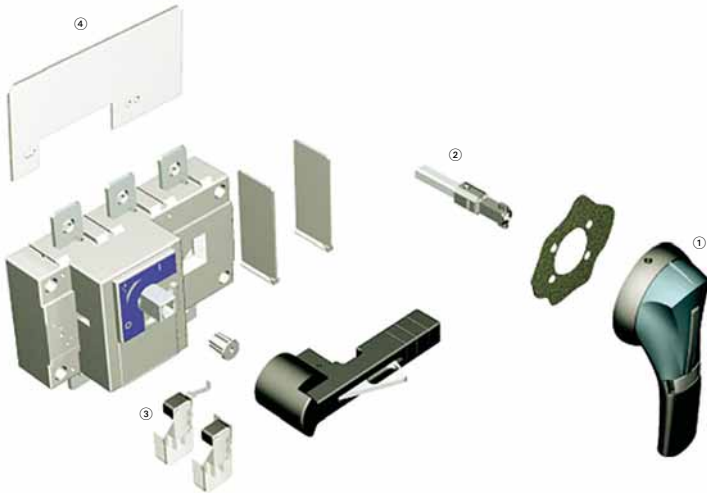
R9 Series Non-Fusible 100–1200A**Product Identification**

- ① External front handle
- ② Shaft extensions for external handle
- ③ Configurable U-type ACs, for pre-break and signalling or TEST
- ④ Terminal Screens

Note: For further details, please see the installation instructions supplied with each device.

Product Selection

Direct Operation

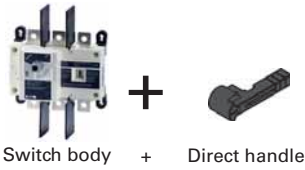

External Operation

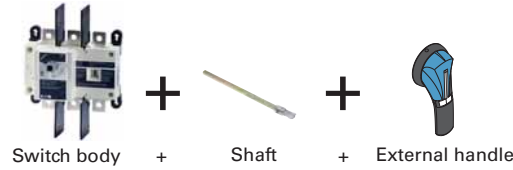

R9 Series Non-Fusible 100–1200A



Ampere Rating (Frame)	Number of Poles	Switch Body Only	Direct Handle	Door Interlocked External Pistol Handle (Choose One)	Shaft Extensions for External Handle—In (mm) (Choose One)	Auxiliary Contacts	Terminal Screens (Choose One)	Terminal Lugs ^③
100 (D Frame)	3	R9D3100U	DHR9DE	Size 2, Black 1, 3R, 12 Defeatable PHB2N12F	7.90 (200.0)	1NO + 1NC AC1N0NCDE AC1N0NCDELL	3-pole, Line side only	LK3R9DL
	4	R9D4100U			12.60 (320.0)		3-pole, Load side only	LK4R9DL
200 (D Frame)	3	R9D3200U	DHR9DE	Size 2, Red 1, 3R, 12 Defeatable PHR2N12F	15.70 (400.0)	2NO + 2NC AC2N0NCDE AC2N0NCDELL	3-pole, Line or load side	LK3R9DL
	4	R9D4200U			19.70 (500.0)		4-pole, Line or load side	LK4R9DL
400 (E Frame)	3	R9E3400U	DHR9DE	Size 2, Black 4, 4X Defeatable PHB2N4XF	19.70 (500.0)	1NO AC U Type AC1N0R9 ^②	3-pole, Line side only	LK3R9EM
	4	R9E4400U			7.90 (200.0)		3-pole, Load side only	LK4R9EM
600 (F Frame)	3	R9F3600U	DHR9FG	Size 3, Black 4, 4X Defeatable PHB3N4XF	7.90 (200.0)	1NC AC U Type AC1NCR9 ^②	3-pole, Line side only	LK3R9FN
	4	R9F4600U			12.60 (320.0)		3-pole, Load side only	LK4R9FN
800 (G Frame)	3	R9G3800U	DHR9FG	Size 3, Red 4, 4X Defeatable PHR3N4XF	12.60 (320.0)	1NO AC U Type AC1N0R9 ^②	3-pole, Line side only	LK6R9G
	4	R9G4800U			19.70 (500.0)		3-pole, Load side only	LK8R9G
1000 (G Frame)	3	R9G31000U	DHR9FG	Size 4, Black 4, 4X Defeatable PHB4N4XF	1.70 (400.0)	1NC AC U Type AC1NCR9 ^②	3-pole, Line side only	LK6R9G
	4	R9G41000U			19.7 (500.0)		3-pole, Load side only	LK8R9G
1200 (G Frame)	3	R9G31200U	DHR9FG	Size 4, Red 4, 4X Defeatable PHR4N4XF	19.7 (500.0)	1NO AC U Type AC1N0R9 ^②	3-pole, Line side only	LK6R9G
	4	R9G41200U			19.7 (500.0)		3-pole, Load side only	LK8R9G

Notes

- ① Top (line side) supplied as standard.
- ② Auxiliary contact requires holder (catalog number ACHFG) when used on F and G Frame switches (non-fusible 600–1200A).
- ③ Each catalog number is for line or load side. For both line and load, please order two sets.

1

Fusible 30–800A



Features

- Load break functionality
- Double break contacts
- Up to 200 kA short-circuit rating with Class CC, J or L fuses
- Compact footprints
- Defeatable pistol handles automatically re-latch when the panel door is closed
- Front or right side operation
- NFPA 79 compliant kits
- Two-, three- and four-pole devices

R9 Series Fusible 30–800A

R9 Fusible 30A/CC and 30A/J (H Frame)—
Direct and External Operation**Product Identification**

- ① External front handles
- ② Direct handle
- ③ Shaft extensions for external handles
- ④ Configurable U Type ACs, for pre-break and signaling or TEST

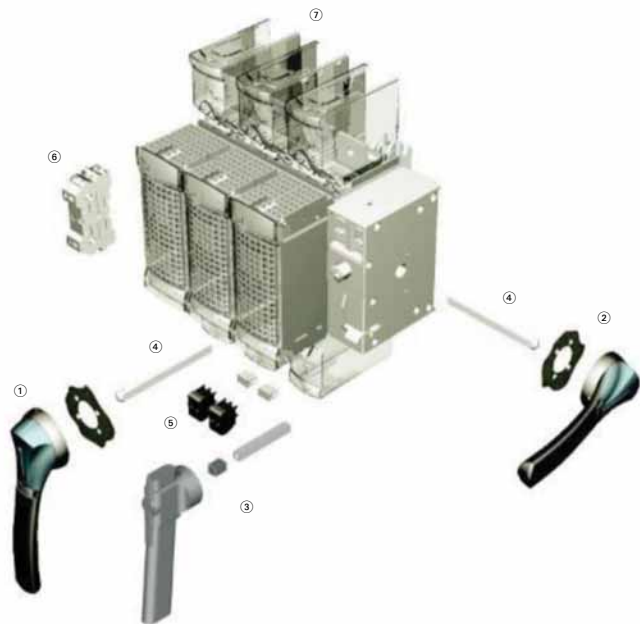
R9 Fusible 30A/J–800A/L (I–N Frames)—
Direct and External Operation**Product Identification**

- ① External front handles
- ② External right side handle (not applicable for N Frame 600/800A)
- ③ Direct handle
- ④ Shaft extensions for external handles
- ⑤ Configurable U Type ACs, for pre-break and signaling or TEST
- ⑥ Side auxiliary contacts
- ⑦ Terminal shrouds

Product Selection

Direct Operation



Switch body + Direct handle

External Operation

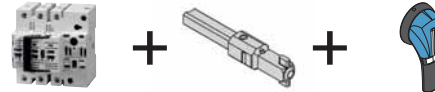

Switch body + Shaft + External handle

Front and Right Side Operation

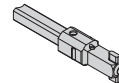

Ampere Rating (Frame) (Fuse Class)	Number of Poles	Switch Body Only	Direct Handle	External Selector Handle (Choose One)	Shaft Extension for Selector Handle Only (Choose One)	External Front Pistol Handle	External Right Side Pistol Handle
30 Compact (H Frame) (CC)	3	R4H3030FCC	DHR9HC	Black 1,3R,12 SHB0N12HV	7.90 (200.0) SF200SH5X5H	Black 1,3R,12 PHB1N12F	—
30 (H Frame) (CC)	3 + switched neutral	R4H3030FCCSN		Red 1,3R,12 SHR0N12HV	12.60 (320.0) SF320SH5X5H	Red 1,3R,12 PHR1N12F	
30 Compact (H Frame) (J)	3	R4H3030FJ	DHR9HJ	Black 4,4X SHB0N4XHV	15.70 (400.0) SF400SH5X5H	Black 4,4X PHB1N4XF	
30 (H Frame) (J)	3 + switched neutral	R4H3030FJSN		Red 4,4X SHR0N4XHV		Red 4,4X PHR1N4XF	
30 (I Frame) (CC)	3	R9I3030FCC	DHR9J2M	—	—		
	4	R9I4030FCC					
30 (J Frame) (J)	2	R9J2030FJ				Black 4,4X (w/ TEST Position) PHB1N4XFT	Black 4, 4X PHB1N4XS
	3	R9J3030FJ					
	4	R9J4030FJ					
60 ① (J Frame) (J)	2	R9J2060FJ				Red 4,4X (w/ TEST Position) PHR1N4XFT	Red 4, 4X PHR1N4XS
	3	R9J3060FJ					
	4	R9J4060FJ					

Note

① 100 kA short-circuit rating.

1.3

Circuit Protection

Rotary Disconnect Switches

1

Front and Right Side Operation, continued



Ampere Rating (Frame) (Fuse Class)	Number of Poles	Switch Body Only	Shaft Extensions for Pistol Handle Only In (mm) (Choose One)	NFPA 79 Kit	Auxiliary Contacts (Choose One)	S Type Auxiliary Contacts (Choose One)	Terminal Shrouds
30 Compact (H Frame) (CC)	3	R4H3030FCC	7.90 (200.0) SF200PH5X5	NFPA79H	1 AC NO AC1NOR9	—	Integral to switch
30 (H Frame) (CC)	3 + switched neutral	R4H3030FCCSN	12.60 (320.0) SF320PH5X5		1 AC NC AC1NCR		
30 Compact (H Frame) (J)	3	R4H3030FJ	15.70 (400.0) SF400PH5X5				
30 (H Frame) (J)	3 + switched neutral	R4H3030FJSN					
30 (I Frame) (CC)	3	R9I3030FCC	7.90 (200.0) SF200PH10X10	NFPA79JKL		1 AC NO + NC AC1N01NCJ2N	
	4	R9I4030FCC					
30 (J Frame) (J)	2	R9J2030FJ	12.60 (320.0) SF320PH10X10			2 AC NO + NC AC2N02NCJ2N	
	3	R9J3030FJ					
	4	R9J4030FJ	15.70 (400.0) SF400PH10X10				
60 [Ⓢ] (J Frame) (J)	2	R9J2060FJ				1 AC NO + NC w/ TEST AC1N01NCJ2NT	
	3	R9J3060FJ	19.70 (500.0) SF500PH10X10				
	4	R9J4060FJ				2 AC NO + NC w/ TEST AC2N02NCJ2NT	

Note

Ⓢ 100 kA short-circuit rating.

Front and Right Side Operation, continued



Ampere Rating (Frame) (Fuse Class)	Number of Poles	Switch Body Only	Direct Handle (Black)	External Front Pistol Handle (Choose One)	External Right Side Pistol Handle (Choose One)
60 ① (K Frame) (J)	2	R9K2060FJ	DHR9J2M	Black 1,3R,12 PHB2N12F	Black 4, 4X PHB2N4XS
	3	R9K3060FJ			
	4	R9K4060FJ			
100 (K Frame) (J)	2	R9K2100FJ		Red 1,3R,12 PHR2N12F	Red 4, 4X PHR2N4XS
	3	R9K3100FJ			
	4	R9K4100FJ			
200 (L Frame) (J)	2	R9L2200FJ		Black 4,4X PHB2N4XF	
	3	R9L3200FJ			
	4	R9L4200FJ			
400 (M Frame) (J)	3	R9M3400FJ		Red 4,4X PHR2N4XF	
	4	R9M4400FJ			
600 (N Frame) (J)	2	R9N2600FJ	DHR9N	Black 4, 4X PHB3N4XF	
	3	R9N3600FJ			
	4	R9N4600FJ			
800 (N Frame) (L)	2	R9N2800FL		Red 4,4X PHR3N4XF	
	3	R9N3800FL			
	4	R9N4800FL			

Note

① 200 kA short-circuit rating.

1.3

Circuit Protection

Rotary Disconnect Switches

1

Front and Right Side Operation, continued

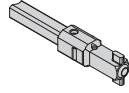

Ampere Rating (Frame) (Fuse Class)	Number of Poles	Switch Body Only	Shaft Extensions for External Handle In (mm) (Choose One)	NFPA 79 Kit	Auxiliary Contacts (Choose One)	Auxiliary Contacts (Choose One)	Terminal Shrouds
60 [Ⓢ] (K Frame) (J)	2	R9K2060FJ	7.90 (200.0)	NFPA79JKL	1 AC NO AC1NOR9	1 AC NO + NC AC1N01NCJ2N	Integral to switch
	3	R9K3060FJ	Pistol SF200PH10X10				
	4	R9K4060FJ					
100 (K Frame) (J)	2	R9K2100FJ	12.60 (320.0)	AC1NCR9	1 AC NC AC1NCR9	2 AC NO + NC AC2NO2NCJ2N	
	3	R9K3100FJ	Pistol SF320PH10X10				
	4	R9K4100FJ					
200 (L Frame) (J)	2	R9L2200FJ	15.70 (400.0)			1 AC NO + NC w/ TEST AC1N01NCJ2NT	TSR9L2
	3	R9L3200FJ	Pistol SF400PH10X10				TSR9L3
	4	R9L4200FJ	19.70 (500.0)				TSR9L4
400 (M Frame) (J)	3	R9M3400FJ	Pistol SF500PH10X10			2 AC NO + NC w/ TEST AC2NO2NCJ2NT	TSR9M3
	4	R9M4400FJ					TSR9M4
600 (N Frame) (J)	2	R9N2600FJ	7.90 (200.0)	NFPA79N		1 AC NO + NC AC1N01NCJ2N	TSR9N2
	3	R9N3600FJ	Pistol SF200PH12X12				TSR9N3
	4	R9N4600FJ					TSR9N4
800 (N Frame) (L)	2	R9N2800FL	12.60 (320.0)			2 AC NO + NC AC2NO2NCJ2N	TSR9N2
	3	R9N3800FL	Pistol SF320PH12X12				TSR9N3
	4	R9N4800FL	15.70 (400.0) Pistol SF400PH12X12				TSR9N4
			19.70 (500.0) Pistol SF500PH12X12				

Note

[Ⓢ] 200 kA short-circuit rating.

DC Rated Disconnects



Features

- Switching technology
- Up to 600 Vdc according to UL 98/CSA
- Up to 1000 Vdc according to IEC 947-3

R9 Series DC Rated Disconnects

Product Selection

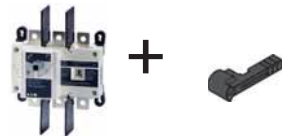

Switch body + Direct handle

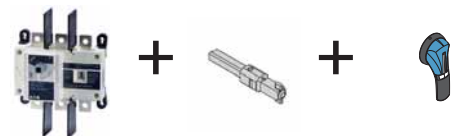

Switch body + Shaft + External handle

Front Operation—Three- and Four-Pole

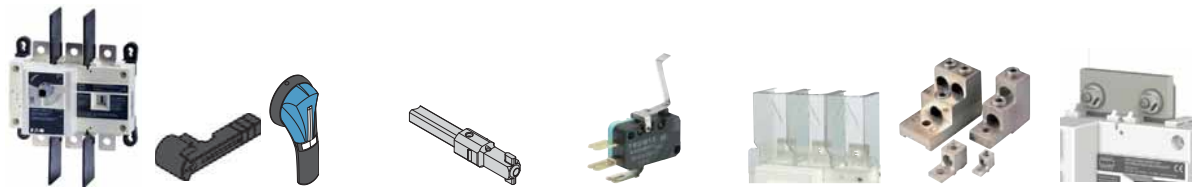

Ampere Rating	Number of Poles	Switch Body	Direct Handle	External Handle (Choose One)	Shaft for External Handle In (mm) (Choose One)	Auxiliary Contacts (Choose One)	Terminals Shroud	Terminal Lugs	Jumpers for Connecting Poles in Series
100	3	R9D3100UDC	DHR9DE	S2 Type	7.90 (200.0)	C Type	3P ②	3P ④	2 pieces
	4	R9D4100UDC		Black	SF200PH10X10	1st Contact	TS3R9DT	LK3R9DL	DCJUMP2
200	3	R9D3200UDC		1, 3R, 12 ①	12.60 (320.0)	NO+NC	3P ③	4P ④	3 pieces
	4	R9D4200UDC		PHB2N12F	SF320PH10X10	AC1NONCDE	TS3R9DB	LK4R9DL	DCJUMP3
400	3	R9E3400UDC		Red/Yellow	15.7 0 (400.0)	2nd Contact	4P ④		
	4	R9E4400UDC		PHR2N12F	SF400PH10X10	AC2NONCDE	TS4R9DTB		
				Black					
				4, 4X ①					
				PHB2N4XF					
							3P ②	3P ④	2 pieces
							TS3R9ET	LK3R9EM	DCJUMPE2
							3P ③	4P ④	3 pieces
							TS3R9EB	LK4R9EM	DCJUMPE3
							4P ④		
							TS4R9ETB		

Notes

- ① Defeatable handle.
- ② Top (line side).
- ③ Bottom (load side).
- ④ Top or bottom (line or load side).

Manual Transfer Switches**Features**

- Three load break positions (I, 0, II)
- On load switching
- Direct or external handle
- 480 Vac total system
- 600 Vac resistive load

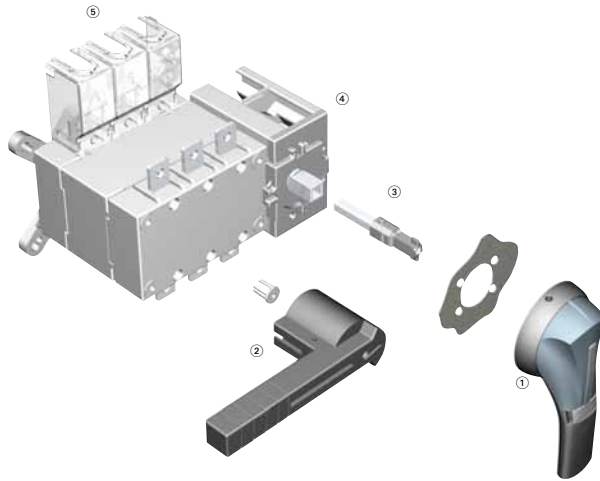
Manual Transfer Switches**Product Identification**

- ① External front handle
- ② Direct handle
- ③ Shaft extension for external handle
- ④ Pre-break ACs (standard on 600–1200A)
- ⑤ Terminal Screen

Product Selection

Direct Operation

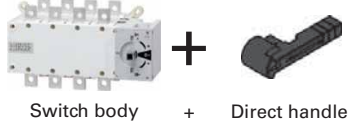

External Operation

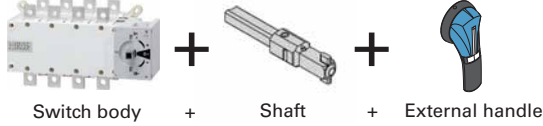

Manual Transfer Switches—UL 98 Standard ①

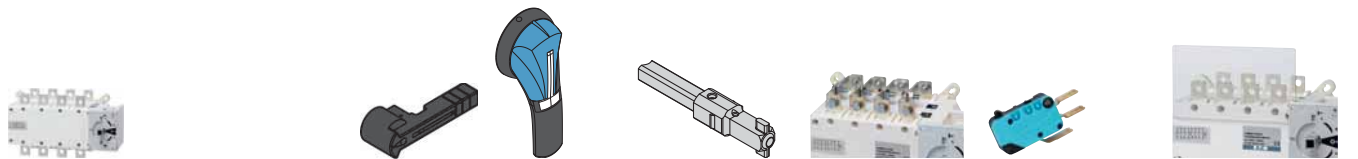

Ampere Rating	Number of Poles	Switch Body Only ①	Direct Handle (Black)	External Three-Position Handle (Choose One)	Shaft Extensions for External Handle In (mm) (Choose One)	Bridging Bars	Auxiliary Contacts	Terminal Screens ②		
100	3	RMTS3100U	DHMTSSL	Size 2, Black I–0–II Type 4/4X PHB2N4X3P	7.90 (200.6) SF200PH10X10	3P BB3P200	NO/NC AC1NONCMTS400	3P TS3MTS200TB		
	4	RMTS4100U			12.60 (320.0) SF320PH10X10					
200	3	RMTS3200U		Size 2, Red I–0–II Type 4/4X PHR2N4X3P	12.60 (320.0) SF320PH10X10	4P BB4P200	Low level AC1NONCMTS400LL ③	4P TS4MTS200TB		
	4	RMTS4200U			15.70 (398.8) SF400PH10X10					
400	3	RMTS3400U		Size 3, Black I–0–II Type 4/4X PHB3N4X3P	7.90 (200.6) SF200PH15X12	3P BB3P400		3P TS3MTS400TB		
	4	RMTS4400U			12.60 (320.0) SF320PH15X12				4P BB4P400	4P TS4MTS400TB
					15.70 (398.8) SF400PH15X12					
600	3	RMTS3600U	DHMTSDL	Size 4, Black I–0–II Type 4/4X PHB4N4X3P		3P BB3P600	NO/NC contact standard	3P TS3MTS600		
	4	RMTS4600U			4P BB4P600	4P TS4MTS600				
800	3	RMTS3800U	DHMTSDLM	Size 4, Red I–0–II Type 4/4X PHR4N4X3P		3P BB3P1200		3P TS3MTS1200		
	4	RMTS4800U			4P BB4P1200	4P TS4MTS1200				
1200	3	RMTS31200U								
	4	RMTS41200U								

Notes

- ① All ratings, 100–1200A, are UL 98 listed. Switches are to be UL 1008 listed in 2011.
- ② Line or load (top or bottom); for both line and load, order two kits.
- ③ Low level auxiliary contact—gold plated for minimal resistance—for PLC applications.

Enclosed Rotary Disconnects**Features**

- Padlockable in the OFF position (up to three padlocks) to meet OSHA lockout requirements
- Available in 16–80A ratings
- 600 Vac, three- and four-pole non-fusible device
- Rated for making and breaking loads
- Accepts auxiliary contacts; capability to signal PLC controllers
- Ground lug connection provided
- Possibility of adding one power pole and one auxiliary contact
- NEMA Type 1, 3R, 12, 4, 4X
- 65kAIC rating when applied downstream from appropriate fusing

Enclosed Rotary Disconnects

Provide users with the ability to lock directly wired motor loads in the OFF position to comply with OSHA lockout/tagout regulations. Also for machine applications that require compact, economical disconnect switches.

Enclosed rotary disconnect switches allow safe control and safe disconnect of any motor application.

Open rotary disconnects can be found on **Pages V9-T1-46 to V9-T1-61** and full information in Volume 5, Motor Control and Protection, CA08100006E, Tab 8.

Product Selection

Enclosed Rotary Non-Fusible

Ampere Rating	Maximum Horsepower Ratings				NEMA 1 ① Enclosure Indoor Catalog Number	NEMA 12 ①② Enclosure Dust-Tight/ Rainproof Catalog Number	NEMA 4X ① Enclosure Corrosion-Resistant, Stainless Steel Catalog Number	NEMA 4X ① Enclosure Corrosion-Resistant, Non-Metallic Catalog Number	NEMA 4X Enclosure Polycarbonate- Non-Metallic Catalog Number
	Three-Phase AC								
	208V	240V	480V	600V					
Three-Pole, 600 Vac									
16	3	5	10	10	ER53016UG	ER53016UD	ER53016UW	ER53016UX	—
25	7-1/2	7-1/2	15	20	ER53025UG	ER53025UD	ER53025UW	ER53025UX	—
30	7-1/2	7-1/2	15	20	ER53030UG	ER53030UD	ER53030UW	ER53030UX	ER53030UPYR ③④
40	7-1/2	7-1/2	20	25	ER53040UG	ER53040UD	ER53040UW	ER53040UX	—
60	15	15	30	30	ER53060UG	ER53060UD	ER53060UW	ER53060UX	ER53060UPYR ③④
80	15	20	40	40	ER53080UG	ER53080UD	ER53080UW	ER53080UX	—
Four-Pole, 600 Vac									
16	3	5	10	10	ER54016UG	ER54016UD	ER54016UW	ER54016UX	—
25	7-1/2	7-1/2	15	20	ER54025UG	ER54025UD	ER54025UW	ER54025UX	—
30	7-1/2	7-1/2	20	25	ER54030UG	ER54030UD	ER54030UW	ER54030UX	—
40	7-1/2	7-1/2	20	25	ER54040UG	ER54040UD	ER54040UW	ER54040UX	—

Accessories for Enclosed Rotary Disconnects ⑤⑥

Disconnect Ampere Rating	Switched Fourth Pole	Unswitched Neutral Pole	Auxiliary Contacts (Choose One)	Terminal Shrouds
16	S4PR516	UNMR5A	1NO + 1NC AC1NONC	Single-pole TS1R5A
25	S4PR525			
30	S4PR530		2NC AC2NC	Three-pole TS3R5A
40	S4PR540			
60	S4PR560 ⑦	UNMR5B ⑦		Single-pole TS1R5B
80	S4PR580 ⑦			Three-pole TS3R5B

Notes

- ① For CSA listed switches, add prefix letter "C" to the front of the catalog number.
- ② NEMA Type 12 enclosures (16–80A) can be field modified to meet NEMA Type 3R rainproof requirements when a factory-provided drain hole is opened.
- ③ YR suffix indicates **Y**ellow cover with **R**ed handle. For **G**ray cover with **B**lack handle, replace "YR" with "GB." For **G**ray cover with **R**ed handle, replace "YR" with "GR."
- ④ cULus only.
- ⑤ Ordered and shipped as separate components—not integral to enclosed device.
- ⑥ Enclosed disconnects can accept one power pole, neutral or up to two auxiliary contacts (one mounted on either side of switch).
- ⑦ Available 2011.

Contact the Safety Switch Flex Center (1-888-329-9272) for factory-installed accessories or other special modifications.

Circuit Breakers



Fuse Blocks and Fuse Holders



Rotary Disconnect Switches



1.1 Circuit Breakers

Product Overview	V9-T1-2
Series G Molded Case Circuit Breakers	V9-T1-5
Series G Motor Circuit Protectors	V9-T1-8
Series G Motor Protector Breakers	V9-T1-10
Universal Molded Case Circuit Breakers	V9-T1-13
QUICKLAG Type QC Miniature Circuit Breakers— Cable-In/Cable-Out Type QC	V9-T1-19
FAZ-NA UL 489 Circuit Breakers	V9-T1-25
FAZ UL 1077 Circuit Breakers	V9-T1-28
Series NRX Low Voltage Power Breakers	V9-T1-33
Magnum Low Voltage Power Breakers	V9-T1-36

1.2 Fuse Blocks and Fuse Holders

Product Overview	V9-T1-44
C350 Series	V9-T1-45

1.3 Rotary Disconnect Switches

Open Rotary Disconnects	V9-T1-46
Enclosed Rotary Disconnects	V9-T1-62

For our complete product offering, see Volume 4—Circuit Protection, CA08100005E and Volume 5—Motor Control and Protection, CA08100006E.

Product Overview

Circuit Breaker Selection Guide



Description	Series G Molded Case Circuit Breaker		Universal Molded Case Circuit Breakers		QUICKLAG® Type QC Miniature Circuit Breakers
	Page V9-T1-5		Page V9-T1-13		Page V9-T1-19
General Applications	Line protection—molded case switch, motor circuit protection (combination tested with Eaton starters and contactors) thermal-magnetic and electronic trip units.		Line protection—feeder and branch thermal-magnetic trip unit.		Used to provide branch circuit protection in cable-in/out panel or DIN rail mount applications.
Technical Data					
Maximum current rating	2500A		600A		100A
Maximum voltage—AC	690 Vac		480 Vac		240 Vac
Maximum voltage—DC	250 Vdc		250 Vdc		80 Vdc
Poles	1, 2, 3, 4		1, 2, 3		QC = 1, 2, 3, 4 QCD = 1, 2, 3 QCR/QCF = 1, 2, 3
Max. interrupting capacities See individual catalogs for limitations and back-up protection requirements.	Three-pole at 240V E = 200 kA J = 200 kA L = 200 kA	Three-pole at 480V E = 100 kA J = 200 kA L = 200 kA	Three-pole at 240V G = 25 kA (480/277) F = 25 kA J = 35 kA K = 35 kA L = 35 kA	Three-pole at 480V GI = 14 kA (480/277) GD = 22 kA F = 14 kA J = 20 kA K = 20 kA L = 20 kA	65 kA at 240 Vac 5 kA at 80 Vdc
Approvals	UL® 489 IEC 60947-2 CE	CSA® KEMA-KEUR CCC	UL 489CE IEC 60947-2	CE CSA	UL 489 CSA 22.2
Environmental Data					
Humidity	Non-condensing 100% relative humidity		Non-condensing 100% relative humidity		—
Shock	—		—		—
Vibration	—		—		—
Operating temperature	-20° to 70°C (-4° to 158°F) derating applies		-20° to 70°C (-4° to 158°F) derating applies		40°C (104°F)
Dielectric strength	Below 250A 6 kV Above 250A 8 kV		Below 250A 6 kV Above 250A 8 kV		1960 Vac (acc. to UL 489)
Insulation resistance	750 Vac		750 Vac		—
Endurance/life	250A: EG, JG = 8,000 operations 630A: LG = 6,000 operations		250A: Gi = 10,000 operations Fi = 8,000 operations 400A: Ji, Ki, Li = 6,000 operations		>10,000 operations
Approximate weight	E Three-pole—2.88 lbs (1.04 kg) J Three-pole—5.06 lbs (2.30 kg) L Three-pole—12.36 lbs (5.61 kg)		G Three-pole—2.10 lbs (0.95 kg) F Three-pole—4.5 lbs (2.0 kg) J Three-pole—12.50 lbs (5.7 kg) K Three-pole—11.50 lbs (5.2 kg)		QC Single-pole—0.36 lbs (162.8 g) Two-pole—0.61 lbs (274.9 g) Three-pole—1.14 lbs (518.3 g) QCD Single-pole—0.43 lbs (195.3 g) Two-pole—0.89 lbs (401.9 g) Three-pole—1.34 lbs (605.6 g) QCR Single-pole—0.22 lbs (97.9 g) Two-pole—0.48 lbs (215.8 g) Three-pole—0.70 lbs (315.6 g) QCF Single-pole—0.24 lbs (109.9 g) Two-pole—0.50 lbs (225.2 g) Three-pole—0.74 lbs (335.1 g)
Mounting configuration	Backpan, plug-in adapter, DIN rail (E)		Backpan, DIN rail (G)		Panel mount, front mount, 35 mm DIN rail mountable

For our complete product offering, see Volume 4—Circuit Protection, CA08100005E.

Circuit Breaker Selection Guide, continued



FAZ-NA UL 489
Miniature Circuit Breakers



FAZ UL 1077
Miniature Circuit Breakers—
Supplementary Protectors

Description

Page V9-T1-25

Page V9-T1-28

General Applications

Used to provide branch circuit protection in cable-in/out DIN rail mount applications.

Used to provide overcurrent protection where branch protection (for example UL 489 MCCB) is already provided or not required. Replacement for fuses used as supplementary protectors.

Technical Data

Maximum current rating	40A	63A
Maximum voltage—AC	480/277 Vac (240/415 Vac IEC)	480/277 Vac
Maximum voltage—DC	48 Vdc	65 Vac Single-pole 130 Vac Two-pole
Poles	1, 2, 3	1, 2, 3
Max. interrupting capacities	10 kA UL/CSA; 15 kA IEC/EN 60947-2	IEC 240/415V 10 kA UL/CSA 120V 10 kA 240V 10 kA 277V 6 kA 480V 6 kA
See individual catalogs for limitations and back-up protection requirements.		

Approvals

UL 489
CE; IEC/EN 60947-2
CSA 22.2

UL 1077
CE; IEC/EN 60947-2; IEC/EN 60898
CSA 22.2 235

Environmental Data

Humidity	Acc. IEC 60068-2 (25° to 55°C/ 77° to 131°F, 90–95% RH)	—
Shock	Acc. IEC 60068-2-27 (40g half sine wave for 10 ms—3 axes) (15g half sine wave for 20 ms—3 axes)	—
Vibration	Acc. to IEC 60068-2-6 5–100 Hz/1.0 mm/0.7g (3 axes)	—
Operating temperature	30°C (86°F)	—
Dielectric strength	1960 Vac (acc. to UL 489)	—
Insulation resistance	100M ohms at 500 Vdc	—
Endurance/life	>20,000 operations	—
Approximate weight	Single-pole—0.27 lbs (121.0g) Two-pole—0.53 lbs (242.0g) Three-pole—0.80 lbs (363.0g)	Single-pole—0.26 lbs (120.0g) Two-pole—0.54 lbs (244.9g) Three-pole—0.83 lbs (376.5g)
Mounting contribution	35 mm DIN rail mountable	35 mm DIN rail mountable

For our complete product offering, see Volume 4—Circuit Protection, CA08100005E.

Circuit Breaker Selection Guide, continued



**Series NRX
Low Voltage Power Breakers**

Page V9-T1-33



**Magnum
Low Voltage Power Breakers**

Page V9-T1-36

Description

General Applications

Solution for where space is at a premium or when equipment dimensions are critical when upgrading or retrofitting current systems. Offering the power and performance of a power breaker in the compact size of a molded case breaker. With its reduced weight and compact dimensions, you can mount two times as many feeder breakers and reduce the overall enclosure density up to 50%.

Enables comprehensive solutions to meet and exceed the unique and wide-ranging requirements of today's global power distribution systems. Designed and engineered for ultimate custom configuration and application flexibility in metal enclosed switchgear and power distribution enclosures.

Technical Data

Maximum current rating	630–1600A	800–6300A
Maximum voltage—AC	220–690 Vac	Up to 690 Vac
Maximum voltage—DC	—	—
Poles	3, 4	3, 4
Max. interrupting capacities See individual catalogs for limitations and back-up protection requirements.	65 kAIC at 480 Vac Max. withstand capacities 42 kAIC	200 kA at 480 Vac Max. withstand capacities 100 kAIC CL fuseless 200 kA at 635 Vac with integral limiters

Approvals

UL 1006 Component UL 489 Component IEC 60947-2	UL 1066 IEC 60947-2 KEMA
------------------------------------------------------	--------------------------------

Environmental Data

Humidity	—	—
Shock	—	—
Vibration	—	—
Operating temperature	–25° to 70°C	–25° to 70°C
Dielectric strength	—	—
Insulation resistance	—	—
Endurance/life	10,000 electrical operations 20,000 mechanical operations	—
Approximate weight	Three-pole breaker + cassette—85 lbs (39 kg) Three-pole breaker—53 lbs (24 kg) Four-pole breaker + cassette—104 lbs (47 kg) Four-pole breaker—67 lbs (30 kg)	—
Mounting configuration	Rear-connected, front-connected, surface mounting, mounting bracket, fixed, drawout breaker with cassette	Fixed or drawout with cassette rear-connected, front-connected

For our complete product offering, see Volume 4—Circuit Protection, CA08100005E.

Series G Molded Case Circuit Breakers



Features

- Field-fit accessories
- Common accessories through 630A
- Space-saving footprint
- High-performance current limiting designs up to 200 kAIC at 480V
- Global ready: UL, CSA, CE, IEC, KEMA-KEUR listings
- Complete breaker includes frame, trip unit, standard terminals and mounting hardware

Catalog Number Selection

Series G® Molded Case Circuit Breakers

EG Frame

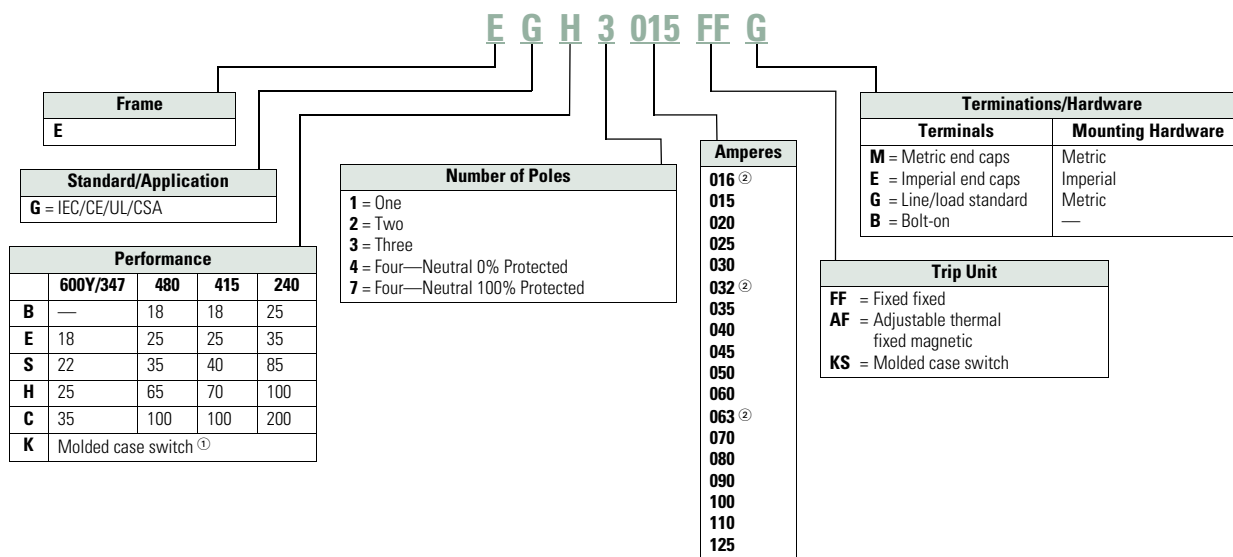

Notes

- ① Available only as 125 and 160A sizes.
- ② Is not UL rated.

1.1

Circuit Protection

Circuit Breakers

1

JG Frame

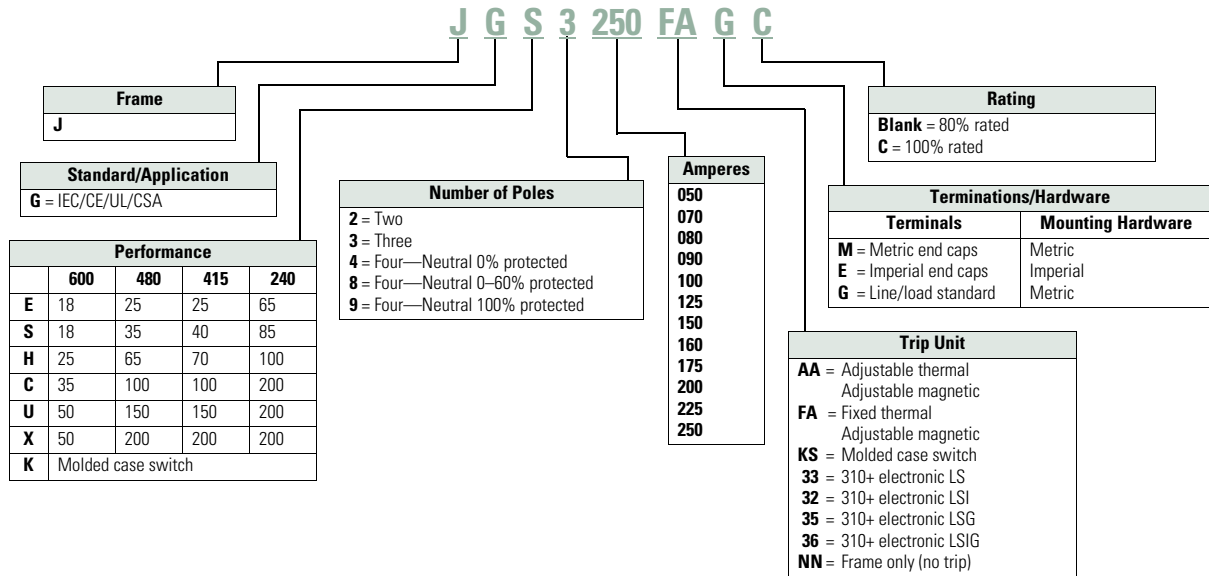

LG Frame

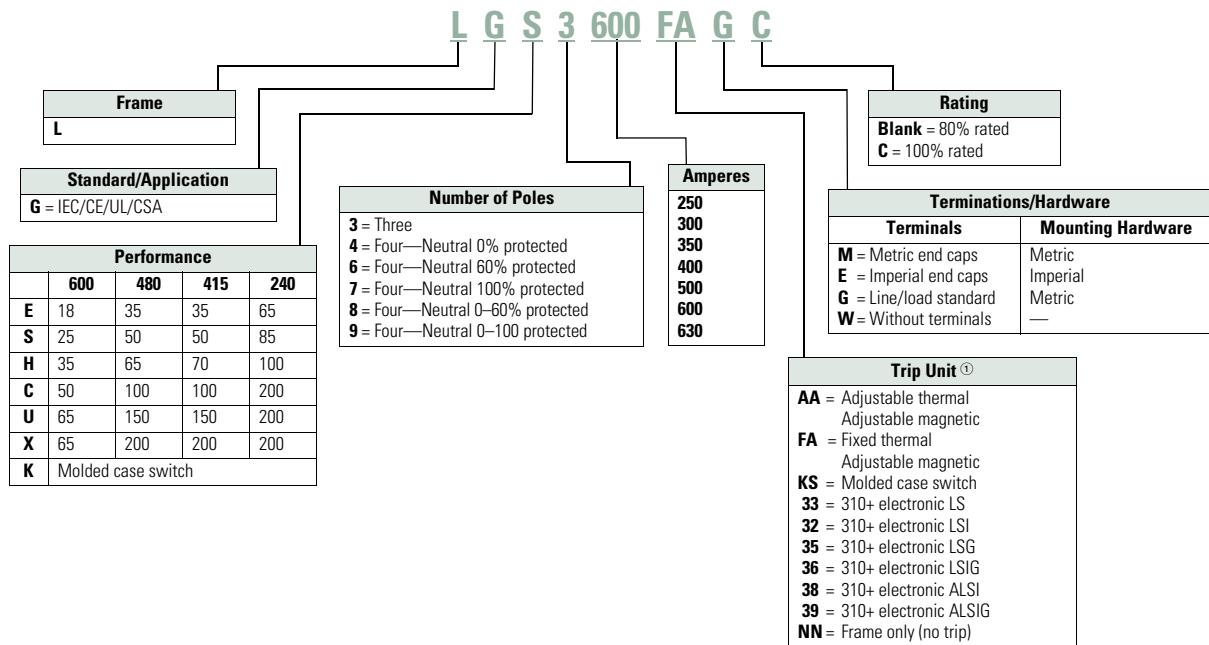

Note

① A = Arc reduction, L = Long, S = Short, I = Instantaneous, G = Ground.

Product Selection

Series G Molded Case Circuit Breakers

Approximate Dimensions are in Inches

EG Frame

Maximum Continuous Amperes at 40°C ① Three-Pole 3.00 W x 5.50 H x 2.99 D
Fixed Thermal
Fixed Magnetic

IC Rating: 25 kAIC at 415 and 480 Vac

15	EGE3015FFG
20	EGE3020FFG
25	EGE3025FFG
30	EGE3030FFG
35	EGE3035FFG
40	EGE3040FFG
45	EGE3045FFG
50	EGE3050FFG
60	EGE3060FFG
70	EGE3070FFG
80	EGE3080FFG
90	EGE3090FFG
100	EGE3100FFG
125	EGE3125FFG

Maximum Continuous Amperes at 40°C Three-Pole 3.00 W x 5.50 H x 2.99 D
Fixed Thermal
Fixed Magnetic

IC Rating: 70 kAIC at 415 Vac, 65 kAIC at 480 Vac

15	EGH3015FFG
20	EGH3020FFG
25	EGH3025FFG
30	EGH3030FFG
35	EGH3035FFG
40	EGH3040FFG
45	EGH3045FFG
50	EGH3050FFG
60	EGH3060FFG
70	EGH3070FFG
80	EGH3080FFG
90	EGH3090FFG
100	EGH3100FFG
125	EGH3125FFG

JG Frame

Maximum Continuous Amperes Three-Pole 4.13 W x 7.00 H x 3.57 D
Magnetic Range Fixed Thermal
Adjustable Magnetic

IC Rating: 25 kAIC at 415 and 480 Vac

70	350–700	JGE3070FAG
90	450–900	JGE3090FAG
100	500–1000	JGE3100FAG
125	625–1250	JGE3125FAG
150	750–1550	JGE3150FAG
175	875–1750	JGE3175FAG
200	1000–2000	JGE3200FAG
225	1125–2250	JGE3225FAG
250	1250–2500	JGE3250FAG

Maximum Continuous Amperes Three-Pole 4.13 W x 7.00 H x 3.57 D
Magnetic Range Fixed Thermal
Adjustable Magnetic

IC Rating: 70 kAIC at 415 Vac, 65 kAIC at 480 Vac

70	350–700	JGH3070FAG
90	450–900	JGH3090FAG
100	500–1000	JGH3100FAG
125	625–1250	JGH3125FAG
150	750–1550	JGH3150FAG
175	875–1750	JGH3175FAG
200	1000–2000	JGH3200FAG
225	1125–2250	JGH3225FAG
250	1250–2500	JGH3250FAG

LG Frame

Ampere Rating Three-Pole 5.48 W x 10.13 H x 4.09 D
Fixed Thermal
Adjustable Magnetic

IC Rating: 35 kAIC at 415 and 480 Vac

250	LGE3250FAG
300	LGE3300FAG
350	LGE3350FAG
400	LGE3400FAG
500	LGE3500FAG
600	LGE3600FAG

Ampere Rating Three-Pole 3.00 W x 5.50 H x 2.99 D
Fixed Thermal
Adjustable Magnetic

IC Rating: 70 kAIC at 415 Vac, 65 kAIC at 480 Vac

250	LGH3250FAG
300	LGH3300FAG
350	LGH3350FAG
400	LGH3400FAG
500	LGH3500FAG
600	LGH3600FAG

Note

① 16, 32, 63A are not UL listed ratings.

Series G Motor Circuit Protector



Features

- Instantaneous only protector
- Designed for use in combination with motor starters
- Adjustable to motor FLA
- UL recognized component, File E7819 motor circuit protectors

Product Selection

Series G Motor Circuit Protectors

EG Frame—480 Vac, 600Y/347 Vac Maximum

Continuous Amperes	Cam Setting	Motor Full Load Current Amperes ^①	MCP Trip Setting ^②	MCP Catalog Number
3	A	0.69–0.91	9	HMCPE003A0C
	B	1.1–1.3	15	
	C	1.6–1.7	21	
	D	2.0–2.2	27	
	E	2.3–2.5	30	
	F	2.6–2.8	33	
7	A	1.5–2.0	21	HMCPE007C0C
	B	2.6–3.1	35	
	C	3.7–3.9	49	
	D	4.8–5.2	63	
	E	5.3–5.7	70	
	F	5.8–6.1	77	
15	A	3.4–4.5	45	HMCPE015E0C
	B	5.7–6.8	75	
	C	8.0–9.1	105	
	D	10.4–11.4	135	
	E	11.5–12.6	150	
	F	12.7–13.0	165	
30	A	3.9–9.1	90	HMCPE030H1C
	B	11.5–13.7	150	
	C	16.1–18.3	210	
	D	20.7–22.9	270	
	E	23.0–25.2	300	
	F	25.3–26.1	330	

Continuous Amperes	Cam Setting	Motor Full Load Current Amperes ^①	MCP Trip Setting ^②	MCP Catalog Number
50	A	11.5–15.2	150	HMCPE050K2C
	B	19.2–22.9	250	
	C	26.9–30.6	350	
	D	34.6–38.3	450	
	E	38.4–42.1	500	
	F	42.2–43.5	550	
70	A	16.1–30.6	210	HMCPE070M2C
	B	26.9–32.2	350	
	C	37.6–42.9	490	
	D	48.4–53.7	630	
	E	53.8–59.1	700	
	F	59.2–60.9	770	
100	A	23.0–30.6	300	HMCPE100R3C
	B	38.4–46.0	500	
	C	53.8–61.4	700	
	D	69.2–76.8	900	
	E	76.9–84.5	1000	
	F	84.6–87.0	1100	
100	A	38.4–46.0	500	HMCPE100T3C
	B	57.6–65.2	750	
	C	76.9–84.5	1000	
	D	③	1250	
	E	③	1375	
	F	③	1500	

Notes

- ① Motor FLA ranges are typical. The corresponding trip setting is at 13 times the minimum FLA value shown. Where a 13 times setting is required for an intermediate FLA value, alternate cam settings and/or MCP ratings should be used.
- ② For DC applications, actual trip levels are approximately 40% higher than values shown.
- ③ Settings above 10 x I_n are for special applications, where the ampere rating of the disconnecting means cannot be less than 115% of the motor full load ampere rating.

JG Frame—600 Vac Maximum, 250 Vdc Maximum

Continuous Amperes	MCP Trip Range Amperes	MCP Catalog Number
250	500–1000	HMCPJ250D5L
	625–1250	HMCPJ250F5L
	750–1500	HMCPJ250G5L
	875–1750	HMCPJ250J5L
	1000–2000	HMCPJ250K5L
	1125–2250	HMCPJ250L5L
	1250–2500	HMCPJ250W5L

LG Frame—600 Vac Maximum, 250 Vdc Maximum

Continuous Amperes	MCP Trip Range Amperes	MCP Catalog Number
600	1250–2500	HMCP600L6G
	1500–3000	HMCP600N6G
	1750–3500	HMCP600R6G
	2000–4000	HMCP600X6G
	2250–4500	HMCP600Y6G
	2500–5000	HMCP600P6G
	3000–6000	HMCP600M6G

Series G Motor Protector Breakers**Features**

- Eliminates need for separate overload relay
- Can be used with contactor to eliminate need for overload relay and still create manual motor control
- Meets requirement for motor branch protection, including:
 - Disconnecting means
 - Branch circuit short-circuit protection
 - Overload protection
- UL 489 listed, IEC 60947-02 rated
- Phase unbalance, phase loss protection and high load alarm
- Optional pre-detection trip relay

Product Selection**Series G Motor Protector Breakers**

For pre-trip alarm option, order Style Number 5721B31G02.

**JG Frame Motor Protector Circuit Breakers,
250A Maximum Rated Current**

Continuous Amperes	35 kAIC Catalog Number	65 kAIC Catalog Number
50	JGMPS050G	JGMPH050G
100	JGMPS100G	JGMPH100G
160	JGMPS160G	JGMPH160G
250	JGMPS250G	JGMPH250G

**LG Frame Motor Protector Circuit Breakers,
630A Maximum Rated Current**

Continuous Amperes	50 kAIC Catalog Number	65 kAIC Catalog Number
250	LGMP250G	LGMPH250G
400	LGMP400G	LGMPH400G
600	LGMP600G	LGMPH600G
630 ^①	LGMP630G	LGMPH630G

Note

^① 630A is not a UL listed rating. 600A is the maximum UL or CSA rating for LG breaker.

Accessories

Field Fit Kit Catalog Numbers

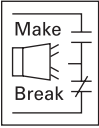
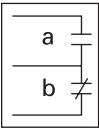
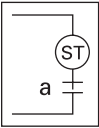
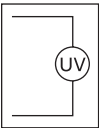
	Description	Pole Location	Frame— EG, JG and LG
Alarm Lockout	Alarm Lockout		
	Make/break	Right	ALM1M1BEPK ①
	2 make/2 break	Right	ALM2M2BEPK ②
Auxiliary Switch	Auxiliary Switch		
	1A, 1B	Right	AUX1A1BPK
	2A, 2B	Right	AUX2A2BPK
	Auxiliary Switch/Alarm Lockout		
	—	Right	AUXALRMEPK ③
Shunt Trip	Shunt Trip—Standard		
	120 Vac	Left	SNT120CPK ④
	240 Vac	Left	SNT120CPK ④
	12 Vdc	Left	SNT012CPK
	24 Vdc	Left	SNT060CPK
	48 Vdc	Left	SNT060CPK
	380–600 Vac	Left	SNT480CPK ⑤
Undervoltage Release Mechanism	Undervoltage Release Mechanism		
	110–127 Vac	Left	UVR120APK
	208–240 Vac	Left	UVR240APK
	24 Vac	Left	UVR024APK
	24 Vdc	Left	UVR024DPK
	48–60 Vdc	Left	UVR048DPK
	12 Vac/Vdc	Left	UVR012CPK
	48–60 Vac	Left	UVR048APK
	120 Vdc	Left	UVR125DPK
	220–250 Vdc	Left	UVR250DPK
	380–500 Vac	Left	UVR480APK
525–600 Vac	Left	UVR600APK	
			

Multiwire Connectors Ordering Information (Package of 3)

High SCCR ratings are available for Power Distribution blocks with Series G MCCBs. See **Tab 6**.

Maximum Amperes	Wires per Terminal	Wire Size Range AWG Cu	Frame	Kit Catalog Number
125	3	14–2	EG	3TA125E3K
125	6	14–6	EG	3TA125E6K
250	3	14–2	JG	3TA250FJ3
250	6	14–6	JG	3TA250FJ6

Terminal Shields

Location	Number of Poles	Frame	IP30 Protection Catalog Number
Line	3	EG	EFTS3K
Line	4	EG	EFTS4K
Line or load	2, 3	JG	FJTS3K
Line or load	4	JG	FJTS4K

Interphase Barriers (Package of 2)

Number of Poles	Frame	Catalog Number
3 or 4	EG	EIPBK
3	JG	FJIPBK
4	JG	FJIPBK4
3 or 4	LG	IPB3

Flex Shaft Handles

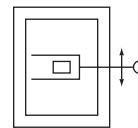

Flex Shaft Handle Mechanisms

Breaker Frame	Flexible Shaft Length in ft (m)	
	4 (1.2)	7 (2.1)
	Catalog Number	Catalog Number
EG	EHMFS04	EHMFS07
JG	JHMFS04	JHMFS07
LG	LHMFS04	LHMFS07

Universal Direct Handle Mechanism



Universal Direct Handle Mechanisms

Frame	With Interlock Catalog Number	Without Interlock Catalog Number
Black Handle Color		
EG	EHMCCBI	EHMCCB
JG	JHMCCBI	JHMCCB
LG	LHMCCBI	LHMCCB
Red Handle Color		
EG	EHMCCRI	EHMCCR
JG	JHMCCRI	JHMCCR
LG	LHMCCRI	LHMCCR

Notes

- ① Part number for JG and LG is ALM1M1BJPK.
- ② Part number for JG and LG is ALM2M2BJPK.
- ③ Part number for JG and LG is AUXALRMJPK.
- ④ 110–125 Vdc, 50/60 Hz.
- ⑤ 380–600 Vdc, 50/60 Hz.

Rotary Handle Mechanisms



High Performance Rotary Handle Mechanisms (Complete Kit Includes Handle, Shaft and Mechanism)

Color	Rating Type UL	IP	EG Frame ^① Catalog Number	JG Frame Catalog Number	LG Frame Catalog Number
Black/blue	1/12/3R	20/54/55	EGHMVD06B	JGHMVD06B	LGHMVD06B
			EGHMVD12B	JGHMVD12B	LGHMVD12B
			EGHMVD24B	JGHMVD24B	LGHMVD24B
Red/yellow	1/12/3R	20/54/55	EGHMVD06R	JGHMVD06R	LGHMVD06R
			EGHMVD12R	JGHMVD12R	LGHMVD12R
			EGHMVD24R	JGHMVD24R	LGHMVD24R
Black/blue	4/4X	66	EGHMVD06BX	JGHMVD06BX	LGHMVD06BX
			EGHMVD12BX	JGHMVD12BX	LGHMVD12BX
			EGHMVD24BX	JGHMVD24BX	LGHMVD24BX
Red/yellow	4/4X	66	EGHMVD06RX	JGHMVD06RX	LGHMVD06RX
			EGHMVD12RX	JGHMVD12RX	LGHMVD12RX
			EGHMVD24RX	JGHMVD24RX	LGHMVD24RX

External Accessories

Description	Fit Type	Frame EG	JG	LG
Non-padlockable handle block	Field	EFHB	—	—
Padlockable handle block	Field	EFPHB	—	—
Padlockable handle block off-only	Field	EFPHBOFF	FJPHBOFF	LBHPOFF
Padlockable handle lock hasp	Field	EFPHL	FJPHL	LPHL
Padlockable handle lock hasp off-only	Field	EFPHLOFF	FJPHLOFF	LPHLOFF
Kirk key interlock kit ^{②③}	Field	—	KYKJG	KYKLG
Castell key interlock kit ^{③④}	Field	—	CTKJG	CTKLG
Slide bar interlock ^⑤	Field	EFSBI	FJSBI	LGSBI
Walking beam interlock	Three-pole	EG3WBI	JG3WBI	LG3WBI
	Four-pole	EG4WBI	JG4WBI	LG4WBI
Electrical operator	120/240 Vac	MOPEG240C	MOPJG240C	MOPLG240C
	125 Vdc	MOPEG240C	MOPJG240C	MOPLG240C
Plug-in adapters	Three-pole	PAD3E	PAD3J	PAD3L
	Four-pole	PAD4E	PAD4J	PAD4L
Rear connecting studs	Field	EFRCSDL	FJRCSDL	3P-LRCS3WK
		EFRCSDS	FJRCSDS	4P-LRCS4WK
		EFRCSWL	FJRCSWL	—
		EFRCSWS	FJRCSWS	—

Notes

- ① Compatible with three-pole and four-pole EG breakers only.
- ② Provision only.
- ③ See Volume 4—Circuit Protection, CA08100005E, Tab 2, for bolt projection dimensions.
- ④ Castell bolt mounting hole must be 10 mm.
- ⑤ Requires two breakers.

Universal Molded Case Circuit Breakers



Features

- Universal design for both NEMA® (UL 489) and IEC (IEC 947-2) standards
- Suitable for 50°C application
- Factory-sealed thermal magnetic trip unit
- Standard interrupting ratings
- Includes mounting hardware and terminals

Catalog Number Selection

Universal Molded Case Circuit Breakers

Universal Molded Case

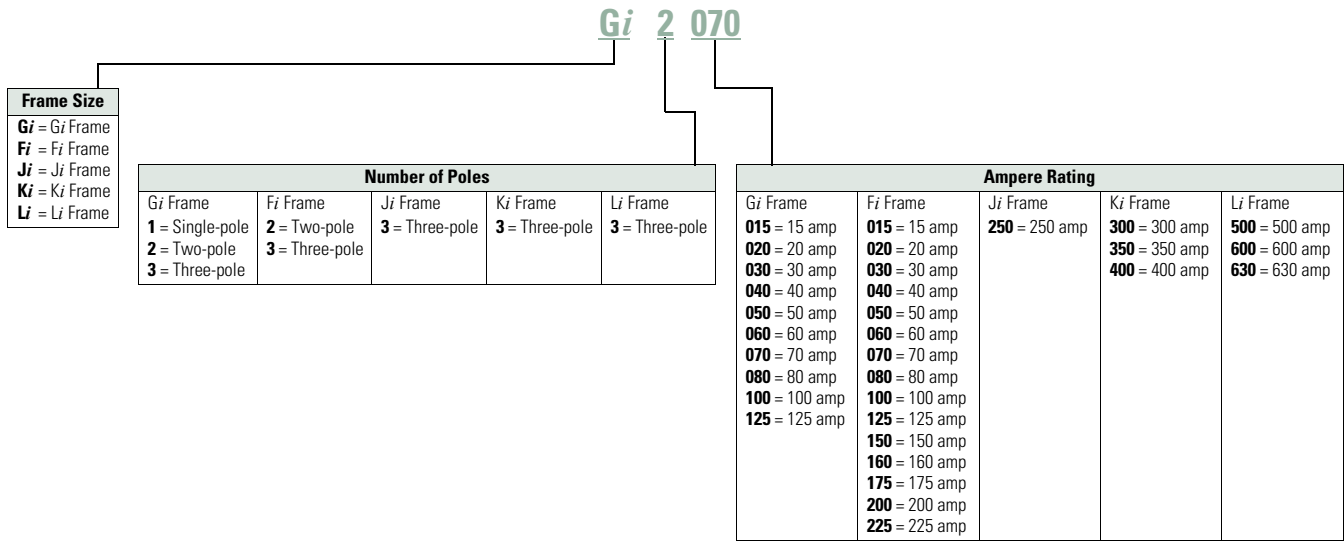

Product Selection

Universal Molded Case Circuit Breakers

Three-Pole

Approximate Dimensions are in Inches

Universal G Frame

Description	Amperes	Catalog Number ^①	
3 W x 4-7/8 H x 2-13/16 D (optional DIN rail kit available catalog number GDIN, package of ten)	15	Gi3015	
	20	Gi3020	
	25	Gi3025	
	30	Gi3030	
Voltage	Interrupting Rating		
380–415	18/5K	35	Gi3035
480/277	14K	40	Gi3040
		45	Gi3045
		50	Gi3050
		60	Gi3060

Universal F Frame

Description	Amperes	Catalog Number ^①	
4-1/8 W x 6 H x 3-3/8 D	15	Fi3015L	
	20	Fi3020L	
	30	Fi3030L	
	35	Fi3035L	
Voltage	Interrupting Rating		
415	18/9K	40	Fi3040L
480	20K	50	Fi3050L
		60	Fi3060L
		70	Fi3070L
		80	Fi3080L
		90	Fi3090L
		100	Fi3100L
		125	Fi3125L
		150	Fi3150L
		175	Fi3175L
		200	Fi3200L
		225	Fi3225L

Universal J Frame

Description	Amperes	Catalog Number ^①
4-1/8 W x 10 H x 4-1/16 D	225	Ji3225L
	250	Ji3250L
Voltage	Interrupting Rating	
415	25/13K	
480	20K	

Universal K Frame

Description	Amperes	Catalog Number ^①
5-1/2 W x 10-1/8 H x 4-1/16 D	300	Ki3300L
	350	Ki3350L
	400	Ki3400L
Voltage	Interrupting Rating	
415	25/13K	
480	20K	

Universal L Frame

Description	Amperes	Catalog Number ^①
8-1/4 W x 10-3/4 H x 4.37 D	500	Li3500
	600	Li3600
Voltage	Interrupting Rating	
415	25/13K	
480	20K	

Note

^① Metric mounting hardware.

Accessories

Internal Accessories

Auxiliary Switch (Right-Pole Mounted)

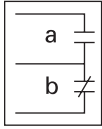

Bell Alarm (Right-Pole Mounted)

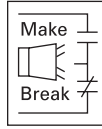

Shunt Trip (Left-Pole Mounted)

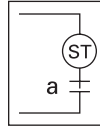

UVR (Left-Pole Mounted)

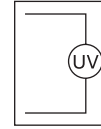

Configuration	Add This Suffix to Catalog Number	Configuration	Add This Suffix to Catalog Number	Voltage Range	Add This Suffix to Catalog Number	Voltage Range	Add This Suffix to Catalog Number
Universal G Frame							
1NO/1NC	A3	1 make/1 break	B3	24 Vac	S7	24 Vac 50/60 Hz	T2
2NO/2NC	A6			120 Vac	S1	48 Vac 50/60 Hz	T3
				240 Vac	S2	60 Vac 50/60 Hz	T4
				12 Vdc	S3	120 Vac 50/60 Hz	T1
				24 Vdc	S4	240 Vac 50/60 Hz	T8
						220 Vac 50 Hz	T7
						440 Vac 50 Hz	T11
						480 Vac 60 Hz	T12
Universal F Frame							
1NO/1NC	A06	1 make/1 break	B06	12–24 Vac/Vdc	S02	12 Vac	U02
2NO/2NC	A13			48–127 Vac or 48–60 Vdc	S06	24 Vac	U06
				208–380 Vac or 110–127 Vdc	S10	48 Vac/Vdc	U38
				415–600 Vac or 220–250 Vdc	S14	110–127 Vac	U14
						208–240 Vac	U18
						380–480 Vac	U22
						525–600 Vac	U26
						12 Vdc	U30
						24 Vdc	U34
						125 Vdc	U42
						220–250 Vdc	U46
Universal J Frame							
1NO/1NC	A06	1 make/1 break	B06	12–24 Vac/Vdc	S42	12 Vac	U06
2 NO/2NC	A13			48–60 Vac/Vdc	S50	24 Vac	U10
				110–240 Vac or 110–125 Vdc	S10	48–60 Vac	U14
				380–440 Vac or 220–50 Vdc	S14	110–127 Vac	U18
				480–600 Vac	S18	208–240 Vac	U22
						380–480 Vac	U26
						12 Vdc	T02
						24 Vdc	T06
						48–60 Vdc	T10
						110–125 Vdc	T14
						220–250 Vdc	T18

If both an auxiliary switch and bell alarm are required, add B13 to the catalog number (right-pole mounted). Auxiliary switch and bell alarm are 240V rated.

If both an auxiliary switch and bell alarm are required, add C05 to the catalog number (right-pole mounted). Auxiliary switch and bell alarm are 600V rated.

If both an auxiliary switch and bell alarm are required, add C05 to the catalog number (right-pole mounted). Auxiliary switch and bell alarm are 600V rated.

Internal Accessories, continued

Auxiliary Switch (Right-Pole Mounted)

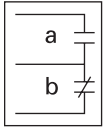

Bell Alarm (Right-Pole Mounted)

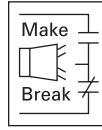

Shunt Trip (Left-Pole Mounted)

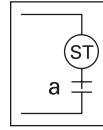

UVR (Left-Pole Mounted)

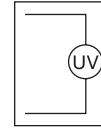

Configuration	Add This Suffix to Catalog Number	Configuration	Add This Suffix to Catalog Number	Voltage Range	Add This Suffix to Catalog Number	Voltage Range	Add This Suffix to Catalog Number				
Universal K Frame											
1NO/1NC	A06	1 make/1 break	B06	12–24 Vac/Vdc	S42	12 Vac	U06				
2NO/2NC	A13			48–60 Vac/Vdc	S50	24 Vac	U10				
If both an auxiliary switch and bell alarm are required, add C05 to the catalog number (right-pole mounted). Auxiliary switch and bell alarm are 600V rated.				110–240 Vac or 110–125 Vdc	S10	48–60 Vac	U14				
						110–127 Vac	U18				
				380–440 Vac or 220–250 Vdc	S14	208–240 Vac	U22				
						380–480 Vac	U26				
				480–600 Vac	S18	12 Vdc	T02				
						24 Vdc	T06				
If both an auxiliary switch and bell alarm are required, add C05 to the catalog number (right-pole mounted). Auxiliary switch and bell alarm are 600V rated.						48–60 Vdc	T10				
						110–125 Vdc	T14				
						220–250 Vdc	T18				
				Universal L Frame							
				1NO/1NC	A06	1 make/1 break	B06	12–24 Vac/Vdc	S02	12 Vac	U06
				2NO/2NC	A13			48–60 Vdc	S06	24 Vac	U10
If both an auxiliary switch and bell alarm are required, add C05 to the catalog number (right-pole mounted). Auxiliary switch and bell alarm are 600V rated.				48–60 Vac	S86	48–60 Vac	U14				
				110–240 Vac	S10	110–127 Vac	U18				
				110–125 Vdc	S42	208–240 Vac	U22				
				380–440 Vac or 220–250 Vdc	S14	380–480 Vac	U26				
				480–600 Vac	S18	12 Vdc	T02				
						24 Vdc	T06				
						48–60 Vdc	T10				
						110–125 Vdc	T14				
						220–250 Vdc	T18				

Handle Mechanisms

Handle Mechanisms

Type 1/12 Universal Rotary

Ordering Information ^①

Shaft Length in Inches (mm)	Handle Color	Complete Catalog Number	Flange Flex Shaft Type 1, 3R, 12 Versions
--------------------------------	-----------------	----------------------------	----------------------------------------------

**Universal G Frame**

6 (152.4)	Black	GHMVD06B	3-ft length; order F0S03C
12 (304.8)	Black	GHMVD12B	4-ft length; order F0S04C
6 (152.4)	Red	GHMVD06R	5-ft length; order F0S05C
12 (304.8)	Red	GHMVD12R	6-ft length; order F0S06C

Universal F Frame

6 (152.4)	Black	FHMVD06B	3-ft length; order F1S03C
12 (304.8)	Black	FHMVD12B	4-ft length; order F1S04C
6 (152.4)	Red	FHMVD06R	5-ft length; order F1S05C
12 (304.8)	Red	FHMVD12R	6-ft length; order F1S06C
			7-ft length; order F1S07C
			8-ft length; order F1S08C
			9-ft length; order F1S09C
			10-ft length; order F1S10C

Universal J Frame

6 (152.4)	Black	JHMVD06B	3-ft length; order F2S03C
12 (304.8)	Black	JHMVD12B	4-ft length; order F2S04C
6 (152.4)	Red	JHMVD06R	5-ft length; order F2S05C
12 (304.8)	Red	JHMVD12R	6-ft length; order F2S06C
			7-ft length; order F2S07C
			8-ft length; order F2S08C
			9-ft length; order F2S09C
			10-ft length; order F2S10C

Universal K Frame

6 (152.4)	Black	KHMVD06B	3-ft length; order F3S03C
12 (304.8)	Black	KHMVD12B	4-ft length; order F3S04C
6 (152.4)	Red	KHMVD06R	5-ft length; order F3S05C
12 (304.8)	Red	KHMVD12R	6-ft length; order F3S06C
			7-ft length; order F3S07C
			8-ft length; order F3S08C
			9-ft length; order F3S09C
			10-ft length; order F3S10C

Note

^① Only available as complete handle mechanism. Parts not sold separately.

Terminals and Termination Accessory Devices

Terminal/Termination Devices

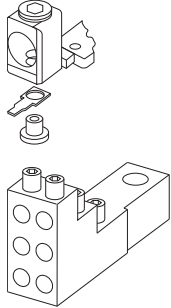

Universal G Frame

Terminals (Included with Breaker)		Optional Multiwire Lugs (Load End Only)	
15–20 A	25–100A	Three-Hole Version	Six-Hole Version
14–2 AWG Cu/Al	10–1/0 AWG Cu/Al	(3) 14–2 AWG Order 3TA100G3K	(6) 14–6 AWG Order 3TA100G6K
2.5–4 mm ² Cu/Al	4–50 mm ² Cu/Al		

Universal F Frame

Terminals (Included with Breaker)			Optional Multiwire Lugs (Load End Only)	
10–20A	25–100A	110–225A	Three-Hole Version	Six-Hole Version
14–10 AWG Cu/Al	14–1/0 AWG Cu/Al	4–4/0 AWG Cu/Al	(3) 14–2 AWG Order 3TA150F3K	(6) 14–6 AWG Order 3TA150F6K
2.5–4 mm ² Cu/Al	2.5–50 mm ² Cu/Al	25–95 mm ² Cu/Al		

Universal J Frame

Terminals (Included with Breaker)		Optional Multiwire Lugs (Load End Only)	
70–250A		Three-Hole Version	Six-Hole Version
4–350 kcmil AWG Cu/Al		(3) 14–2 AWG Order 3TA250J3K	(6) 14–6 AWG Order 3TA250J6K
25–150 mm ² Cu/Al			

Universal K Frame

Terminals (Included with Breaker)		Optional Multiwire Lugs (Load End Only)	
300–350A	400A	Three-Hole Version	Six-Hole Version
250–500 kcmil AWG Cu/Al	3/0–200 (2) AWG Cu/Al	(3) 12–2/0 AWG Order 3TA400K3K	(6) 14–2/0 AWG Order 3TA400K6K
120–240 mm ² Cu/Al	95–120 mm ² Cu/Al		

Universal L Frame

Terminals (Included with Breaker)		Optional Multiwire Lugs (Load End Only)	
500A	600A	Three-Hole Version	Six-Hole Version
(2) 250–300 kcmil Cu/Al	(2) 400–500 kcmil Cu/Al	—	—
120–150 mm ² Cu/Al	185–250 mm ² Cu/Al		

QUICKLAG Type QC Miniature Circuit Breakers—Cable-In/Cable-Out Type QC



Features

For Cable-In/Cable-Out Panel Mount Applications

- Single-, two-, three- and four-pole options
- Built and listed to UL 489
- All products UL and CSA listed
- All products 10–100A are HACR rated

Catalog Number Selection

QUICKLAG Type QC Miniature Circuit Breakers—Cable-In/Cable-Out Type QC

Type QC Miniature Circuit Breakers

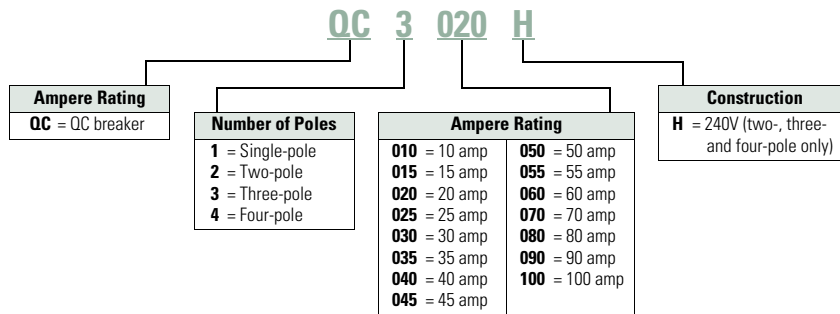

Product Selection

QUICKLAG Type QC 10,000 Ampere I.C. Thermal-Magnetic Breakers

Note: For non-automatic switches, see Volume 4—Circuit Protection, CA08100005E, Tab 1.

Continuous Ampere Rating at 40°C	Single-Pole, 120/240 Vac Catalog Number	Two-Pole, 120/240 Vac Catalog Number	Three-Pole, 240 Vac Catalog Number
10	QC1010	QC2010	—
15	QC1015 ①②	QC2015	QC3015H
20	QC1020 ①②	QC2020	QC3020H
30	QC1030	QC2030	QC3030H
40	QC1040	QC2040	QC3040H
50	QC1050	QC2050	QC3050H
60	—	QC2060	QC3060H
70	—	QC2070	QC3070H
100	QC1100	QC2100	QC3100H

Notes

- ① Switching duty rated for 120 Vac fluorescent light applications only.
- ② For special low-magnetic breaker, order QC1015L1 or QC1020L1.

1.1

Circuit Protection

Circuit Breakers

1

QUICKLAG Type QC Miniature Circuit Breakers—Cable-In/Cable-Out Type QCD



Features

For Cable-In/Cable-Out DIN rail Mount HVAC Applications

- Single-, two- and three-pole options
- Modular construction
- DIN mounted (symmetrical rail 35 in x 7.5 in DIN/EN 50 022)
- Flexible power feed connection: wire size, position
- Same breaker size for entire rating range
- Field-mountable accessories: finger-shroud proof, quick connect terminals, jumper units

Catalog Number Selection

QUICKLAG Type QC Miniature Circuit Breakers—Cable-In/Cable-Out Type QCD

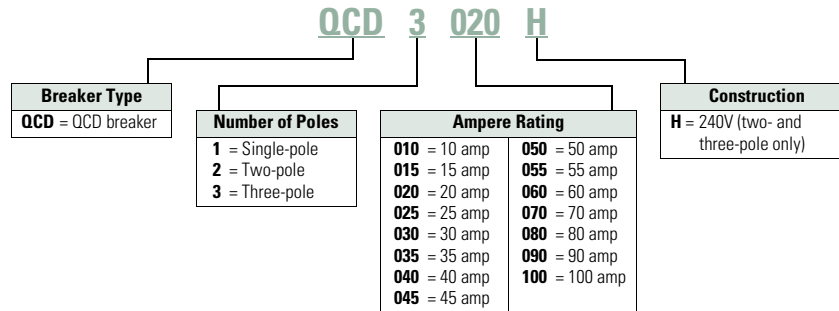

Product Selection

QUICKLAG Type QCD 10,000 Ampere I.C. Thermal-Magnetic Breakers

Continuous Ampere Rating at 40°C	Single-Pole, 120/240 Vac Catalog Number	Two-Pole, 120/240 Vac Catalog Number	Three-Pole, 240 Vac Catalog Number
10	QCD1010	QCD2010	—
15	QCD1015	QCD2015	QCD3015H
20	QCD1020	QCD2020	QCD3020H
30	QCD1030	QCD2030	QCD3030H
40	QCD1040	QCD2040	QCD3040H
50	QCD1050	QCD2050	QCD3050H
60	QCD1060	QCD2060	QCD3060H
70	—	QCD2070	QCD3070H
100	—	QCD2100	QCD3100H

QUICKLAG Type QC Miniature Circuit Breakers—Cable-In/Cable-Out 1/2-Inch Wide Types QCR, QCF



Features

When Space is at a Premium

- QCR: For DIN rail mount cable-in/cable-out applications
- QCF: For front-mount through-the-door cable-in/cable-out applications
- 1/2 in (12.7 mm) wide per pole
- Three-position handle: ON, tripped (center), OFF
- Thermal-magnetic protection
- Single-, two- and three-pole
- 10 kAIC at 120/240 Vac, 10–60A
- 10 kAIC at 240 Vac, 10–30A

Catalog Number Selection

QUICKLAG Type QC Miniature Circuit Breakers—Cable-In/Cable-Out 1/2-Inch Wide Types QCR, QCF

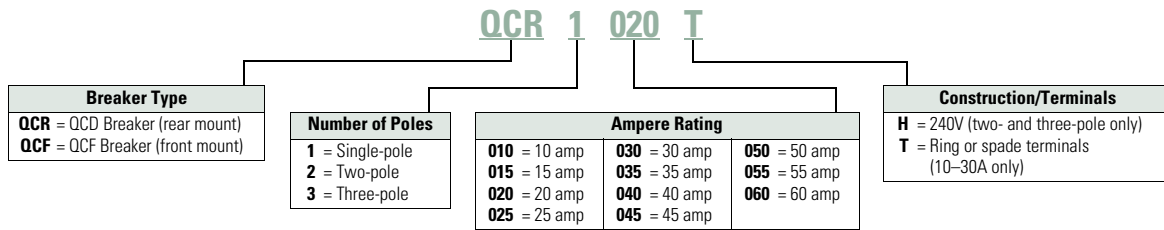

Product Selection

QUICKLAG Type QCR Breakers 10 kAIC Interrupting Ratings ①②③④

Continuous Ampere Rating at 40°C	Single-Pole 120/240 Vac Catalog Number	Two-Pole 120/240 Vac Catalog Number	Three-Pole 240 Vac Catalog Number
10	QCR1010 QCR1010T	QCR2010 QCR2010T	—
15	QCR1015 ⑤ QCR1015T ⑤	QCR2015 QCR2015T	QCR3015H QCR3015HT
20	QCR1020 ⑤ QCR1020T ⑤	QCR2020 QCR2020T	QCR3020H QCR3020HT
25	QCR1025 —	QCR2025 —	QCR3025H QCR3025HT
30	QCR1030 —	QCR2030 —	QCR3030H QCR3030HT
35	QCR1035	QCR2035	—
40	QCR1040	QCR2040	—
45	QCR1045	QCR2045	—
50	QCR1050	QCR2050	—
55	QCR1055	—	—
60 ⑥	QCR1060	QCR2060	—

QUICKLAG Type QCF Breakers 10 kAIC Interrupting Ratings ①②③

Continuous Ampere Rating at 40°C	Single-Pole 120/240 Vac Catalog Number	Two-Pole 120/240 Vac Catalog Number	Three-Pole 240 Vac Catalog Number
10	QCF1010 QCF1010T	QCF2010 QCF2010T	—
15	QCF1015 ⑤ —	QCF2015 —	QCF3015H QCF3015HT
20	QCF1020 ⑤ —	QCF2020 —	QCF3020H QCF3020HT
25	QCF1025 —	QCF2025 —	QCF3025H QCF3025HT
30	QCF1030 —	QCF2030 —	QCF3030H QCF3030HT
40	QCF1040	QCF2040	—
50	QCF1050	QCF2050	—
60 ⑥	QCF1060	QCF2060	—

Notes

- ① Standard breaker terminals are box type lugs.
- ② Breakers with "T" catalog number suffix are suitable for line and load side ring terminal connection (#10-32 plus/minus terminal screw provided).
- ③ Breakers with "P" catalog number suffix are suitable for terminating two 10 AWG quick-connect type terminals per phase on breaker load side.
- ④ Breakers with shunt trip (extra pole required on breaker right-hand side) are available on single-, two- and three-pole.
- ⑤ All 15 and 20A single-pole breakers are SWD (switching duty) rated for fluorescent lighting applications.
- ⑥ 60/75°C Cu/Al wire on all ratings except 60A, which requires Cu only conductor.

Accessories

Type QCR and QCF

Description	Catalog Number
Steel mounting clip mounts QCR breaker if individual mounting is required. Quantity two required for single- and two-pole and four required for three-pole breakers.	QCRMTGFT
Removable padlock device for single-pole QCR or QCF breaker.	QCRFPL1P
Removable padlock device for multi-pole QCR or QCF breaker.	QCRFPLMP
Padlock bracket assembly for QCR or QCF single- or multi-pole breakers (OFF only).	QCRFLOFF
Padlock bracket for QCR, lock-off only.	QCRPLOFF
QUICKLAG Type C Spacer	QCRSPACER

QUICKLAG Type C Spacer



QCR and QCF Ring or Spade Lug Terminals

QCR and QCF ring or spade lug terminals (10–30A ratings only). Factory installed line and load side terminals each equipped with a #10-32 screw suitable for terminating one 10 AWG wire with insulated ring or spade type terminal as shown.

Suffix "T"

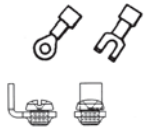

**QUICKLAG Type QC Miniature Circuit Breakers—Cable-In/Cable-Out
1/2-Inch Wide Types QCGF, QCGFEP**



Features

For Cable-In/Cable-Out Panel-Mount Applications

- QUICKLAG ground fault circuit breakers, Class A GFCI:
- Built and tested to UL 943
- 5 mA trip sensitivity
- QUICKLAG ground fault equipment protectors:
 - Built and tested to UL 1053
 - 30 mA trip sensitivity
- All products UL and CSA listed

Catalog Number Selection

**QUICKLAG Type QC Miniature Circuit Breakers—
Cable-In/Cable-Out Ground Fault and Equipment Protector Types QCGF, QCGFEP**

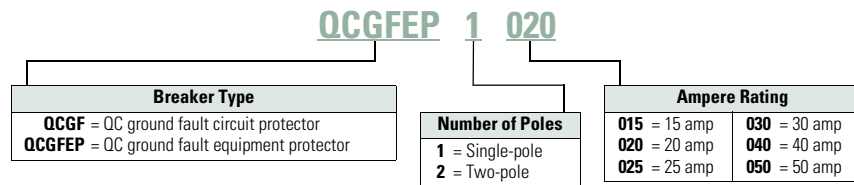



Product Selection

Types QCGF and QCGFEP Thermal-Magnetic Breakers

Continuous Ampere Rating at 40°C	Single-Pole, 120/240 Vac Catalog Number	Two-Pole, 120/240 Vac Catalog Number
Ground Fault Circuit Breakers—5 mA Sensitivity		
QUICKLAG Type: QCGF 10,000 Ampere I.C.		
15	QCGF1015	QCGF2015
20	QCGF1020	QCGF2020
30	QCGF1030	QCGF2030
40	QCGF1040	QCGF2040
50	—	QCGF2050
Ground Fault Equipment Protectors—30 mA Sensitivity		
QUICKLAG Type: QCGFEP 10,000 Ampere I.C.		
15	QCGFEP1015	QCGFEP2015
20	QCGFEP1020	QCGFEP2020
30	QCGFEP1030	QCGFEP2030
40	QCGFEP1040	QCGFEP2040
50	—	QCGFEP2050

Accessories

Type QC Miniature Circuit Breakers

	Accessory ^①	Description	Catalog Number
Handle Locks 	Handle locks: Non-padlockable ^②	QUICKLAG type P, B, C—single-pole	QL1NPL
		QUICKLAG type P, B, C—two-, three-pole	QL23NPL
	Handle locks: Padlockable	QUICKLAG type P, B, C—single-pole	QL1PL
		QUICKLAG type C—single-, two-, three-pole	QC123PL
		QUICKLAG type C—single-, two-, three-pole (off only)	QCD123PLOFF
Handle Tie 	Handle tie	QUICKLAG handle tie—single-pole	QL1HT
		QUICKLAG handle tie—three-pole	QL3HT
Hardware 	Mounting hardware	QUICKLAG type C face mounting clip	QCFLIP
		QUICKLAG type C face mounting plate—single-pole	QC1FP
		QUICKLAG type C face mounting plate—two-pole	QC2FP
		QUICKLAG type C face mounting plate—three-pole	QC3FP
		QUICKLAG type C face mounting plate and lock-off (off only)—two-pole ^③	QC2FPLOFF
		QUICKLAG type C face mounting plate and lock-off (off only)—three-pole	QC3FPLOFF
		QUICKLAG type C base mounting clamp	QCBCLIP
		QUICKLAG base mounting plate—six poles total	QC6BP
		QUICKLAG type C base mounting plate, six-poles total— heavy-duty screw-secured	QC6BPS
		QUICKLAG type C (QCD) two-way jumper unit with cover	QCDJ2
		QUICKLAG type C (QCD) four-way jumper unit with cover	QCDJ4
		QUICKLAG type C (QCD) six-way jumper unit with cover	QCDJ6
		QUICKLAG type C (QCD) two-way jumper unit, no cover	QCDJ2T
		QUICKLAG type C (QCD) four-way jumper unit, no cover	QCDJ4T
		QUICKLAG type C (QCD) six-way jumper unit, no cover	QCDJ6T
		QUICKLAG type QCD finger protection attachment	QCDFP
	QUICKLAG type C DIN rail adapter	QCDINADAPT	

Notes

- ① See **Page V9-T1-22** for QCR and QCF accessories.
- ② Can lock in ON or OFF position.
- ③ Suitable for ground fault breakers.

FAZ-NA UL 489 Circuit Breakers



Features

- UL 489 listed DIN rail mounted miniature circuit breakers up to 40A current rating
- Current limiting design provides fast short-circuit interruption that reduces let-through energy
- Thermal-magnetic overcurrent protection
 - Three levels of short-circuit protection, categorized by B, C and D curves
- Ring-tongue terminals available
- Complete line of accessories

Catalog Number Selection

FAZ-NA UL 489 Circuit Breakers

FAZ-NA UL 489

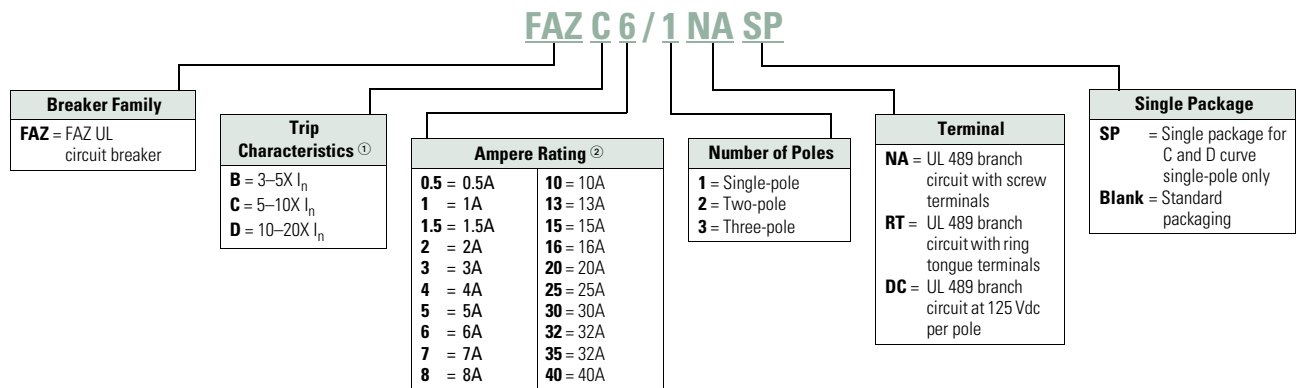

Notes

- ① I_n = Rated current for instantaneous trip characteristics.
- ② B curve starts at 1 ampere.

Product Selection

FAZ-NA UL 489 Circuit Breakers— 10 kAIC, 14 kAIC B Curve (15–25A)

Amperes	Single-Pole ^① Catalog Number	Two-Pole Catalog Number	Three-Pole Catalog Number
B Curve (3–5X I_n Current Rating)			
1	FAZ-B1/1-NA	FAZ-B1/2-NA	FAZ-B1/3-NA
1.5	FAZ-B1.5/1-NA	FAZ-B1.5/2-NA	FAZ-B1.5/3-NA
2	FAZ-B2/1-NA	FAZ-B2/2-NA	FAZ-B2/3-NA
3	FAZ-B3/1-NA	FAZ-B3/2-NA	FAZ-B3/3-NA
4	FAZ-B4/1-NA	FAZ-B4/2-NA	FAZ-B4/3-NA
5	FAZ-B5/1-NA	FAZ-B5/2-NA	FAZ-B5/3-NA
6	FAZ-B6/1-NA	FAZ-B6/2-NA	FAZ-B6/3-NA
7	FAZ-B7/1-NA	FAZ-B7/2-NA	FAZ-B7/3-NA
8	FAZ-B8/1-NA	FAZ-B8/2-NA	FAZ-B8/3-NA
10	FAZ-B10/1-NA	FAZ-B10/2-NA	FAZ-B10/3-NA
13	FAZ-B13/1-NA	FAZ-B13/2-NA	FAZ-B13/3-NA
15	FAZ-B15/1-NA	FAZ-B15/2-NA	FAZ-B15/3-NA
16	FAZ-B16/1-NA	FAZ-B16/2-NA	FAZ-B16/3-NA
20	FAZ-B20/1-NA	FAZ-B20/2-NA	FAZ-B20/3-NA
25	FAZ-B25/1-NA	FAZ-B25/2-NA	FAZ-B25/3-NA
30	FAZ-B30/1-NA	FAZ-B30/2-NA	FAZ-B30/3-NA
32	FAZ-B32/1-NA	FAZ-B32/2-NA	FAZ-B32/3-NA
35 ^②	FAZ-B35/1-NA	FAZ-B35/2-NA	FAZ-B35/3-NA
40 ^②	FAZ-B40/1-NA	FAZ-B40/2-NA	FAZ-B40/3-NA

FAZ-RT UL 489 Circuit Breakers with Ring-Tongue Terminals— 10 kAIC, 14 kAIC B Curve (15–25A)

Amperes	Single-Pole ^① Catalog Number	Two-Pole Catalog Number	Three-Pole Catalog Number
B Curve with Ring-Tongue Terminals (3–5X I_n Current Rating)			
1	FAZ-B1/1-RT	FAZ-B1/2-RT	FAZ-B1/3-RT
1.5	FAZ-B1.5/1-RT	FAZ-B1.5/2-RT	FAZ-B1.5/3-RT
2	FAZ-B2/1-RT	FAZ-B2/2-RT	FAZ-B2/3-RT
3	FAZ-B3/1-RT	FAZ-B3/2-RT	FAZ-B3/3-RT
4	FAZ-B4/1-RT	FAZ-B4/2-RT	FAZ-B4/3-RT
5	FAZ-B5/1-RT	FAZ-B5/2-RT	FAZ-B5/3-RT
6	FAZ-B6/1-RT	FAZ-B6/2-RT	FAZ-B6/3-RT
7	FAZ-B7/1-RT	FAZ-B7/2-RT	FAZ-B7/3-RT
8	FAZ-B8/1-RT	FAZ-B8/2-RT	FAZ-B8/3-RT
10	FAZ-B10/1-RT	FAZ-B10/2-RT	FAZ-B10/3-RT
13	FAZ-B13/1-RT	FAZ-B13/2-RT	FAZ-B13/3-RT
15	FAZ-B15/1-RT	FAZ-B15/2-RT	FAZ-B15/3-RT
16	FAZ-B16/1-RT	FAZ-B16/2-RT	FAZ-B16/3-RT
20	FAZ-B20/1-RT	FAZ-B20/2-RT	FAZ-B20/3-RT
25	FAZ-B25/1-RT	FAZ-B25/2-RT	FAZ-B25/3-RT
30	FAZ-B30/1-RT	FAZ-B30/2-RT	FAZ-B30/3-RT
32	FAZ-B32/1-RT	FAZ-B32/2-RT	FAZ-B32/3-RT
35 ^②	FAZ-B35/1-RT	FAZ-B35/2-RT	FAZ-B35/3-RT
40 ^②	FAZ-B40/1-RT	FAZ-B40/2-RT	FAZ-B40/3-RT

FAZ-NA UL 489 Circuit Breakers— 10 kAIC, 14 kAIC C Curve (15–25A)

Amperes	Single-Pole ^③ Catalog Number	Two-Pole Catalog Number	Three-Pole Catalog Number
C Curve (5–10X I_n Current Rating)			
0.5	FAZ-C0.5/1-NA-SP	FAZ-C0.5/2-NA	FAZ-C0.5/3-NA
1	FAZ-C1/1-NA-SP	FAZ-C1/2-NA	FAZ-C1/3-NA
1.5	FAZ-C1.5/1-NA-SP	FAZ-C1.5/2-NA	FAZ-C1.5/3-NA
2	FAZ-C2/1-NA-SP	FAZ-C2/2-NA	FAZ-C2/3-NA
3	FAZ-C3/1-NA-SP	FAZ-C3/2-NA	FAZ-C3/3-NA
4	FAZ-C4/1-NA-SP	FAZ-C4/2-NA	FAZ-C4/3-NA
5	FAZ-C5/1-NA-SP	FAZ-C5/2-NA	FAZ-C5/3-NA
6	FAZ-C6/1-NA-SP	FAZ-C6/2-NA	FAZ-C6/3-NA
7	FAZ-C7/1-NA-SP	FAZ-C7/2-NA	FAZ-C7/3-NA
8	FAZ-C8/1-NA-SP	FAZ-C8/2-NA	FAZ-C8/3-NA
10	FAZ-C10/1-NA-SP	FAZ-C10/2-NA	FAZ-C10/3-NA
13	FAZ-C13/1-NA-SP	FAZ-C13/2-NA	FAZ-C13/3-NA
15	FAZ-C15/1-NA-SP	FAZ-C15/2-NA	FAZ-C15/3-NA
16	FAZ-C16/1-NA-SP	FAZ-C16/2-NA	FAZ-C16/3-NA
20	FAZ-C20/1-NA-SP	FAZ-C20/2-NA	FAZ-C20/3-NA
25	FAZ-C25/1-NA-SP	FAZ-C25/2-NA	FAZ-C25/3-NA
30	FAZ-C30/1-NA-SP	FAZ-C30/2-NA	FAZ-C30/3-NA
32	FAZ-C32/1-NA-SP	FAZ-C32/2-NA	FAZ-C32/3-NA
35 ^②	FAZ-C35/1-NA-SP	FAZ-C35/2-NA	FAZ-C35/3-NA
40 ^②	FAZ-C40/1-NA-SP	FAZ-C40/2-NA	FAZ-C40/3-NA

FAZ-RT UL 489 Circuit Breakers with Ring-Tongue Terminals— 10 kAIC, 14 kAIC C Curve (15–25A)

Amperes	Single-Pole ^③ Catalog Number	Two-Pole Catalog Number	Three-Pole Catalog Number
C Curve with Ring-Tongue Terminals (5–10X I_n Current Rating)			
0.5	FAZ-C0.5/1-RT-SP	FAZ-C0.5/2-RT	FAZ-C0.5/3-RT
1	FAZ-C1/1-RT-SP	FAZ-C1/2-RT	FAZ-C1/3-RT
1.5	FAZ-C1.5/1-RT-SP	FAZ-C1.5/2-RT	FAZ-C1.5/3-RT
2	FAZ-C2/1-RT-SP	FAZ-C2/2-RT	FAZ-C2/3-RT
3	FAZ-C3/1-RT-SP	FAZ-C3/2-RT	FAZ-C3/3-RT
4	FAZ-C4/1-RT-SP	FAZ-C4/2-RT	FAZ-C4/3-RT
5	FAZ-C5/1-RT-SP	FAZ-C5/2-RT	FAZ-C5/3-RT
6	FAZ-C6/1-RT-SP	FAZ-C6/2-RT	FAZ-C6/3-RT
7	FAZ-C7/1-RT-SP	FAZ-C7/2-RT	FAZ-C7/3-RT
8	FAZ-C8/1-RT-SP	FAZ-C8/2-RT	FAZ-C8/3-RT
10	FAZ-C10/1-RT-SP	FAZ-C10/2-RT	FAZ-C10/3-RT
13	FAZ-C13/1-RT-SP	FAZ-C13/2-RT	FAZ-C13/3-RT
15	FAZ-C15/1-RT-SP	FAZ-C15/2-RT	FAZ-C15/3-RT
16	FAZ-C16/1-RT-SP	FAZ-C16/2-RT	FAZ-C16/3-RT
20	FAZ-C20/1-RT-SP	FAZ-C20/2-RT	FAZ-C20/3-RT
25	FAZ-C25/1-RT-SP	FAZ-C25/2-RT	FAZ-C25/3-RT
30	FAZ-C30/1-RT-SP	FAZ-C30/2-RT	FAZ-C30/3-RT
32	FAZ-C32/1-RT-SP	FAZ-C32/2-RT	FAZ-C32/3-RT
35 ^②	FAZ-C35/1-RT-SP	FAZ-C35/2-RT	FAZ-C35/3-RT
40 ^②	FAZ-C40/1-RT-SP	FAZ-C40/2-RT	FAZ-C40/3-RT

Notes

- ① Two-piece order. Quantities of two per box.
- ② 240 Vac rated only.
- ③ Option for single packaging on single-pole C and D curves only; add suffix SP when ordering.

**FAZ-NA UL 489 Circuit Breakers— 10 kAIC, 14 kAIC
D Curve (13–20A)**

Amperes	Single-Pole ^① Catalog Number	Two-Pole Catalog Number	Three-Pole Catalog Number
D Curve (10–20X I_n Current Rating)			
0.5	FAZ-D0.5/1-NA-SP	FAZ-D0.5/2-NA	FAZ-D0.5/3-NA
1	FAZ-D1/1-NA-SP	FAZ-D1/2-NA	FAZ-D1/3-NA
1.5	FAZ-D1.5/1-NA-SP	FAZ-D1.5/2-NA	FAZ-D1.5/3-NA
2	FAZ-D2/1-NA-SP	FAZ-D2/2-NA	FAZ-D2/3-NA
3	FAZ-D3/1-NA-SP	FAZ-D3/2-NA	FAZ-D3/3-NA
4	FAZ-D4/1-NA-SP	FAZ-D4/2-NA	FAZ-D4/3-NA
5	FAZ-D5/1-NA-SP	FAZ-D5/2-NA	FAZ-D5/3-NA
6	FAZ-D6/1-NA-SP	FAZ-D6/2-NA	FAZ-D6/3-NA
7	FAZ-D7/1-NA-SP	FAZ-D7/2-NA	FAZ-D7/3-NA
8	FAZ-D8/1-NA-SP	FAZ-D8/2-NA	FAZ-D8/3-NA
10	FAZ-D10/1-NA-SP	FAZ-D10/2-NA	FAZ-D10/3-NA
13	FAZ-D13/1-NA-SP	FAZ-D13/2-NA	FAZ-D13/3-NA
15	FAZ-D15/1-NA-SP	FAZ-D15/2-NA	FAZ-D15/3-NA
16	FAZ-D16/1-NA-SP	FAZ-D16/2-NA	FAZ-D16/3-NA
20	FAZ-D20/1-NA-SP	FAZ-D20/2-NA	FAZ-D20/3-NA
25	FAZ-D25/1-NA-SP	FAZ-D25/2-NA	FAZ-D25/3-NA
30	FAZ-D30/1-NA-SP	FAZ-D30/2-NA	FAZ-D30/3-NA
32	FAZ-D32/1-NA-SP	FAZ-D32/2-NA	FAZ-D32/3-NA
35 ^②	FAZ-D35/1-NA-SP	FAZ-D35/2-NA	FAZ-D35/3-NA
40 ^②	FAZ-D40/1-NA-SP	FAZ-D40/2-NA	FAZ-D40/3-NA

**FAZ-NA-DC UL 489 Circuit Breakers— 10 kAIC at
125 Vdc Per Pole**

Amperes	Single-Pole ^③ Catalog Number	Two-Pole Catalog Number
C Curve (5–10X I_n Current Rating)		
2	FAZ-C2/1-NA-DC-SP	FAZ-C2/2-NA-DC
3	FAZ-C3/1-NA-DC-SP	FAZ-C3/2-NA-DC
4	FAZ-C4/1-NA-DC-SP	FAZ-C4/2-NA-DC
5	FAZ-C5/1-NA-DC-SP	FAZ-C5/2-NA-DC
6	FAZ-C6/1-NA-DC-SP	FAZ-C6/2-NA-DC
7	FAZ-C7/1-NA-DC-SP	FAZ-C7/2-NA-DC
8	FAZ-C8/1-NA-DC-SP	FAZ-C8/2-NA-DC
10	FAZ-C10/1-NA-DC-SP	FAZ-C10/2-NA-DC
13	FAZ-C13/1-NA-DC-SP	FAZ-C13/2-NA-DC
15	FAZ-C15/1-NA-DC-SP	FAZ-C15/2-NA-DC
16	FAZ-C16/1-NA-DC-SP	FAZ-C16/2-NA-DC
20	FAZ-C20/1-NA-DC-SP	FAZ-C20/2-NA-DC
25	FAZ-C25/1-NA-DC-SP	FAZ-C25/2-NA-DC
30	FAZ-C30/1-NA-DC-SP	FAZ-C30/2-NA-DC
32	FAZ-C32/1-NA-DC-SP	FAZ-C32/2-NA-DC
35	FAZ-C35/1-NA-DC-SP	FAZ-C35/2-NA-DC
40	FAZ-C40/1-NA-DC-SP	FAZ-C40/2-NA-DC

Notes

- ① Option for single packaging on single-pole C and D curves only; add suffix SP when ordering.
- ② 240 Vac rated only.
- ③ Option for single packaging on single-pole C curves only; add suffix SP when ordering.

**FAZ-RT UL 489 Circuit Breakers with Ring-Tongue
Terminals— 10 kAIC, 14 kAIC D Curve (13–20A)**

Amperes	Single-Pole ^① Catalog Number	Two-Pole Catalog Number	Three-Pole Catalog Number
D Curve with Ring-Tongue Terminals (10–20X I_n Current Rating)			
0.5	FAZ-D0.5/1-RT-SP	FAZ-D0.5/2-RT	FAZ-D0.5/3-RT
1	FAZ-D1/1-RT-SP	FAZ-D1/2-RT	FAZ-D1/3-RT
1.5	FAZ-D1.5/1-RT-SP	FAZ-D1.5/2-RT	FAZ-D1.5/3-RT
2	FAZ-D2/1-RT-SP	FAZ-D2/2-RT	FAZ-D2/3-RT
3	FAZ-D3/1-RT-SP	FAZ-D3/2-RT	FAZ-D3/3-RT
4	FAZ-D4/1-RT-SP	FAZ-D4/2-RT	FAZ-D4/3-RT
5	FAZ-D5/1-RT-SP	FAZ-D5/2-RT	FAZ-D5/3-RT
6	FAZ-D6/1-RT-SP	FAZ-D6/2-RT	FAZ-D6/3-RT
7	FAZ-D7/1-RT-SP	FAZ-D7/2-RT	FAZ-D7/3-RT
8	FAZ-D8/1-RT-SP	FAZ-D8/2-RT	FAZ-D8/3-RT
10	FAZ-D10/1-RT-SP	FAZ-D10/2-RT	FAZ-D10/3-RT
13	FAZ-D13/1-RT-SP	FAZ-D13/2-RT	FAZ-D13/3-RT
15	FAZ-D15/1-RT-SP	FAZ-D15/2-RT	FAZ-D15/3-RT
16	FAZ-D16/1-RT-SP	FAZ-D16/2-RT	FAZ-D16/3-RT
20	FAZ-D20/1-RT-SP	FAZ-D20/2-RT	FAZ-D20/3-RT
25	FAZ-D25/1-RT-SP	FAZ-D25/2-RT	FAZ-D25/3-RT
30	FAZ-D30/1-RT-SP	FAZ-D30/2-RT	FAZ-D30/3-RT
32	FAZ-D32/1-RT-SP	FAZ-D32/2-RT	FAZ-D32/3-RT
35 ^②	FAZ-D35/1-RT-SP	FAZ-D35/2-RT	FAZ-D35/3-RT
40 ^②	FAZ-D40/1-RT-SP	FAZ-C40/2-RT	FAZ-D40/3-RT

1.1

Circuit Protection

Circuit Breakers

1

FAZ UL 1077 Circuit Breakers



Features

- UL 1077 recognized DIN rail mounted supplemental protectors up to 63A
- Current limiting design provides fast short-circuit interruption that reduces let-through energy
- Thermal-magnetic overcurrent protection
 - Three levels of short-circuit protection, categorized by B, C and D curves
- Ideal replacement for fuses that are applied as supplemental protection
- Complete line of accessories

Catalog Number Selection

FAZ UL 1077 Circuit Breakers

FAZ UL 1077

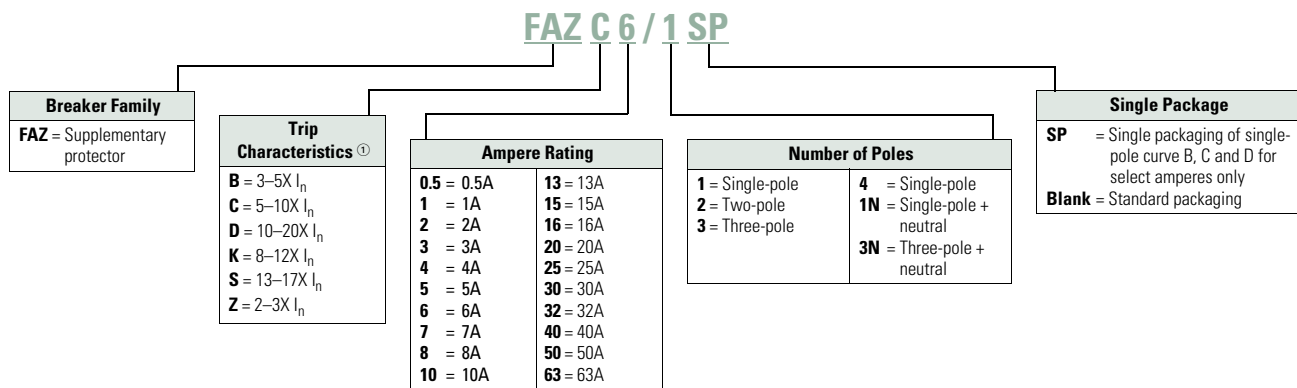

Note

① I_n = Rated current for instantaneous trip characteristics.

Product Selection

B Curve (3–5X I_n Current Rating)—Designed for Resistive or Slightly Inductive Loads ^①

Amperes	Single-Pole ^② Catalog Number	Two-Pole Catalog Number	Three-Pole Catalog Number
1	FAZ-B1/1-SP	FAZ-B1/2	FAZ-B1/3
2	FAZ-B2/1-SP	FAZ-B2/2	FAZ-B2/3
3	FAZ-B3/1-SP	FAZ-B3/2	FAZ-B3/3
4	FAZ-B4/1-SP	FAZ-B4/2	FAZ-B4/3
5	FAZ-B5/1-SP	FAZ-B5/2	FAZ-B5/3
6	FAZ-B6/1-SP	FAZ-B6/2	FAZ-B6/3
7	FAZ-B7/1-SP	FAZ-B7/2	FAZ-B7/3
8	FAZ-B8/1-SP	FAZ-B8/2	FAZ-B8/3
10	FAZ-B10/1-SP	FAZ-B10/2	FAZ-B10/3
12	FAZ-B12/1-SP	FAZ-B12/2	FAZ-B12/3
13	FAZ-B13/1-SP	FAZ-B13/2	FAZ-B13/3
15	FAZ-B15/1-SP	FAZ-B15/2	FAZ-B15/3
16	FAZ-B16/1-SP	FAZ-B16/2	FAZ-B16/3
20	FAZ-B20/1-SP	FAZ-B20/2	FAZ-B20/3
25	FAZ-B25/1-SP	FAZ-B25/2	FAZ-B25/3
30	FAZ-B30/1-SP	FAZ-B30/2	FAZ-B30/3
32	FAZ-B32/1-SP	FAZ-B32/2	FAZ-B32/3
40	FAZ-B40/1-SP	FAZ-B40/2	FAZ-B40/3
50	FAZ-B50/1-SP	FAZ-B50/2	FAZ-B50/3
63	FAZ-B63/1-SP	FAZ-B63/2	FAZ-B63/3

B Curve (3–5X I_n Current Rating)—Designed for Resistive or Slightly Inductive Loads, continued ^①

Amperes	Four-Pole	Single-Pole + Neutral	Three-Pole + Neutral
1	FAZ-B1/4	FAZ-B1/1N	FAZ-B1/3N
2	FAZ-B2/4	FAZ-B2/1N	FAZ-B2/3N
3	FAZ-B3/4	FAZ-B3/1N	FAZ-B3/3N
4	FAZ-B4/4	FAZ-B4/1N	FAZ-B4/3N
5	FAZ-B5/4	FAZ-B5/1N	FAZ-B5/3N
6	FAZ-B6/4	FAZ-B6/1N	FAZ-B6/3N
7	FAZ-B7/4	FAZ-B7/1N	FAZ-B7/3N
8	FAZ-B8/4	FAZ-B8/1N	FAZ-B8/3N
10	FAZ-B10/4	FAZ-B10/1N	FAZ-B10/3N
12	FAZ-B12/4	FAZ-B12/1N	FAZ-B12/3N
13	FAZ-B13/4	FAZ-B13/1N	FAZ-B13/3N
15	FAZ-B15/4	FAZ-B15/1N	FAZ-B15/3N
16	FAZ-B16/4	FAZ-B16/1N	FAZ-B16/3N
20	FAZ-B20/4	FAZ-B20/1N	FAZ-B20/3N
25	FAZ-B25/4	FAZ-B25/1N	FAZ-B25/3N
30	FAZ-B30/4	FAZ-B30/1N	FAZ-B30/3N
32	FAZ-B32/4	FAZ-B32/1N	FAZ-B32/3N
40	FAZ-B40/4	FAZ-B40/1N	FAZ-B40/3N
50	FAZ-B50/4	FAZ-B50/1N	FAZ-B50/3N
63	FAZ-B63/4	FAZ-B63/1N	FAZ-B63/3N

Notes

- ^① In North America, these switches are UL recognized and CSA Certified as supplementary protection devices. Per the intent of NEC (National Electrical Code), Article 240, and CEC (Canadian Electrical Code), Part 1 C22.1, supplementary breakers cannot be used as a substitute for the branch circuit protective device. They can be used to provide overcurrent protection within an appliance or other electrical equipment where branch circuit overcurrent protection is already provided, or is not required.
- ^② Option for single packaging on single-pole B, C and D curves only; add suffix SP when ordering.

1 C Curve (5–10X I_n Current Rating)—Designed Inductive Loads ^①

Amperes	Single-Pole ^② Catalog Number	Two-Pole Catalog Number	Three-Pole Catalog Number
0.5	FAZ-C0.5/1-SP	FAZ-C0.5/2	FAZ-C0.5/3
1	FAZ-C1/1-SP	FAZ-C1/2	FAZ-C1/3
1.6	FAZ-C1.6/1-SP	FAZ-C1.6/2	FAZ-C1.6/3
2	FAZ-C2/1-SP	FAZ-C2/2	FAZ-C2/3
3	FAZ-C3/1-SP	FAZ-C3/2	FAZ-C3/3
4	FAZ-C4/1-SP	FAZ-C4/2	FAZ-C4/3
5	FAZ-C5/1-SP	FAZ-C5/2	FAZ-C5/3
6	FAZ-C6/1-SP	FAZ-C6/2	FAZ-C6/3
7	FAZ-C7/1-SP	FAZ-C7/2	FAZ-C7/3
8	FAZ-C8/1-SP	FAZ-C8/2	FAZ-C8/3
10	FAZ-C10/1-SP	FAZ-C10/2	FAZ-C10/3
13	FAZ-C13/1-SP	FAZ-C13/2	FAZ-C13/3
15	FAZ-C15/1-SP	FAZ-C15/2	FAZ-C15/3
16	FAZ-C16/1-SP	FAZ-C16/2	FAZ-C16/3
20	FAZ-C20/1-SP	FAZ-C20/2	FAZ-C20/3
25	FAZ-C25/1-SP	FAZ-C25/2	FAZ-C25/3
30	FAZ-C30/1-SP	FAZ-C30/2	FAZ-C30/3
32	FAZ-C32/1-SP	FAZ-C32/2	FAZ-C32/3
40	FAZ-C40/1-SP	FAZ-C40/2	FAZ-C40/3
50	FAZ-C50/1-SP	FAZ-C50/2	FAZ-C50/3
63	FAZ-C63/1-SP	FAZ-C63/2	FAZ-C63/3

C Curve (5–10X I_n Current Rating)—Designed Inductive Loads, continued ^①

Amperes	Four-Pole	Single-Pole + Neutral	Three-Pole + Neutral
0.5	FAZ-C0.5/4	FAZ-C0.5/1N	FAZ-C0.5/3N
1	FAZ-C1/4	FAZ-C1/1N	FAZ-C1/3N
1.6	FAZ-C1.6/4	FAZ-C1.6/1N	FAZ-C1.6/3N
2	FAZ-C2/4	FAZ-C2/1N	FAZ-C2/3N
3	FAZ-C3/4	FAZ-C3/1N	FAZ-C3/3N
4	FAZ-C4/4	FAZ-C4/1N	FAZ-C4/3N
5	FAZ-C5/4	FAZ-C5/1N	FAZ-C5/3N
6	FAZ-C6/4	FAZ-C6/1N	FAZ-C6/3N
7	FAZ-C7/4	FAZ-C7/1N	FAZ-C7/3N
8	FAZ-C8/4	FAZ-C8/1N	FAZ-C8/3N
10	FAZ-C10/4	FAZ-C10/1N	FAZ-C10/3N
13	FAZ-C13/4	FAZ-C13/1N	FAZ-C13/3N
15	FAZ-C15/4	FAZ-C15/1N	FAZ-C15/3N
16	FAZ-C16/4	FAZ-C16/1N	FAZ-C16/3N
20	FAZ-C20/4	FAZ-C20/1N	FAZ-C20/3N
25	FAZ-C25/4	FAZ-C25/1N	FAZ-C25/3N
30	FAZ-C30/4	FAZ-C30/1N	FAZ-C30/3N
32	FAZ-C32/4	FAZ-C32/1N	FAZ-C32/3N
40	FAZ-C40/4	FAZ-C40/1N	FAZ-C40/3N
50	FAZ-C50/4	FAZ-C50/1N	FAZ-C50/3N
63	FAZ-C63/4	FAZ-C63/1N	FAZ-C63/3N

Notes

- ^① In North America, these switches are UL recognized and CSA Certified as supplementary protection devices. Per the intent of NEC (National Electrical Code), Article 240, and CEC (Canadian Electrical Code), Part 1 C22.1, supplementary breakers cannot be used as a substitute for the branch circuit protective device. They can be used to provide overcurrent protection within an appliance or other electrical equipment where branch circuit overcurrent protection is already provided, or is not required.
- ^② Option for single packaging on single-pole B, C and D curves only; add suffix SP when ordering.

D Curve (10–20X I_n Current Rating)—Designed for Inductive Loads ^①

Amperes	Single-Pole ^② Catalog Number	Two-Pole Catalog Number	Three-Pole Catalog Number
0.5	FAZ-D0.5/1-SP	FAZ-D0.5/2	FAZ-D0.5/3
1	FAZ-D1/1-SP	FAZ-D1/2	FAZ-D1/3
2	FAZ-D2/1-SP	FAZ-D2/2	FAZ-D2/3
3	FAZ-D3/1-SP	FAZ-D3/2	FAZ-D3/3
4	FAZ-D4/1-SP	FAZ-D4/2	FAZ-D4/3
5	FAZ-D5/1-SP	FAZ-D5/2	FAZ-D5/3
6	FAZ-D6/1-SP	FAZ-D6/2	FAZ-D6/3
7	FAZ-D7/1-SP	FAZ-D7/2	FAZ-D7/3
8	FAZ-D8/1-SP	FAZ-D8/2	FAZ-D8/3
10	FAZ-D10/1-SP	FAZ-D10/2	FAZ-D10/3
13	FAZ-D13/1-SP	FAZ-D13/2	FAZ-D13/3
15	FAZ-D15/1-SP	FAZ-D15/2	FAZ-D15/3
16	FAZ-D16/1-SP	FAZ-D16/2	FAZ-D16/3
20	FAZ-D20/1-SP	FAZ-D20/2	FAZ-D20/3
25	FAZ-D25/1-SP	FAZ-D25/2	FAZ-D25/3
30	FAZ-D30/1-SP	FAZ-D30/2	FAZ-D30/3
32	FAZ-D32/1-SP	FAZ-D32/2	FAZ-D32/3
40	FAZ-D40/1-SP	FAZ-D40/2	FAZ-D40/3
50 ^③	FAZ-D50/1-SP	FAZ-D50/2	FAZ-D50/3
63 ^③	FAZ-D63/1-SP	FAZ-D63/2	FAZ-D63/3

D Curve (10–20X I_n Current Rating)—Designed for Inductive Loads, continued ^①

Amperes	Four-Pole	Single-Pole + Neutral	Three-Pole + Neutral
0.5	FAZ-D0.5/4	FAZ-D0.5/1N	FAZ-D0.5/3N
1	FAZ-D1/4	FAZ-D1/1N	FAZ-D1/3N
2	FAZ-D2/4	FAZ-D2/1N	FAZ-D2/3N
3	FAZ-D3/4	FAZ-D3/1N	FAZ-D3/3N
4	FAZ-D4/4	FAZ-D4/1N	FAZ-D4/3N
5	FAZ-D5/4	FAZ-D5/1N	FAZ-D5/3N
6	FAZ-D6/4	FAZ-D6/1N	FAZ-D6/3N
7	FAZ-D7/4	FAZ-D7/1N	FAZ-D7/3N
8	FAZ-D8/4	FAZ-D8/1N	FAZ-D8/3N
10	FAZ-D10/4	FAZ-D10/1N	FAZ-D10/3N
13	FAZ-D13/4	FAZ-D13/1N	FAZ-D13/3N
15	FAZ-D15/4	FAZ-D15/1N	FAZ-D15/3N
16	FAZ-D16/4	FAZ-D16/1N	FAZ-D16/3N
20	FAZ-D20/4	FAZ-D20/1N	FAZ-D20/3N
25	FAZ-D25/4	FAZ-D25/1N	FAZ-D25/3N
30	FAZ-D30/4	FAZ-D30/1N	FAZ-D30/3N
32	FAZ-D32/4	FAZ-D32/1N	FAZ-D32/3N
40	FAZ-D40/4	FAZ-D40/1N	FAZ-D40/3N
50 ^③	FAZ-D50/4	FAZ-D50/1N	FAZ-D50/3N
63 ^③	FAZ-D63/4	FAZ-D63/1N	FAZ-D63/3N

Notes

- ^① In North America, these switches are UL recognized and CSA Certified as supplementary protection devices. Per the intent of NEC (National Electrical Code), Article 240, and CEC (Canadian Electrical Code), Part 1 C22.1, supplementary breakers cannot be used as a substitute for the branch circuit protective device. They can be used to provide overcurrent protection within an appliance or other electrical equipment where branch circuit overcurrent protection is already provided, or is not required.
- ^② Option for single packaging on single-pole B, C and D curves only; add suffix SP when ordering.
- ^③ IEC 60947-2 only.

Accessories

FAZ-NA UL 489 Breakers

Description	Catalog Number
Two-pole contact or auxiliary contact/trip indicating contact	Z-NHK ^①
Auxiliary contact	Z-IHK-NA
Shunt trip 110–415 Vac	FAZ-XAA-NA110-415VAC
Shunt trip 12–110 Vac	FAZ-XAA-NA12-110VAC
Padlock hasp	IS/SPE-1TE
Busbar—single-pole, 6 terminals ^{②③④⑤}	Z-SV/UL-16/1P-1TE/6
Busbar—single-pole, 12 terminals ^{②③④⑤}	Z-SV/UL-16/1P-1TE/12
Busbar—single-pole, 18 terminals ^{②③④⑤}	Z-SV/UL-16/1P-1TE/18
Busbar—two-pole, 6 terminals ^{②③④⑤}	Z-SV/UL-16/2P-2TE/6
Busbar—two-pole, 12 terminals ^{②③④⑤}	Z-SV/UL-16/2P-2TE/12
Busbar—two-pole, 18 terminals ^{②③④⑤}	Z-SV/UL-16/2P-2TE/18
Busbar—three-pole, 6 terminals ^{②③④⑤}	Z-SV/UL-16/3P-3TE/6
Busbar—three-pole, 12 terminals ^{②③④⑤}	Z-SV/UL-16/3P-3TE/12
Busbar—three-pole, 18 terminals ^{②③④⑤}	Z-SV/UL-16/3P-3TE/18
Three-pole busbar shroud	ZV-BS-UL
Extension terminal—35 mm ² (2–14 AWG)	Z-EK/35/UL
Bus connector—conductors up to 50 mm ² (~1/0 AWG)	Z-EB/50/UL

FAZ UL 1077 Auxiliary Contacts

Description	Rated Operational Voltage	Catalog Number
Standard Auxiliary Contacts		
1NO/1NC Installs on left side of FAZ or shunt trip Max. one per FAZ (1077) device Switches when FAZ is tripped electrically or manually	230 Vac	FAZ-XHIN11
1 changeover contact Installs on left side of FAZ or shunt trip Max. one per FAZ (1077) device Switches when FAZ is tripped electrically or manually	230 Vac	FAZ-XHINW1
Auxiliary/Trip Indicating Contact		
Small selector screw changes mode Two Form C (changeover) contacts Installs on left side of FAZ or shunt trip Auxiliary contacts switch when FAZ is tripped electrically or manually Trip indicating contact switches only when FAZ is tripped electrically	230 Vac	FAZ-XAM002
Undervoltage Trip		
Prevents FAZ from operating unless voltage is present	115 Vac	FAZ-XUA(115VAC)
Installs on left side of FAZ	230 Vac	FAZ-XUA(230VAC)
Includes test button	400 Vac	FAZ-XUA(400VAC)
Shunt Trip		
Allows remote trip of FAZ Installs on left side of FAZ	12–110 Vac 12–60 Vdc	FAZ-XAA-C-12-110VAC
	110–415 Vac 110–230 Vdc	FAZ-XAA-C-110-415VAC

FAZ UL 1077 Busbar System

Rated Operational Current	Number of Poles per Device	Number of Terminals	Catalog Number ^⑤
Without Auxiliary Contacts			
80A	1	57	BB-UL-18/1P-1M/57
	2	56	BB-UL-18/2P-2M/56
	3	57	BB-UL-18/3P-3M/57
100A	1	57	BB-UL-25/1P-1M/57
	2	56	BB-UL-25/2P-2M/56
	3	57	BB-UL-25/3P-3M/57
Auxiliary/Trip Indicating Contacts			
80A	1	37	BB-UL-18/1P-1.5M/37
	2	46	BB-UL-18/2P+AS-2.5M/46
	3	48	BB-UL-18/3P+AS-3.5M/48
100A	1	37	BB-UL-25/1P-1.5M/37
	2	46	BB-UL-25/2P+AS-2.5M/46
	3	48	BB-UL-25/3P+AS-3.5M/48

Pin Type Incoming Supply Terminals

Description	Catalog Number
Accommodates conductors from 6–35 mm ² /#10–2 AWG 4–5.5 Nm/35–50 lb-in / Two- and three-pole	BB-UL-TEP/35

Pin Type Incoming Supply Terminals—Single-Phase Only

Description	Catalog Number
Accommodates conductors from 6–35 mm ² /#10–2 AWG 4–5.5 Nm/35–50 lb-in	BB-UL-TEPA/35

Protective Accessories

Description	Catalog Number
For covering unused terminals	BB-IP/5
Prevents reactivation of the device during maintenance Holds one padlock	IS/SPE-1TE

Bus Incoming Supply Terminals

Description	Catalog Number
50 mm ² #14–1 AWG 75 Deg wire 115 A/Y, 480V UL 160 A/Y 690V IEC	BB-UL-TE/50

Busbar End Cap

Description	Poles	Catalog Number
Install after cutting busbar	2 and 3	BB-UL-EC/3
Protects end of busbar	1	BB-UL-EC/1

Notes

- ① Voltage of FAZ-NA circuit breaker is limited to 300V with this auxiliary contact installed.
- ② Do not cut commoning link.
- ③ A maximum of three commoning links may be used in conjunction. Each breaker connected to the commoning link must have the same number of poles for proper use.
- ④ Not for use with ring-tongue circuit breakers.
- ⑤ Bus may be center fed for high current capacity.

Series NRX Low Voltage Power Breakers**Series NRX™ Low Voltage Power Breakers****Features**

- Rogowski coil does not saturate like iron core sensors, and one sensor accommodates 200–1600A range. Never change a sensor, and NO CTs are required
- Tension clamp secondary terminals—10A continuous rating at 600V meets UL/CSA/RoHS and UL-94 V0. Mounted directly to fixed breaker or drawout cassette they reduce wiring and provide clean, organized wiring schemes
- Breaker mounted communication modules for INCOM™, Modbus® and PROFIBUS® mount directly to the cassette, reducing the space and room required for communication capability
- With the patent pending simple design of the fold-up cassette, all items in a cassette are replaceable without removing the cassette from the cell
- Plug-and-play accessories—no special tools needed. Accessories come with plug and wires ready to install

Catalog Number Selection

Series NRX Power Breakers (Exclusionary Rules Apply)

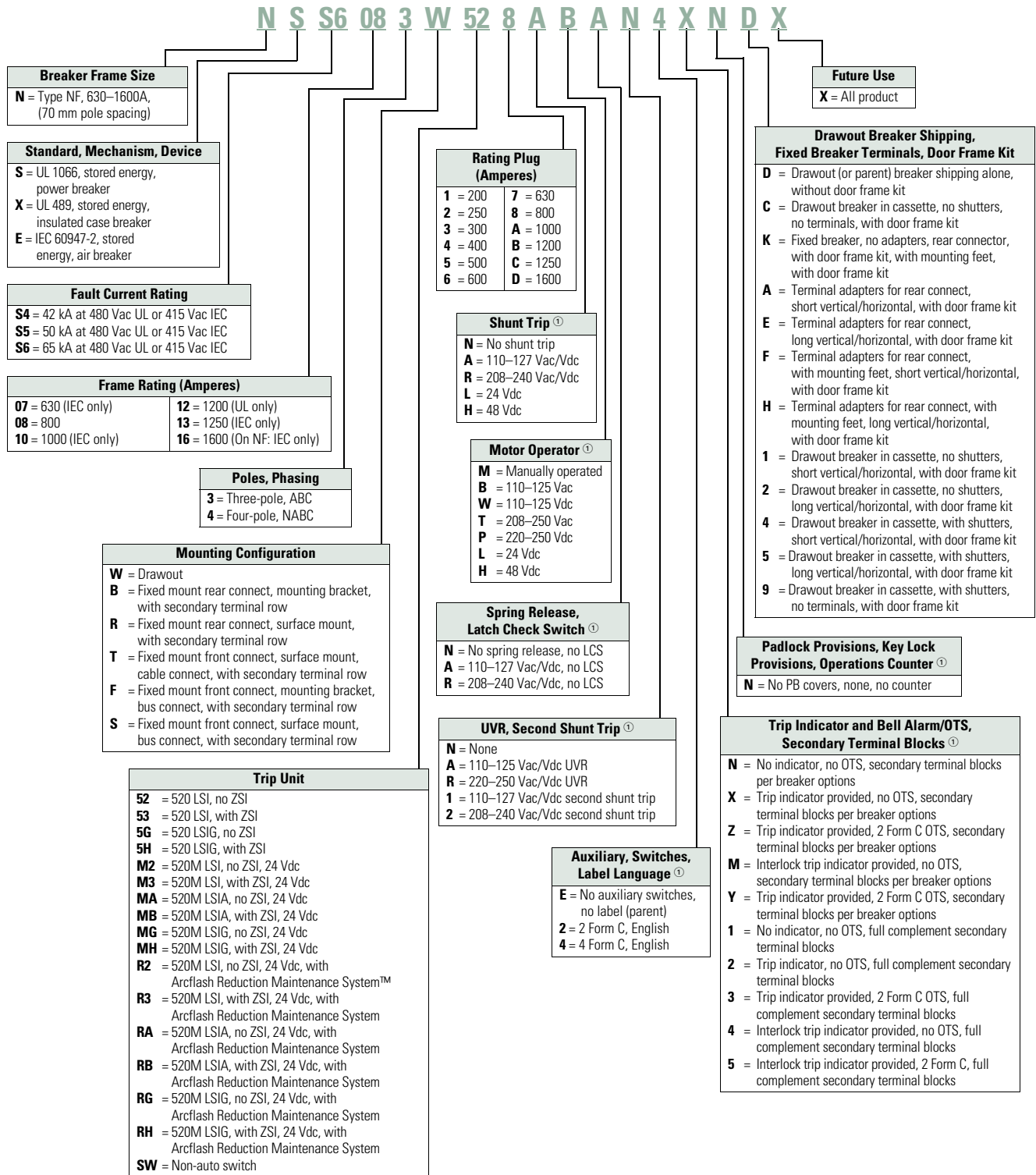

Note
 ① Contact Eaton for available voltages. Not all voltages are currently available.

Catalog Number Selection

Series NRX Cassettes

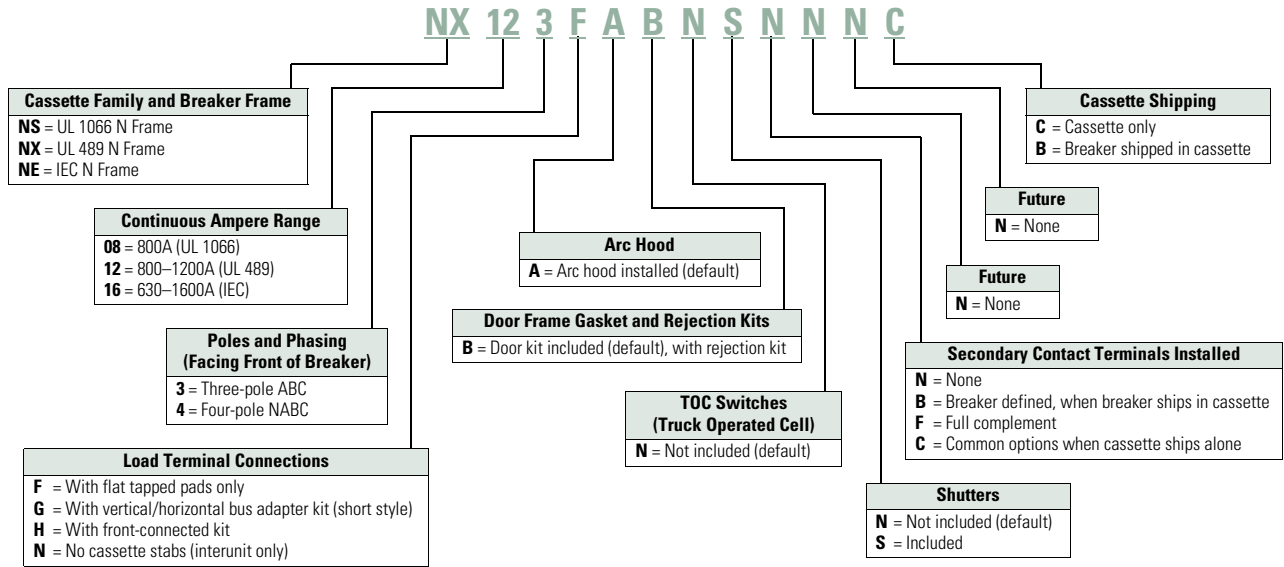

Product Selection

Series NRX Low Voltage Power Breakers

Breaker Frame	Industry Standard	Fault Current Rating (kAIC)	Frame Rating in Amperes	Poles	Mounting	Trip Unit	Rating Plug	Part Number ②
N	UL 1066	42	800	3	Drawout ①	520 LSI (No ZSI)	800	NSS4083W528
N	UL 1066	42	800	4	Fixed	520 LSI (No ZSI)	800	NSS4084B528
N	UL 1066	50	800	3	Drawout ①	520 LSI (No ZSI)	800	NSS5083W528
N	UL 1066	50	800	4	Fixed	520 LSI (No ZSI)	800	NSS5084B528
N	UL 1066	65	800	3	Drawout ①	520 LSI (No ZSI)	800	NSS6083W528
N	UL 1066	65	800	3	Fixed	520 LSI (No ZSI)	800	NSS6083B528
N	UL 1066	65	800	4	Drawout ①	520 LSI (No ZSI)	800	NSS6084W528
N	UL 1066	65	800	4	Fixed	520 LSI (No ZSI)	800	NSS6084B528
N	UL 489	42	800	3	Drawout ①	520 LSI (No ZSI)	800	NXS4083W528
N	UL 489	42	1200	4	Drawout ①	520 LSI (No ZSI)	1200	NXS4124W528
N	UL 489	50	800	3	Fixed	520 LSI (No ZSI)	800	NXS5083B528
N	UL 489	50	1200	4	Fixed	520 LSI (No ZSI)	1200	NXS5124B528
N	UL 489	65	800	3	Drawout ①	520 LSI (No ZSI)	800	NXS6083W528
N	UL 489	65	800	4	Fixed	520 LSI (No ZSI)	800	NSS6084B528
N	UL 489	65	1200	3	Drawout ①	520 LSI (No ZSI)	1200	NXS6123W528
N	UL 489	65	1200	4	Fixed	520 LSI (No ZSI)	1200	NXS6124B528
N	IEC	42	630	3	Drawout ①	520 LSI (No ZSI)	630	NES4073W527
N	IEC	42	1600	4	Drawout ①	520 LSI (No ZSI)	1600	NES4164W52D
N	IEC	50	630	3	Fixed	520 LSI (No ZSI)	630	NES5073B527
N	IEC	50	1600	4	Fixed	520 LSI (No ZSI)	1600	NES5164B52D
N	IEC	65	630	3	Drawout ①	520 LSI (No ZSI)	630	NES6073W527
N	IEC	65	800	4	Fixed	520 LSI (No ZSI)	800	NES6084B528
N	IEC	65	1250	3	Fixed	520 LSI (No ZSI)	1250	NES6133B52C
N	IEC	65	1600	4	Drawout ①	520 LSI (No ZSI)	1600	NES6164W52D

Notes

- ① See Page V9-T1-34 for cassette selection for drawout breakers.
- ② See selection above for accessories in positions 12–20.

Magnum Low Voltage Power Breakers**Features**

- Rated up to 6300A with interrupting ratings up to 200 kAIC and withstand ratings up to 100 kAIC
- Magnum® DS is UL 1066 listed for one-half second short-time withstand rating, and rated for 30 cycles. It is a switchgear class product to meet UL 1558 switchgear standards
- Magnum SB is a UL 1066 listed product with one-half second short-time withstand rating at three cycles to meet switchboard class product specifications, such as UL 891
- Magnum DS MDDX is the highest interrupting performance in a non-current limiting breaker construction rated up to 200 kAIC with 100 kAIC short-time withstand
- The Magnum DS, Magnum SB and Magnum IEC lines all offer the smallest double narrow 4000A frame available

Magnum Low Voltage Power Breakers

Catalog Number Selection

Magnum ANSI/UL Low Voltage Power Breakers

MD S 4 12 3 V E A 06 MU A W C H N E H K L A X

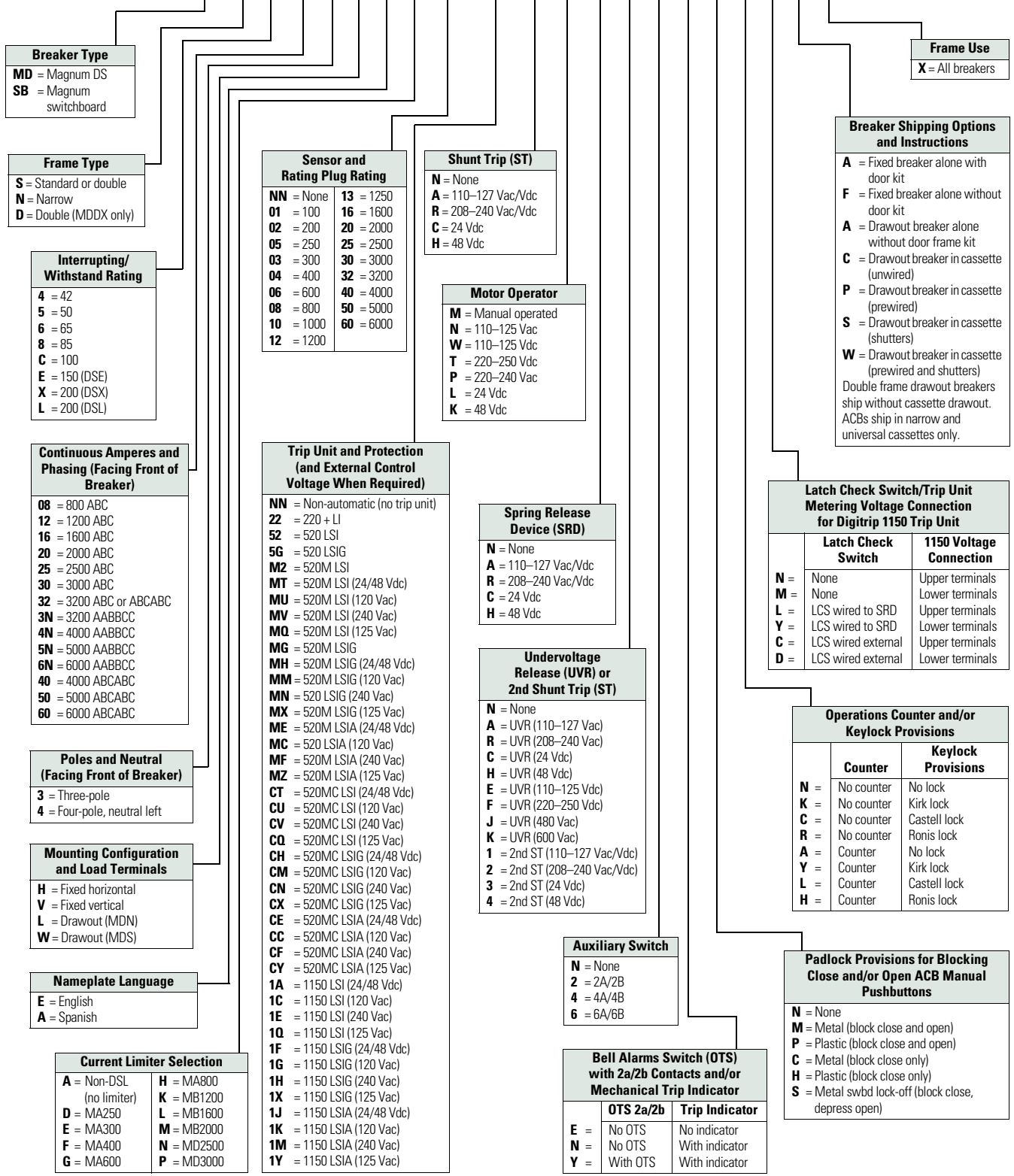

Breaker Type

MD = Magnum DS
SB = Magnum switchboard

Frame Type

S = Standard or double
N = Narrow
D = Double (MDDX only)

Interrupting/Withstand Rating

4 = 42
5 = 50
6 = 65
8 = 85
C = 100
E = 150 (DSE)
X = 200 (DSX)
L = 200 (DSL)

Continuous Amperes and Phasing (Facing Front of Breaker)

08 = 800 ABC
12 = 1200 ABC
16 = 1600 ABC
20 = 2000 ABC
25 = 2500 ABC
30 = 3000 ABC
32 = 3200 ABC or ABCABC
3N = 3200 AABBC
4N = 4000 AABBC
5N = 5000 AABBC
6N = 6000 AABBC
40 = 4000 ABCABC
50 = 5000 ABCABC
60 = 6000 ABCABC

Poles and Neutral (Facing Front of Breaker)

3 = Three-pole
4 = Four-pole, neutral left

Mounting Configuration and Load Terminals

H = Fixed horizontal
V = Fixed vertical
L = Drawout (MDN)
W = Drawout (MDS)

Nameplate Language

E = English
A = Spanish

Current Limiter Selection

A = Non-DSL (no limiter)	H = MA800
D = MA250	K = MB1200
E = MA300	L = MB1600
F = MA400	M = MB2000
G = MA600	N = MD2500
	P = MD3000

Sensor and Rating Plug Rating

NN = None	13 = 1250
01 = 100	16 = 1600
02 = 200	20 = 2000
05 = 250	25 = 2500
03 = 300	30 = 3000
04 = 400	32 = 3200
06 = 600	40 = 4000
08 = 800	50 = 5000
10 = 1000	60 = 6000
12 = 1200	

Shunt Trip (ST)

N = None
A = 110–127 Vac/Vdc
R = 208–240 Vac/Vdc
C = 24 Vdc
H = 48 Vdc

Motor Operator

M = Manual operated
N = 110–125 Vac
W = 110–125 Vdc
T = 220–250 Vdc
P = 220–240 Vac
L = 24 Vdc
K = 48 Vdc

Trip Unit and Protection (and External Control Voltage When Required)

NN = Non-automatic (no trip unit)
22 = 220 + LI
52 = 520 LSI
5G = 520 LSIG
M2 = 520M LSI
MT = 520M LSI (24/48 Vdc)
MU = 520M LSI (120 Vac)
MV = 520M LSI (240 Vac)
MQ = 520M LSI (125 Vac)
MG = 520M LSIG
MH = 520M LSIG (24/48 Vdc)
MM = 520M LSIG (120 Vac)
MN = 520M LSIG (240 Vac)
MX = 520M LSIG (125 Vac)
ME = 520M LSIA (24/48 Vdc)
MC = 520 LSIA (120 Vac)
MF = 520M LSIA (240 Vac)
MZ = 520M LSIA (125 Vac)
CT = 520MC LSI (24/48 Vdc)
CU = 520MC LSI (120 Vac)
CV = 520MC LSI (240 Vac)
CQ = 520MC LSI (125 Vac)
CH = 520MC LSIG (24/48 Vdc)
CM = 520MC LSIG (120 Vac)
CN = 520MC LSIG (240 Vac)
CX = 520MC LSIG (125 Vac)
CE = 520MC LSIA (24/48 Vdc)
CC = 520MC LSIA (120 Vac)
CF = 520MC LSIA (240 Vac)
CY = 520MC LSIA (125 Vac)
1A = 1150 LSI (24/48 Vdc)
1C = 1150 LSI (120 Vac)
1E = 1150 LSI (240 Vac)
1Q = 1150 LSI (125 Vac)
1F = 1150 LSIG (24/48 Vdc)
1G = 1150 LSIG (120 Vac)
1H = 1150 LSIG (240 Vac)
1X = 1150 LSIG (125 Vac)
1J = 1150 LSIA (24/48 Vdc)
1K = 1150 LSIA (120 Vac)
1M = 1150 LSIA (240 Vac)
1Y = 1150 LSIA (125 Vac)

Spring Release Device (SRD)

N = None
A = 110–127 Vac/Vdc
R = 208–240 Vac/Vdc
C = 24 Vdc
H = 48 Vdc

Undervoltage Release (UVR) or 2nd Shunt Trip (ST)

N = None
A = UVR (110–127 Vac)
R = UVR (208–240 Vac)
C = UVR (24 Vdc)
H = UVR (48 Vdc)
E = UVR (110–125 Vdc)
F = UVR (220–250 Vdc)
J = UVR (480 Vac)
K = UVR (600 Vac)
1 = 2nd ST (110–127 Vac/Vdc)
2 = 2nd ST (208–240 Vac/Vdc)
3 = 2nd ST (24 Vdc)
4 = 2nd ST (48 Vdc)

Auxiliary Switch

N = None
2 = 2A/2B
4 = 4A/4B
6 = 6A/6B

Bell Alarms Switch (OTS) with 2a/2b Contacts and/or Mechanical Trip Indicator

	OTS 2a/2b	Trip Indicator
E =	No OTS	No indicator
N =	No OTS	With indicator
Y =	With OTS	With indicator

Frame Use

X = All breakers

Breaker Shipping Options and Instructions

A = Fixed breaker alone with door kit
F = Fixed breaker alone without door kit
A = Drawout breaker alone without door frame kit
C = Drawout breaker in cassette (unwired)
P = Drawout breaker in cassette (prewired)
S = Drawout breaker in cassette (shutters)
W = Drawout breaker in cassette (prewired and shutters)
Double frame drawout breakers ship without cassette drawout. ACBs ship in narrow and universal cassettes only.

Latch Check Switch/Trip Unit Metering Voltage Connection for Digitrip 1150 Trip Unit

	Latch Check Switch	1150 Voltage Connection
N =	None	Upper terminals
M =	None	Lower terminals
L =	LCS wired to SRD	Upper terminals
Y =	LCS wired to SRD	Lower terminals
C =	LCS wired external	Upper terminals
D =	LCS wired external	Lower terminals

Operations Counter and/or Keylock Provisions

	Counter	Keylock Provisions
N =	No counter	No lock
K =	No counter	Kirk lock
C =	No counter	Castell lock
R =	No counter	Ronis lock
A =	Counter	No lock
Y =	Counter	Kirk lock
L =	Counter	Castell lock
H =	Counter	Ronis lock

Padlock Provisions for Blocking Close and/or Open ACB Manual Pushbuttons

N = None
M = Metal (block close and open)
P = Plastic (block close and open)
C = Metal (block close only)
H = Plastic (block close only)
S = Metal swbd lock-off (block close, depress open)

1.1

Circuit Protection

Circuit Breakers

1 Magnum ANSI/UL Low Voltage Air Circuit Breaker Cassettes

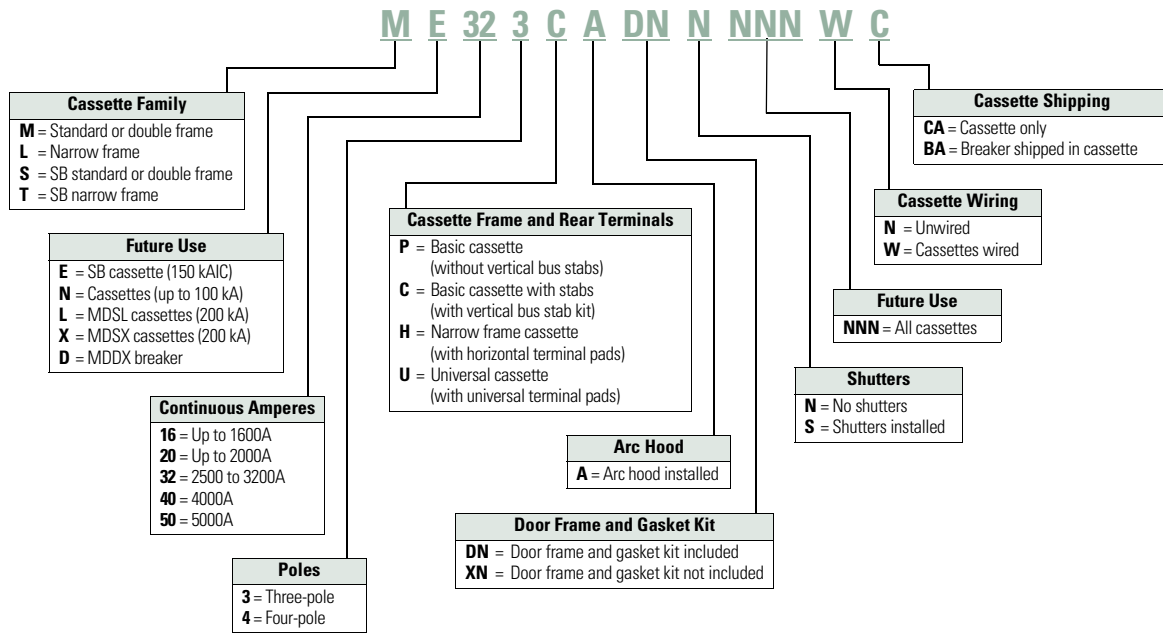

Magnum IEC Low Voltage Air Circuit Breakers

MW I 4 08 3 H E A - 02 22 A M A A 2 E M K L A X

Breaker Frame
I = Standard or double
N = Narrow
K = Special 1100 Vac ACB

Interrupting I_{CU}
4 = 40 kA
5 = 50 kA
6 = 65 kA
8 = 85 kA
C = 100 kA
2 = 25 kA (1100 Vac MWK)

Continuous Amperes and Phasing (Facing Front of Breaker)
08 = 800 ABC
10 = 1000 ABC
12 = 1250 ABC
16 = 1600 ABC
20 = 2000 ABC
25 = 2500 ABC
32 = 3200 ABC
4N = 4000 AABBC
5N = 5000 AABBC
6N = 6300 AABBC
40 = 4000 ABCABC
50 = 5000 ABCABC
60 = 6300 ABCABC

Poles and Neutral (Facing Front of Breaker)
3 = Three
4 = Four (neutral left)
R = Four (reserved for neutral right)

Mounting Configuration and Load Terminals
H = Fixed horizontal
V = Fixed vertical
L = Drawout horizontal

Nameplate Language
E = English
A = Spanish

Sensor and Rating Plug Rating

NN = None	13 = 1250
02 = 200	16 = 1600
05 = 250	20 = 2000
03 = 300	25 = 2500
04 = 400	30 = 3000
06 = 600	32 = 3200
07 = 630	40 = 4000
08 = 800	50 = 5000
10 = 1000	63 = 6300
12 = 1200	

Trip Unit Protection, (and External Control Voltage When Required)

NN = Non-automatic (no trip unit)
22 = 220 LI
52 = 520 LSI
5W = 520i LSIG
M2 = 520M LSI
MT = 520M LSI (24–48 Vdc)
MU = 520M LSI (120 Vac)
MV = 520M LSI (240 Vac)
MW = 520Mi LSIG
MJ = 520Mi LSIG (24–48 Vdc)
MK = 520Mi LSIG (120 Vac)
ML = 520Mi LSIG (240 Vac)
ME = 520M LSI/A (24–48 Vdc)
MC = 520M LSI/A (120 Vac)
MF = 520M LSI/A (240 Vac)
CT = 520MC LSI
CU = 520MC LSI
CV = 520MC LSI
CE = 520MC LSI/A
CC = 520MC LSI/A
CJ = 520MC LSI/A
CF = 520MCi LSIG
CK = 520MCi LSIG
CL = 520MCi LSIG
1W = 1150i LSI (24–48 Vdc)
1N = 1150i LSI (120 Vac)
1P = 1150i LSI (240 Vac)
1R = 1150i LSI/A (24–48 Vdc)
1S = 1150i LSI/A (120 Vac)
1T = 1150i LSI/A (240 Vac)

Auxiliary Switch
N = None
2 = 2A/2B
4 = 4A/4B
6 = 6A/6B

Shunt Trip Attachment (STA)
N = None
A = 110–127 Vac
R = 208–240 Vac
C = 24 Vdc
H = 48 Vdc

Motor Operator
M = Manual operated
N = 110–125 Vac
W = 110–125 Vdc
T = 220–250 Vdc
P = 220–250 Vac
L = 24 Vdc
K = 48 Vdc

Spring Release Device (SRD)
N = None
A = 110–127 Vac/Vdc
R = 208–240 Vac/Vdc
C = 24 Vdc
H = 48 Vdc

Undervoltage Release (UVR) or 2nd Shunt Trip Attachment (STA)

N = None
A = 110–127 Vac
R = 208–240 Vac
C = 24 Vdc
H = 48 Vdc
E = 110–125 Vdc
F = 220–250 Vdc
G = 32 Vdc
X = 380–415 Vac
J = 480 Vac
K = 600 Vac
1 = 2nd STA (110–127 Vac/Vdc)
2 = 2nd STA (208–250 Vac/Vdc)
3 = 2nd STA (24 Vdc)
4 = 2nd STA (48 Vdc)

Future Use
X = All ACBs

ACB Shipping Instructions
A = Fixed ACB with door kit
F = Fixed ACB without door kit
A = D/O ACB only without door kit
C = D/O ACB in cassette (unwired)
P = D/O ACB in cassette (prewired)
S = D/O ACB in cassette (shutters)
W = D/O ACB in cassette (prewired and shutters)
 Double frame D/O ACBs ship without cassette

Latch Checking Switch/Trip Unit Metering Voltage Connection for Digitrip 1150 Trip Unit

	Latch Check Switch	1150 Voltage Connection
N =	None	Upper terminals
M =	None	Lower terminals
L =	LCS wired to SRD	Upper terminals
Y =	LCS wired to SRD	Lower terminals
C =	LCS wired external	Upper terminals
D =	LCS wired external	Lower terminals

Operations Counter and/or Keylock Provisions

	Counter	Keylock Provisions
N =	No counter	No lock
K =	No counter	Kirk lock
C =	No counter	Castell lock
R =	No counter	Ronis lock
A =	Counter	No lock
T =	Counter	Kirk lock
L =	Counter	Castell lock
H =	Counter	Ronis lock

Padlock Provisions for Blocking Close and/or Open ACB Manual Pushbuttons

N = None
M = Metal (block close and open)
P = Plastic (block close and open)
C = Metal (block close only)
H = Plastic (block close only)

Bell Alarms Switch (OTS) with 2a/2b Contacts and/or Mechanical Trip Indicator

	OTS 2a/2b	Trip Indicator
E =	No OTS	No indicator
N =	No OTS	With indicator
Y =	With OT	With indicator

1.1

Circuit Protection

Circuit Breakers

1 Magnum IEC Low Voltage Air Circuit Breaker Cassettes

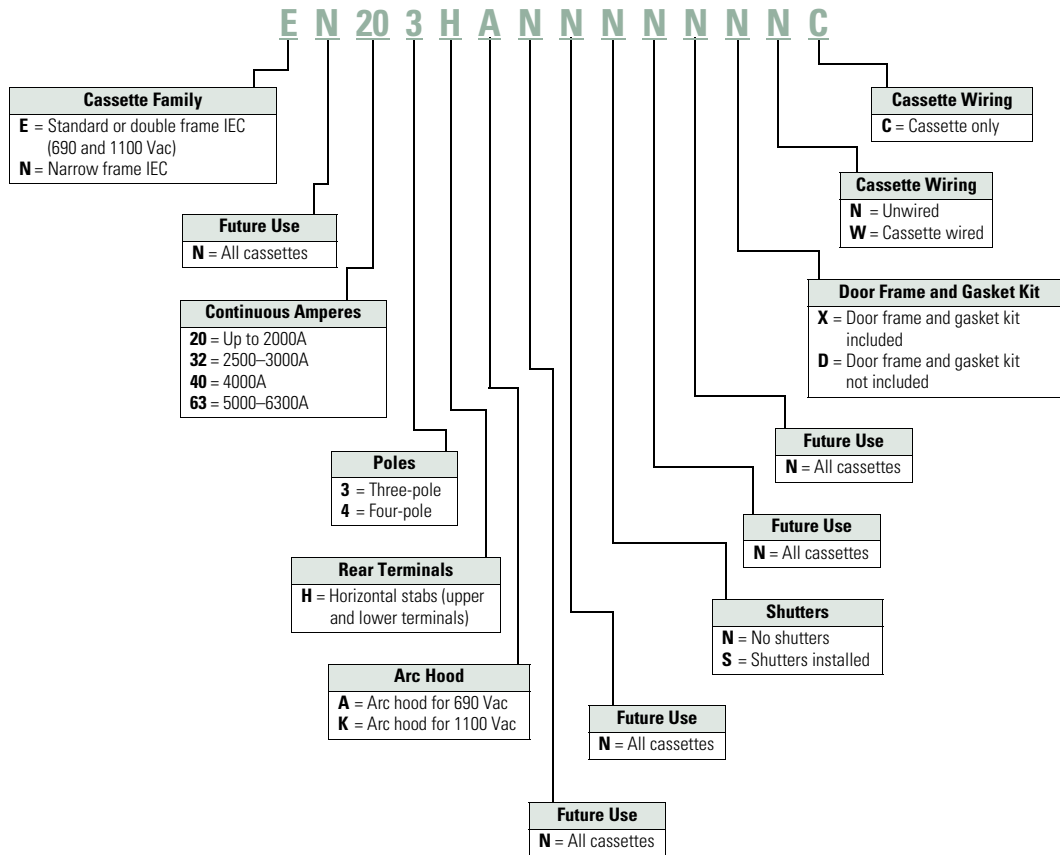

Product Selection

Magnum DS Switchgear Class UL 1066 Low Voltage Power Circuit Breakers

Frame Type	RMS Symmetrical Current Ratings kA 50/60 Hz ^①			Short Time Current Rating	Frame Amperes	Breaker Type ^②	
	Interrupting at 254 Vac	Interrupting at 508 Vac	Interrupting at 635 Vac				
Narrow	42	42	42	42	800	MDN-408	
	50	50	50	50		MDN-508	
	65	65	65	65		MDN-608	
	100	100	65	20		MDN-C08	
Standard	42	42	42	42	800	MDS-408	
	65	65	65	65		MDS-608	
	85	85	85	85		MDS-808	
	100	100	100	85		MDS-C08	
	200	200	200	—		MDS-L08 ^③	
Narrow	42	42	42	42	1600	MDN-416	
	50	50	50	50		MDN-516	
	65	65	65	65		MDN-616	
	100	100	65	30		MDN-C16	
Standard	65	65	65	65	1600	MDS-616	
	85	85	85	85		MDS-816	
	100	100	100	85		MDS-C16	
	200	200	200	—		MDS-L16 ^③	
	200	200	④	30		MDS-X16 ^⑤	
Narrow	65	65	65	65	2000	MDN-620	
	100	100	65	35		MDN-C20	
Standard	65	65	65	65	2000	MDS-620	
	85	85	85	85		MDS-820	
	100	100	100	85		MDS-C20	
	200	200	200	—		MDS-L20 ^③	
	200	200	④	30		MDS-X20 ^⑤	
	65	65	65	65		3200	MDS-632
85	85	85	85	MDS-832			
100	100	100	85	MDS-C32			
Double	200	200	④	50	3200	MDS-X32 ^⑤	
Double (N)	85	85	④	85	4000	MDN-840	
	100	100	④	100		MDN-C40	
Double	85	85	85	85	4000	MDS-840	
	100	100	100	100		MDS-C40	
	200	200	④	50		MDS-X40 ^⑤	
	200	200	④	100	4000	MDD-X40	
	85	85	85	85		5000	MDS-850
	100	100	100	100			MDS-C50
	200	200	④	50	6000	MDS-X50 ^{⑤⑦}	
	200	200	④	100		MDD-X50	
	100	100	100	100		MDS-C60 ^⑦	
	200	200	④	100		MDD-X60	

Notes

- ① Interrupting ratings shown based on breaker equipped with integral Digitrip RMS trip unit. Interruption ratings for non-automatic breakers are equal to the published short time current rating. These interruption ratings are based on the standard duty cycle consisting of an open operation, a 15-second interval and a close-open operation, in succession, with delayed tripping in case of short-delay devices. The standard duty cycle for short time ratings consists of maintaining the rated current for two periods of 1/2 seconds each, with a 15-second interval of zero current between the two periods.
- ② See **Page V9-T1-40** for selection of trip unit and accessories. See **Page V9-T1-40** for cassette selection for drawout breakers.
- ③ Magnum MDSL current limiting power circuit breaker with integral current limiters. Current limiter selected determines short time and maximum instantaneous trip rating. Maximum voltage rating is 600 Vac.
- ④ Product to be tested. Contact Eaton for product rating.
- ⑤ Magnum MDSX current limiting power circuit breaker with fast opening contacts.
- ⑥ Contact Eaton for availability.
- ⑦ Breaker applied in a tested fan-cooled enclosure.

Magnum SB Switchboard Class UL 1066 Insulated Case Low Voltage Power Circuit Breakers

Frame Type	RMS Symmetrical Current Ratings kA 50/60 Hz ^①			Short Time Current Rating	Frame Amperes	Breaker Type ^②
	Interrupting at 254 Vac	Interrupting at 508 Vac	Interrupting at 635 Vac			
Narrow	50	50	35	20	800	SBN-508
	65	65	42	20		SBN-608
	100	100	65	20		SBN-C08
Standard	65	65	65	20	800	SBS-608
	100	100	85	20		SBS-C08
	200	150	②	30		SBS-E08 ^③
Narrow	50	50	35	25	1200	SBN-512
	65	65	42	25		SBN-612
	100	100	65	25		SBN-C12
Standard	65	65	65	25	1200	SBS-612
	100	100	85	25		SBS-C12
	200	150	②	30		SBS-E12 ^③
Narrow	50	50	35	30	1600	SBN-516
	65	65	42	30		SBN-616
	100	100	65	30		SBN-C16
Standard	65	65	65	30	1600	SBS-616
	100	100	85	30		SBS-C16
	200	150	②	30		SBS-E16 ^③
Narrow	65	65	65	35	2000	SBN-620
	100	100	65	35		SBN-C20
Standard	65	65	65	35	2000	SBS-620
	100	100	85	35		SBS-C20
	200	150	②	30		SBS-E20 ^③
Narrow	65	65	65	45	2500	SBS-625
	100	100	85	45		SBS-C25
Double	200	150	②	50		SBS-E25 ^③
Standard	65	65	65	50	3000	SBS-630
	100	100	85	50		SBS-C30
Double	200	150	②	50		SBS-E30 ^③
Double (N)	85	85	③	85	4000	SBN-840
	100	100	③	100		SBN-C40
Double	85	85	85	85	5000	SBS-840
	100	100	100	100		SBS-C40
	200	150	②	50		SBS-E40 ^③
Double	85	85	85	85	5000	SBS-850
	100	100	100	100		SBS-C50
Double	200	150	②	50	6000	SBS-E50 ^{③④}
	100	100	100	100		SBS-C60 ^④

Notes

- ① Interrupting ratings shown based on breaker equipped with integral Digitrip RMS trip unit. Interruption ratings for non-automatic breakers are equal to the published short time current rating. These interruption ratings are based on the standard duty cycle consisting of an open operation, a 15-second interval and a close-open operation, in succession, with delayed tripping in case of short-delay devices. The standard duty cycle for short time ratings consists of maintaining the rated current for two periods of 1/2 seconds each, with a 15-second interval of zero current between the two periods.
- ② Product to be tested. Contact Eaton for product rating.
- ③ Magnum SBSE current limiting power circuit breaker with fast opening contacts.
- ④ Breaker applied in a tested fan-cooled enclosure.

Magnum IEC 60947-2 Rated Low Voltage Air Circuit Breakers

Frame Amperes	Breaker Type	Frame Type	rms Symmetrical Current Ratings kA ^①			Withstand Rating I _{CW} 1-Sec/3-Sec	Fixed Internal Inst. Trip	Available Current Sensor and Rating Plugs for Digitrip RMS Trip Unit (Establishes Breaker I _n Rating)
			Interrupting at 240 Vac I _{CU} = I _{CS}	Interrupting at 440 Vac I _{CU} = I _{CS}	Interrupting at 690 Vac I _{CU} = I _{CS}			
800	MWN-408	Narrow	40	40	40	40/—	—	200, 250, 300, 400, 630, 800
	MWN-508	Narrow	50	50	50	50/—	—	
	MWN-608	Narrow	65	65	65	65/40	—	
	MWI-608	Standard	65	65	65	65/—	—	
	MWI-808	Standard	85	85	85	85/65	—	
	MWI-C08	Standard	100	100	85	85/65	85	
1000	MWN-410	Narrow	40	40	40	40/—	—	200, 250, 300, 400, 630, 800, 1000
	MWN-510	Narrow	50	50	50	50/—	—	
	MWN-610	Narrow	65	65	65	65/40	—	
	MWI-610	Standard	65	65	65	65/—	—	
	MWI-810	Standard	85	85	85	85/65	—	
	MWI-C10	Standard	100	100	85	85/65	85	
1250	MWN-412	Narrow	40	40	40	40/—	—	200, 250, 300, 400, 630, 800, 1000, 1250
	MWN-512	Narrow	50	50	50	50/—	—	
	MWN-612	Narrow	65	65	65	65/40	—	
	MWI-612	Standard	65	65	65	65/—	—	
	MWI-812	Standard	85	85	85	85/65	—	
	MWI-C12	Standard	100	100	85	85/65	85	
1600	MWN-516	Narrow	50	50	50	50/—	—	200, 250, 300, 400, 630, 800, 1000, 1250, 1600
	MWN-616	Narrow	65	65	65	65/40	—	
	MWI-616	Standard	65	65	65	65/—	—	
	MWI-816	Standard	85	85	85	85/65	—	
	MWI-C16	Standard	100	100	85	85/65	85	
2000	MWN-520	Narrow	50	50	50	50/30	—	200, 250, 300, 400, 630, 800, 1000, 1250, 1600, 2000
	MWN-620	Narrow	65	65	65	65/40	—	
	MWI-620	Standard	65	65	65	65/50	—	
	MWI-820	Standard	85	85	85	85/65	—	
	MWI-C20	Standard	100	100	85	85/65	85	
2500	MWI-625	Standard	65	65	65	65/—	—	200, 250, 300, 400, 630, 800, 1000, 1250, 1600, 2000, 2500
	MWI-825	Standard	85	85	85	85/65	—	
	MWI-C25	Standard	100	100	85	85/65	85	
3200	MWI-632	Standard	65	65	65	65/50	—	200, 250, 300, 400, 630, 800, 1000, 1250, 1600, 2000, 2500, 3200
	MWI-832	Standard	85	85	85	85/65	—	
	MWI-C32	Standard	100	100	85	85/65	85	
4000	MWI-64N	Double	65	65	65	65/—	—	2000, 2500, 3200, 4000
	MWI-84N	Double	85	85	85	85/—	—	
	MWI-C4N	Double	100	100	100	100/—	—	
5000	MWI-85N	Double	85	85	85	85/—	—	2500, 3200, 4000, 5000
	MWI-C5N	Double	100	100	100	100/—	—	
6300	MWI-86N	Double	85	85	85	85/—	—	3200, 4000, 5000, 6300
	MWI-C6N	Double	100	100	100	100/—	—	

Note

^① Interrupting ratings shown based on breaker equipped with integral Digitrip RMS trip unit. Interruption ratings for non-automatic breakers are equal to the published breaker I_{CW} rating.

Product Overview**Fuse Blocks and Fuse Holders**

Description	C350 Series
	Page V9-T1-45
Technical Data	
Number of poles	Up to 3
Mounting	35 mm flat or 32 mm asymmetrical DIN rail (with optional adapter)
Terminal ratings	600V, 30A
Housing construction	Thermoplastic UL 94V0 flammability rating
Clip/terminal construction	Tin-plated copper alloy
Screw/pressure plate construction	Zinc-plated steel
Dielectric strength	1200V
Approvals	
	UL, CSA

For our complete product offering, see Volume 4—Circuit Protection, CA08100005E.

C350 Series Fuse Blocks and Fuse Holders



Features

- Space-saving design
- Rated 600V, 30A
- UL approved for motor loads

Product Selection

C350 Series

Fuse Blocks and Fuse Holders

Wire Termination	Number of Poles	250V			600V				
		30A Catalog Number	Carton Qty.	60A Catalog Number	Carton Qty.	30A Catalog Number	Carton Qty.	60A Catalog Number	Carton Qty.
Class H Fuse Holders									
Single collar (box lug)—sized to ampere rating	1	W231HA	10	W261HA	10	W631HA	10	W661HA	1
	2	W232HA	5	W262HA	5	W632HA	5	W662HA	1
	3	W233HA	5	W263HA	5	W633HA	1	W663HA	2
Class M Fuse Holders									
Combination of double quick-connect, 20A max., and binding head screw, #10 max., Cu/Al	1	—	—	—	—	WM631F	10	—	—
	2	—	—	—	—	WM632F	8	—	—
	3	—	—	—	—	WM633F	6	—	—
Combination of double quick-connect, 20A max., and pressure plate screw, #10 max., Cu only	1	—	—	—	—	WM631G	10	—	—
	2	—	—	—	—	WM632G	8	—	—
	3	—	—	—	—	WM633G	6	—	—
Class R Fuse Holders									
Single collar (box lug)—sized to ampere rating	1	WR231HA	10	—	—	WR631HA	10	—	—
	2	—	—	—	—	WR632HA	5	—	—
	3	WR233HA	5	WR263HA	1	WR633HA	5	WR663HA	5
Combination of double quick-connect, 20A max., and binding head screw, #10 max., Cu/Al	1	—	—	—	—	—	—	—	—
	2	—	—	—	—	WMR632F	1	—	—
	3	—	—	—	—	WMR633F	6	—	—
Combination of double quick-connect, 20A max., and pressure plate screw, #10 max., Cu only	1	—	—	—	—	WMR631G	10	—	—
	3	—	—	—	—	WMR633G	6	—	—
Class R Fuse Holder, Type WRR Control Transformer Fuse Block									
Combination of double quick-connect, 20A max., and pressure plate screw, #14–#10 Cu only	3	—	—	—	—	WRR633G	6	—	—

Open Rotary Disconnects

Product Overview

Rotary Disconnect Switch Selection Guide



**R5 Series
Non-Fusible 16–80A**



**R9 Series
Non-Fusible 30–100A Compact**



**R9 Series
Non-Fusible 100–1200A**

Description

Page V9-T1-48

Page V9-T1-50

Page V9-T1-52

Product Description

R5 Series (UL 508 listed) products are manually operated modular switches. Load break switching and isolation provide safety solutions for any low voltage circuit, particularly for machine and control circuits. The R5 Series products are manual motor controllers suitable as motor disconnect.

The R9 Series (UL 98 listed) non-fusible 30–100A compact range ensures making or breaking on load and safety isolation for low voltage electrical circuits, particularly for machine control circuits up to 600V.

The R9 Series (UL 98 listed) non-fusible 100–1200A are manually operated multipole load-break switches. Quick-make, quick-break design provides safety isolation for any low voltage circuit.

Approvals

UL 508 listed, Guide NLRV, File E165150
CSA C22.2 No. 14, File 217736
IEC 60947-3, EN 60947-3
CCC

UL 98, File E222859
CSA 22.2 No. 4, File 217736
IEC 60947-3
EN 60947-3

UL 98, File E222859
CSA 22.2 No. 4, File 217736
IEC 60947-3
EN 60947-3



**R9 Series
Fusible 30–800A**



**R9 Series
DC Rated Disconnects**



Manual Transfer Switches

Description

Page V9-T1-54

Page V9-T1-59

Page V9-T1-60

Product Description

R9 Series (UL 98 listed) Fusible 30–800A manual operated multi-pole fusible disconnect switches use double break contacts per pole that ensure complete isolation of the fuse when the switch is in the OFF position.

When installed with fuses, they provide protection for low voltage electrical installations against short circuit and overload.

UL listed disconnect switches 600 Vdc for photovoltaic applications 100 to 400A

R9 Series (UL 98 listed) DC rated disconnects are manually operated multi-pole load break switches. They provide safety isolation for any low voltage circuit in a photovoltaic application.

R9 Series (UL 98 listed) non-fusible disconnects are heavy-duty manual transfer switches, they transfer load manually between two low voltage circuits and provide safety disconnection.

These switches are extremely durable and are tested and approved for use in the most demanding applications as resistive load or total system applications.

Approvals

UL 98, File E222859 for 30 to 800A ratings
UL 489, File E305341 for H Frame switches
CSA 22.2 No. 4, File 217736
CSA 22.2 No. 5, File 217736, H Frame only
IEC 60947-1, EN 60947-1
IEC 60947-3, EN 60947-3
CE mark
NFPA® 79

UL 98, cULus®, File E222859
CSA 22.2 No. 4, File 217736 ①
IEC 60947-3
EN 60947-3
IEC 60-364-7-712 (Rules for the installations and sites special—photovoltaic applications)

UL 98, cULus, File E222859
UL 1008 (2011)
CSA 22.2 No. 4, File 217736
IEC 60947-3
EN 60947-3

Note

① Q4 2010

Catalog Number Selection

Disconnects

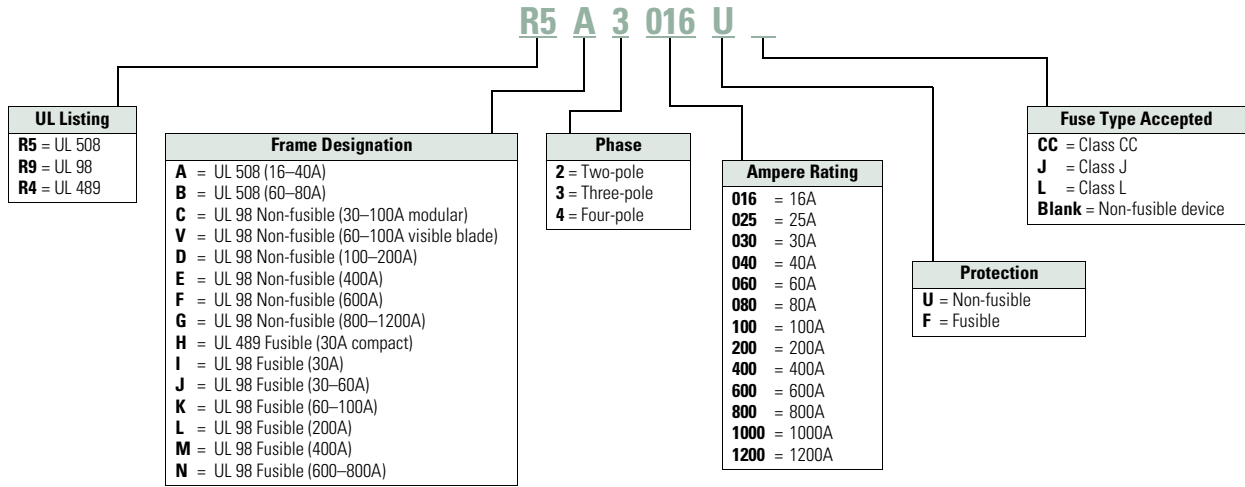

External Handles

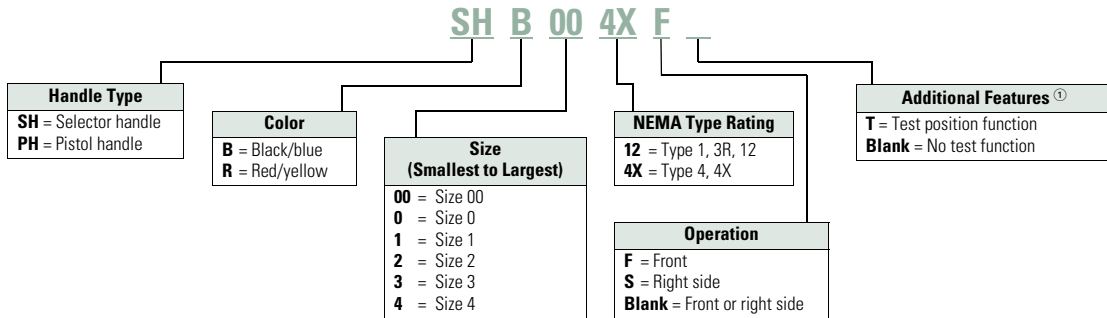

Shafts

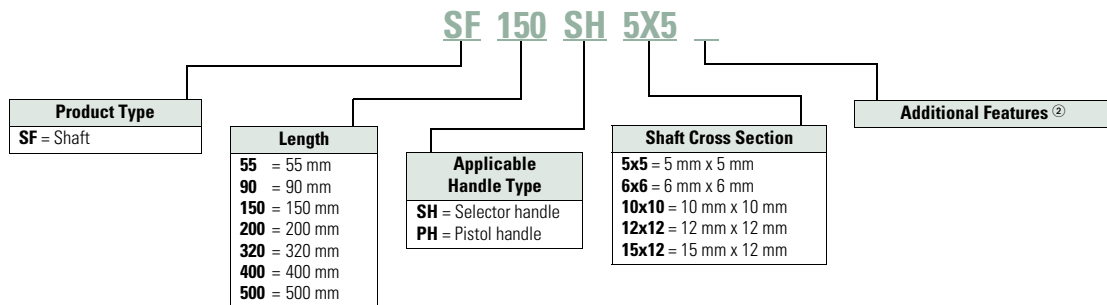

Notes

- ① **HV** at the end of some catalog numbers indicates use with H and V switches only. Not all handles are designed to go with all disconnects. Consult specific section of the catalog for available options.
- ② **H** at the end of some catalog numbers indicates use with H Frame switches only. Not all shafts are designed to go with all disconnects. Consult specific section of the catalog for available options.

1

R5 Series Non-Fusible 16–80A**Features**

- Up to 65 kAIC short-circuit rating
- Direct or external operation
- Compact footprint
- DIN rail or base mount
- Wide range of accessories
- Modular design
- Padlockable design (direct, toggle and external handles)

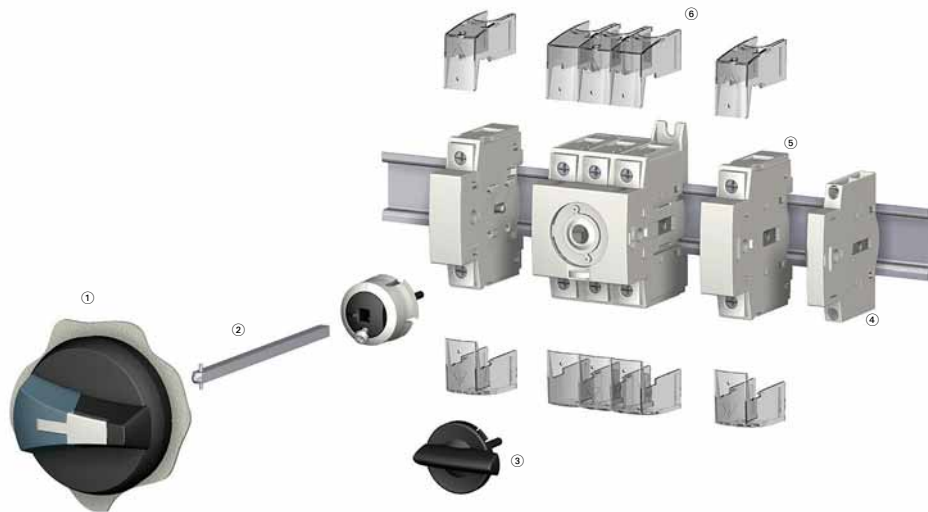
R5 Series Non-Fusible 16–80A**Product Identification**

- ① External front handle
- ② Shaft extension for external handle
- ③ Direct handle
- ④ Auxiliary contacts
- ⑤ Switched fourth-pole module
- ⑥ Terminal shroud

Note: For further details, please see the installation instructions supplied with each device.

Product Selection

Direct Operation



Switch body + Direct handle

External Operation



Switch body + Shaft + External handle

R5 Series



Ampere Rating	Three-Pole Toggle Switch Only ①	Three-Pole Rotary Switch Only	Direct Handle	Front and Right External Handle SH00 (Choose One)	Front and Right External Handle SH0 (Choose One)	Three-Position Front External Handle SH00 (Black) ②	Shaft for SH0 and SH00—5 x 5 mm—In (mm)
16	—	R5A3016U	DHR5	SH00 Black 3R, 12 SHB00N12	SH0 Black 3R, 12 SHB0N12	SH00 4, 4X I–0–II Open transition SHB00MTSOT	2.20 (55.5) SF55SH5X5
25	—	R5A3025U					
30	T5A3030U	R5A3030U					3.50 (90.0) SF90SH5X5
40	T5A3040U	R5A3040U					
60	T5B3060U	R5B3060U		SH00 Red 3R, 12 SHR00N12	SH0 Red 3R, 12 SHR0N12	SH00 4, 4X I–I–II–II Closed transition SHB00MTSCT	5.90 (150.0) SF150SH5X5
80	T5B3080U	R5B3080U		SH00 Black 4, 4X SHB00N4X	SH0 Black 4, 4X SHB0N4X		7.90 (200.0) SF200SH5X5
				SH00 Red 4, 4X SHR00N4X	SH0 Red 4, 4X SHR0N4X		12.60 (320.0) SF320SH5X5

Accessories



Ampere Rating	Switched Fourth-Pole Module	Unswitched Neutral Module	Auxiliary Contacts (Choose One)	Terminal Shrouds	Conversion Kit (Choose One) ②	Door Mounting Kit ③
16	S4PR516	UNMR5A	1NO + 1NC AC1NON	1P TS1R5A	6/8 pole CKR568	DMK
25	S4PR525					
30	S4PR530			3P TS3R5A	Changeover switch Open transition I–0–II	
40	S4PR540		2NO AC2N		MTSCKR50T	
60	S4PR560 ②	UNMR5B		1P TS1R5B		
80	S4PR580 ②			3P TS3R5B	Changeover switch Closed transition I–I–II–II MTSCKR5CT	

Notes

- ① Toggle version includes direct handle.
- ② Available Q2 2011.
- ③ Includes shaft and accessory cap.

1

Non-Fusible 30–100A Compact**Features**

- Rating three-pole from 30A to 100A
- Direct or external operation handle (padlockable in ON position)
- Double breaking per phase
- Small footprint

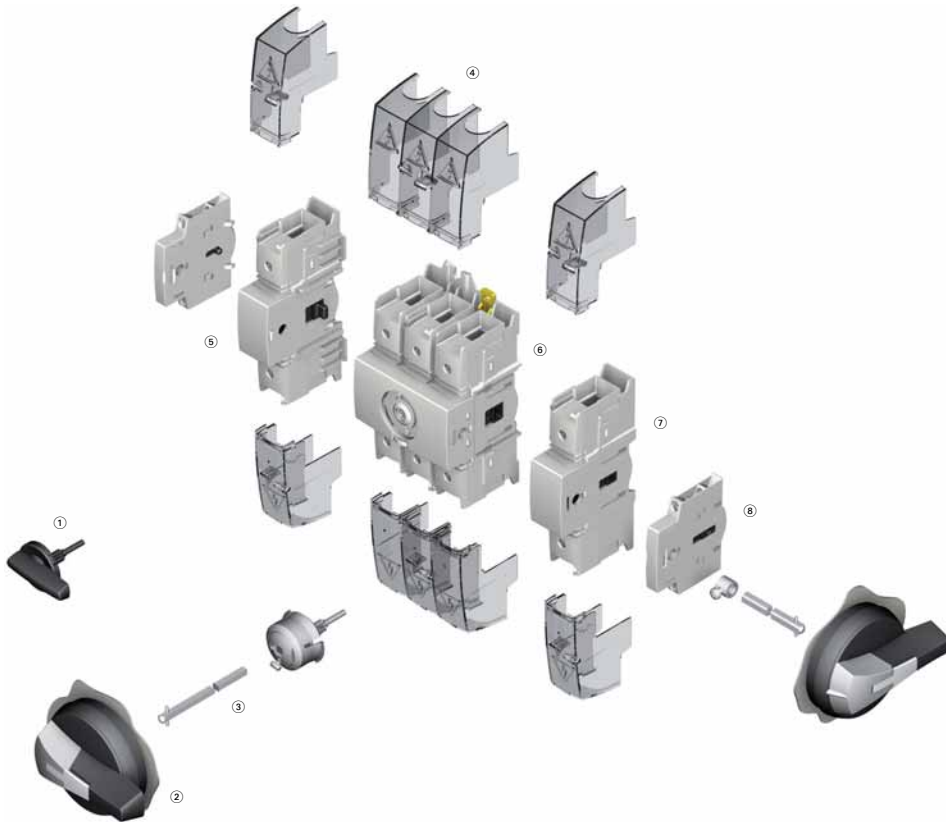
R9 Series Non-Fusible 30–100A Compact**Product Identification**

- ① Direct handle
- ② Door interlocked external handle
- ③ Shaft extension
- ④ Terminal shrouds
- ⑤ Unswitched neutral pole
- ⑥ Switch body
- ⑦ Switched fourth-pole module
- ⑧ Modular type auxiliary contacts

Note: For further details, please see the installation instructions supplied with each device.

Product Selection

Direct Operation



External Operation



R9 Series 30–100A

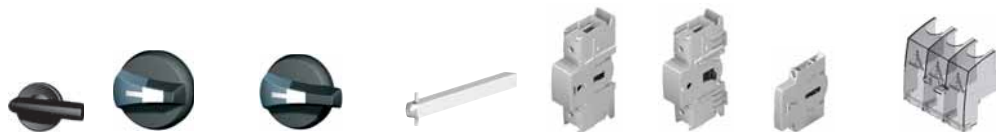

Ampere Rating (Frame)	Number of Poles	Switch Body Only	Direct Handle	Front and Right External Handle SH00 (Choose One)	Front and Right External Handle SH0 (Choose One)	Shaft for SH0 and SH00 Handles—In (mm) (Choose One)	Switched Fourth-Pole Module	Unswitched Neutral Module	Auxiliary Contacts (Choose One)	Terminal Shrouds (Choose One)
30 (C Frame)	3	R9C3030U	DHR9	SH00 Black 3R, 12 SHB00N12	SH0 Black 3R, 12 SHB0N12	2.20 (55.5) SF55SH5X5	S4PR930	Neutral UNMR9C	1NO + 1NC AC1N0NC	1P TS1R9
60 (C Frame)	3	R9C3060U		SH00 Red 3R, 12 SHR00N12	SH0 Red 3R, 12 SHR0N12	3.50 (90.0) SF90SH5X5	S4PR960		2NO AC2N	3P TS3R9CV
100 (C Frame)	3	R9C3100U		SH00 Black 4, 4X SHB00N4X	SH0 Black 4, 4X SHB0N4X	5.91 (150.0) SF150SH5X5	S4PR9100			
				SH00 Red 4 4X SHR00N4X	SH0 Red 4 4X SHR0N4X	7.87 (200.0) SF200SH5X5				
				SH00 Black 4, 4X SHB00N4X	SH0 Black 4, 4X SHB0N4X	12.60 (320.0) SF320SH5X5				
				SH00 Red 4 4X SHR00N4X	SH0 Red 4 4X SHR0N4X					

1

Non-Fusible 100–1200A**Features**

- High thermal and dynamic withstand ratings
- Arduous categories of applications
- High electrical and mechanical endurances

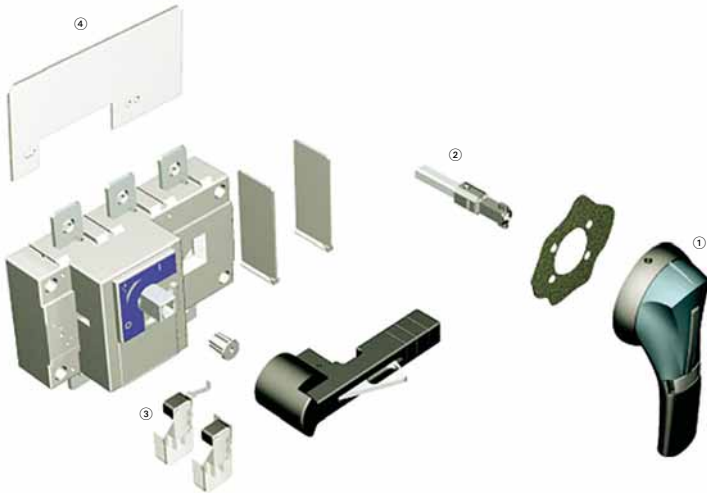
R9 Series Non-Fusible 100–1200A**Product Identification**

- ① External front handle
- ② Shaft extensions for external handle
- ③ Configurable U-type ACs, for pre-break and signalling or TEST
- ④ Terminal Screens

Note: For further details, please see the installation instructions supplied with each device.

Product Selection

Direct Operation

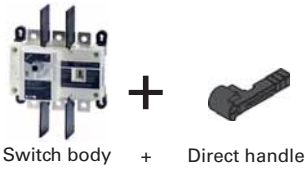

External Operation

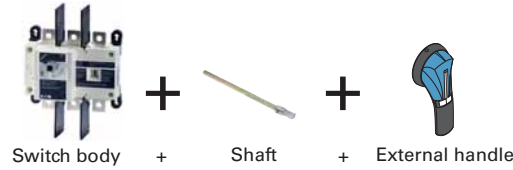

R9 Series Non-Fusible 100–1200A



Ampere Rating (Frame)	Number of Poles	Switch Body Only	Direct Handle	Door Interlocked External Pistol Handle (Choose One)	Shaft Extensions for External Handle—In (mm) (Choose One)	Auxiliary Contacts	Terminal Screens (Choose One)	Terminal Lugs ^③
100 (D Frame)	3	R9D3100U	DHR9DE	Size 2, Black 1, 3R, 12 Defeatable PHB2N12F	7.90 (200.0)	1NO + 1NC AC1N0NCDE AC1N0NCDELL	3-pole, Line side only	LK3R9DL
	4	R9D4100U			12.60 (320.0)		3-pole, Load side only	LK4R9DL
200 (D Frame)	3	R9D3200U	DHR9DE	Size 2, Red 1, 3R, 12 Defeatable PHR2N12F	15.70 (400.0)	2NO + 2NC AC2N0NCDE AC2N0NCDELL	3-pole, Line or load side	LK3R9DL
	4	R9D4200U			19.70 (500.0)		4-pole, Line or load side	LK4R9DL
400 (E Frame)	3	R9E3400U	DHR9DE	Size 2, Black 4, 4X Defeatable PHB2N4XF	19.70 (500.0)	1NO AC U Type AC1N0R9 ^②	3-pole, Line side only	LK3R9EM
	4	R9E4400U			7.90 (200.0)		3-pole, Load side only	LK4R9EM
600 (F Frame)	3	R9F3600U	DHR9FG	Size 3, Black 4, 4X Defeatable PHB3N4XF	7.90 (200.0)	1NC AC U Type AC1NCR9 ^②	3-pole, Line side only	LK3R9FN
	4	R9F4600U			12.60 (320.0)		3-pole, Load side only	LK4R9FN
800 (G Frame)	3	R9G3800U	DHR9FG	Size 3, Red 4, 4X Defeatable PHR3N4XF	12.60 (320.0)	1.70 (400.0)	3-pole, Line side only	LK6R9G
	4	R9G4800U			19.7 (500.0)		3-pole, Load side only	LK8R9G
1000 (G Frame)	3	R9G31000U	DHR9FG	Size 4, Black 4, 4X Defeatable PHB4N4XF	1.70 (400.0)	19.7 (500.0)	4-pole, Line or load side	
	4	R9G41000U			7.90 (200.0)			
1200 (G Frame)	3	R9G31200U	DHR9FG	Size 4, Red 4, 4X Defeatable PHR4N4XF	19.7 (500.0)			
	4	R9G41200U			7.90 (200.0)			

Notes

- ① Top (line side) supplied as standard.
- ② Auxiliary contact requires holder (catalog number ACHFG) when used on F and G Frame switches (non-fusible 600–1200A).
- ③ Each catalog number is for line or load side. For both line and load, please order two sets.

1

Fusible 30–800A



Features

- Load break functionality
- Double break contacts
- Up to 200 kA short-circuit rating with Class CC, J or L fuses
- Compact footprints
- Defeatable pistol handles automatically re-latch when the panel door is closed
- Front or right side operation
- NFPA 79 compliant kits
- Two-, three- and four-pole devices

R9 Series Fusible 30–800A

R9 Fusible 30A/CC and 30A/J (H Frame)— Direct and External Operation



Product Identification

- ① External front handles
- ② Direct handle
- ③ Shaft extensions for external handles
- ④ Configurable U Type ACs, for pre-break and signaling or TEST

R9 Fusible 30A/J–800A/L (I–N Frames)— Direct and External Operation

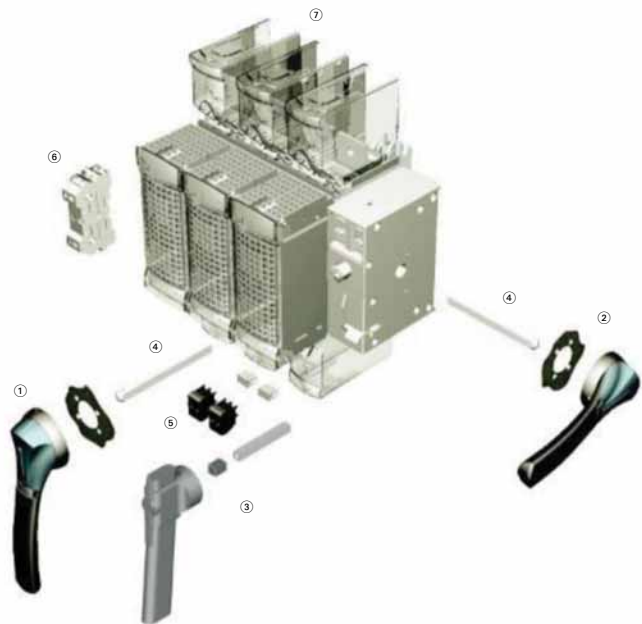

Product Identification

- ① External front handles
- ② External right side handle (not applicable for N Frame 600/800A)
- ③ Direct handle
- ④ Shaft extensions for external handles
- ⑤ Configurable U Type ACs, for pre-break and signaling or TEST
- ⑥ Side auxiliary contacts
- ⑦ Terminal shrouds

Product Selection

Direct Operation



Switch body + Direct handle

External Operation



Switch body + Shaft + External handle

Front and Right Side Operation

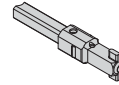

Ampere Rating (Frame) (Fuse Class)	Number of Poles	Switch Body Only	Direct Handle	External Selector Handle (Choose One)	Shaft Extension for Selector Handle Only (Choose One)	External Front Pistol Handle	External Right Side Pistol Handle
30 Compact (H Frame) (CC)	3	R4H3030FCC	DHR9HC	Black 1,3R,12 SHB0N12HV	7.90 (200.0) SF200SH5X5H	Black 1,3R,12 PHB1N12F	—
30 (H Frame) (CC)	3 + switched neutral	R4H3030FCCSN		Red 1,3R,12 SHR0N12HV	12.60 (320.0) SF320SH5X5H	Red 1,3R,12 PHR1N12F	
30 Compact (H Frame) (J)	3	R4H3030FJ	DHR9HJ	Black 4,4X SHB0N4XHV	15.70 (400.0) SF400SH5X5H	Black 4,4X PHB1N4XF	
30 (H Frame) (J)	3 + switched neutral	R4H3030FJSN		Red 4,4X SHR0N4XHV		Red 4,4X PHR1N4XF	
30 (I Frame) (CC)	3	R9I3030FCC	DHR9J2M	—	—		
	4	R9I4030FCC					
30 (J Frame) (J)	2	R9J2030FJ				Black 4,4X (w/ TEST Position) PHB1N4XFT	Black 4, 4X PHB1N4XS
	3	R9J3030FJ					
	4	R9J4030FJ					
60 ① (J Frame) (J)	2	R9J2060FJ				Red 4,4X (w/ TEST Position) PHR1N4XFT	Red 4, 4X PHR1N4XS
	3	R9J3060FJ					
	4	R9J4060FJ					

Note

① 100 kA short-circuit rating.

1.3

Circuit Protection

Rotary Disconnect Switches

1

Front and Right Side Operation, continued



Ampere Rating (Frame) (Fuse Class)	Number of Poles	Switch Body Only	Shaft Extensions for Pistol Handle Only In (mm) (Choose One)	NFPA 79 Kit	Auxiliary Contacts (Choose One)	S Type Auxiliary Contacts (Choose One)	Terminal Shrouds
30 Compact (H Frame) (CC)	3	R4H3030FCC	7.90 (200.0) SF200PH5X5	NFPA79H	1 AC NO AC1NOR9	—	Integral to switch
30 (H Frame) (CC)	3 + switched neutral	R4H3030FCCSN	12.60 (320.0) SF320PH5X5		1 AC NC AC1NCR		
30 Compact (H Frame) (J)	3	R4H3030FJ	15.70 (400.0) SF400PH5X5				
30 (H Frame) (J)	3 + switched neutral	R4H3030FJSN					
30 (I Frame) (CC)	3	R9I3030FCC	7.90 (200.0) SF200PH10X10	NFPA79JKL		1 AC NO + NC AC1N01NCJ2N	
	4	R9I4030FCC					
30 (J Frame) (J)	2	R9J2030FJ	12.60 (320.0) SF320PH10X10			2 AC NO + NC AC2N02NCJ2N	
	3	R9J3030FJ					
	4	R9J4030FJ	15.70 (400.0) SF400PH10X10				
60 [Ⓢ] (J Frame) (J)	2	R9J2060FJ				1 AC NO + NC w/ TEST AC1N01NCJ2NT	
	3	R9J3060FJ	19.70 (500.0) SF500PH10X10				
	4	R9J4060FJ				2 AC NO + NC w/ TEST AC2N02NCJ2NT	

Note

Ⓢ 100 kA short-circuit rating.

Front and Right Side Operation, continued



Ampere Rating (Frame) (Fuse Class)	Number of Poles	Switch Body Only	Direct Handle (Black)	External Front Pistol Handle (Choose One)	External Right Side Pistol Handle (Choose One)
60 [Ⓢ] (K Frame) (J)	2	R9K2060FJ	DHR9J2M	Black 1,3R,12 PHB2N12F	Black 4, 4X PHB2N4XS
	3	R9K3060FJ			
	4	R9K4060FJ			
100 (K Frame) (J)	2	R9K2100FJ		Red 1,3R,12 PHR2N12F	Red 4, 4X PHR2N4XS
	3	R9K3100FJ			
	4	R9K4100FJ			
200 (L Frame) (J)	2	R9L2200FJ		Black 4,4X PHB2N4XF	
	3	R9L3200FJ			
	4	R9L4200FJ			
400 (M Frame) (J)	3	R9M3400FJ		Red 4,4X PHR2N4XF	
	4	R9M4400FJ			
600 (N Frame) (J)	2	R9N2600FJ	DHR9N	Black 4, 4X PHB3N4XF	
	3	R9N3600FJ			
	4	R9N4600FJ			
800 (N Frame) (L)	2	R9N2800FL		Red 4,4X PHR3N4XF	
	3	R9N3800FL			
	4	R9N4800FL			

Note

[Ⓢ] 200 kA short-circuit rating.

1.3

Circuit Protection

Rotary Disconnect Switches

1

Front and Right Side Operation, continued

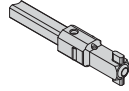

Ampere Rating (Frame) (Fuse Class)	Number of Poles	Switch Body Only	Shaft Extensions for External Handle In (mm) (Choose One)	NFPA 79 Kit	Auxiliary Contacts (Choose One)	Auxiliary Contacts (Choose One)	Terminal Shrouds
60 [Ⓢ] (K Frame) (J)	2	R9K2060FJ	7.90 (200.0)	NFPA79JKL	1 AC NO AC1NOR9	1 AC NO + NC AC1N01NCJ2N	Integral to switch
	3	R9K3060FJ	Pistol SF200PH10X10				
	4	R9K4060FJ					
100 (K Frame) (J)	2	R9K2100FJ	12.60 (320.0)	AC1NCR9	1 AC NC AC1NCR9	2 AC NO + NC AC2NO2NCJ2N	
	3	R9K3100FJ	Pistol SF320PH10X10				
	4	R9K4100FJ					
200 (L Frame) (J)	2	R9L2200FJ	15.70 (400.0)			1 AC NO + NC w/ TEST AC1N01NCJ2NT	TSR9L2
	3	R9L3200FJ	Pistol SF400PH10X10				TSR9L3
	4	R9L4200FJ	19.70 (500.0)				TSR9L4
400 (M Frame) (J)	3	R9M3400FJ	Pistol SF500PH10X10			2 AC NO + NC w/ TEST AC2NO2NCJ2NT	TSR9M3
	4	R9M4400FJ					TSR9M4
600 (N Frame) (J)	2	R9N2600FJ	7.90 (200.0)	NFPA79N		1 AC NO + NC AC1N01NCJ2N	TSR9N2
	3	R9N3600FJ	Pistol SF200PH12X12				TSR9N3
	4	R9N4600FJ					TSR9N4
800 (N Frame) (L)	2	R9N2800FL	12.60 (320.0)			2 AC NO + NC AC2NO2NCJ2N	TSR9N2
	3	R9N3800FL	Pistol SF320PH12X12				TSR9N3
	4	R9N4800FL	15.70 (400.0) Pistol SF400PH12X12				TSR9N4
			19.70 (500.0) Pistol SF500PH12X12				

Note

[Ⓢ] 200 kA short-circuit rating.

DC Rated Disconnects



Features

- Switching technology
- Up to 600 Vdc according to UL 98/CSA
- Up to 1000 Vdc according to IEC 947-3

R9 Series DC Rated Disconnects

Product Selection

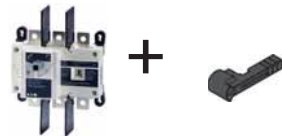

Switch body + Direct handle

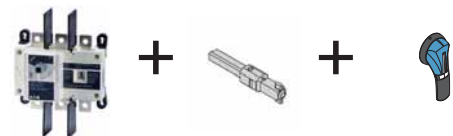

Switch body + Shaft + External handle

Front Operation—Three- and Four-Pole

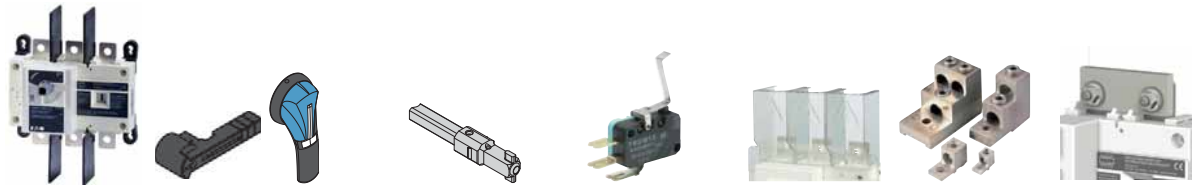

Ampere Rating	Number of Poles	Switch Body	Direct Handle	External Handle (Choose One)	Shaft for External Handle In (mm) (Choose One)	Auxiliary Contacts (Choose One)	Terminals Shroud	Terminal Lugs	Jumpers for Connecting Poles in Series
100	3	R9D3100UDC	DHR9DE	S2 Type	7.90 (200.0)	C Type	3P ②	3P ④	2 pieces
	4	R9D4100UDC		Black 1, 3R, 12 ①	SF200PH10X10	1st Contact NO+NC	TS3R9DT	LK3R9DL	DCJUMP2
200	3	R9D3200UDC		PHB2N12F	12.60 (320.0)	AC1NONCDE	3P ③	4P ④	3 pieces
	4	R9D4200UDC		Red/Yellow 1, 3R, 12 ①	SF320PH10X10	2nd Contact NO+NC	TS3R9DB	LK4R9DL	DCJUMP3
400	3	R9E3400UDC		Black 4, 4X ①	15.7 0 (400.0)	AC2NONCDE	4P ④		
	4	R9E4400UDC		PHB2N4XF	SF400PH10X10		TS4R9DTB		
							3P ②	3P ④	2 pieces
							TS3R9ET	LK3R9EM	DCJUMPE2
							3P ③	4P ④	3 pieces
							TS3R9EB	LK4R9EM	DCJUMPE3
							4P ④		
							TS4R9ETB		

Notes

- ① Defeatable handle.
- ② Top (line side).
- ③ Bottom (load side).
- ④ Top or bottom (line or load side).

Manual Transfer Switches**Features**

- Three load break positions (I, 0, II)
- On load switching
- Direct or external handle
- 480 Vac total system
- 600 Vac resistive load

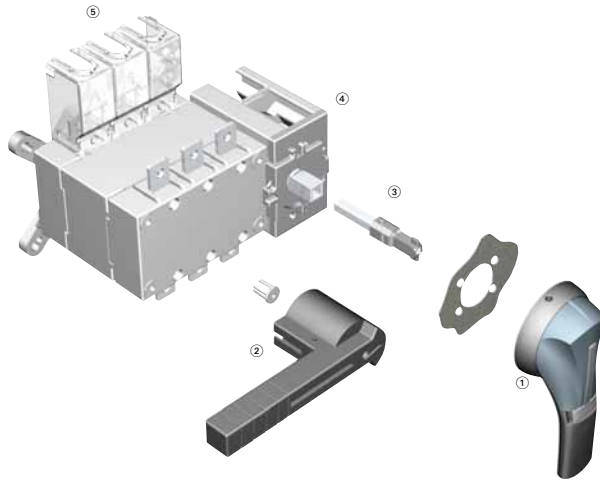
Manual Transfer Switches**Product Identification**

- ① External front handle
- ② Direct handle
- ③ Shaft extension for external handle
- ④ Pre-break ACs (standard on 600–1200A)
- ⑤ Terminal Screen

Product Selection

Direct Operation

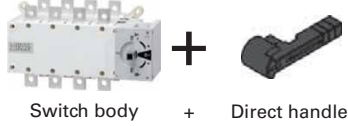

External Operation



Manual Transfer Switches—UL 98 Standard ①

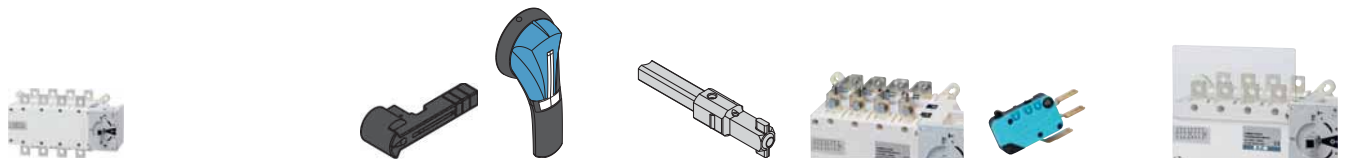

Ampere Rating	Number of Poles	Switch Body Only ①	Direct Handle (Black)	External Three-Position Handle (Choose One)	Shaft Extensions for External Handle In (mm) (Choose One)	Bridging Bars	Auxiliary Contacts	Terminal Screens ②		
100	3	RMTS3100U	DHMTSSL	Size 2, Black I–0–II Type 4/4X PHB2N4X3P	7.90 (200.6) SF200PH10X10	3P BB3P200	NO/NC AC1NONCMTS400	3P TS3MTS200TB		
	4	RMTS4100U			12.60 (320.0) SF320PH10X10					
200	3	RMTS3200U		Size 2, Red I–0–II Type 4/4X PHR2N4X3P	12.60 (320.0) SF320PH10X10	4P BB4P200	Low level AC1NONCMTS400LL ③	4P TS4MTS200TB		
	4	RMTS4200U			15.70 (398.8) SF400PH10X10					
400	3	RMTS3400U		Size 3, Black I–0–II Type 4/4X PHB3N4X3P	7.90 (200.6) SF200PH15X12	3P BB3P400		3P TS3MTS400TB		
	4	RMTS4400U			12.60 (320.0) SF320PH15X12				4P BB4P400	4P TS4MTS400TB
					15.70 (398.8) SF400PH15X12					
600	3	RMTS3600U	DHMTSDL	Size 4, Black I–0–II Type 4/4X PHB4N4X3P		3P BB3P600	NO/NC contact standard	3P TS3MTS600		
	4	RMTS4600U			4P BB4P600	4P TS4MTS600				
800	3	RMTS3800U	DHMTSDLM	Size 4, Red I–0–II Type 4/4X PHR4N4X3P		3P BB3P1200		3P TS3MTS1200		
	4	RMTS4800U			4P BB4P1200	4P TS4MTS1200				
1200	3	RMTS31200U								
	4	RMTS41200U								

Notes

- ① All ratings, 100–1200A, are UL 98 listed. Switches are to be UL 1008 listed in 2011.
- ② Line or load (top or bottom); for both line and load, order two kits.
- ③ Low level auxiliary contact—gold plated for minimal resistance—for PLC applications.

Enclosed Rotary Disconnects**Features**

- Padlockable in the OFF position (up to three padlocks) to meet OSHA lockout requirements
- Available in 16–80A ratings
- 600 Vac, three- and four-pole non-fusible device
- Rated for making and breaking loads
- Accepts auxiliary contacts; capability to signal PLC controllers
- Ground lug connection provided
- Possibility of adding one power pole and one auxiliary contact
- NEMA Type 1, 3R, 12, 4, 4X
- 65kAIC rating when applied downstream from appropriate fusing

Enclosed Rotary Disconnects

Provide users with the ability to lock directly wired motor loads in the OFF position to comply with OSHA lockout/tagout regulations. Also for machine applications that require compact, economical disconnect switches.

Enclosed rotary disconnect switches allow safe control and safe disconnect of any motor application.

Open rotary disconnects can be found on **Pages V9-T1-46 to V9-T1-61** and full information in Volume 5, Motor Control and Protection, CA08100006E, Tab 8.

Product Selection

Enclosed Rotary Non-Fusible

Ampere Rating	Maximum Horsepower Ratings				NEMA 1 ① Enclosure Indoor Catalog Number	NEMA 12 ①② Enclosure Dust-Tight/ Rainproof Catalog Number	NEMA 4X ① Enclosure Corrosion-Resistant, Stainless Steel Catalog Number	NEMA 4X ① Enclosure Corrosion-Resistant, Non-Metallic Catalog Number	NEMA 4X Enclosure Polycarbonate- Non-Metallic Catalog Number
	Three-Phase AC								
	208V	240V	480V	600V					
Three-Pole, 600 Vac									
16	3	5	10	10	ER53016UG	ER53016UD	ER53016UW	ER53016UX	—
25	7-1/2	7-1/2	15	20	ER53025UG	ER53025UD	ER53025UW	ER53025UX	—
30	7-1/2	7-1/2	15	20	ER53030UG	ER53030UD	ER53030UW	ER53030UX	ER53030UPYR ③④
40	7-1/2	7-1/2	20	25	ER53040UG	ER53040UD	ER53040UW	ER53040UX	—
60	15	15	30	30	ER53060UG	ER53060UD	ER53060UW	ER53060UX	ER53060UPYR ③④
80	15	20	40	40	ER53080UG	ER53080UD	ER53080UW	ER53080UX	—
Four-Pole, 600 Vac									
16	3	5	10	10	ER54016UG	ER54016UD	ER54016UW	ER54016UX	—
25	7-1/2	7-1/2	15	20	ER54025UG	ER54025UD	ER54025UW	ER54025UX	—
30	7-1/2	7-1/2	20	25	ER54030UG	ER54030UD	ER54030UW	ER54030UX	—
40	7-1/2	7-1/2	20	25	ER54040UG	ER54040UD	ER54040UW	ER54040UX	—

Accessories for Enclosed Rotary Disconnects ⑤⑥

Disconnect Ampere Rating	Switched Fourth Pole	Unswitched Neutral Pole	Auxiliary Contacts (Choose One)	Terminal Shrouds
16	S4PR516	UNMR5A	1NO + 1NC AC1NONC	Single-pole TS1R5A
25	S4PR525			
30	S4PR530		2NC AC2NC	Three-pole TS3R5A
40	S4PR540			
60	S4PR560 ⑦	UNMR5B ⑦		Single-pole TS1R5B
80	S4PR580 ⑦			Three-pole TS3R5B

Notes

- ① For CSA listed switches, add prefix letter "C" to the front of the catalog number.
- ② NEMA Type 12 enclosures (16–80A) can be field modified to meet NEMA Type 3R rainproof requirements when a factory-provided drain hole is opened.
- ③ YR suffix indicates **Y**ellow cover with **R**ed handle. For **G**ray cover with **B**lack handle, replace "YR" with "GB." For **G**ray cover with **R**ed handle, replace "YR" with "GR."
- ④ cULus only.
- ⑤ Ordered and shipped as separate components—not integral to enclosed device.
- ⑥ Enclosed disconnects can accept one power pole, neutral or up to two auxiliary contacts (one mounted on either side of switch).
- ⑦ Available 2011.

Contact the Safety Switch Flex Center (1-888-329-9272) for factory-installed accessories or other special modifications.