

NEW!
more on reverse

Heavy duty, Non-Metallic QuickLATCH™

Installed Strut Clip • For RIGID and EMT

NEW!



Arlington's heavy duty NM3100 series QuickLATCH™ with installed strut clip holds RIGID and EMT securely on strut. Use it like a pipe hanger.

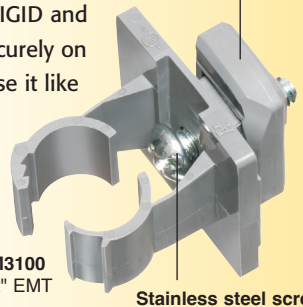

NM3100
1/2" EMT

Stainless steel screw

Fast, Easy Installation!
Saves 20 seconds per installation

One-piece QuickLATCH saves time, about 20 seconds per installation... over 33¢ each at \$60.00 per hour labor rate.

Fast and easy to install. Insert the hanger into the strut, twist to lock the pre-installed clip in place then tighten screw to secure QuickLATCH to strut. Push RIGID or EMT into the hanger to lock it in place.



1 Insert QuickLATCH into strut. The strut clip is already attached so you save time.

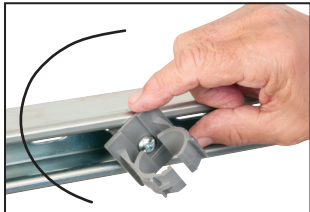

2 Twist QuickLATCH to seat clip in strut.



3 Tighten screw for secure installation on strut.



4 Push conduit into QuickLATCH to snap in place.



5 Secure installation of conduit to strut.



Easy screwdriver removal

- UV rated, corrosion resistant for outdoor use
- Stainless steel screw
- Mounts vertically or horizontally
- Screwdriver removal, reusable
- Listed for use in environmental air handling spaces per 2020 NEC, article 300.22(c)

See reverse for even more QuickLATCH products!

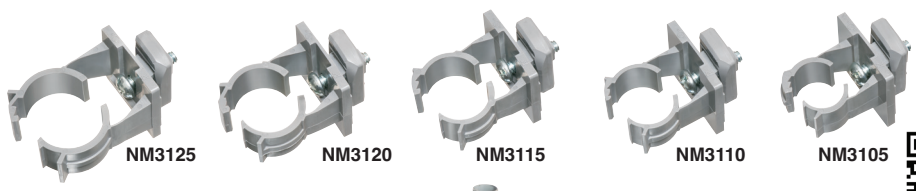

NM3125

NM3120

NM3115

NM3110

NM3105



QUICKLATCH™ PIPE HANGER

Catalog Number	UPC/DEI/NAED Mfg. #018997	Rigid, IMC, PVC Size	EMT Size	Std Pkg
NM3100	54027	---	1/2"	100
NM3105	54028	1/2"	---	100
NM3110	54029	---	3/4"	100
NM3115	54030	3/4"	---	100
NM3120	54031	---	1"	100
NM3125	54032	1"	---	100

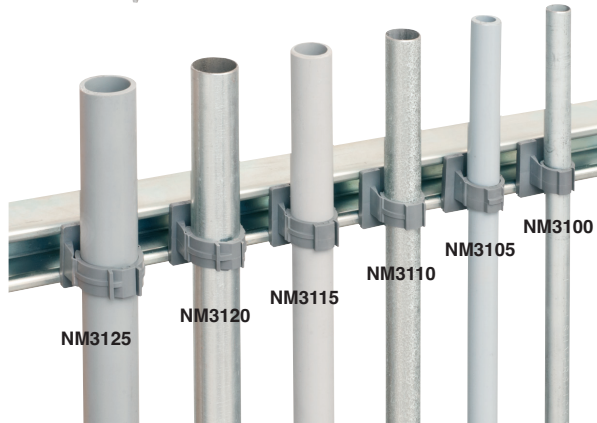

NM3125

NM3120

NM3115

NM3110

NM3105

NM3100

Patent pending



Arlington®

1 Stauffer Industrial Park
Scranton, PA 18517
800/233.4717 • Fax 570/562.0646
www.aifittings.com

UV Rated, Non-Metallic QuickLATCH™

Works just like a Pipe Hanger • Easy to Install

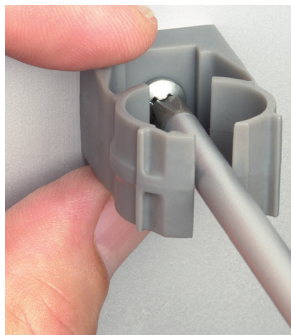

Mount to surface with a screw.

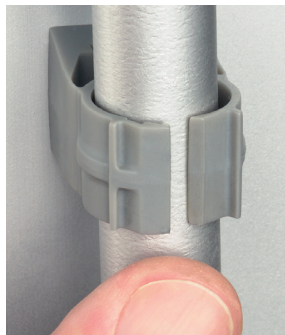

Press down on pipe to lock it firmly in place.

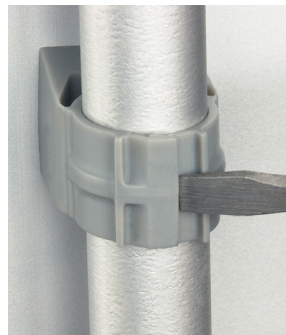

Removable Use screwdriver to lift tab.

Fast and easy to install, one-piece, non-metallic **QuickLATCH™** mounts to walls, metal strut and studs, and threaded rod up to 1/4"-20...works with Arlington's Strut Clip™ too. *Strut Clip holds pipe hangers securely on strut.*

It fits 1/2" to 4" EMT, RIGID, IMC and PVC. The larger 2-1/2" to 4" sizes have an extra opening for the optional securing of tie wire or cable tie.

- Corrosion resistant
- Horizontal or vertical mounting
- Integral slot keeps nut from spinning

Catalog Number	UPC/DEI/NAED Mfg. #018997	Rigid, IMC, PVC Size	EMT Size	LT Size	Flex Size	ENT Size	Copper Tubing	Copper Pipe	Std Pkg
NM1900	54514	---	---	5/16"	---	---	1/2"	---	100
NM2000	54515	---	1/2"	3/8"	---	---	---	3/8"	100
NM2005	54525	1/2"	---	1/2"	1/2"	1/2"	---	1/2"	100
NM2010	54516	---	3/4"	---	---	---	3/4"	---	100
NM2015	54526	3/4"	---	3/4"	3/4"	3/4"	---	3/4"	100
NM2020	54517	---	1"	---	---	---	1"	---	100
NM2025	54518	1"	---	1"	1"	1"	---	1"	100
NM2030	54528	---	1-1/4"	---	---	---	1-1/4"	---	100
NM2040	54519	1-1/4"	1-1/2"	---	---	---	1-1/2"	1-1/4"	100
NM2045	54544	1-1/2"	---	1-1/2"	1-1/2"	---	---	1-1/2"	100
NM2150	54547	---	---	---	---	---	2"	---	50
NM2050	54520	2"	2"	2"	2"	---	2"	---	50
NM2060	54521	2-1/2"	2-1/2"	2-1/2"	2-1/2"	---	---	---	50
NM2070	54522	3"	3"	3"	3"	---	---	---	25
NM2080	54523	3-1/2"	3-1/2"	3-1/2"	3-1/2"	---	---	---	25
NM2090	54524	4"	4"	4"	4"	---	---	---	10



2-1/2" to 4"
Press pipe into QuickLATCH, up to the first notch to lock it in place. Then squeeze tabs together for a super-secure hold.



Catalog Number	UPC/DEI/NAED Mfg. #018997	Description STRUT CLIP™	Unit/Std Pkg
NM1000	54615	UV rated, non-metallic clip Holds pipe hangers and/or conduit secure on strut Includes 1/4"-20 screw (installed)	100

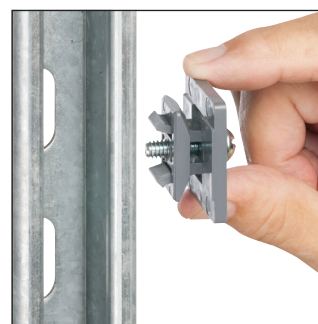

Our QuickLATCH™ Pipe Hanger installs on Strut Clip™

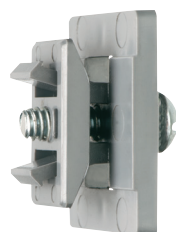

NM1000
STRUT CLIP
Strut Conduit Support



Distributed by

Patented

QuickLATCH REV 0325/15M

Arlington®

1 Stauffer Industrial Park
Scranton, PA 18517

800/233.4717 • Fax 570/562.0646

www.aifittings.com

NEW!
more on reverse

Heavy duty, Non-Metallic QuickLATCH™

Installed Strut Clip • For RIGID and EMT

NEW!



Arlington's heavy duty NM3100 series QuickLATCH™ with installed strut clip holds RIGID and EMT securely on strut. Use it like a pipe hanger.

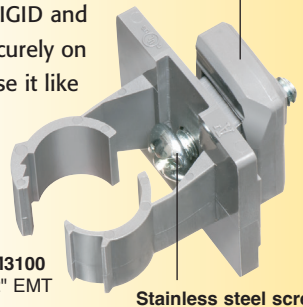

NM3100
1/2" EMT

Stainless steel screw

Fast, Easy Installation!
Saves 20 seconds per installation

One-piece QuickLATCH saves time, about 20 seconds per installation... over 33¢ each at \$60.00 per hour labor rate.

Fast and easy to install. Insert the hanger into the strut, twist to lock the pre-installed clip in place then tighten screw to secure QuickLATCH to strut. Push RIGID or EMT into the hanger to lock it in place.



1 Insert QuickLATCH into strut. The strut clip is already attached so you save time.

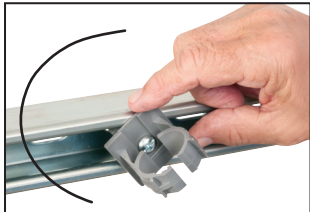

2 Twist QuickLATCH to seat clip in strut.



3 Tighten screw for secure installation on strut.



4 Push conduit into QuickLATCH to snap in place.



5 Secure installation of conduit to strut.

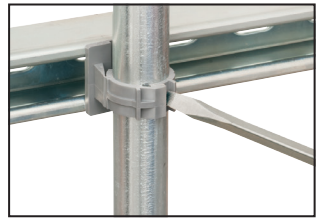

Easy screwdriver removal

- UV rated, corrosion resistant for outdoor use
- Stainless steel screw
- Mounts vertically or horizontally
- Screwdriver removal, reusable
- Listed for use in environmental air handling spaces per 2020 NEC, article 300.22(c)

See reverse for even more QuickLATCH products!

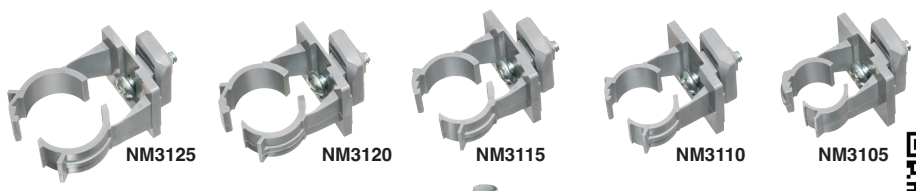

QUICKLATCH™ PIPE HANGER

Catalog Number	UPC/DEI/NAED Mfg. #018997	Rigid, IMC, PVC Size	EMT Size	Std Pkg
NM3100	54027	---	1/2"	100
NM3105	54028	1/2"	---	100
NM3110	54029	---	3/4"	100
NM3115	54030	3/4"	---	100
NM3120	54031	---	1"	100
NM3125	54032	1"	---	100

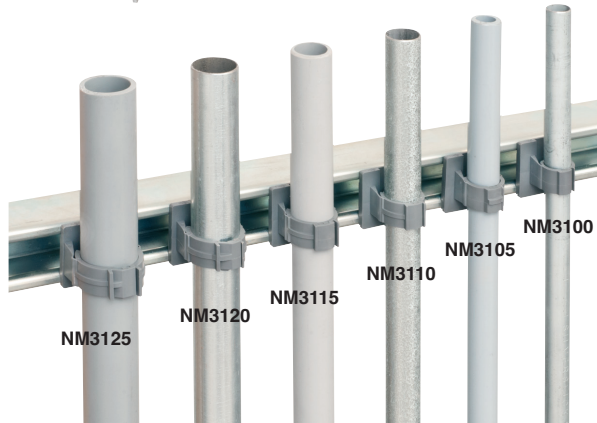

Patent pending



Arlington®

1 Stauffer Industrial Park
Scranton, PA 18517
800/233.4717 • Fax 570/562.0646
www.aifittings.com

UV Rated, Non-Metallic QuickLATCH™

Works just like a Pipe Hanger • Easy to Install

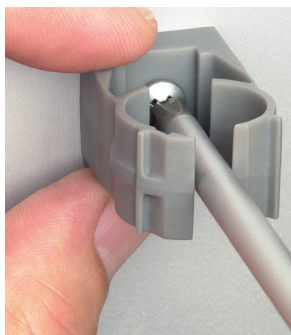

Mount to surface with a screw.

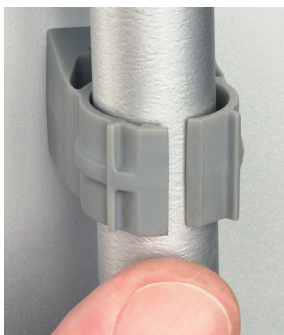

Press down on pipe to lock it firmly in place.



Removable Use screwdriver to lift tab.

Fast and easy to install, one-piece, non-metallic **QuickLATCH™** mounts to walls, metal strut and studs, and threaded rod up to 1/4"-20...works with Arlington's Strut Clip™ too. *Strut Clip holds pipe hangers securely on strut.*

It fits 1/2" to 4" EMT, RIGID, IMC and PVC. The larger 2-1/2" to 4" sizes have an extra opening for the optional securing of tie wire or cable tie.

- Corrosion resistant
- Horizontal or vertical mounting
- Integral slot keeps nut from spinning

Catalog Number	UPC/DEI/NAED Mfg. #018997	Rigid, IMC, PVC Size	EMT Size	LT Size	Flex Size	ENT Size	Copper Tubing	Copper Pipe	Std Pkg
NM1900	54514	---	---	5/16"	---	---	1/2"	---	100
NM2000	54515	---	1/2"	3/8"	---	---	---	3/8"	100
NM2005	54525	1/2"	---	1/2"	1/2"	1/2"	---	1/2"	100
NM2010	54516	---	3/4"	---	---	---	3/4"	---	100
NM2015	54526	3/4"	---	3/4"	3/4"	3/4"	---	3/4"	100
NM2020	54517	---	1"	---	---	---	1"	---	100
NM2025	54518	1"	---	1"	1"	1"	---	1"	100
NM2030	54528	---	1-1/4"	---	---	---	1-1/4"	---	100
NM2040	54519	1-1/4"	1-1/2"	---	---	---	1-1/2"	1-1/4"	100
NM2045	54544	1-1/2"	---	1-1/2"	1-1/2"	---	---	1-1/2"	100
NM2150	54547	---	---	---	---	---	2"	---	50
NM2050	54520	2"	2"	2"	2"	---	2"	---	50
NM2060	54521	2-1/2"	2-1/2"	2-1/2"	2-1/2"	---	---	---	50
NM2070	54522	3"	3"	3"	3"	---	---	---	25
NM2080	54523	3-1/2"	3-1/2"	3-1/2"	3-1/2"	---	---	---	25
NM2090	54524	4"	4"	4"	4"	---	---	---	10



2-1/2" to 4"
Press pipe into QuickLATCH, up to the first notch to lock it in place. Then squeeze tabs together for a super-secure hold.



Catalog Number	UPC/DEI/NAED Mfg. #018997	Description STRUT CLIP™	Unit/Std Pkg
NM1000	54615	UV rated, non-metallic clip Holds pipe hangers and/or conduit secure on strut Includes 1/4"-20 screw (installed)	100



NM1000
STRUT CLIP
Strut Conduit Support

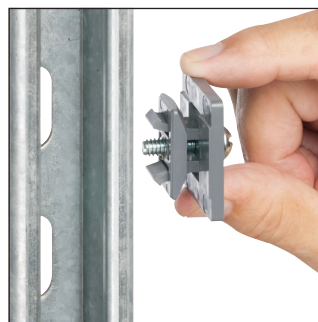

Our QuickLATCH™ Pipe Hanger installs on Strut Clip™



Distributed by

Patented

QuickLATCH REV 0325/15M

Arlington®

1 Stauffer Industrial Park
Scranton, PA 18517

800/233.4717 • Fax 570/562.0646

www.aifittings.com