

# 1F Condulet® Conduit Bodies - Cast Iron or Aluminum

Gasket and Covers see page 8

1F

## Applications:

- Conduit outlet bodies are installed in conduit systems to:
- Act as pull outlets for conductors being installed
  - Provide openings for making splices and taps in conductors
  - Connect conduit sections
  - Provide taps for branch conduit runs
  - Make 90° bends in conduit runs
  - Provide for access to conductors for maintenance and future system changes

## Features:

### Conduit Outlet Bodies

- Form 7 Condulet outlet bodies approach conduit in size for neat, compact installations
- Form 8 and Mark 9 bodies provide more room for heavier conductors
- Many shapes and sizes are available for rigid threaded conduit – for complete listings see pages 6–12
- Conduit hubs have tapered threads and feature integral bushings for protection of wire insulation
- Form 7 has exclusive snaptight and wedgenut cover attachment to provide clear, unobstructed cover opening
- Built-in rollers on all Form 5 1 1/4" to 4" C and LB bodies to facilitate wire pulling
- Series 5 bodies available in optional configuration with set screws on hubs for EMT conduit (add suffix -MT to catalog number)

### Gaskets

Solid gaskets:

- Are used with blank covers
- For Mark 9 and Form 5, can be converted to open type gaskets by tearing out center section along scored lines – 1/2" to 2" sizes
- For Form 7 are used with all covers

Open gaskets:

- For Form 8 – 1/2" to 4" sizes
- For Mark 9 – 2 1/2" to 4" sizes

### Blank Covers

Stainless steel cover screws are standard on Form 7, Form 8, Mark 9, Series 5 and Form 5 covers.

#### • Form 7

Wedge nut design facilitates installation and removal. Nuts are held captive in cover. Covers can be used with or without gaskets. SNAPTIGHT™ Form 7 Covers with integral sealing gaskets are installed without the use of screws, reducing installation time and costs. Covers are reusable.

#### • Form 8

Two cover screws provided on all sizes to provide tight cover and gasket assembly. *Feraloy* iron alloy covers have dome shapes for added strength and extra wiring room.

#### • Mark 9

Self-retaining cover screws.

## Certifications and Compliances:

Outlet Bodies –

- UL Standard: 514B
- Fed. Spec.: W-C-586D
- CSA Standard 22.2 No. 18
- NEMA 3R Raintight (when installed with cover and gasket)

## Standard Materials:

- Form 7, Form 8 outlet bodies – *Feraloy* iron alloy
- Mark 9 outlet bodies – copper-free aluminum
- Form 5 – malleable iron
- Series 5 – die cast aluminum

## Standard Finishes:

- Form 7, Form 8 outlet bodies – electrogalvanized with aluminum acrylic paint
- Mark 9 outlet bodies – natural
- Form 5 – electrogalvanized with aluminum acrylic paint
- Series 5 – aluminum acrylic paint

## Options:

| Description   | Suffix |
|---|--------|
| Form 7 body and cover only:   |        |
| Copper-free aluminum . . . . .  | SA     |
| <i>Corro-free</i> ™ epoxy powder coat - external body only . . . . .    | S752   |
| <i>Corro-free</i> ™ epoxy powder coat - internal and external . . . . . | S753   |
| Series 5 in an EMT version with set screws on all hubs . . . . .        | MT     |
| Series 5 pre-packaged with neoprene gasket and cover . . . . .          | CGN    |



Form 7



Mark 9

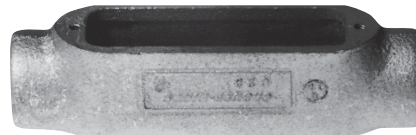

Form 8











Mogul

# Condulet® Conduit Bodies - Cast Iron or Aluminum

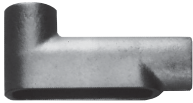
1F

Dimensions Pgs. See pages 10–12 (Dimensions for Form 5 – see Section CP)

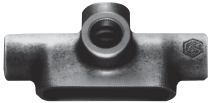
## Threaded Rigid Bodies

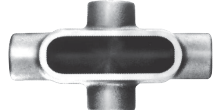
| Shape   | Style     | Hub Size |        |        |         |         |         |         |         |         |         |  |
|---|-----------|----------|--------|--------|---------|---------|---------|---------|---------|---------|---------|--|
|   |           | 1/2      | 3/4    | 1      | 1 1/4   | 1 1/2   | 2       | 2 1/2   | 3       | 3 1/2   | 4       |  |
|                                  | <b>C</b>  |          |        |        |         |         |         |         |         |         |         |  |
|   | Form 7    | C17      | C27    | C37    | C47     | C57     | C67     | C77     | C87     |         |         |  |
|   | Form 8    | C18      | C28    | C38    | C448    | C58     | C68     | C78     | C88     |         |         |  |
|   | Mark 9    | C19      | C29    | C39    | C49     | C59     | C69     | C789    | C889    | C989    | C1089   |  |
|   | Form 5    | C50M     | C75M   | C100M  | C125M*  | C150M*  | C200M*  | C250M*  | C300M*  | C350M*  | C400M*  |  |
| Series 5  | C15       | C25      | C35    | C45    | C55     | C65     | C75     | C85     | C95*    | C105*   |         |  |
|                                  | <b>E</b>  |          |        |        |         |         |         |         |         |         |         |  |
|   | Form 7    | E17      | E27    | E37    |         |         |         |         |         |         |         |  |
|                                  | <b>L</b>  |          |        |        |         |         |         |         |         |         |         |  |
|   | Form 7    | L17      | L27    | L37    | L47     | L57     | L67     |         |         |         |         |  |
| Double faced – may be used as LL or LR – has 2 openings, one of which is furnished with a blank sheet steel cover |           |          |        |        |         |         |         |         |         |         |         |  |
|                                  | <b>LB</b> |          |        |        |         |         |         |         |         |         |         |  |
|   | Form 7    | LB17     | LB27   | LB37   | LB47    | LB57    | LB67    | LB777   | LB87    | LB97    | LB107   |  |
|   | Form 8    | LB18     | LB28   | LB38   | LB448   | LB58    | LB68    | LB78    | LB888   | LB98    | LB108   |  |
|   | Mark 9    | LB19     | LB29   | LB39   | LB49    | LB59    | LB69    | LB789   | LB889   | LB989   | LB1089  |  |
|   | Form 5    | LB50M    | LB75M  | LB100M | LB125M* | LB150M* | LB200M* | LB250M* | LB300M* | LB350M* | LB400M* |  |
| Series 5  | LB15      | LB25     | LB35   | LB45   | LB55    | LB65    | LB75    | LB85    | LB95    | LB105   |         |  |
|                                  | <b>LL</b> |          |        |        |         |         |         |         |         |         |         |  |
|   | Form 7    | LL17     | LL27   | LL37   | LL47    | LL57    | LL67    | LL777   | LL87    | LL97    | LL107   |  |
|   | Form 8    | LL18     | LL28   | LL38   | LL448   | LL58    | LL68    | LL78    | LL888   |         |         |  |
|   | Mark 9    | LL19     | LL29   | LL39   | LL49    | LL59    | LL69    | LL789   | LL889   | LL989   | LL1089  |  |
|   | Form 5    | LL50M    | LL75M  | LL100M | LL125M  | LL150M  | LL200M  | LL250M  | LL300M  | LL350M  | LL400M  |  |
| Series 5  | LL15      | LL25     | LL35   | LL45   | LL55    | LL65    | LL75    | LL85    | LL95    | LL105   |         |  |
|                                | <b>LR</b> |          |        |        |         |         |         |         |         |         |         |  |
|   | Form 7    | LR17     | LR27   | LR37   | LR47    | LR57    | LR67    | LR777   | LR87    | LR97    | LR107   |  |
|   | Form 8    | LR18     | LR28   | LR38   | LR448   | LR58    | LR68    | LR78    | LR888   |         |         |  |
|   | Mark 9    | LR19     | LR29   | LR39   | LR49    | LR59    | LR69    | LR789   | LR889   | LR989   | LR1089  |  |
|   | Form 5    | LR50M    | LR75M  | LR100M | LR125M  | LR150M  | LR200M  | LR250M  | LR300M  | LR350M  | LR400M  |  |
| Series 5  | LR15      | LR25     | LR35   | LR45   | LR55    | LR65    | LR75    | LR85    | LR95    | LR105   |         |  |
|                                | <b>T</b>  |          |        |        |         |         |         |         |         |         |         |  |
|   | Form 7    | T17      | T27    | T37    | T47     | T57     | T67     | T77     | T87     | T97     | T107    |  |
|   | Form 8    | T18      | T28    | T38    | T448    | T58     | T68     | T78     | T88     |         |         |  |
|   | Mark 9    | T19      | T29    | T39    | T49     | T59     | T69     | T789    | T889    | T989    | T1089   |  |
|   | Form 5    | T50M     | T75M   | T100M  | T125M   | T150M   | T200M   | T250M   | T300M   | T350M   | T400M   |  |
| Series 5  | T15       | T25      | T35    | T45    | T55     | T65     | T75     | T85     | T95*    | T105*   |         |  |
|                                | <b>TA</b> |          |        |        |         |         |         |         |         |         |         |  |
|   | Form 7    | TA17     | TA27   | TA37   | TA47    | TA57    | TA67    |         |         |         |         |  |
|                                | <b>TB</b> |          |        |        |         |         |         |         |         |         |         |  |
|   | Form 7    | TB17     | TB27   | TB37   | TB47    | TB57    | TB67    |         |         |         |         |  |
|   | Form 8    | TB18     | TB28   | TB38   | TB448   | TB58    | TB68    |         |         |         |         |  |
|   | Mark 9    | TB19     | TB29   | TB39   | TB49    | TB59    | TB69    |         |         |         |         |  |
|   | Form 5    | TB15     | TB25   | TB35   | TB45    | TB55    | TB65    |         |         |         |         |  |
| Series 5  | TB50M     | TB75M    | TB100M | TB125M | TB150M  | TB200M  |         |         |         |         |         |  |
|                                | <b>X</b>  |          |        |        |         |         |         |         |         |         |         |  |
|   | Form 7    | X17      | X27    | X37    | X47     | X57     | X67     |         |         |         |         |  |
|   | Form 8    | X18      | X28    | X38    | X448    | X58     | X68     |         |         |         |         |  |
|   | Mark 9    | X19      | X29    | X39    |         |         |         |         |         |         |         |  |
|   | Form 5    | X15      | X25    | X35    | X45     | X55     | X65     |         |         |         |         |  |
| Series 5  | X50M      | X75M     | X100M  | X125M  | X150M   | X200M   |         |         |         |         |         |  |

\* 1 1/2" - 4" Form 5 LB and C bodies are supplied with built-in rollers to facilitate wire pulling.

## Covers and Gaskets

Dimensions Pgs. See pages 10–12 (Dimensions for Form 5 – see Section CP)

### Blank Covers



Sheet Steel

| Size  | Form 7 Wedgenut Cat. # | Form 7 Snaptight™ Covers‡ Cat. # | Form 7 Wedgenut w/Integral Gasket Cat. # | Form 8§ Cat. # | Form 8 w/Integral Gasket Cat. # | Form 5 w/Integral Gasket** Cat. # |
|-------|------------------------|----------------------------------|--|----------------|---------------------------------|-----------------------------------|
| 1/2   | 170                    | 170SG                            | 170G                                     | 180            | 180G                            | K50SG                             |
| 3/4   | 270                    | 270SG                            | 270G                                     | 280            | 280G                            | K75SG                             |
| 1     | 370                    | 370SG                            | 370G                                     | 380            | 380G                            | K100SG                            |
| 1 1/4 | 470                    | 470SG                            | 470G                                     | 480            | 480G                            | K125SG                            |
| 1 1/2 | 570                    | 570SG                            | 570G                                     | 580            | 580G                            | K125SG                            |
| 2     | 670                    | 670SG                            | 670G                                     | 680            | 680G                            | K200SG                            |
| 2 1/2 | 870                    |                                  | 870G                                     | 880            |                                 | K250SG                            |
| 3     | 870                    |                                  | 870G                                     | 880            |                                 | K250SG                            |
| 3 1/2 | 970                    |                                  | 970G                                     | 980            |                                 | K350SG                            |
| 4     | 970                    |                                  | 970G                                     | 980            |                                 | K350SG                            |

‡Form 7 Snaptight covers with integral sealing gasket are installed without the use of screws.  
§Two cover screws on 1/2" to 2" Form 8 covers and four cover screws on 2 1/2" and larger Form 8 covers.  
\*\*For cover without integral gasket, remove G from catalog number.



Sheet Aluminum



Feraloy® Iron Alloy



Cast Aluminum

| Size  | Mark 9 Cat. # | Mark 9 w/Integral Gasket Cat. # | Form 7 Cat. # | Form 7 w/Integral Gasket Cat. # | Series 5 w/Integral Gasket** Cat. # | Form 7 Wedgenut Cat. # | Form 7 Wedgenut w/Integral Gasket Cat. # | Form 8§ Cat. # | Form 5‡ Cat. # | Form 7 Wedgenut Cat. # |
|-------|---------------|---------------------------------|---------------|---------------------------------|-------------------------------------|------------------------|--|----------------|----------------|------------------------|
| 1/2   | 190           | 190G                            | 170 SA        | 170G SA                         | 150 G                               | 170F                   | 170FG                                    | 180F           | K50CM          | 170F SA                |
| 3/4   | 290           | 290G                            | 270 SA        | 270G SA                         | 250 G                               | 270F                   | 270FG                                    | 280F           | K75CM          | 270F SA                |
| 1     | 390           | 390G                            | 370 SA        | 370G SA                         | 350 G                               | 370F                   | 370FG                                    | 380F           | K100CM         | 370F SA                |
| 1 1/4 | 490           | 490G                            | 470 SA        | 470G SA                         | 450 G                               | 470F                   | 470FG                                    | 480F           | K125CM         | 470F SA                |
| 1 1/2 | 590           | 590G                            | 570 SA        | 570G SA                         | 450 G                               | 570F                   | 570FG                                    | 580F           | K125CM         | 570F SA                |
| 2     | 690           | 690G                            | 670 SA        | 670G SA                         | 650 G                               | 670F                   | 670FG                                    | 680F           | K200CM         | 670F SA                |
| 2 1/2 | 889           |                                 | 870 SA        |                                 | 850 G                               | 870F                   |  | 880F           | K250CM         | 870F SA                |
| 3     | 889           |                                 | 870 SA        |                                 | 850 G                               | 870F                   |  | 880F           | K250CM         | 870F SA                |
| 3 1/2 | 989           |                                 | 970 SA        |                                 | 950 G                               | 970F                   |  | 980F           | K350CM         | 970F SA                |
| 4     | 989           |                                 | 970 SA        |                                 | 950 G                               | 970F                   |  | 980F           | K350CM         | 970F SA                |

‡Malleable iron covers.  
§Two cover screws on 1/2" to 2" Form 8 covers and four cover screws on 2 1/2" and larger Form 8 covers.  
\*\*For cover without integral gasket, remove G from catalog number.

### Solid Gaskets - Neoprene



| Size  | Form 7 Cat. # | Form 8* Cat. # | Mark 9† Cat. # | Form 5 Cat. # | Series 5 Cat. # |
|-------|---------------|----------------|----------------|---------------|-----------------|
| 1/2   | GASK571       | GASK851N       | GASK1941       | GK50N         | GASK015N        |
| 3/4   | GASK572       | GASK852N       | GASK1942       | GK75N         | GASK025N        |
| 1     | GASK573       | GASK853N       | GASK1943       | GK100N        | GASK035N        |
| 1 1/4 | GASK574       | GASK854N       | GASK1944       | GK125N        | GASK045N        |
| 1 1/2 | GASK575       | GASK805N       | GASK1945       | GK125N        | GASK045N        |
| 2     | GASK576       | GASK806N       | GASK1946       | GK200N        | GASK065N        |
| 2 1/2 | GASK578       | GASK808N       | GASK808N       | GK250N        | GASK085N        |
| 3     | GASK578       | GASK808N       | GASK808N       | GK250N        | GASK085N        |
| 3 1/2 | GASK579       | GASK809N       | GASK809N       | GK350N        | GASK095N        |
| 4     | GASK579       | GASK809N       | GASK809N       | GK350N        | GASK095N        |

†1/2 – 1 1/4 are solid gaskets; 1 1/2 – 4 are open gaskets.  
‡1/2 – 2 are solid gaskets; 2 1/2 – 4 are open gaskets.

# Condulet® Conduit Bodies - Cast Iron or Aluminum

Dimensions (In Inches)

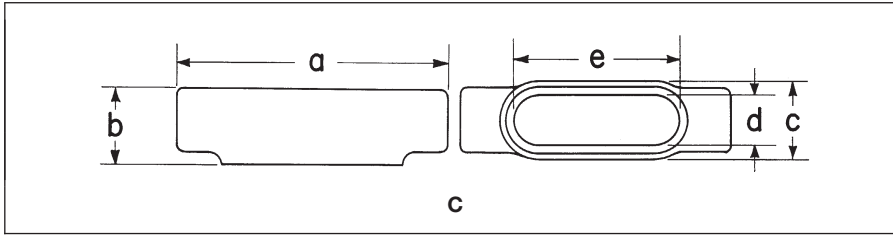

### Form 7 C

| Size | 1/2    | 3/4     | 1     | 1 1/4  | 1 1/2   | 2      | 2 1/2  | 3      |
|------|--------|---------|-------|--------|---------|--------|--------|--------|
| a    | 5 5/8  | 6       | 7     | 7 7/16 | 8 3/16  | 9 3/16 | 12     | 11 3/4 |
| b    | 1 3/8  | 1 5/8   | 1 7/8 | 2 5/16 | 2 9/16  | 3 1/8  | 3 5/8  | 4 3/8  |
| c    | 1 3/8  | 1 9/16  | 1 3/4 | 2 3/16 | 2 7/16  | 3      | 4 1/4  | 4 1/4  |
| d    | 1 5/16 | 1 1/8   | 1 3/8 | 1 3/4  | 1 15/16 | 2 7/16 | 3 3/16 | 3 9/16 |
| e    | 3 3/16 | 3 13/16 | 4 1/2 | 5      | 5 7/16  | 6 5/8  | 8 3/8  | 8 5/8  |

### Form 8 C

| Size | 1/2     | 3/4     | 1       | 1 1/4  | 1 1/2   | 2      | 2 1/2  | 3       |
|------|---------|---------|---------|--------|---------|--------|--------|---------|
| a    | 5 11/16 | 6 9/32  | 7 5/16  | 8 1/2  | 10 3/8  | 12 1/4 | 15 5/8 | 15 5/8  |
| b    | 1 7/16  | 1 11/16 | 1 15/16 | 2 3/8  | 2 25/32 | 3 3/16 | 4 7/16 | 4 13/16 |
| c    | 1 3/8   | 1 3/16  | 1 3/4   | 2 3/16 | 2 3/4   | 3 3/4  | 5      | 5       |
| d    | 1       | 1 3/16  | 1 3/8   | 1 3/4  | 2 1/8   | 3      | 4 1/4  | 4 1/4   |
| e    | 3 5/16  | 3 15/16 | 4 9/16  | 5 5/16 | 6 1/2   | 8 9/16 | 10 7/8 | 10 7/8  |

### Mark 9 C

| Size | 1/2     | 3/4     | 1       | 1 1/4   | 1 1/2   | 2       | 2 1/2  | 3       | 3 1/2   | 4       |
|------|---------|---------|---------|---------|---------|---------|--------|---------|---------|---------|
| a    | 4 31/32 | 5 11/32 | 6 19/32 | 7 5/8   | 8 11/32 | 10 5/8  | 15 5/8 | 15 5/8  | 18 3/4  | 18 3/4  |
| b    | 1 13/32 | 1 5/8   | 1 7/8   | 2 1/2   | 2 13/16 | 3 7/16  | 4 7/16 | 4 13/16 | 5 11/16 | 5 15/16 |
| c    | 1 3/8   | 1 9/16  | 1 3/4   | 2 3/16  | 2 1/2   | 3 3/2   | 5      | 5       | 6 1/4   | 6 1/4   |
| d    | 1 1/8   | 1 1/4   | 1 5/8   | 1 27/32 | 2 3/32  | 2 25/32 | 4 1/4  | 4 1/4   | 5 1/16  | 5 7/16  |
| e    | 3 9/32  | 3 27/32 | 4 9/16  | 5 3/16  | 5 5/8   | 8 3/32  | 10 7/8 | 10 7/8  | 13 7/16 | 13 7/16 |

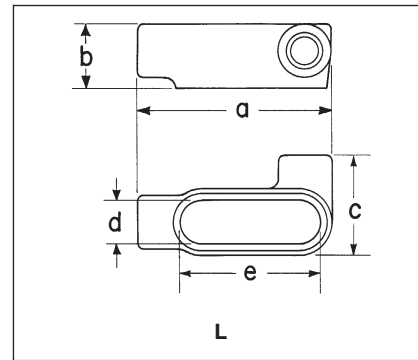
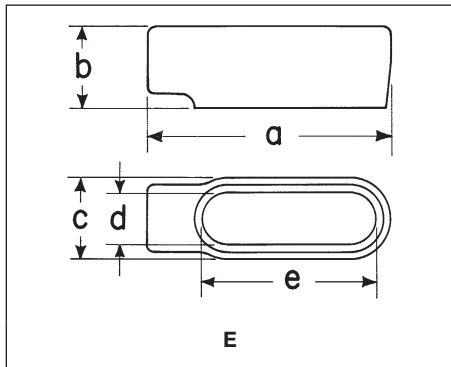

### Form 7 E

| Size | 1/2    | 3/4     | 1     |
|------|--------|---------|-------|
| a    | 4 9/16 | 5 3/16  | 6     |
| b    | 1 3/8  | 1 5/8   | 1 7/8 |
| c    | 1 3/8  | 1 9/16  | 1 3/4 |
| d    | 1 5/16 | 1 1/8   | 1 3/8 |
| e    | 3 3/16 | 3 13/16 | 4 1/2 |

### Form 7 L

| Size | 1/2    | 3/4     | 1     | 1 1/4  | 1 1/2   | 2      |
|------|--------|---------|-------|--------|---------|--------|
| a    | 4 9/16 | 5 3/16  | 6     | 6 1/2  | 7 1/8   | 3 3/8  |
| b    | 1 3/8  | 1 5/8   | 1 7/8 | 2 5/16 | 2 9/16  | 3 3/8  |
| c    | 2 1/4  | 2 7/16  | 2 3/4 | 3 3/16 | 3 9/16  | 4 1/8  |
| d    | 1 5/16 | 1 1/8   | 1 3/8 | 1 3/4  | 1 15/16 | 2 7/16 |
| e    | 3 3/16 | 3 13/16 | 4 1/2 | 5      | 5 7/16  | 6 5/8  |

# Condulet® Conduit Bodies - Cast Iron or Aluminum

1F

## Dimensions (In Inches)

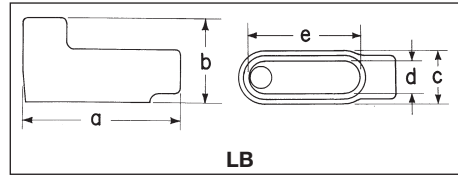

### Form 7 LB

| Size | 1/2                            | 3/4                            | 1     | 1 1/4  | 1 1/2   | 2      | 2 1/2  | 3      | 3 1/2    | 4        |
|------|--------------------------------|--------------------------------|-------|--------|---------|--------|--------|--------|----------|----------|
| a    | 4 <sup>9</sup> / <sub>16</sub> | 5 <sup>9</sup> / <sub>16</sub> | 6     | 6 1/2  | 7 1/8   | 8 7/8  | 10 1/2 | 10 1/2 | 12 11/16 | 12 11/16 |
| b    | 2 1/4                          | 2 1/2                          | 2 7/8 | 3 5/16 | 3 11/16 | 4 1/4  | 5 1/8  | 5 7/8  | 6 9/16   | 7 1/16   |
| c    | 1 3/8                          | 1 9/16                         | 1 3/4 | 2 3/16 | 2 7/16  | 3      | 4 1/4  | 4 1/4  | 5 1/4    | 5 1/4    |
| d    | 1 5/16                         | 1 1/8                          | 1 3/8 | 1 3/4  | 1 15/16 | 2 7/16 | 3 9/16 | 3 9/16 | 4 1/2    | 4 1/2    |
| e    | 3 3/16                         | 3 13/16                        | 4 1/2 | 5      | 5 7/16  | 6 3/8  | 8 3/8  | 8 3/8  | 10 1/4   | 10 1/4   |

### Form 8 LB

| Size | 1/2     | 3/4     | 1       | 1 1/4   | 1 1/2  | 2       | 2 1/2    | 3        | 3 1/2   | 4       |
|------|---------|---------|---------|---------|--------|---------|----------|----------|---------|---------|
| a    | 4 15/16 | 5 9/16  | 6 15/32 | 7 17/32 | 9 1/8  | 11      | 13 15/16 | 13 15/16 | 16 7/8  | 16 7/8  |
| b    | 2 7/32  | 2 7/16  | 2 13/16 | 3 11/32 | 4 1/32 | 4 13/16 | 6 1/8    | 6 1/2    | 7 9/16  | 7 13/16 |
| c    | 1 3/8   | 1 9/16  | 1 3/4   | 2 3/16  | 2 3/4  | 3 3/4   | 5        | 5        | 6 1/4   | 6 1/4   |
| d    | 1       | 1 3/16  | 1 3/8   | 1 3/4   | 2 1/8  | 3       | 4 1/4    | 4 1/4    | 5 1/16  | 5 1/16  |
| e    | 3 5/16  | 3 15/16 | 4 9/16  | 5 5/16  | 6 1/2  | 8 9/16  | 10 7/8   | 10 7/8   | 13 7/16 | 13 7/16 |

### Mark 9 LB

| Size | 1/2     | 3/4     | 1       | 1 1/4  | 1 1/2   | 2       | 2 1/2    | 3        | 3 1/2   | 4       |
|------|---------|---------|---------|--------|---------|---------|----------|----------|---------|---------|
| a    | 4 19/32 | 5 1/4   | 6 3/32  | 7 3/32 | 7 25/32 | 10 3/32 | 13 15/16 | 13 15/16 | 16 7/8  | 16 7/8  |
| b    | 2 1/8   | 2 15/32 | 2 13/16 | 3 5/8  | 3 3/8   | 4 9/32  | 6 1/8    | 6 1/2    | 7 9/16  | 7 13/16 |
| c    | 1 3/8   | 1 19/32 | 1 3/4   | 2 3/16 | 2 1/2   | 3 7/32  | 5        | 5        | 6 1/4   | 6 1/4   |
| d    | 1 1/16  | 1 9/32  | 1 7/16  | 1 7/8  | 2 3/16  | 2 29/32 | 4 1/4    | 4 1/4    | 5 1/16  | 5 1/16  |
| e    | 3 3/32  | 3 27/32 | 4 9/16  | 5 3/16 | 5 5/8   | 8 3/32  | 10 7/8   | 10 7/8   | 13 7/16 | 13 7/16 |



### Form 7 LL & LR

| Size | 1/2    | 3/4     | 1     | 1 1/4  | 1 1/2   | 2      | 2 1/2  | 3      | 3 1/2    | 4        |
|------|--------|---------|-------|--------|---------|--------|--------|--------|----------|----------|
| a    | 4 9/16 | 5 9/16  | 6     | 6 1/2  | 7 1/8   | 8 7/8  | 10 1/2 | 10 1/2 | 12 11/16 | 12 11/16 |
| b    | 1 3/8  | 1 5/8   | 1 7/8 | 2 5/16 | 2 9/16  | 3 3/8  | 3 5/8  | 4 3/8  | 4 7/8    | 5 5/8    |
| c    | 2 1/4  | 2 7/16  | 2 3/4 | 3 3/16 | 3 9/16  | 4 1/8  | 5 3/4  | 5 3/4  | 6 15/16  | 6 15/16  |
| d    | 1 5/16 | 1 1/8   | 1 3/8 | 1 3/4  | 1 15/16 | 2 7/16 | 3 9/16 | 3 9/16 | 4 1/2    | 4 1/2    |
| e    | 3 3/16 | 3 13/16 | 4 1/2 | 5      | 5 7/16  | 6 3/8  | 8 3/8  | 8 3/8  | 10 1/4   | 10 1/4   |

### Form 8 LL & LR

| Size | 1/2     | 3/4     | 1       | 1 1/4   | 1 1/2   | 2      | 2 1/2    | 3        |
|------|---------|---------|---------|---------|---------|--------|----------|----------|
| a    | 4 15/16 | 5 9/16  | 6 15/32 | 7 17/32 | 9 1/8   | 11     | 13 15/16 | 13 15/16 |
| b    | 1 7/16  | 1 11/16 | 1 15/16 | 2 3/8   | 2 25/32 | 3 9/16 | 4 7/16   | 4 13/16  |
| c    | 2 5/32  | 2 5/16  | 2 5/8   | 3 3/32  | 4       | 5      | 6 11/16  | 6 11/16  |
| d    | 1       | 1 3/16  | 1 3/8   | 1 3/4   | 2 1/8   | 3      | 4 1/4    | 4 1/4    |
| e    | 3 5/16  | 3 15/16 | 4 9/16  | 5 5/16  | 6 1/2   | 8 9/16 | 10 7/8   | 10 7/8   |

### Mark 9 LL & LR

| Size | 1/2     | 3/4     | 1       | 1 1/4  | 1 1/2   | 2       | 2 1/2    | 3        | 3 1/2   | 4       |
|------|---------|---------|---------|--------|---------|---------|----------|----------|---------|---------|
| a    | 4 19/32 | 5 1/4   | 6 3/32  | 7 3/32 | 7 1/64  | 10 3/32 | 13 15/16 | 13 15/16 | 16 7/8  | 16 7/8  |
| b    | 1 13/32 | 1 5/8   | 1 7/8   | 2 1/2  | 2 13/16 | 3 7/16  | 4 7/16   | 4 13/16  | 5 11/16 | 5 13/16 |
| c    | 2 1/8   | 2 5/16  | 2 11/16 | 3 1/4  | 3 1/2   | 4 19/64 | 6 11/16  | 6 11/16  | 8 1/8   | 8 1/8   |
| d    | 1 1/16  | 1 1/4   | 1 3/8   | 1 7/8  | 2 1/16  | 2 29/32 | 4 1/4    | 4 1/4    | 5 1/16  | 5 1/16  |
| e    | 3 3/32  | 3 27/32 | 4 9/16  | 5 3/16 | 5 5/8   | 8 3/32  | 10 7/8   | 10 7/8   | 13 7/16 | 13 7/16 |

1F

# Condulet® Conduit Bodies - Cast Iron or Aluminum

## Dimensions (In Inches)

1F

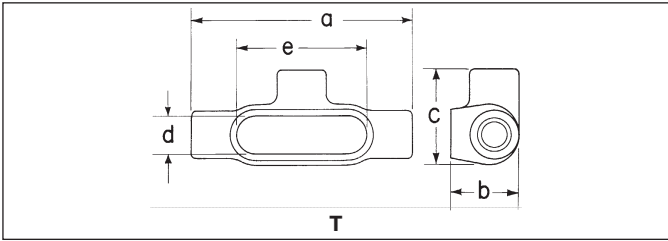

### Form 7T

| Size                          | a                               | b                              | c                               | d                               | e                               |
|-------------------------------|---------------------------------|--------------------------------|---------------------------------|---------------------------------|---------------------------------|
| 1/2                           | 5 <sup>5</sup> / <sub>8</sub>   | 1 <sup>3</sup> / <sub>4</sub>  | 2 <sup>7</sup> / <sub>16</sub>  | 1 <sup>5</sup> / <sub>16</sub>  | 3 <sup>3</sup> / <sub>16</sub>  |
| 3/4                           | 6 <sup>1</sup> / <sub>4</sub>   | 2                              | 2 <sup>5</sup> / <sub>8</sub>   | 1 <sup>1</sup> / <sub>8</sub>   | 3 <sup>13</sup> / <sub>16</sub> |
| 1                             | 7 <sup>1</sup> / <sub>4</sub>   | 2 <sup>1</sup> / <sub>4</sub>  | 3                               | 1 <sup>3</sup> / <sub>8</sub>   | 4 <sup>1</sup> / <sub>2</sub>   |
| 1 <sup>1</sup> / <sub>4</sub> | 7 <sup>7</sup> / <sub>16</sub>  | 2 <sup>5</sup> / <sub>16</sub> | 3 <sup>3</sup> / <sub>16</sub>  | 1 <sup>3</sup> / <sub>4</sub>   | 5                               |
| 1 <sup>1</sup> / <sub>2</sub> | 8 <sup>3</sup> / <sub>16</sub>  | 2 <sup>9</sup> / <sub>16</sub> | 3 <sup>9</sup> / <sub>16</sub>  | 1 <sup>15</sup> / <sub>16</sub> | 5 <sup>7</sup> / <sub>16</sub>  |
| 2                             | 9 <sup>9</sup> / <sub>16</sub>  | 3 <sup>1</sup> / <sub>8</sub>  | 4 <sup>1</sup> / <sub>8</sub>   | 2 <sup>7</sup> / <sub>16</sub>  | 6 <sup>3</sup> / <sub>8</sub>   |
| 2 <sup>1</sup> / <sub>2</sub> | 12                              | 3 <sup>5</sup> / <sub>8</sub>  | 5 <sup>1</sup> / <sub>4</sub>   | 3 <sup>9</sup> / <sub>16</sub>  | 8 <sup>3</sup> / <sub>8</sub>   |
| 3                             | 12 <sup>1</sup> / <sub>16</sub> | 4 <sup>3</sup> / <sub>8</sub>  | 5 <sup>1</sup> / <sub>4</sub>   | 3 <sup>9</sup> / <sub>16</sub>  | 8 <sup>3</sup> / <sub>8</sub>   |
| 3 <sup>1</sup> / <sub>2</sub> | 14 <sup>5</sup> / <sub>16</sub> | 4 <sup>7</sup> / <sub>8</sub>  | 6 <sup>15</sup> / <sub>16</sub> | 4 <sup>1</sup> / <sub>2</sub>   | 10 <sup>1</sup> / <sub>4</sub>  |
| 4                             | 14 <sup>5</sup> / <sub>16</sub> | 5 <sup>3</sup> / <sub>8</sub>  | 6 <sup>15</sup> / <sub>16</sub> | 4 <sup>1</sup> / <sub>2</sub>   | 10 <sup>1</sup> / <sub>4</sub>  |

### Form 8T

| Size                          | a                               | b                               | c                               | d                              | e                               |
|-------------------------------|---------------------------------|---------------------------------|---------------------------------|--------------------------------|---------------------------------|
| 1/2                           | 5 <sup>11</sup> / <sub>16</sub> | 1 <sup>3</sup> / <sub>4</sub>   | 2 <sup>5</sup> / <sub>32</sub>  | 1                              | 3 <sup>5</sup> / <sub>16</sub>  |
| 3/4                           | 6 <sup>9</sup> / <sub>32</sub>  | 2                               | 2 <sup>5</sup> / <sub>16</sub>  | 1 <sup>3</sup> / <sub>16</sub> | 3 <sup>15</sup> / <sub>16</sub> |
| 1                             | 7 <sup>5</sup> / <sub>16</sub>  | 2 <sup>1</sup> / <sub>4</sub>   | 2 <sup>5</sup> / <sub>8</sub>   | 1 <sup>3</sup> / <sub>8</sub>  | 4 <sup>9</sup> / <sub>16</sub>  |
| 1 <sup>1</sup> / <sub>4</sub> | 8 <sup>1</sup> / <sub>2</sub>   | 2 <sup>5</sup> / <sub>8</sub>   | 3 <sup>5</sup> / <sub>32</sub>  | 1 <sup>3</sup> / <sub>4</sub>  | 5 <sup>5</sup> / <sub>16</sub>  |
| 1 <sup>1</sup> / <sub>2</sub> | 10 <sup>3</sup> / <sub>8</sub>  | 2 <sup>25</sup> / <sub>32</sub> | 4                               | 2 <sup>1</sup> / <sub>8</sub>  | 6 <sup>1</sup> / <sub>2</sub>   |
| 2                             | 12 <sup>1</sup> / <sub>4</sub>  | 3 <sup>9</sup> / <sub>16</sub>  | 5                               | 3                              | 8 <sup>9</sup> / <sub>16</sub>  |
| 2 <sup>1</sup> / <sub>2</sub> | 15 <sup>5</sup> / <sub>8</sub>  | 4 <sup>7</sup> / <sub>16</sub>  | 6 <sup>11</sup> / <sub>16</sub> | 4 <sup>1</sup> / <sub>4</sub>  | 10 <sup>7</sup> / <sub>8</sub>  |
| 3                             | 15 <sup>5</sup> / <sub>8</sub>  | 4 <sup>13</sup> / <sub>16</sub> | 6 <sup>11</sup> / <sub>16</sub> | 4 <sup>1</sup> / <sub>4</sub>  | 10 <sup>7</sup> / <sub>8</sub>  |

### Mark 9T

| Size                          | a                               | b                               | c                               | d                               | e                               |
|-------------------------------|---------------------------------|---------------------------------|---------------------------------|---------------------------------|---------------------------------|
| 1/2                           | 5                               | 1 <sup>13</sup> / <sub>32</sub> | 2 <sup>1</sup> / <sub>8</sub>   | 1 <sup>1</sup> / <sub>16</sub>  | 3 <sup>9</sup> / <sub>32</sub>  |
| 3/4                           | 5 <sup>11</sup> / <sub>16</sub> | 1 <sup>5</sup> / <sub>8</sub>   | 2 <sup>5</sup> / <sub>16</sub>  | 1 <sup>1</sup> / <sub>4</sub>   | 3 <sup>27</sup> / <sub>32</sub> |
| 1                             | 6 <sup>19</sup> / <sub>32</sub> | 1 <sup>7</sup> / <sub>8</sub>   | 2 <sup>11</sup> / <sub>16</sub> | 1 <sup>3</sup> / <sub>8</sub>   | 4 <sup>9</sup> / <sub>16</sub>  |
| 1 <sup>1</sup> / <sub>4</sub> | 7 <sup>5</sup> / <sub>8</sub>   | 2 <sup>1</sup> / <sub>2</sub>   | 3 <sup>1</sup> / <sub>4</sub>   | 1 <sup>7</sup> / <sub>8</sub>   | 5 <sup>3</sup> / <sub>16</sub>  |
| 1 <sup>1</sup> / <sub>2</sub> | 8 <sup>11</sup> / <sub>32</sub> | 2 <sup>13</sup> / <sub>16</sub> | 3 <sup>1</sup> / <sub>2</sub>   | 2 <sup>3</sup> / <sub>16</sub>  | 5 <sup>7</sup> / <sub>8</sub>   |
| 2                             | 10 <sup>5</sup> / <sub>8</sub>  | 3 <sup>7</sup> / <sub>16</sub>  | 4 <sup>13</sup> / <sub>32</sub> | 2 <sup>29</sup> / <sub>32</sub> | 8 <sup>3</sup> / <sub>32</sub>  |
| 2 <sup>1</sup> / <sub>2</sub> | 15 <sup>5</sup> / <sub>8</sub>  | 4 <sup>7</sup> / <sub>16</sub>  | 6 <sup>11</sup> / <sub>16</sub> | 4 <sup>1</sup> / <sub>4</sub>   | 10 <sup>7</sup> / <sub>8</sub>  |
| 3                             | 15 <sup>5</sup> / <sub>8</sub>  | 4 <sup>13</sup> / <sub>16</sub> | 6 <sup>11</sup> / <sub>16</sub> | 4 <sup>1</sup> / <sub>4</sub>   | 10 <sup>7</sup> / <sub>8</sub>  |
| 3 <sup>1</sup> / <sub>2</sub> | 18 <sup>3</sup> / <sub>4</sub>  | 5 <sup>11</sup> / <sub>16</sub> | 8 <sup>1</sup> / <sub>8</sub>   | 5 <sup>7</sup> / <sub>16</sub>  | 13 <sup>7</sup> / <sub>16</sub> |
| 4                             | 18 <sup>3</sup> / <sub>4</sub>  | 5 <sup>15</sup> / <sub>16</sub> | 8 <sup>1</sup> / <sub>8</sub>   | 5 <sup>7</sup> / <sub>16</sub>  | 13 <sup>7</sup> / <sub>16</sub> |

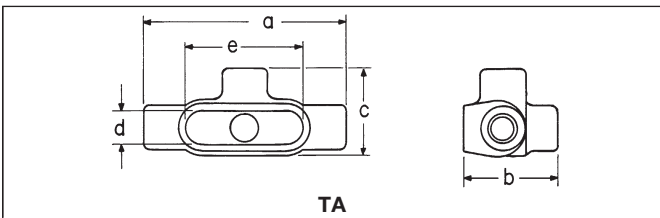

### Form 7TA

| Size                          | a                              | b                               | c                              | d                               | e                               |
|-------------------------------|--------------------------------|---------------------------------|--------------------------------|---------------------------------|---------------------------------|
| 1/2                           | 5 <sup>5</sup> / <sub>8</sub>  | 2 <sup>5</sup> / <sub>8</sub>   | 2 <sup>7</sup> / <sub>16</sub> | 1 <sup>5</sup> / <sub>16</sub>  | 3 <sup>3</sup> / <sub>16</sub>  |
| 3/4                           | 6 <sup>1</sup> / <sub>4</sub>  | 2 <sup>7</sup> / <sub>8</sub>   | 2 <sup>5</sup> / <sub>8</sub>  | 1 <sup>1</sup> / <sub>8</sub>   | 3 <sup>13</sup> / <sub>16</sub> |
| 1                             | 7 <sup>1</sup> / <sub>4</sub>  | 3 <sup>1</sup> / <sub>4</sub>   | 3                              | 1 <sup>3</sup> / <sub>8</sub>   | 4 <sup>1</sup> / <sub>2</sub>   |
| 1 <sup>1</sup> / <sub>4</sub> | 7 <sup>7</sup> / <sub>16</sub> | 3 <sup>3</sup> / <sub>16</sub>  | 3 <sup>3</sup> / <sub>16</sub> | 1 <sup>3</sup> / <sub>4</sub>   | 5                               |
| 1 <sup>1</sup> / <sub>2</sub> | 8 <sup>3</sup> / <sub>16</sub> | 3 <sup>11</sup> / <sub>16</sub> | 3 <sup>9</sup> / <sub>16</sub> | 1 <sup>15</sup> / <sub>16</sub> | 5 <sup>7</sup> / <sub>16</sub>  |
| 2                             | 9 <sup>9</sup> / <sub>16</sub> | 4 <sup>1</sup> / <sub>4</sub>   | 4 <sup>1</sup> / <sub>8</sub>  | 2 <sup>7</sup> / <sub>16</sub>  | 6 <sup>3</sup> / <sub>8</sub>   |

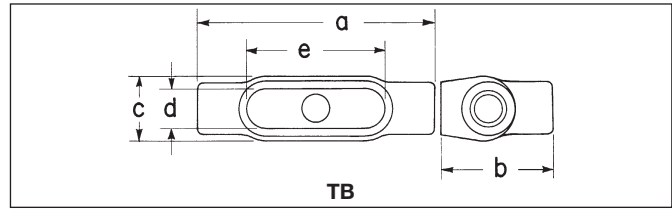

### Form 7TB

| Size                          | a                              | b                              | c                              | d                               | e                               |
|-------------------------------|--------------------------------|--------------------------------|--------------------------------|---------------------------------|---------------------------------|
| 1/2                           | 5 <sup>5</sup> / <sub>8</sub>  | 2 <sup>5</sup> / <sub>8</sub>  | 1 <sup>9</sup> / <sub>16</sub> | 1 <sup>5</sup> / <sub>16</sub>  | 3 <sup>3</sup> / <sub>16</sub>  |
| 3/4                           | 6 <sup>1</sup> / <sub>4</sub>  | 2 <sup>7</sup> / <sub>8</sub>  | 1 <sup>3</sup> / <sub>4</sub>  | 1 <sup>1</sup> / <sub>8</sub>   | 3 <sup>13</sup> / <sub>16</sub> |
| 1                             | 7 <sup>1</sup> / <sub>4</sub>  | 3 <sup>1</sup> / <sub>4</sub>  | 2                              | 1 <sup>3</sup> / <sub>8</sub>   | 4 <sup>1</sup> / <sub>2</sub>   |
| 1 <sup>1</sup> / <sub>4</sub> | 7 <sup>7</sup> / <sub>16</sub> | 3 <sup>5</sup> / <sub>16</sub> | 2 <sup>3</sup> / <sub>16</sub> | 1 <sup>3</sup> / <sub>4</sub>   | 5                               |
| 1 <sup>1</sup> / <sub>2</sub> | 8 <sup>3</sup> / <sub>16</sub> | 5                              | 2 <sup>7</sup> / <sub>16</sub> | 1 <sup>15</sup> / <sub>16</sub> | 5 <sup>7</sup> / <sub>16</sub>  |
| 2                             | 9 <sup>9</sup> / <sub>16</sub> | 6 <sup>1</sup> / <sub>8</sub>  | 3                              | 2 <sup>7</sup> / <sub>16</sub>  | 6 <sup>3</sup> / <sub>8</sub>   |

### Form 8TB

| Size                          | a                               | b                               | c                              | d                              | e                               |
|-------------------------------|---------------------------------|---------------------------------|--------------------------------|--------------------------------|---------------------------------|
| 1/2                           | 5 <sup>11</sup> / <sub>16</sub> | 2 <sup>17</sup> / <sub>32</sub> | 1 <sup>3</sup> / <sub>8</sub>  | 1                              | 3 <sup>5</sup> / <sub>16</sub>  |
| 3/4                           | 6 <sup>9</sup> / <sub>32</sub>  | 2 <sup>3</sup> / <sub>4</sub>   | 1 <sup>9</sup> / <sub>16</sub> | 1 <sup>3</sup> / <sub>16</sub> | 3 <sup>15</sup> / <sub>16</sub> |
| 1                             | 7 <sup>5</sup> / <sub>16</sub>  | 3 <sup>1</sup> / <sub>8</sub>   | 1 <sup>3</sup> / <sub>4</sub>  | 1 <sup>3</sup> / <sub>8</sub>  | 4 <sup>9</sup> / <sub>16</sub>  |
| 1 <sup>1</sup> / <sub>4</sub> | 8 <sup>1</sup> / <sub>2</sub>   | 3 <sup>11</sup> / <sub>32</sub> | 2 <sup>3</sup> / <sub>16</sub> | 1 <sup>3</sup> / <sub>4</sub>  | 5 <sup>5</sup> / <sub>16</sub>  |
| 1 <sup>1</sup> / <sub>2</sub> | 10 <sup>3</sup> / <sub>8</sub>  | 4 <sup>1</sup> / <sub>32</sub>  | 2 <sup>3</sup> / <sub>4</sub>  | 2 <sup>1</sup> / <sub>8</sub>  | 6 <sup>1</sup> / <sub>2</sub>   |
| 2                             | 12 <sup>1</sup> / <sub>4</sub>  | 4 <sup>13</sup> / <sub>16</sub> | 3 <sup>3</sup> / <sub>4</sub>  | 3                              | 8 <sup>9</sup> / <sub>16</sub>  |

### Mark 9TB

| Size                          | a                               | b                               | c                              | d                               | e                               |
|-------------------------------|---------------------------------|---------------------------------|--------------------------------|---------------------------------|---------------------------------|
| 1/2                           | 5 <sup>11</sup> / <sub>16</sub> | 2 <sup>33</sup> / <sub>64</sub> | 1 <sup>3</sup> / <sub>8</sub>  | 1                               | 3 <sup>5</sup> / <sub>16</sub>  |
| 3/4                           | 6 <sup>9</sup> / <sub>16</sub>  | 2 <sup>7</sup> / <sub>8</sub>   | 1 <sup>5</sup> / <sub>8</sub>  | 1 <sup>3</sup> / <sub>16</sub>  | 3 <sup>15</sup> / <sub>16</sub> |
| 1                             | 7 <sup>5</sup> / <sub>16</sub>  | 3 <sup>1</sup> / <sub>8</sub>   | 1 <sup>3</sup> / <sub>4</sub>  | 1 <sup>3</sup> / <sub>8</sub>   | 4 <sup>9</sup> / <sub>16</sub>  |
| 1 <sup>1</sup> / <sub>4</sub> | 8 <sup>1</sup> / <sub>2</sub>   | 3 <sup>11</sup> / <sub>32</sub> | 2 <sup>3</sup> / <sub>16</sub> | 1 <sup>3</sup> / <sub>4</sub>   | 5 <sup>5</sup> / <sub>16</sub>  |
| 1 <sup>1</sup> / <sub>2</sub> | 8 <sup>11</sup> / <sub>32</sub> | 3 <sup>7</sup> / <sub>8</sub>   | 2 <sup>1</sup> / <sub>2</sub>  | 2 <sup>3</sup> / <sub>16</sub>  | 5 <sup>7</sup> / <sub>8</sub>   |
| 2                             | 10 <sup>5</sup> / <sub>8</sub>  | 4 <sup>19</sup> / <sub>32</sub> | 3 <sup>3</sup> / <sub>32</sub> | 2 <sup>13</sup> / <sub>16</sub> | 8 <sup>3</sup> / <sub>32</sub>  |

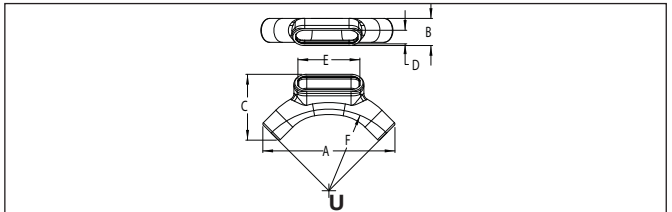

### Form 7U

| Size                          | a                               | b                               | c                               | d                               | e                               | f                              |
|-------------------------------|---------------------------------|---------------------------------|---------------------------------|---------------------------------|---------------------------------|--------------------------------|
| 1/2                           | 7 <sup>1</sup> / <sub>8</sub>   | 1 <sup>1</sup> / <sub>2</sub>   | 3 <sup>11</sup> / <sub>16</sub> | 1 <sup>5</sup> / <sub>16</sub>  | 3 <sup>3</sup> / <sub>16</sub>  | 4 <sup>7</sup> / <sub>16</sub> |
| 3/4                           | 7 <sup>1</sup> / <sub>2</sub>   | 1 <sup>11</sup> / <sub>16</sub> | 3 <sup>7</sup> / <sub>8</sub>   | 1 <sup>1</sup> / <sub>8</sub>   | 3 <sup>13</sup> / <sub>16</sub> | 4 <sup>5</sup> / <sub>8</sub>  |
| 1                             | 9 <sup>11</sup> / <sub>16</sub> | 2                               | 4 <sup>13</sup> / <sub>16</sub> | 1 <sup>3</sup> / <sub>8</sub>   | 4 <sup>1</sup> / <sub>2</sub>   | 6                              |
| 1 <sup>1</sup> / <sub>4</sub> | 12                              | 2 <sup>1</sup> / <sub>2</sub>   | 5 <sup>15</sup> / <sub>16</sub> | 1 <sup>3</sup> / <sub>4</sub>   | 5                               | 7 <sup>7</sup> / <sub>16</sub> |
| 1 <sup>1</sup> / <sub>2</sub> | 15 <sup>1</sup> / <sub>8</sub>  | 2 <sup>7</sup> / <sub>8</sub>   | 7 <sup>3</sup> / <sub>16</sub>  | 1 <sup>15</sup> / <sub>16</sub> | 5 <sup>7</sup> / <sub>16</sub>  | 9 <sup>5</sup> / <sub>8</sub>  |
| 2                             | 17 <sup>5</sup> / <sub>16</sub> | 3 <sup>5</sup> / <sub>8</sub>   | 8 <sup>5</sup> / <sub>8</sub>   | 2 <sup>7</sup> / <sub>16</sub>  | 6 <sup>3</sup> / <sub>8</sub>   | 10 <sup>7</sup> / <sub>8</sub> |

# Condulet® Conduit Bodies - Cast Iron or Aluminum

1F

## Dimensions (In Inches)

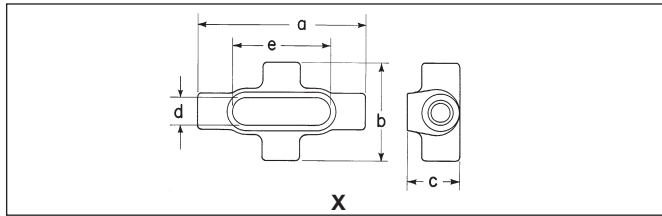

### Form 7X

| Size                          | a                              | b                              | c                              | d                               | e                               |
|-------------------------------|--------------------------------|--------------------------------|--------------------------------|---------------------------------|---------------------------------|
| 1/2                           | 5 <sup>5</sup> / <sub>8</sub>  | 3 <sup>5</sup> / <sub>16</sub> | 1 <sup>3</sup> / <sub>4</sub>  | 1 <sup>5</sup> / <sub>16</sub>  | 3 <sup>3</sup> / <sub>16</sub>  |
| 3/4                           | 6 <sup>1</sup> / <sub>4</sub>  | 3 <sup>1</sup> / <sub>2</sub>  | 2                              | 1 <sup>1</sup> / <sub>8</sub>   | 3 <sup>13</sup> / <sub>16</sub> |
| 1                             | 7 <sup>1</sup> / <sub>4</sub>  | 4                              | 2 <sup>1</sup> / <sub>4</sub>  | 1 <sup>3</sup> / <sub>8</sub>   | 4 <sup>1</sup> / <sub>2</sub>   |
| 1 <sup>1</sup> / <sub>4</sub> | 7 <sup>7</sup> / <sub>16</sub> | 4 <sup>1</sup> / <sub>8</sub>  | 2 <sup>5</sup> / <sub>16</sub> | 1 <sup>3</sup> / <sub>4</sub>   | 5                               |
| 1 <sup>1</sup> / <sub>2</sub> | 8 <sup>3</sup> / <sub>16</sub> | 4 <sup>5</sup> / <sub>8</sub>  | 2 <sup>9</sup> / <sub>16</sub> | 1 <sup>15</sup> / <sub>16</sub> | 5 <sup>7</sup> / <sub>16</sub>  |
| 2                             | 9 <sup>3</sup> / <sub>16</sub> | 5 <sup>3</sup> / <sub>16</sub> | 3 <sup>1</sup> / <sub>8</sub>  | 2 <sup>7</sup> / <sub>16</sub>  | 6 <sup>3</sup> / <sub>8</sub>   |

### Form 8X

|                               |                                 |                                 |                                 |                                |                                 |
|-------------------------------|---------------------------------|---------------------------------|---------------------------------|--------------------------------|---------------------------------|
| 1/2                           | 5 <sup>11</sup> / <sub>16</sub> | 2 <sup>29</sup> / <sub>32</sub> | 1 <sup>3</sup> / <sub>4</sub>   | 1                              | 3 <sup>5</sup> / <sub>16</sub>  |
| 3/4                           | 6 <sup>9</sup> / <sub>32</sub>  | 3 <sup>1</sup> / <sub>16</sub>  | 2                               | 1 <sup>3</sup> / <sub>16</sub> | 3 <sup>15</sup> / <sub>16</sub> |
| 1                             | 7 <sup>9</sup> / <sub>16</sub>  | 3 <sup>1</sup> / <sub>2</sub>   | 2 <sup>1</sup> / <sub>4</sub>   | 1 <sup>3</sup> / <sub>8</sub>  | 4 <sup>9</sup> / <sub>16</sub>  |
| 1 <sup>1</sup> / <sub>4</sub> | 8 <sup>1</sup> / <sub>2</sub>   | 4 <sup>1</sup> / <sub>8</sub>   | 2 <sup>5</sup> / <sub>8</sub>   | 1 <sup>3</sup> / <sub>4</sub>  | 5 <sup>5</sup> / <sub>16</sub>  |
| 1 <sup>1</sup> / <sub>2</sub> | 10 <sup>9</sup> / <sub>8</sub>  | 5 <sup>1</sup> / <sub>4</sub>   | 2 <sup>15</sup> / <sub>32</sub> | 2 <sup>1</sup> / <sub>8</sub>  | 6 <sup>1</sup> / <sub>2</sub>   |
| 2                             | 12 <sup>1</sup> / <sub>4</sub>  | 6 <sup>1</sup> / <sub>4</sub>   | 3 <sup>9</sup> / <sub>16</sub>  | 3                              | 8 <sup>9</sup> / <sub>16</sub>  |

### Mark 9X

|     |                                 |                                 |                               |                                |                                 |
|-----|---------------------------------|---------------------------------|-------------------------------|--------------------------------|---------------------------------|
| 1/2 | 5 <sup>11</sup> / <sub>16</sub> | 2 <sup>57</sup> / <sub>64</sub> | 1 <sup>3</sup> / <sub>4</sub> | 1                              | 3 <sup>5</sup> / <sub>16</sub>  |
| 3/4 | 6 <sup>9</sup> / <sub>16</sub>  | 3 <sup>3</sup> / <sub>4</sub>   | 2                             | 1 <sup>3</sup> / <sub>16</sub> | 3 <sup>15</sup> / <sub>16</sub> |
| 1   | 7 <sup>5</sup> / <sub>16</sub>  | 3 <sup>1</sup> / <sub>2</sub>   | 2 <sup>1</sup> / <sub>4</sub> | 1 <sup>3</sup> / <sub>8</sub>  | 4 <sup>9</sup> / <sub>16</sub>  |

# 1F Condulet® Conduit Bodies - Cast Iron or Aluminum

Gasket and Covers see page 8

1F

## Applications:

- Conduit outlet bodies are installed in conduit systems to:
- Act as pull outlets for conductors being installed
  - Provide openings for making splices and taps in conductors
  - Connect conduit sections
  - Provide taps for branch conduit runs
  - Make 90° bends in conduit runs
  - Provide for access to conductors for maintenance and future system changes

## Features:

### Conduit Outlet Bodies

- Form 7 Condulet outlet bodies approach conduit in size for neat, compact installations
- Form 8 and Mark 9 bodies provide more room for heavier conductors
- Many shapes and sizes are available for rigid threaded conduit – for complete listings see pages 6–12
- Conduit hubs have tapered threads and feature integral bushings for protection of wire insulation
- Form 7 has exclusive snaptight and wedgenut cover attachment to provide clear, unobstructed cover opening
- Built-in rollers on all Form 5 1 1/4" to 4" C and LB bodies to facilitate wire pulling
- Series 5 bodies available in optional configuration with set screws on hubs for EMT conduit (add suffix -MT to catalog number)

### Gaskets

Solid gaskets:

- Are used with blank covers
- For Mark 9 and Form 5, can be converted to open type gaskets by tearing out center section along scored lines – 1/2" to 2" sizes
- For Form 7 are used with all covers

Open gaskets:

- For Form 8 – 1/2" to 4" sizes
- For Mark 9 – 2 1/2" to 4" sizes

### Blank Covers

Stainless steel cover screws are standard on Form 7, Form 8, Mark 9, Series 5 and Form 5 covers.

#### • Form 7

Wedge nut design facilitates installation and removal. Nuts are held captive in cover. Covers can be used with or without gaskets. SNAPTIGHT™ Form 7 Covers with integral sealing gaskets are installed without the use of screws, reducing installation time and costs. Covers are reusable.

#### • Form 8

Two cover screws provided on all sizes to provide tight cover and gasket assembly. *Feraloy* iron alloy covers have dome shapes for added strength and extra wiring room.

#### • Mark 9

Self-retaining cover screws.

## Certifications and Compliances:

Outlet Bodies –

- UL Standard: 514B
- Fed. Spec.: W-C-586D
- CSA Standard 22.2 No. 18
- NEMA 3R Raintight (when installed with cover and gasket)

## Standard Materials:

- Form 7, Form 8 outlet bodies – *Feraloy* iron alloy
- Mark 9 outlet bodies – copper-free aluminum
- Form 5 – malleable iron
- Series 5 – die cast aluminum

## Standard Finishes:

- Form 7, Form 8 outlet bodies – electrogalvanized with aluminum acrylic paint
- Mark 9 outlet bodies – natural
- Form 5 – electrogalvanized with aluminum acrylic paint
- Series 5 – aluminum acrylic paint

## Options:

| Description   | Suffix |
|---|--------|
| Form 7 body and cover only:                                   |        |
| Copper-free aluminum  | SA     |
| <i>Corro-free</i> ™ epoxy powder coat - external body only    | S752   |
| <i>Corro-free</i> ™ epoxy powder coat - internal and external | S753   |
| Series 5 in an EMT version with set screws on all hubs        | MT     |
| Series 5 pre-packaged with neoprene gasket and cover          | CGN    |



Form 7



Mark 9

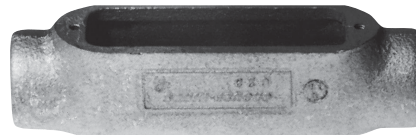

Form 8









Mogul

# Condulet® Conduit Bodies - Cast Iron or Aluminum

1F

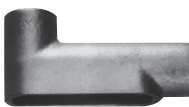
Dimensions Pgs. See pages 10–12 (Dimensions for Form 5 – see Section CP)

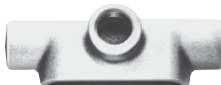
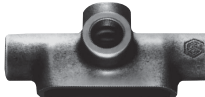
## Threaded Rigid Bodies

| Shape   | Style     | Hub Size |        |        |         |         |         |         |         |         |         |  |
|---|-----------|----------|--------|--------|---------|---------|---------|---------|---------|---------|---------|--|
|   |           | 1/2      | 3/4    | 1      | 1 1/4   | 1 1/2   | 2       | 2 1/2   | 3       | 3 1/2   | 4       |  |
|                                  | <b>C</b>  |          |        |        |         |         |         |         |         |         |         |  |
|   | Form 7    | C17      | C27    | C37    | C47     | C57     | C67     | C77     | C87     |         |         |  |
|   | Form 8    | C18      | C28    | C38    | C448    | C58     | C68     | C78     | C88     |         |         |  |
|   | Mark 9    | C19      | C29    | C39    | C49     | C59     | C69     | C789    | C889    | C989    | C1089   |  |
|   | Form 5    | C50M     | C75M   | C100M  | C125M*  | C150M*  | C200M*  | C250M*  | C300M*  | C350M*  | C400M*  |  |
| Series 5  | C15       | C25      | C35    | C45    | C55     | C65     | C75     | C85     | C95*    | C105*   |         |  |
|                                  | <b>E</b>  |          |        |        |         |         |         |         |         |         |         |  |
|   | Form 7    | E17      | E27    | E37    |         |         |         |         |         |         |         |  |
|                                  | <b>L</b>  |          |        |        |         |         |         |         |         |         |         |  |
|   | Form 7    | L17      | L27    | L37    | L47     | L57     | L67     |         |         |         |         |  |
| Double faced – may be used as LL or LR – has 2 openings, one of which is furnished with a blank sheet steel cover |           |          |        |        |         |         |         |         |         |         |         |  |
|                                  | <b>LB</b> |          |        |        |         |         |         |         |         |         |         |  |
|   | Form 7    | LB17     | LB27   | LB37   | LB47    | LB57    | LB67    | LB777   | LB87    | LB97    | LB107   |  |
|   | Form 8    | LB18     | LB28   | LB38   | LB448   | LB58    | LB68    | LB78    | LB888   | LB98    | LB108   |  |
|   | Mark 9    | LB19     | LB29   | LB39   | LB49    | LB59    | LB69    | LB789   | LB889   | LB989   | LB1089  |  |
|   | Form 5    | LB50M    | LB75M  | LB100M | LB125M* | LB150M* | LB200M* | LB250M* | LB300M* | LB350M* | LB400M* |  |
| Series 5  | LB15      | LB25     | LB35   | LB45   | LB55    | LB65    | LB75    | LB85    | LB95    | LB105   |         |  |
|                                  | <b>LL</b> |          |        |        |         |         |         |         |         |         |         |  |
|   | Form 7    | LL17     | LL27   | LL37   | LL47    | LL57    | LL67    | LL777   | LL87    | LL97    | LL107   |  |
|   | Form 8    | LL18     | LL28   | LL38   | LL448   | LL58    | LL68    | LL78    | LL888   |         |         |  |
|   | Mark 9    | LL19     | LL29   | LL39   | LL49    | LL59    | LL69    | LL789   | LL889   | LL989   | LL1089  |  |
|   | Form 5    | LL50M    | LL75M  | LL100M | LL125M  | LL150M  | LL200M  | LL250M  | LL300M  | LL350M  | LL400M  |  |
| Series 5  | LL15      | LL25     | LL35   | LL45   | LL55    | LL65    | LL75    | LL85    | LL95    | LL105   |         |  |
|                                | <b>LR</b> |          |        |        |         |         |         |         |         |         |         |  |
|   | Form 7    | LR17     | LR27   | LR37   | LR47    | LR57    | LR67    | LR777   | LR87    | LR97    | LR107   |  |
|   | Form 8    | LR18     | LR28   | LR38   | LR448   | LR58    | LR68    | LR78    | LR888   |         |         |  |
|   | Mark 9    | LR19     | LR29   | LR39   | LR49    | LR59    | LR69    | LR789   | LR889   | LR989   | LR1089  |  |
|   | Form 5    | LR50M    | LR75M  | LR100M | LR125M  | LR150M  | LR200M  | LR250M  | LR300M  | LR350M  | LR400M  |  |
| Series 5  | LR15      | LR25     | LR35   | LR45   | LR55    | LR65    | LR75    | LR85    | LR95    | LR105   |         |  |
|                                | <b>T</b>  |          |        |        |         |         |         |         |         |         |         |  |
|   | Form 7    | T17      | T27    | T37    | T47     | T57     | T67     | T77     | T87     | T97     | T107    |  |
|   | Form 8    | T18      | T28    | T38    | T448    | T58     | T68     | T78     | T88     |         |         |  |
|   | Mark 9    | T19      | T29    | T39    | T49     | T59     | T69     | T789    | T889    | T989    | T1089   |  |
|   | Form 5    | T50M     | T75M   | T100M  | T125M   | T150M   | T200M   | T250M   | T300M   | T350M   | T400M   |  |
| Series 5  | T15       | T25      | T35    | T45    | T55     | T65     | T75     | T85     | T95*    | T105*   |         |  |
|                                | <b>TA</b> |          |        |        |         |         |         |         |         |         |         |  |
|   | Form 7    | TA17     | TA27   | TA37   | TA47    | TA57    | TA67    |         |         |         |         |  |
|                                | <b>TB</b> |          |        |        |         |         |         |         |         |         |         |  |
|   | Form 7    | TB17     | TB27   | TB37   | TB47    | TB57    | TB67    |         |         |         |         |  |
|   | Form 8    | TB18     | TB28   | TB38   | TB448   | TB58    | TB68    |         |         |         |         |  |
|   | Mark 9    | TB19     | TB29   | TB39   | TB49    | TB59    | TB69    |         |         |         |         |  |
|   | Form 5    | TB15     | TB25   | TB35   | TB45    | TB55    | TB65    |         |         |         |         |  |
| Series 5  | TB50M     | TB75M    | TB100M | TB125M | TB150M  | TB200M  |         |         |         |         |         |  |
|                                | <b>X</b>  |          |        |        |         |         |         |         |         |         |         |  |
|   | Form 7    | X17      | X27    | X37    | X47     | X57     | X67     |         |         |         |         |  |
|   | Form 8    | X18      | X28    | X38    | X448    | X58     | X68     |         |         |         |         |  |
|   | Mark 9    | X19      | X29    | X39    |         |         |         |         |         |         |         |  |
|   | Form 5    | X15      | X25    | X35    | X45     | X55     | X65     |         |         |         |         |  |
| Series 5  | X50M      | X75M     | X100M  | X125M  | X150M   | X200M   |         |         |         |         |         |  |

\* 1 1/2" - 4" Form 5 LB and C bodies are supplied with built-in rollers to facilitate wire pulling.

## Covers and Gaskets

Dimensions Pgs. See pages 10–12 (Dimensions for Form 5 – see Section CP)

### Blank Covers



Sheet Steel

| Size  | Form 7 Wedgenut Cat. # | Form 7 Snaptight™ Covers‡ Cat. # | Form 7 Wedgenut w/Integral Gasket Cat. # | Form 8§ Cat. # | Form 8 w/Integral Gasket Cat. # | Form 5 w/Integral Gasket** Cat. # |
|-------|------------------------|----------------------------------|--|----------------|---------------------------------|-----------------------------------|
| 1/2   | 170                    | 170SG                            | 170G                                     | 180            | 180G                            | K50SG                             |
| 3/4   | 270                    | 270SG                            | 270G                                     | 280            | 280G                            | K75SG                             |
| 1     | 370                    | 370SG                            | 370G                                     | 380            | 380G                            | K100SG                            |
| 1 1/4 | 470                    | 470SG                            | 470G                                     | 480            | 480G                            | K125SG                            |
| 1 1/2 | 570                    | 570SG                            | 570G                                     | 580            | 580G                            | K125SG                            |
| 2     | 670                    | 670SG                            | 670G                                     | 680            | 680G                            | K200SG                            |
| 2 1/2 | 870                    |                                  | 870G                                     | 880            |                                 | K250SG                            |
| 3     | 870                    |                                  | 870G                                     | 880            |                                 | K250SG                            |
| 3 1/2 | 970                    |                                  | 970G                                     | 980            |                                 | K350SG                            |
| 4     | 970                    |                                  | 970G                                     | 980            |                                 | K350SG                            |

‡Form 7 Snaptight covers with integral sealing gasket are installed without the use of screws.  
§Two cover screws on 1/2" to 2" Form 8 covers and four cover screws on 2 1/2" and larger Form 8 covers.  
\*\*For cover without integral gasket, remove G from catalog number.



Sheet Aluminum



Feraloy® Iron Alloy



Cast Aluminum

| Size  | Mark 9 Cat. # | Mark 9 w/Integral Gasket Cat. # | Form 7 Cat. # | Form 7 w/Integral Gasket Cat. # | Series 5 w/Integral Gasket** Cat. # | Form 7 Wedgenut Cat. # | Form 7 Wedgenut w/Integral Gasket Cat. # | Form 8§ Cat. # | Form 5‡ Cat. # | Form 7 Wedgenut Cat. # |
|-------|---------------|---------------------------------|---------------|---------------------------------|-------------------------------------|------------------------|--|----------------|----------------|------------------------|
| 1/2   | 190           | 190G                            | 170 SA        | 170G SA                         | 150 G                               | 170F                   | 170FG                                    | 180F           | K50CM          | 170F SA                |
| 3/4   | 290           | 290G                            | 270 SA        | 270G SA                         | 250 G                               | 270F                   | 270FG                                    | 280F           | K75CM          | 270F SA                |
| 1     | 390           | 390G                            | 370 SA        | 370G SA                         | 350 G                               | 370F                   | 370FG                                    | 380F           | K100CM         | 370F SA                |
| 1 1/4 | 490           | 490G                            | 470 SA        | 470G SA                         | 450 G                               | 470F                   | 470FG                                    | 480F           | K125CM         | 470F SA                |
| 1 1/2 | 590           | 590G                            | 570 SA        | 570G SA                         | 450 G                               | 570F                   | 570FG                                    | 580F           | K125CM         | 570F SA                |
| 2     | 690           | 690G                            | 670 SA        | 670G SA                         | 650 G                               | 670F                   | 670FG                                    | 680F           | K200CM         | 670F SA                |
| 2 1/2 | 889           |                                 | 870 SA        |                                 | 850 G                               | 870F                   |  | 880F           | K250CM         | 870F SA                |
| 3     | 889           |                                 | 870 SA        |                                 | 850 G                               | 870F                   |  | 880F           | K250CM         | 870F SA                |
| 3 1/2 | 989           |                                 | 970 SA        |                                 | 950 G                               | 970F                   |  | 980F           | K350CM         | 970F SA                |
| 4     | 989           |                                 | 970 SA        |                                 | 950 G                               | 970F                   |  | 980F           | K350CM         | 970F SA                |

‡Malleable iron covers.  
§Two cover screws on 1/2" to 2" Form 8 covers and four cover screws on 2 1/2" and larger Form 8 covers.  
\*\*For cover without integral gasket, remove G from catalog number.

### Solid Gaskets - Neoprene



| Size  | Form 7 Cat. # | Form 8* Cat. # | Mark 9† Cat. # | Form 5 Cat. # | Series 5 Cat. # |
|-------|---------------|----------------|----------------|---------------|-----------------|
| 1/2   | GASK571       | GASK851N       | GASK1941       | GK50N         | GASK015N        |
| 3/4   | GASK572       | GASK852N       | GASK1942       | GK75N         | GASK025N        |
| 1     | GASK573       | GASK853N       | GASK1943       | GK100N        | GASK035N        |
| 1 1/4 | GASK574       | GASK854N       | GASK1944       | GK125N        | GASK045N        |
| 1 1/2 | GASK575       | GASK805N       | GASK1945       | GK125N        | GASK045N        |
| 2     | GASK576       | GASK806N       | GASK1946       | GK200N        | GASK065N        |
| 2 1/2 | GASK578       | GASK808N       | GASK808N       | GK250N        | GASK085N        |
| 3     | GASK578       | GASK808N       | GASK808N       | GK250N        | GASK085N        |
| 3 1/2 | GASK579       | GASK809N       | GASK809N       | GK350N        | GASK095N        |
| 4     | GASK579       | GASK809N       | GASK809N       | GK350N        | GASK095N        |

\*1/2 – 1 1/4 are solid gaskets; 1 1/2 – 4 are open gaskets.  
†1/2 – 2 are solid gaskets; 2 1/2 – 4 are open gaskets.

# Condulet® Conduit Bodies - Cast Iron or Aluminum

Dimensions (In Inches)

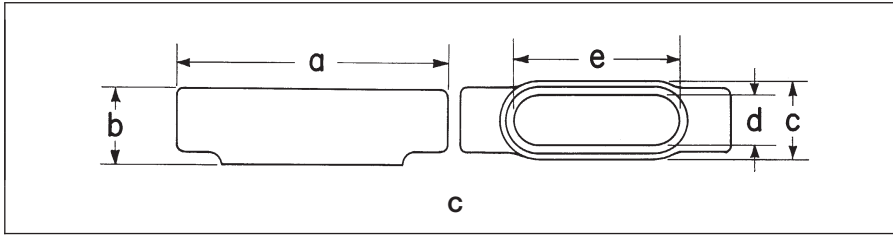

### Form 7 C

| Size | 1/2    | 3/4     | 1     | 1 1/4  | 1 1/2   | 2      | 2 1/2  | 3      |
|------|--------|---------|-------|--------|---------|--------|--------|--------|
| a    | 5 5/8  | 6       | 7     | 7 7/16 | 8 3/16  | 9 3/16 | 12     | 11 3/4 |
| b    | 1 3/8  | 1 5/8   | 1 7/8 | 2 5/16 | 2 9/16  | 3 1/8  | 3 5/8  | 4 3/8  |
| c    | 1 3/8  | 1 9/16  | 1 3/4 | 2 3/16 | 2 7/16  | 3      | 4 1/4  | 4 1/4  |
| d    | 1 5/16 | 1 1/8   | 1 3/8 | 1 3/4  | 1 15/16 | 2 7/16 | 3 3/16 | 3 9/16 |
| e    | 3 3/16 | 3 13/16 | 4 1/2 | 5      | 5 7/16  | 6 5/8  | 8 3/8  | 8 5/8  |

### Form 8 C

| Size | 1/2     | 3/4     | 1       | 1 1/4  | 1 1/2   | 2      | 2 1/2  | 3       |
|------|---------|---------|---------|--------|---------|--------|--------|---------|
| a    | 5 11/16 | 6 9/32  | 7 5/16  | 8 1/2  | 10 3/8  | 12 1/4 | 15 5/8 | 15 5/8  |
| b    | 1 7/16  | 1 11/16 | 1 15/16 | 2 3/8  | 2 25/32 | 3 3/16 | 4 7/16 | 4 13/16 |
| c    | 1 3/8   | 1 3/16  | 1 3/4   | 2 3/16 | 2 3/4   | 3 3/4  | 5      | 5       |
| d    | 1       | 1 3/16  | 1 3/8   | 1 3/4  | 2 1/8   | 3      | 4 1/4  | 4 1/4   |
| e    | 3 5/16  | 3 15/16 | 4 9/16  | 5 5/16 | 6 1/2   | 8 9/16 | 10 7/8 | 10 7/8  |

### Mark 9 C

| Size | 1/2     | 3/4     | 1       | 1 1/4   | 1 1/2   | 2       | 2 1/2  | 3       | 3 1/2   | 4       |
|------|---------|---------|---------|---------|---------|---------|--------|---------|---------|---------|
| a    | 4 31/32 | 5 11/32 | 6 19/32 | 7 5/8   | 8 11/32 | 10 5/8  | 15 5/8 | 15 5/8  | 18 3/4  | 18 3/4  |
| b    | 1 13/32 | 1 5/8   | 1 7/8   | 2 1/2   | 2 13/16 | 3 7/16  | 4 7/16 | 4 13/16 | 5 11/16 | 5 15/16 |
| c    | 1 3/8   | 1 9/16  | 1 3/4   | 2 3/16  | 2 1/2   | 3 3/2   | 5      | 5       | 6 1/4   | 6 1/4   |
| d    | 1 1/8   | 1 1/4   | 1 5/8   | 1 27/32 | 2 7/32  | 2 25/32 | 4 1/4  | 4 1/4   | 5 1/16  | 5 7/16  |
| e    | 3 9/32  | 3 27/32 | 4 9/16  | 5 3/16  | 5 5/8   | 8 3/32  | 10 7/8 | 10 7/8  | 13 7/16 | 13 7/16 |

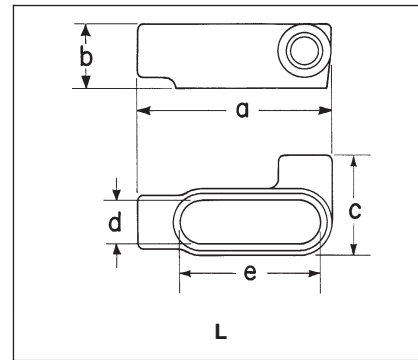
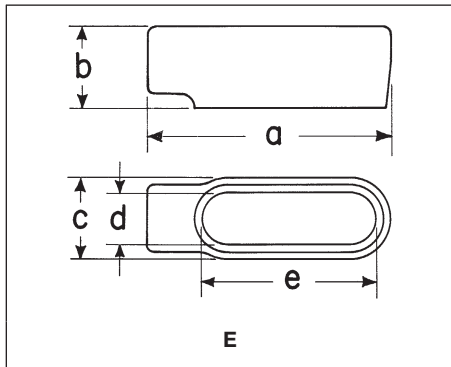

### Form 7 E

| Size | 1/2    | 3/4     | 1     |
|------|--------|---------|-------|
| a    | 4 9/16 | 5 3/16  | 6     |
| b    | 1 3/8  | 1 5/8   | 1 7/8 |
| c    | 1 3/8  | 1 9/16  | 1 3/4 |
| d    | 1 5/16 | 1 1/8   | 1 3/8 |
| e    | 3 3/16 | 3 13/16 | 4 1/2 |

### Form 7 L

| Size | 1/2    | 3/4     | 1     | 1 1/4  | 1 1/2   | 2      |
|------|--------|---------|-------|--------|---------|--------|
| a    | 4 9/16 | 5 3/16  | 6     | 6 1/2  | 7 1/8   | 3 3/8  |
| b    | 1 3/8  | 1 5/8   | 1 7/8 | 2 5/16 | 2 9/16  | 3 3/8  |
| c    | 2 1/4  | 2 7/16  | 2 3/4 | 3 3/16 | 3 9/16  | 4 1/8  |
| d    | 1 5/16 | 1 1/8   | 1 3/8 | 1 3/4  | 1 15/16 | 2 7/16 |
| e    | 3 3/16 | 3 13/16 | 4 1/2 | 5      | 5 7/16  | 6 5/8  |

# Condulet® Conduit Bodies - Cast Iron or Aluminum

1F

## Dimensions (In Inches)

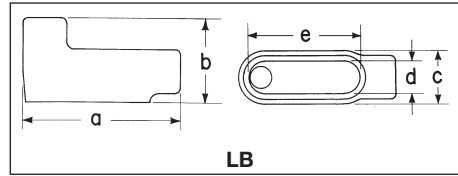

### Form 7 LB

| Size | 1/2                            | 3/4                            | 1     | 1 1/4  | 1 1/2   | 2      | 2 1/2  | 3      | 3 1/2    | 4        |
|------|--------------------------------|--------------------------------|-------|--------|---------|--------|--------|--------|----------|----------|
| a    | 4 <sup>9</sup> / <sub>16</sub> | 5 <sup>9</sup> / <sub>16</sub> | 6     | 6 1/2  | 7 1/8   | 8 3/8  | 10 1/2 | 10 1/2 | 12 11/16 | 12 11/16 |
| b    | 2 1/4                          | 2 1/2                          | 2 7/8 | 3 5/16 | 3 11/16 | 4 1/4  | 5 1/8  | 5 7/8  | 6 9/16   | 7 1/16   |
| c    | 1 3/8                          | 1 9/16                         | 1 3/4 | 2 3/16 | 2 7/16  | 3      | 4 1/4  | 4 1/4  | 5 1/4    | 5 1/4    |
| d    | 1 5/16                         | 1 1/8                          | 1 3/8 | 1 3/4  | 1 15/16 | 2 7/16 | 3 9/16 | 3 9/16 | 4 1/2    | 4 1/2    |
| e    | 3 3/16                         | 3 13/16                        | 4 1/2 | 5      | 5 7/16  | 6 3/8  | 8 3/8  | 8 3/8  | 10 1/4   | 10 1/4   |

### Form 8 LB

| Size | 1/2     | 3/4     | 1       | 1 1/4   | 1 1/2  | 2       | 2 1/2    | 3        | 3 1/2   | 4       |
|------|---------|---------|---------|---------|--------|---------|----------|----------|---------|---------|
| a    | 4 15/16 | 5 9/16  | 6 15/32 | 7 17/32 | 9 1/8  | 11      | 13 15/16 | 13 15/16 | 16 7/8  | 16 7/8  |
| b    | 2 7/32  | 2 7/16  | 2 13/16 | 3 11/32 | 4 1/32 | 4 13/16 | 6 1/8    | 6 1/2    | 7 9/16  | 7 13/16 |
| c    | 1 3/8   | 1 9/16  | 1 3/4   | 2 3/16  | 2 3/4  | 3 3/4   | 5        | 5        | 6 1/4   | 6 1/4   |
| d    | 1       | 1 3/16  | 1 3/8   | 1 3/4   | 2 1/8  | 3       | 4 1/4    | 4 1/4    | 5 1/16  | 5 1/16  |
| e    | 3 5/16  | 3 15/16 | 4 9/16  | 5 5/16  | 6 1/2  | 8 9/16  | 10 7/8   | 10 7/8   | 13 7/16 | 13 7/16 |

### Mark 9 LB

| Size | 1/2     | 3/4     | 1       | 1 1/4  | 1 1/2   | 2       | 2 1/2    | 3        | 3 1/2   | 4       |
|------|---------|---------|---------|--------|---------|---------|----------|----------|---------|---------|
| a    | 4 19/32 | 5 1/4   | 6 3/32  | 7 3/32 | 7 25/32 | 10 3/32 | 13 15/16 | 13 15/16 | 16 7/8  | 16 7/8  |
| b    | 2 1/8   | 2 15/32 | 2 13/16 | 3 5/8  | 3 3/8   | 4 9/32  | 6 1/8    | 6 1/2    | 7 9/16  | 7 13/16 |
| c    | 1 3/8   | 1 19/32 | 1 3/4   | 2 3/16 | 2 1/2   | 3 7/32  | 5        | 5        | 6 1/4   | 6 1/4   |
| d    | 1 1/16  | 1 9/32  | 1 7/16  | 1 7/8  | 2 3/16  | 2 29/32 | 4 1/4    | 4 1/4    | 5 1/16  | 5 1/16  |
| e    | 3 3/32  | 3 27/32 | 4 9/16  | 5 3/16 | 5 5/8   | 8 3/32  | 10 7/8   | 10 7/8   | 13 7/16 | 13 7/16 |



### Form 7 LL & LR

| Size | 1/2    | 3/4     | 1     | 1 1/4  | 1 1/2   | 2      | 2 1/2  | 3      | 3 1/2    | 4        |
|------|--------|---------|-------|--------|---------|--------|--------|--------|----------|----------|
| a    | 4 9/16 | 5 9/16  | 6     | 6 1/2  | 7 1/8   | 8 3/8  | 10 1/2 | 10 1/2 | 12 11/16 | 12 11/16 |
| b    | 1 3/8  | 1 5/8   | 1 7/8 | 2 5/16 | 2 9/16  | 3 3/8  | 3 5/8  | 4 3/8  | 4 7/8    | 5 5/8    |
| c    | 2 1/4  | 2 7/16  | 2 3/4 | 3 3/16 | 3 9/16  | 4 1/8  | 5 3/4  | 5 3/4  | 6 15/16  | 6 15/16  |
| d    | 1 5/16 | 1 1/8   | 1 3/8 | 1 3/4  | 1 15/16 | 2 7/16 | 3 9/16 | 3 9/16 | 4 1/2    | 4 1/2    |
| e    | 3 3/16 | 3 13/16 | 4 1/2 | 5      | 5 7/16  | 6 3/8  | 8 3/8  | 8 3/8  | 10 1/4   | 10 1/4   |

### Form 8 LL & LR

| Size | 1/2     | 3/4     | 1       | 1 1/4   | 1 1/2   | 2      | 2 1/2    | 3        |
|------|---------|---------|---------|---------|---------|--------|----------|----------|
| a    | 4 15/16 | 5 9/16  | 6 15/32 | 7 17/32 | 9 1/8   | 11     | 13 15/16 | 13 15/16 |
| b    | 1 7/16  | 1 11/16 | 1 15/16 | 2 3/8   | 2 25/32 | 3 9/16 | 4 7/16   | 4 13/16  |
| c    | 2 5/32  | 2 5/16  | 2 5/8   | 3 3/32  | 4       | 5      | 6 11/16  | 6 11/16  |
| d    | 1       | 1 3/16  | 1 3/8   | 1 3/4   | 2 1/8   | 3      | 4 1/4    | 4 1/4    |
| e    | 3 5/16  | 3 15/16 | 4 9/16  | 5 5/16  | 6 1/2   | 8 9/16 | 10 7/8   | 10 7/8   |

### Mark 9 LL & LR

| Size | 1/2     | 3/4     | 1       | 1 1/4  | 1 1/2   | 2       | 2 1/2    | 3        | 3 1/2   | 4       |
|------|---------|---------|---------|--------|---------|---------|----------|----------|---------|---------|
| a    | 4 19/32 | 5 1/4   | 6 3/32  | 7 3/32 | 7 1/64  | 10 3/32 | 13 15/16 | 13 15/16 | 16 7/8  | 16 7/8  |
| b    | 1 13/32 | 1 5/8   | 1 7/8   | 2 1/2  | 2 13/16 | 3 7/16  | 4 7/16   | 4 13/16  | 5 11/16 | 5 13/16 |
| c    | 2 1/8   | 2 5/16  | 2 11/16 | 3 1/4  | 3 1/2   | 4 19/64 | 6 11/16  | 6 11/16  | 8 1/8   | 8 1/8   |
| d    | 1 1/16  | 1 1/4   | 1 3/8   | 1 7/8  | 2 1/16  | 2 29/32 | 4 1/4    | 4 1/4    | 5 1/16  | 5 1/16  |
| e    | 3 3/32  | 3 27/32 | 4 9/16  | 5 3/16 | 5 5/8   | 8 3/32  | 10 7/8   | 10 7/8   | 13 7/16 | 13 7/16 |

1F

# Condulet® Conduit Bodies - Cast Iron or Aluminum

Dimensions (In Inches)

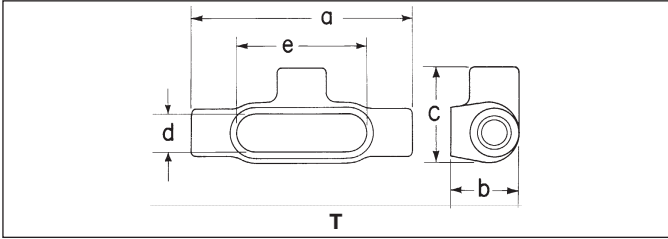

**Form 7T**

| Size                          | a                               | b                              | c                               | d                               | e                               |
|-------------------------------|---------------------------------|--------------------------------|---------------------------------|---------------------------------|---------------------------------|
| 1/2                           | 5 <sup>5</sup> / <sub>8</sub>   | 1 <sup>3</sup> / <sub>4</sub>  | 2 <sup>7</sup> / <sub>16</sub>  | 1 <sup>5</sup> / <sub>16</sub>  | 3 <sup>3</sup> / <sub>16</sub>  |
| 3/4                           | 6 <sup>1</sup> / <sub>4</sub>   | 2                              | 2 <sup>5</sup> / <sub>8</sub>   | 1 <sup>1</sup> / <sub>8</sub>   | 3 <sup>13</sup> / <sub>16</sub> |
| 1                             | 7 <sup>1</sup> / <sub>4</sub>   | 2 <sup>1</sup> / <sub>4</sub>  | 3                               | 1 <sup>3</sup> / <sub>8</sub>   | 4 <sup>1</sup> / <sub>2</sub>   |
| 1 <sup>1</sup> / <sub>4</sub> | 7 <sup>7</sup> / <sub>16</sub>  | 2 <sup>5</sup> / <sub>16</sub> | 3 <sup>3</sup> / <sub>16</sub>  | 1 <sup>3</sup> / <sub>4</sub>   | 5                               |
| 1 <sup>1</sup> / <sub>2</sub> | 8 <sup>3</sup> / <sub>16</sub>  | 2 <sup>9</sup> / <sub>16</sub> | 3 <sup>9</sup> / <sub>16</sub>  | 1 <sup>15</sup> / <sub>16</sub> | 5 <sup>7</sup> / <sub>16</sub>  |
| 2                             | 9 <sup>9</sup> / <sub>16</sub>  | 3 <sup>1</sup> / <sub>8</sub>  | 4 <sup>1</sup> / <sub>8</sub>   | 2 <sup>7</sup> / <sub>16</sub>  | 6 <sup>3</sup> / <sub>8</sub>   |
| 2 <sup>1</sup> / <sub>2</sub> | 12                              | 3 <sup>5</sup> / <sub>8</sub>  | 5 <sup>1</sup> / <sub>4</sub>   | 3 <sup>9</sup> / <sub>16</sub>  | 8 <sup>3</sup> / <sub>8</sub>   |
| 3                             | 12 <sup>1</sup> / <sub>16</sub> | 4 <sup>3</sup> / <sub>8</sub>  | 5 <sup>1</sup> / <sub>4</sub>   | 3 <sup>9</sup> / <sub>16</sub>  | 8 <sup>3</sup> / <sub>8</sub>   |
| 3 <sup>1</sup> / <sub>2</sub> | 14 <sup>5</sup> / <sub>16</sub> | 4 <sup>7</sup> / <sub>8</sub>  | 6 <sup>15</sup> / <sub>16</sub> | 4 <sup>1</sup> / <sub>2</sub>   | 10 <sup>1</sup> / <sub>4</sub>  |
| 4                             | 14 <sup>5</sup> / <sub>16</sub> | 5 <sup>3</sup> / <sub>8</sub>  | 6 <sup>15</sup> / <sub>16</sub> | 4 <sup>1</sup> / <sub>2</sub>   | 10 <sup>1</sup> / <sub>4</sub>  |

**Form 8T**

| Size                          | a                               | b                               | c                               | d                              | e                               |
|-------------------------------|---------------------------------|---------------------------------|---------------------------------|--------------------------------|---------------------------------|
| 1/2                           | 5 <sup>11</sup> / <sub>16</sub> | 1 <sup>3</sup> / <sub>4</sub>   | 2 <sup>5</sup> / <sub>32</sub>  | 1                              | 3 <sup>5</sup> / <sub>16</sub>  |
| 3/4                           | 6 <sup>9</sup> / <sub>32</sub>  | 2                               | 2 <sup>5</sup> / <sub>16</sub>  | 1 <sup>3</sup> / <sub>16</sub> | 3 <sup>15</sup> / <sub>16</sub> |
| 1                             | 7 <sup>5</sup> / <sub>16</sub>  | 2 <sup>1</sup> / <sub>4</sub>   | 2 <sup>5</sup> / <sub>8</sub>   | 1 <sup>3</sup> / <sub>8</sub>  | 4 <sup>9</sup> / <sub>16</sub>  |
| 1 <sup>1</sup> / <sub>4</sub> | 8 <sup>1</sup> / <sub>2</sub>   | 2 <sup>5</sup> / <sub>8</sub>   | 3 <sup>5</sup> / <sub>32</sub>  | 1 <sup>3</sup> / <sub>4</sub>  | 5 <sup>5</sup> / <sub>16</sub>  |
| 1 <sup>1</sup> / <sub>2</sub> | 10 <sup>3</sup> / <sub>8</sub>  | 2 <sup>25</sup> / <sub>32</sub> | 4                               | 2 <sup>1</sup> / <sub>8</sub>  | 6 <sup>1</sup> / <sub>2</sub>   |
| 2                             | 12 <sup>1</sup> / <sub>4</sub>  | 3 <sup>9</sup> / <sub>16</sub>  | 5                               | 3                              | 8 <sup>9</sup> / <sub>16</sub>  |
| 2 <sup>1</sup> / <sub>2</sub> | 15 <sup>5</sup> / <sub>8</sub>  | 4 <sup>7</sup> / <sub>16</sub>  | 6 <sup>11</sup> / <sub>16</sub> | 4 <sup>1</sup> / <sub>4</sub>  | 10 <sup>7</sup> / <sub>8</sub>  |
| 3                             | 15 <sup>5</sup> / <sub>8</sub>  | 4 <sup>13</sup> / <sub>16</sub> | 6 <sup>11</sup> / <sub>16</sub> | 4 <sup>1</sup> / <sub>4</sub>  | 10 <sup>7</sup> / <sub>8</sub>  |

**Mark 9T**

| Size                          | a                               | b                               | c                               | d                               | e                               |
|-------------------------------|---------------------------------|---------------------------------|---------------------------------|---------------------------------|---------------------------------|
| 1/2                           | 5                               | 1 <sup>13</sup> / <sub>32</sub> | 2 <sup>1</sup> / <sub>8</sub>   | 1 <sup>1</sup> / <sub>16</sub>  | 3 <sup>9</sup> / <sub>32</sub>  |
| 3/4                           | 5 <sup>11</sup> / <sub>16</sub> | 1 <sup>5</sup> / <sub>8</sub>   | 2 <sup>5</sup> / <sub>16</sub>  | 1 <sup>1</sup> / <sub>4</sub>   | 3 <sup>27</sup> / <sub>32</sub> |
| 1                             | 6 <sup>19</sup> / <sub>32</sub> | 1 <sup>7</sup> / <sub>8</sub>   | 2 <sup>11</sup> / <sub>16</sub> | 1 <sup>3</sup> / <sub>8</sub>   | 4 <sup>9</sup> / <sub>16</sub>  |
| 1 <sup>1</sup> / <sub>4</sub> | 7 <sup>5</sup> / <sub>8</sub>   | 2 <sup>1</sup> / <sub>2</sub>   | 3 <sup>1</sup> / <sub>4</sub>   | 1 <sup>7</sup> / <sub>8</sub>   | 5 <sup>3</sup> / <sub>16</sub>  |
| 1 <sup>1</sup> / <sub>2</sub> | 8 <sup>11</sup> / <sub>32</sub> | 2 <sup>13</sup> / <sub>16</sub> | 3 <sup>1</sup> / <sub>2</sub>   | 2 <sup>3</sup> / <sub>16</sub>  | 5 <sup>7</sup> / <sub>8</sub>   |
| 2                             | 10 <sup>5</sup> / <sub>8</sub>  | 3 <sup>7</sup> / <sub>16</sub>  | 4 <sup>13</sup> / <sub>32</sub> | 2 <sup>29</sup> / <sub>32</sub> | 8 <sup>3</sup> / <sub>32</sub>  |
| 2 <sup>1</sup> / <sub>2</sub> | 15 <sup>5</sup> / <sub>8</sub>  | 4 <sup>7</sup> / <sub>16</sub>  | 6 <sup>11</sup> / <sub>16</sub> | 4 <sup>1</sup> / <sub>4</sub>   | 10 <sup>7</sup> / <sub>8</sub>  |
| 3                             | 15 <sup>5</sup> / <sub>8</sub>  | 4 <sup>13</sup> / <sub>16</sub> | 6 <sup>11</sup> / <sub>16</sub> | 4 <sup>1</sup> / <sub>4</sub>   | 10 <sup>7</sup> / <sub>8</sub>  |
| 3 <sup>1</sup> / <sub>2</sub> | 18 <sup>3</sup> / <sub>4</sub>  | 5 <sup>11</sup> / <sub>16</sub> | 8 <sup>1</sup> / <sub>8</sub>   | 5 <sup>7</sup> / <sub>16</sub>  | 13 <sup>7</sup> / <sub>16</sub> |
| 4                             | 18 <sup>3</sup> / <sub>4</sub>  | 5 <sup>15</sup> / <sub>16</sub> | 8 <sup>1</sup> / <sub>8</sub>   | 5 <sup>7</sup> / <sub>16</sub>  | 13 <sup>7</sup> / <sub>16</sub> |

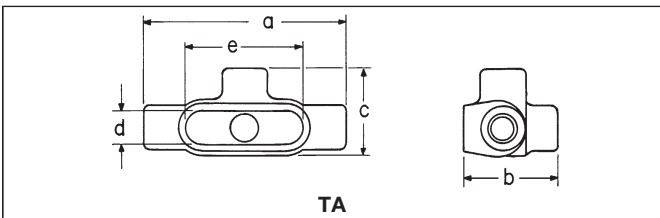

**Form 7TA**

| Size                          | a                              | b                               | c                              | d                               | e                               |
|-------------------------------|--------------------------------|---------------------------------|--------------------------------|---------------------------------|---------------------------------|
| 1/2                           | 5 <sup>5</sup> / <sub>8</sub>  | 2 <sup>5</sup> / <sub>8</sub>   | 2 <sup>7</sup> / <sub>16</sub> | 1 <sup>5</sup> / <sub>16</sub>  | 3 <sup>3</sup> / <sub>16</sub>  |
| 3/4                           | 6 <sup>1</sup> / <sub>4</sub>  | 2 <sup>7</sup> / <sub>8</sub>   | 2 <sup>5</sup> / <sub>8</sub>  | 1 <sup>1</sup> / <sub>8</sub>   | 3 <sup>13</sup> / <sub>16</sub> |
| 1                             | 7 <sup>1</sup> / <sub>4</sub>  | 3 <sup>1</sup> / <sub>4</sub>   | 3                              | 1 <sup>3</sup> / <sub>8</sub>   | 4 <sup>1</sup> / <sub>2</sub>   |
| 1 <sup>1</sup> / <sub>4</sub> | 7 <sup>7</sup> / <sub>16</sub> | 3 <sup>3</sup> / <sub>16</sub>  | 3 <sup>3</sup> / <sub>16</sub> | 1 <sup>3</sup> / <sub>4</sub>   | 5                               |
| 1 <sup>1</sup> / <sub>2</sub> | 8 <sup>3</sup> / <sub>16</sub> | 3 <sup>11</sup> / <sub>16</sub> | 3 <sup>9</sup> / <sub>16</sub> | 1 <sup>15</sup> / <sub>16</sub> | 5 <sup>7</sup> / <sub>16</sub>  |
| 2                             | 9 <sup>9</sup> / <sub>16</sub> | 4 <sup>1</sup> / <sub>4</sub>   | 4 <sup>1</sup> / <sub>8</sub>  | 2 <sup>7</sup> / <sub>16</sub>  | 6 <sup>3</sup> / <sub>8</sub>   |

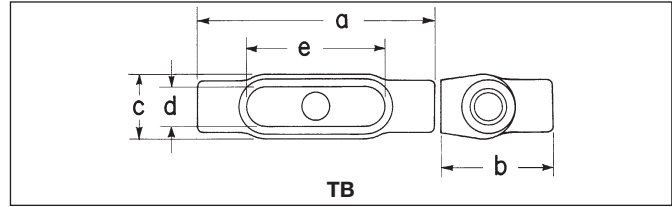

**Form 7TB**

| Size                          | a                              | b                              | c                              | d                               | e                               |
|-------------------------------|--------------------------------|--------------------------------|--------------------------------|---------------------------------|---------------------------------|
| 1/2                           | 5 <sup>5</sup> / <sub>8</sub>  | 2 <sup>5</sup> / <sub>8</sub>  | 1 <sup>9</sup> / <sub>16</sub> | 1 <sup>5</sup> / <sub>16</sub>  | 3 <sup>3</sup> / <sub>16</sub>  |
| 3/4                           | 6 <sup>1</sup> / <sub>4</sub>  | 2 <sup>7</sup> / <sub>8</sub>  | 1 <sup>3</sup> / <sub>4</sub>  | 1 <sup>1</sup> / <sub>8</sub>   | 3 <sup>13</sup> / <sub>16</sub> |
| 1                             | 7 <sup>1</sup> / <sub>4</sub>  | 3 <sup>1</sup> / <sub>4</sub>  | 2                              | 1 <sup>3</sup> / <sub>8</sub>   | 4 <sup>1</sup> / <sub>2</sub>   |
| 1 <sup>1</sup> / <sub>4</sub> | 7 <sup>7</sup> / <sub>16</sub> | 3 <sup>5</sup> / <sub>16</sub> | 2 <sup>3</sup> / <sub>16</sub> | 1 <sup>3</sup> / <sub>4</sub>   | 5                               |
| 1 <sup>1</sup> / <sub>2</sub> | 8 <sup>3</sup> / <sub>16</sub> | 5                              | 2 <sup>7</sup> / <sub>16</sub> | 1 <sup>15</sup> / <sub>16</sub> | 5 <sup>7</sup> / <sub>16</sub>  |
| 2                             | 9 <sup>9</sup> / <sub>16</sub> | 6 <sup>1</sup> / <sub>8</sub>  | 3                              | 2 <sup>7</sup> / <sub>16</sub>  | 6 <sup>3</sup> / <sub>8</sub>   |

**Form 8TB**

| Size                          | a                               | b                               | c                              | d                              | e                               |
|-------------------------------|---------------------------------|---------------------------------|--------------------------------|--------------------------------|---------------------------------|
| 1/2                           | 5 <sup>11</sup> / <sub>16</sub> | 2 <sup>17</sup> / <sub>32</sub> | 1 <sup>3</sup> / <sub>8</sub>  | 1                              | 3 <sup>5</sup> / <sub>16</sub>  |
| 3/4                           | 6 <sup>9</sup> / <sub>32</sub>  | 2 <sup>3</sup> / <sub>4</sub>   | 1 <sup>9</sup> / <sub>16</sub> | 1 <sup>3</sup> / <sub>16</sub> | 3 <sup>15</sup> / <sub>16</sub> |
| 1                             | 7 <sup>5</sup> / <sub>16</sub>  | 3 <sup>1</sup> / <sub>8</sub>   | 1 <sup>3</sup> / <sub>4</sub>  | 1 <sup>3</sup> / <sub>8</sub>  | 4 <sup>9</sup> / <sub>16</sub>  |
| 1 <sup>1</sup> / <sub>4</sub> | 8 <sup>1</sup> / <sub>2</sub>   | 3 <sup>11</sup> / <sub>32</sub> | 2 <sup>3</sup> / <sub>16</sub> | 1 <sup>3</sup> / <sub>4</sub>  | 5 <sup>5</sup> / <sub>16</sub>  |
| 1 <sup>1</sup> / <sub>2</sub> | 10 <sup>3</sup> / <sub>8</sub>  | 4 <sup>1</sup> / <sub>32</sub>  | 2 <sup>3</sup> / <sub>4</sub>  | 2 <sup>1</sup> / <sub>8</sub>  | 6 <sup>1</sup> / <sub>2</sub>   |
| 2                             | 12 <sup>1</sup> / <sub>4</sub>  | 4 <sup>13</sup> / <sub>16</sub> | 3 <sup>3</sup> / <sub>4</sub>  | 3                              | 8 <sup>9</sup> / <sub>16</sub>  |

**Mark 9TB**

| Size                          | a                               | b                               | c                              | d                               | e                               |
|-------------------------------|---------------------------------|---------------------------------|--------------------------------|---------------------------------|---------------------------------|
| 1/2                           | 5 <sup>11</sup> / <sub>16</sub> | 2 <sup>33</sup> / <sub>64</sub> | 1 <sup>3</sup> / <sub>8</sub>  | 1                               | 3 <sup>5</sup> / <sub>16</sub>  |
| 3/4                           | 6 <sup>9</sup> / <sub>16</sub>  | 2 <sup>7</sup> / <sub>8</sub>   | 1 <sup>5</sup> / <sub>8</sub>  | 1 <sup>3</sup> / <sub>16</sub>  | 3 <sup>15</sup> / <sub>16</sub> |
| 1                             | 7 <sup>5</sup> / <sub>16</sub>  | 3 <sup>1</sup> / <sub>8</sub>   | 1 <sup>3</sup> / <sub>4</sub>  | 1 <sup>3</sup> / <sub>8</sub>   | 4 <sup>9</sup> / <sub>16</sub>  |
| 1 <sup>1</sup> / <sub>4</sub> | 8 <sup>1</sup> / <sub>2</sub>   | 3 <sup>11</sup> / <sub>32</sub> | 2 <sup>3</sup> / <sub>16</sub> | 1 <sup>3</sup> / <sub>4</sub>   | 5 <sup>5</sup> / <sub>16</sub>  |
| 1 <sup>1</sup> / <sub>2</sub> | 8 <sup>11</sup> / <sub>32</sub> | 3 <sup>7</sup> / <sub>8</sub>   | 2 <sup>1</sup> / <sub>2</sub>  | 2 <sup>3</sup> / <sub>16</sub>  | 5 <sup>7</sup> / <sub>8</sub>   |
| 2                             | 10 <sup>5</sup> / <sub>8</sub>  | 4 <sup>19</sup> / <sub>32</sub> | 3 <sup>3</sup> / <sub>32</sub> | 2 <sup>13</sup> / <sub>16</sub> | 8 <sup>3</sup> / <sub>32</sub>  |

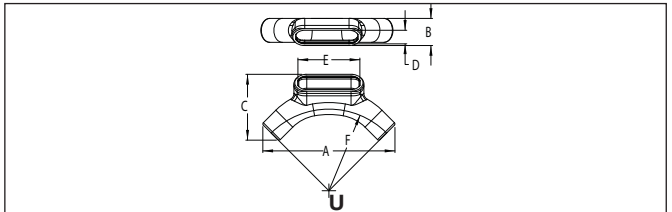

**Form 7U**

| Size                          | a                               | b                               | c                               | d                               | e                               | f                              |
|-------------------------------|---------------------------------|---------------------------------|---------------------------------|---------------------------------|---------------------------------|--------------------------------|
| 1/2                           | 7 <sup>1</sup> / <sub>8</sub>   | 1 <sup>1</sup> / <sub>2</sub>   | 3 <sup>11</sup> / <sub>16</sub> | 1 <sup>5</sup> / <sub>16</sub>  | 3 <sup>3</sup> / <sub>16</sub>  | 4 <sup>7</sup> / <sub>16</sub> |
| 3/4                           | 7 <sup>1</sup> / <sub>2</sub>   | 1 <sup>11</sup> / <sub>16</sub> | 3 <sup>7</sup> / <sub>8</sub>   | 1 <sup>1</sup> / <sub>8</sub>   | 3 <sup>13</sup> / <sub>16</sub> | 4 <sup>5</sup> / <sub>8</sub>  |
| 1                             | 9 <sup>11</sup> / <sub>16</sub> | 2                               | 4 <sup>13</sup> / <sub>16</sub> | 1 <sup>3</sup> / <sub>8</sub>   | 4 <sup>1</sup> / <sub>2</sub>   | 6                              |
| 1 <sup>1</sup> / <sub>4</sub> | 12                              | 2 <sup>1</sup> / <sub>2</sub>   | 5 <sup>15</sup> / <sub>16</sub> | 1 <sup>3</sup> / <sub>4</sub>   | 5                               | 7 <sup>7</sup> / <sub>16</sub> |
| 1 <sup>1</sup> / <sub>2</sub> | 15 <sup>1</sup> / <sub>8</sub>  | 2 <sup>7</sup> / <sub>8</sub>   | 7 <sup>3</sup> / <sub>16</sub>  | 1 <sup>15</sup> / <sub>16</sub> | 5 <sup>7</sup> / <sub>16</sub>  | 9 <sup>5</sup> / <sub>8</sub>  |
| 2                             | 17 <sup>5</sup> / <sub>16</sub> | 3 <sup>5</sup> / <sub>8</sub>   | 8 <sup>5</sup> / <sub>8</sub>   | 2 <sup>7</sup> / <sub>16</sub>  | 6 <sup>3</sup> / <sub>8</sub>   | 10 <sup>7</sup> / <sub>8</sub> |

# Condulet® Conduit Bodies - Cast Iron or Aluminum

1F

## Dimensions (In Inches)

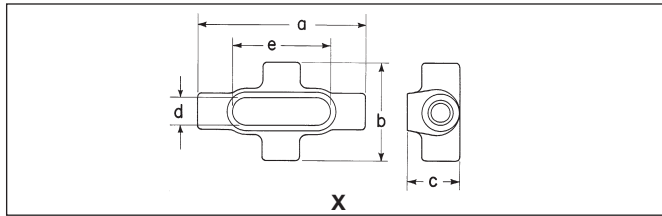

### Form 7X

| Size                          | a                              | b                              | c                              | d                               | e                               |
|-------------------------------|--------------------------------|--------------------------------|--------------------------------|---------------------------------|---------------------------------|
| 1/2                           | 5 <sup>5</sup> / <sub>8</sub>  | 3 <sup>5</sup> / <sub>16</sub> | 1 <sup>3</sup> / <sub>4</sub>  | 1 <sup>5</sup> / <sub>16</sub>  | 3 <sup>3</sup> / <sub>16</sub>  |
| 3/4                           | 6 <sup>1</sup> / <sub>4</sub>  | 3 <sup>1</sup> / <sub>2</sub>  | 2                              | 1 <sup>1</sup> / <sub>8</sub>   | 3 <sup>13</sup> / <sub>16</sub> |
| 1                             | 7 <sup>1</sup> / <sub>4</sub>  | 4                              | 2 <sup>1</sup> / <sub>4</sub>  | 1 <sup>3</sup> / <sub>8</sub>   | 4 <sup>1</sup> / <sub>2</sub>   |
| 1 <sup>1</sup> / <sub>4</sub> | 7 <sup>7</sup> / <sub>16</sub> | 4 <sup>1</sup> / <sub>8</sub>  | 2 <sup>5</sup> / <sub>16</sub> | 1 <sup>3</sup> / <sub>4</sub>   | 5                               |
| 1 <sup>1</sup> / <sub>2</sub> | 8 <sup>3</sup> / <sub>16</sub> | 4 <sup>5</sup> / <sub>8</sub>  | 2 <sup>9</sup> / <sub>16</sub> | 1 <sup>15</sup> / <sub>16</sub> | 5 <sup>7</sup> / <sub>16</sub>  |
| 2                             | 9 <sup>3</sup> / <sub>16</sub> | 5 <sup>3</sup> / <sub>16</sub> | 3 <sup>1</sup> / <sub>8</sub>  | 2 <sup>7</sup> / <sub>16</sub>  | 6 <sup>3</sup> / <sub>8</sub>   |

### Form 8X

|                               |                                 |                                 |                                 |                                |                                 |
|-------------------------------|---------------------------------|---------------------------------|---------------------------------|--------------------------------|---------------------------------|
| 1/2                           | 5 <sup>11</sup> / <sub>16</sub> | 2 <sup>29</sup> / <sub>32</sub> | 1 <sup>3</sup> / <sub>4</sub>   | 1                              | 3 <sup>5</sup> / <sub>16</sub>  |
| 3/4                           | 6 <sup>9</sup> / <sub>32</sub>  | 3 <sup>1</sup> / <sub>16</sub>  | 2                               | 1 <sup>3</sup> / <sub>16</sub> | 3 <sup>15</sup> / <sub>16</sub> |
| 1                             | 7 <sup>9</sup> / <sub>16</sub>  | 3 <sup>1</sup> / <sub>2</sub>   | 2 <sup>1</sup> / <sub>4</sub>   | 1 <sup>3</sup> / <sub>8</sub>  | 4 <sup>9</sup> / <sub>16</sub>  |
| 1 <sup>1</sup> / <sub>4</sub> | 8 <sup>1</sup> / <sub>2</sub>   | 4 <sup>1</sup> / <sub>8</sub>   | 2 <sup>5</sup> / <sub>8</sub>   | 1 <sup>3</sup> / <sub>4</sub>  | 5 <sup>5</sup> / <sub>16</sub>  |
| 1 <sup>1</sup> / <sub>2</sub> | 10 <sup>9</sup> / <sub>8</sub>  | 5 <sup>1</sup> / <sub>4</sub>   | 2 <sup>15</sup> / <sub>32</sub> | 2 <sup>1</sup> / <sub>8</sub>  | 6 <sup>1</sup> / <sub>2</sub>   |
| 2                             | 12 <sup>1</sup> / <sub>4</sub>  | 6 <sup>1</sup> / <sub>4</sub>   | 3 <sup>9</sup> / <sub>16</sub>  | 3                              | 8 <sup>9</sup> / <sub>16</sub>  |

### Mark 9X

|     |                                 |                                 |                               |                                |                                 |
|-----|---------------------------------|---------------------------------|-------------------------------|--------------------------------|---------------------------------|
| 1/2 | 5 <sup>11</sup> / <sub>16</sub> | 2 <sup>57</sup> / <sub>64</sub> | 1 <sup>3</sup> / <sub>4</sub> | 1                              | 3 <sup>5</sup> / <sub>16</sub>  |
| 3/4 | 6 <sup>9</sup> / <sub>16</sub>  | 3 <sup>3</sup> / <sub>4</sub>   | 2                             | 1 <sup>3</sup> / <sub>16</sub> | 3 <sup>15</sup> / <sub>16</sub> |
| 1   | 7 <sup>5</sup> / <sub>16</sub>  | 3 <sup>1</sup> / <sub>2</sub>   | 2 <sup>1</sup> / <sub>4</sub> | 1 <sup>3</sup> / <sub>8</sub>  | 4 <sup>9</sup> / <sub>16</sub>  |