

DESCRIPTION

Ideal for task, accent, office, cove, utility and display lighting, the Halo HU20 Undercabinet delivers a low-profile design with easy installation. Track mounted driver is equipped with sensitive touch Hi-Med-Low-Off switch. Track sections are available in 12", 18", or 24" lengths and can be field cut to fit almost anywhere. The connector cable makes it easy to link one unit to another and one driver can drive up to 7 pucks.

SPECIFICATION FEATURES

Flexible In Design

Patented magnetic connector technology provides for unmatched lighting effect flexibility before and after installation. Each luminaire is connected to the low voltage track system with magnetic contact that allows you to locate and relocate them anywhere along the track surface at any time. Adapt the lighting design to a change in environment or simply take advantage of easy installation.

Low Profile System

Low profile track system and luminaires have less than 3/4" overall height with the driver coming in under 1".

Pucks

Pucks are attached magnetically to the track. Each puck has a frosted lens and contains LEDs that provide a uniform source with high efficiency and no pixilation. Available in 90 CRI minimum, R9 greater than 50 and color accuracy within 3 SDCM provide color accuracy and uniformity.

Track

Each section of track features two magnetic contacts for the pucks, connector and driver to attach. There is no polarity to the track, so each component can be attached to the track regardless of orientation or direction. The track can be field cut to the desired length for maximum versatility.

Mounting

Each track section can be secured horizontally directly to the mounting surface with screws at the counter sunk screw locations. No separate mounting clip required.

Connector

Connect two lengths of track together with the 6" magnetic linking cord.

Life

Halo HU20 Undercabinet system is expected to yield 70% lumen maintenance after 50,000 hours of operation.

Adjustable Light Levels

Driver features a high-medium-low-off switch using sensitive touch adjustable light levels.

Catalog #		Type
Project		
Comments		Date
Prepared by		

Warranty

Five-year limited warranty, consult website for details.
www.eaton.com/lighting/Legal

Driver

The driver connects directly to the track and can be used with up to 7 pucks. Each driver is controlled using sensitive touch directly on the HALO logo. It provides flicker free operation and is for use only with 120V.

Compliance

ETL listed / certified EMI/RFI emissions per FCC 47CFR Part 18 consumer limits. Contains no mercury or lead and RoHS compliant. Photometric testing in accordance with IES LM-79-08. Lumen maintenance projections in accordance with IES LM-80-08 and TM-21-11. ENERGY STAR® listed, reference database for current listings.

Operating Conditions

Damp location listed and for indoor use only.



HU20

LED Magnetic Undercabinet

90 CRI

ORDERING INFORMATION / DIMENSIONS

Track

Sample Number: **HU20G212MB** (12" Track Matte Black)

System	Length	Finish
HU20G2= Halo LED Undercabinet	12= 12" 18= 18" 24= 24"	MB= Matte Black

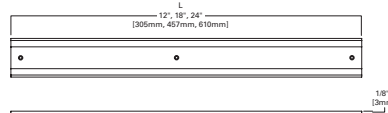

Puck*

Sample Number: **HU20G2P930MB** (Puck 3000K, 90CRI, Matte Black)

System	Form Factor	CRI	Color Temperature	Finish
HU20G2= Halo LED Undercabinet	P=Puck	9=90 CRI	30=3000K	MB= Matte Black

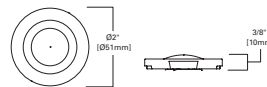

Driver*

Sample Number: **HU20G2D13MB** (13W driver, Matte Black)

System	Form Factor	Wattage	Finish
HU20G2= Halo LED Undercabinet	D=Corded	13=13 Watts	MB= Matte Black

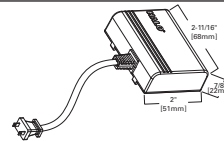

Connector

Sample Number: **HU20G22MB** (6" connector, Matte Black)

System	Length	Finish
HU20G2= Halo LED Undercabinet	2=6" connector	MB= Matte Black

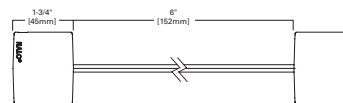

Note: *For references to certification bodies, "HU20G2" represents the system driver and "P930" represents the color & efficacy for the puck based system.

HU20 Kits

System
HU2012PS2P930MBR= 12" Kit with 2 Pucks, 90 CRI, 3000K, Matte Black
HU2018PS2P930MBR= 18" Kit with 3 Pucks, 90 CRI, 3000K, Matte Black
HU2024PS2P930MBR= 24" Kit with 4 Pucks, 90 CRI, 3000K, Matte Black



Qualified and compliant. Refer to ENERGY STAR® Qualified Products List for listings. Can be used to comply with California Title 24 High Efficacy requirements.

2 pucks: 340 lm, Efficacy 72.3 lm/W

3 pucks: 504 lm, Efficacy 72.1 lm/W

4 pucks: 660 lm, Efficacy 71.4 lm/W

ENERGY DATA

	2 Pucks	3 Pucks	4 Pucks
Lumens (lm)	339.6 lm	503.7 lm	659.9 lm
Input Voltage (V)	120V	120V	120V
Input Power (W)	4.7 W	6.98 W	9.24 W
Efficiency (lm/W)	72.3 lm/W	72.1 lm/W	71.4 lm/W
Input Current (A)	0.0476 A	0.0687 A	0.0899 A
THD (THDi)	58.2	57.1	56
Power Factor (Pf)	0.82	0.85	0.88
T Ambient	-40°C to 85°C	-40°C to 85°C	-40°C to 85°C
Sound Rating	<22dB	<22dB	<22dB

PHOTOMETRY

Mounting Height 18"

Top Number: HU2012PS2P930MBR
 Middle Number: HU2018PS2P930MBR
 Bottom Number: HU2024PS2P930MBR

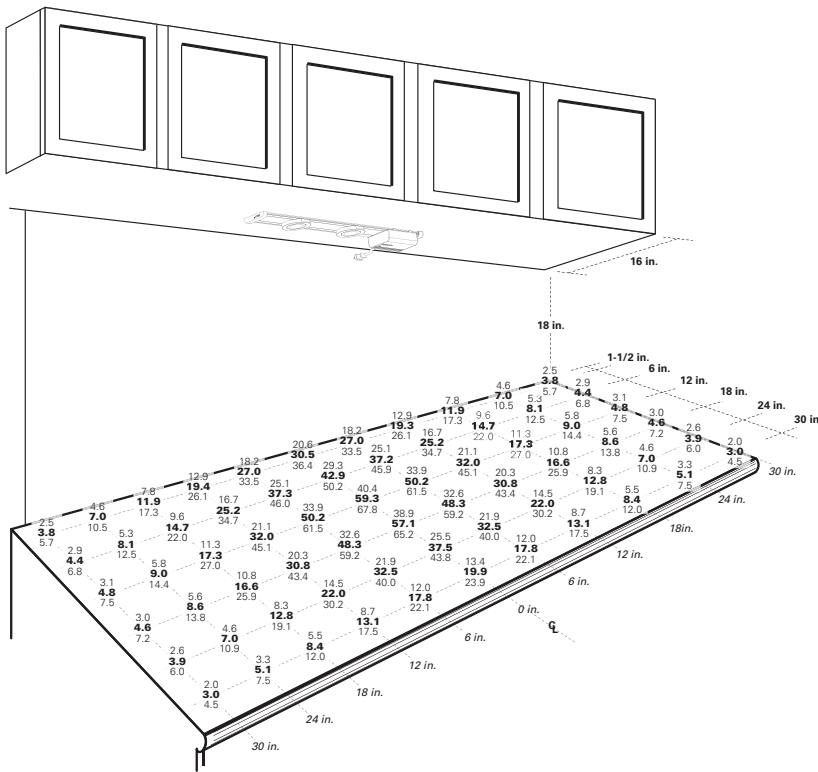

# of Pucks	System Lumens	Wattage	Power Factor	Amps	Efficacy	Lumens / Luminaire
1	155	2.2	0.81	0.02	72	155
2	340	4.7	0.82	0.04	73	170
3	503	7.0	0.85	0.06	72	168
4	660	9.2	0.88	0.08	72	165
5	805	11.0	0.90	0.09	73	161
6	970	13.2	0.90	0.11	73	162
7	1,114	14.7	0.90	0.12	76	159

Mounting Height 15"

Top Number: HU2012PS2P930MBR
 Middle Number: HU2018PS2P930MBR
 Bottom Number: HU2024PS2P930MBR

2.1	4.0	7.2	12.7	19.1	22.3	19.1	12.7	7.2	4.0	2.1	1-1/2"
3.9	6.1	11.1	19.2	28.4	32.7	28.4	19.2	11.1	6.1	3.9	
4.2	9.5	16.6	26.5	35.0	38.3	35.0	26.5	16.6	9.5	4.2	6"
2.4	4.6	9.1	17.4	28.7	34.6	28.7	17.4	9.1	4.6	2.4	
3.7	7.2	14.0	26.5	42.5	50.5	42.5	26.5	14.0	7.2	3.7	12"
5.8	11.5	22.1	37.8	52.0	57.3	52.0	37.8	22.1	11.5	5.8	
2.6	5.2	11.0	23.7	43.9	55.5	43.9	23.7	11.0	5.2	2.6	18"
4.0	8.1	17.2	36.5	64.9	80.3	64.9	36.5	17.2	8.1	4.0	
6.5	13.6	28.9	54.9	79.1	87.8	79.1	54.9	28.9	13.6	6.5	24"
2.5	4.9	10.5	22.6	42.0	53.1	42.0	22.6	10.5	4.9	2.5	
3.8	7.6	16.3	34.9	62.2	76.8	62.2	34.9	16.3	7.6	3.8	30"
6.2	12.9	27.6	52.5	75.7	84.0	75.7	52.5	27.6	12.9	6.2	
2.1	3.9	7.7	14.9	24.7	29.8	24.7	14.9	7.7	3.9	2.1	36"
3.0	6.0	11.9	22.7	36.6	43.5	36.6	22.7	11.9	6.0	3.0	
5.0	9.8	18.8	32.4	44.7	49.3	44.7	32.4	18.8	9.8	5.0	42"
1.6	2.7	4.8	8.0	11.7	13.4	11.7	8.0	4.8	2.7	1.6	
2.4	4.2	7.3	12.1	17.3	19.7	17.3	12.1	7.3	4.2	2.4	48"
3.6	6.3	10.7	16.4	21.4	23.3	21.4	16.4	10.7	6.3	3.6	
30"	24"	18"	12"	6"	0	6"	12"	18"	24"	30"	

Mounting Height 24"

Top Number: HU2012PS2P930MBR
 Middle Number: HU2018PS2P930MBR
 Bottom Number: HU2024PS2P930MBR

3.0	5.0	7.8	11.3	14.6	16.0	14.6	11.3	7.8	5.0	3.0	1-1/2"
4.6	7.6	11.8	17.0	21.7	23.7	21.7	17.0	11.8	7.6	4.6	
6.7	11.0	16.3	22.4	27.4	29.2	27.4	22.4	16.3	11.0	6.7	6"
3.4	5.7	9.0	13.5	18.0	19.8	18.0	13.5	9.0	5.7	3.4	
5.2	8.6	13.6	20.3	26.6	29.3	26.6	20.3	13.6	8.6	5.2	12"
7.6	12.4	19.2	26.9	33.4	35.8	33.4	26.9	19.2	12.4	7.6	
3.7	6.2	10.1	15.7	21.3	23.8	21.3	15.7	10.1	6.2	3.7	18"
5.6	9.4	15.4	23.6	31.7	35.2	31.7	23.6	15.4	9.4	5.6	
8.3	13.8	21.9	31.5	39.5	42.6	39.5	31.5	21.9	13.8	8.3	24"
3.6	6.0	9.9	15.3	20.7	23.1	20.7	15.3	9.9	6.0	3.6	
5.5	9.1	15.0	23.0	30.8	34.2	30.8	23.0	15.0	9.1	5.5	30"
8.2	13.5	21.3	30.6	38.4	41.4	38.4	30.6	21.3	13.5	8.2	
3.2	5.2	6.2	12.3	16.2	17.9	16.2	12.3	6.2	5.2	3.2	36"
4.9	7.9	12.4	18.4	24.1	26.5	24.1	18.4	12.4	7.9	4.9	
7.1	11.4	17.4	24.4	30.2	32.4	30.2	24.4	17.4	11.4	7.1	42"
2.6	4.0	6.0	8.5	10.8	11.7	10.8	8.5	6.0	4.0	2.6	
3.9	6.1	9.1	12.8	16.0	17.4	16.0	12.8	9.1	6.1	3.9	48"
5.7	8.6	12.5	16.8	20.2	21.5	20.2	16.8	12.5	8.6	5.7	
30"	24"	18"	12"	6"	0	6"	12"	18"	24"	30"	

DESCRIPTION

Ideal for task, accent, office, cove, utility and display lighting, the Halo HU20 Undercabinet delivers a low-profile design with easy installation. Track mounted driver is equipped with sensitive touch Hi-Med-Low-Off switch. Track sections are available in 12", 18", or 24" lengths and can be field cut to fit almost anywhere. The connector cable makes it easy to link one unit to another and one driver can drive up to 7 pucks.

SPECIFICATION FEATURES

Flexible In Design

Patented magnetic connector technology provides for unmatched lighting effect flexibility before and after installation. Each luminaire is connected to the low voltage track system with magnetic contact that allows you to locate and relocate them anywhere along the track surface at any time. Adapt the lighting design to a change in environment or simply take advantage of easy installation.

Low Profile System

Low profile track system and luminaires have less than 3/4" overall height with the driver coming in under 1".

Pucks

Pucks are attached magnetically to the track. Each puck has a frosted lens and contains LEDs that provide a uniform source with high efficiency and no pixilation. Available in 90 CRI minimum, R9 greater than 50 and color accuracy within 3 SDCM provide color accuracy and uniformity.

Track

Each section of track features two magnetic contacts for the pucks, connector and driver to attach. There is no polarity to the track, so each component can be attached to the track regardless of orientation or direction. The track can be field cut to the desired length for maximum versatility.

Mounting

Each track section can be secured horizontally directly to the mounting surface with screws at the counter sunk screw locations. No separate mounting clip required.

Connector

Connect two lengths of track together with the 6" magnetic linking cord.

Life

Halo HU20 Undercabinet system is expected to yield 70% lumen maintenance after 50,000 hours of operation.

Adjustable Light Levels

Driver features a high-medium-low-off switch using sensitive touch adjustable light levels.

Catalog #		Type
Project		
Comments		Date
Prepared by		

Warranty

Five-year limited warranty, consult website for details.
www.eaton.com/lighting/Legal

Driver

The driver connects directly to the track and can be used with up to 7 pucks. Each driver is controlled using sensitive touch directly on the HALO logo. It provides flicker free operation and is for use only with 120V.

Compliance

ETL listed / certified EMI/RFI emissions per FCC 47CFR Part 18 consumer limits. Contains no mercury or lead and RoHS compliant. Photometric testing in accordance with IES LM-79-08. Lumen maintenance projections in accordance with IES LM-80-08 and TM-21-11. ENERGY STAR® listed, reference database for current listings.

Operating Conditions

Damp location listed and for indoor use only.



HU20

LED Magnetic Undercabinet

90 CRI

ORDERING INFORMATION / DIMENSIONS

Track

Sample Number: **HU20G212MB** (12" Track Matte Black)

System	Length	Finish
HU20G2= Halo LED Undercabinet	12= 12" 18= 18" 24= 24"	MB= Matte Black

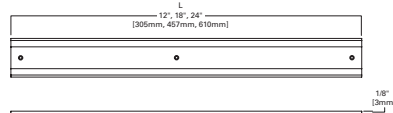

Puck*

Sample Number: **HU20G2P930MB** (Puck 3000K, 90CRI, Matte Black)

System	Form Factor	CRI	Color Temperature	Finish
HU20G2= Halo LED Undercabinet	P=Puck	9=90 CRI	30=3000K	MB= Matte Black

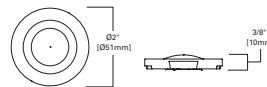

Driver*

Sample Number: **HU20G2D13MB** (13W driver, Matte Black)

System	Form Factor	Wattage	Finish
HU20G2= Halo LED Undercabinet	D=Corded	13=13 Watts	MB= Matte Black

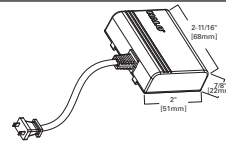

Connector

Sample Number: **HU20G22MB** (6" connector, Matte Black)

System	Length	Finish
HU20G2= Halo LED Undercabinet	2=6" connector	MB= Matte Black

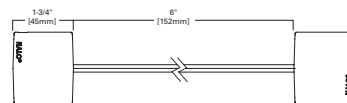

Note: *For references to certification bodies, "HU20G2" represents the system driver and "P930" represents the color & efficacy for the puck based system.

HU20 Kits

System
HU2012PS2P930MBR= 12" Kit with 2 Pucks, 90 CRI, 3000K, Matte Black
HU2018PS2P930MBR= 18" Kit with 3 Pucks, 90 CRI, 3000K, Matte Black
HU2024PS2P930MBR= 24" Kit with 4 Pucks, 90 CRI, 3000K, Matte Black



Qualified and compliant. Refer to ENERGY STAR® Qualified Products List for listings. Can be used to comply with California Title 24 High Efficacy requirements.

2 pucks: 340 lm, Efficacy 72.3 lm/W

3 pucks: 504 lm, Efficacy 72.1 lm/W

4 pucks: 660 lm, Efficacy 71.4 lm/W

ENERGY DATA

	2 Pucks	3 Pucks	4 Pucks
Lumens (lm)	339.6 lm	503.7 lm	659.9 lm
Input Voltage (V)	120V	120V	120V
Input Power (W)	4.7 W	6.98 W	9.24 W
Efficiency (lm/W)	72.3 lm/W	72.1 lm/W	71.4 lm/W
Input Current (A)	0.0476 A	0.0687 A	0.0899 A
THD (THDi)	58.2	57.1	56
Power Factor (Pf)	0.82	0.85	0.88
T Ambient	-40°C to 85°C	-40°C to 85°C	-40°C to 85°C
Sound Rating	<22dB	<22dB	<22dB

PHOTOMETRY

Mounting Height 18"

Top Number: HU2012PS2P930MBR
 Middle Number: HU2018PS2P930MBR
 Bottom Number: HU2024PS2P930MBR

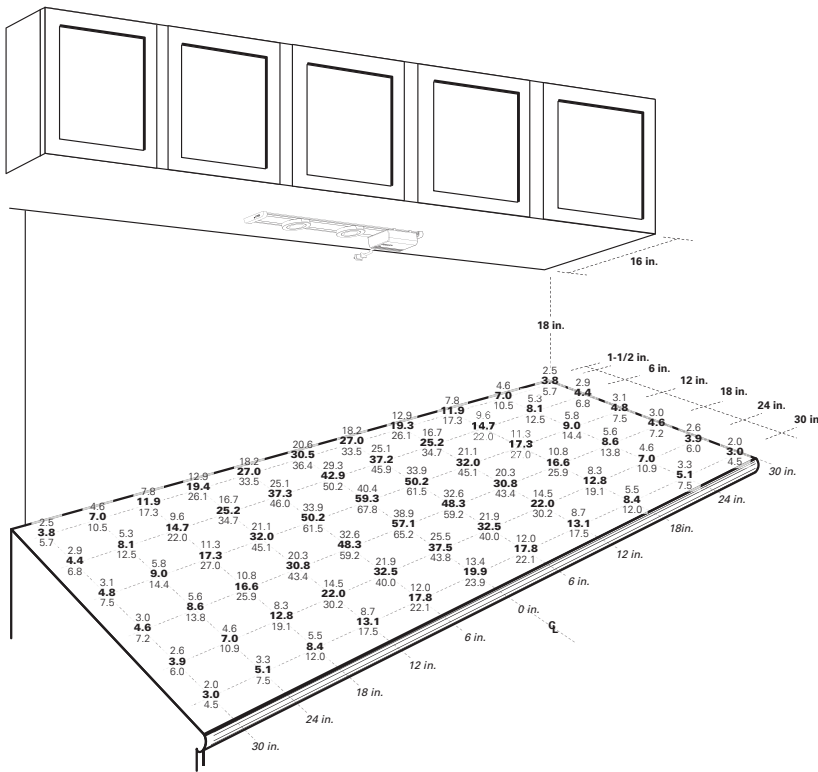

# of Pucks	System Lumens	Wattage	Power Factor	Amps	Efficacy	Lumens / Luminaire
1	155	2.2	0.81	0.02	72	155
2	340	4.7	0.82	0.04	73	170
3	503	7.0	0.85	0.06	72	168
4	660	9.2	0.88	0.08	72	165
5	805	11.0	0.90	0.09	73	161
6	970	13.2	0.90	0.11	73	162
7	1,114	14.7	0.90	0.12	76	159

Mounting Height 15"

Top Number: HU2012PS2P930MBR
 Middle Number: HU2018PS2P930MBR
 Bottom Number: HU2024PS2P930MBR

2.1	4.0	7.2	12.7	19.1	22.3	19.1	12.7	7.2	4.0	2.1	1-1/2"
3.2	6.1	11.1	19.2	28.4	32.7	28.4	19.2	11.1	6.1	3.2	
4.9	9.5	16.6	26.5	35.0	38.3	35.0	26.5	16.6	9.5	4.9	6"
2.4	4.6	9.1	17.4	28.7	34.6	28.7	17.4	9.1	4.6	2.4	
3.7	7.2	14.0	26.5	42.5	50.5	42.5	26.5	14.0	7.2	3.7	12"
5.8	11.5	22.1	37.8	52.0	57.3	52.0	37.8	22.1	11.5	5.8	
2.6	5.2	11.0	23.7	43.9	55.5	43.9	23.7	11.0	5.2	2.6	18"
4.0	8.1	17.2	36.5	64.9	80.3	64.9	36.5	17.2	8.1	4.0	
6.5	13.6	28.9	54.9	79.1	87.8	79.1	54.9	28.9	13.6	6.5	24"
2.5	4.9	10.5	22.6	42.0	53.1	42.0	22.6	10.5	4.9	2.5	
3.8	7.6	16.3	34.9	62.2	76.8	62.2	34.9	16.3	7.6	3.8	30"
6.2	12.9	27.6	52.5	75.7	84.0	75.7	52.5	27.6	12.9	6.2	
2.1	3.9	7.7	14.9	24.7	29.8	24.7	14.9	7.7	3.9	2.1	36"
3.0	6.0	11.9	22.7	36.6	43.5	36.6	22.7	11.9	6.0	3.0	
5.0	9.8	18.8	32.4	44.7	49.3	44.7	32.4	18.8	9.8	5.0	42"
1.6	2.7	4.8	8.0	11.7	13.4	11.7	8.0	4.8	2.7	1.6	
2.4	4.2	7.3	12.1	17.3	19.7	17.3	12.1	7.3	4.2	2.4	48"
3.6	6.3	10.7	16.4	21.4	23.3	21.4	16.4	10.7	6.3	3.6	
30"	24"	18"	12"	6"	0	6"	12"	18"	24"	30"	

Mounting Height 24"

Top Number: HU2012PS2P930MBR
 Middle Number: HU2018PS2P930MBR
 Bottom Number: HU2024PS2P930MBR

3.0	5.0	7.8	11.3	14.6	16.0	14.6	11.3	7.8	5.0	3.0	1-1/2"
4.6	7.6	11.8	17.0	21.7	23.7	21.7	17.0	11.8	7.6	4.6	
6.7	11.0	16.3	22.4	27.4	29.2	27.4	22.4	16.3	11.0	6.7	6"
3.4	5.7	9.0	13.5	18.0	19.8	18.0	13.5	9.0	5.7	3.4	
5.2	8.6	13.6	20.3	26.6	29.3	26.6	20.3	13.6	8.6	5.2	12"
7.6	12.4	19.2	26.9	33.4	35.8	33.4	26.9	19.2	12.4	7.6	
3.7	6.2	10.1	15.7	21.3	23.8	21.3	15.7	10.1	6.2	3.7	18"
5.6	9.4	15.4	23.6	31.7	35.2	31.7	23.6	15.4	9.4	5.6	
8.3	13.8	21.9	31.5	39.5	42.6	39.5	31.5	21.9	13.8	8.3	24"
3.6	6.0	9.9	15.3	20.7	23.1	20.7	15.3	9.9	6.0	3.6	
5.5	9.1	15.0	23.0	30.8	34.2	30.8	23.0	15.0	9.1	5.5	30"
8.2	13.5	21.3	30.6	38.4	41.4	38.4	30.6	21.3	13.5	8.2	
3.2	5.2	6.2	12.3	16.2	17.9	16.2	12.3	6.2	5.2	3.2	36"
4.9	7.9	12.4	18.4	24.1	26.5	24.1	18.4	12.4	7.9	4.9	
7.1	11.4	17.4	24.4	30.2	32.4	30.2	24.4	17.4	11.4	7.1	42"
2.6	4.0	6.0	8.5	10.8	11.7	10.8	8.5	6.0	4.0	2.6	
3.9	6.1	9.1	12.8	16.0	17.4	16.0	12.8	9.1	6.1	3.9	48"
5.7	8.6	12.5	16.8	20.2	21.5	20.2	16.8	12.5	8.6	5.7	
30"	24"	18"	12"	6"	0	6"	12"	18"	24"	30"	