

Twist-Lock® Devices  
 30A, 3 Phase 250V AC, 3 Pole, 4 Wire  
 Grounding  
 Insulgrip® Plug

# HUBBELL

## Features

- Superior cord grip design protects terminations from excess strain.
- Clear, funnel shaped wire entry for ease of termination.
- Integral dust shield protects wiring chamber from dust or contaminants.

## Ordering Information

Description	Cord Diameter	UPC	Catalog Number
Black and white nylon.	.350"-1.150" (9-29)	783585039220	HBL2721

## Listings

Listed to UL 498  
 Fed.Spec. W-C-596  
 Certified to CSA C22.2 No.42

## Specifications

Housing / Cord Clamp	Nylon
Terminal Retainer	Clear polycarbonate
Blades	Brass
Terminal Screws	#10-32 Brass (Phillips / Slotted / Robertson)
Terminal Clamp	Cold rolled steel – nickel plated
Assembly Screws	Steel - nickel plated

## Performance

### Electrical

Current Interrupting	Certified for current interrupting at full rated current
Dielectric Voltage	Withstands 2,000V minimum

### Mechanical

Terminal Accommodation	#16 AWG - #8 AWG stranded copper wire only.
------------------------	---

Terminal Identification	Terminals identified in accordance with UL 498
-------------------------	--

### Environmental

Flammability	HB or better per UL94/CSA 22.2 No.0.17
Moisture Resistance	IP20 Suitability
Operating Temperatures	Maximum Continuous 75°C; Minimum -40°C (w/o impact)



30A 3Ø 250V AC  
 NEMA L15-30P  
 UL/CSA  
 3 HP

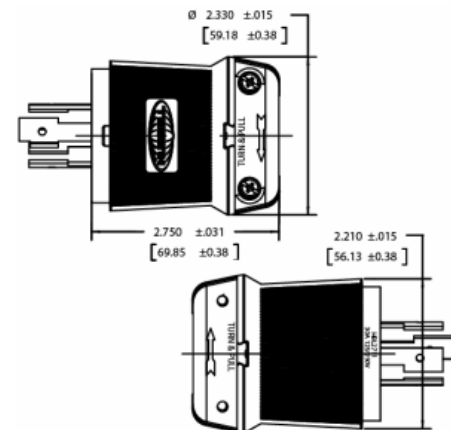

## Accessories

Connector	HBL2723
Single Receptacle	HBL2720
Flanged Receptacle	HBL2726
Weatherproof Boot	HBL6035

## Resources

Customer Use Drawing  
 eCatalog

Dimensions in Inches (mm)

Hubbell Wiring Device-Kellems • Hubbell Incorporated (Delaware) • 40 Waterview Drive • Shelton, CT 06484

Phone (800) 288-6000 • Fax (800) 255-1031 • Specifications subject to change without notice.



Twist-Lock® Devices  
 30A, 3 Phase 250V AC, 3 Pole, 4 Wire  
 Grounding  
 Insulgrip® Plug

# HUBBELL

## Features

- Superior cord grip design protects terminations from excess strain.
- Clear, funnel shaped wire entry for ease of termination.
- Integral dust shield protects wiring chamber from dust or contaminants.

## Ordering Information

Description	Cord Diameter	UPC	Catalog Number
Black and white nylon.	.350"-1.150" (9-29)	783585039220	HBL2721

## Listings

Listed to UL 498  
 Fed.Spec. W-C-596  
 Certified to CSA C22.2 No.42

## Specifications

Housing / Cord Clamp	Nylon
Terminal Retainer	Clear polycarbonate
Blades	Brass
Terminal Screws	#10-32 Brass (Phillips / Slotted / Robertson)
Terminal Clamp	Cold rolled steel – nickel plated
Assembly Screws	Steel - nickel plated

## Performance

### Electrical

Current Interrupting	Certified for current interrupting at full rated current
Dielectric Voltage	Withstands 2,000V minimum

### Mechanical

Terminal Accommodation	#16 AWG - #8 AWG stranded copper wire only.
------------------------	---

Terminal Identification	Terminals identified in accordance with UL 498
-------------------------	--

### Environmental

Flammability	HB or better per UL94/CSA 22.2 No.0.17
Moisture Resistance	IP20 Suitability
Operating Temperatures	Maximum Continuous 75°C; Minimum -40°C (w/o impact)



30A 3Ø 250V AC  
 NEMA L15-30P  
 UL/CSA  
 3 HP

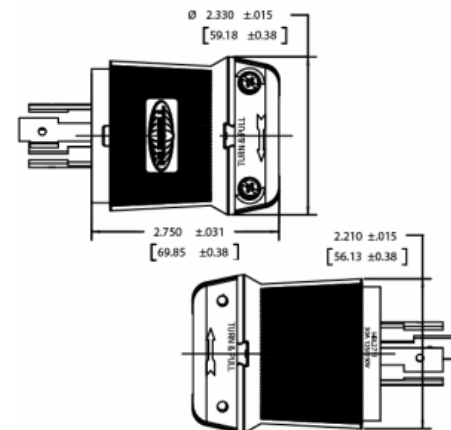

## Accessories

Connector	HBL2723
Single Receptacle	HBL2720
Flanged Receptacle	HBL2726
Weatherproof Boot	HBL6035

## Resources

Customer Use Drawing  
 eCatalog

Dimensions in Inches (mm)

Hubbell Wiring Device-Kellems • Hubbell Incorporated (Delaware) • 40 Waterview Drive • Shelton, CT 06484

Phone (800) 288-6000 • Fax (800) 255-1031 • Specifications subject to change without notice.

