



HBL-20

LED Linear Low Bay / High Bay

The HBL LED Linear Low Bay/High Bay provides lumen packages that are ideal for replacing metal halide and linear fluorescent systems. With output greater than 135 lumens per watt, this energy-efficient and economical fixture offers high performance, long life, excellent color rendering, and even uniformity. The HBL is available in 4000K and 5000K color temperatures and has suggested mounting heights from 15ft to 80ft, making it an ideal solution for warehouses, gymnasiums, garages and other storage areas, commercial and manufacturing facilities, as well as open and stack aisle applications.

Construction: Post-painted, heavy gauge steel

Optical: Clear acrylic lens protects LEDs and provides optimal lumen output

CCT: 4000K or 5000K

Input Voltage: 120-277V, 347-480V

Surge Protection: Additional 10kA surge protection standard

Dimmable: Provides 0-10V standard dimming

Operating temperature: 0° to 104°F (-18°C to 40°C)

Installation: V-hook and chain mounting system included with optional pendant mount kit available

Finish: White powder coat finish

FCC: Meets FCC Part 15, Subpart B, Class A standards for conducted and radiated emissions

Emergency: Optional emergency battery backup kit available



Photometric Data

HBL-20 110W 5000K

Input Voltage (VAC)	120-277
System Level Power (W)	110
Delivered Lumens (Lm)	14850
System Efficacy (Lm/W)	135
Correlated Color Temp (K)	5237
Color Rendering Index (CRI)	83
Total Harmonic Distortion	10%
Power Factor	>0.90
Beam Angle	112°
Spacing Criteria	1.30

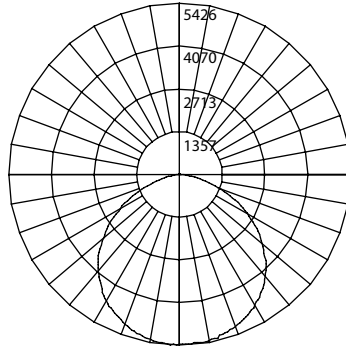

Intensity Summary (Candle Power)

Angle	Mean CP
0	5426
5	5408
15	5264
25	4949
35	4491
45	3781
55	2857
65	1699
75	624
85	52
90	10

CCT Data Multiplier

HBL-20-110W-UNV-40K	0.993
---------------------	-------

Diffuser Multiplier

HBL-20-110-FROS-DIFU	0.97
----------------------	------

Cone of Light Tabulation

Mounted height (Feet)	Footcandles Beam Center	Diameter (Feet)
15	23.95	44.48
17	18.65	50.41
20	13.47	59.30
23	10.19	68.20
25	8.62	74.13
28	6.87	83.02
30	5.98	88.95

Zonal Lumen Summary

Zone	Lumens	% of Luminaire
0-30	4250	28.6%
0-40	7033	47.4%
0-60	12421	83.6%
0-90	14798	99.7%
90-180	51	0.3%
0-180	14850	100%

HBL-20 162W 5000K

Input Voltage (VAC)	120-277
System Level Power (W)	162
Delivered Lumens (Lm)	21870
System Efficacy (Lm/W)	135
Correlated Color Temp (K)	5159
Color Rendering Index (CRI)	83
Total Harmonic Distortion	10%
Power Factor	>0.90
Beam Angle	113°
Spacing Criteria	1.30

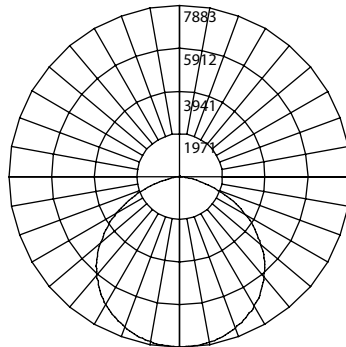

Intensity Summary (Candle Power)

Angle	Mean CP
0	7883
5	7865
15	7645
25	7187
35	6515
45	5515
55	4169
65	2554
75	971
85	65
90	11

CCT Data Multiplier

HBL-20-162W-UNV-40K	0.993
---------------------	-------

Diffuser Multiplier

HBL-20-162-FROS-DIFU	0.97
----------------------	------

Cone of Light Tabulation

Mounted height (Feet)	Footcandles Beam Center	Diameter (Feet)
15	34.92	44.48
17	27.19	50.41
20	19.65	59.30
23	14.85	68.20
25	12.57	74.13
28	10.02	83.02
30	8.73	88.95

Zonal Lumen Summary

Zone	Lumens	% of Luminaire
0-30	6198	28.3%
0-40	10257	46.9%
0-60	18173	83.1%
0-90	21807	99.7%
90-180	63	0.3%
0-180	21870	100.0%

HBL-20 223W 5000K

Input Voltage (VAC)	120-277
System Level Power (W)	223
Delivered Lumens (Lm)	30105
System Efficacy (Lm/W)	135
Correlated Color Temp (K)	5220
Color Rendering Index (CRI)	83
Total Harmonic Distortion	10%
Power Factor	>0.90
Beam Angle	111°
Spacing Criteria	1.30

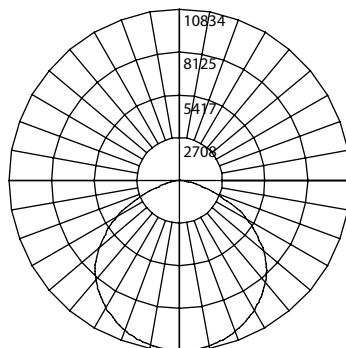

Intensity Summary (Candle Power)

Angle	Mean CP
0	10834
5	10794
15	10491
25	9871
35	8973
45	7609
55	5808
65	3497
75	1322
85	108
90	16

CCT Data Multiplier

HBL-20-223W-UNV-40K	0.993
---------------------	-------

Diffuser Multiplier

HBL-20-223-FROS-DIFU	0.97
----------------------	------

Cone of Light Tabulation

Mounted height (Feet)	Footcandles Beam Center	Diameter (Feet)
15	48.07	44.48
17	37.43	50.41
20	27.04	59.30
23	20.45	68.20
25	17.31	74.13
28	13.80	83.02
30	12.02	88.95

Zonal Lumen Summary

Zone	Lumens	% of Luminaire
0-30	8523	28.3%
0-40	14114	46.9%
0-60	25085	83.3%
0-90	30024	99.7%
90-180	82	0.3%
0-180	30105	100.0%

HBL | LED Linear Low Bay / High Bay

Wireguard Accessories*

Wireguard for 110W HBL	HBL-10-100-WG
Wireguard for 162W HBL	HBL-10-150-WG
Wireguard for 223W HBL	HBL-10-200-WG
Wireguard for 321W HBL	HBL-10-320-WG

Lens Accessories

HBL 110W Frosted Diffuser	HBL-20-110-FROS-DIFU
HBL 162W Frosted Diffuser	HBL-20-162-FROS-DIFU
HBL 223W Frosted Diffuser	HBL-20-223-FROS-DIFU
HBL 321W Frosted Diffuser	HBL-20-321-FROS-DIFU

Pendant Kit*

Pendant Kit for HBL	HBL-10-PENDANT
Pendant for High Voltage Option	HBL-10-HV-PENDANT

Motion Sensors

Microwave Motion Sensor	MWOS360
Infrared Motion Sensor	HBOS360WH
Microwave Sensor Remote	MWOS360R
Handheld Remote Control	MWOS-REMOTE

*HBL-20 is a version upgrade and accessories will use the current part number for ease of transition

Dimensions

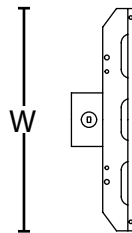
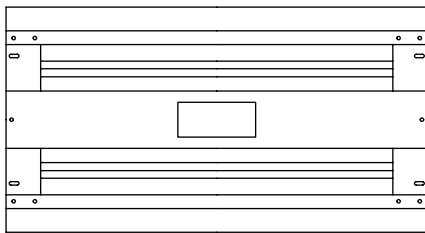
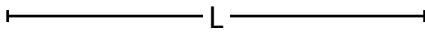
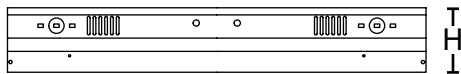

	HBL-110W 50K	HBL-162W 50K	HBL-223W 50K	HBL-321W 50K
Length:	23.8 in. (605mm)	23.8 in. (605mm)	46 in. (1166mm)	46 in. (1166mm)
Width:	12.6 in. (320mm)	17.3 in. (440mm)	12.6 in. (320mm)	17.3 in. (440mm)
Height:	3.6 in. (92mm)	3.6 in. (92mm)	3.6 in. (92mm)	3.6 in. (92mm)

NICOR[®] HAZOC

LEARN MORE
nicorhazloc.com



HBL-20

LED Linear Low Bay / High Bay

The HBL LED Linear Low Bay/High Bay provides lumen packages that are ideal for replacing metal halide and linear fluorescent systems. With output greater than 135 lumens per watt, this energy-efficient and economical fixture offers high performance, long life, excellent color rendering, and even uniformity. The HBL is available in 4000K and 5000K color temperatures and has suggested mounting heights from 15ft to 80ft, making it an ideal solution for warehouses, gymnasiums, garages and other storage areas, commercial and manufacturing facilities, as well as open and stack aisle applications.

Construction: Post-painted, heavy gauge steel

Optical: Clear acrylic lens protects LEDs and provides optimal lumen output

CCT: 4000K or 5000K

Input Voltage: 120-277V, 347-480V

Surge Protection: Additional 10kA surge protection standard

Dimmable: Provides 0-10V standard dimming

Operating temperature: 0° to 104°F (-18°C to 40°C)

Installation: V-hook and chain mounting system included with optional pendant mount kit available

Finish: White powder coat finish

FCC: Meets FCC Part 15, Subpart B, Class A standards for conducted and radiated emissions

Emergency: Optional emergency battery backup kit available



Photometric Data

HBL-20 110W 5000K

Input Voltage (VAC)	120-277
System Level Power (W)	110
Delivered Lumens (Lm)	14850
System Efficacy (Lm/W)	135
Correlated Color Temp (K)	5237
Color Rendering Index (CRI)	83
Total Harmonic Distortion	10%
Power Factor	>0.90
Beam Angle	112°
Spacing Criteria	1.30

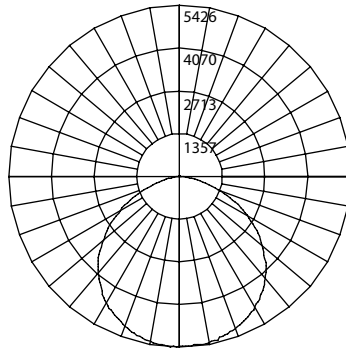

Intensity Summary (Candle Power)

Angle	Mean CP
0	5426
5	5408
15	5264
25	4949
35	4491
45	3781
55	2857
65	1699
75	624
85	52
90	10

CCT Data Multiplier

HBL-20-110W-UNV-40K	0.993
---------------------	-------

Diffuser Multiplier

HBL-20-110-FROS-DIFU	0.97
----------------------	------

Cone of Light Tabulation

Mounted height (Feet)	Footcandles Beam Center	Diameter (Feet)
15	23.95	44.48
17	18.65	50.41
20	13.47	59.30
23	10.19	68.20
25	8.62	74.13
28	6.87	83.02
30	5.98	88.95

Zonal Lumen Summary

Zone	Lumens	% of Luminaire
0-30	4250	28.6%
0-40	7033	47.4%
0-60	12421	83.6%
0-90	14798	99.7%
90-180	51	0.3%
0-180	14850	100%

HBL-20 162W 5000K

Input Voltage (VAC)	120-277
System Level Power (W)	162
Delivered Lumens (Lm)	21870
System Efficacy (Lm/W)	135
Correlated Color Temp (K)	5159
Color Rendering Index (CRI)	83
Total Harmonic Distortion	10%
Power Factor	>0.90
Beam Angle	113°
Spacing Criteria	1.30

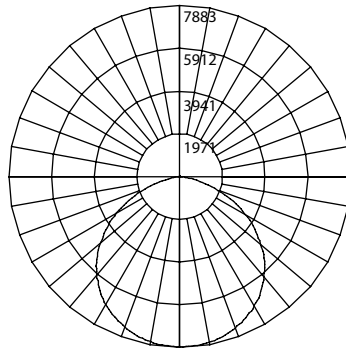

Intensity Summary (Candle Power)

Angle	Mean CP
0	7883
5	7865
15	7645
25	7187
35	6515
45	5515
55	4169
65	2554
75	971
85	65
90	11

CCT Data Multiplier

HBL-20-162W-UNV-40K	0.993
---------------------	-------

Diffuser Multiplier

HBL-20-162-FROS-DIFU	0.97
----------------------	------

Cone of Light Tabulation

Mounted height (Feet)	Footcandles Beam Center	Diameter (Feet)
15	34.92	44.48
17	27.19	50.41
20	19.65	59.30
23	14.85	68.20
25	12.57	74.13
28	10.02	83.02
30	8.73	88.95

Zonal Lumen Summary

Zone	Lumens	% of Luminaire
0-30	6198	28.3%
0-40	10257	46.9%
0-60	18173	83.1%
0-90	21807	99.7%
90-180	63	0.3%
0-180	21870	100.0%

HBL-20 223W 5000K

Input Voltage (VAC)	120-277
System Level Power (W)	223
Delivered Lumens (Lm)	30105
System Efficacy (Lm/W)	135
Correlated Color Temp (K)	5220
Color Rendering Index (CRI)	83
Total Harmonic Distortion	10%
Power Factor	>0.90
Beam Angle	111°
Spacing Criteria	1.30

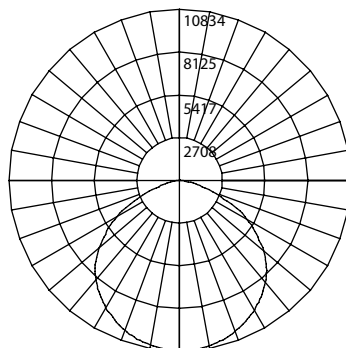

Intensity Summary (Candle Power)

Angle	Mean CP
0	10834
5	10794
15	10491
25	9871
35	8973
45	7609
55	5808
65	3497
75	1322
85	108
90	16

CCT Data Multiplier

HBL-20-223W-UNV-40K	0.993
---------------------	-------

Diffuser Multiplier

HBL-20-223-FROS-DIFU	0.97
----------------------	------

Cone of Light Tabulation

Mounted height (Feet)	Footcandles Beam Center	Diameter (Feet)
15	48.07	44.48
17	37.43	50.41
20	27.04	59.30
23	20.45	68.20
25	17.31	74.13
28	13.80	83.02
30	12.02	88.95

Zonal Lumen Summary

Zone	Lumens	% of Luminaire
0-30	8523	28.3%
0-40	14114	46.9%
0-60	25085	83.3%
0-90	30024	99.7%
90-180	82	0.3%
0-180	30105	100.0%

HBL | LED Linear Low Bay / High Bay

Wireguard Accessories*

Wireguard for 110W HBL	HBL-10-100-WG
Wireguard for 162W HBL	HBL-10-150-WG
Wireguard for 223W HBL	HBL-10-200-WG
Wireguard for 321W HBL	HBL-10-320-WG

Lens Accessories

HBL 110W Frosted Diffuser	HBL-20-110-FROS-DIFU
HBL 162W Frosted Diffuser	HBL-20-162-FROS-DIFU
HBL 223W Frosted Diffuser	HBL-20-223-FROS-DIFU
HBL 321W Frosted Diffuser	HBL-20-321-FROS-DIFU

Pendant Kit*

Pendant Kit for HBL	HBL-10-PENDANT
Pendant for High Voltage Option	HBL-10-HV-PENDANT

Motion Sensors

Microwave Motion Sensor	MWOS360
Infrared Motion Sensor	HBOS360WH
Microwave Sensor Remote	MWOS360R
Handheld Remote Control	MWOS-REMOTE

*HBL-20 is a version upgrade and accessories will use the current part number for ease of transition

Dimensions

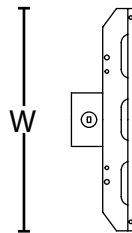
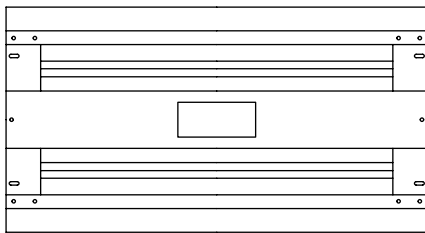
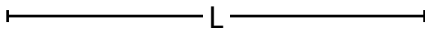
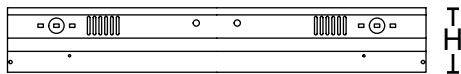

	HBL-110W 50K	HBL-162W 50K	HBL-223W 50K	HBL-321W 50K
Length:	23.8 in. (605mm)	23.8 in. (605mm)	46 in. (1166mm)	46 in. (1166mm)
Width:	12.6 in. (320mm)	17.3 in. (440mm)	12.6 in. (320mm)	17.3 in. (440mm)
Height:	3.6 in. (92mm)	3.6 in. (92mm)	3.6 in. (92mm)	3.6 in. (92mm)

NICOR[®] HAZOC

LEARN MORE
nicorhazloc.com