

# Class H(K) and R Fuse Blocks – 250V

## H250 & R250 Series

**Specifications**

**Descriptions:**

**H250 Series:** 1-, 2- and 3-pole fuse blocks for use with Class H fuses.

**R250 Series:** 1-, 2- and 3-pole fuse blocks for use with Class R fuses (Bussmann LPN-RK and FRN-R and KTN-R fuses).

**Dimensions:** See Dimensions illustrations.

**Ratings:**

Volts: — 250Vac/dc (H250 & R250 Series)

Amps: — 1/10-100A

SCCR: — H250 Series; 10kA RMS Sym.

— R250 Series; 200kA RMS Sym.



**Agency Information:** CE, UL Listed UL 4248, Guide IZLT, File E14853; CSA Certified, Class 6225-01, File 47235.

**Flammability Rating:** UL 94V0.

**Features and Benefits**

- H250 fuse blocks provide one, two and three pole housing for Class H, K and R fuses at 250Vac.
- H250 fuse blocks are listed with a Short-Circuit Current Rating of 10kA RMS Sym.
- R250 fuse blocks provide 1-, 2- and 3-pole housing for Class R fuses at 250Vac.
- R250 fuse blocks are listed with a Short-Circuit Current Rating of 200kA RMS Sym.

**Typical Applications**

- 250Vac/dc or less Control Systems
- 250Vac/dc or less Industrial Control
- 250Vac/dc or less Industrial Control Circuits

**Recommended DIN-Rail adapters for the 1/10-30A series**

- see page 509.

**Class H Fuseblocks (250V) Catalog Data (for NON and REN Fuses)**

Amps	Poles	Terminal Type (Suffix No.)										Figure Number	Wire Range
		Screw					Box Lug w/						
		Catalog Number	—	Clip with Reinforced Spring	Pressure Plate	Pressure Plate & Clip with Reinforced Spring	—	Clip with Reinforced Spring	Copper Only	0.25" Quick Connect			
1/10 to 30	1	H25030-1	S	SR	P	PR	C	CR	—	Q	1	C, CR #2-14 Cu, #2-12 Al P, PR #10-18 Cu Only Q N/A S, SR #10-18 Cu Only	
	2	H25030-2	S	SR	P	PR	C	CR	—	—	2		
	3	H25030-3	S	SR	P	PR	C	CR	—	—	3		
31 to 60	1	H25060-1	—	—	—	—	C	CR	CO	—	4	C, CR #2-14 Cu, #2-8 Al CO #2-14 Cu Only	
	2	H25060-2	—	—	—	—	C	CR	CO	—	5		
	3	H25060-3	—	—	—	—	C	CR	CO	—	6		
61 to 100	1	H25100-1	—	SR	—	—	—	CR	—	—	7	CR #1/0-8 Cu/Al SR #8W/ Ring Terminal	
	2	H25100-2	—	SR	—	—	—	CR	—	—	8		
	3	H25100-3	—	SR	—	—	—	CR	—	—	9		

# Class H(K) and R Fuse Blocks – 250V

## Class R Fuseblocks (250V) Catalog Data (for LPN-RK, FRN-R and KTN-R Fuses)

Amps	Poles	Catalog Number	Terminal Type (Suffix No.)				Fig. No.	Wire Range	
			Screw w/	Box Lug w/	0.25" Quick-Connect				
1/2 to 30	1	R25030-1	SR	PR	CR	COR	QR*	1	COR #6-14 Cu Only
	2	R25030-2	SR	PR	CR	COR	—	2	CR #2-14 Cu, #2-12 Al
	3	R25030-3	SR	PR	CR	COR	—	3	PR #10-18 Cu Only QR N/A SR #10-18 Cu Only
31 to 60	1	R25060-1	—	—	CR	—	—	4	CR #2-14 Cu, #2-8 Al
	2	R25060-2	—	—	CR	—	—	5	
	3	R25060-3	—	—	CR	—	—	6	
61 to 100	1	R25100-1	—	—	CR	—	—	7	CR 1/0-8 Cu/Al
	2	R25100-2	—	—	CR	—	—	8	
	3	R25100-3	—	—	CR	—	—	9	

### Dimensions - in 250V 1/2 to 30A



FIGURE 1.

FIGURE 2.

FIGURE 3.

### 250V, 31A to 60A

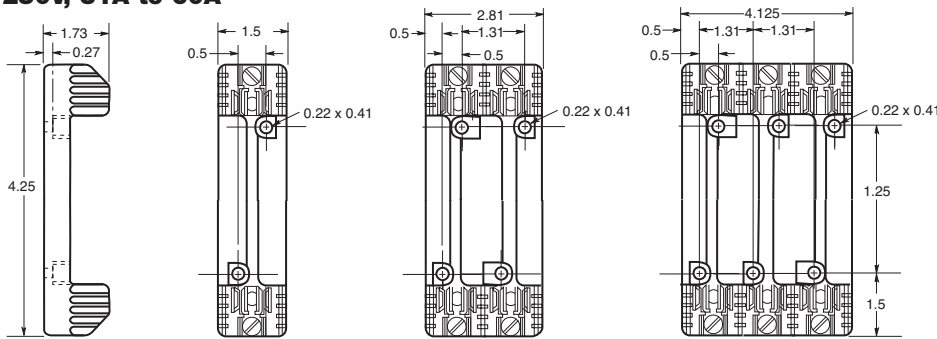

FIGURE 4.

FIGURE 5.

FIGURE 6.

### 250V, 61A to 100A

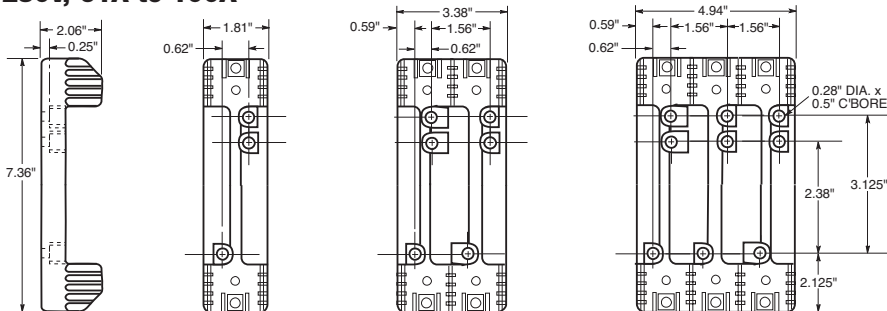

FIGURE 7.

FIGURE 8.

FIGURE 9.

Data Sheet: H250 Series, 1112; R250 Series, 1110

For product data sheets, visit [www.cooperbussmann.com/DatasheetsEle](http://www.cooperbussmann.com/DatasheetsEle)

# Class H(K) and R Fuse Blocks – 250V

## H250 & R250 Series

### Specifications

#### Descriptions:

**H250 Series:** 1-, 2- and 3-pole fuse blocks for use with Class H fuses.

**R250 Series:** 1-, 2- and 3-pole fuse blocks for use with Class R fuses (Bussmann LPN-RK and FRN-R and KTN-R fuses).

**Dimensions:** See Dimensions illustrations.

#### Ratings:

Volts: — 250Vac/dc (H250 & R250 Series)

Amps: — 1/10-100A

SCCR: — H250 Series; 10kA RMS Sym.

— R250 Series; 200kA RMS Sym.



**Agency Information:** CE, UL Listed UL 4248, Guide IZLT, File E14853; CSA Certified, Class 6225-01, File 47235.

**Flammability Rating:** UL 94V0.

#### Features and Benefits

- H250 fuse blocks provide one, two and three pole housing for Class H, K and R fuses at 250Vac.
- H250 fuse blocks are listed with a Short-Circuit Current Rating of 10kA RMS Sym.
- R250 fuse blocks provide 1-, 2- and 3-pole housing for Class R fuses at 250Vac.
- R250 fuse blocks are listed with a Short-Circuit Current Rating of 200kA RMS Sym.

#### Typical Applications

- 250Vac/dc or less Control Systems
- 250Vac/dc or less Industrial Control
- 250Vac/dc or less Industrial Control Circuits

**Recommended DIN-Rail adapters for the 1/10-30A series**

- see page 509.

### Class H Fuseblocks (250V) Catalog Data (for NON and REN Fuses)

Amps	Poles	Terminal Type (Suffix No.)										Figure Number	Wire Range
		Screw					Box Lug w/						
		Catalog Number	—	Clip with Reinforced Spring	Pressure Plate	Pressure Plate & Clip with Reinforced Spring	—	Clip with Reinforced Spring	Copper Only	0.25" Quick Connect			
1/10 to 30	1	H25030-1	S	SR	P	PR	C	CR	—	Q	1	C, CR #2-14 Cu, #2-12 Al P, PR #10-18 Cu Only Q N/A S, SR #10-18 Cu Only	
	2	H25030-2	S	SR	P	PR	C	CR	—	—	2		
	3	H25030-3	S	SR	P	PR	C	CR	—	—	3		
31 to 60	1	H25060-1	—	—	—	—	C	CR	CO	—	4	C, CR #2-14 Cu, #2-8 Al CO #2-14 Cu Only	
	2	H25060-2	—	—	—	—	C	CR	CO	—	5		
	3	H25060-3	—	—	—	—	C	CR	CO	—	6		
61 to 100	1	H25100-1	—	SR	—	—	—	CR	—	—	7	CR #1/0-8 Cu/Al SR #8W/ Ring Terminal	
	2	H25100-2	—	SR	—	—	—	CR	—	—	8		
	3	H25100-3	—	SR	—	—	—	CR	—	—	9		

# Class H(K) and R Fuse Blocks – 250V

## Class R Fuseblocks (250V) Catalog Data (for LPN-RK, FRN-R and KTN-R Fuses)

Amps	Poles	Catalog Number	Terminal Type (Suffix No.)					Fig. No.	Wire Range
			Screw w/	Pres. Plate	Box Lug w/	Clip Cu Only	0.25" Quick-Connect		
1/40 to 30	1	R25030-1	SR	PR	CR	COR	QR*	1	COR #6-14 Cu Only
	2	R25030-2	SR	PR	CR	COR	—	2	CR #2-14 Cu, #2-12 Al
	3	R25030-3	SR	PR	CR	COR	—	3	PR #10-18 Cu Only QR N/A SR #10-18 Cu Only
31 to 60	1	R25060-1	—	—	CR	—	—	4	CR #2-14 Cu, #2-8 Al
	2	R25060-2	—	—	CR	—	—	5	
	3	R25060-3	—	—	CR	—	—	6	
61 to 100	1	R25100-1	—	—	CR	—	—	7	CR 1/0-8 Cu/Al
	2	R25100-2	—	—	CR	—	—	8	
	3	R25100-3	—	—	CR	—	—	9	

### Dimensions - in 250V 1/40 to 30A

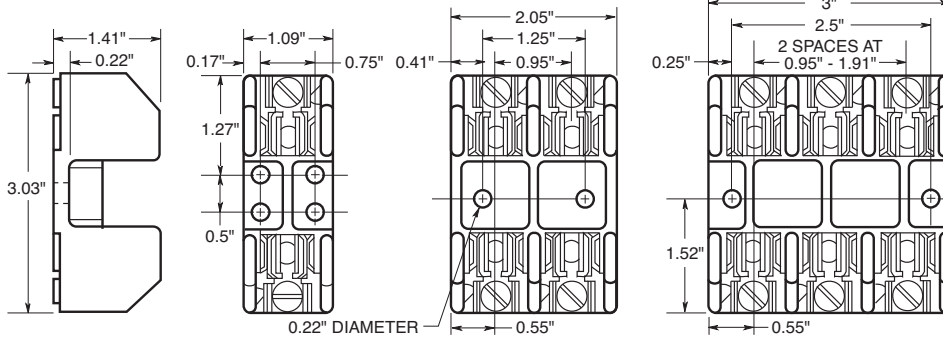

FIGURE 1.

FIGURE 2.

FIGURE 3.

### 250V, 31A to 60A

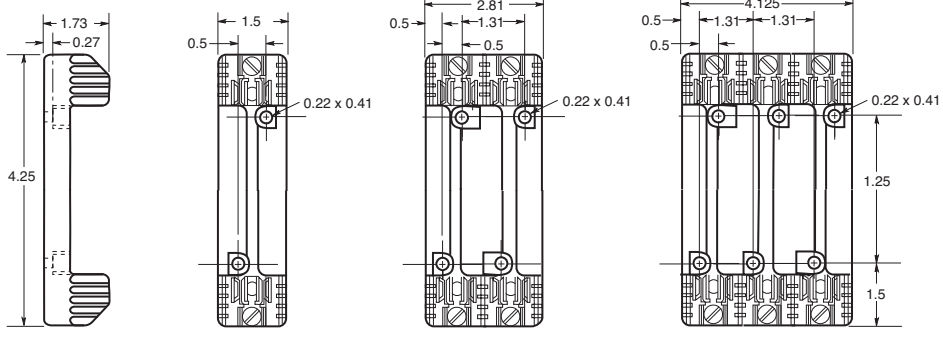

FIGURE 4.

FIGURE 5.

FIGURE 6.

### 250V, 61A to 100A

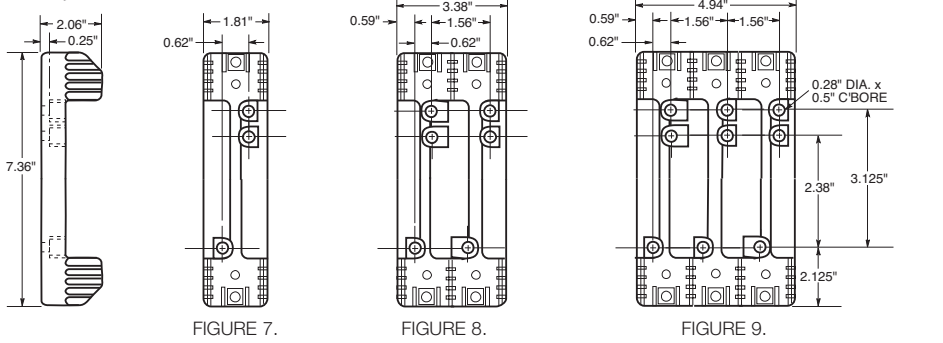

FIGURE 7.

FIGURE 8.

FIGURE 9.

Data Sheet: H250 Series, 1112; R250 Series, 1110

For product data sheets, visit [www.cooperbussmann.com/DatasheetsEle](http://www.cooperbussmann.com/DatasheetsEle)