



Plugmold systems are available in a variety of colors and configurations.

Plugmold® Raceway & Multioutlet Assemblies

Plugmold® Multioutlet Systems are available in a wide variety of lengths and fittings and in a variety of finishes to provide versatile solutions for many applications. Plugmold options include single or alternating circuits, standard or isolated ground receptacles, GFCI protection, tamper-resistant protection, USB charging, Snapicoil® harnesses of prewired receptacles, and cord-ended units.

Plugmold® Multioutlet Systems are available in black or ivory ScuffCoat™ finish, painted white or gray enamel steel, stylish stainless steel, anodized aluminum and durable textured ivory nonmetallic. The painted steel product works with many types of decor and is paintable to integrate with most color schemes. Durable stainless steel and anodized aluminum Plugmold products are corrosion-resistant, making them ideal for labs.

PRODUCTS: PLUGMOLD 2000 SERIES, 2400 SERIES, AL2000 SERIES, NM2000 SERIES, NM2400 SERIES

Features & Benefits

- **Compact, low profile appearance.** Enhanced aesthetics and ideal for installations within minimal spaces.
- **Multiple finishes.** Choose from black or ivory ScuffCoat, white or gray painted enamel or durable stainless steel finishes.
- **USB Charging.** Available with dual-port USB-A modules, sharing 2.4 amps of charging capacity and single-port USB-C module with 30W Power Delivery.
- **Tamper-resistance protection.** Prevents the accidental insertion of foreign objects into receptacles reducing the risk of shocks or electrocution. Meets 2014 NEC section 406 requirements.
- **Single, alternating circuit, and isolated ground wiring options available.** Wiring options to meet virtually any job or environment requirement.
- **Variety of lengths.** Installed power and USB charging in multiple lengths to meet space and location requirements.
- **Full range of fittings.** Provide flexibility for multiple installation options or integrations with 2000 or 2400 Series Raceway systems.
- **Snapicoil harnesses with different lengths and receptacle spacing.** Custom solution available for large or specific use electrical installations.
- **Customization available.** Plugmold products can be modified to accommodate virtually any application or aesthetic need.
- **Receptacle spacing options.** Select the right configuration for your application.
- **cULus Listed.** Safety and reliability in the applications.

Vertical Markets

- Commercial
- Education
- Entertainment
- Healthcare
- Retail
- Hospitality



Compliance

cULus Listed Base & Blank Cover: File E4376 Guide RJBT

Multioutlet Assemblies: File E15191 Guide PVGT

Fittings: File E41751 Guide RJPR

Base & Blank Cover: Meets Article 386 of NEC

Plugmold Strips: Meets Article 380 of NEC

Plugmold Multioutlet Systems Quick Selection Guide

FABRICATION	PROFILE	FINISH OPTIONS	LENGTHS	WIRING CONFIGS.	OUTLET OPTIONS		OPTIONS
					O.C. SPACING	QUANTITY	
Steel	2000 Series	Black Scuffcoat	2' (610mm) *	GB, GB/USB, GBA	6" (152mm)	4 Single	<ul style="list-style-type: none"> Hard-Wired models Cord-Ended models USB Charging models Plug-In model GFCI Protection Tamper-Resistant
		Ivory Scuffcoat	3' (910mm)		9" (229mm)	5 Single	
		Gray Enamel	5' (1.5m)		12" (305mm)	6 Single	
		White Enamel	6' (1.8m)		18" (457mm)	8 Single	
		Stainless Steel			24" (608mm)	10 Single	
						12 Single	
						3 Duplex	
						4 Duplex	
						5 Duplex	
						6 Duplex	
Steel	2400 Series	Ivory Scuffcoat	3' (910mm)	GB, GBA, IG	6" (152mm)	4 Single	<ul style="list-style-type: none"> Hard-Wired models Cord-Ended models
			5' (1.5m)		12" (305mm)	5 Single	
			6' (1.8m)		18" (457mm)	6 Single	
					24" (608mm)	10 Single	
						12 Single	
						3 Duplex	
						4 Duplex	
						5 Duplex	
						6 Duplex	
			Aluminum		AL2000 Series	Anodized	
5' (1.5m)	12" (305mm)	5 Single					
6' (1.8m)	18" (457mm)	6 Single					
		10 Single					
		12 Single					
		12 Single					
Nonmetallic	NM2000 Series	Ivory PVC	4' (1.2m)	GB, GBA, IG	9" (229mm)	2 Duplex	<ul style="list-style-type: none"> Hard-Wired models Cord-Ended models
			5' (1.5m)		12" (305mm)	4 Duplex	
			6' (1.8m)		15" (381mm)	5 Duplex	
					18" (457mm)	6 Duplex	
					30" (760mm)	6 Duplex	
						8 Duplex	
Nonmetallic	NM2400 Series	Ivory PVC	3' (910mm)	GB, GBA	12" (305mm)	2 Duplex	<ul style="list-style-type: none"> Hard-Wired models Cord-Ended models
			4' (1.2m)		18" (457mm)	3 Duplex	
			5' (1.5m)		30" (760mm)	4 Duplex	
			6' (1.8m)			5 Duplex	
						6 Duplex	
						6 Duplex	

Plugmold 2000 Series Steel Multioutlet Systems Ordering Information

Plugmold 2000 Series Steel Part Numbering System

2000 Series Steel Plugmold Series - Example: G20GB306



G

COLOR:

Black = BK
Gray = G
Ivory = V
White = WH
Stainless = S

20

RACEWAY:

2000 = 20

GB

WIRING CONFIGURATION:

GB = GB
GBA = GBA

3

LENGTH:

24" (608mm) = 2*
36" (915mm) = 3
60" (1.5m) = 5
72" (1.8m) = 6

06

CENTER DISTANCE:

6" (152mm) = 6
9" (229mm) = 9**
12" (305mm) = 12
18" (457mm) = 18

* Stainless steel only.
** 6' lengths only.

NOTE: Not all combinations of color, wiring configurations, length, and center distance are available as standard products. For additional information, contact Wiremold Technical Support at 1-844-957-3783.

NOTE: Color codes: "V" for Ivory ScuffCoat™ finish, "BK" for Black ScuffCoat™ finish, "G" for Gray enamel finish, "WH" for white enamel finish, and "S" for stainless steel. Receptacle colors match extrusion colors except for stainless steel which has black receptacles.

* All 2000 Series Plugmold products include two (2) 2010B Blank End Fittings and one (1) 2001 Base Coupling unless otherwise indicated in the product description.

Steel Plugmold® Multioutlet Systems

Steel Plugmold Multioutlet Systems are available in a wide range of lengths and finishes to provide a versatile solution for many applications. Options include versions with single or alternating circuits, standard receptacles, Snapicoil® harnesses of prewired receptacles, USB charging options, GFCI protection, tamper-resistance, plug-in and cord-ended units.

Steel Plugmold® Multioutlet Systems are available in black or ivory ScuffCoat™ finish, painted white or gray enamel finish, or stylish stainless steel. The enamel finishes work with many types of decor or can be painted to blend with most color schemes. Stainless steel Plugmold raceway is both durable and aesthetically pleasing.



Steel Plugmold systems are available in a variety of colors and configurations.

Plugmold 2000 Series Steel Multioutlet Systems

Plugmold 2000 Series Wire Fill Capacities for Power				
CABLE TYPE	WIRE SIZE THHN/THWN	O.D.		NO. OF CONDUCTORS (40% FILL) 2000
		Inches	(mm)	
POWER WIRING WITHOUT DEVICES	12 AWG	0.130	(3.3)	7*
	14 AWG	0.111	(2.8)	7*
POWER WIRING WITH DEVICES (Plugmold Series)	12 AWG	0.122	(3.1)	5**
	14 AWG	0.105	(2.7)	5**



*Wire capacity limited to maximum of seven conductors due to .025" (.6mm) material thickness of cover.

**Including one hot, neutral, and ground wire from the receptacle.



Steel Plugmold Multioutlet Systems are ideal for use in homes, dormitories and office applications, anywhere convenient access to power or USB charging is needed.

Plugmold 2000 Series Steel Multioutlet Systems Ordering Information

Plugmold 2000 Series Wiring Configurations			
<p>GB Series: 3-wire, #12 THHN (1 hot, 1 neutral and 1 ground), 1 circuit; has insulated grounding conductor.</p>	<p>GBA Series: 4-wire, #12 THHN (2 hot, 1 neutral and 1 ground), 2 circuit; outlets wired alternately; has insulated grounding conductor.</p>	<p>GB Series: 3-wire, #12 THHN (1 hot, 1 neutral and 1 ground), 1 circuit; has insulated grounding conductor.</p>	<p>GBA Series: 4-wire, #12 THHN (2 hot, 1 neutral and 1 ground), 2 circuit; outlets wired alternately; has insulated grounding conductor.</p>

NOTE: SNAPICOIL REELS on custom order. Snapicoil harness is available on reels if lengths greater than 50' are needed, or if multiple lengths are required for production-type jobs. The maximum length per reel is 240' for Snapicoil with outlets 12" and 18" on centers; 500' with outlets 30" on center. Packaging includes the necessary number of lengths of base, holecut cover, wire clips, and couplings for complete installation. Price and delivery information should be obtained prior to specifying or ordering. To specify or order, add "R" to the Snapicoil number. Ex: V20GB12R. Other outlet spacings available on custom order.

Receptacles are made from high impact thermoplastic. Snapicoil packaging includes the necessary lengths of 2000B Base, 2000C Hole Cut Cover, 2000WC Wire Clips, and 2001 Couplings for complete installation.

Plugmold 2000 Series Steel Multioutlet Systems Ordering Information

Plugmold 2000 Series Steel with Snapicoil Harness Ordering Information									
CATALOG NO.	LENGTH		WIRING CONFIG	OUTLETS (15A 120V NEMA 5-15SR) CENTER DISTANCE		QUANTITY	HOLE CUT COVER LENGTH		HOUSING
	Feet	(meters)		Inches	(mm)		QUANTITY	Feet	
20GB12*	48'	(14.63)	GB	12"	(305mm)	48 Single	8	6' (1.8m)	Steel - Ivory, Gray
20GB18*	48'	(14.63)	GB	18"	(457mm)	32 Single	8	6' (1.8m)	Steel - Ivory, Gray
V20GB30	50'	(15.25)	GB	30"	(760mm)	20 Single	10	5' (1.5m)	Steel - Ivory
20GBA12*	48'	(14.63)	GBA	12"	(305mm)	48 Single	8	6' (1.8m)	Steel - Ivory, Gray

CUSTOM PLUGMOLD

Plugmold is one of our most frequently requested custom products. From airports, to trains, to classrooms, dormitories or residences, anywhere multiple access to power or USB charging is needed. Custom receptacle spacing options, custom colors, wiring modifications, or any number of custom configurations are available for special applications. Contact the factory to discuss our capabilities and why Plugmold is often the best option for locations requiring multiple access to power or USB charging.



Plugmold 2000 Series Steel Multioutlet Systems Ordering Information

Product	Description/Specifications
---------	----------------------------

GFCI Plugmold

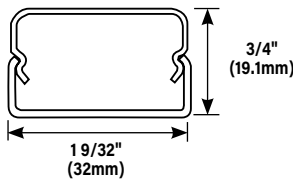
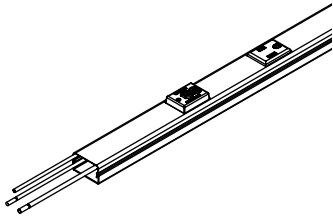

GFCI Module provides downstream protection for all outlets and connections. Available in 3' (914mm), 5' (1.5m) and 6' (1.8m) lengths with 6" (152mm) receptacle spacing. 15A tamper-resistant receptacles. 3-wire, #12 THHN (1 hot, 1 neutral, and insulated ground conductor). .040" (1.0mm) steel housing. Packed 2 per carton. Each unit supplied with one (1) Coupling and two (2) Blank End Fittings. GFCI Class A 20A 125V 60Hz.

CATALOG NO.	FINISH	LENGTH Feet (mm)	WIRING CONFIG	CENTER DISTANCE Inches (mm)	OUTLETS QUANTITY & TYPE
WH20GB306TRGFI6	White	3' (915mm)	GB	6" (152mm)	1 GFCI, 5 Single 15A
BK20GB306TRGFI6	Black	3' (915mm)	GB	6" (152mm)	1 GFCI, 5 Single 15A
V20GB306TRGFI6	Ivory	3' (915mm)	GB	6" (152mm)	1 GFCI, 5 Single 15A
G20GB306TRGFI6	Gray	3' (915mm)	GB	6" (152mm)	1 GFCI, 5 Single 15A
S20GB306TRGFI6	Stainless	3' (915mm)	GB	6" (152mm)	1 GFCI, 5 Single 15A
WH20GB506TRGFI6	White	5' (1.5m)	GB	6" (152mm)	1 GFCI, 9 Single 15A
BK20GB506TRGFI6	Black	5' (1.5m)	GB	6" (152mm)	1 GFCI, 9 Single 15A
V20GB506TRGFI6	Ivory	5' (1.5m)	GB	6" (152mm)	1 GFCI, 9 Single 15A
G20GB506TRGFI6	Gray	5' (1.5m)	GB	6" (152mm)	1 GFCI, 9 Single 15A
S20GB506TRGFI6	Stainless	5' (1.5m)	GB	6" (152mm)	1 GFCI, 9 Single 15A
WH20GB606TRGFI6	White	6' (1.8m)	GB	6" (152mm)	1 GFCI, 11 Single 15A
BK20GB606TRGFI6	Black	6' (1.8m)	GB	6" (152mm)	1 GFCI, 11 Single 15A
V20GB606TRGFI6	Ivory	6' (1.8m)	GB	6" (152mm)	1 GFCI, 11 Single 15A
G20GB606TRGFI6	Gray	6' (1.8m)	GB	6" (152mm)	1 GFCI, 11 Single 15A
S20GB606TRGFI6	Stainless	6' (1.8m)	GB	6" (152mm)	1 GFCI, 11 Single 15A

NOTE: GFCI module does not contain an outlet.

Tamper-Resistant Plugmold

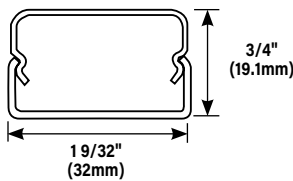
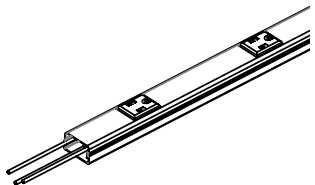

Receptacles prevent the accidental insertion of foreign objects into receptacles reducing the risk of shocks or electrocution. Meets 2014 NEC section 406 requirements. Available in 3' (914mm), 5' (1.5m) and 6' (1.8m) lengths with 6" (152mm) receptacle spacing. 15A tamper-resistant receptacles. | 3-wire, #12 THHN (1 hot, 1 neutral, and insulated ground conductor). .040" (1.0mm) steel housing. Packed 2 per carton. Each unit supplied with one (1) Coupling and two (2) Blank End Fittings.

CATALOG NO.	FINISH	LENGTH Feet (mm)	WIRING CONFIG	CENTER DISTANCE Inches (mm)	OUTLETS QUANTITY & TYPE
WH20GB306TR	White	3' (915mm)	GB	6" (152mm)	6 Single TR 15A
BK20GB306TR	Black	3' (915mm)	GB	6" (152mm)	6 Single TR 15A
V20GB306TR	Ivory	3' (915mm)	GB	6" (152mm)	6 Single TR 15A
G20GB306TR	Gray	3' (915mm)	GB	6" (152mm)	6 Single TR 15A
S20GB306TR	Stainless	3' (915mm)	GB	6" (152mm)	6 Single TR 15A
WH20GB506TR	White	5' (1.5m)	GB	6" (152mm)	9 Single TR 15A
BK20GB506TR	Black	5' (1.5m)	GB	6" (152mm)	9 Single TR 15A
V20GB506TR	Ivory	5' (1.5m)	GB	6" (152mm)	9 Single TR 15A
G20GB506TR	Gray	5' (1.5m)	GB	6" (152mm)	9 Single TR 15A
S20GB506TR	Stainless	5' (1.5m)	GB	6" (152mm)	9 Single TR 15A
WH20GB606TR	White	6' (1.8m)	GB	6" (152mm)	11 Single TR 15A
BK20GB606TR	Black	6' (1.8m)	GB	6" (152mm)	11 Single TR 15A
V20GB606TR	Ivory	6' (1.8m)	GB	6" (152mm)	11 Single TR 15A
G20GB606TR	Gray	6' (1.8m)	GB	6" (152mm)	11 Single TR 15A
S20GB606TR	Stainless	6' (1.8m)	GB	6" (152mm)	11 Single TR 15A

NOTE: Color codes: "V" for Ivory ScuffCoat™ finish, "BK" for Black ScuffCoat™ finish, "G" for Gray enamel finish, "WH" for white enamel finish, and "S" for stainless steel. Receptacle colors match extrusion colors except for stainless steel which has black receptacles and isolated ground versions which have orange receptacles.

All 2000 Series Plugmold products include two (2) 2010B Blank End Fittings and one (1) 2001 Base Coupling unless otherwise indicated in the product description.

Plugmold 2000 Series Steel Multioutlet Systems Ordering Information

USB Plugmold



Available in 3' [914mm], 5' [1.5m] and 6' [1.8m] lengths with 6" [152mm] receptacle spacing. 15A tamper-resistant receptacles. 3-wire, #12 THHN (1 hot, 1 neutral, and insulated ground conductor rated for use on 20A circuits). .040" [1.0mm] steel housing. Packed 2 per carton. Each unit supplied with one (1) Coupling and two (2) Blank End Fittings. USB is 2.4 Amp (shared between 2 ports) 5VDC.

USB PLUGMOLD CATALOG NO.	FINISH	LENGTH		WIRING CONFIG	CENTER DISTANCE		OUTLETS QUANTITY & TYPE	
		Feet	[mm]		Inches	[mm]		
BK20GB306TRUSB	Black	3'	[915mm]	GB	6"	[152mm]	1 USB A, 5 Single	15A
BK20GB506TRUSB	Black	5'	[1.5m]	GB	6"	[152mm]	1 USB A, 9 Single	15A
BK20GB606TRUSB	Black	6'	[1.8m]	GB	6"	[152mm]	1 USB A, 11 Single	15A
G20GB306TRUSB	Gray	3'	[915mm]	GB	6"	[152mm]	1 USB A, 5 Single	15A
G20GB506TRUSB	Gray	5'	[1.5m]	GB	6"	[152mm]	1 USB A, 9 Single	15A
G20GB606TRUSB	Gray	6'	[1.8m]	GB	6"	[152mm]	1 USB A, 11 Single	15A
V20GB306TRUSB	Ivory	3'	[915mm]	GB	6"	[152mm]	1 USB A, 5 Single	15A
V20GB506TRUSB	Ivory	5'	[1.5m]	GB	6"	[152mm]	1 USB A, 9 Single	15A
V20GB606TRUSB	Ivory	6'	[1.8m]	GB	6"	[152mm]	1 USB A, 11 Single	15A
S20GB306TRUSB	Stainless	3'	[915mm]	GB	6"	[152mm]	1 USB A, 5 Single	15A
S20GB506TRUSB	Stainless	5'	[1.5m]	GB	6"	[152mm]	1 USB A, 9 Single	15A
S20GB606TRUSB	Stainless	6'	[1.8m]	GB	6"	[152mm]	1 USB A, 11 Single	15A
WH20GB306TRUSB	White	3'	[915mm]	GB	6"	[152mm]	1 USB A, 5 Single	15A
WH20GB506TRUSB	White	5'	[1.5m]	GB	6"	[152mm]	1 USB A, 9 Single	15A
WH20GB606TRUSB	White	6'	[1.8m]	GB	6"	[152mm]	1 USB A, 11 Single	15A

All USB Plugmold



Available in 3' [914mm], and 5' [1.5m] lengths with 12" spacing. USB is 2.4 Amps (shared between two ports) 5VDC. .040" [1.0mm] steel housing. Packed two per carton. Each unit supplied with one (1) Coupling and two (2) Blank End Fittings. Each USB module provides 2 ports with 2.4 Amps of shared charging. Please note the charging load on one module will not affect the charging performance of the other USB modules in the product.

ALL USB PLUGMOLD CATALOG NO.	FINISH	LENGTH		WIRING CONFIG	CENTER DISTANCE		OUTLETS QUANTITY & TYPE
		Feet	[mm]		Inches	[mm]	
BK20USB312	Black	3'	[915mm]	USB	12"	[305mm]	3 USB A Modules
BK20USB512	Black	5'	[1.5m]	USB	12"	[305mm]	5 USB A Modules
G20USB312	Gray	3'	[915mm]	USB	12"	[305mm]	3 USB A Modules
G20USB512	Gray	5'	[1.5m]	USB	12"	[305mm]	5 USB A Modules
V20USB312	Ivory	3'	[915mm]	USB	12"	[305mm]	3 USB A Modules
V20USB512	Ivory	5'	[1.5m]	USB	12"	[305mm]	5 USB A Modules
S20USB312	Stainless	3'	[915mm]	USB	12"	[305mm]	3 USB A Modules
S20USB512	Stainless	5'	[1.5m]	USB	12"	[305mm]	5 USB A Modules
WH20USB312	White	3'	[915mm]	USB	12"	[305mm]	3 USB A Modules
WH20USB512	White	5'	[1.5m]	USB	12"	[305mm]	5 USB A Modules

Alternating USB Plugmold

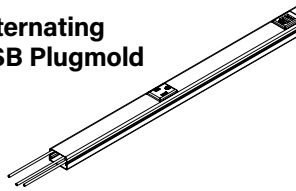

Available in 5' [1.5m] length with 9" spacing. 15A tamper-resistant receptacles. 3-wire, #12 THHN (1 hot, 1 neutral, and insulated ground conductor rated for use on 20A circuits). .040" [1.0 mm] steel housing. Packed two per carton. Each unit supplied with one (1) Coupling and two (2) Blank End Fittings. USB is 2.4 Amps (shared between two ports) 5VDC. Please note the charging load on one module will not affect the charging performance of the other USB modules in the product.

ALTERNATING USB PLUGMOLD CATALOG NO.	FINISH	LENGTH		WIRING CONFIG	CENTER DISTANCE		OUTLETS QUANTITY & TYPE
		Feet	[mm]		Inches	[mm]	
BK20GB509TRUSBA	Black	5'	[1.5m]	GB/USB	9"	[229mm]	3 Outlets/3 USB A Modules
G20GB509TRUSBA	Gray	5'	[1.5m]	GB/USB	9"	[229mm]	3 Outlets/3 USB A Modules
V20GB509TRUSBA	Ivory	5'	[1.5m]	GB/USB	9"	[229mm]	3 Outlets/3 USB A Modules
S20GB509TRUSBA	Stainless	5'	[1.5m]	GB/USB	9"	[229mm]	3 Outlets/3 USB A Modules
WH20GB509TRUSBA	White	5'	[1.5m]	GB/USB	9"	[229mm]	3 Outlets/3 USB A Modules
BK20GB509TRUAC	Black	5'	[1.5m]	GB/USB	9"	[229mm]	3 Outlets/2 USB A & 1 USB C Modules
G20GB509TRUAC	Gray	5'	[1.5m]	GB/USB	9"	[229mm]	3 Outlets/2 USB A & 1 USB C Modules
V20GB509TRUAC	Ivory	5'	[1.5m]	GB/USB	9"	[229mm]	3 Outlets/2 USB A & 1 USB C Modules
S20GB509TRUAC	Stainless	5'	[1.5m]	GB/USB	9"	[229mm]	3 Outlets/2 USB A & 1 USB C Modules
WH20GB509TRUAC	White	5'	[1.5m]	GB/USB	9"	[229mm]	3 Outlets/2 USB A & 1 USB C Modules

NOTE: Color codes: "V" for Ivory ScuffCoat™ finish, "BK" for Black ScuffCoat™ finish, "G" for Gray enamel finish, "WH" for white enamel finish, and "S" for stainless steel. Receptacle colors match extrusion colors except for stainless steel which has black receptacles and isolated ground versions which have orange receptacles. All 2000 Series Plugmold products include two (2) 2010B Blank End Fittings and one (1) 2001 Base Coupling unless otherwise indicated in the product description.

Plugmold 2000 Series Steel Multioutlet Systems Ordering Information

Cord-Ended Plugmold 2000 Series Steel Ordering Information

CAT NO.	UNIT LENGTH	OUTLETS QUANTITY	CORD SET LENGTH	TYPE	SWITCH	CIRCUIT BREAKER	FINISH
20-C2*	3' 4" (1m)	6 Single	6' (1.8m)	12/3 SJT	No	Yes	Steel - Gray, Ivory

* Use "V" prefix for Ivory ScuffCoat™ finish and "G" prefix for Gray enamel finish.

V2000BC (Ivory)
WH2000BC (White)
G2000BC (Gray)
BK2000BC (Black)
S2000BC (Stainless Steel)

Base and Cover - 2000B Base:
.040" (1.0mm) steel; 2000C
Cover: .025" (.6mm) steel.
Packed ten 5' (1.5m) lengths of
each per carton.

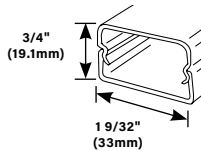

W30/W30G

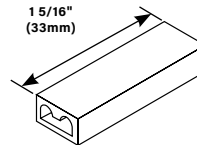

Pressure-Type Wire

Connectors - This part comes with both 16-W30 and 8-W30G. W30 - For common connection of two, three, or four No. 12 or No.14 solid copper conductors. W30G - For connection of equipment grounding of two, three, or four No.12 or No. 14 AWG solid conductors. 300V maximum; 20A 105° C maximum.

NOTE: Not for use with aluminum conductors.

V2000B-5 (Ivory)
WH2000B-5 (White)
G2000B-5 (Gray)

Raceway Base - .040" (1.0mm)
steel. Packed twenty 5' (1.5m)
lengths per carton.

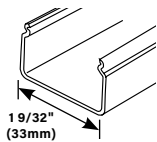

2000WC

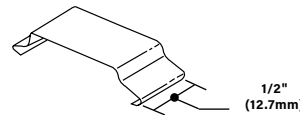

Wire Clip (Plated) - Use when
conductors bypass receptacles.
Not UL Listed.

V2000B-10 (Ivory)
WH2000B-10 (White)

Raceway Base - .040" (1.0mm)
steel. Packed ten 10' (3.05m)
lengths per carton.

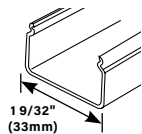

2001

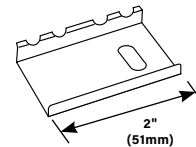

Coupling (Galvanized Steel)
- Joins lengths of 2000 Series
Raceway Base.

V2000C (Ivory)
WH2000C (White)
G2000C (Gray)

Raceway Cover - .025" (.6mm)
steel. Packed twenty 5' (1.5m)
lengths per carton. Has no
receptacle hole cuts.

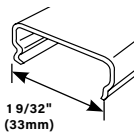

V2003 (Ivory) 2003 (Plated Finish)

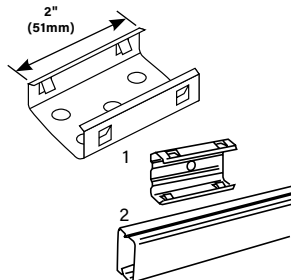

2003 Supporting Clip -
Temporary support, while
positioning lengths of raceway
base. Use with 2000 Series
Raceway.

- 2003 mounted on surface with No. 6 flathead screw.
- Plugmold 2000 snaps into 2003 Supporting Clip.

620

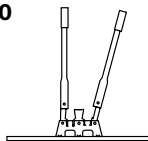

**Raceway Base and Cover
Cutter** - Portable cutter for
both 2000 Base and Cover.

V2006 (Ivory)
WH2006 (White)
G2006 (Gray)
BK2006 (Black)
S2006 (Stainless Steel)

2006 Cover Clip - Covers
seam where lengths of cover or
base meet.

620BCK

Replacement Blade Kit -
Replacement blades and die
set for 620 Cutter.

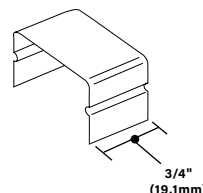

2000 Series Steel Raceway Fittings Ordering Information

2009



Ground Clamp (Galvanized) - Connects equipment grounding conductor to provide an additional ground to raceway.



V2010A3 (Ivory)
WH2010A3 (White)
G2010A3 (Gray)
BK2010A3 (Black)

2010A3 Entrance End Fitting - Offers larger capacity than V2010A2. 1/2" trade size KOs on end, each side and bottom. 3/4" trade size KOs on bottom and rear. Includes ground screw.

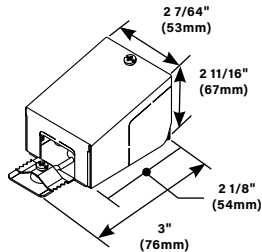

V2010A2 (Ivory)
WH2010A2 (White)
G2010A2 (Gray)
BK2010A2 (Black)
S2010A2 (Stainless Steel)

2010A2 Entrance End Fitting - Smallest entrance end fitting for connecting Plugmold 2000TR Series with 1/2" trade size conduit and armored cable connectors. 1/2" trade size KOs on end, each side and bottom. Includes ground screw.



V2010B (Ivory)
WH2010B (White)
G2010B (Gray)
BK2010B (Black)
S2010B (Stainless Steel)

Blank End - Closes off open end of 2000 Series Raceway.



V2011 (Ivory)
WH2011 (White)
G2011 (Gray)
BK2011 (Black)
S2011 (Stainless Steel)

90° Flat Elbow - Right angle turns on same surface. Cover stop permits neat butting of 2000C Cover. Two couplings furnished.



V2015 (Ivory)
WH2015 (White)
G2015 (Gray)
BK2015 (Black)



Tee - Branches raceway at right angles. Couplings furnished.

2017TC



Internal Corner Coupling - Furnished with one fiber bushing.



1. 2017TC used as a corner coupling.
2. 2017TC used as a corner coupling and a straight-through fitting.

V2018C (Ivory)
WH2018C (White)
G2018C (Gray)
BK2018C (Black)
S2018C (Stainless Steel)

External Elbow Cover - Continues raceway runs around outside corner. Fills the gap when external corner is made by notching and bending the 2000 Base.



Corner Gap Filler snapped into place in 2018C.



V2048 (Ivory)
WH2048 (White)
G2048 (Gray)
BK2048 (Black)
S2048 (Stainless Steel)

Single-Gang Device Box - Cover has twistouts for 2000, 500 and 700 Series Raceways. Base has 1/2" trade size KO and rectangular KO for extension to wall box. Base has No. 10 threaded hole for ground connection.



2000 Series Steel Raceway Fittings Ordering Information

V2048-2 (Ivory)
WH2048-2 (White)
G2048-2 (Gray)
BK2048-2 (Black)



Two-Gang Device Box - Cover has twistouts for 2000, 500 and 700 Series Raceways. Base has 1/2" trade size KO and rectangular KO for extension to wall box. Base has No.10 threaded hole for ground connection.

V2089



Side Reducing Connector - connects 2000 Series Plugmold with 500 Series Raceway through the side of 2000 Series Plugmold.

V2051H (Ivory)
WH2051H (White)
G2051H (Gray)
BK2051H (Black)
S2051H (Stainless Steel)



Flush Plate Adapter - Feeds 2000 Series Plugmold from an existing wall outlet. Equipped with 1/2" (12.7mm) threaded stud, toothed lock washer for grounding, threaded hole for and conduit bushing.

V2089E



End Reducing Connector - Connects 2000 Series Plugmold with 500 Series Raceway through the end of 2000 Series Plugmold.



Plugmold 2000 extended from wall outlet using 2051H.



2051H fastened to horizontally mounted wall box.



2051H fastened to vertically mounted wall box.

V20-C2 (6 Foot Cord)
G20-C2 (15 Foot Cord)



Plug-In Outlet Center Unit - Six outlets, steel housing with ivory (V20-C2) or gray finish (G20-C2). 6' (1.8m) cord. Length 40" (1m). Receptacle center-to-center 6" (152mm).

2000 Series Interconnectivity Fittings

CONNECTION REQUIRED		USE CATALOG NUMBER
FROM	TO	
500 Series Raceway	Side of Plugmold 2000 Series	V2089, V2048, V2048-2
500 Series Raceway	End of Plugmold 2000 Series	V2089E, V2048, V2048-2
Existing Outlet	Plugmold 2000 Series	V2051H
1/2" trade size Conduit or Armored Cable	End of Plugmold 2000 Series	V2010A2, V2010A3

Plugmold 2400 Series Steel Multioutlet Systems

2400 Series Plugmold Wire Fill Capacities for Power				
CABLE TYPE	WIRE SIZE THHN/THWN	O.D.		NO. OF CONDUCTORS (40% FILL) 2400
		Inches	(mm)	
POWER WIRING WITHOUT DEVICES	10 AWG	0.166	(4.2)	26
	12 AWG	0.130	(3.3)	41
	14 AWG	0.111	(2.8)	57
POWER WIRING WITH DEVICES (Plugmold Series)	8 AWG	0.218	(5.5)	2
	10 AWG	0.153	(3.9)	6
	12 AWG	0.122	(3.1)	10
	14 AWG	0.105	(2.7)	-



Plugmold 2400 Series Steel Part Numbering System

2400 Series Steel Plugmold Series w/Simplex Receptacle - Example: 24GBA512

	V	24	GBA	5	12
COLOR:	RACEWAY:	WIRING CONFIGURATION:	LENGTH:	CENTER DISTANCE:	
Ivory = V	2400 = 24	GB = GB GBA = GBA	36" (915mm) = 3 60" (1.5m) = 5 72" (1.8m) = 6	6" (152mm) = 6 12" (305mm) = 12 18" (457mm) = 18	

2400 Series Steel Plugmold Series w/Duplex Receptacle - Example: 24SGBX3618I

24S	36	18	GBX	99IV
RACEWAY:	LENGTH:	CENTER DISTANCE:	WIRING CONFIGURATION:	COLOR:
2400 = 24S	36" (915mm) = 36 60" (1.5m) = 60 72" (1.8m) = 72	12" (305mm) = 12 18" (457mm) = 18 24" (610mm) = 24	GBX = GBX GBA = GBA IGX = IGX	Ivory = 99IV

NOTE: Not all combinations of color, wiring configurations, length, and center distance are available as standard products. For additional information, contact Wiremold Technical Support at 1-844-957-3783.

NOTE: Color codes: "V" for Ivory ScuffCoat™ finish. Receptacle colors match extrusion colors except for isolated ground versions which have orange receptacles.

* All 2400 Series Plugmold products include two (2) 2410B Blank End Fittings and one (1) 2401 Base Coupling unless otherwise indicated in the product description.

Plugmold 2400 Series Steel Multioutlet Systems Ordering Information

Product	Description/Specifications
---------	----------------------------

Plugmold 2400 Series

Available in 3' (914mm), 5' (1.5m) and 6' (1.8m) lengths with 6" (152mm), 12" (305mm), 18" (457mm) and 24" (608mm) receptacle spacing. 20A receptacles. 3-wire, #12 THHN (1 hot, 1 neutral, and insulated ground conductor). .040" (1.0mm) steel housing. Packed 2 per carton. Each unit supplied with one (1) Coupling and two (2) Blank End Fittings.



CATALOG NO.	FINISH	LENGTH Feet (mm)	WIRING CONFIG	CENTER DISTANCE Inches (mm)	OUTLETS QUANTITY & TYPE
V24GB306	Ivory	3' (915mm)	GB	6" (152mm)	6 Single 20A
24S3612GBX99IV	Ivory	3' (915mm)	GB	12" (305mm)	3 Duplex 20A
24S3612GBA99IV	Ivory	3' (915mm)	GBA	12" (305mm)	3 Duplex 20A
V24GB506	Ivory	5' (1.5m)	GB	6" (152mm)	10 Single 20A
V24GB512	Ivory	5' (1.5m)	GB	12" (305mm)	5 Single 20A
V24GBA512	Ivory	5' (1.5m)	GBA	12" (305mm)	5 Single 20A
24S6012GBX99IV	Ivory	5' (1.5m)	GB	12" (305mm)	5 Duplex 20A
24S6012GBA99IV	Ivory	5' (1.5m)	GBA	12" (305mm)	5 Duplex 20A
24S6012IGX99IV	Ivory	5' (1.5m)	IG	12" (305mm)	5 Duplex 20A
V24GB606	Ivory	6' (1.8m)	GB	6" (152mm)	12 Single 20A
V24GB612	Ivory	6' (1.8m)	GB	12" (305mm)	6 Single 20A
V24GBA612	Ivory	6' (1.8m)	GBA	12" (305mm)	6 Single 20A
V24GB618	Ivory	6' (1.8m)	GB	18" (457mm)	4 Single 20A
V24GBA618	Ivory	6' (1.8m)	GBA	18" (457mm)	4 Single 20A
24S7212GBX99IV	Ivory	6' (1.8m)	GB	12" (305mm)	6 Duplex 20A
24S7224GBA99IV	Ivory	6' (1.8m)	GBA	24" (608mm)	3 Duplex 20A
24S7218GBX99IV	Ivory	6' (1.8m)	GB	18" (457mm)	4 Duplex 20A
24S7224GBX99IV	Ivory	6' (1.8m)	GB	24" (608mm)	3 Duplex 20A
24S7218IGX99IV	Ivory	6' (1.8m)	IG	18" (457mm)	4 Duplex 20A
24S7212IGX99IV	Ivory	6' (1.8m)	IG	12" (305mm)	6 Duplex 20A
24S7224IGX99IV	Ivory	6' (1.8m)	IG	24" (608mm)	3 Duplex 20A
24S7212GBA99IV	Ivory	6' (1.8m)	GBA	12" (305mm)	6 Duplex 20A
24S7218GBA99IV	Ivory	6' (1.8m)	GBA	18" (457mm)	4 Duplex 20A

NOTE: Color codes: "V" for Ivory ScuffCoat™ finish. Receptacle colors match extrusion colors except for isolated ground versions which have orange receptacles.

All 2400 Series Plugmold products include two (2) 2410B Blank End Fittings and one (1) 2401 Base Coupling unless otherwise indicated in the product description.

2400 Series Plugmold Wiring Configurations

			With Snapicoil	
<p>GB Series: 3-wire, #12 THHN (1 hot, 1 neutral and 1 ground), 1 circuit; has insulated grounding conductor.</p>	<p>GBA Series: 4-wire, #12 THHN (2 hot, 1 neutral and 1 ground), 2 circuit; outlets wired alternately; has insulated grounding conductor.</p>	<p>IG Series: 3-wire, #12 THHN (1 hot, 1 neutral and 1 ground), 1 circuit; has insulated-isolated grounding conductor. Orange receptacles.</p>	<p>GB Series: 3-wire, #12 THHN (1 hot, 1 neutral and 1 ground), 1 circuit; has insulated grounding conductor.</p>	<p>GBA Series: 4-wire, #12 THHN (2 hot, 1 neutral and 1 ground), 2 circuit; outlets wired alternately; has insulated grounding conductor.</p>

NOTE: SNAPICOIL REELS on custom order. Snapicoil harness is available on reels if lengths greater than 50' are needed, or if multiple lengths are required for production-type jobs. The maximum length per reel is 240' for Snapicoil with outlets 12" and 18" on centers; 500' with outlets 30" on center. Packaging includes the necessary number of lengths of base, holecut cover, wire clips, and couplings for complete installation. Price and delivery information should be obtained prior to specifying or ordering. To specify or order, add "R" to the Snapicoil number. Ex: V24GB12R. Other outlet spacings available on custom order.

Receptacles are made from high impact thermoplastic. Snapicoil packaging includes the necessary lengths of 2400B Base, 2400C Hole Cut Cover, 2400WC Wire Clips, and 2401 Couplings for complete installation.

2400 Series Steel Raceway Fittings Ordering Information

V2400



Base and Cover –
Base – V2400B .040" (1.0mm) steel.
Cover – V2400C .040" (1.0mm) steel.
Also available in custom colors.

Country of Origin: USA

Cross-Sectional Area:
1.39in² (897mm²)

ITEM	CAT. NO.	LENGTH	MATERIAL
Base	V2400B	5' (1.5m)	.040 Steel
Cover	V2400C	5' (1.5m)	.025 Steel
Base & Cover	V2400BC	5' (1.5m)	.025 Steel

V2410C



Entrance End Fitting – Has 1/2" and 3/4" trade size KOs on end and bottom. Additional 1/2" trade size KO on sides.

Country of Origin: USA

V2411M



90° Flat Elbow – For right angle turns on the same surface (nonmetallic cover).

Country of Origin: USA

2401



Coupling – For joining lengths of raceway. Use with V2400 Series.

Country of Origin: USA

V2417M



Internal Elbow – For making internal 90° corners. All steel construction.

Country of Origin: USA

2400WC

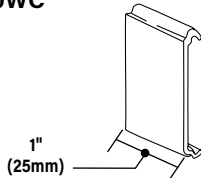

Wire Clip – Holds conductors in place in raceway.

Country of Origin: USA

V2418M



External Elbow – For covering outside corners (nonmetallic cover).

Country of Origin: USA

V2406



Cover Clip – For covering joint where lengths of cover or base adjoin. Use with V2400 Series (nonmetallic).

Country of Origin: USA

V2451H



Back Feed Fitting – For feeding 2400 Series Raceway from an existing outlet box. Equipped with 1/2" trade size male bushing and locknut washer for grounding.

Country of Origin: USA

2409



Ground Clamp – No. 10 ground screw provided. Use with V2400 Series Raceway.

Country of Origin: USA

V2448 V2448-2



Device Box – Base has 1/2" trade size KO and rectangular KO for extension to wall box. Has #10 threaded hole for ground connection. Cover has twistouts for 500/700 Series Raceway on each end and twistouts for 2400 Series Raceway on each side.

Country of Origin: USA

V2410A

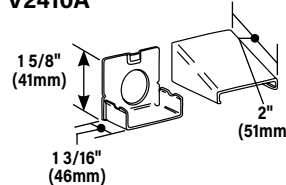

Entrance End – For connecting V2400 with 1/2" trade size conduit and armored cable. Use with V2400 Series Raceway.

Country of Origin: USA

CAT. NO.	L	W	D	GANG #
V2448	4 5/8" (117mm)	2 7/8" (73mm)	1 3/4" (44mm)	1
V2448-2	4 3/4" (121mm)	4 3/4" (121mm)	1 3/4" (44mm)	2

V2410B

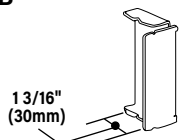

Blank End – For closing open end of V2400 Series Raceway.

Country of Origin: USA

2400 Series Steel Raceway Fittings Ordering Information

V2444
V2444-2



Extra Deep Device Box – Base has rectangular knockout to enable extension from existing single-gang flush wall box and 1/2" and 1" concentric KOs. Cover has twistouts for 500/700 Series Raceway on each end and twistouts for 2400 Series Raceway on each side.

Country of Origin: USA

CAT. NO.	L	W	D	GANG #
V2444	4 5/8" (117mm)	2 7/8" (73mm)	2 3/4" (44mm)	1
V2444-2	4 3/4" (121mm)	4 3/4" (121mm)	2 3/4" (44mm)	2

V2489



Side Reducing Connector – For connecting V2400 Series Raceway with V500 Series Raceway.

Country of Origin: USA

624



2400 and 2400BD Raceway & Cover Cutter – Portable cutter for 2400B and 2400BD Raceway and Cover. Tooled steel construction for clean and easy square cuts. Total manual operation.

Country of Origin: USA

624BCK

Replacement Blade Kit – Replacement blades and die set for 624 Cutter.

Country of Origin: USA

V2427GA



Duplex Receptacle – 3-wire, 15A, 125V, NEMA 5-15R. Provided with 10 1/2" (267mm) pigtails and inline splice connectors.

Country of Origin: USA

V2427GT



Duplex Receptacle – 3-wire, 20A, 125V, NEMA 5-20R. Provided with 10 1/2" (267mm) pigtails and inline splice connectors.

Country of Origin: USA

2686FO

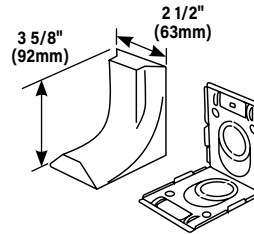

FiberReady Transition Feed Fitting – Eliminates offsetting V2400 in connecting with surface panel boxes. Has 3/4" and 1" concentric trade size KOs with 1" trade size KO elongated so adjustment from surface to center of bushing is 1" (25mm) minimum to 1 5/8" (41mm) maximum. Has twistouts for transition to Pancake 1500 and 2600 Series Raceway.

Country of Origin: USA

IG2427GA



Isolated Ground Duplex Receptacle – 3-wire, 15A, 125V NEMA 5-15R. Provided with 10 1/2" (267mm) pigtails and inline splice connectors.

Country of Origin: USA

IG2427GT



Isolated Ground Duplex Receptacle – 3-wire, 20A, 125V NEMA 5-20R. Provided with 10 1/2" (267mm) pigtails and inline splice connectors.

Country of Origin: USA

V2426

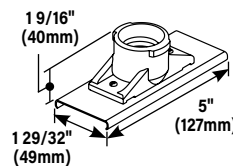

Lamp Holder – Medium base lamp holder 660W, 250V. Black, general purpose phenolic.

Country of Origin: USA

Aluminum Plugmold® Multioutlet Systems

Aluminum Plugmold® Multioutlet Systems offer an attractive choice for hospital and commercial labs, as well as for residential applications. The durable finish offers both aesthetics and corrosion resistance. Aluminum Plugmold Series is available in single and alternating circuits, with standard or isolated ground tamper-resistant receptacles. It can also be customized to meet virtually any job requirement.



The durable corrosion-resistant finish of Aluminum Plugmold Series makes it an ideal solution for use in laboratories.

Plugmold AL2000 Series Wire Fill Capacities for Power

CABLE TYPE	WIRE SIZE THHN/THWN	O.D.		NO. OF CONDUCTORS (40% FILL) AL2000
		Inches	(mm)	
POWER WIRING WITHOUT DEVICES	8 AWG	0.216	(5.5)	12
	10 AWG	0.166	(4.2)	24
	12 AWG	0.130	(3.3)	38
	14 AWG	0.111	(2.8)	51
POWER WIRING WITH DEVICES (Plugmold Series)	8 AWG	0.218	(5.5)	-
	10 AWG	0.153	(3.9)	3
	12 AWG	0.122	(3.1)	6
	14 AWG	0.105	(2.7)	8

Plugmold AL2400 Series Wire Fill Capacities for Power

CABLE TYPE	WIRE SIZE THHN/THWN	O.D.		NO. OF CONDUCTORS (40% FILL) AL2000
		Inches	(mm)	
POWER WIRING WITHOUT DEVICES	6 AWG	0.254	(6.5)	13
	8 AWG	0.216	(5.5)	18
	10 AWG	0.164	(4.2)	37
	12 AWG	0.130	(3.3)	58
	14 AWG	0.111	(2.8)	78
POWER WIRING WITH DEVICES (Plugmold Series)	6 AWG	0.254	(6.5)	3
	8 AWG	0.216	(5.5)	4
	10 AWG	0.164	(4.2)	8
	12 AWG	0.130	(3.3)	12
	14 AWG	0.111	(2.8)	16

Plugmold AL2000 Series Steel Multioutlet Systems Ordering Information

Plugmold AL2000 Series Aluminum Part Numbering System

AL2000 Series Aluminum Plugmold Series – Example: AL20GB306TR



AL	20	GB	3	06	TR
COLOR:	RACEWAY:	WIRING CONFIGURATION:	LENGTH:	CENTER DISTANCE:	TYPE:
Aluminum = AL 2000 = 20	GB = GB GBA = GBA IG = IG*	24" (608mm) = 2 36" (915mm) = 3 60" (1.5m) = 5 72" (1.8m) = 6	6" (152mm) = 6 9" (229mm) = 9 12" (305mm) = 12 18" (457mm) = 18	Tamper-Resistant = TR	

NOTE: Not all combinations of color, wiring configurations, length, and center distance are available as standard products. For additional information on custom options, contact Wiremold Technical Support at 1-844-957-3783.

NOTE: AL2000 Series Aluminum Plugmold products are available in an anodized finish with gray receptacles.

* All AL2000 Series Plugmold products include two (2) AL2010B Blank End Fittings and one (1) AL2001 Base Coupling unless otherwise indicated in the product description.

Plugmold AL2000 Series Aluminum Multioutlet Systems Ordering Information

Product	Description/Specifications
---------	----------------------------

Plugmold AL2000 Series

Available in 3' (914mm), 5' (1.5m) and 6' (1.8m) lengths with 6" (152mm), 12" (305mm) and 18" (457mm) receptacle spacing. 15A tamper-resistant receptacles. 3-wire, #12 THHN (1 hot, 1 neutral, and insulated ground conductor). Packed 2 per carton. Each unit supplied with one (1) Coupling and two (2) Blank End Fittings.



CATALOG NO.	FINISH	LENGTH Feet (mm)	WIRING CONFIG	CENTER DISTANCE Inches (mm)	OUTLETS QUANTITY & TYPE
AL20GB306TR	Aluminum	3' (915mm)	GB	6" (152mm)	6 Single 15A
AL20GB506TR	Aluminum	5' (1.5m)	GB	6" (152mm)	10 Single 15A
AL20GB512TR	Aluminum	5' (1.5m)	GB	12" (305mm)	5 Single 15A
AL20GB606TR	Aluminum	6' (1.8m)	GB	6" (152mm)	12 Single 15A
AL20GB612TR	Aluminum	6' (1.8m)	GB	12" (305mm)	6 Single 15A
AL20GB618TR	Aluminum	6' (1.8m)	GB	18" (457mm)	4 Single 15A
AL20GBA606TR	Aluminum	6' (1.8m)	GBA	6" (152mm)	12 Single 15A
AL20GBA612TR	Aluminum	6' (1.8m)	GBA	12" (305mm)	6 Single 15A
AL20GBA618TR	Aluminum	6' (1.8m)	GBA	18" (457mm)	4 Single 15A

Aluminum GFCI Plugmold

GFCI Module provides downstream protection for all outlets and connections. Available in 3' (914mm), 5' (1.5m) and 6' (1.8m) lengths with 6" (152mm) receptacle spacing. 15A tamper-resistant receptacles. 3-wire, #12 THHN (1 hot, 1 neutral, and insulated ground conductor). Packed 2 per carton. Each unit supplied with one (1) Coupling and two (2) Blank End Fittings. GFCI Class A 20A 125V 60Hz.

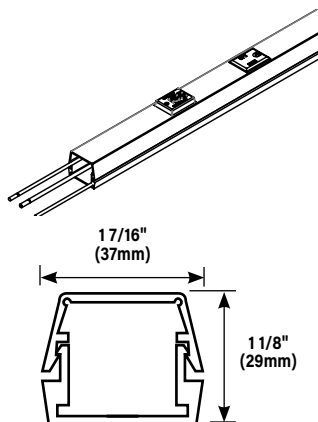

CATALOG NO.	FINISH	LENGTH Feet (mm)	WIRING CONFIG	CENTER DISTANCE Inches (mm)	OUTLETS QUANTITY & TYPE
AL20GB306TRGFI6	Aluminum	3' (915mm)	GB	6" (152mm)	1 GFCI, 5 Single 15A
AL20GB506TRGFI6	Aluminum	5' (1.5m)	GB	6" (152mm)	1 GFCI, 9 Single 15A

NOTE: GFCI module does not contain an outlet.

Plugmold AL2000 Series Steel Multioutlet Systems Ordering Information

Product	Description/Specifications
---------	----------------------------

Aluminum All USB Plugmold

Available in 3' (914mm), and 5' (1.5m) lengths with 12" spacing. USB is 2.4 Amps (shared between two ports) 5VDC. Packed two per carton. Each unit supplied with one (1) Coupling and two (2) Blank End Fittings.



CATALOG NO.	FINISH	LENGTH Feet (mm)	WIRING CONFIG	CENTER DISTANCE Inches (mm)	OUTLETS QUANTITY & TYPE
AL20USB312	Aluminum	3' (915mm)	USB	12" (305mm)	3 USB Modules
AL20USB512	Aluminum	5' (1.5m)	USB	12" (305mm)	5 USB Modules

Aluminum Alternating USB Plugmold

Available in 5' (1.5m) length with 9" spacing. 15A tamper-resistant receptacles. 3-wire, #12 THHN (1 hot, 1 neutral and insulated ground conductor). Packed two per carton. Each unit supplied with one (1) Coupling and two (2) Blank End Fittings. USB Type-A Module is 2.4 Amps (shared between two ports) 5VDC. USB Type-C module is a single 30W Power Delivery port. Please note the charging load on one module will not affect the charging performance of the other USB modules in the product.



CATALOG NO.	FINISH	LENGTH Feet (mm)	WIRING CONFIG	CENTER DISTANCE Inches (mm)	OUTLETS QUANTITY & TYPE
AL20GB509TRUSBA	Aluminum	5' (1.5m)	GB/USB	9"(229mm)	3 Outlets/3USB Modules
AL20GB509TRUAC	Aluminum	5' (1.5m)	GB/USB	9" (229mm)	3 Outlets/2 USB-Amodules/ 1 USB-C Module

NOTE: AL2000 Series Aluminum Plugmold products are available in an anodized finish with gray receptacles.

All AL2000 Series Plugmold products include two (2) AL2010B Blank End Fittings and one (1) AL2001 Base Coupling unless otherwise indicated in the product description.

AL2000/AL2400 Series Aluminum Raceway Fittings Ordering Information

AL2000

Base and Cover – 6063-T5 extruded aluminum, satin anodized finish, .060" (1.5mm) nominal thickness.

Country of Origin: USA

Cross-Sectional Area:
1in² (645mm²)



AL2400

Capacity: 1.7 in.²
(1097mm²)



ITEM	CAT. NO.	LENGTH
Base	AL2000B-5	5' (1.5m)
Cover	AL2000C-5	5' (1.5m)
Base	AL2000B-10	10' (3.m)
Base	AL2400B-5	5' (1.5m)
Cover	AL2400C	5' (1.5m)
Base	AL2400B-10	10' (3.m)

AL2003

Supporting Clip – Mount to surface with No. 8 flathead screws. Use with AL2000 Series.

Country of Origin: USA



AL2000WC AL2400WC

Wire Clip – Holds conductors in place in raceway (nonmetallic).

Country of Origin: USA



W30/W30G

Pressure-Type Wire

Connectors - W30 – For common connection of two, three, or four No. 12 or No.14 solid copper conductors (White).

W30G – For connection of equipment grounding of 2, 3, or 4 solid conductors No. 14 or No. 12 AWG (Green). 300V maximum; 20A 105° C maximum.

Country of Origin: USA

NOTE: Not for use with aluminum conductors.



AL2001 AL2401

Coupling – For joining lengths of raceway. Use with AL2000 Series.

Country of Origin: USA



CAT NO.	L	W
AL2001	1 5/8" (41mm)	1 1/2" (38mm)
AL2401	3" (76mm)	1 3/4" (44mm)

AL2006 AL2406

Cover Clip – For covering joint where lengths of cover or base adjoin. Use with AL2000 Series.

Country of Origin: USA

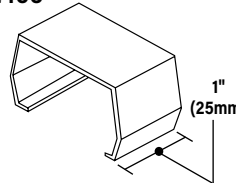

AL2009

Ground Clamp – Use with AL2000 Series.

Country of Origin: USA



AL2010A

End Fitting – With 1/2" hub adapter. Use with AL2000 Series.

Country of Origin: USA



AL2010B

Blank End – Use with AL2000 Series.

Country of Origin: USA



AL2051H AL2451H

Box Adapter – For feeding raceway from an existing wall outlet.

Country of Origin: USA



AL2011 AL2411

90° Flat Elbow – For right angle turn on same surface. Comes with two couplings.

Country of Origin: Mexico

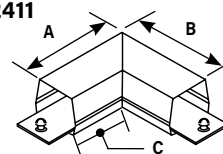

CAT NO.	A	B	C
AL2011	3" (76mm)	3" (76mm)	1 9/16" (40mm)
AL2411	4" (102mm)	4" (102mm)	2" (51mm)

AL2000/AL2400 Series Aluminum Raceway Fittings Ordering Information

**AL2015
AL2415**

Tee – For branch connection of two runs of AL2000 Raceway. Three couplings furnished.

Country of Origin: Mexico



CAT NO.	A	B	C
AL2015	1 7/16" (37mm)	4" (102mm)	1 9/16" (40mm)
AL2415	4" (102mm)	6" (152mm)	2" (51mm)

AL2409

Ground Clamp – Use with AL2400 Series.

Country of Origin: USA



#8 Ground Stud
W/Cup Washer

AL2010B

Blank End – Use with AL2000 Series.

Country of Origin: USA

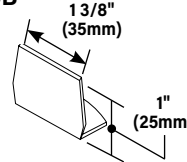

**AL2017
AL2417**

Internal Elbow – For bending around internal corners. Two couplings furnished.

Country of Origin: Mexico

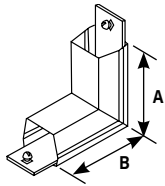

CAT NO.	A
AL2017	3" (76mm)
AL2417	4" (102mm)

AL2410B2

End Fitting – With 1/2" plastic KO. Use with AL2400 Series.

Country of Origin: USA

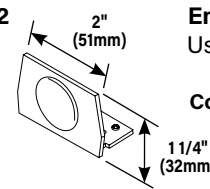

**AL2018
AL2418**

External Elbow – For making 90° external corners. Two couplings furnished.

Country of Origin: Mexico

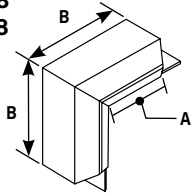

CAT NO.	A	B
AL2018	1 7/8" (48mm)	3" (76mm)
AL2418	3" (76mm)	5" (127mm)

**AL2044
AL2044-2**

Deep Device Box – For receptacles and deep devices such as those of signal and alarm systems. Base has open back plate for mounting to existing wall box and solid back plate insert with 1/2" (AL2000 Raceway) and 3/4" (AL2000 Raceway) KO to close opening.

Country of Origin: USA

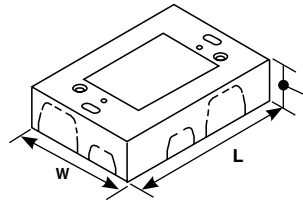

CAT. NO.	L	W	D	GANG #
AL2044	4 5/8" (117mm)	3 1/16" (73mm)	2 1/4" (57mm)	1
AL2044-2	4 5/8" (117mm)	4 27/32" (121mm)	2 1/2" (64mm)	2

AL2038

Round Fixture Box (Solid Base) – Designed for use in hanging fixtures. Cover takes any device with mounting screw centers of 2 3/4", 3 1/2", and 4 1/16" (70mm, 89mm, and 103mm). Base has concentric 1/2" and 3/4" KOs.

Country of Origin: USA

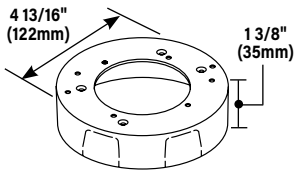

AL2047

Shallow Switch & Receptacle Box

– Designed for standard shallow switches and receptacles. Base has open back plate for mounting to existing wall box and solid back plate insert with 1/2" and 3/4" KO to close opening.

Country of Origin: USA

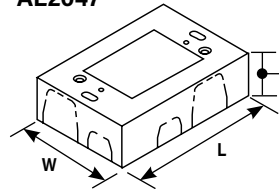

CAT. NO.	L	W	D	GANG #
AL2047	4 5/8" (117mm)	3 1/16" (73mm)	1 3/8" (35mm)	1
AL2047-2	4 5/8" (117mm)	4 27/32" (121mm)	1 3/8" (35mm)	2

AL2040A

In-line Single Pole Switch – Single pole 120V switch. Two couplings furnished.

Country of Origin: Mexico

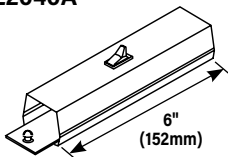

AL2043TR

In-line Receptacle – Two 15A, 120V U-ground factory wired receptacles. Couplings furnished. Receptacles are tamper-resistant.

Country of Origin: USA

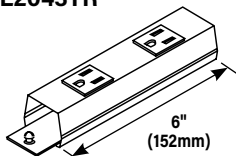

Nonmetallic Plugmold® Multioutlet Assemblies

Nonmetallic Plugmold Multioutlet Systems provides a versatile solution for many applications. Plugmold sections offer single or alternating circuits, standard or isolated ground receptacles, and Snapicoil® harnesses of prewired receptacles or cord ended units.

Nonmetallic Plugmold has a textured ivory finish with duplex receptacles, and can be customized to accommodate virtually any application.



Nonmetallic Plugmold Multioutlet Systems are available in a variety of configurations.

Plugmold NM2000 Series Nonmetallic Multioutlet Systems

Plugmold NM2000 Series Wire Fill Capacities for Power				
CABLE TYPE	WIRE SIZE THHN/THWN	O.D.		NUMBER OF CONDUCTORS (40% FILL) NM2000/NM2400
		Inches	(mm)	
POWER WIRING WITHOUT DEVICES	10 AWG	0.164	(4.2)	15
	12 AWG	0.130	(3.3)	31
	14 AWG	0.111	(2.8)	45
POWER WIRING WITH DEVICES (Plugmold Series)	10 AWG	0.153	(3.9)	-
	12 AWG	0.122	(3.1)	8 *
	14 AWG	0.105	(2.7)	8 *

* Including one hot, neutral, and ground wire from the receptacle.



Plugmold NM2000 Series Nonmetallic Multioutlet Systems

Plugmold NM2000 Series Nonmetallic Part Numbering System

NM2000 Series Nonmetallic Plugmold Series - Example: NM20GB306







N M	2 0	G B	3	0 6
COLOR:	AMPERAGE:	WIRING CONFIGURATION:	LENGTH:	CENTER DISTANCE:
Nonmetallic = NM	20 = 15A 24 = 20A	GB = GB GBA = GBA IG = IG*	48" (1.2m) = 4 60" (1.5m) = 5 72" (1.8m) = 6	9" (229mm) = 9 12" (305mm) = 12 18" (457mm) = 18 30" (760mm) = 30

NOTE: Not all combinations of color, wiring configurations, length, and center distance are available as standard products. For additional information on custom options, contact Wiremold Technical Support at 1-844-957-3783.

NOTE: NM2000 Series Nonmetallic Plugmold products are available in an ivory finish with ivory receptacles.

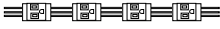
* All NM2000 Series Plugmold products include two (2) NM2010B Blank End Fittings unless otherwise indicated in the product description.

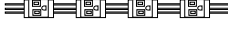
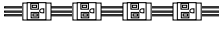
Plugmold NM2000 Series Raceway Wiring Configurations

			With Snapicoil	
				
GB Series: 3-wire, #12 THHN (1 hot, 1 neutral and 1 ground), 1 circuit; has insulated grounding conductor.	GBA Series: 4-wire, #12 THHN (2 hot, 1 neutral and 1 ground), 2 circuit; outlets wired alternately; has insulated grounding conductor.	IG Series: 3-wire, #12 THHN (1 hot, 1 neutral and 1 ground), 1 circuit; has insulated-isolated grounding conductor. Orange receptacles.	GB Series: 3-wire, #12 THHN (1 hot, 1 neutral and 1 ground), 1 circuit; has insulated grounding conductor.	GBA Series: 4-wire, #12 THHN (2 hot, 1 neutral and 1 ground), 2 circuit; outlets wired alternately; has insulated grounding conductor.

NOTE: SNAPICOIL REELS on custom order. Snapicoil harness is available on reels if lengths greater than 50' are needed, or if multiple lengths are required for production-type jobs. The maximum length per reel is 240' for Snapicoil with outlets 12" and 18" on centers; 500' with outlets 30" on center. Packaging includes the necessary number of lengths of base, holecut cover, wire clips, and couplings for complete installation. Price and delivery information should be obtained prior to specifying or ordering. To specify or order, add "R" to the Snapicoil number. Ex: NM20GB12R. Other outlet spacings available on custom order.

Receptacles are made from high impact thermoplastic. Snapicoil packaging includes the necessary lengths of NM2000B Base, NM2000C Hole Cut Cover, NM2000WC Wire Clips, and NM2001 Couplings for complete installation.

Cord-Ended Nonmetallic Plugmold Multioutlet Systems								
CAT NO.	UNIT LENGTH	OUTLETS QUANTITY	CORD SET LENGTH	TYPE	SWITCH	CIRCUIT BREAKER	HOUSING	
NM20-C3	3' (.92m)	3 Duplex	6' (1.8m)	14/3 SJT	Yes	Yes	PVC-Ivory	
NM20-C4	4' (1.2m)	4 Duplex	6' (1.8m)	14/3 SJT	Yes	Yes	PVC-Ivory	
NM20-C5	5' (1.5m)	5 Duplex	6' (1.8m)	14/3 SJT	Yes	Yes	PVC-Ivory	
NM20-C6	6' (1.8m)	6 Duplex	6' (1.8m)	14/3 SJT	Yes	Yes	PVC-Ivory	

Plugmold NM2000 Series Raceway with Snapicoil Harness								
CATALOG NO.	LENGTH	WIRING CONFIG	OUTLETS (15A 120V NEMA 5-15SR) CENTER DISTANCE	QUANTITY	HOLE CUT COVER QUANTITY LENGTH		HOUSING	
NM20GB12	48'	GB	12" (152mm)	24 Duplex	8	6' (1.8m)	PVC-Ivory	
NM20GBA12	48'	GBA	12" (305mm)	24 Duplex	8	6' (1.8m)	PVC-Ivory	

Plugmold NM2000 onmetallic Multioutlet Systems Ordering Information

Product	Description/Specifications																																																																																										
Plugmold NM2000 Series	Available in 4' (1.2m), 5' (1.5m) and 6' (1.8m) lengths with 9" (229mm), 12" (305mm) and 18" (457mm) and 30" (762mm) receptacle spacing. 15A receptacles. 3-wire, #12 THHN (1 hot, 1 neutral, and insulated ground conductor). Packed 2 per carton. Each unit supplied with two (2) Blank End Fittings.																																																																																										
	<table border="1"> <thead> <tr> <th>CATALOG NO.</th> <th>FINISH</th> <th>LENGTH Feet (mm)</th> <th>WIRING CONFIG</th> <th>CENTER DISTANCE Inches (mm)</th> <th>OUTLETS QUANTITY & TYPE</th> </tr> </thead> <tbody> <tr> <td>NM20GB412</td> <td>Nonmetallic</td> <td>4' (1.2m)</td> <td>GB</td> <td>12" (305mm)</td> <td>4 Duplex 15A</td> </tr> <tr> <td>NM20GBA412</td> <td>Nonmetallic</td> <td>4' (1.2m)</td> <td>GBA</td> <td>12" (305mm)</td> <td>4 Duplex 15A</td> </tr> <tr> <td>NM20IG412</td> <td>Nonmetallic</td> <td>4' (1.2 m)</td> <td>GB</td> <td>12" (305mm)</td> <td>4 Duplex 15A</td> </tr> <tr> <td>NM20GB512</td> <td>Nonmetallic</td> <td>5' (1.5m)</td> <td>GB</td> <td>12" (305mm)</td> <td>5 Duplex 15A</td> </tr> <tr> <td>NM20GB515</td> <td>Nonmetallic</td> <td>5' (1.5m)</td> <td>GB</td> <td>15" (381mm)</td> <td>4 Duplex 15A</td> </tr> <tr> <td>NM20GB530</td> <td>Nonmetallic</td> <td>5' (1.5m)</td> <td>GB</td> <td>30" (760mm)</td> <td>2 Duplex 15A</td> </tr> <tr> <td>NM20GBA512</td> <td>Nonmetallic</td> <td>5' (1.5m)</td> <td>GBA</td> <td>12" (305mm)</td> <td>5 Duplex 15A</td> </tr> <tr> <td>NM20IG512</td> <td>Nonmetallic</td> <td>5' (1.5m)</td> <td>IG</td> <td>12" (305mm)</td> <td>5 Duplex 15A</td> </tr> <tr> <td>NM20GB609</td> <td>Nonmetallic</td> <td>6' (1.8m)</td> <td>GB</td> <td>9" (229mm)</td> <td>8 Duplex 15A</td> </tr> <tr> <td>NM20GB612</td> <td>Nonmetallic</td> <td>6' (1.8m)</td> <td>GB</td> <td>12" (305mm)</td> <td>6 Duplex 15A</td> </tr> <tr> <td>NM20GB618</td> <td>Nonmetallic</td> <td>6' (1.8m)</td> <td>GB</td> <td>18" (457mm)</td> <td>4 Duplex 15A</td> </tr> <tr> <td>NM20GBA609</td> <td>Nonmetallic</td> <td>6' (1.8m)</td> <td>GBA</td> <td>9" (229mm)</td> <td>8 Duplex 15A</td> </tr> <tr> <td>NM20GBA612</td> <td>Nonmetallic</td> <td>6' (1.8m)</td> <td>GBA</td> <td>12" (305mm)</td> <td>6 Duplex 15A</td> </tr> <tr> <td>NM20IG612</td> <td>Nonmetallic</td> <td>6' (1.8m)</td> <td>IG</td> <td>12" (305mm)</td> <td>6 Duplex 15A</td> </tr> </tbody> </table>	CATALOG NO.	FINISH	LENGTH Feet (mm)	WIRING CONFIG	CENTER DISTANCE Inches (mm)	OUTLETS QUANTITY & TYPE	NM20GB412	Nonmetallic	4' (1.2m)	GB	12" (305mm)	4 Duplex 15A	NM20GBA412	Nonmetallic	4' (1.2m)	GBA	12" (305mm)	4 Duplex 15A	NM20IG412	Nonmetallic	4' (1.2 m)	GB	12" (305mm)	4 Duplex 15A	NM20GB512	Nonmetallic	5' (1.5m)	GB	12" (305mm)	5 Duplex 15A	NM20GB515	Nonmetallic	5' (1.5m)	GB	15" (381mm)	4 Duplex 15A	NM20GB530	Nonmetallic	5' (1.5m)	GB	30" (760mm)	2 Duplex 15A	NM20GBA512	Nonmetallic	5' (1.5m)	GBA	12" (305mm)	5 Duplex 15A	NM20IG512	Nonmetallic	5' (1.5m)	IG	12" (305mm)	5 Duplex 15A	NM20GB609	Nonmetallic	6' (1.8m)	GB	9" (229mm)	8 Duplex 15A	NM20GB612	Nonmetallic	6' (1.8m)	GB	12" (305mm)	6 Duplex 15A	NM20GB618	Nonmetallic	6' (1.8m)	GB	18" (457mm)	4 Duplex 15A	NM20GBA609	Nonmetallic	6' (1.8m)	GBA	9" (229mm)	8 Duplex 15A	NM20GBA612	Nonmetallic	6' (1.8m)	GBA	12" (305mm)	6 Duplex 15A	NM20IG612	Nonmetallic	6' (1.8m)	IG	12" (305mm)	6 Duplex 15A
	CATALOG NO.	FINISH	LENGTH Feet (mm)	WIRING CONFIG	CENTER DISTANCE Inches (mm)	OUTLETS QUANTITY & TYPE																																																																																					
	NM20GB412	Nonmetallic	4' (1.2m)	GB	12" (305mm)	4 Duplex 15A																																																																																					
	NM20GBA412	Nonmetallic	4' (1.2m)	GBA	12" (305mm)	4 Duplex 15A																																																																																					
	NM20IG412	Nonmetallic	4' (1.2 m)	GB	12" (305mm)	4 Duplex 15A																																																																																					
	NM20GB512	Nonmetallic	5' (1.5m)	GB	12" (305mm)	5 Duplex 15A																																																																																					
	NM20GB515	Nonmetallic	5' (1.5m)	GB	15" (381mm)	4 Duplex 15A																																																																																					
	NM20GB530	Nonmetallic	5' (1.5m)	GB	30" (760mm)	2 Duplex 15A																																																																																					
	NM20GBA512	Nonmetallic	5' (1.5m)	GBA	12" (305mm)	5 Duplex 15A																																																																																					
	NM20IG512	Nonmetallic	5' (1.5m)	IG	12" (305mm)	5 Duplex 15A																																																																																					
	NM20GB609	Nonmetallic	6' (1.8m)	GB	9" (229mm)	8 Duplex 15A																																																																																					
	NM20GB612	Nonmetallic	6' (1.8m)	GB	12" (305mm)	6 Duplex 15A																																																																																					
	NM20GB618	Nonmetallic	6' (1.8m)	GB	18" (457mm)	4 Duplex 15A																																																																																					
	NM20GBA609	Nonmetallic	6' (1.8m)	GBA	9" (229mm)	8 Duplex 15A																																																																																					
	NM20GBA612	Nonmetallic	6' (1.8m)	GBA	12" (305mm)	6 Duplex 15A																																																																																					
NM20IG612	Nonmetallic	6' (1.8m)	IG	12" (305mm)	6 Duplex 15A																																																																																						

Product	Description/Specifications																																																						
Plugmold NM2400 Series	Available in 4' (1.2m), 5' (1.5m) and 6' (1.8m) lengths with 9" (229mm), 12" (305mm) and 18" (457mm) and 30" (762mm) receptacle spacing. 20A receptacles. 3-wire, #12 THHN (1 hot, 1 neutral, and insulated ground conductor). Packed 2 per carton. Each unit supplied with two (2) Blank End Fittings.																																																						
	<table border="1"> <thead> <tr> <th>CATALOG NO.</th> <th>FINISH</th> <th>LENGTH Feet (mm)</th> <th>WIRING CONFIG</th> <th>CENTER DISTANCE Inches (mm)</th> <th>OUTLETS QUANTITY & TYPE</th> </tr> </thead> <tbody> <tr> <td>NM24GB412</td> <td>Nonmetallic</td> <td>4' (1.2m)</td> <td>GB</td> <td>12" (305mm)</td> <td>4 Duplex 20A</td> </tr> <tr> <td>NM24GBA412</td> <td>Nonmetallic</td> <td>4' (1.2m)</td> <td>GBA</td> <td>12" (305mm)</td> <td>4 Duplex 20A</td> </tr> <tr> <td>NM24GB512</td> <td>Nonmetallic</td> <td>5' (1.5m)</td> <td>GB</td> <td>12" (305mm)</td> <td>5 Duplex 20A</td> </tr> <tr> <td>NM24GB530</td> <td>Nonmetallic</td> <td>5' (1.5m)</td> <td>GB</td> <td>30" (760mm)</td> <td>2 Duplex 20A</td> </tr> <tr> <td>NM24GBA512</td> <td>Nonmetallic</td> <td>5' (1.5m)</td> <td>GBA</td> <td>12" (305mm)</td> <td>5 Duplex 20A</td> </tr> <tr> <td>NM24GB612</td> <td>Nonmetallic</td> <td>6' (1.8m)</td> <td>GB</td> <td>12" (305mm)</td> <td>6 Duplex 20A</td> </tr> <tr> <td>NM24GB618</td> <td>Nonmetallic</td> <td>6' (1.8m)</td> <td>GB</td> <td>18" (457mm)</td> <td>4 Duplex 20A</td> </tr> <tr> <td>NM24GBA612</td> <td>Nonmetallic</td> <td>6' (1.8m)</td> <td>GB A</td> <td>12" (305mm)</td> <td>6 Duplex 20A</td> </tr> </tbody> </table>	CATALOG NO.	FINISH	LENGTH Feet (mm)	WIRING CONFIG	CENTER DISTANCE Inches (mm)	OUTLETS QUANTITY & TYPE	NM24GB412	Nonmetallic	4' (1.2m)	GB	12" (305mm)	4 Duplex 20A	NM24GBA412	Nonmetallic	4' (1.2m)	GBA	12" (305mm)	4 Duplex 20A	NM24GB512	Nonmetallic	5' (1.5m)	GB	12" (305mm)	5 Duplex 20A	NM24GB530	Nonmetallic	5' (1.5m)	GB	30" (760mm)	2 Duplex 20A	NM24GBA512	Nonmetallic	5' (1.5m)	GBA	12" (305mm)	5 Duplex 20A	NM24GB612	Nonmetallic	6' (1.8m)	GB	12" (305mm)	6 Duplex 20A	NM24GB618	Nonmetallic	6' (1.8m)	GB	18" (457mm)	4 Duplex 20A	NM24GBA612	Nonmetallic	6' (1.8m)	GB A	12" (305mm)	6 Duplex 20A
	CATALOG NO.	FINISH	LENGTH Feet (mm)	WIRING CONFIG	CENTER DISTANCE Inches (mm)	OUTLETS QUANTITY & TYPE																																																	
	NM24GB412	Nonmetallic	4' (1.2m)	GB	12" (305mm)	4 Duplex 20A																																																	
	NM24GBA412	Nonmetallic	4' (1.2m)	GBA	12" (305mm)	4 Duplex 20A																																																	
	NM24GB512	Nonmetallic	5' (1.5m)	GB	12" (305mm)	5 Duplex 20A																																																	
	NM24GB530	Nonmetallic	5' (1.5m)	GB	30" (760mm)	2 Duplex 20A																																																	
	NM24GBA512	Nonmetallic	5' (1.5m)	GBA	12" (305mm)	5 Duplex 20A																																																	
	NM24GB612	Nonmetallic	6' (1.8m)	GB	12" (305mm)	6 Duplex 20A																																																	
	NM24GB618	Nonmetallic	6' (1.8m)	GB	18" (457mm)	4 Duplex 20A																																																	
	NM24GBA612	Nonmetallic	6' (1.8m)	GB A	12" (305mm)	6 Duplex 20A																																																	

NOTE: NM2000 Series Nonmetallic Plugmold products are available in an ivory finish with ivory receptacles.
 All NM2000 Series Plugmold products include two (2) NM2010B Blank End Fittings and one (1) NM2001 Base Coupling unless otherwise indicated in the product description.

Plugmold NM2000 Series Nonmetallic Multioutlet Systems Ordering Information

NM2000

Base and Cover – Extruded PVC, ivory textured finish.

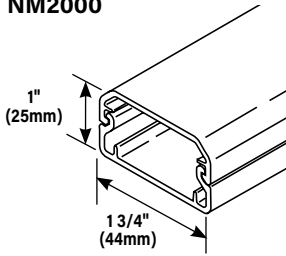

Country of Origin: USA

Cross-Sectional Area:
1.14in² (735mm²)

NM2010B

Blank End Fitting – Use with NM2000 Series.

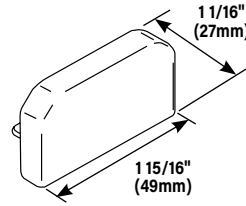

Country of Origin: USA

NM2011

90° Flat Elbow – For right angle turns on same surface.

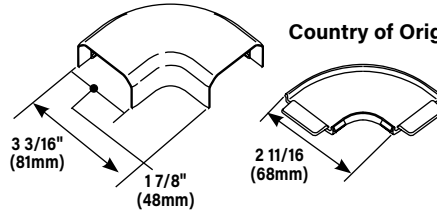

Country of Origin: USA

ITEM	CAT. NO.	LENGTH	MATERIAL
Base	NM2000B	8' (2.4m)	PVC-Ivory
Cover	NM2000C	8' (2.4m)	PVC-Ivory
Base & Cover	NM2000BC	5' (1.52m)	PVC-Ivory

NM2003

Supporting Clip – Mount to surface with No. 8 flathead screw. Use with NM2000 Series.

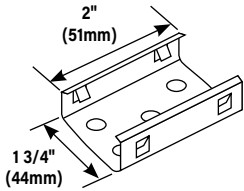

Country of Origin: USA

NM2015

Tee – For branches at right angles.



Country of Origin: USA

W30/W30G

Pressure-Type Wire Connectors – **W30** – For common connection of two, three, or four No. 12 or No.14 solid copper conductors (White). **W30G** – For connection of equipment grounding of 2, 3, or 4 solid conductors No. 14 or No. 12 AWG (Green). 300V maximum; 20A 105° C maximum.



Country of Origin: USA

NOTE: Not for use with aluminum conductors.

NM2017

Internal Elbow – For right turns at inside corners.



Country of Origin: USA

NM2006

Cover Clip – For covering joint where lengths of NM2000 Series cover or base adjoin. Use with NM2000 Series.



Country of Origin: USA

NM2018

External Elbow – Used for making 90° turns at outside corners.

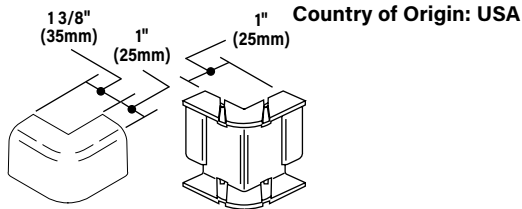

Country of Origin: USA

NM2010A

Entrance End – Has 1/2" trade size KO on end and bottom. Use with NM2000 Series.



Country of Origin: USA

NOTE: NM2000 Series fittings work with both NM20 (15A) and NM24 (20A) Plugmold Multioutlet Systems.

Plugmold NM2000 Series Nonmetallic Multioutlet Systems Ordering Information

NM2051H

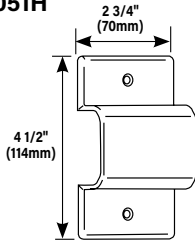

Wall Box Adapter – For feeding raceway from an existing wall outlet; horizontal applications. Provides complete access to wall box for connections.

Country of Origin: USA

**NM2048
NM2048-2**



Sure-Snap® Device Box – Cover snaps onto base, no screws required. Cover has twistouts on all sides. Rectangular KO in base for extension to wall box.

Country of Origin: USA

CAT. NO.	L	W	D	GANG #
NM2048	4 3/4" (121mm)	3" (76mm)	1 3/4" (44mm)	1
NM2048-2	4 3/4" (121mm)	4 7/8" (124mm)	1 3/4" (44mm)	2

NM2051V

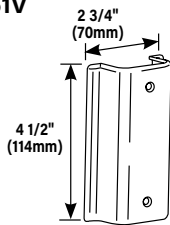

Wall Box Adapter – For feeding raceway from an existing wall outlet; vertical applications. Provides complete access to wall box for connections.

Country of Origin: USA

**NM2027-15
NM2027-20**

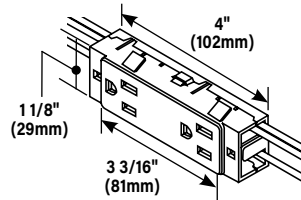

Replacement Receptacles – 15A and 20A replacement devices. 6" (152mm) wire leads each side. Used to replace faulty receptacles in Plugmold Strips, not for installation in blank raceway base.

Country of Origin: USA

NM2044

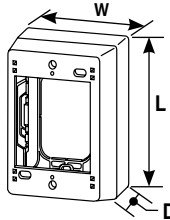

Extra Deep Device Box – For mounting power/communication device when additional depth is required. Has combination twistouts for 2700, 2800, 2900, and NM2000.

Country of Origin: USA

CAT. NO.	L	W	D	GANG #
NM2044	4 3/4" (121mm)	3" (76mm)	2 3/4" (44mm)	1
NM2044-2	4 3/4" (121mm)	4 7/8" (124mm)	2 3/4" (44mm)	2

NOTE: NM2000 Series fittings work with both NM20 (15A) and NM24 (20A) Plugmold Multioutlet Systems.

NOTE: All brand and product names referenced in this document are registered trademarks or trademarks of their respective holders.



Legrand, North America
60 Woodlawn Street
West Hartford, CT 06110
1.877.BY.LEGRAND (295.3472)
www.legrand.us

Canada
905.738.9195
www.legrand.ca

FOLLOW US





Plugmold systems are available in a variety of colors and configurations.

Plugmold® Raceway & Multioutlet Assemblies

Plugmold® Multioutlet Systems are available in a wide variety of lengths and fittings and in a variety of finishes to provide versatile solutions for many applications. Plugmold options include single or alternating circuits, standard or isolated ground receptacles, GFCI protection, tamper-resistant protection, USB charging, Snapicoil® harnesses of prewired receptacles, and cord-ended units.

Plugmold® Multioutlet Systems are available in black or ivory ScuffCoat™ finish, painted white or gray enamel steel, stylish stainless steel, anodized aluminum and durable textured ivory nonmetallic. The painted steel product works with many types of decor and is paintable to integrate with most color schemes. Durable stainless steel and anodized aluminum Plugmold products are corrosion-resistant, making them ideal for labs.

PRODUCTS: PLUGMOLD 2000 SERIES, 2400 SERIES, AL2000 SERIES, NM2000 SERIES, NM2400 SERIES

Features & Benefits

- **Compact, low profile appearance.** Enhanced aesthetics and ideal for installations within minimal spaces.
- **Multiple finishes.** Choose from black or ivory ScuffCoat, white or gray painted enamel or durable stainless steel finishes.
- **USB Charging.** Available with dual-port USB-A modules, sharing 2.4 amps of charging capacity and single-port USB-C module with 30W Power Delivery.
- **Tamper-resistance protection.** Prevents the accidental insertion of foreign objects into receptacles reducing the risk of shocks or electrocution. Meets 2014 NEC section 406 requirements.
- **Single, alternating circuit, and isolated ground wiring options available.** Wiring options to meet virtually any job or environment requirement.
- **Variety of lengths.** Installed power and USB charging in multiple lengths to meet space and location requirements.
- **Full range of fittings.** Provide flexibility for multiple installation options or integrations with 2000 or 2400 Series Raceway systems.
- **Snapicoil harnesses with different lengths and receptacle spacing.** Custom solution available for large or specific use electrical installations.
- **Customization available.** Plugmold products can be modified to accommodate virtually any application or aesthetic need.
- **Receptacle spacing options.** Select the right configuration for your application.
- **cULus Listed.** Safety and reliability in the applications.

Vertical Markets

- Commercial
- Education
- Entertainment
- Healthcare
- Retail
- Hospitality



Compliance

cULus Listed Base & Blank Cover: File E4376 Guide RJBT

Multioutlet Assemblies: File E15191 Guide PVGT

Fittings: File E41751 Guide RJPR

Base & Blank Cover: Meets Article 386 of NEC

Plugmold Strips: Meets Article 380 of NEC

Plugmold Multioutlet Systems Quick Selection Guide

FABRICATION	PROFILE	FINISH OPTIONS	LENGTHS	WIRING CONFIGS.	OUTLET OPTIONS		OPTIONS
					O.C. SPACING	QUANTITY	
Steel	2000 Series	Black Scuffcoat	2' (610mm) *	GB, GB/USB, GBA	6" (152mm)	4 Single	<ul style="list-style-type: none"> Hard-Wired models Cord-Ended models USB Charging models Plug-In model GFCI Protection Tamper-Resistant
		Ivory Scuffcoat	3' (910mm)		9" (229mm)	5 Single	
		Gray Enamel	5' (1.5m)		12" (305mm)	6 Single	
		White Enamel	6' (1.8m)		18" (457mm)	8 Single	
		Stainless Steel			24" (608mm)	10 Single	
						12 Single	
						3 Duplex	
						4 Duplex	
						5 Duplex	
						6 Duplex	
Steel	2400 Series	Ivory Scuffcoat	3' (910mm)	GB, GBA, IG	6" (152mm)	4 Single	<ul style="list-style-type: none"> Hard-Wired models Cord-Ended models
			5' (1.5m)		12" (305mm)	5 Single	
			6' (1.8m)		18" (457mm)	6 Single	
					24" (608mm)	10 Single	
						12 Single	
						3 Duplex	
						4 Duplex	
						5 Duplex	
						6 Duplex	
			Aluminum		AL2000 Series	Anodized	
5' (1.5m)	12" (305mm)	5 Single					
6' (1.8m)	18" (457mm)	6 Single					
		10 Single					
		12 Single					
		12 Single					
Nonmetallic	NM2000 Series	Ivory PVC	4' (1.2m)	GB, GBA, IG	9" (229mm)	2 Duplex	<ul style="list-style-type: none"> Hard-Wired models Cord-Ended models
			5' (1.5m)		12" (305mm)	4 Duplex	
			6' (1.8m)		15" (381mm)	5 Duplex	
					18" (457mm)	6 Duplex	
					30" (760mm)	6 Duplex	
						8 Duplex	
Nonmetallic	NM2400 Series	Ivory PVC	3' (910mm)	GB, GBA	12" (305mm)	2 Duplex	<ul style="list-style-type: none"> Hard-Wired models Cord-Ended models
			4' (1.2m)		18" (457mm)	3 Duplex	
			5' (1.5m)		30" (760mm)	4 Duplex	
			6' (1.8m)			5 Duplex	
						6 Duplex	
						6 Duplex	

Plugmold 2000 Series Steel Multioutlet Systems Ordering Information

Plugmold 2000 Series Steel Part Numbering System

2000 Series Steel Plugmold Series - Example: G20GB306



G

COLOR:

Black = BK
Gray = G
Ivory = V
White = WH
Stainless = S

2 0

RACEWAY:

2000 = 20

G B

WIRING CONFIGURATION:

GB = GB
GBA = GBA

3

LENGTH:

24" (608mm) = 2*
36" (915mm) = 3
60" (1.5m) = 5
72" (1.8m) = 6

0 6

CENTER DISTANCE:

6" (152mm) = 6
9" (229mm) = 9**
12" (305mm) = 12
18" (457mm) = 18

* Stainless steel only.
** 6' lengths only.

NOTE: Not all combinations of color, wiring configurations, length, and center distance are available as standard products. For additional information, contact Wiremold Technical Support at 1-844-957-3783.

NOTE: Color codes: "V" for Ivory ScuffCoat™ finish, "BK" for Black ScuffCoat™ finish, "G" for Gray enamel finish, "WH" for white enamel finish, and "S" for stainless steel. Receptacle colors match extrusion colors except for stainless steel which has black receptacles.

* All 2000 Series Plugmold products include two (2) 2010B Blank End Fittings and one (1) 2001 Base Coupling unless otherwise indicated in the product description.

Steel Plugmold® Multioutlet Systems

Steel Plugmold Multioutlet Systems are available in a wide range of lengths and finishes to provide a versatile solution for many applications. Options include versions with single or alternating circuits, standard receptacles, Snapicoil® harnesses of prewired receptacles, USB charging options, GFCI protection, tamper-resistance, plug-in and cord-ended units.

Steel Plugmold® Multioutlet Systems are available in black or ivory ScuffCoat™ finish, painted white or gray enamel finish, or stylish stainless steel. The enamel finishes work with many types of decor or can be painted to blend with most color schemes. Stainless steel Plugmold raceway is both durable and aesthetically pleasing.



Steel Plugmold systems are available in a variety of colors and configurations.

Plugmold 2000 Series Steel Multioutlet Systems

Plugmold 2000 Series Wire Fill Capacities for Power				
CABLE TYPE	WIRE SIZE THHN/THWN	O.D.		NO. OF CONDUCTORS (40% FILL) 2000
		Inches	(mm)	
POWER WIRING WITHOUT DEVICES	12 AWG	0.130	(3.3)	7*
	14 AWG	0.111	(2.8)	7*
POWER WIRING WITH DEVICES (Plugmold Series)	12 AWG	0.122	(3.1)	5**
	14 AWG	0.105	(2.7)	5**



*Wire capacity limited to maximum of seven conductors due to .025" (.6mm) material thickness of cover.

**Including one hot, neutral, and ground wire from the receptacle.



Steel Plugmold Multioutlet Systems are ideal for use in homes, dormitories and office applications, anywhere convenient access to power or USB charging is needed.

Plugmold 2000 Series Steel Multioutlet Systems Ordering Information

Plugmold 2000 Series Wiring Configurations			
		With Snapicoil 	
GB Series: 3-wire, #12 THHN (1 hot, 1 neutral and 1 ground), 1 circuit; has insulated grounding conductor.	GBA Series: 4-wire, #12 THHN (2 hot, 1 neutral and 1 ground), 2 circuit; outlets wired alternately; has insulated grounding conductor.	GB Series: 3-wire, #12 THHN (1 hot, 1 neutral and 1 ground), 1 circuit; has insulated grounding conductor.	GBA Series: 4-wire, #12 THHN (2 hot, 1 neutral and 1 ground), 2 circuit; outlets wired alternately; has insulated grounding conductor.

NOTE: SNAPICOIL REELS on custom order. Snapicoil harness is available on reels if lengths greater than 50' are needed, or if multiple lengths are required for production-type jobs. The maximum length per reel is 240' for Snapicoil with outlets 12" and 18" on centers; 500' with outlets 30" on center. Packaging includes the necessary number of lengths of base, holecut cover, wire clips, and couplings for complete installation. Price and delivery information should be obtained prior to specifying or ordering. To specify or order, add "R" to the Snapicoil number. Ex: V20GB12R. Other outlet spacings available on custom order.

Receptacles are made from high impact thermoplastic. Snapicoil packaging includes the necessary lengths of 2000B Base, 2000C Hole Cut Cover, 2000WC Wire Clips, and 2001 Couplings for complete installation.

Plugmold 2000 Series Steel Multioutlet Systems Ordering Information

Plugmold 2000 Series Steel with Snapicoil Harness Ordering Information									
CATALOG NO.	LENGTH		WIRING CONFIG	OUTLETS (15A 120V NEMA 5-15SR) CENTER DISTANCE		QUANTITY	HOLE CUT COVER LENGTH		HOUSING
	Feet	(meters)		Inches	(mm)		QUANTITY	Feet	
20GB12*	48'	(14.63)	GB	12"	(305mm)	48 Single	8	6' (1.8m)	Steel - Ivory, Gray
20GB18*	48'	(14.63)	GB	18"	(457mm)	32 Single	8	6' (1.8m)	Steel - Ivory, Gray
V20GB30	50'	(15.25)	GB	30"	(760mm)	20 Single	10	5' (1.5m)	Steel - Ivory
20GBA12*	48'	(14.63)	GBA	12"	(305mm)	48 Single	8	6' (1.8m)	Steel - Ivory, Gray

CUSTOM PLUGMOLD

Plugmold is one of our most frequently requested custom products. From airports, to trains, to classrooms, dormitories or residences, anywhere multiple access to power or USB charging is needed. Custom receptacle spacing options, custom colors, wiring modifications, or any number of custom configurations are available for special applications. Contact the factory to discuss our capabilities and why Plugmold is often the best option for locations requiring multiple access to power or USB charging.



Plugmold 2000 Series Steel Multioutlet Systems Ordering Information

Product	Description/Specifications
---------	----------------------------

GFCI Plugmold

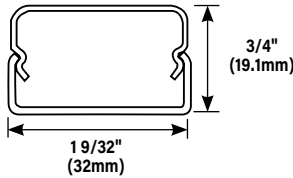
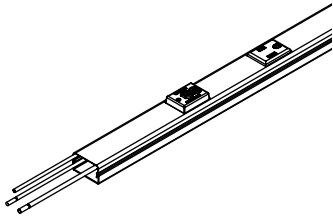

GFCI Module provides downstream protection for all outlets and connections. Available in 3' (914mm), 5' (1.5m) and 6' (1.8m) lengths with 6" (152mm) receptacle spacing. 15A tamper-resistant receptacles. 3-wire, #12 THHN (1 hot, 1 neutral, and insulated ground conductor). .040" (1.0mm) steel housing. Packed 2 per carton. Each unit supplied with one (1) Coupling and two (2) Blank End Fittings. GFCI Class A 20A 125V 60Hz.

CATALOG NO.	FINISH	LENGTH Feet (mm)	WIRING CONFIG	CENTER DISTANCE Inches (mm)	OUTLETS QUANTITY & TYPE
WH20GB306TRGFI6	White	3' (915mm)	GB	6" (152mm)	1 GFCI, 5 Single 15A
BK20GB306TRGFI6	Black	3' (915mm)	GB	6" (152mm)	1 GFCI, 5 Single 15A
V20GB306TRGFI6	Ivory	3' (915mm)	GB	6" (152mm)	1 GFCI, 5 Single 15A
G20GB306TRGFI6	Gray	3' (915mm)	GB	6" (152mm)	1 GFCI, 5 Single 15A
S20GB306TRGFI6	Stainless	3' (915mm)	GB	6" (152mm)	1 GFCI, 5 Single 15A
WH20GB506TRGFI6	White	5' (1.5m)	GB	6" (152mm)	1 GFCI, 9 Single 15A
BK20GB506TRGFI6	Black	5' (1.5m)	GB	6" (152mm)	1 GFCI, 9 Single 15A
V20GB506TRGFI6	Ivory	5' (1.5m)	GB	6" (152mm)	1 GFCI, 9 Single 15A
G20GB506TRGFI6	Gray	5' (1.5m)	GB	6" (152mm)	1 GFCI, 9 Single 15A
S20GB506TRGFI6	Stainless	5' (1.5m)	GB	6" (152mm)	1 GFCI, 9 Single 15A
WH20GB606TRGFI6	White	6' (1.8m)	GB	6" (152mm)	1 GFCI, 11 Single 15A
BK20GB606TRGFI6	Black	6' (1.8m)	GB	6" (152mm)	1 GFCI, 11 Single 15A
V20GB606TRGFI6	Ivory	6' (1.8m)	GB	6" (152mm)	1 GFCI, 11 Single 15A
G20GB606TRGFI6	Gray	6' (1.8m)	GB	6" (152mm)	1 GFCI, 11 Single 15A
S20GB606TRGFI6	Stainless	6' (1.8m)	GB	6" (152mm)	1 GFCI, 11 Single 15A

NOTE: GFCI module does not contain an outlet.

Tamper-Resistant Plugmold

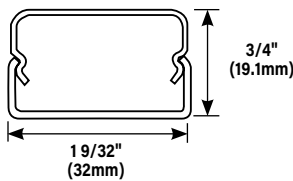
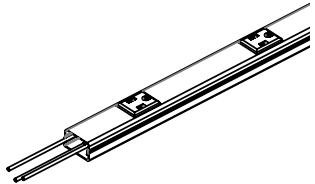

Receptacles prevent the accidental insertion of foreign objects into receptacles reducing the risk of shocks or electrocution. Meets 2014 NEC section 406 requirements. Available in 3' (914mm), 5' (1.5m) and 6' (1.8m) lengths with 6" (152mm) receptacle spacing. 15A tamper-resistant receptacles. | 3-wire, #12 THHN (1 hot, 1 neutral, and insulated ground conductor). .040" (1.0mm) steel housing. Packed 2 per carton. Each unit supplied with one (1) Coupling and two (2) Blank End Fittings.

CATALOG NO.	FINISH	LENGTH Feet (mm)	WIRING CONFIG	CENTER DISTANCE Inches (mm)	OUTLETS QUANTITY & TYPE
WH20GB306TR	White	3' (915mm)	GB	6" (152mm)	6 Single TR 15A
BK20GB306TR	Black	3' (915mm)	GB	6" (152mm)	6 Single TR 15A
V20GB306TR	Ivory	3' (915mm)	GB	6" (152mm)	6 Single TR 15A
G20GB306TR	Gray	3' (915mm)	GB	6" (152mm)	6 Single TR 15A
S20GB306TR	Stainless	3' (915mm)	GB	6" (152mm)	6 Single TR 15A
WH20GB506TR	White	5' (1.5m)	GB	6" (152mm)	9 Single TR 15A
BK20GB506TR	Black	5' (1.5m)	GB	6" (152mm)	9 Single TR 15A
V20GB506TR	Ivory	5' (1.5m)	GB	6" (152mm)	9 Single TR 15A
G20GB506TR	Gray	5' (1.5m)	GB	6" (152mm)	9 Single TR 15A
S20GB506TR	Stainless	5' (1.5m)	GB	6" (152mm)	9 Single TR 15A
WH20GB606TR	White	6' (1.8m)	GB	6" (152mm)	11 Single TR 15A
BK20GB606TR	Black	6' (1.8m)	GB	6" (152mm)	11 Single TR 15A
V20GB606TR	Ivory	6' (1.8m)	GB	6" (152mm)	11 Single TR 15A
G20GB606TR	Gray	6' (1.8m)	GB	6" (152mm)	11 Single TR 15A
S20GB606TR	Stainless	6' (1.8m)	GB	6" (152mm)	11 Single TR 15A

NOTE: Color codes: "V" for Ivory ScuffCoat™ finish, "BK" for Black ScuffCoat™ finish, "G" for Gray enamel finish, "WH" for white enamel finish, and "S" for stainless steel. Receptacle colors match extrusion colors except for stainless steel which has black receptacles and isolated ground versions which have orange receptacles.

All 2000 Series Plugmold products include two (2) 2010B Blank End Fittings and one (1) 2001 Base Coupling unless otherwise indicated in the product description.

Plugmold 2000 Series Steel Multioutlet Systems Ordering Information

USB Plugmold

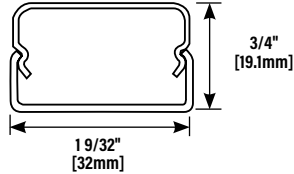
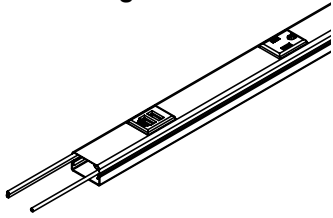

Available in 3' [914mm], 5' [1.5m] and 6' [1.8m] lengths with 6" [152mm] receptacle spacing. 15A tamper-resistant receptacles. 3-wire, #12 THHN (1 hot, 1 neutral, and insulated ground conductor rated for use on 20A circuits). .040" [1.0mm] steel housing. Packed 2 per carton. Each unit supplied with one (1) Coupling and two (2) Blank End Fittings. USB is 2.4 Amp (shared between 2 ports) 5VDC.

USB PLUGMOLD CATALOG NO.	FINISH	LENGTH		WIRING CONFIG	CENTER DISTANCE		OUTLETS QUANTITY & TYPE	
		Feet	[mm]		Inches	[mm]		
BK20GB306TRUSB	Black	3'	[915mm]	GB	6"	[152mm]	1 USB A, 5 Single	15A
BK20GB506TRUSB	Black	5'	[1.5m]	GB	6"	[152mm]	1 USB A, 9 Single	15A
BK20GB606TRUSB	Black	6'	[1.8m]	GB	6"	[152mm]	1 USB A, 11 Single	15A
G20GB306TRUSB	Gray	3'	[915mm]	GB	6"	[152mm]	1 USB A, 5 Single	15A
G20GB506TRUSB	Gray	5'	[1.5m]	GB	6"	[152mm]	1 USB A, 9 Single	15A
G20GB606TRUSB	Gray	6'	[1.8m]	GB	6"	[152mm]	1 USB A, 11 Single	15A
V20GB306TRUSB	Ivory	3'	[915mm]	GB	6"	[152mm]	1 USB A, 5 Single	15A
V20GB506TRUSB	Ivory	5'	[1.5m]	GB	6"	[152mm]	1 USB A, 9 Single	15A
V20GB606TRUSB	Ivory	6'	[1.8m]	GB	6"	[152mm]	1 USB A, 11 Single	15A
S20GB306TRUSB	Stainless	3'	[915mm]	GB	6"	[152mm]	1 USB A, 5 Single	15A
S20GB506TRUSB	Stainless	5'	[1.5m]	GB	6"	[152mm]	1 USB A, 9 Single	15A
S20GB606TRUSB	Stainless	6'	[1.8m]	GB	6"	[152mm]	1 USB A, 11 Single	15A
WH20GB306TRUSB	White	3'	[915mm]	GB	6"	[152mm]	1 USB A, 5 Single	15A
WH20GB506TRUSB	White	5'	[1.5m]	GB	6"	[152mm]	1 USB A, 9 Single	15A
WH20GB606TRUSB	White	6'	[1.8m]	GB	6"	[152mm]	1 USB A, 11 Single	15A

All USB Plugmold

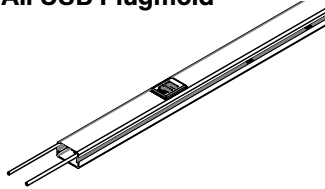

Available in 3' [914mm], and 5' [1.5m] lengths with 12" spacing. USB is 2.4 Amps (shared between two ports) 5VDC. .040" [1.0mm] steel housing. Packed two per carton. Each unit supplied with one (1) Coupling and two (2) Blank End Fittings. Each USB module provides 2 ports with 2.4 Amps of shared charging. Please note the charging load on one module will not affect the charging performance of the other USB modules in the product.

ALL USB PLUGMOLD CATALOG NO.	FINISH	LENGTH		WIRING CONFIG	CENTER DISTANCE		OUTLETS QUANTITY & TYPE	
		Feet	[mm]		Inches	[mm]		
BK20USB312	Black	3'	[915mm]	USB	12"	[305mm]	3 USB A Modules	
BK20USB512	Black	5'	[1.5m]	USB	12"	[305mm]	5 USB A Modules	
G20USB312	Gray	3'	[915mm]	USB	12"	[305mm]	3 USB A Modules	
G20USB512	Gray	5'	[1.5m]	USB	12"	[305mm]	5 USB A Modules	
V20USB312	Ivory	3'	[915mm]	USB	12"	[305mm]	3 USB A Modules	
V20USB512	Ivory	5'	[1.5m]	USB	12"	[305mm]	5 USB A Modules	
S20USB312	Stainless	3'	[915mm]	USB	12"	[305mm]	3 USB A Modules	
S20USB512	Stainless	5'	[1.5m]	USB	12"	[305mm]	5 USB A Modules	
WH20USB312	White	3'	[915mm]	USB	12"	[305mm]	3 USB A Modules	
WH20USB512	White	5'	[1.5m]	USB	12"	[305mm]	5 USB A Modules	

Alternating USB Plugmold

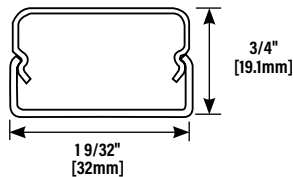
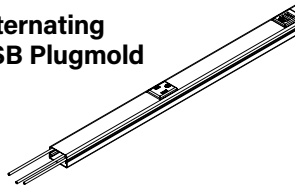

Available in 5' [1.5m] length with 9" spacing. 15A tamper-resistant receptacles. 3-wire, #12 THHN (1 hot, 1 neutral, and insulated ground conductor rated for use on 20A circuits). .040" [1.0 mm] steel housing. Packed two per carton. Each unit supplied with one (1) Coupling and two (2) Blank End Fittings. USB is 2.4 Amps (shared between two ports) 5VDC. Please note the charging load on one module will not affect the charging performance of the other USB modules in the product.

ALTERNATING USB PLUGMOLD CATALOG NO.	FINISH	LENGTH		WIRING CONFIG	CENTER DISTANCE		OUTLETS QUANTITY & TYPE	
		Feet	[mm]		Inches	[mm]		
BK20GB509TRUSBA	Black	5'	[1.5m]	GB/USB	9"	[229mm]	3 Outlets/3 USB A Modules	
G20GB509TRUSBA	Gray	5'	[1.5m]	GB/USB	9"	[229mm]	3 Outlets/3 USB A Modules	
V20GB509TRUSBA	Ivory	5'	[1.5m]	GB/USB	9"	[229mm]	3 Outlets/3 USB A Modules	
S20GB509TRUSBA	Stainless	5'	[1.5m]	GB/USB	9"	[229mm]	3 Outlets/3 USB A Modules	
WH20GB509TRUSBA	White	5'	[1.5m]	GB/USB	9"	[229mm]	3 Outlets/3 USB A Modules	
BK20GB509TRUAC	Black	5'	[1.5m]	GB/USB	9"	[229mm]	3 Outlets/2 USB A & 1 USB C Modules	
G20GB509TRUAC	Gray	5'	[1.5m]	GB/USB	9"	[229mm]	3 Outlets/2 USB A & 1 USB C Modules	
V20GB509TRUAC	Ivory	5'	[1.5m]	GB/USB	9"	[229mm]	3 Outlets/2 USB A & 1 USB C Modules	
S20GB509TRUAC	Stainless	5'	[1.5m]	GB/USB	9"	[229mm]	3 Outlets/2 USB A & 1 USB C Modules	
WH20GB509TRUAC	White	5'	[1.5m]	GB/USB	9"	[229mm]	3 Outlets/2 USB A & 1 USB C Modules	

NOTE: Color codes: "V" for Ivory ScuffCoat™ finish, "BK" for Black ScuffCoat™ finish, "G" for Gray enamel finish, "WH" for white enamel finish, and "S" for stainless steel. Receptacle colors match extrusion colors except for stainless steel which has black receptacles and isolated ground versions which have orange receptacles. All 2000 Series Plugmold products include two (2) 2010B Blank End Fittings and one (1) 2001 Base Coupling unless otherwise indicated in the product description.

Plugmold 2000 Series Steel Multioutlet Systems Ordering Information

Cord-Ended Plugmold 2000 Series Steel Ordering Information							
CAT NO.	UNIT LENGTH	OUTLETS QUANTITY	CORD SET LENGTH	TYPE	SWITCH	CIRCUIT BREAKER	FINISH
20-C2*	3' 4" (1m)	6 Single	6' (1.8m)	12/3 SJT	No	Yes	Steel - Gray, Ivory

* Use "V" prefix for Ivory ScuffCoat™ finish and "G" prefix for Gray enamel finish.

V2000BC (Ivory)
WH2000BC (White)
G2000BC (Gray)
BK2000BC (Black)
S2000BC (Stainless Steel)

Base and Cover - 2000B Base:
.040" (1.0mm) steel; 2000C
Cover: .025" (.6mm) steel.
Packed ten 5' (1.5m) lengths of each per carton.



W30/W30G



Pressure-Type Wire

Connectors - This part comes with both 16-W30 and 8-W30G. W30 - For common connection of two, three, or four No. 12 or No.14 solid copper conductors. W30G - For connection of equipment grounding of two, three, or four No.12 or No. 14 AWG solid conductors. 300V maximum; 20A 105° C maximum.

NOTE: Not for use with aluminum conductors.

V2000B-5 (Ivory)
WH2000B-5 (White)
G2000B-5 (Gray)

Raceway Base - .040" (1.0mm) steel. Packed twenty 5' (1.5m) lengths per carton.



2000WC



Wire Clip (Plated) - Use when conductors bypass receptacles. Not UL Listed.

V2000B-10 (Ivory)
WH2000B-10 (White)

Raceway Base - .040" (1.0mm) steel. Packed ten 10' (3.05m) lengths per carton.



2001



Coupling (Galvanized Steel) - Joins lengths of 2000 Series Raceway Base.

V2000C (Ivory)
WH2000C (White)
G2000C (Gray)

Raceway Cover - .025" (.6mm) steel. Packed twenty 5' (1.5m) lengths per carton. Has no receptacle hole cuts.

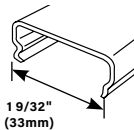

V2003 (Ivory)
2003 (Plated Finish)



2003 Supporting Clip - Temporary support, while positioning lengths of raceway base. Use with 2000 Series Raceway.

- 2003 mounted on surface with No. 6 flathead screw.
- Plugmold 2000 snaps into 2003 Supporting Clip.

620



Raceway Base and Cover Cutter - Portable cutter for both 2000 Base and Cover.

V2006 (Ivory)
WH2006 (White)
G2006 (Gray)
BK2006 (Black)
S2006 (Stainless Steel)

2006 Cover Clip - Covers seam where lengths of cover or base meet.

620BCK

Replacement Blade Kit - Replacement blades and die set for 620 Cutter.

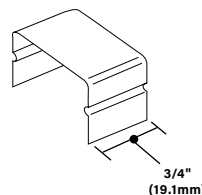

2000 Series Steel Raceway Fittings Ordering Information

2009



Ground Clamp (Galvanized) - Connects equipment grounding conductor to provide an additional ground to raceway.



V2010A3 (Ivory)
WH2010A3 (White)
G2010A3 (Gray)
BK2010A3 (Black)

2010A3 Entrance End Fitting - Offers larger capacity than V2010A2. 1/2" trade size KOs on end, each side and bottom. 3/4" trade size KOs on bottom and rear. Includes ground screw.

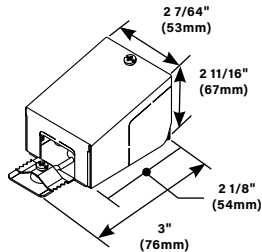

V2010A2 (Ivory)
WH2010A2 (White)
G2010A2 (Gray)
BK2010A2 (Black)
S2010A2 (Stainless Steel)

2010A2 Entrance End Fitting - Smallest entrance end fitting for connecting Plugmold 2000TR Series with 1/2" trade size conduit and armored cable connectors. 1/2" trade size KOs on end, each side and bottom. Includes ground screw.



V2010B (Ivory)
WH2010B (White)
G2010B (Gray)
BK2010B (Black)
S2010B (Stainless Steel)

Blank End - Closes off open end of 2000 Series Raceway.



V2011 (Ivory)
WH2011 (White)
G2011 (Gray)
BK2011 (Black)
S2011 (Stainless Steel)

90° Flat Elbow - Right angle turns on same surface. Cover stop permits neat butting of 2000C Cover. Two couplings furnished.



V2015 (Ivory)
WH2015 (White)
G2015 (Gray)
BK2015 (Black)



Tee - Branches raceway at right angles. Couplings furnished.

2017TC



Internal Corner Coupling - Furnished with one fiber bushing.

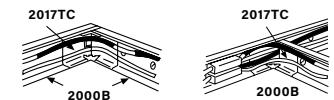

1. 2017TC used as a corner coupling.
2. 2017TC used as a corner coupling and a straight-through fitting.

V2018C (Ivory)
WH2018C (White)
G2018C (Gray)
BK2018C (Black)
S2018C (Stainless Steel)

External Elbow Cover - Continues raceway runs around outside corner. Fills the gap when external corner is made by notching and bending the 2000 Base.



Corner Gap Filler snapped into place in 2018C.



V2048 (Ivory)
WH2048 (White)
G2048 (Gray)
BK2048 (Black)
S2048 (Stainless Steel)

Single-Gang Device Box - Cover has twistouts for 2000, 500 and 700 Series Raceways. Base has 1/2" trade size KO and rectangular KO for extension to wall box. Base has No. 10 threaded hole for ground connection.



2000 Series Steel Raceway Fittings Ordering Information

V2048-2 (Ivory)
WH2048-2 (White)
G2048-2 (Gray)
BK2048-2 (Black)



Two-Gang Device Box - Cover has twistouts for 2000, 500 and 700 Series Raceways. Base has 1/2" trade size KO and rectangular KO for extension to wall box. Base has No.10 threaded hole for ground connection.

V2089



Side Reducing Connector - connects 2000 Series Plugmold with 500 Series Raceway through the side of 2000 Series Plugmold.

V2051H (Ivory)
WH2051H (White)
G2051H (Gray)
BK2051H (Black)
S2051H (Stainless Steel)



Flush Plate Adapter - Feeds 2000 Series Plugmold from an existing wall outlet. Equipped with 1/2" (12.7mm) threaded stud, toothed lock washer for grounding, threaded hole for and conduit bushing.

V2089E



End Reducing Connector - Connects 2000 Series Plugmold with 500 Series Raceway through the end of 2000 Series Plugmold.



Plugmold 2000 extended from wall outlet using 2051H.



2051H fastened to horizontally mounted wall box.



2051H fastened to vertically mounted wall box.

V20-C2 (6 Foot Cord)
G20-C2 (15 Foot Cord)



Plug-In Outlet Center Unit - Six outlets, steel housing with ivory (V20-C2) or gray finish (G20-C2). 6' (1.8m) cord. Length 40" (1m). Receptacle center-to-center 6" (152mm).

2000 Series Interconnectivity Fittings

CONNECTION REQUIRED		USE CATALOG NUMBER
FROM	TO	
500 Series Raceway	Side of Plugmold 2000 Series	V2089, V2048, V2048-2
500 Series Raceway	End of Plugmold 2000 Series	V2089E, V2048, V2048-2
Existing Outlet	Plugmold 2000 Series	V2051H
1/2" trade size Conduit or Armored Cable	End of Plugmold 2000 Series	V2010A2, V2010A3

Plugmold 2400 Series Steel Multioutlet Systems

2400 Series Plugmold Wire Fill Capacities for Power				
CABLE TYPE	WIRE SIZE THHN/THWN	O.D.		NO. OF CONDUCTORS (40% FILL) 2400
		Inches	(mm)	
POWER WIRING WITHOUT DEVICES	10 AWG	0.166	(4.2)	26
	12 AWG	0.130	(3.3)	41
	14 AWG	0.111	(2.8)	57
POWER WIRING WITH DEVICES (Plugmold Series)	8 AWG	0.218	(5.5)	2
	10 AWG	0.153	(3.9)	6
	12 AWG	0.122	(3.1)	10
	14 AWG	0.105	(2.7)	-



Plugmold 2400 Series Steel Part Numbering System

2400 Series Steel Plugmold Series w/Simplex Receptacle - Example: 24GBA512

	V	24	G B A	5	12
COLOR:	RACEWAY:	WIRING CONFIGURATION:	LENGTH:	CENTER DISTANCE:	
Ivory = V	2400 = 24	GB = GB GBA = GBA	36" (915mm) = 3 60" (1.5m) = 5 72" (1.8m) = 6	6" (152mm) = 6 12" (305mm) = 12 18" (457mm) = 18	

2400 Series Steel Plugmold Series w/Duplex Receptacle - Example: 24SGBX3618I

24S	36	18	G B X	99IV
RACEWAY:	LENGTH:	CENTER DISTANCE:	WIRING CONFIGURATION:	COLOR:
2400 = 24S	36" (915mm) = 36 60" (1.5m) = 60 72" (1.8m) = 72	12" (305mm) = 12 18" (457mm) = 18 24" (610mm) = 24	GBX = GBX GBA = GBA IGX = IGX	Ivory = 99IV

NOTE: Not all combinations of color, wiring configurations, length, and center distance are available as standard products. For additional information, contact Wiremold Technical Support at 1-844-957-3783.

NOTE: Color codes: "V" for Ivory ScuffCoat™ finish. Receptacle colors match extrusion colors except for isolated ground versions which have orange receptacles.

* All 2400 Series Plugmold products include two (2) 2410B Blank End Fittings and one (1) 2401 Base Coupling unless otherwise indicated in the product description.

Plugmold 2400 Series Steel Multioutlet Systems Ordering Information

Product	Description/Specifications
---------	----------------------------

Plugmold 2400 Series

Available in 3' (914mm), 5' (1.5m) and 6' (1.8m) lengths with 6" (152mm), 12" (305mm), 18" (457mm) and 24" (608mm) receptacle spacing. 20A receptacles. 3-wire, #12 THHN (1 hot, 1 neutral, and insulated ground conductor). .040" (1.0mm) steel housing. Packed 2 per carton. Each unit supplied with one (1) Coupling and two (2) Blank End Fittings.



CATALOG NO.	FINISH	LENGTH Feet (mm)	WIRING CONFIG	CENTER DISTANCE Inches (mm)	OUTLETS QUANTITY & TYPE
V24GB306	Ivory	3' (915mm)	GB	6" (152mm)	6 Single 20A
24S3612GBX99IV	Ivory	3' (915mm)	GB	12" (305mm)	3 Duplex 20A
24S3612GBA99IV	Ivory	3' (915mm)	GBA	12" (305mm)	3 Duplex 20A
V24GB506	Ivory	5' (1.5m)	GB	6" (152mm)	10 Single 20A
V24GB512	Ivory	5' (1.5m)	GB	12" (305mm)	5 Single 20A
V24GBA512	Ivory	5' (1.5m)	GBA	12" (305mm)	5 Single 20A
24S6012GBX99IV	Ivory	5' (1.5m)	GB	12" (305mm)	5 Duplex 20A
24S6012GBA99IV	Ivory	5' (1.5m)	GBA	12" (305mm)	5 Duplex 20A
24S6012IGX99IV	Ivory	5' (1.5m)	IG	12" (305mm)	5 Duplex 20A
V24GB606	Ivory	6' (1.8m)	GB	6" (152mm)	12 Single 20A
V24GB612	Ivory	6' (1.8m)	GB	12" (305mm)	6 Single 20A
V24GBA612	Ivory	6' (1.8m)	GBA	12" (305mm)	6 Single 20A
V24GB618	Ivory	6' (1.8m)	GB	18" (457mm)	4 Single 20A
V24GBA618	Ivory	6' (1.8m)	GBA	18" (457mm)	4 Single 20A
24S7212GBX99IV	Ivory	6' (1.8m)	GB	12" (305mm)	6 Duplex 20A
24S7224GBA99IV	Ivory	6' (1.8m)	GBA	24" (608mm)	3 Duplex 20A
24S7218GBX99IV	Ivory	6' (1.8m)	GB	18" (457mm)	4 Duplex 20A
24S7224GBX99IV	Ivory	6' (1.8m)	GB	24" (608mm)	3 Duplex 20A
24S7218IGX99IV	Ivory	6' (1.8m)	IG	18" (457mm)	4 Duplex 20A
24S7212IGX99IV	Ivory	6' (1.8m)	IG	12" (305mm)	6 Duplex 20A
24S7224IGX99IV	Ivory	6' (1.8m)	IG	24" (608mm)	3 Duplex 20A
24S7212GBA99IV	Ivory	6' (1.8m)	GBA	12" (305mm)	6 Duplex 20A
24S7218GBA99IV	Ivory	6' (1.8m)	GBA	18" (457mm)	4 Duplex 20A

NOTE: Color codes: "V" for Ivory ScuffCoat™ finish. Receptacle colors match extrusion colors except for isolated ground versions which have orange receptacles.

All 2400 Series Plugmold products include two (2) 2410B Blank End Fittings and one (1) 2401 Base Coupling unless otherwise indicated in the product description.

2400 Series Plugmold Wiring Configurations

			With Snapicoil	
<p>GB Series: 3-wire, #12 THHN (1 hot, 1 neutral and 1 ground), 1 circuit; has insulated grounding conductor.</p>	<p>GBA Series: 4-wire, #12 THHN (2 hot, 1 neutral and 1 ground), 2 circuit; outlets wired alternately; has insulated grounding conductor.</p>	<p>IG Series: 3-wire, #12 THHN (1 hot, 1 neutral and 1 ground), 1 circuit; has insulated-isolated grounding conductor. Orange receptacles.</p>	<p>GB Series: 3-wire, #12 THHN (1 hot, 1 neutral and 1 ground), 1 circuit; has insulated grounding conductor.</p>	<p>GBA Series: 4-wire, #12 THHN (2 hot, 1 neutral and 1 ground), 2 circuit; outlets wired alternately; has insulated grounding conductor.</p>

NOTE: SNAPICOIL REELS on custom order. Snapicoil harness is available on reels if lengths greater than 50' are needed, or if multiple lengths are required for production-type jobs. The maximum length per reel is 240' for Snapicoil with outlets 12" and 18" on centers; 500' with outlets 30" on center. Packaging includes the necessary number of lengths of base, holecut cover, wire clips, and couplings for complete installation. Price and delivery information should be obtained prior to specifying or ordering. To specify or order, add "R" to the Snapicoil number. Ex: V24GB12R. Other outlet spacings available on custom order.

Receptacles are made from high impact thermoplastic. Snapicoil packaging includes the necessary lengths of 2400B Base, 2400C Hole Cut Cover, 2400WC Wire Clips, and 2401 Couplings for complete installation.

2400 Series Steel Raceway Fittings Ordering Information

V2400



Base and Cover –
Base – V2400B .040" (1.0mm) steel.
Cover – V2400C .040" (1.0mm) steel.
Also available in custom colors.

Country of Origin: USA

Cross-Sectional Area:
1.39in² (897mm²)

ITEM	CAT. NO.	LENGTH	MATERIAL
Base	V2400B	5' (1.5m)	.040 Steel
Cover	V2400C	5' (1.5m)	.025 Steel
Base & Cover	V2400BC	5' (1.5m)	.025 Steel

V2410C



Entrance End Fitting – Has 1/2" and 3/4" trade size KOs on end and bottom. Additional 1/2" trade size KO on sides.

Country of Origin: USA

V2411M



90° Flat Elbow – For right angle turns on the same surface (nonmetallic cover).

Country of Origin: USA

2401



Coupling – For joining lengths of raceway. Use with V2400 Series.

Country of Origin: USA

V2417M



Internal Elbow – For making internal 90° corners. All steel construction.

Country of Origin: USA

2400WC

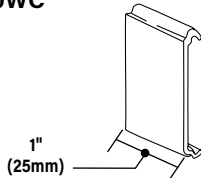

Wire Clip – Holds conductors in place in raceway.

Country of Origin: USA

V2418M



External Elbow – For covering outside corners (nonmetallic cover).

Country of Origin: USA

V2406



Cover Clip – For covering joint where lengths of cover or base adjoin. Use with V2400 Series (nonmetallic).

Country of Origin: USA

V2451H

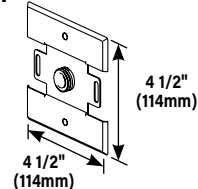

Back Feed Fitting – For feeding 2400 Series Raceway from an existing outlet box. Equipped with 1/2" trade size male bushing and locknut washer for grounding.

Country of Origin: USA

2409



Ground Clamp – No. 10 ground screw provided. Use with V2400 Series Raceway.

Country of Origin: USA

V2448 V2448-2



Device Box – Base has 1/2" trade size KO and rectangular KO for extension to wall box. Has #10 threaded hole for ground connection. Cover has twistouts for 500/700 Series Raceway on each end and twistouts for 2400 Series Raceway on each side.

Country of Origin: USA

V2410A



Entrance End – For connecting V2400 with 1/2" trade size conduit and armored cable. Use with V2400 Series Raceway.

Country of Origin: USA

CAT. NO.	L	W	D	GANG #
V2448	4 5/8" (117mm)	2 7/8" (73mm)	1 3/4" (44mm)	1
V2448-2	4 3/4" (121mm)	4 3/4" (121mm)	1 3/4" (44mm)	2

V2410B

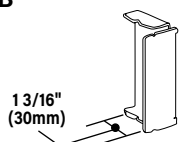

Blank End – For closing open end of V2400 Series Raceway.

Country of Origin: USA

2400 Series Steel Raceway Fittings Ordering Information

V2444
V2444-2



Extra Deep Device Box – Base has rectangular knockout to enable extension from existing single-gang flush wall box and 1/2" and 1" concentric KOs. Cover has twistouts for 500/700 Series Raceway on each end and twistouts for 2400 Series Raceway on each side.

Country of Origin: USA

CAT. NO.	L	W	D	GANG #
V2444	4 5/8" (117mm)	2 7/8" (73mm)	2 3/4" (44mm)	1
V2444-2	4 3/4" (121mm)	4 3/4" (121mm)	2 3/4" (44mm)	2

V2489



Side Reducing Connector – For connecting V2400 Series Raceway with V500 Series Raceway.

Country of Origin: USA

624



2400 and 2400BD Raceway & Cover Cutter – Portable cutter for 2400B and 2400BD Raceway and Cover. Tooled steel construction for clean and easy square cuts. Total manual operation.

Country of Origin: USA

624BCK

Replacement Blade Kit – Replacement blades and die set for 624 Cutter.

Country of Origin: USA

V2427GA



Duplex Receptacle – 3-wire, 15A, 125V, NEMA 5-15R. Provided with 10 1/2" (267mm) pigtails and inline splice connectors.

Country of Origin: USA

V2427GT



Duplex Receptacle – 3-wire, 20A, 125V, NEMA 5-20R. Provided with 10 1/2" (267mm) pigtails and inline splice connectors.

Country of Origin: USA

2686FO



FiberReady Transition Feed Fitting – Eliminates offsetting V2400 in connecting with surface panel boxes. Has 3/4" and 1" concentric trade size KOs with 1" trade size KO elongated so adjustment from surface to center of bushing is 1" (25mm) minimum to 1 5/8" (41mm) maximum. Has twistouts for transition to Pancake 1500 and 2600 Series Raceway.

Country of Origin: USA

IG2427GA



Isolated Ground Duplex Receptacle – 3-wire, 15A, 125V NEMA 5-15R. Provided with 10 1/2" (267mm) pigtails and inline splice connectors.

Country of Origin: USA

IG2427GT



Isolated Ground Duplex Receptacle – 3-wire, 20A, 125V NEMA 5-20R. Provided with 10 1/2" (267mm) pigtails and inline splice connectors.

Country of Origin: USA

V2426



Lamp Holder – Medium base lamp holder 660W, 250V. Black, general purpose phenolic.

Country of Origin: USA

Aluminum Plugmold® Multioutlet Systems

Aluminum Plugmold® Multioutlet Systems offer an attractive choice for hospital and commercial labs, as well as for residential applications. The durable finish offers both aesthetics and corrosion resistance. Aluminum Plugmold Series is available in single and alternating circuits, with standard or isolated ground tamper-resistant receptacles. It can also be customized to meet virtually any job requirement.



The durable corrosion-resistant finish of Aluminum Plugmold Series makes it an ideal solution for use in laboratories.

Plugmold AL2000 Series Wire Fill Capacities for Power

CABLE TYPE	WIRE SIZE THHN/THWN	O.D.		NO. OF CONDUCTORS (40% FILL) AL2000
		Inches	(mm)	
POWER WIRING WITHOUT DEVICES	8 AWG	0.216	(5.5)	12
	10 AWG	0.166	(4.2)	24
	12 AWG	0.130	(3.3)	38
	14 AWG	0.111	(2.8)	51
POWER WIRING WITH DEVICES (Plugmold Series)	8 AWG	0.218	(5.5)	-
	10 AWG	0.153	(3.9)	3
	12 AWG	0.122	(3.1)	6
	14 AWG	0.105	(2.7)	8

Plugmold AL2400 Series Wire Fill Capacities for Power

CABLE TYPE	WIRE SIZE THHN/THWN	O.D.		NO. OF CONDUCTORS (40% FILL) AL2000
		Inches	(mm)	
POWER WIRING WITHOUT DEVICES	6 AWG	0.254	(6.5)	13
	8 AWG	0.216	(5.5)	18
	10 AWG	0.164	(4.2)	37
	12 AWG	0.130	(3.3)	58
	14 AWG	0.111	(2.8)	78
POWER WIRING WITH DEVICES (Plugmold Series)	6 AWG	0.254	(6.5)	3
	8 AWG	0.216	(5.5)	4
	10 AWG	0.164	(4.2)	8
	12 AWG	0.130	(3.3)	12
	14 AWG	0.111	(2.8)	16

Plugmold AL2000 Series Steel Multioutlet Systems Ordering Information

Plugmold AL2000 Series Aluminum Part Numbering System

AL2000 Series Aluminum Plugmold Series – Example: AL20GB306TR



AL	20	GB	3	06	TR
COLOR:	RACEWAY:	WIRING CONFIGURATION:	LENGTH:	CENTER DISTANCE:	TYPE:
Aluminum = AL 2000 = 20	GB = GB GBA = GBA IG = IG*	24" (608mm) = 2 36" (915mm) = 3 60" (1.5m) = 5 72" (1.8m) = 6	6" (152mm) = 6 9" (229mm) = 9 12" (305mm) = 12 18" (457mm) = 18	Tamper-Resistant = TR	

NOTE: Not all combinations of color, wiring configurations, length, and center distance are available as standard products. For additional information on custom options, contact Wiremold Technical Support at 1-844-957-3783.

NOTE: AL2000 Series Aluminum Plugmold products are available in an anodized finish with gray receptacles.

* All AL2000 Series Plugmold products include two (2) AL2010B Blank End Fittings and one (1) AL2001 Base Coupling unless otherwise indicated in the product description.

Plugmold AL2000 Series Aluminum Multioutlet Systems Ordering Information

Product	Description/Specifications
---------	----------------------------

Plugmold AL2000 Series

Available in 3' (914mm), 5' (1.5m) and 6' (1.8m) lengths with 6" (152mm), 12" (305mm) and 18" (457mm) receptacle spacing. 15A tamper-resistant receptacles. 3-wire, #12 THHN (1 hot, 1 neutral, and insulated ground conductor). Packed 2 per carton. Each unit supplied with one (1) Coupling and two (2) Blank End Fittings.



CATALOG NO.	FINISH	LENGTH Feet (mm)	WIRING CONFIG	CENTER DISTANCE Inches (mm)	OUTLETS QUANTITY & TYPE
AL20GB306TR	Aluminum	3' (915mm)	GB	6" (152mm)	6 Single 15A
AL20GB506TR	Aluminum	5' (1.5m)	GB	6" (152mm)	10 Single 15A
AL20GB512TR	Aluminum	5' (1.5m)	GB	12" (305mm)	5 Single 15A
AL20GB606TR	Aluminum	6' (1.8m)	GB	6" (152mm)	12 Single 15A
AL20GB612TR	Aluminum	6' (1.8m)	GB	12" (305mm)	6 Single 15A
AL20GB618TR	Aluminum	6' (1.8m)	GB	18" (457mm)	4 Single 15A
AL20GBA606TR	Aluminum	6' (1.8m)	GBA	6" (152mm)	12 Single 15A
AL20GBA612TR	Aluminum	6' (1.8m)	GBA	12" (305mm)	6 Single 15A
AL20GBA618TR	Aluminum	6' (1.8m)	GBA	18" (457mm)	4 Single 15A

Aluminum GFCI Plugmold

GFCI Module provides downstream protection for all outlets and connections. Available in 3' (914mm), 5' (1.5m) and 6' (1.8m) lengths with 6" (152mm) receptacle spacing. 15A tamper-resistant receptacles. 3-wire, #12 THHN (1 hot, 1 neutral, and insulated ground conductor). Packed 2 per carton. Each unit supplied with one (1) Coupling and two (2) Blank End Fittings. GFCI Class A 20A 125V 60Hz.

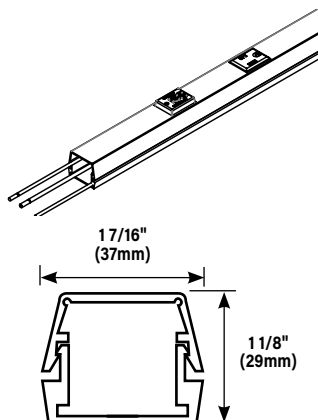

CATALOG NO.	FINISH	LENGTH Feet (mm)	WIRING CONFIG	CENTER DISTANCE Inches (mm)	OUTLETS QUANTITY & TYPE
AL20GB306TRGFI6	Aluminum	3' (915mm)	GB	6" (152mm)	1 GFCI, 5 Single 15A
AL20GB506TRGFI6	Aluminum	5' (1.5m)	GB	6" (152mm)	1 GFCI, 9 Single 15A

NOTE: GFCI module does not contain an outlet.

Plugmold AL2000 Series Steel Multioutlet Systems Ordering Information

Product	Description/Specifications
---------	----------------------------

Aluminum All USB Plugmold

Available in 3' (914mm), and 5' (1.5m) lengths with 12" spacing. USB is 2.4 Amps (shared between two ports) 5VDC. Packed two per carton. Each unit supplied with one (1) Coupling and two (2) Blank End Fittings.



CATALOG NO.	FINISH	LENGTH Feet (mm)	WIRING CONFIG	CENTER DISTANCE Inches (mm)	OUTLETS QUANTITY & TYPE
AL20USB312	Aluminum	3' (915mm)	USB	12" (305mm)	3 USB Modules
AL20USB512	Aluminum	5' (1.5m)	USB	12" (305mm)	5 USB Modules

Aluminum Alternating USB Plugmold

Available in 5' (1.5m) length with 9" spacing. 15A tamper-resistant receptacles. 3-wire, #12 THHN (1 hot, 1 neutral and insulated ground conductor). Packed two per carton. Each unit supplied with one (1) Coupling and two (2) Blank End Fittings. USB Type-A Module is 2.4 Amps (shared between two ports) 5VDC. USB Type-C module is a single 30W Power Delivery port. Please note the charging load on one module will not affect the charging performance of the other USB modules in the product.



CATALOG NO.	FINISH	LENGTH Feet (mm)	WIRING CONFIG	CENTER DISTANCE Inches (mm)	OUTLETS QUANTITY & TYPE
AL20GB509TRUSBA	Aluminum	5' (1.5m)	GB/USB	9"(229mm)	3 Outlets/3USB Modules
AL20GB509TRUAC	Aluminum	5' (1.5m)	GB/USB	9" (229mm)	3 Outlets/2 USB-Amodules/ 1 USB-C Module

NOTE: AL2000 Series Aluminum Plugmold products are available in an anodized finish with gray receptacles. ~~~~~

All AL2000 Series Plugmold products include two (2) AL2010B Blank End Fittings and one (1) AL2001 Base Coupling unless otherwise indicated in the product description.

AL2000/AL2400 Series Aluminum Raceway Fittings Ordering Information

AL2000

Base and Cover – 6063-T5 extruded aluminum, satin anodized finish, .060" (1.5mm) nominal thickness.

Country of Origin: USA

Cross-Sectional Area:
1in² (645mm²)



AL2400

Capacity: 1.7 in.²
(1097mm²)



ITEM	CAT. NO.	LENGTH
Base	AL2000B-5	5' (1.5m)
Cover	AL2000C-5	5' (1.5m)
Base	AL2000B-10	10' (3.0m)
Base	AL2400B-5	5' (1.5m)
Cover	AL2400C	5' (1.5m)
Base	AL2400B-10	10' (3.0m)

AL2003

Supporting Clip – Mount to surface with No. 8 flathead screws. Use with AL2000 Series.

Country of Origin: USA



AL2000WC AL2400WC

Wire Clip – Holds conductors in place in raceway (nonmetallic).

Country of Origin: USA



W30/W30G

Pressure-Type Wire

Connectors – W30 – For common connection of two, three, or four No. 12 or No.14 solid copper conductors (White).

W30G – For connection of equipment grounding of 2, 3, or 4 solid conductors No. 14 or No. 12 AWG (Green). 300V maximum; 20A 105° C maximum.

Country of Origin: USA

NOTE: Not for use with aluminum conductors.



AL2001 AL2401

Coupling – For joining lengths of raceway. Use with AL2000 Series.

Country of Origin: USA



CAT NO.	L	W
AL2001	1 5/8" (41mm)	1 1/2" (38mm)
AL2401	3" (76mm)	1 3/4" (44mm)

AL2006 AL2406

Cover Clip – For covering joint where lengths of cover or base adjoin. Use with AL2000 Series.

Country of Origin: USA



AL2009

Ground Clamp – Use with AL2000 Series.

Country of Origin: USA



AL2010A

End Fitting – With 1/2" hub adapter. Use with AL2000 Series.

Country of Origin: USA

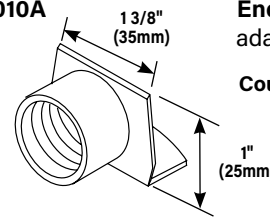

AL2010B

Blank End – Use with AL2000 Series.

Country of Origin: USA



AL2051H AL2451H

Box Adapter – For feeding raceway from an existing wall outlet.

Country of Origin: USA



AL2011 AL2411

90° Flat Elbow – For right angle turn on same surface. Comes with two couplings.

Country of Origin: Mexico



CAT NO.	A	B	C
AL2011	3" (76mm)	3" (76mm)	1 9/16" (40mm)
AL2411	4" (102mm)	4" (102mm)	2" (51mm)

AL2000/AL2400 Series Aluminum Raceway Fittings Ordering Information

**AL2015
AL2415** Tee – For branch connection of two runs of AL2000 Raceway. Three couplings furnished.

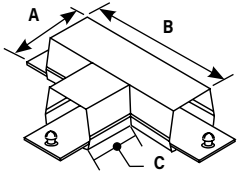

Country of Origin: Mexico

CAT NO.	A	B	C
AL2015	1 7/16" (37mm)	4" (102mm)	1 9/16" (40mm)
AL2415	4" (102mm)	6" (152mm)	2" (51mm)

AL2409 Ground Clamp – Use with AL2400 Series.

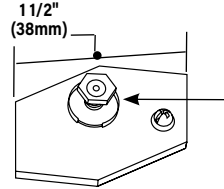

Country of Origin: USA

#8 Ground Stud
W/Cup Washer

AL2010B Blank End – Use with AL2000 Series.

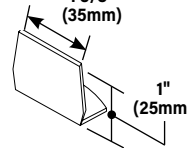

Country of Origin: USA

**AL2017
AL2417** Internal Elbow – For bending around internal corners. Two couplings furnished.

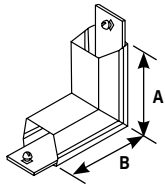

Country of Origin: Mexico

CAT NO.	A
AL2017	3" (76mm)
AL2417	4" (102mm)

AL2410B2 End Fitting – With 1/2" plastic KO. Use with AL2400 Series.

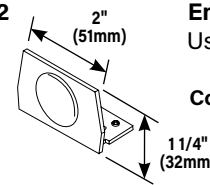

Country of Origin: USA

**AL2018
AL2418** External Elbow – For making 90° external corners. Two couplings furnished.

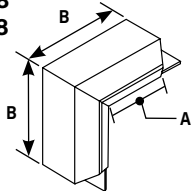

Country of Origin: Mexico

CAT NO.	A	B
AL2018	1 7/8" (48mm)	3" (76mm)
AL2418	3" (76mm)	5" (127mm)

**AL2044
AL2044-2** Deep Device Box – For receptacles and deep devices such as those of signal and alarm systems. Base has open back plate for mounting to existing wall box and solid back plate insert with 1/2" (AL2000 Raceway) and 3/4" (AL2000 Raceway) KO to close opening.

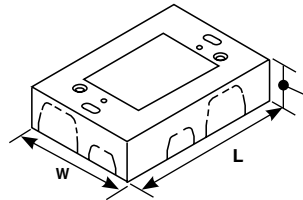

Country of Origin: USA

CAT. NO.	L	W	D	GANG #
AL2044	4 5/8" (117mm)	3 1/16" (73mm)	2 1/4" (57mm)	1
AL2044-2	4 5/8" (117mm)	4 27/32" (121mm)	2 1/2" (64mm)	2

AL2038 Round Fixture Box (Solid Base) – Designed for use in hanging fixtures. Cover takes any device with mounting screw centers of 2 3/4", 3 1/2", and 4 1/16" (70mm, 89mm, and 103mm). Base has concentric 1/2" and 3/4" KOs.

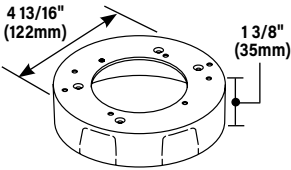

Country of Origin: USA

AL2040A In-line Single Pole Switch – Single pole 120V switch. Two couplings furnished.

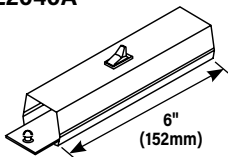

Country of Origin: Mexico

AL2047 Shallow Switch & Receptacle Box – Designed for standard shallow switches and receptacles. Base has open back plate for mounting to existing wall box and solid back plate insert with 1/2" and 3/4" KO to close opening.

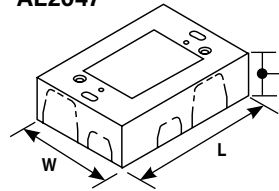

Country of Origin: USA

CAT. NO.	L	W	D	GANG #
AL2047	4 5/8" (117mm)	3 1/16" (73mm)	1 3/8" (35mm)	1
AL2047-2	4 5/8" (117mm)	4 27/32" (121mm)	1 3/8" (35mm)	2

AL2043TR In-line Receptacle – Two 15A, 120V U-ground factory wired receptacles. Couplings furnished. Receptacles are tamper-resistant.

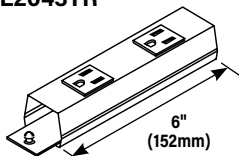

Country of Origin: USA

Nonmetallic Plugmold® Multioutlet Assemblies

Nonmetallic Plugmold Multioutlet Systems provides a versatile solution for many applications. Plugmold sections offer single or alternating circuits, standard or isolated ground receptacles, and Snapicoil® harnesses of prewired receptacles or cord ended units.

Nonmetallic Plugmold has a textured ivory finish with duplex receptacles, and can be customized to accommodate virtually any application.



Nonmetallic Plugmold Multioutlet Systems are available in a variety of configurations.

Plugmold NM2000 Series Nonmetallic Multioutlet Systems

Plugmold NM2000 Series Wire Fill Capacities for Power				
CABLE TYPE	WIRE SIZE THHN/THWN	O.D.		NUMBER OF CONDUCTORS (40% FILL) NM2000/NM2400
		Inches	(mm)	
POWER WIRING WITHOUT DEVICES	10 AWG	0.164	(4.2)	15
	12 AWG	0.130	(3.3)	31
	14 AWG	0.111	(2.8)	45
POWER WIRING WITH DEVICES (Plugmold Series)	10 AWG	0.153	(3.9)	-
	12 AWG	0.122	(3.1)	8 *
	14 AWG	0.105	(2.7)	8 *

* Including one hot, neutral, and ground wire from the receptacle.



Plugmold NM2000 Series Nonmetallic Multioutlet Systems

Plugmold NM2000 Series Nonmetallic Part Numbering System

NM2000 Series Nonmetallic Plugmold Series - Example: NM20GB306





N M	2 0	G B	3	0 6
COLOR:	AMPERAGE:	WIRING CONFIGURATION:	LENGTH:	CENTER DISTANCE:
Nonmetallic = NM	20 = 15A 24 = 20A	GB = GB GBA = GBA IG = IG*	48" (1.2m) = 4 60" (1.5m) = 5 72" (1.8m) = 6	9" (229mm) = 9 12" (305mm) = 12 18" (457mm) = 18 30" (760mm) = 30

NOTE: Not all combinations of color, wiring configurations, length, and center distance are available as standard products. For additional information on custom options, contact Wiremold Technical Support at 1-844-957-3783.

NOTE: NM2000 Series Nonmetallic Plugmold products are available in an ivory finish with ivory receptacles.

* All NM2000 Series Plugmold products include two (2) NM2010B Blank End Fittings unless otherwise indicated in the product description.

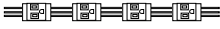
Plugmold NM2000 Series Raceway Wiring Configurations

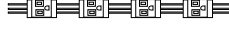
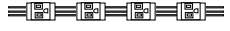
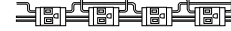
			With Snapicoil	
				
GB Series: 3-wire, #12 THHN (1 hot, 1 neutral and 1 ground), 1 circuit; has insulated grounding conductor.	GBA Series: 4-wire, #12 THHN (2 hot, 1 neutral and 1 ground), 2 circuit; outlets wired alternately; has insulated grounding conductor.	IG Series: 3-wire, #12 THHN (1 hot, 1 neutral and 1 ground), 1 circuit; has insulated-isolated grounding conductor. Orange receptacles.	GB Series: 3-wire, #12 THHN (1 hot, 1 neutral and 1 ground), 1 circuit; has insulated grounding conductor.	GBA Series: 4-wire, #12 THHN (2 hot, 1 neutral and 1 ground), 2 circuit; outlets wired alternately; has insulated grounding conductor.

NOTE: SNAPICOIL REELS on custom order. Snapicoil harness is available on reels if lengths greater than 50' are needed, or if multiple lengths are required for production-type jobs. The maximum length per reel is 240' for Snapicoil with outlets 12" and 18" on centers; 500' with outlets 30" on center. Packaging includes the necessary number of lengths of base, holecut cover, wire clips, and couplings for complete installation. Price and delivery information should be obtained prior to specifying or ordering. To specify or order, add "R" to the Snapicoil number. Ex: NM20GB12R. Other outlet spacings available on custom order.

Receptacles are made from high impact thermoplastic. Snapicoil packaging includes the necessary lengths of NM2000B Base, NM2000C Hole Cut Cover, NM2000WC Wire Clips, and NM2001 Couplings for complete installation.

Cord-Ended Nonmetallic Plugmold Multioutlet Systems								
CAT NO.	UNIT LENGTH	OUTLETS QUANTITY	CORD SET LENGTH	TYPE	SWITCH	CIRCUIT BREAKER	HOUSING	
NM20-C3	3' (.92m)	3 Duplex	6' (1.8m)	14/3 SJT	Yes	Yes	PVC-Ivory	
NM20-C4	4' (1.2m)	4 Duplex	6' (1.8m)	14/3 SJT	Yes	Yes	PVC-Ivory	
NM20-C5	5' (1.5m)	5 Duplex	6' (1.8m)	14/3 SJT	Yes	Yes	PVC-Ivory	
NM20-C6	6' (1.8m)	6 Duplex	6' (1.8m)	14/3 SJT	Yes	Yes	PVC-Ivory	

Plugmold NM2000 Series Raceway with Snapicoil Harness								
CATALOG NO.	LENGTH	WIRING CONFIG	OUTLETS (15A 120V NEMA 5-15SR) CENTER DISTANCE	QUANTITY	HOLE CUT COVER QUANTITY LENGTH		HOUSING	
NM20GB12	48'	GB	12" (152mm)	24 Duplex	8	6' (1.8m)	PVC-Ivory	
NM20GBA12	48'	GBA	12" (305mm)	24 Duplex	8	6' (1.8m)	PVC-Ivory	

Plugmold NM2000 onmetallic Multioutlet Systems Ordering Information

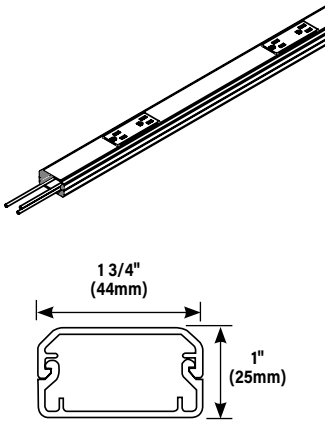
Product	Description/Specifications																																																																																									
Plugmold NM2000 Series 	Available in 4' (1.2m), 5' (1.5m) and 6' (1.8m) lengths with 9" (229mm), 12" (305mm) and 18" (457mm) and 30" (762mm) receptacle spacing. 15A receptacles. 3-wire, #12 THHN (1 hot, 1 neutral, and insulated ground conductor). Packed 2 per carton. Each unit supplied with two (2) Blank End Fittings.																																																																																									
	<table border="1"> <thead> <tr> <th>CATALOG NO.</th> <th>FINISH</th> <th>LENGTH Feet (mm)</th> <th>WIRING CONFIG</th> <th>CENTER DISTANCE Inches (mm)</th> <th>OUTLETS QUANTITY & TYPE</th> </tr> </thead> <tbody> <tr><td>NM20GB412</td><td>Nonmetallic</td><td>4' (1.2m)</td><td>GB</td><td>12" (305mm)</td><td>4 Duplex 15A</td></tr> <tr><td>NM20GBA412</td><td>Nonmetallic</td><td>4' (1.2m)</td><td>GBA</td><td>12" (305mm)</td><td>4 Duplex 15A</td></tr> <tr><td>NM20IG412</td><td>Nonmetallic</td><td>4' (1.2 m)</td><td>GB</td><td>12" (305mm)</td><td>4 Duplex 15A</td></tr> <tr><td>NM20GB512</td><td>Nonmetallic</td><td>5' (1.5m)</td><td>GB</td><td>12" (305mm)</td><td>5 Duplex 15A</td></tr> <tr><td>NM20GB515</td><td>Nonmetallic</td><td>5' (1.5m)</td><td>GB</td><td>15" (381mm)</td><td>4 Duplex 15A</td></tr> <tr><td>NM20GB530</td><td>Nonmetallic</td><td>5' (1.5m)</td><td>GB</td><td>30" (760mm)</td><td>2 Duplex 15A</td></tr> <tr><td>NM20GBA512</td><td>Nonmetallic</td><td>5' (1.5m)</td><td>GBA</td><td>12" (305mm)</td><td>5 Duplex 15A</td></tr> <tr><td>NM20IG512</td><td>Nonmetallic</td><td>5' (1.5m)</td><td>IG</td><td>12" (305mm)</td><td>5 Duplex 15A</td></tr> <tr><td>NM20GB609</td><td>Nonmetallic</td><td>6' (1.8m)</td><td>GB</td><td>9" (229mm)</td><td>8 Duplex 15A</td></tr> <tr><td>NM20GB612</td><td>Nonmetallic</td><td>6' (1.8m)</td><td>GB</td><td>12" (305mm)</td><td>6 Duplex 15A</td></tr> <tr><td>NM20GB618</td><td>Nonmetallic</td><td>6' (1.8m)</td><td>GB</td><td>18" (457mm)</td><td>4 Duplex 15A</td></tr> <tr><td>NM20GBA609</td><td>Nonmetallic</td><td>6' (1.8m)</td><td>GBA</td><td>9" (229mm)</td><td>8 Duplex 15A</td></tr> <tr><td>NM20GBA612</td><td>Nonmetallic</td><td>6' (1.8m)</td><td>GBA</td><td>12" (305mm)</td><td>6 Duplex 15A</td></tr> <tr><td>NM20IG612</td><td>Nonmetallic</td><td>6' (1.8m)</td><td>IG</td><td>12" (305mm)</td><td>6 Duplex 15A</td></tr> </tbody> </table>	CATALOG NO.	FINISH	LENGTH Feet (mm)	WIRING CONFIG	CENTER DISTANCE Inches (mm)	OUTLETS QUANTITY & TYPE	NM20GB412	Nonmetallic	4' (1.2m)	GB	12" (305mm)	4 Duplex 15A	NM20GBA412	Nonmetallic	4' (1.2m)	GBA	12" (305mm)	4 Duplex 15A	NM20IG412	Nonmetallic	4' (1.2 m)	GB	12" (305mm)	4 Duplex 15A	NM20GB512	Nonmetallic	5' (1.5m)	GB	12" (305mm)	5 Duplex 15A	NM20GB515	Nonmetallic	5' (1.5m)	GB	15" (381mm)	4 Duplex 15A	NM20GB530	Nonmetallic	5' (1.5m)	GB	30" (760mm)	2 Duplex 15A	NM20GBA512	Nonmetallic	5' (1.5m)	GBA	12" (305mm)	5 Duplex 15A	NM20IG512	Nonmetallic	5' (1.5m)	IG	12" (305mm)	5 Duplex 15A	NM20GB609	Nonmetallic	6' (1.8m)	GB	9" (229mm)	8 Duplex 15A	NM20GB612	Nonmetallic	6' (1.8m)	GB	12" (305mm)	6 Duplex 15A	NM20GB618	Nonmetallic	6' (1.8m)	GB	18" (457mm)	4 Duplex 15A	NM20GBA609	Nonmetallic	6' (1.8m)	GBA	9" (229mm)	8 Duplex 15A	NM20GBA612	Nonmetallic	6' (1.8m)	GBA	12" (305mm)	6 Duplex 15A	NM20IG612	Nonmetallic	6' (1.8m)	IG	12" (305mm)
CATALOG NO.	FINISH	LENGTH Feet (mm)	WIRING CONFIG	CENTER DISTANCE Inches (mm)	OUTLETS QUANTITY & TYPE																																																																																					
NM20GB412	Nonmetallic	4' (1.2m)	GB	12" (305mm)	4 Duplex 15A																																																																																					
NM20GBA412	Nonmetallic	4' (1.2m)	GBA	12" (305mm)	4 Duplex 15A																																																																																					
NM20IG412	Nonmetallic	4' (1.2 m)	GB	12" (305mm)	4 Duplex 15A																																																																																					
NM20GB512	Nonmetallic	5' (1.5m)	GB	12" (305mm)	5 Duplex 15A																																																																																					
NM20GB515	Nonmetallic	5' (1.5m)	GB	15" (381mm)	4 Duplex 15A																																																																																					
NM20GB530	Nonmetallic	5' (1.5m)	GB	30" (760mm)	2 Duplex 15A																																																																																					
NM20GBA512	Nonmetallic	5' (1.5m)	GBA	12" (305mm)	5 Duplex 15A																																																																																					
NM20IG512	Nonmetallic	5' (1.5m)	IG	12" (305mm)	5 Duplex 15A																																																																																					
NM20GB609	Nonmetallic	6' (1.8m)	GB	9" (229mm)	8 Duplex 15A																																																																																					
NM20GB612	Nonmetallic	6' (1.8m)	GB	12" (305mm)	6 Duplex 15A																																																																																					
NM20GB618	Nonmetallic	6' (1.8m)	GB	18" (457mm)	4 Duplex 15A																																																																																					
NM20GBA609	Nonmetallic	6' (1.8m)	GBA	9" (229mm)	8 Duplex 15A																																																																																					
NM20GBA612	Nonmetallic	6' (1.8m)	GBA	12" (305mm)	6 Duplex 15A																																																																																					
NM20IG612	Nonmetallic	6' (1.8m)	IG	12" (305mm)	6 Duplex 15A																																																																																					

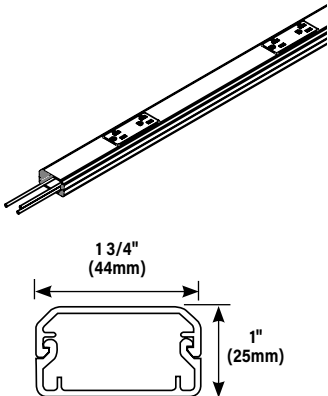
Product	Description/Specifications																																																					
Plugmold NM2400 Series 	Available in 4' (1.2m), 5' (1.5m) and 6' (1.8m) lengths with 9" (229mm), 12" (305mm) and 18" (457mm) and 30" (762mm) receptacle spacing. 20A receptacles. 3-wire, #12 THHN (1 hot, 1 neutral, and insulated ground conductor). Packed 2 per carton. Each unit supplied with two (2) Blank End Fittings.																																																					
	<table border="1"> <thead> <tr> <th>CATALOG NO.</th> <th>FINISH</th> <th>LENGTH Feet (mm)</th> <th>WIRING CONFIG</th> <th>CENTER DISTANCE Inches (mm)</th> <th>OUTLETS QUANTITY & TYPE</th> </tr> </thead> <tbody> <tr><td>NM24GB412</td><td>Nonmetallic</td><td>4' (1.2m)</td><td>GB</td><td>12" (305mm)</td><td>4 Duplex 20A</td></tr> <tr><td>NM24GBA412</td><td>Nonmetallic</td><td>4' (1.2m)</td><td>GBA</td><td>12" (305mm)</td><td>4 Duplex 20A</td></tr> <tr><td>NM24GB512</td><td>Nonmetallic</td><td>5' (1.5m)</td><td>GB</td><td>12" (305mm)</td><td>5 Duplex 20A</td></tr> <tr><td>NM24GB530</td><td>Nonmetallic</td><td>5' (1.5m)</td><td>GB</td><td>30" (760mm)</td><td>2 Duplex 20A</td></tr> <tr><td>NM24GBA512</td><td>Nonmetallic</td><td>5' (1.5m)</td><td>GBA</td><td>12" (305mm)</td><td>5 Duplex 20A</td></tr> <tr><td>NM24GB612</td><td>Nonmetallic</td><td>6' (1.8m)</td><td>GB</td><td>12" (305mm)</td><td>6 Duplex 20A</td></tr> <tr><td>NM24GB618</td><td>Nonmetallic</td><td>6' (1.8m)</td><td>GB</td><td>18" (457mm)</td><td>4 Duplex 20A</td></tr> <tr><td>NM24GBA612</td><td>Nonmetallic</td><td>6' (1.8m)</td><td>GB A</td><td>12" (305mm)</td><td>6 Duplex 20A</td></tr> </tbody> </table>	CATALOG NO.	FINISH	LENGTH Feet (mm)	WIRING CONFIG	CENTER DISTANCE Inches (mm)	OUTLETS QUANTITY & TYPE	NM24GB412	Nonmetallic	4' (1.2m)	GB	12" (305mm)	4 Duplex 20A	NM24GBA412	Nonmetallic	4' (1.2m)	GBA	12" (305mm)	4 Duplex 20A	NM24GB512	Nonmetallic	5' (1.5m)	GB	12" (305mm)	5 Duplex 20A	NM24GB530	Nonmetallic	5' (1.5m)	GB	30" (760mm)	2 Duplex 20A	NM24GBA512	Nonmetallic	5' (1.5m)	GBA	12" (305mm)	5 Duplex 20A	NM24GB612	Nonmetallic	6' (1.8m)	GB	12" (305mm)	6 Duplex 20A	NM24GB618	Nonmetallic	6' (1.8m)	GB	18" (457mm)	4 Duplex 20A	NM24GBA612	Nonmetallic	6' (1.8m)	GB A	12" (305mm)
CATALOG NO.	FINISH	LENGTH Feet (mm)	WIRING CONFIG	CENTER DISTANCE Inches (mm)	OUTLETS QUANTITY & TYPE																																																	
NM24GB412	Nonmetallic	4' (1.2m)	GB	12" (305mm)	4 Duplex 20A																																																	
NM24GBA412	Nonmetallic	4' (1.2m)	GBA	12" (305mm)	4 Duplex 20A																																																	
NM24GB512	Nonmetallic	5' (1.5m)	GB	12" (305mm)	5 Duplex 20A																																																	
NM24GB530	Nonmetallic	5' (1.5m)	GB	30" (760mm)	2 Duplex 20A																																																	
NM24GBA512	Nonmetallic	5' (1.5m)	GBA	12" (305mm)	5 Duplex 20A																																																	
NM24GB612	Nonmetallic	6' (1.8m)	GB	12" (305mm)	6 Duplex 20A																																																	
NM24GB618	Nonmetallic	6' (1.8m)	GB	18" (457mm)	4 Duplex 20A																																																	
NM24GBA612	Nonmetallic	6' (1.8m)	GB A	12" (305mm)	6 Duplex 20A																																																	

NOTE: NM2000 Series Nonmetallic Plugmold products are available in an ivory finish with ivory receptacles.
 All NM2000 Series Plugmold products include two (2) NM2010B Blank End Fittings and one (1) NM2001 Base Coupling unless otherwise indicated in the product description.

Plugmold NM2000 Series Nonmetallic Multioutlet Systems Ordering Information

NM2000

Base and Cover – Extruded PVC, ivory textured finish.

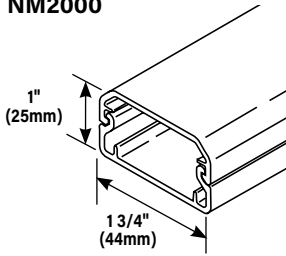

Country of Origin: USA

Cross-Sectional Area:
1.14in² (735mm²)

NM2010B

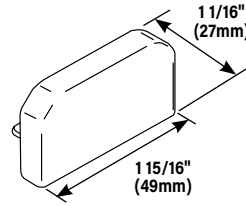

Blank End Fitting – Use with NM2000 Series.

Country of Origin: USA

NM2011

90° Flat Elbow – For right angle turns on same surface.

Country of Origin: USA

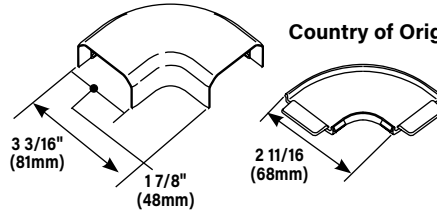

ITEM	CAT. NO.	LENGTH	MATERIAL
Base	NM2000B	8' (2.4m)	PVC-Ivory
Cover	NM2000C	8' (2.4m)	PVC-Ivory
Base & Cover	NM2000BC	5' (1.52m)	PVC-Ivory

NM2003

Supporting Clip – Mount to surface with No. 8 flathead screw. Use with NM2000 Series.

Country of Origin: USA

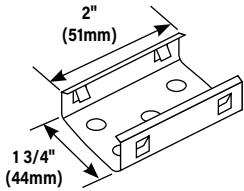

NM2015

Tee – For branches at right angles.

Country of Origin: USA

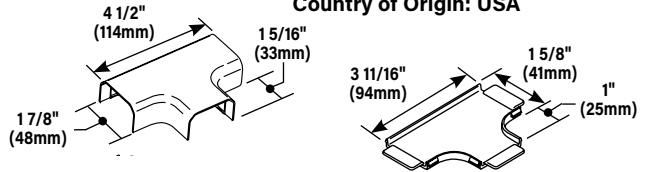

W30/W30G

Pressure-Type Wire Connectors – **W30** – For common connection of two, three, or four No. 12 or No.14 solid copper conductors (White). **W30G** – For connection of equipment grounding of 2, 3, or 4 solid conductors No. 14 or No. 12 AWG (Green). 300V maximum; 20A 105° C maximum.

Country of Origin: USA

NOTE: Not for use with aluminum conductors.

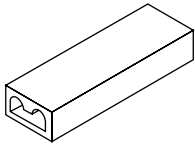

NM2017

Internal Elbow – For right turns at inside corners.

Country of Origin: USA

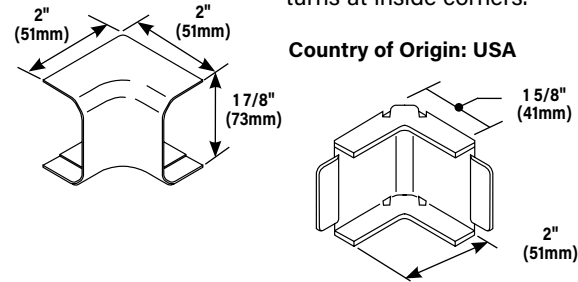

NM2006

Cover Clip – For covering joint where lengths of NM2000 Series cover or base adjoin. Use with NM2000 Series.

Country of Origin: USA

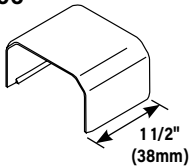

NM2018

External Elbow – Used for making 90° turns at outside corners.

Country of Origin: USA

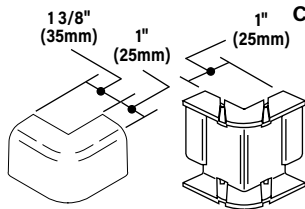

NM2010A

Entrance End – Has 1/2" trade size KO on end and bottom. Use with NM2000 Series.

Country of Origin: USA

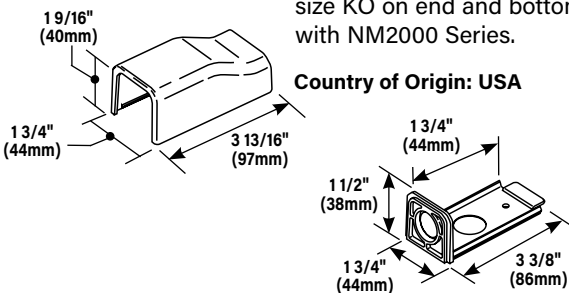

NOTE: NM2000 Series fittings work with both NM20 (15A) and NM24 (20A) Plugmold Multioutlet Systems.

Plugmold NM2000 Series Nonmetallic Multioutlet Systems Ordering Information

NM2051H



Wall Box Adapter – For feeding raceway from an existing wall outlet; horizontal applications. Provides complete access to wall box for connections.

Country of Origin: USA

**NM2048
NM2048-2**



Sure-Snap® Device Box – Cover snaps onto base, no screws required. Cover has twistouts on all sides. Rectangular KO in base for extension to wall box.

Country of Origin: USA

NM2051V



Wall Box Adapter – For feeding raceway from an existing wall outlet; vertical applications. Provides complete access to wall box for connections.

Country of Origin: USA

CAT. NO.	L	W	D	GANG #
NM2048	4 3/4" (121mm)	3" (76mm)	1 3/4" (44mm)	1
NM2048-2	4 3/4" (121mm)	4 7/8" (124mm)	1 3/4" (44mm)	2

**NM2027-15
NM2027-20**

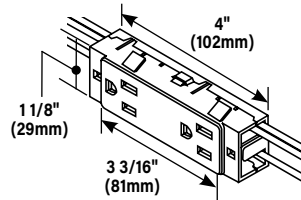

Replacement Receptacles – 15A and 20A replacement devices. 6" (152mm) wire leads each side. Used to replace faulty receptacles in Plugmold Strips, not for installation in blank raceway base.

Country of Origin: USA

NM2044



Extra Deep Device Box – For mounting power/communication device when additional depth is required. Has combination twistouts for 2700, 2800, 2900, and NM2000.

Country of Origin: USA

CAT. NO.	L	W	D	GANG #
NM2044	4 3/4" (121mm)	3" (76mm)	2 3/4" (44mm)	1
NM2044-2	4 3/4" (121mm)	4 7/8" (124mm)	2 3/4" (44mm)	2

NOTE: NM2000 Series fittings work with both NM20 (15A) and NM24 (20A) Plugmold Multioutlet Systems.

NOTE: All brand and product names referenced in this document are registered trademarks or trademarks of their respective holders.



Legrand, North America
60 Woodlawn Street
West Hartford, CT 06110
1.877.BY.LEGRAND (295.3472)
www.legrand.us

Canada
905.738.9195
www.legrand.ca

FOLLOW US

