

# HALO OUTDOOR™

## DESCRIPTION

The HALO LED Die Cast floodlight series utilizes selectable CCT functionality, advanced two-stage optics and multiple mounting options for a versatile outdoor lighting solution. Multiple lumen packages and integrated control options address a wide range of outdoor general lighting and security applications. The durable die-cast aluminum housing is available in bronze or white powder coat finish, ensuring years of reliable, maintenance-free operation.

Catalog #		Type
Project		
Comments		Date
Prepared by		

## SPECIFICATION FEATURES

### Construction

- Durable die-cast aluminum housing with UV stable clear lens
- Powder coated bronze or white finish
- Optically enhanced reflector improves efficiency and delivered lumens
- Tool-less head and motion sensor adjustment
- Wall or eave mounted to recessed or surface junction boxes

### Optics

- Two-stage optics for maximum coverage
- Field selectable CCT: 3000K, 4000K and 5000K

### Electrical

- 120VAC, 60Hz (Select SKUs)
- 120-277VAC, 60Hz (Select SKUs)
- Maintenance-free LEDs with 70,000 hours of life
- Fixture operating temperature of -30°C to 40°C
- External supply wiring 75°C minimum
- Integral photocell allows for nighttime ON / daytime OFF operation (Integrated sensor SKUs only)

### Select Motion SKUs

- Motion sensor detects motion 180° or 270° up to 50 feet
- Selectable duration to keep floodlights on up to 12 minutes
- Adjustable sensitivity
- Integral photocell prevents lights from turning on with motion during daylight hours
- Manual override allows fixture to operate as a standard dusk-to-dawn for up to 6 hours

### Warranty

- Five year limited warranty, consult website for details. [www.cooperlighting.com](http://www.cooperlighting.com)

### Compliance

- UL certified for US and Canada for wet locations
- EMI/RFI emissions per FCC 47CFR Part 15B
- Contains no mercury or lead and RoHS compliant.
- Photometric testing in accordance with IES LM-79-08
- Lumen maintenance projections in accordance with IES LM-80-08 and TM-21-11



## DIE CAST FLOOD SERIES SINGLE, TWIN, TRIPLE FLOODS

seleCCTable™

Suitable for recessed or surface mount electrical junction boxes

## DIMENSIONS

### FSL303T and FSL203T

Front View

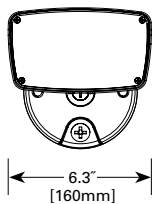

Side View

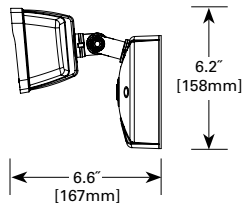

Wall Mount

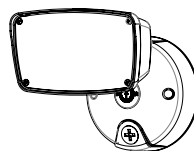

Eave Mount



### FSS153T

Front View

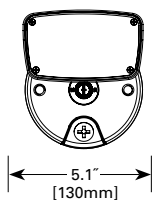

Side View

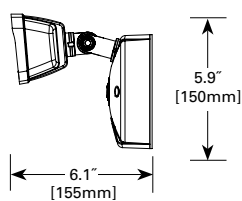

Wall Mount

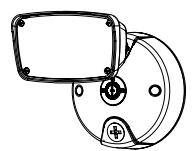

Eave Mount

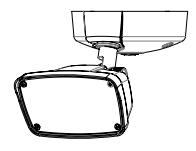

**DIMENSIONS**

**MST203T**

Front View

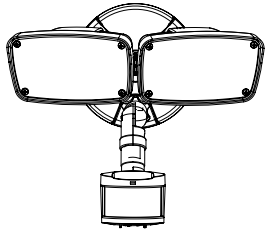
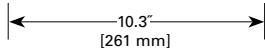

Side View

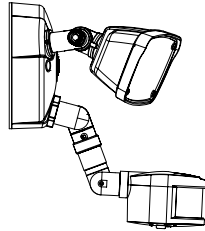
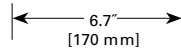

**MHS303T**

Front View

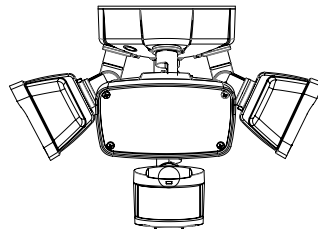
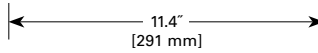

Side View

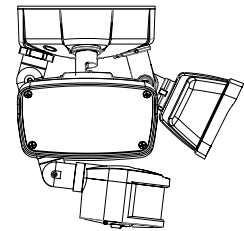
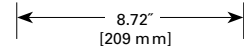

**ORDERING INFORMATION**

Sample Number: FSS153TIB or MST203T18W

Module	Lumens	CRI/CCT	Options	Colors
<b>FSS</b> = Flood Single Small <b>FSL</b> = Single Large Flood <b>FTS</b> = Flood Twin Small <b>FHS</b> = Flood Triple Small <b>MSS</b> = Motion Small Single <b>MST</b> = Motion Small Twin <b>MSH</b> = Motion Small Triple	<b>15</b> = 1500 lumens (nominal) <b>20</b> = 2000 lumens (nominal) <b>30</b> = 3000 lumens (nominal)	<b>3T</b> = Selectable CCT 3000K, 4000K, & 5000K	<b>I</b> = Integrated Photocell <b>18</b> = 180° Motion Sensor <b>27</b> = 270° Motion Sensor	<b>W</b> = White

**PHOTOMETRY**

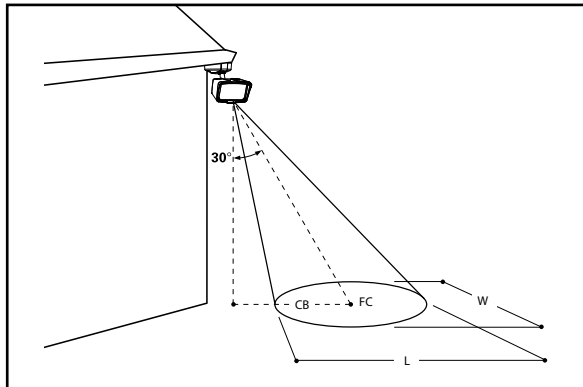

**Area Coverage**

	Mounting Height	Length (L)	Width (W)	Area (Sq. Ft.)	Max FC
<b>MST203T Series</b>	10 ft.	18	40	720	4.3
	15 ft.	20	40	800	1.9
	20 ft.	20	40	800	1.1

Note: Bronze fixture at a typical mounting angle of 30° from vertical  
All figures based on minimum footcandle (FC) of 0.5 and 4000K CCT.

Note: Specifications and Dimensions subject to change without notice.

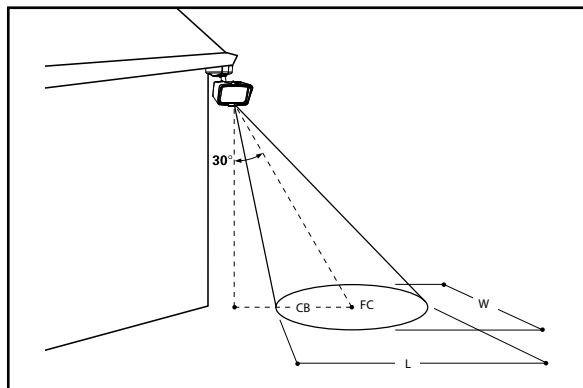

**Area Coverage**

	Mounting Height	Length (L)	Width (W)	Area (Sq. Ft.)
<b>FSL303T Series</b>	10 ft.	22	38	800
	15 ft.	28	42	1150
	20 ft.	32	50	1500
	25 ft.	35	56	1800
<b>FSL203T Series</b>	10 ft.	20	30	600
	15 ft.	24	40	960
	20 ft.	27	40	1040
<b>FSS153T Series</b>	10 ft.	20	25	400
	15 ft.	20	30	500
	20 ft.	22	35	560

Note: Bronze fixture at a typical mounting angle of 30° from vertical  
All figures based on minimum footcandle (FC) of 0.5.

## PHOTOMETRY

Series	Voltage	Power (W)	Delivered Lumens (Lm)	Efficacy (Lm/W)	CCT	CRI	Controls
FSS153TB	120-277V	17.3	1503	86.9	3000K,4000K,5000K	84	None
FSS153TW	120-277V	17.3	1503	86.9	3000K,4000K,5000K	84	None
FSS153TIB	120V	17.3	1503	86.9	3000K,4000K,5000K	84	Integrated Photocell
FSS153TIW	120V	17.3	1503	86.9	3000K,4000K,5000K	84	Integrated Photocell
FSL203TB	120-277V	22.5	1916	85.2	3000K,4000K,5000K	84	None
FSL203TW	120-277V	22.5	1916	85.2	3000K,4000K,5000K	84	None
FSL203TIB	120V	22.5	1916	85.2	3000K,4000K,5000K	84	Integrated Photocell
FSL203TIW	120V	22.5	1916	85.2	3000K,4000K,5000K	84	Integrated Photocell
FSL303TB	120-277V	31.6	2900	91.8	3000K,4000K,5000K	84	None
FSL303TW	120-277V	31.6	2900	91.8	3000K,4000K,5000K	84	None
FSL303TIB	120V	31.6	2900	91.8	3000K,4000K,5000K	84	Integrated Photocell
FSL303TIW	120V	31.6	2900	91.8	3000K,4000K,5000K	84	Integrated Photocell
FTS203TB	120-277V	22.8	2034	89.2	3000K,4000K,5000K	84	None
FTS203TW	120-277V	22.8	2034	89.2	3000K,4000K,5000K	84	None
FHS303TB	120-277V	31.8	2853	89.7	3000K,4000K,5000K	84	None
FHS303TW	120-277V	31.8	2853	89.7	3000K,4000K,5000K	84	None
MSH303T18B	120V	31.8	2853	89.7	3000K,4000K,5000K	84	180* Motion Sensor
MSH303T18W	120V	31.8	2853	89.7	3000K,4000K,5000K	84	180* Motion Sensor
MSS153T18B	120V	17.3	1503	86.9	3000K,4000K,5000K	84	180* Motion Sensor
MSS153T18W	120V	17.3	1503	86.9	3000K,4000K,5000K	84	180* Motion Sensor
MST203T18B	120V	22.8	2034	89.2	3000K,4000K,5000K	84	180* Motion Sensor
MST203T18W	120V	22.8	2034	89.2	3000K,4000K,5000K	84	180* Motion Sensor
MST203T27B	120V	22.8	2034	89.2	3000K,4000K,5000K	84	270* Motion Sensor
MST203T27W	120V	22.8	2034	89.2	3000K,4000K,5000K	84	270* Motion Sensor

# HALO OUTDOOR™

## DESCRIPTION

The HALO LED Die Cast floodlight series utilizes selectable CCT functionality, advanced two-stage optics and multiple mounting options for a versatile outdoor lighting solution. Multiple lumen packages and integrated control options address a wide range of outdoor general lighting and security applications. The durable die-cast aluminum housing is available in bronze or white powder coat finish, ensuring years of reliable, maintenance-free operation.

<b>Catalog #</b>		<b>Type</b>
<b>Project</b>		
<b>Comments</b>		<b>Date</b>
<b>Prepared by</b>		

## SPECIFICATION FEATURES

### Construction

- Durable die-cast aluminum housing with UV stable clear lens
- Powder coated bronze or white finish
- Optically enhanced reflector improves efficiency and delivered lumens
- Tool-less head and motion sensor adjustment
- Wall or eave mounted to recessed or surface junction boxes

### Optics

- Two-stage optics for maximum coverage
- Field selectable CCT: 3000K, 4000K and 5000K

### Electrical

- 120VAC, 60Hz (Select SKUs)
- 120-277VAC, 60Hz (Select SKUs)
- Maintenance-free LEDs with 70,000 hours of life
- Fixture operating temperature of -30°C to 40°C
- External supply wiring 75°C minimum
- Integral photocell allows for nighttime ON / daytime OFF operation (Integrated sensor SKUs only)

### Select Motion SKUs

- Motion sensor detects motion 180° or 270° up to 50 feet
- Selectable duration to keep floodlights on up to 12 minutes
- Adjustable sensitivity
- Integral photocell prevents lights from turning on with motion during daylight hours
- Manual override allows fixture to operate as a standard dusk-to-dawn for up to 6 hours

### Warranty

- Five year limited warranty, consult website for details. [www.cooperlighting.com](http://www.cooperlighting.com)

### Compliance

- UL certified for US and Canada for wet locations
- EMI/RFI emissions per FCC 47CFR Part 15B
- Contains no mercury or lead and RoHS compliant.
- Photometric testing in accordance with IES LM-79-08
- Lumen maintenance projections in accordance with IES LM-80-08 and TM-21-11



## DIE CAST FLOOD SERIES SINGLE, TWIN, TRIPLE FLOODS

seleCCTable™

Suitable for recessed or surface mount electrical junction boxes

## DIMENSIONS

### FSL303T and FSL203T

Front View

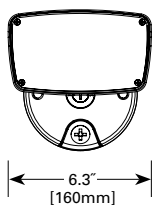

Side View

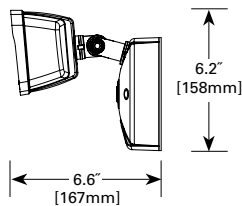

Wall Mount

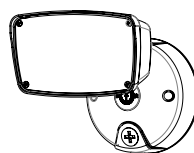

Eave Mount



### FSS153T

Front View

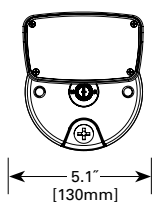

Side View

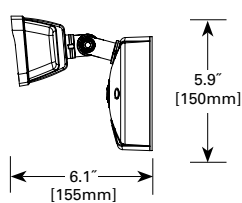

Wall Mount

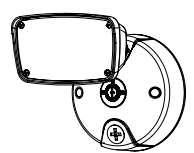

Eave Mount

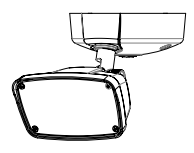

**DIMENSIONS**

**MST203T**

Front View

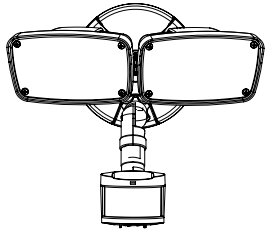
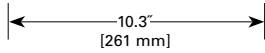

Side View

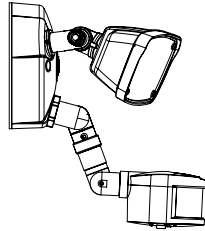
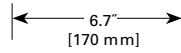

**MHS303T**

Front View

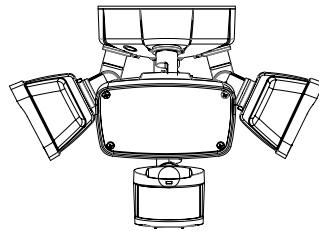
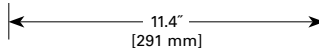

Side View

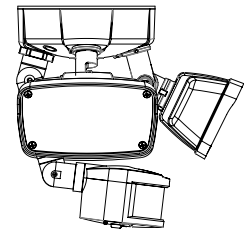
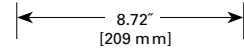

**ORDERING INFORMATION**

Sample Number: FSS153TIB or MST203T18W

Module	Lumens	CRI/CCT	Options	Colors
<b>FSS</b> = Flood Single Small <b>FSL</b> = Single Large Flood <b>FTS</b> = Flood Twin Small <b>FHS</b> = Flood Triple Small <b>MSS</b> = Motion Small Single <b>MST</b> = Motion Small Twin <b>MSH</b> = Motion Small Triple	<b>15</b> = 1500 lumens (nominal) <b>20</b> = 2000 lumens (nominal) <b>30</b> = 3000 lumens (nominal)	<b>3T</b> = Selectable CCT 3000K, 4000K, & 5000K	<b>I</b> = Integrated Photocell <b>18</b> = 180° Motion Sensor <b>27</b> = 270° Motion Sensor	<b>W</b> = White

**PHOTOMETRY**

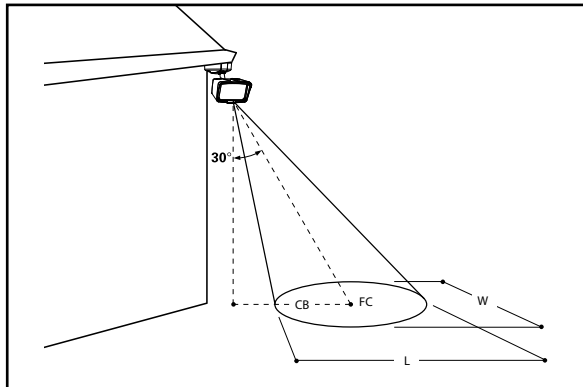

**Area Coverage**

	Mounting Height	Length (L)	Width (W)	Area (Sq. Ft.)	Max FC
<b>MST203T Series</b>	10 ft.	18	40	720	4.3
	15 ft.	20	40	800	1.9
	20 ft.	20	40	800	1.1

Note: Bronze fixture at a typical mounting angle of 30° from vertical  
All figures based on minimum footcandle (FC) of 0.5 and 4000K CCT.

Note: Specifications and Dimensions subject to change without notice.

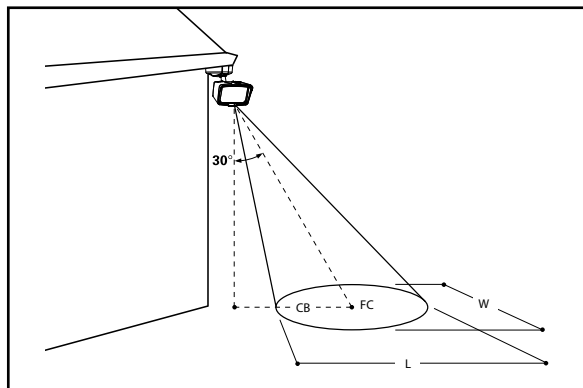

**Area Coverage**

	Mounting Height	Length (L)	Width (W)	Area (Sq. Ft.)
<b>FSL303T Series</b>	10 ft.	22	38	800
	15 ft.	28	42	1150
	20 ft.	32	50	1500
	25 ft.	35	56	1800
<b>FSL203T Series</b>	10 ft.	20	30	600
	15 ft.	24	40	960
	20 ft.	27	40	1040
<b>FSS153T Series</b>	10 ft.	20	25	400
	15 ft.	20	30	500
	20 ft.	22	35	560

Note: Bronze fixture at a typical mounting angle of 30° from vertical  
All figures based on minimum footcandle (FC) of 0.5.

## PHOTOMETRY

Series	Voltage	Power (W)	Delivered Lumens (Lm)	Efficacy (Lm/W)	CCT	CRI	Controls
FSS153TB	120-277V	17.3	1503	86.9	3000K,4000K,5000K	84	None
FSS153TW	120-277V	17.3	1503	86.9	3000K,4000K,5000K	84	None
FSS153TIB	120V	17.3	1503	86.9	3000K,4000K,5000K	84	Integrated Photocell
FSS153TIW	120V	17.3	1503	86.9	3000K,4000K,5000K	84	Integrated Photocell
FSL203TB	120-277V	22.5	1916	85.2	3000K,4000K,5000K	84	None
FSL203TW	120-277V	22.5	1916	85.2	3000K,4000K,5000K	84	None
FSL203TIB	120V	22.5	1916	85.2	3000K,4000K,5000K	84	Integrated Photocell
FSL203TIW	120V	22.5	1916	85.2	3000K,4000K,5000K	84	Integrated Photocell
FSL303TB	120-277V	31.6	2900	91.8	3000K,4000K,5000K	84	None
FSL303TW	120-277V	31.6	2900	91.8	3000K,4000K,5000K	84	None
FSL303TIB	120V	31.6	2900	91.8	3000K,4000K,5000K	84	Integrated Photocell
FSL303TIW	120V	31.6	2900	91.8	3000K,4000K,5000K	84	Integrated Photocell
FTS203TB	120-277V	22.8	2034	89.2	3000K,4000K,5000K	84	None
FTS203TW	120-277V	22.8	2034	89.2	3000K,4000K,5000K	84	None
FHS303TB	120-277V	31.8	2853	89.7	3000K,4000K,5000K	84	None
FHS303TW	120-277V	31.8	2853	89.7	3000K,4000K,5000K	84	None
MSH303T18B	120V	31.8	2853	89.7	3000K,4000K,5000K	84	180* Motion Sensor
MSH303T18W	120V	31.8	2853	89.7	3000K,4000K,5000K	84	180* Motion Sensor
MSS153T18B	120V	17.3	1503	86.9	3000K,4000K,5000K	84	180* Motion Sensor
MSS153T18W	120V	17.3	1503	86.9	3000K,4000K,5000K	84	180* Motion Sensor
MST203T18B	120V	22.8	2034	89.2	3000K,4000K,5000K	84	180* Motion Sensor
MST203T18W	120V	22.8	2034	89.2	3000K,4000K,5000K	84	180* Motion Sensor
MST203T27B	120V	22.8	2034	89.2	3000K,4000K,5000K	84	270* Motion Sensor
MST203T27W	120V	22.8	2034	89.2	3000K,4000K,5000K	84	270* Motion Sensor