

Condulet® Multi-Gang Device Boxes - Cast Iron or Aluminum

Accessories
see pages 37-45

2F

With and Without Mounting Lugs for
Threaded Rigid and IMC Conduit

FS†

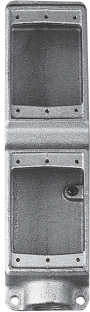

Two Gang Tandem

Size	Cat. #
1/2	FS17
3/4	FS27

FSC†



Two Gang Tandem

Size	Cat. #
1/2	FSC17
3/4	FSC27

FSE

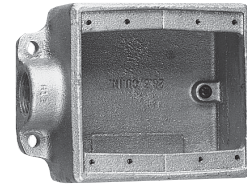

Two Gang

Size	Cat. #
3/4	FSE22

FS & FD

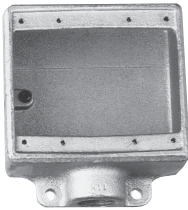

Two Gang

Size	Cat. #	Cat. #
1/2	FS12*	FD12
3/4	FS22*	FD22*
1	FS32	FD32

FSC & FDC

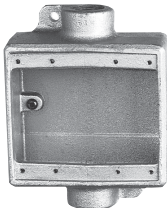

Two Gang

Size	Cat. #	Cat. #
1/2	FSC12	FDC12
3/4	FSC222	FDC222*
1	FSC32	FDC32

†Use single gang covers only.

*Available in copper-free aluminum;
add suffix "SA".

Dimensions

In Inches:

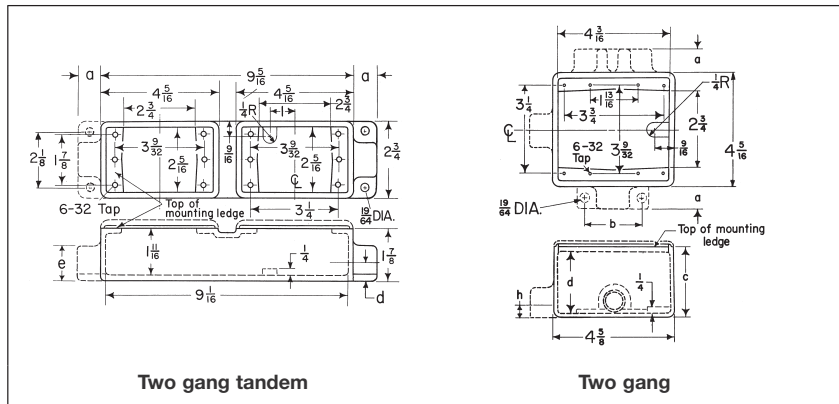

Two gang tandem

Series	Hub Size	a	b	e
FS	1/2	7/8	5/8	1 1/4
	3/4	7/8	3/4	1 1/2

Two gang

Series	Hub Size	a	b	c	d	h
FS	1/2	7/8	2 1/4	1 7/8	1 11/16	5/8
	3/4	7/8	2 1/4	1 7/8	1 11/16	3/4
	1	1	2 1/2	1 7/8	1 11/16	7/8
FD	1/2	7/8	2 1/4	2 11/16	2 1/2	5/8
	3/4	7/8	2 1/4	2 11/16	2 1/2	3/4
	1	1	2 1/2	2 11/16	2 1/2	7/8

2F

Condulet® Multi-Gang Device Boxes - Cast Iron or Aluminum

Accessories
see pages 37-45

With and Without Mounting Lugs for
Threaded Rigid and IMC Conduit

2F

FSS & FDS



Two Gang

Size	Cat. #	Cat. #
3/4	FSS222	FDS222

FSD

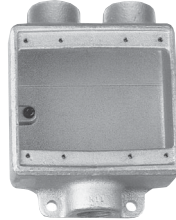

Two Gang

Size	Cat. #
3/4	FSD212*

*Hubs on 2 hub side are 1/2"

FS & FD

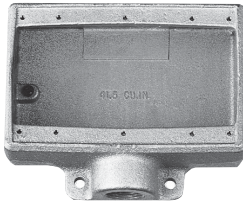

Three Gang

Size	Cat. #	Cat. #
3/4	FS23	FD23
1	FS33	

FSS

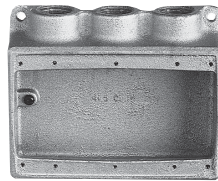

Three Gang

Size	Cat. #
3/4	FSS23

Dimensions

In Inches:

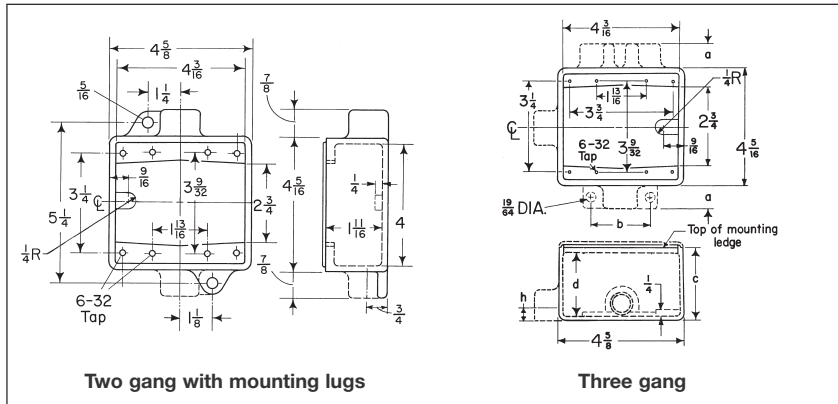

Three gang

Series	Hub Size	a	c	d
FS	3/4	7/8	1 7/8	1 11/16
	1	1	1 7/8	1 11/16
FD	3/4	7/8	2 11/16	2 1/2

Condulet® Multi-Gang Device Boxes - Cast Iron or Aluminum

Accessories
see pages 37-45

2F

With and Without Mounting Lugs for
Threaded Rigid and IMC Conduit

FS†

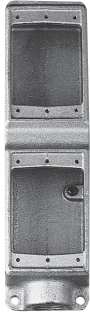

Two Gang Tandem

Size	Cat. #
1/2	FS17
3/4	FS27

FSC†



Two Gang Tandem

Size	Cat. #
1/2	FSC17
3/4	FSC27

FSE

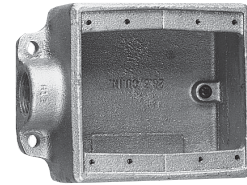

Two Gang

Size	Cat. #
3/4	FSE22

FS & FD

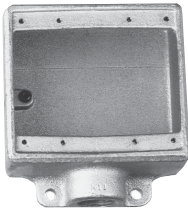

Two Gang

Size	Cat. #	Cat. #
1/2	FS12*	FD12
3/4	FS22*	FD22*
1	FS32	FD32

FSC & FDC

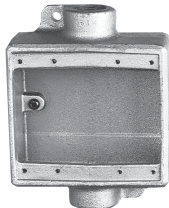

Two Gang

Size	Cat. #	Cat. #
1/2	FSC12	FDC12
3/4	FSC222	FDC222*
1	FSC32	FDC32

†Use single gang covers only.

*Available in copper-free aluminum;
add suffix "SA".

Dimensions

In Inches:

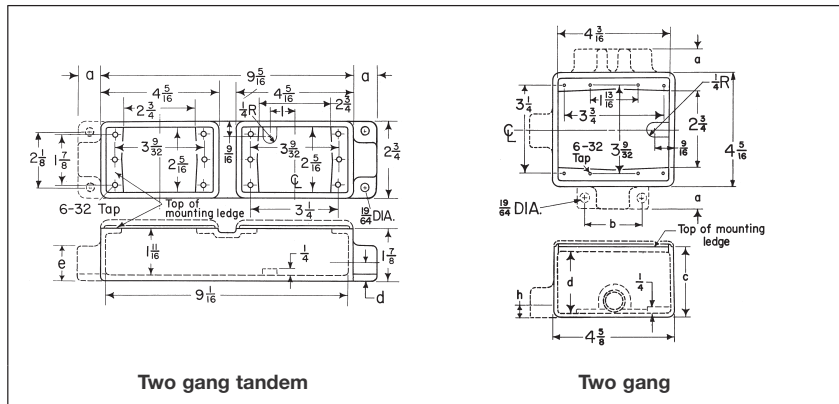

Two gang tandem

Series	Hub Size	a	b	e
FS	1/2	7/8	5/8	1 1/4
	3/4	7/8	3/4	1 1/2

Two gang

Series	Hub Size	a	b	c	d	h
FS	1/2	7/8	2 1/4	1 7/8	1 11/16	5/8
	3/4	7/8	2 1/4	1 7/8	1 11/16	3/4
	1	1	2 1/2	1 7/8	1 11/16	7/8
FD	1/2	7/8	2 1/4	2 11/16	2 1/2	5/8
	3/4	7/8	2 1/4	2 11/16	2 1/2	3/4
	1	1	2 1/2	2 11/16	2 1/2	7/8

2F

Condulet® Multi-Gang Device Boxes - Cast Iron or Aluminum

Accessories
see pages 37-45

With and Without Mounting Lugs for
Threaded Rigid and IMC Conduit

2F

FSS & FDS



Two Gang

Size	Cat. #	Cat. #
3/4	FSS222	FDS222

FSD

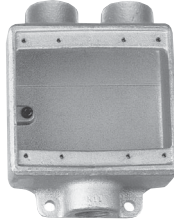

Two Gang

Size	Cat. #
3/4	FSD212*

*Hubs on 2 hub side are 1/2"

FS & FD

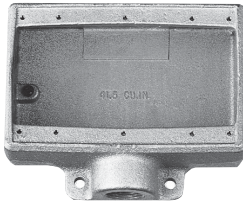

Three Gang

Size	Cat. #	Cat. #
3/4	FS23	FD23
1	FS33	

FSS

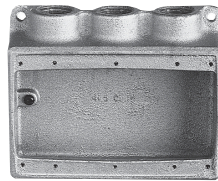

Three Gang

Size	Cat. #
3/4	FSS23

Dimensions

In Inches:

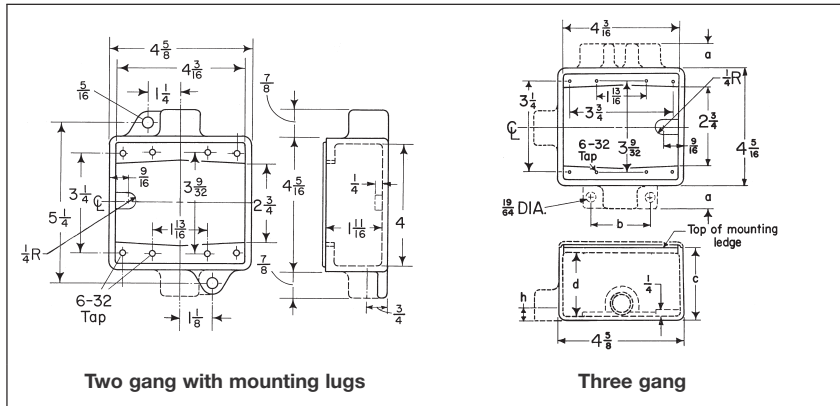

Three gang

Series	Hub Size	a	c	d
FS	3/4	7/8	1 7/8	1 11/16
	1	1	1 7/8	1 11/16
FD	3/4	7/8	2 11/16	2 1/2