



Non-metallic and

Metal Covers



PUT A RECEPTACLE IN THE FLOOR THE EASY WAY!

**FLOOR BOX KITS and
Boxes • Covers • Accessories**



NON-METALLIC BOXES THREE STYLES



FLUSH FIT

FOR NEW OR EXISTING FLOORS

Arlington's **UL Listed FLOOR BOX KITS** offer installers the low cost, *convenient* way to put a receptacle in the floor – with a box that installs flush with the floor.

We have a floor box for nearly any job site condition. There's one for new concrete pours, a box for existing floors – and an *adjustable* box that fits most finished floor heights up to 2". All are available with oversized non-metallic or metal covers. And all install flush with the floor surface

COVERS Our non-metallic boxes have gasketed covers that prevent water intrusion – with your choice of threaded plugs or flip lids that protect the receptacle when it's not in use. Best of all, they're oversized to hide miscut flooring!

Arlington's single-gang floor box kits are available with metal or non-metallic covers in a variety of colors and finishes.

Non-metallic in white, black, brown, light almond and **metal** in brass and nickel-plated brass.



ON EXISTING FLOORS

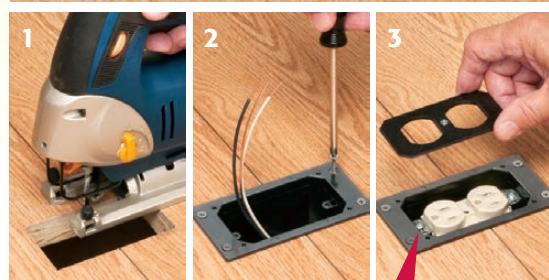
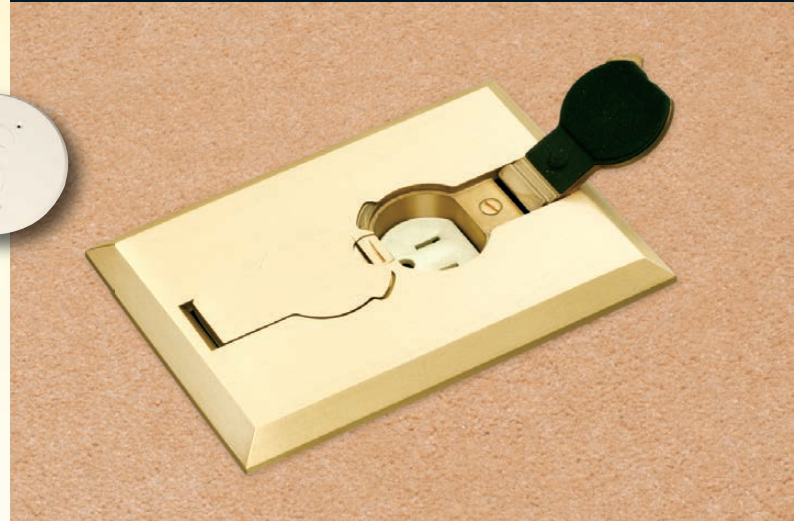

Easy to install in an Existing Floor...Cut the opening...install

See pages 8-15 for **INTERCHANGEABLE, COST-EFFECTIVE Single and Two-Gang Floor Box Kits, Boxes, Covers and Accessories.**



View Video



FLBR101BR
Rectangular,
Brown Cover

ADJUSTS TO FINAL FLOOR HEIGHT



FOR FLOORS UP TO 2" THICK

FOR NEW CONCRETE POURS

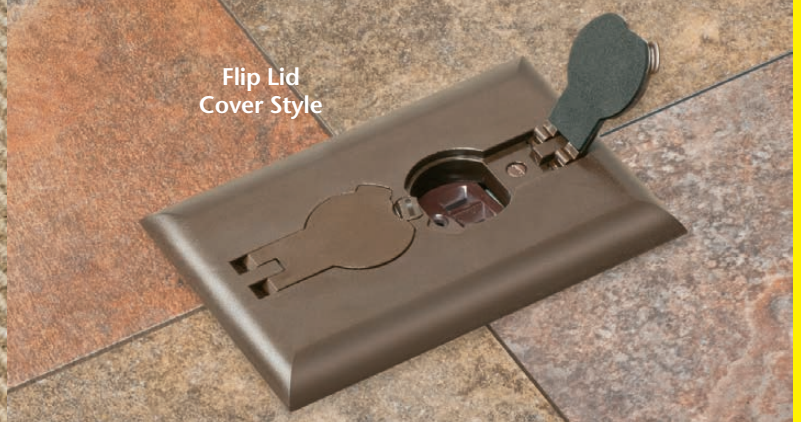

Flip Lid
Cover Style

Supplied with 1/8", 1/4", 1/2" and 3/4" spacers to allow for increases in floor thickness; tile, wood, carpet, etc.



Adjustable boxes for varying floor heights

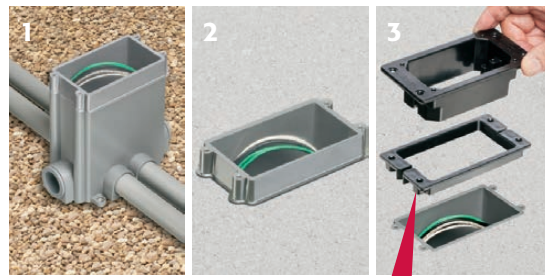

Supplied spacers allow for adjustment to final floor thickness



FLBA101MB
Rectangular,
Brass Cover

Adjustable Bracket
positions box
flush with floor



FLBCF101MB
Brass Cover
with Flip Lids

UL LISTED FLOOR BOX KITS

FOR EXISTING FLOORS

FOR EXISTING FLOORS



FLBR101LA

CATALOG NUMBER	UPC/DCI/NAED MFG. #018997	DESCRIPTION	COVER MATERIAL	COVER STYLE/SHAPE	COVER COLOR	UNIT PKG	STD PKG
FLBRF101W	16253	20.0 cubic inch BOX FOR EXISTING FLOORS	Non-Metallic	RECTANGULAR with TWO FLIP LIDS	White	1	4
FLBRF101LA	16252		Non-Metallic		Light Almond	1	4
FLBRF101BR	16251		Non-Metallic		Brown	1	4
FLBRF101BL	16250		Non-Metallic		Black	1	4
FLBRF101MB	16254		Metal		Brass	1	4
FLBRF101NL	16255	Flush-to-the-floor Installation. Put a receptacle where you need it...easy.	Metal		Nickel-plated brass	1	4
FLBR101W	04356		Non-Metallic	RECTANGULAR with TWO THREADED PLUGS	White	1	4
FLBR101LA	04357		Non-Metallic		Light Almond	1	4
FLBR101BR	04359		Non-Metallic		Brown	1	4
FLBR101BL	04358		Non-Metallic		Black	1	4
FLBR101MB	52263		Metal		Brass	1	4
FLBR101NL	52453		Metal		Nickel-plated brass	1	4

Includes: Floor Box, duplex receptacle, (1) NM94 connector, back plate on non-metallic covers, gasketed cover, (5) #6-32 cover plate screws and threaded plugs or flip lids.



FLBRF101MB



FLBRF101W



FLBRF101BL

Not shown:

FLBRF101NL (Nickel-plated cover with flip lids)

FLBRF101BR (Non-metallic, brown cover with flip lids)



FLBRF101LA

INSTALLS FLUSH WITH FLOOR



FLBR101MB



FLBR101NL



FLBR101BL



FLBR101BR

Not shown:

FLBR101W (Non-metallic, white cover with threaded plugs)



FLBR101LA



View Video



UL LISTED FLOOR BOX KITS

**ADJUSTABLE...
FOR FLOORS
UP TO 2" H**

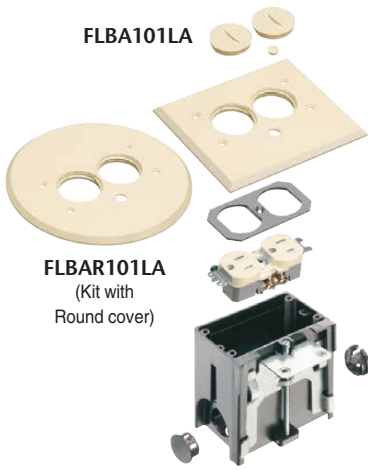

CATALOG NUMBER	UPC/DCI/NAED MFG. #018997	DESCRIPTION UL Listed Floor Box Kit	COVER MATERIAL	COVER STYLE/SHAPE	COVER COLOR	UNIT PKG	STD PKG
FLBAF101W	04340		Non-Metallic		White	1	4
FLBAF101LA	04341		Non-Metallic	RECTANGULAR	Light Almond	1	4
FLBAF101BR	04343		Non-Metallic	with	Brown	1	4
FLBAF101BL	04342		Non-Metallic	TWO FLIP LIDS	Black	1	4
FLBAF101MB	13805		Metal		Brass	1	4
FLBAF101NL	13806	18.3 cubic inch ADJUSTABLE BOX	Metal		Nickel-plated brass	1	4
FLBA101W	04344	Fits most finished floor heights up to 2"	Non-Metallic	RECTANGULAR	White	1	4
FLBA101LA	04345		Non-Metallic	with	Light Almond	1	4
FLBA101BR	04347		Non-Metallic	TWO THREADED PLUGS	Brown	1	4
FLBA101BL	04346		Non-Metallic		Black	1	4
FLBA101MB	52259		Metal		Brass	1	4
FLBA101NL	52450		Metal		Nickel-plated brass	1	4
FLBAR101W	04348		Non-Metallic	ROUND	White	1	4
FLBAR101LA	04349		Non-Metallic	with	Light Almond	1	4
FLBAR101BR	04351		Non-Metallic	TWO THREADED PLUGS	Brown	1	4
FLBAR101BL	04350		Non-Metallic		Black	1	4
FLBAR101MB	52261		Metal		Brass	1	4
FLBAR101NL	52451		Metal		Nickel-plated brass	1	4

Includes: Adjustable Floor Box, (1) tamper-resistant ("TR") duplex receptacle, (1) cover plate w/ gasket, flip lids or threaded plugs, (2) #6-32 x 1" long screws, (2) #6 drywall screws, (1) NM94 connector, (1) NM900 plug, (1) cap (covers adjustable screw hole in cover plate)

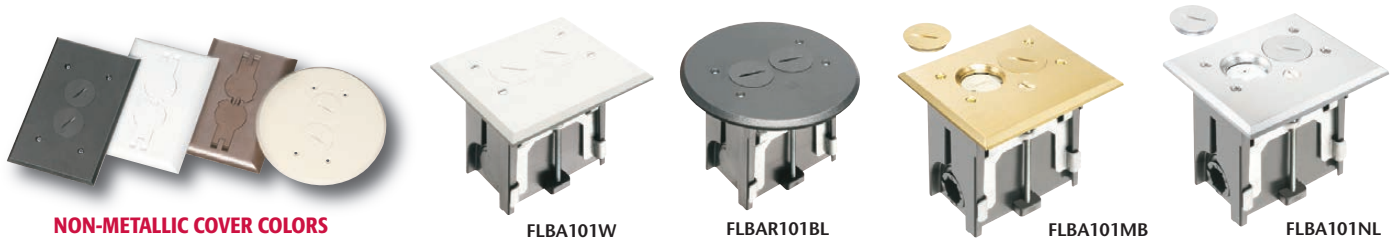

NON-METALLIC COVER COLORS

FLBA101W

FLBAR101BL

FLBA101MB

FLBA101NL



1 ADJUSTS TO FINISHED FLOOR HEIGHT

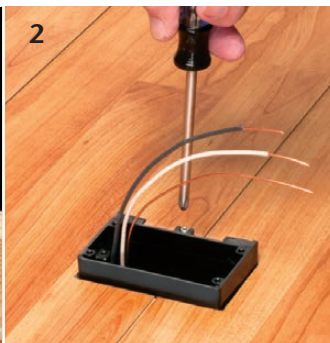

2

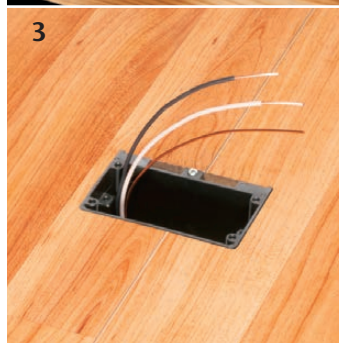

3



4

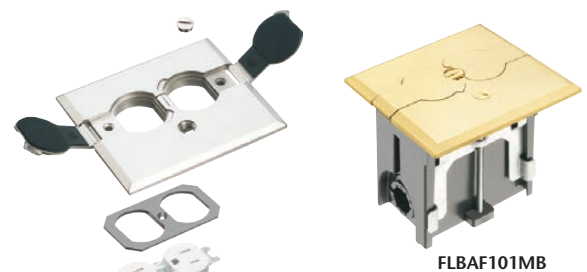

FLBAF101MB

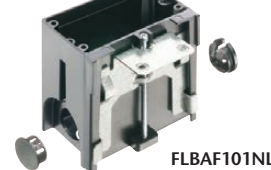

FLBAF101NL



UL LISTED FLOOR BOX KITS

FOR CONCRETE POURS



FOR NEW CONCRETE



FLBCF101BR



FLBC101BL

CATALOG NUMBER	UPC/DCI/NAED MFG. #018997	DESCRIPTION UL Listed Floor Box Kit	COVER MATERIAL	COVER STYLE/SHAPE	COVER COLOR	UNIT PKG	STD PKG
FLBCF101W	06950	BOX FOR NEW CONCRETE Includes spacers for adjusting box to finished floor height 	Non-Metallic	RECTANGULAR with TWO FLIP LIDS	White	1	1
FLBCF101LA	06951		Non-Metallic		Light Almond	1	1
FLBCF101BR	06952		Non-Metallic		Brown	1	1
FLBCF101BL	06953		Non-Metallic		Black	1	1
FLBCF101MB	52454		Metal		Brass	1	1
FLBCF101NL	52455		Metal		Nickel-plated brass	1	1
FLBC101W	04352		Non-Metallic	RECTANGULAR with TWO THREADED PLUGS	White	1	1
FLBC101LA	04353		Non-Metallic		Light Almond	1	1
FLBC101BR	04355		Non-Metallic		Brown	1	1
FLBC101BL	04354		Non-Metallic		Black	1	1
FLBC101MB	52265		Metal		Brass	1	1
FLBC101NL	52452		Metal		Nickel-plated brass	1	1

Includes: Concrete box, mud cover, (4) 3/4" plugs, (2) 1" plugs, (1) 1/8" spacer, (1) 1/4" spacer, (1) 1/2" spacer and (1) 3/4" spacer, mounting bracket, duplex receptacle, gasketed cover plate, (5) #6-32 x 1/2" long cover plate screws, (4) #8 x 5/8" long sheet metal screws, (4) #8 x 1-1/4" long sheet metal screws and threaded plugs or flip lids.



(1) Gasketed cover with flip lids **OR** threaded plugs



FLBC101NL



FLBC101MB

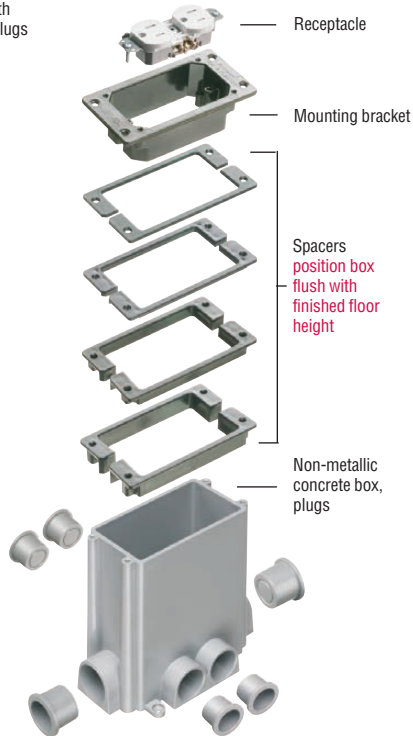

View Video



ROUGH-IN & TRIM KITS

FOR NEW CONCRETE

ROUGH-IN KIT

Non-metallic concrete box and plugs



CATALOG NUMBER	UPC/DCI/NAED MFG. #018997	DESCRIPTION Rough-In Kit	BOX MATERIAL	COLOR	UNIT PKG	STD PKG
FLBC101RK	13820	Non-metallic concrete box, plugs and mud cover	Non-Metallic	Gray plastic	1	1

Includes: Concrete box, (4) 3/4" plugs, (2) 1" plugs and mud cover (not shown)

TRIM KIT



CATALOG NUMBER	UPC/DCI/NAED MFG. #018997	DESCRIPTION Trim Kit	COVER MATERIAL	COVER STYLE/SHAPE	COVER COLOR	UNIT PKG	STD PKG
FLBCF101WTK	13827		Non-Metallic		White	1	1
FLBCF101LATK	13828	TRIM KIT	Non-Metallic	RECTANGULAR COVER with TWO FLIP LIDS	Light Almond	1	1
FLBCF101BRBK	13829	Includes (4) spacers, mounting bracket, receptacle, (1) gasketed cover with flip lids	Non-Metallic		Brown	1	1
FLBCF101BLTK	13830		Non-Metallic		Black	1	1
FLBCF101MBTK	13831		Metal		Brass	1	1
FLBCF101NLTK	13832		Metal		Nickel-plated brass	1	1
FLBC101WTK	13821	TRIM KIT	Non-Metallic	RECTANGULAR COVER with TWO THREADED PLUGS	White	1	1
FLBC101LATK	13822	Includes (4) spacers, mounting bracket, receptacle, (1) gasketed cover with threaded plugs	Non-Metallic		Light Almond	1	1
FLBC101BRBK	13823		Non-Metallic		Brown	1	1
FLBC101BLTK	13824		Non-Metallic		Black	1	1
FLBC101MBTK	13825		Metal		Brass	1	1
FLBC101NLTK	13826		Metal		Nickel-plated brass	1	1

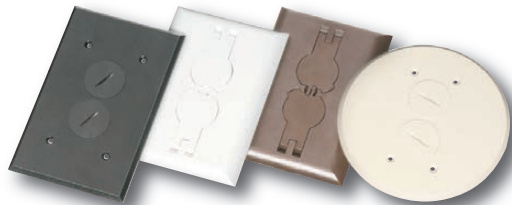

NON-METALLIC COVER COLORS



BRASS & NICKEL-PLATED BRASS METAL COVERS

INTERCHANGEABLE

FLOOR BOX KITS, COVERS, ACCESSORIES

NEW & EXIST

FOR NEW OR EXISTING FLOORS

Arlington's cost-effective **FLOOR BOX KITS** offer installers the low cost, *convenient* way to install a receptacle *flush with the floor* wherever your customer needs one.

This new series of floor box kits, covers and accessories is designed for installation convenience in new and existing floors, and new concrete pours (Page 9) – as well as interchangeability with a variety of other manufacturers' floor boxes.

Available with a **steel** box and a gasketed brass or nickel-plated brass cover to prevent water intrusion, the cover comes with threaded plugs or flip lids to protect the receptacle when it's not in use.

With a variety of floor box kits and individual metal covers and accessories, Arlington offers just about any option you could possibly need...

- Single and two-gang floor box kits...and a *combination* box kit with an installed divider for power and low voltage in the same box.
- Rectangular or square metal covers with flip lids or threaded plugs...also sold separately.



Covers with threaded plugs for two-gang box



Cover with flip lids for single gang (or two-gang) box

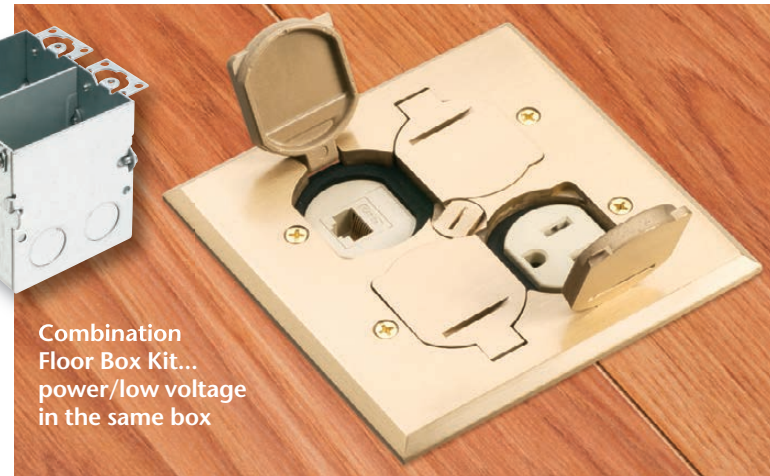
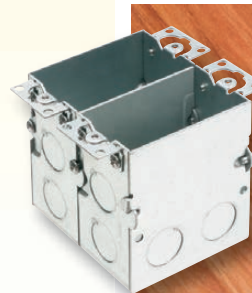

Combination Floor Box Kit... power/low voltage in the same box



COVERS TO FIT OTHER MANUFACTURERS' BOXES FOR GOOD LOOKS ANYWHERE!



ING FLOORS and NEW CONCRETE

Arlington's FLOOR BOX KITS and COVERS **FOR NEW CONCRETE** offer flexibility and convenience.

Made of heavy-duty plastic, our 4.5" non-metallic **concrete box**

is a universal "fits all" size, that accommodates our 6" round covers as well as *most other round covers on the market.*

Our versatile concrete box **covers** are available with flip lids or threaded plugs – in brass or nickel-plated brass. They deliver easier-than-ever installation of receptacles so they'll look great wherever they're installed!

A selection of leveling rings and adapters allows our covers to fit our boxes *and* most other manufacturers' concrete boxes.

For the fastest installation, our trapdoor covers ship *ready to use* with a pre-installed gasket and decorator-style receptacle.



Flip Lid Cover for concrete box



Nickel-plated
FLBT6615NL
(closed)



FLBT6615NL
(open)



Brass Trapdoor style
FLBT6615MB
(open and back)

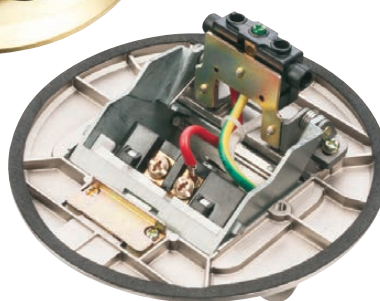

COVERS WITH FLIP LIDS

FLB5331NL
Single-gang with nickel cover

(exploded views)

FLB5551MB
Two-gang with brass cover



CATALOG NUMBER	UPC/DCI/NAED MFG. #018997	DESCRIPTION COVERS WITH FLIP LIDS	COVER SIZE & STYLE	COVER SHAPE	UNIT PKG	STD PKG
FLOOR BOX KITS • with STEEL BOX						
FLB5331MB	22019	Single-gang steel box, gaskets, (1) duplex receptacle, gasketed cover, mounting screws	Brass with Two Flip Lids	■	1	4
FLB5331NL	22020	Single-gang steel box, gaskets, (1) duplex receptacle, gasketed cover, mounting screws	Nickel-plated with Two Flip Lids	■	1	4
FLOOR BOX KITS • with STEEL BOX						
FLB5551MB	22038	Two-gang steel box, gaskets, (2) duplex receptacles, gasketed cover, mounting screws	Brass with Four Flip Lids	■	1	4
FLB5551NL	22039	Two-gang steel box, gaskets, (2) duplex receptacles, gasketed cover, mounting screws	Nickel-plated w/ Four Flip Lids	■	1	4
METAL GASKETED COVERS with receptacle						
FLB5330MB	22017	Brass Cover	Single-gang with Two Flip Lids	■	1	10
FLB5330NL	22018	Nickel-plated Cover	Single-gang with Two Flip Lids	■	1	10
FLB5550MB	22036	Brass Cover	Two-gang with Four Flip Lids	■	1	10
FLB5550NL	22037	Nickel-plated Cover	Two-gang with Four Flip Lids	■	1	10
FLOOR BOX KITS • with TWO-GANG STEEL COMBO BOX						
FLB5552MB	22050	Two-gang steel box with installed low voltage divider, gaskets, (1) duplex receptacle, (1) low voltage duplex plate, mounting screws	Brass with Four Flip Lids	■	1	4
FLB5552NL	22051	Two-gang steel box with installed low voltage divider, gaskets, (1) duplex receptacle, (1) low voltage duplex plate, mounting screws	Nickel-plated with Four Flip Lids	■	1	4

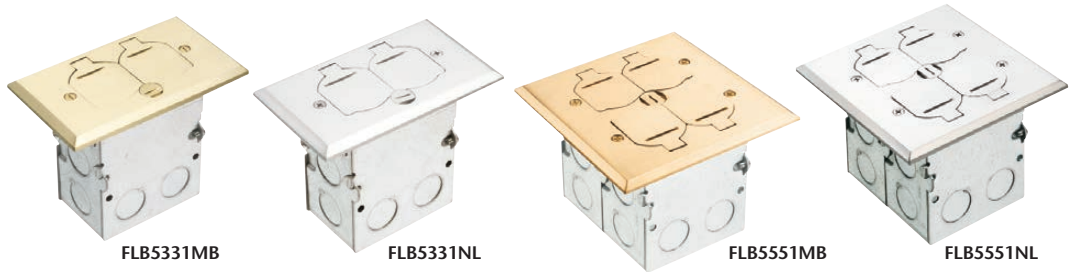

SINGLE & TWO-GANG FLOOR BOX KITS

COMBINATION POWER/LOW VOLTAGE FLOOR BOX KIT



FLB5552MB
Power/Low Voltage Combo Box

FLB5552NL combo box with nickel-plated cover



Divider separates power & low voltage

FLB5552MB



Arlington

Carlson • T&B	Hubbell	Lew	WireMold • P&S
71W-DS	B2481 + S3825 (needs receptacle)	SWB-2-LR	880W1818TCAL (needs receptacle)
71W-DS-N	B2481 + SA3825 (needs receptacle)	SWB-2-LRA	880W1818TCAL (needs receptacle)
62W + (2) 64-DS (needs receptacle)	B2482 + SB3082 + (2) S3925	SWB-4-PQ-LR	880W2827B (needs receptacle)
62W + (2) 64-AL (needs receptacle)	B2482 + SB3082 + (2) SA3825	SWB-4-PQ-LR	880W2827B (needs receptacle)
P-64-DS	S3825	RRP-2-LRR	828R
P-64-DS-AL	SA3825	RRP-2-LR-AR	828R-TCAL
(2) 64-DS	SB3084 + S3825	RRP-4-BP-LR	(2) 828R
(2) 64-DS-AL	SB3082 + (2) SA3825	RRP-4-PQ-LR-A	(2) 828R-TCAL
----	----	----	----
----	----	----	----

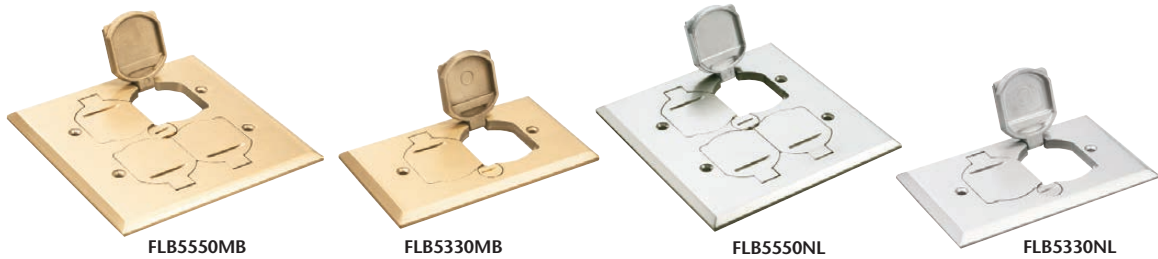

ARLINGTON'S METAL GASKETED COVERS with FLIP LIDS

Arlington's steel floor outlet boxes are compatible with our metal floor box covers on pages 10 and 12. Features include: installed grounding screw, adjustable mounting ears and multiple 1/2" knockouts.

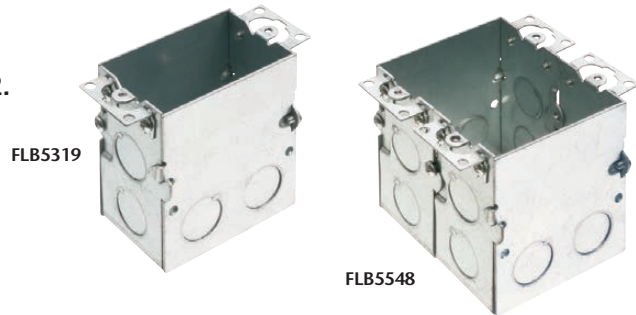

STEEL OUTLET BOXES FOR NEW OR RETROFIT CONSTRUCTION

CATALOG NUMBER	UPC/DCI/NAED MFG. #018997	DESCRIPTION	CUBIC INCHES	# OF KNOCKOUTS	UNIT PKG	STD PKG
FLB5319	22060	Single-gang Steel Floor Outlet Box	18.0	9	1	10
FLB5548	22061	Two-gang Steel Floor Outlet Box	36.0	14	1	10
FLB5549	22062	Two-gang Steel Floor Combination Box with installed (removable) divider for power/low voltage	36.0	14	1	10



COVERS WITH THREADED PLUGS



FLB5541MB
Floor Box Kit
(exploded view)

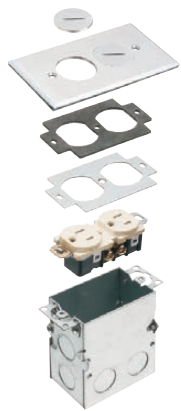

FLB5321NL
(exploded view)

CATALOG NUMBER	UPC/DCI/NAED MFG. #018997	DESCRIPTION COVERS WITH FLIP LIDS	COVER SIZE & STYLE	COVER SHAPE	UNIT PKG	STD PKG
FLOOR BOX KIT • with STEEL BOX						
FLB5321MB	22015	Single-gang steel box, gaskets, receptacle, gasketed cover, mounting screws	Brass with Two Threaded Plugs	■	1	4
FLB5321NL	22016		Nickel-plated with Two Threaded Plugs	■	1	4
FLB5541MB	22034	Two-gang steel box, gaskets, receptacles, gasketed cover, mounting screws	Brass with Four Threaded Plugs	■	1	4
FLB5541NL	22035		Nickel-plated with Four Threaded Plugs	■	1	4
METAL GASKETED COVER with receptacle						
FLB5320MB	22013	Brass Cover	Single-gang with Two Threaded Plugs	■	1	10
FLB5320NL	22014	Nickel-plated Cover	Single-gang with Two Threaded Plugs	■	1	10
FLB5540MB	22005	Brass Cover	Two-gang with Four Threaded Plugs	■	1	10
FLB5540NL	22033	Nickel-plated Cover	Two-gang with Four Threaded Plugs	■	1	10



FLB5321MB



FLB5321NL



FLB5541MB



FLB5541NL

SINGLE & TWO-GANG FLOOR BOX KITS



FLB5541NL



Arlington

Carlson • T&B	Hubbell	Lew	WireMold • P&S
61W + P-64-DU (needs receptacle)	B2481 + S3625 (needs receptacle)	SWB-2	880W1+828SPTC (needs receptacle)
61W + P-64-DU-AL (needs receptacle)	B2481 + SA3625 (needs receptacle)	SWB-2-NS	(2) 828SPTC
62W + (2) P-64-DU (needs receptacle)	B2482 + SB3084W + SA3625	SWB-4-PQ	880W2
62W + (2) P-64-DU-AL	B2482 + SA3084 + (2)SA3625	SWB-4-PQ-A	880W2 + (2) 828SPTC
P-64-DU	S3625	RRP-2-BR	828SPTC
P-64-DU-AL	SA3625	RRP-2-NS	-----
(2) P-64-DU	SB3084W + (2) SA3625	RRP-4-BP	880W1+(2) 828SPTC
(2) P-64-DU-AL	SA3084W + (2) SA3625	RRP-4-BP-A	(2) 828SPTC



FLB5540MB



FLB5320MB



FLB5540NL



FLB5320NL

ARLINGTON'S METAL GASKETED COVERS with THREADED PLUGS

Arlington's single and two-gang steel floor outlet boxes are compatible with our metal floor box covers on pages 10 and 12.

Features include: installed grounding screw, adjustable mounting ears and multiple 1/2" knockouts.



FLB5319



FLB5548

STEEL OUTLET BOXES FOR NEW OR RETROFIT CONSTRUCTION

CATALOG NUMBER	UPC/DCI/NAED MFG. #018997	DESCRIPTION	CUBIC INCHES	# OF KNOCKOUTS	UNIT PKG	STD PKG
FLB5319	22060	Single-gang Steel Floor Outlet Box	18.0	9	1	10
FLB5548	22061	Two-gang Steel Floor Outlet Box	36.0	14	1	10

FOR NEW CONCRETE POURS



FLBC4500
(Mud cover in place)

CATALOG NUMBER	UPC/DCI/NAED MFG. #018997	DESCRIPTION	NOTES	UNIT PKG	STD PKG
FLBC4500	22010	4.5" Non-metallic Round Box for Concrete Pours (conduit plugs, mud cover, voltage divider)		1	5
FLB6230MB	22025	Cover Kit 6" Round, Brass w two flip lids	*hole pattern fits FLBC4500LR	1	10
FLB6230NL	22026	Cover Kit 6" Round, Nickel-plated w two flip lids	*hole pattern fits FLBC4500LR	1	10
FLB6220MB	22021	Cover Kit 6" Round, Brass w two threaded plugs	*hole pattern fits FLBC4500LR	1	10
FLB6220NL	22022	Cover Kit 6" Round, Nickel-plated w two threaded plugs	*hole pattern fits FLBC4500LR	1	10
FLBC4500LR	22011	Leveling Ring for Arlington FLBC4500 & above round covers (has bosses for cover mounting)		1	10
FLBT6615MB	22030	Trapdoor Cover Round, Brass. Pre-mounted gasket & decorator-style 15A receptacle		1	10
FLBT6615NL	22031	Trapdoor Cover Round, Nickel-plated. Pre-mounted gasket & decorator-style 15A receptacle		1	10
FLBT6615LR	22029	Leveling Ring for Arlington FLBC4500 box w FLBT6615 trapdoor style cover		1	10
FLBC4500AR	22004	Oversized Adapter Ring for 5" diameter concrete boxes		1	10
FLBC4500Y	22012	"Y" Adapter - Provides (2) 1" openings for conduit entering 1" hub		1	10

NON-METALLIC CONCRETE BOX



FLBC4500
Exploded view of components. (Mud cover not shown)

COVER KITS with FLIP LIDS

FLB6230MB
Brass cover

Includes cover with flip lids, gaskets, receptacle.

Also available with Nickel-plated cover **FLB6230NL** (not shown)



COVER KITS with THREADED PLUGS

FLB6220MB
Brass cover

Includes cover with threaded plugs, gaskets, receptacle.

FLB6220NL
Nickel-plated cover

(NOT SHOWN)

LEVELING RING

Hole pattern fits above round covers:
FLB6230MB
FLB6230NL
FLB6220MB
FLB6220NL

FLBC4500LR

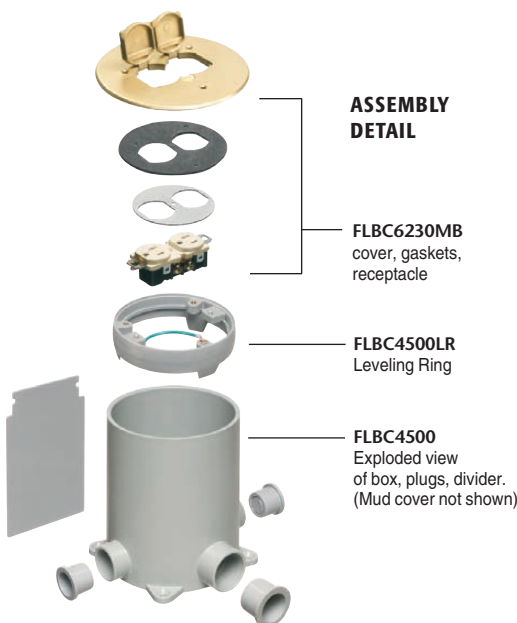
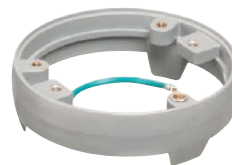

Carlson • T&B	Hubbell	Lew	WireMold • P&S
E971FB, 68P	PFB1	FB	881 E971FB, 68P
E97BR2, P60DS	S3925 + S3082	TCP-2-LR	895T E97BR2, P60DS
E97SS2, P60CACP	-----	TCP-LR-A	895 E97SS2, P60CACP
P-60-DUP-60-CP	S3725 + S3082	TCP-2	895SP P-60-DUP-60-CP
-----	-----	-----	-----
E97ABR2, 68-PAR	PFBA1	LRA	881ADP E97ABR2, 68-PAR
-----	-----	PUFP-BD	-----
-----	-----	PUFF-SD	-----
-----	-----	PUFF-LRA	-----
-----	-----	LRA-HT	-----
E972Y	PFBYA1	Y-CONN	N/A E972Y

ARLINGTON'S TRAPDOOR COVERS & LEVELING RING



FLBT6615MB
Trapdoor cover
(open & closed)



FLBT6615NL
Trapdoor cover



FLBT6615LR
Leveling Ring
for trapdoor covers



FLBT6615MB
Trapdoor cover
on **FLBC4500**
Concrete box



FLBT6615NL

ARLINGTON'S ADAPTERS



FLBC4500AR
Oversized
Adapter Ring



FLBC4500Y
"Y" Adapter



FLOOR BOX KITS

FOR GOOD
LOOKS
ANYWHERE

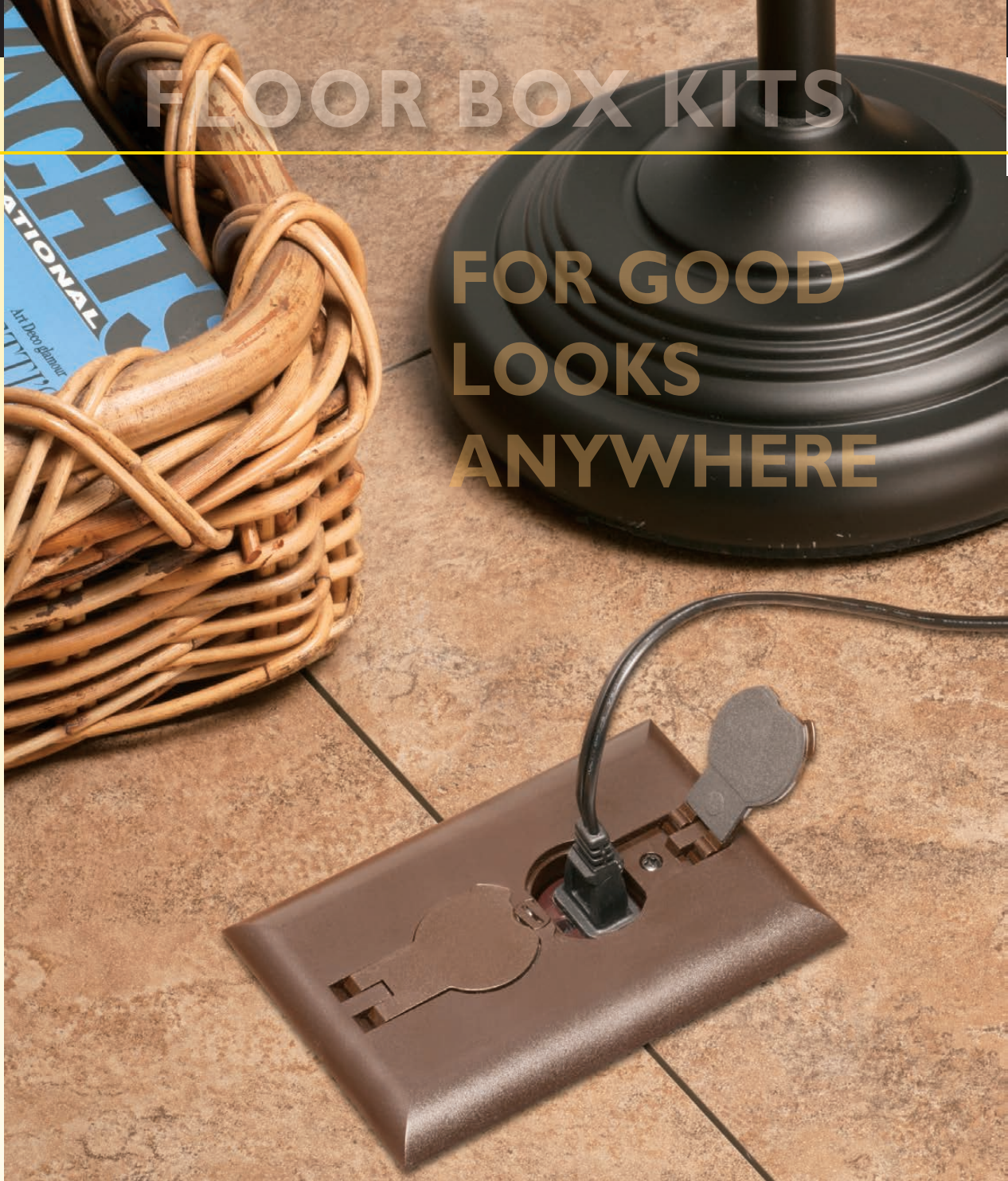

FLOOR
BOX KITS

and INTERCHANGEABLE FLOOR BOXES • COVERS • ACCESSORIES



Arlington

Distributed by



Non-metallic and

Metal Covers



PUT A RECEPTACLE IN THE FLOOR THE EASY WAY!

**FLOOR BOX KITS and
Boxes • Covers • Accessories**



NON-METALLIC BOXES THREE STYLES



FLUSH FIT

FOR NEW OR EXISTING FLOORS

Arlington's **UL Listed FLOOR BOX KITS** offer installers the low cost, *convenient* way to put a receptacle in the floor – with a box that installs flush with the floor.

We have a floor box for nearly any job site condition. There's one for new concrete pours, a box for existing floors – and an *adjustable* box that fits most finished floor heights up to 2". All are available with oversized non-metallic or metal covers. And all install flush with the floor surface

COVERS Our non-metallic boxes have gasketed covers that prevent water intrusion – with your choice of threaded plugs or flip lids that protect the receptacle when it's not in use. Best of all, they're oversized to hide miscut flooring!

Arlington's single-gang floor box kits are available with metal or non-metallic covers in a variety of colors and finishes.

Non-metallic in white, black, brown, light almond and **metal** in brass and nickel-plated brass.



ON EXISTING FLOORS

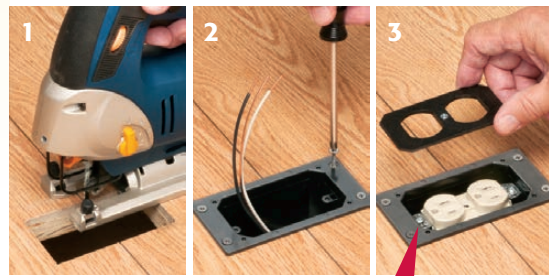
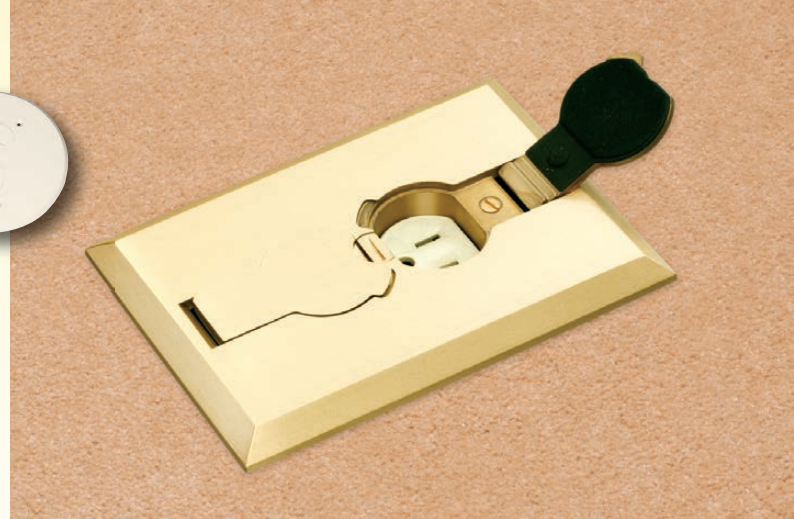

Easy to install in an Existing Floor...Cut the opening...install

See pages 8-15 for **INTERCHANGEABLE, COST-EFFECTIVE Single and Two-Gang Floor Box Kits, Boxes, Covers and Accessories.**



View Video



FLBR101BR
Rectangular,
Brown Cover

ADJUSTS TO FINAL FLOOR HEIGHT



FOR FLOORS UP TO 2" THICK

FOR NEW CONCRETE POURS

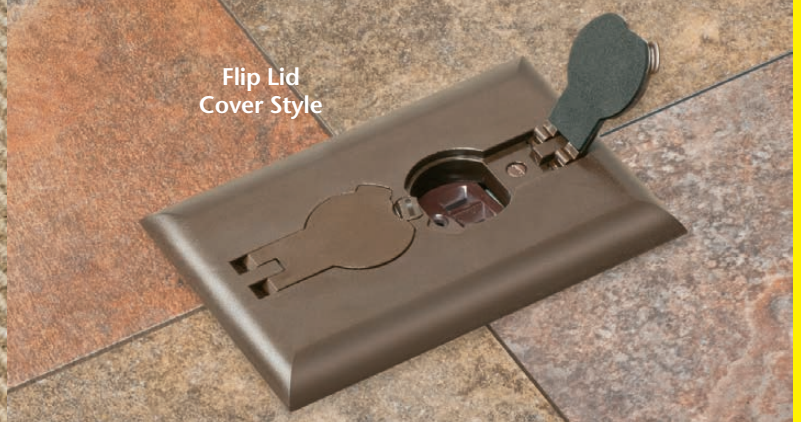

Flip Lid
Cover Style

Supplied with 1/8", 1/4", 1/2" and 3/4" spacers to allow for increases in floor thickness; tile, wood, carpet, etc.



Adjustable boxes for varying floor heights

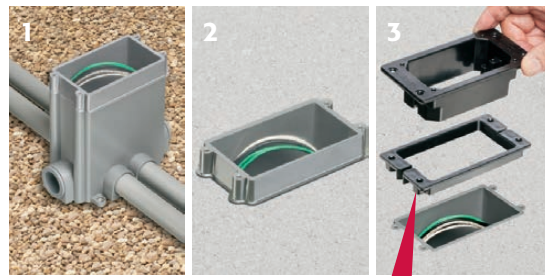

Supplied spacers allow for adjustment to final floor thickness



FLBA101MB
Rectangular,
Brass Cover

Adjustable Bracket
positions box
flush with floor



FLBCF101MB
Brass Cover
with Flip Lids

UL LISTED FLOOR BOX KITS

FOR EXISTING FLOORS

FOR EXISTING FLOORS



FLBR101LA

CATALOG NUMBER	UPC/DCI/NAED MFG. #018997	DESCRIPTION	COVER MATERIAL	COVER STYLE/SHAPE	COVER COLOR	UNIT PKG	STD PKG
FLBRF101W	16253	20.0 cubic inch BOX FOR EXISTING FLOORS	Non-Metallic	RECTANGULAR with TWO FLIP LIDS	White	1	4
FLBRF101LA	16252		Non-Metallic		Light Almond	1	4
FLBRF101BR	16251		Non-Metallic		Brown	1	4
FLBRF101BL	16250		Non-Metallic		Black	1	4
FLBRF101MB	16254		Metal		Brass	1	4
FLBRF101NL	16255	Flush-to-the-floor Installation. Put a receptacle where you need it...easy.	Metal		Nickel-plated brass	1	4
FLBR101W	04356		Non-Metallic	RECTANGULAR with TWO THREADED PLUGS	White	1	4
FLBR101LA	04357		Non-Metallic		Light Almond	1	4
FLBR101BR	04359		Non-Metallic		Brown	1	4
FLBR101BL	04358		Non-Metallic		Black	1	4
FLBR101MB	52263		Metal		Brass	1	4
FLBR101NL	52453		Metal		Nickel-plated brass	1	4

Includes: Floor Box, duplex receptacle, (1) NM94 connector, back plate on non-metallic covers, gasketed cover, (5) #6-32 cover plate screws and threaded plugs or flip lids.



FLBRF101MB



FLBRF101W



FLBRF101BL

Not shown:

FLBRF101NL (Nickel-plated cover with flip lids)

FLBRF101BR (Non-metallic, brown cover with flip lids)



FLBRF101LA

INSTALLS FLUSH WITH FLOOR



FLBR101MB



FLBR101NL



FLBR101BL



FLBR101BR

Not shown:

FLBR101W (Non-metallic, white cover with threaded plugs)



FLBR101LA





View Video

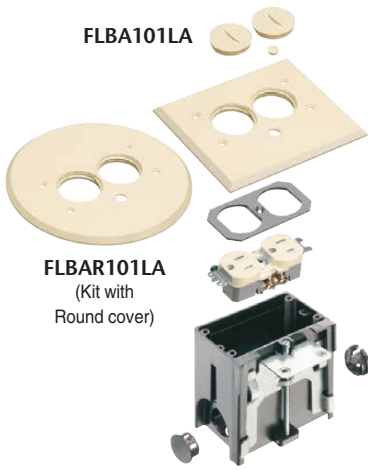

UL LISTED FLOOR BOX KITS

**ADJUSTABLE...
FOR FLOORS
UP TO 2" H**



CATALOG NUMBER	UPC/DCI/NAED MFG. #018997	DESCRIPTION UL Listed Floor Box Kit	COVER MATERIAL	COVER STYLE/SHAPE	COVER COLOR	UNIT PKG	STD PKG
FLBAF101W	04340		Non-Metallic		White	1	4
FLBAF101LA	04341		Non-Metallic	RECTANGULAR	Light Almond	1	4
FLBAF101BR	04343		Non-Metallic	with	Brown	1	4
FLBAF101BL	04342		Non-Metallic	TWO FLIP LIDS	Black	1	4
FLBAF101MB	13805		Metal		Brass	1	4
FLBAF101NL	13806	18.3 cubic inch ADJUSTABLE BOX	Metal		Nickel-plated brass	1	4
FLBA101W	04344	Fits most finished floor heights up to 2"	Non-Metallic	RECTANGULAR	White	1	4
FLBA101LA	04345		Non-Metallic	with	Light Almond	1	4
FLBA101BR	04347		Non-Metallic	TWO THREADED PLUGS	Brown	1	4
FLBA101BL	04346		Non-Metallic		Black	1	4
FLBA101MB	52259		Metal		Brass	1	4
FLBA101NL	52450		Metal		Nickel-plated brass	1	4
FLBAR101W	04348		Non-Metallic	ROUND	White	1	4
FLBAR101LA	04349		Non-Metallic	with	Light Almond	1	4
FLBAR101BR	04351		Non-Metallic	TWO THREADED PLUGS	Brown	1	4
FLBAR101BL	04350		Non-Metallic		Black	1	4
FLBAR101MB	52261		Metal		Brass	1	4
FLBAR101NL	52451		Metal		Nickel-plated brass	1	4

Includes: Adjustable Floor Box, (1) tamper-resistant ("TR") duplex receptacle, (1) cover plate w/ gasket, flip lids or threaded plugs, (2) #6-32 x 1" long screws, (2) #6 drywall screws, (1) NM94 connector, (1) NM900 plug, (1) cap (covers adjustable screw hole in cover plate)

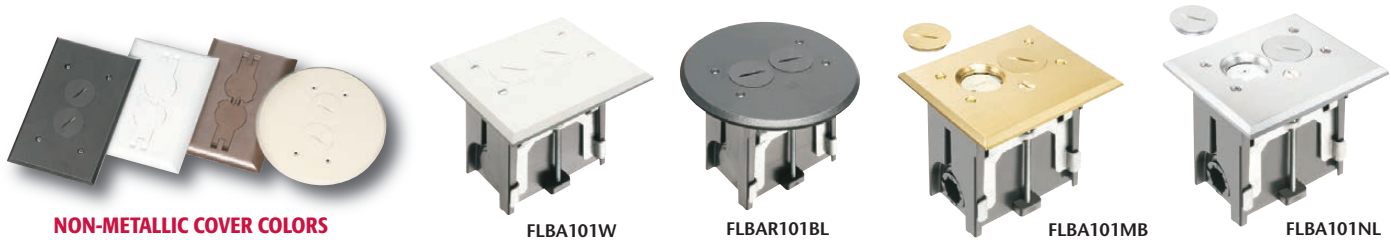

NON-METALLIC COVER COLORS

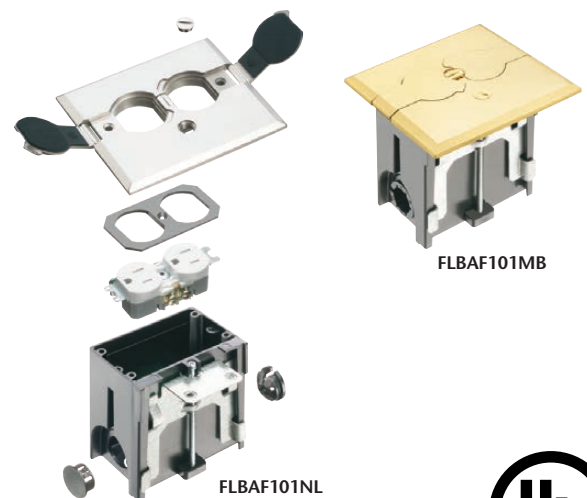
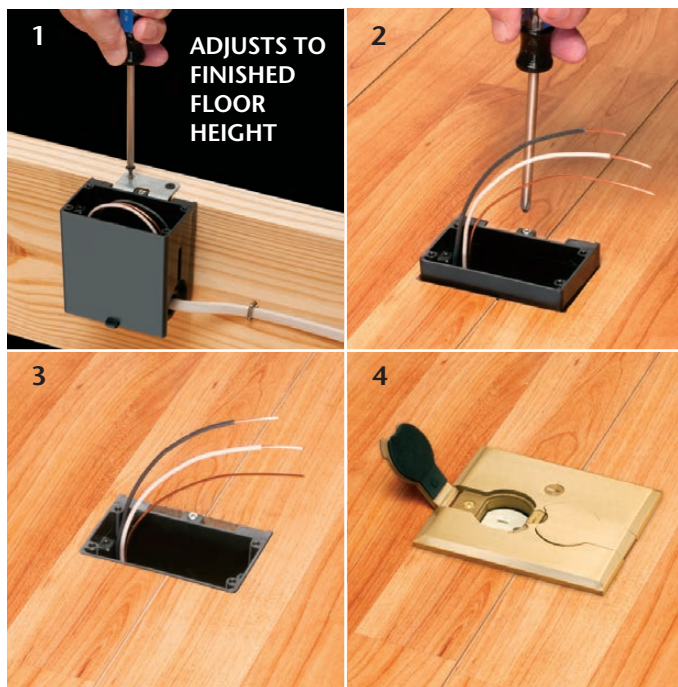

UL LISTED FLOOR BOX KITS

FOR CONCRETE POURS

FOR NEW CONCRETE



FLBCF101BR



FLBC101BL

CATALOG NUMBER	UPC/DCI/NAED MFG. #018997	DESCRIPTION UL Listed Floor Box Kit	COVER MATERIAL	COVER STYLE/SHAPE	COVER COLOR	UNIT PKG	STD PKG
FLBCF101W	06950	BOX FOR NEW CONCRETE Includes spacers for adjusting box to finished floor height	Non-Metallic	RECTANGULAR with TWO FLIP LIDS	White	1	1
FLBCF101LA	06951		Non-Metallic		Light Almond	1	1
FLBCF101BR	06952		Non-Metallic		Brown	1	1
FLBCF101BL	06953		Non-Metallic		Black	1	1
FLBCF101MB	52454		Metal		Brass	1	1
FLBCF101NL	52455		Metal		Nickel-plated brass	1	1
FLBC101W	04352		Non-Metallic	RECTANGULAR with TWO THREADED PLUGS	White	1	1
FLBC101LA	04353		Non-Metallic		Light Almond	1	1
FLBC101BR	04355		Non-Metallic		Brown	1	1
FLBC101BL	04354		Non-Metallic		Black	1	1
FLBC101MB	52265		Metal		Brass	1	1
FLBC101NL	52452		Metal		Nickel-plated brass	1	1

Includes: Concrete box, mud cover, (4) 3/4" plugs, (2) 1" plugs, (1) 1/8" spacer, (1) 1/4" spacer, (1) 1/2" spacer and (1) 3/4" spacer, mounting bracket, duplex receptacle, gasketed cover plate, (5) #6-32 x 1/2" long cover plate screws, (4) #8 x 5/8" long sheet metal screws, (4) #8 x 1-1/4" long sheet metal screws and threaded plugs or flip lids.



(1) Gasketed cover with flip lids **OR** threaded plugs



FLBC101NL



FLBC101MB

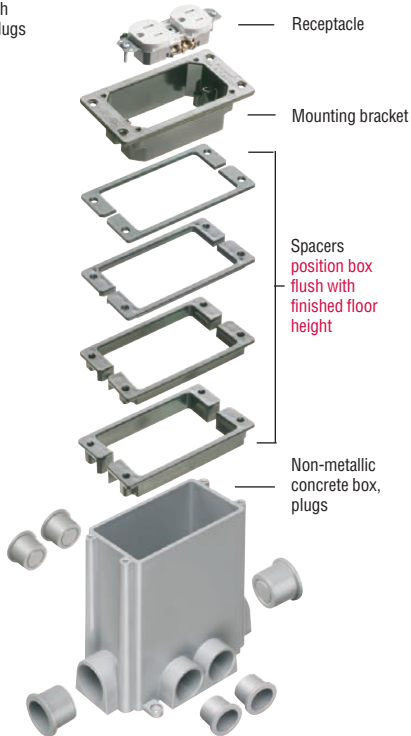

View Video



ROUGH-IN & TRIM KITS

FOR NEW CONCRETE

ROUGH-IN KIT

Non-metallic concrete box and plugs



CATALOG NUMBER	UPC/DCI/NAED MFG. #018997	DESCRIPTION Rough-In Kit	BOX MATERIAL	COLOR	UNIT PKG	STD PKG
FLBC101RK	13820	Non-metallic concrete box, plugs and mud cover	Non-Metallic	Gray plastic	1	1

Includes: Concrete box, (4) 3/4" plugs, (2) 1" plugs and mud cover (not shown)

TRIM KIT



CATALOG NUMBER	UPC/DCI/NAED MFG. #018997	DESCRIPTION Trim Kit	COVER MATERIAL	COVER STYLE/SHAPE	COVER COLOR	UNIT PKG	STD PKG
FLBCF101WTK	13827		Non-Metallic		White	1	1
FLBCF101LATK	13828	TRIM KIT	Non-Metallic	RECTANGULAR COVER with TWO FLIP LIDS	Light Almond	1	1
FLBCF101BRTK	13829	Includes (4) spacers, mounting bracket, receptacle, (1) gasketed cover with flip lids	Non-Metallic		Brown	1	1
FLBCF101BLTK	13830		Non-Metallic		Black	1	1
FLBCF101MBTK	13831		Metal		Brass	1	1
FLBCF101NLTK	13832		Metal		Nickel-plated brass	1	1
FLBC101WTK	13821	TRIM KIT	Non-Metallic	RECTANGULAR COVER with TWO THREADED PLUGS	White	1	1
FLBC101LATK	13822	Includes (4) spacers, mounting bracket, receptacle, (1) gasketed cover with threaded plugs	Non-Metallic		Light Almond	1	1
FLBC101BRTK	13823		Non-Metallic		Brown	1	1
FLBC101BLTK	13824		Non-Metallic		Black	1	1
FLBC101MBTK	13825		Metal		Brass	1	1
FLBC101NLTK	13826		Metal		Nickel-plated brass	1	1

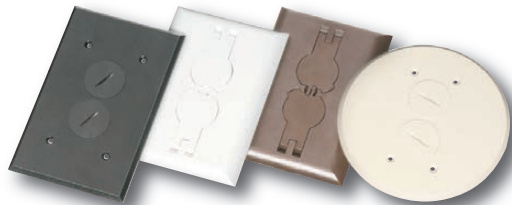

NON-METALLIC COVER COLORS



BRASS & NICKEL-PLATED BRASS METAL COVERS

INTERCHANGEABLE

FLOOR BOX KITS, COVERS, ACCESSORIES

NEW & EXIST

FOR NEW OR EXISTING FLOORS

Arlington's cost-effective **FLOOR BOX KITS** offer installers the low cost, *convenient* way to install a receptacle *flush with the floor* wherever your customer needs one.

This new series of floor box kits, covers and accessories is designed for installation convenience in new and existing floors, and new concrete pours (Page 9) – as well as interchangeability with a variety of other manufacturers' floor boxes.

Available with a **steel** box and a gasketed brass or nickel-plated brass cover to prevent water intrusion, the cover comes with threaded plugs or flip lids to protect the receptacle when it's not in use.

With a variety of floor box kits and individual metal covers and accessories, Arlington offers just about any option you could possibly need...

- Single and two-gang floor box kits...and a *combination* box kit with an installed divider for power and low voltage in the same box.
- Rectangular or square metal covers with flip lids or threaded plugs...also sold separately.



Covers with threaded plugs for two-gang box



Cover with flip lids for single gang (or two-gang) box

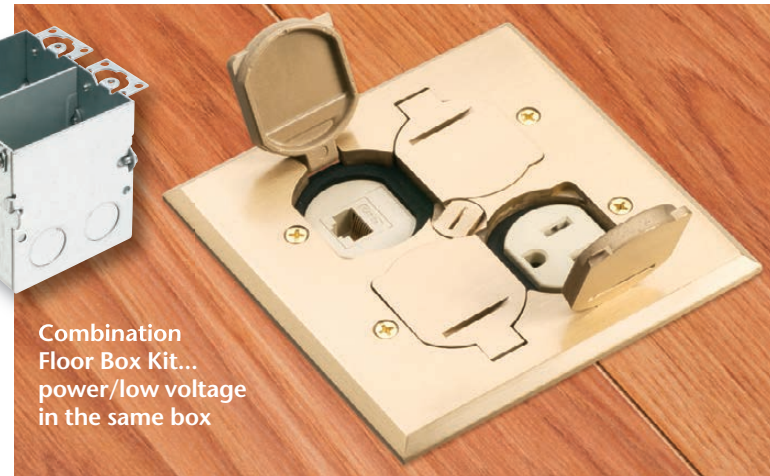
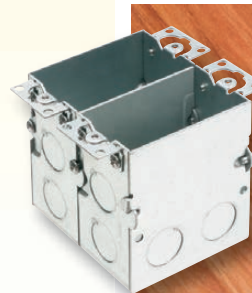

Combination Floor Box Kit... power/low voltage in the same box



COVERS TO FIT OTHER MANUFACTURERS' BOXES FOR GOOD LOOKS ANYWHERE!



Arlington

ING FLOORS and NEW CONCRETE

Arlington's FLOOR BOX KITS and COVERS **FOR NEW CONCRETE** offer flexibility and convenience.

Made of heavy-duty plastic, our 4.5" non-metallic **concrete box**

is a universal "fits all" size, that accommodates our 6" round covers as well as *most other round covers on the market.*

Our versatile concrete box **covers** are available with flip lids or threaded plugs – in brass or nickel-plated brass. They deliver easier-than-ever installation of receptacles so they'll look great wherever they're installed!

A selection of leveling rings and adapters allows our covers to fit our boxes *and* most other manufacturers' concrete boxes.

For the fastest installation, our trapdoor covers ship *ready to use* with a pre-installed gasket and decorator-style receptacle.



Flip Lid Cover for concrete box



Nickel-plated
FLBT6615NL
(closed)



FLBT6615NL
(open)



Brass Trapdoor style
FLBT6615MB
(open and back)

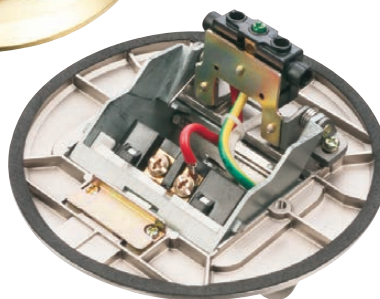

COVERS WITH FLIP LIDS

FLB5331NL
Single-gang with nickel cover

(exploded views)

FLB5551MB
Two-gang with brass cover



CATALOG NUMBER	UPC/DCI/NAED MFG. #018997	DESCRIPTION COVERS WITH FLIP LIDS	COVER SIZE & STYLE	COVER SHAPE	UNIT PKG	STD PKG
FLOOR BOX KITS • with STEEL BOX						
FLB5331MB	22019	Single-gang steel box, gaskets, (1) duplex receptacle, gasketed cover, mounting screws	Brass with Two Flip Lids	■	1	4
FLB5331NL	22020	Single-gang steel box, gaskets, (1) duplex receptacle, gasketed cover, mounting screws	Nickel-plated with Two Flip Lids	■	1	4
FLOOR BOX KITS • with STEEL BOX						
FLB5551MB	22038	Two-gang steel box, gaskets, (2) duplex receptacles, gasketed cover, mounting screws	Brass with Four Flip Lids	■	1	4
FLB5551NL	22039	Two-gang steel box, gaskets, (2) duplex receptacles, gasketed cover, mounting screws	Nickel-plated w/ Four Flip Lids	■	1	4
METAL GASKETED COVERS with receptacle						
FLB5330MB	22017	Brass Cover	Single-gang with Two Flip Lids	■	1	10
FLB5330NL	22018	Nickel-plated Cover	Single-gang with Two Flip Lids	■	1	10
FLB5550MB	22036	Brass Cover	Two-gang with Four Flip Lids	■	1	10
FLB5550NL	22037	Nickel-plated Cover	Two-gang with Four Flip Lids	■	1	10
FLOOR BOX KITS • with TWO-GANG STEEL COMBO BOX						
FLB5552MB	22050	Two-gang steel box with installed low voltage divider, gaskets, (1) duplex receptacle, (1) low voltage duplex plate, mounting screws	Brass with Four Flip Lids	■	1	4
FLB5552NL	22051	Two-gang steel box with installed low voltage divider, gaskets, (1) duplex receptacle, (1) low voltage duplex plate, mounting screws	Nickel-plated with Four Flip Lids	■	1	4

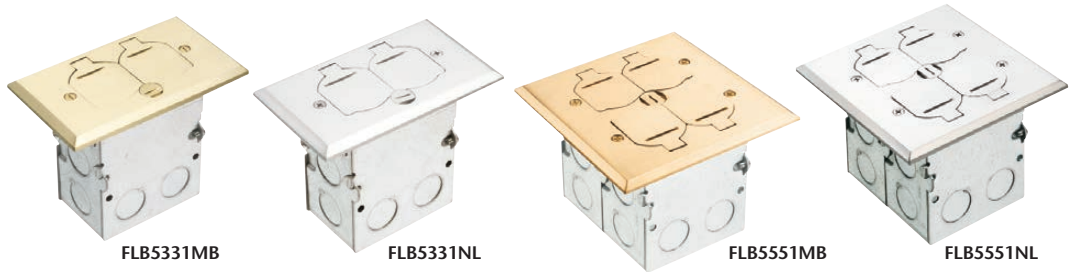

SINGLE & TWO-GANG FLOOR BOX KITS

COMBINATION POWER/LOW VOLTAGE FLOOR BOX KIT



FLB5552MB
Power/Low Voltage Combo Box

FLB5552NL combo box with nickel-plated cover



Divider separates power & low voltage

FLB5552MB



Arlington

Carlson • T&B	Hubbell	Lew	WireMold • P&S
71W-DS	B2481 + S3825 (needs receptacle)	SWB-2-LR	880W1818TCAL (needs receptacle)
71W-DS-N	B2481 + SA3825 (needs receptacle)	SWB-2-LRA	880W1818TCAL (needs receptacle)
62W + (2) 64-DS (needs receptacle)	B2482 + SB3082 + (2) S3925	SWB-4-PQ-LR	880W2827B (needs receptacle)
62W + (2) 64-AL (needs receptacle)	B2482 + SB3082 + (2) SA3825	SWB-4-PQ-LR	880W2827B (needs receptacle)
P-64-DS	S3825	RRP-2-LRR	828R
P-64-DS-AL	SA3825	RRP-2-LR-AR	828R-TCAL
(2) 64-DS	SB3084 + S3825	RRP-4-BP-LR	(2) 828R
(2) 64-DS-AL	SB3082 + (2) SA3825	RRP-4-PQ-LR-A	(2) 828R-TCAL
----	----	----	----
----	----	----	----

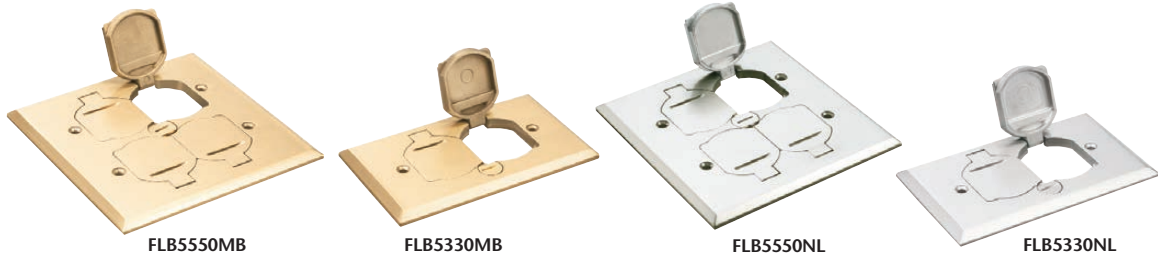

ARLINGTON'S METAL GASKETED COVERS with FLIP LIDS

Arlington's steel floor outlet boxes are compatible with our metal floor box covers on pages 10 and 12. Features include: installed grounding screw, adjustable mounting ears and multiple 1/2" knockouts.

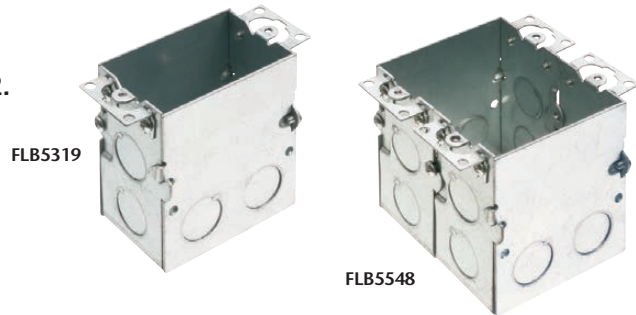

STEEL OUTLET BOXES FOR NEW OR RETROFIT CONSTRUCTION

CATALOG NUMBER	UPC/DCI/NAED MFG. #018997	DESCRIPTION	CUBIC INCHES	# OF KNOCKOUTS	UNIT PKG	STD PKG
FLB5319	22060	Single-gang Steel Floor Outlet Box	18.0	9	1	10
FLB5548	22061	Two-gang Steel Floor Outlet Box	36.0	14	1	10
FLB5549	22062	Two-gang Steel Floor Combination Box with installed (removable) divider for power/low voltage	36.0	14	1	10



COVERS WITH THREADED PLUGS



FLB5541MB
Floor Box Kit
(exploded view)

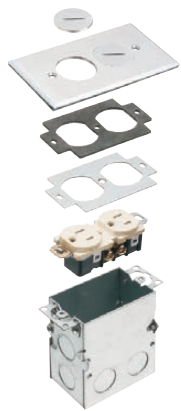

FLB5321NL
(exploded view)

CATALOG NUMBER	UPC/DCI/NAED MFG. #018997	DESCRIPTION COVERS WITH FLIP LIDS	COVER SIZE & STYLE	COVER SHAPE	UNIT PKG	STD PKG
FLOOR BOX KIT • with STEEL BOX						
FLB5321MB	22015	Single-gang steel box, gaskets, receptacle, gasketed cover, mounting screws	Brass with Two Threaded Plugs	■	1	4
FLB5321NL	22016		Nickel-plated with Two Threaded Plugs	■	1	4
FLB5541MB	22034	Two-gang steel box, gaskets, receptacles, gasketed cover, mounting screws	Brass with Four Threaded Plugs	■	1	4
FLB5541NL	22035		Nickel-plated with Four Threaded Plugs	■	1	4
METAL GASKETED COVER with receptacle						
FLB5320MB	22013	Brass Cover	Single-gang with Two Threaded Plugs	■	1	10
FLB5320NL	22014	Nickel-plated Cover	Single-gang with Two Threaded Plugs	■	1	10
FLB5540MB	22005	Brass Cover	Two-gang with Four Threaded Plugs	■	1	10
FLB5540NL	22033	Nickel-plated Cover	Two-gang with Four Threaded Plugs	■	1	10



FLB5321MB



FLB5321NL



FLB5541MB



FLB5541NL

SINGLE & TWO-GANG FLOOR BOX KITS



FLB5541NL



Arlington

Carlson • T&B	Hubbell	Lew	WireMold • P&S
61W + P-64-DU (needs receptacle)	B2481 + S3625 (needs receptacle)	SWB-2	880W1+828SPTC (needs receptacle)
61W + P-64-DU-AL (needs receptacle)	B2481 + SA3625 (needs receptacle)	SWB-2-NS	(2) 828SPTC
62W + (2) P-64-DU (needs receptacle)	B2482 + SB3084W + SA3625	SWB-4-PQ	880W2
62W + (2) P-64-DU-AL	B2482 + SA3084 + (2)SA3625	SWB-4-PQ-A	880W2 + (2) 828SPTC
P-64-DU	S3625	RRP-2-BR	828SPTC
P-64-DU-AL	SA3625	RRP-2-NS	-----
(2) P-64-DU	SB3084W + (2) SA3625	RRP-4-BP	880W1+(2) 828SPTC
(2) P-64-DU-AL	SA3084W + (2) SA3625	RRP-4-BP-A	(2) 828SPTC



FLB5540MB



FLB5320MB



FLB5540NL



FLB5320NL

ARLINGTON'S METAL GASKETED COVERS with THREADED PLUGS

Arlington's single and two-gang steel floor outlet boxes are compatible with our metal floor box covers on pages 10 and 12.

Features include: installed grounding screw, adjustable mounting ears and multiple 1/2" knockouts.



FLB5319



FLB5548

STEEL OUTLET BOXES FOR NEW OR RETROFIT CONSTRUCTION

CATALOG NUMBER	UPC/DCI/NAED MFG. #018997	DESCRIPTION	CUBIC INCHES	# OF KNOCKOUTS	UNIT PKG	STD PKG
FLB5319	22060	Single-gang Steel Floor Outlet Box	18.0	9	1	10
FLB5548	22061	Two-gang Steel Floor Outlet Box	36.0	14	1	10

FOR NEW CONCRETE POURS



FLBC4500
(Mud cover in place)

CATALOG NUMBER	UPC/DCI/NAED MFG. #018997	DESCRIPTION	NOTES	UNIT PKG	STD PKG
FLBC4500	22010	4.5" Non-metallic Round Box for Concrete Pours (conduit plugs, mud cover, voltage divider)		1	5
FLB6230MB	22025	Cover Kit 6" Round, Brass w two flip lids	*hole pattern fits FLBC4500LR	1	10
FLB6230NL	22026	Cover Kit 6" Round, Nickel-plated w two flip lids	*hole pattern fits FLBC4500LR	1	10
FLB6220MB	22021	Cover Kit 6" Round, Brass w two threaded plugs	*hole pattern fits FLBC4500LR	1	10
FLB6220NL	22022	Cover Kit 6" Round, Nickel-plated w two threaded plugs	*hole pattern fits FLBC4500LR	1	10
FLBC4500LR	22011	Leveling Ring for Arlington FLBC4500 & above round covers (has bosses for cover mounting)		1	10
FLBT6615MB	22030	Trapdoor Cover Round, Brass. Pre-mounted gasket & decorator-style 15A receptacle		1	10
FLBT6615NL	22031	Trapdoor Cover Round, Nickel-plated. Pre-mounted gasket & decorator-style 15A receptacle		1	10
FLBT6615LR	22029	Leveling Ring for Arlington FLBC4500 box w FLBT6615 trapdoor style cover		1	10
FLBC4500AR	22004	Oversized Adapter Ring for 5" diameter concrete boxes		1	10
FLBC4500Y	22012	"Y" Adapter - Provides (2) 1" openings for conduit entering 1" hub		1	10

NON-METALLIC CONCRETE BOX



FLBC4500
Exploded view of components. (Mud cover not shown)

COVER KITS with FLIP LIDS

FLB6230MB
Brass cover

Includes cover with flip lids, gaskets, receptacle.

Also available with Nickel-plated cover **FLB6230NL** (not shown)



COVER KITS with THREADED PLUGS

FLB6220MB
Brass cover

Includes cover with threaded plugs, gaskets, receptacle.

FLB6220NL
Nickel-plated cover

(NOT SHOWN)

LEVELING RING

Hole pattern fits above round covers:
FLB6230MB
FLB6230NL
FLB6220MB
FLB6220NL

FLBC4500LR

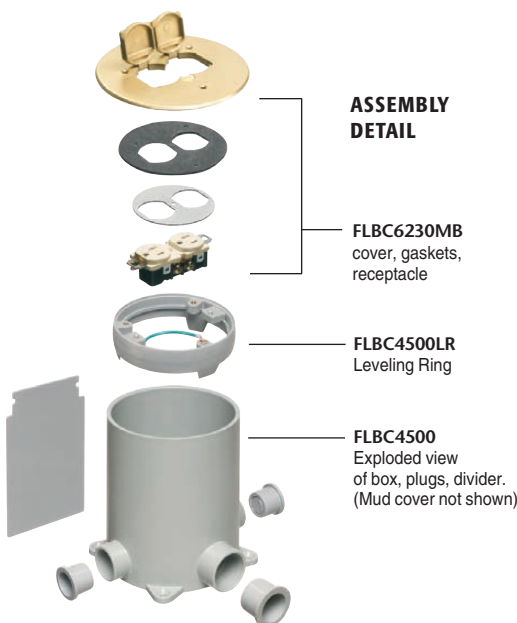
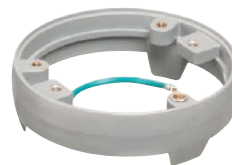

Carlson • T&B	Hubbell	Lew	WireMold • P&S
E971FB, 68P	PFB1	FB	881 E971FB, 68P
E97BR2, P60DS	S3925 + S3082	TCP-2-LR	895T E97BR2, P60DS
E97SS2, P60CACP	-----	TCP-LR-A	895 E97SS2, P60CACP
P-60-DUP-60-CP	S3725 + S3082	TCP-2	895SP P-60-DUP-60-CP
-----	-----	-----	-----
E97ABR2, 68-PAR	PFBA1	LRA	881ADP E97ABR2, 68-PAR
-----	-----	PUFP-BD	-----
-----	-----	PUFF-SD	-----
-----	-----	PUFF-LRA	-----
-----	-----	LRA-HT	-----
E972Y	PFBYA1	Y-CONN	N/A E972Y

ARLINGTON'S TRAPDOOR COVERS & LEVELING RING



FLBT6615MB
Trapdoor cover
(open & closed)



FLBT6615NL
Trapdoor cover



FLBT6615LR
Leveling Ring
for trapdoor covers



FLBT6615MB
Trapdoor cover
on **FLBC4500**
Concrete box



FLBT6615NL

ARLINGTON'S ADAPTERS



FLBC4500AR
Oversized
Adapter Ring



FLBC4500Y
"Y" Adapter



FLOOR BOX KITS

FOR GOOD
LOOKS
ANYWHERE

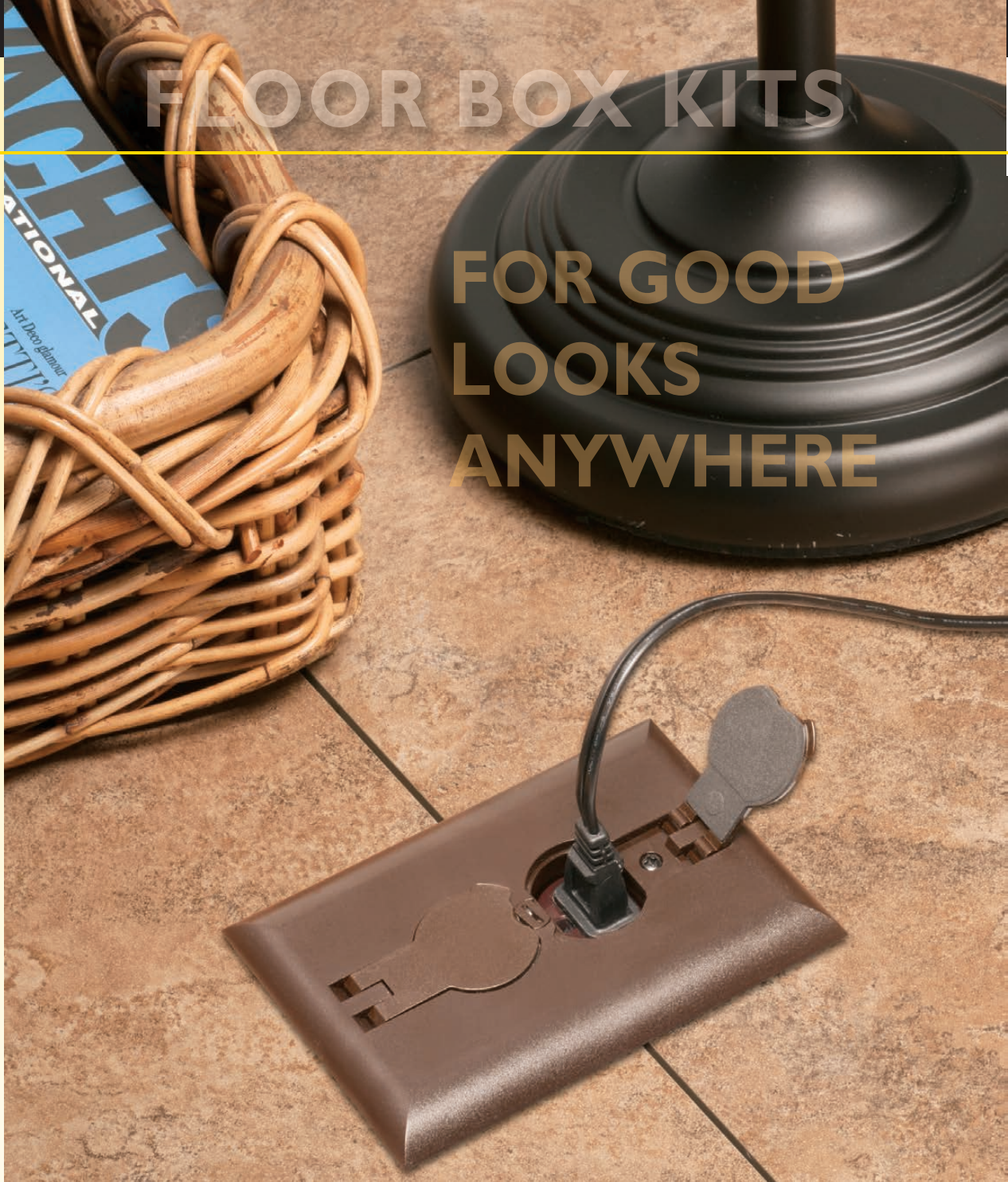

FLOOR
BOX KITS

and INTERCHANGEABLE FLOOR BOXES • COVERS • ACCESSORIES



Arlington

Distributed by