

IN/OUT BOX™ for Ceiling Fixtures

Made in USA 

NEW!
Outlet boxes
on back

Adjustable Non-Metallic Box for New Construction

Easy Installation in New Construction

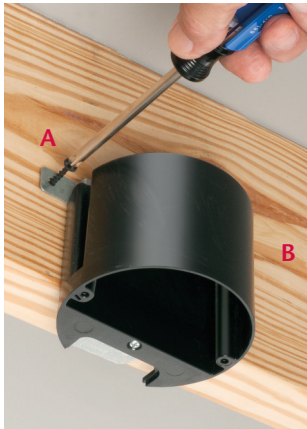

1 Install FA426 onto joist with a MINIMUM of four screws; (2) through front flange, (1) in each rear position. A, B, C, D above.



2 After installing the box on joist slide plastic insert into box. Pull NM cable through installed NM connector.



Catalog Number	UPC/DEI/NAED Mfg. #018997	Description Non-Metallic IN/OUT BOX™	Size/Cu Inches	Unit/Std Pkg
FA426	40040	Adjustable Ceiling Fixture Box	Round 20.5 cu in	25/ctn
FA426GC	40041	Adjustable Ceiling Fixture Box w/ ground clip for Canada	Round 20.5 cu in	25/ctn

Includes (4) installation screws, NM cable connector
Pre-set for 1/2" wall thickness - Depth adjustment up to 1-1/2"



Photo A (cutaway) shows box set back in double drywall ceiling



Photo B Box now flush with ceiling

3 After installation of wall board is complete use the depth adjustment screw to adjust position of FA426 box if necessary (see Photo B). FA426 adjusts up to 1-1/2" for ceiling thickness.

Arlington's IN/OUT BOX for ceiling fixtures adjusts up to 1-1/2" to accommodate varying ceiling thicknesses, like single or double drywall.

- Pre-set for 1/2" ceiling... Depth adjusts up to 1-1/2"
- Always accessible depth adjustment screw allows for depth adjustment of box before or after the ceiling is in place
- Complies with 2014 NEC, 314.20 for set back boxes
- Mounts securely to joist in new construction
- Listed for fixture support up to 50 lbs
- UL/CSA Listed

Depth adjustment screw

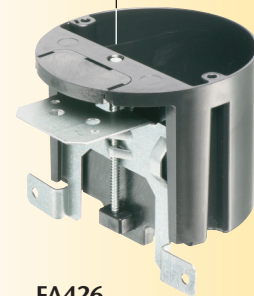

FA426 Adjustable Fixture Box

Patent pending



Arlington

1 Stauffer Industrial Park
Scranton, PA 18517

800/233.4717

Fax 570/562.0646

www.aifittings.com

IN/OUT BOX™ Adjustable OUTLET Boxes

Made in USA 

Adjustable Non-Metallic Outlet Boxes for New Construction

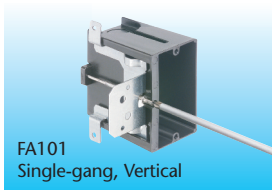
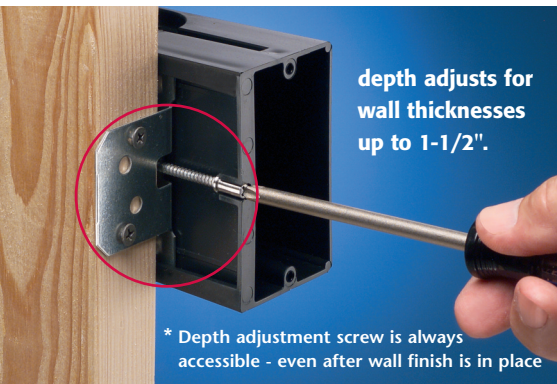
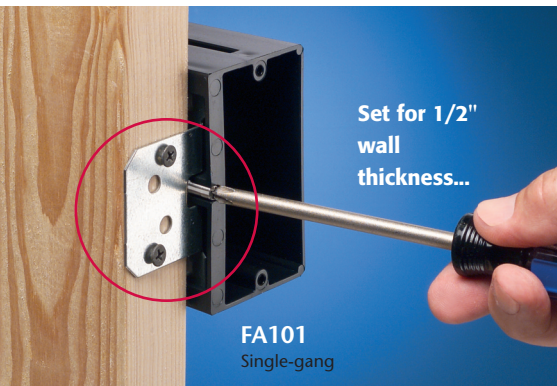

Catalog Number	UPC/DEI/NAED Mfg. #018997	Description	Number of Gangs / Cubic Inches	Unit/Std Pkg
FA101*	04241	Non-metallic box	Single/Vertical/21.0 cu in	25
FA101H*	11102	for 2x4 studs w/ depth adjustment up to 1-1/2" (pre-set for 1/2" wall thickness)	Single/Horizontal/21.0 cu in	25
FA102*	04242		Two-gang / 43.5 cu in	10
FA103*	04243		Three-gang / 65.0 cu in	10
FA104	04244		Four-gang / 87.0 cu in	10

Arlington's IN/OUT OUTLET BOXES are adjustable for wall thicknesses up to 1-1/2"; perfect for use when the final thickness is not known; double drywall, change orders, tile, etc.

New! ...single-gang **horizontal** box **FA101H** for countertops and horizontal outlets... single-gang, **low profile** **FA101LP**. Made for new work installations with shallower wall cavities, it's shorter than our 'regular' single-gang IN/OUT outlet box – perfect for smaller spaces.

- Complies with 2014 NEC, 314.20 for set back boxes
- Always accessible depth adjustment screw
- Secure installation on wood or steel studs in new construction

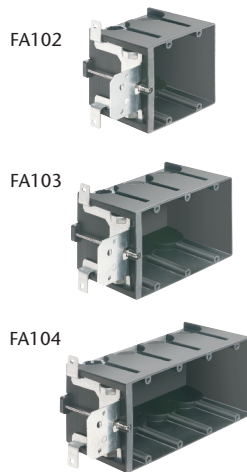

with Ground Clip for use in Canada

Catalog Number	UPC/DEI/NAED Mfg. #018997	Description	Number of Gangs / Cubic Inches	Unit/Std Pkg
FA101GC*	76881	Non-metallic box	Single/Vertical/21.0 cu in	25
FA101HGC*	11103	w/ depth adjustment up to 1-1/2" (pre-set for 1/2" wall thickness)	Single/Horizontal/21.0 cu in	25
FA102GC*	76883		Two-gang / 43.5 cu in	10
FA103GC*	76884		Three-gang / 65.0 cu in	10
FA104GC	76885		Four-gang / 87.0 cu in	10

Catalog Number	UPC/DEI/NAED Mfg. #018997	Description	Unit/Std Pkg
FA102D	04245	Low Voltage Divider for FA102, FA103, FA104	25

Optional FA102D low voltage separator for use with multiple gang IN/OUT BOX



1 Stauffer Industrial Park
Scranton, PA 18517
800/233.4717
Fax 570/562.0646
www.aifittings.com

FA426 1214/15M
Patent pending

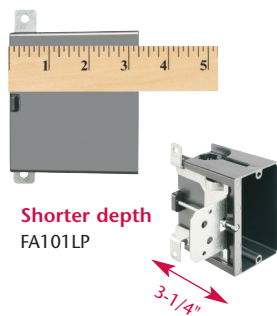

Catalog Number	UPC/DEI/NAED Mfg. #018997	Description IN/OUT BOX™	Size/ Cu Inches	Unit/Std Pkg
FA101LP	76880	3.25" deep, Non-metallic low profile outlet box	Single-gang 18.3 cu in	25
FA101LPGC	76882	3.25" deep, Non-metallic low profile outlet box, with ground clip for Canada	Single-gang 18.3 cu in	25

w/ depth adjustment up to 1-1/2" (pre-set for 1/2" wall thickness)

IN/OUT BOX™ for Ceiling Fixtures

Made in USA 

NEW!
Outlet boxes
on back

Adjustable Non-Metallic Box for New Construction

Easy Installation in New Construction

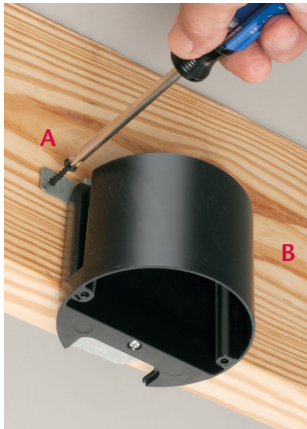

1 Install FA426 onto joist with a MINIMUM of four screws; (2) through front flange, (1) in each rear position. A, B, C, D above.



Catalog Number	UPC/DEI/NAED Mfg. #018997	Description	Size/Cu Inches	Unit/Std Pkg
FA426	40040	Adjustable Ceiling Fixture Box	Round 20.5 cu in	25/ctn
FA426GC	40041	Adjustable Ceiling Fixture Box w/ ground clip for Canada	Round 20.5 cu in	25/ctn

Includes (4) installation screws, NM cable connector
Pre-set for 1/2" wall thickness - Depth adjustment up to 1-1/2"



2 After installing the box on joist slide plastic insert into box. Pull NM cable through installed NM connector.



Photo A (cutaway) shows box set back in double drywall ceiling



Photo B Box now flush with ceiling

3 After installation of wall board is complete use the depth adjustment screw to adjust position of FA426 box if necessary (see Photo B). FA426 adjusts up to 1-1/2" for ceiling thickness.

Arlington's IN/OUT BOX for ceiling fixtures adjusts up to 1-1/2" to accommodate varying ceiling thicknesses, like single or double drywall.

- Pre-set for 1/2" ceiling... Depth adjusts up to 1-1/2"
- Always accessible depth adjustment screw allows for depth adjustment of box before or after the ceiling is in place
- Complies with 2014 NEC, 314.20 for set back boxes
- Mounts securely to joist in new construction
- Listed for fixture support up to 50 lbs
- UL/CSA Listed

Depth adjustment screw

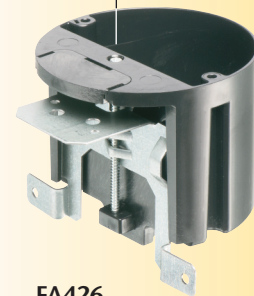

FA426 Adjustable Fixture Box

Patent pending



Arlington

1 Stauffer Industrial Park
Scranton, PA 18517

800/233.4717

Fax 570/562.0646

www.aifittings.com

IN/OUT BOX™ Adjustable OUTLET Boxes

Made in USA 

Adjustable Non-Metallic Outlet Boxes for New Construction

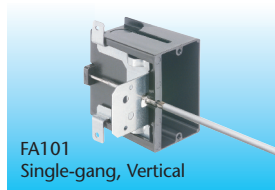
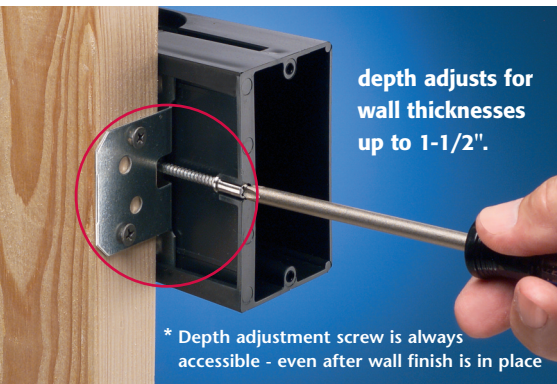
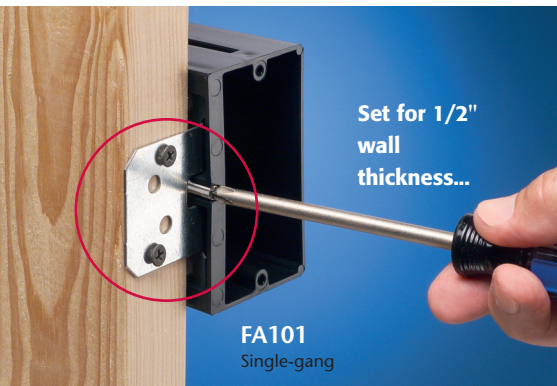

Catalog Number	UPC/DEI/NAED Mfg. #018997	Description	Number of Gangs / Cubic Inches	Unit/Std Pkg
FA101*	04241	Non-metallic box	Single/Vertical/21.0 cu in	25
FA101H*	11102	for 2x4 studs w/ depth adjustment up to 1-1/2" (pre-set for 1/2" wall thickness)	Single/Horizontal/21.0 cu in	25
FA102*	04242		Two-gang / 43.5 cu in	10
FA103*	04243		Three-gang / 65.0 cu in	10
FA104	04244		Four-gang / 87.0 cu in	10

Arlington's IN/OUT OUTLET BOXES are adjustable for wall thicknesses up to 1-1/2"; perfect for use when the final thickness is not known; double drywall, change orders, tile, etc.

New! ...single-gang **horizontal** box **FA101H** for countertops and horizontal outlets... single-gang, **low profile** **FA101LP**. Made for new work installations with shallower wall cavities, it's shorter than our 'regular' single-gang IN/OUT outlet box – perfect for smaller spaces.

- Complies with 2014 NEC, 314.20 for set back boxes
- Always accessible depth adjustment screw
- Secure installation on wood or steel studs in new construction

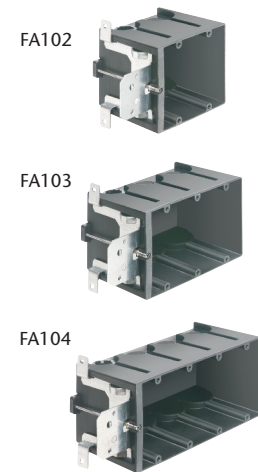

with Ground Clip for use in Canada

Catalog Number	UPC/DEI/NAED Mfg. #018997	Description	Number of Gangs / Cubic Inches	Unit/Std Pkg
FA101GC*	76881	Non-metallic box	Single/Vertical/21.0 cu in	25
FA101HGC*	11103	w/ depth adjustment up to 1-1/2" (pre-set for 1/2" wall thickness)	Single/Horizontal/21.0 cu in	25
FA102GC*	76883		Two-gang / 43.5 cu in	10
FA103GC*	76884		Three-gang / 65.0 cu in	10
FA104GC	76885		Four-gang / 87.0 cu in	10

Catalog Number	UPC/DEI/NAED Mfg. #018997	Description	Unit/Std Pkg
FA102D	04245	Low Voltage Divider for FA102, FA103, FA104	25

Optional FA102D low voltage separator for use with multiple gang IN/OUT BOX



1 Stauffer Industrial Park
Scranton, PA 18517
800/233.4717
Fax 570/562.0646
www.aifittings.com

FA426 1214/15M
Patent pending

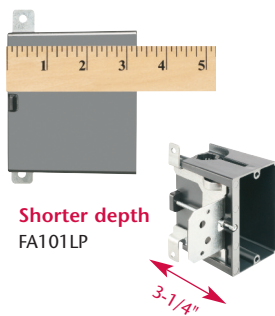

Catalog Number	UPC/DEI/NAED Mfg. #018997	Description IN/OUT BOX™	Size/ Cu Inches	Unit/Std Pkg
FA101LP	76880	3.25" deep, Non-metallic low profile outlet box	Single-gang 18.3 cu in	25
FA101LPGC	76882	3.25" deep, Non-metallic low profile outlet box, with ground clip for Canada	Single-gang 18.3 cu in	25

w/ depth adjustment up to 1-1/2" (pre-set for 1/2" wall thickness)