

LAY-IN HINGED-COVER WIREWAY, NEMA TYPE 1



INDUSTRY STANDARDS

UL 870 Listed; File No. E27524
 cUL Listed per CSA C22.2 No. 26; File No. E27524

NEMA/EEMAC Type 1
 IEC 60529, IP30

APPLICATION

This wireway provides convenient cable installation and maintenance with its top hinged cover and an opening on one side so wires and cables can be laid in along the entire run without pulling. A variety of lengths and fittings provide increased design flexibility.

FEATURES

- Open top assembly
- Removable hinged cover latches with captive screws
- 12.00 x 12.00-in. models available in hinged or non-hinged styles
- Available with or without knockouts on wireway sides
- Covers include captivated plated screw fasteners

SPECIFICATIONS

- 16 gauge or 14 gauge steel covers and bodies

FINISH

ANSI 61 gray polyester powder paint finish inside and out over pretreated surfaces.

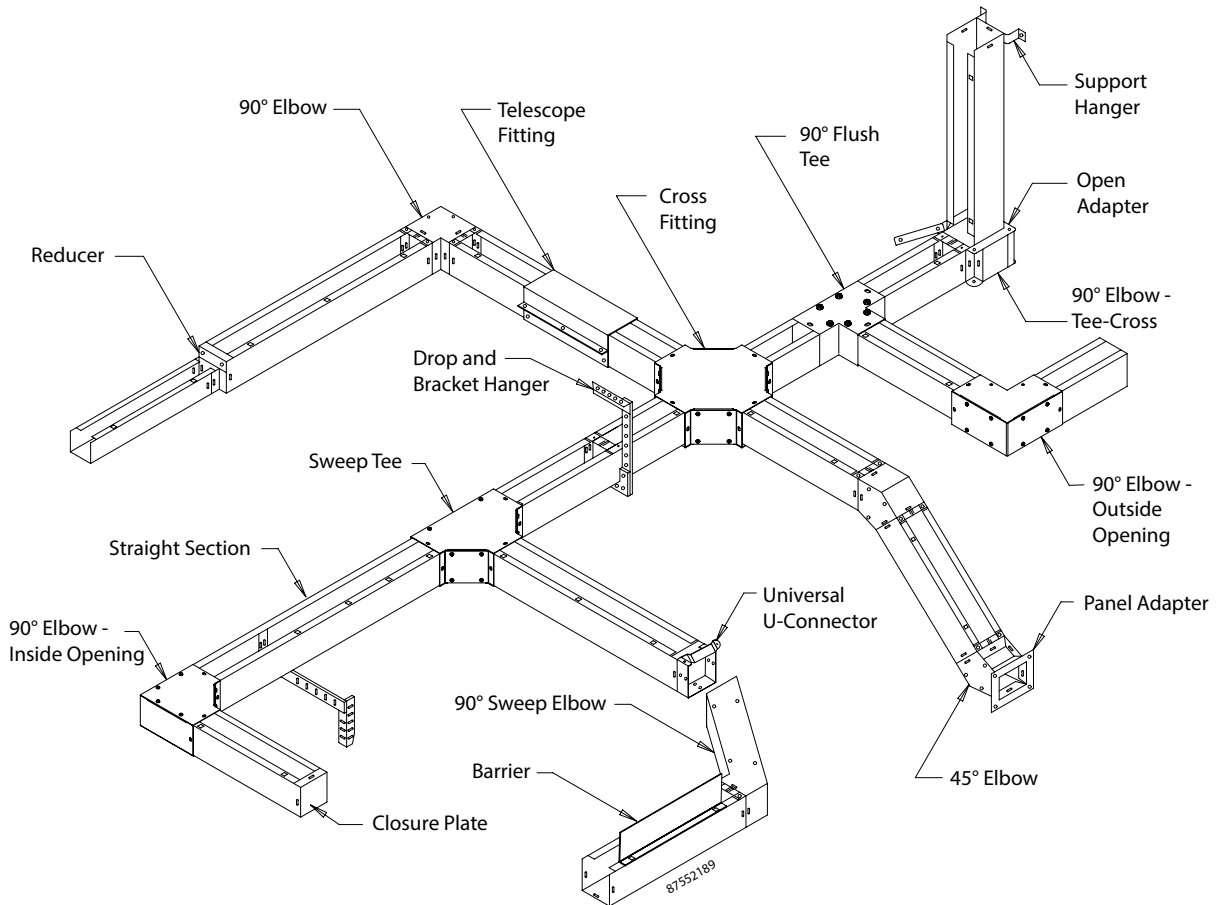

Standard Product Selection Matrix

Description	2.50 x 2.50 in. (64 x 64 mm) 16 Gauge	4.00 x 4.00 in. (102 x 102 mm) 16 Gauge	6.00 x 6.00 in. (152 x 152 mm) 16 Gauge	8.00 x 8.00 in. (203 x 203 mm) 14 Gauge	10.00 x 10.00 in. (254 x 254 mm) 14 Gauge	Not Hinged 12.00 x 12.00 in. (305 x 305 mm) 14 Gauge	Hinged 12.00 x 12.00 in. (305 x 305 mm) 14 Gauge
12.00-in. (305mm) Straight Section with knockouts	F22G12WK	F44G12WK	F66G12WK	—	—	—	—
12.00-in. (305mm) Straight Section without knockouts	F22G12	F44G12	F66G12	F88G12	F1010G12	F1212G12	F1212G12H
18.00-in. (455mm) Straight Section without knockouts	—	F44G18	F66G18	F88G18	—	—	—
24.00-in. (610mm) Straight Section with knockouts	F22G24WK	F44G24WK	F66G24WK	—	—	—	—
24.00-in. (610mm) Straight Section without knockouts	F22G24	F44G24	F66G24	F88G24	F1010G24	F1212G24	F1212G24H
36.00-in. (914mm) Straight Section with knockouts	F22G36WK	F44G36WK	F66G36WK	—	—	—	—
36.00-in. (914mm) Straight Section without knockouts	F22G36	F44G36	F66G36	F88G36	F1010G36	F1212G36	F1212G36H
48.00-in. (1219mm) Straight Section with knockouts	F22G48WK	F44G48WK	F66G48WK	—	—	—	—
48.00-in. (1219mm) Straight Section without knockouts	F22G48	F44G48	F66G48	F88G48	F1010G48	F1212G48	F1212G48H
60.00-in. (1524mm) Straight Section with knockouts	F22G60WK	F44G60WK	F66G60WK	—	—	—	—
60.00-in. (1524mm) Straight Section without knockouts	F22G60	F44G60	F66G60	F88G60	F1010G60	F1212G60	F1212G60H
72.00-in. (1829mm) Straight Section with knockouts	—	F44G72WK	F66G72WK	—	—	—	—
72.00-in. (1829mm) Straight Section without knockouts	—	F44G72	F66G72	F88G72	F1010G72	F1212G72	F1212G72H
96.00-in. (2438mm) Straight Section without knockouts	—	F44G96	F66G96	F88G96	F1010G96	F1212G96	—
120.00-in. (3048mm) Straight Section with knockouts	F22G120WK	F44G120WK	F66G120WK	—	—	—	—
120.00-in. (3048mm) Straight Section without knockouts	F22G120	F44G120	F66G120	F88G120	F1010G120	F1212G120	F1212G120H
90° Flush Tee	F22GT	F44GT	F66GT	F88GT	F1010GT	F1212GT	F1212GT
Sweep Tee	F22T	F44T	F66T	F88T	F1010T	F1212T	F1212T
Cross Fitting	F22X	F44X	F66X	F88X	F1010X	F1212X	F1212X
90° Sweep Elbow	F22G90SE	F44G90SE	F66G90SE	F88G90SE	F1010G90SE	F1212G90SE	F1212G90SE
90° Elbow-Tee-Cross	F22G90TX	F44G90TX	F66G90TX	F88G90TX	F1010G90TX	F1212G90TX	F1212G90TX
90° Elbow	F22G90E	F44G90E	F66G90E	F88G90E	F1010G90E	F1212G90E	F1212G90E
90° Elbow Outside Opening	F2290EOUT	F4490EOUT	F6690EOUT	F8890EOUT	F101090EOUT	F121290EOUT	F121290EOUT
90° Elbow Inside Opening	F2290EIN	F4490EIN	F6690EIN	F8890EIN	F101090EIN	F121290EIN	F121290EIN
45° Elbow	F22G45E	F44G45E	F66G45E	F88G45E	F1010G45E	F1212G45E	F1212G45E
Telescope Fitting ^a	F22GA	F44GA	F66GA	F88GA	F1010GA	F1212GA	F1212GA
Open Adapter	F22GOA	F44GOA	F66GOA	F88GOA	F1010GOA	F1212GOA	F1212GOA
Panel Adapter	F22GPA	F44GPA	F66GPA	F88GPA	F1010GPA	F1212GPA	F1212GPA
Closure Plate without knockouts	F22GCPNK	F44GCPNK	F66GCPNK	F88GCPNK	F1010GCPNK	F1212GCPNK	F1212GCPNK
Closure Plate with knockouts	F22GCP	F44GCP	F66GCP	F88GCP	F1010GCP	F1212GCP	F1212GCP
Reducer	—	F44G22R	F66G44R	F88G66R	F1010G88R	F1212G88R F1212G1010R	F1212G88R F1212G1010R
Drop and Bracket Hanger	F22GDB	F44GDB	F66GDB	F88GDB	F1010GDB	F1212GDB	F1212GDB
Support Hanger	F22GSH	F44GSH	F66GSH	F88GSH	F1010GSH	F1212GSH	F1212GSH
Universal U-Connector	F22GUC	F44GUC	F66GUC	F88GUC	F1010GUC	F1212GUC	F1212GUC
Barrier Kit, bolt-on h barrier 60.00 in. (1524 mm)	—	F44BK60	F66BK60	F88BK60	—	—	—

^aNot UL/cUL listed.

STRAIGHT SECTION

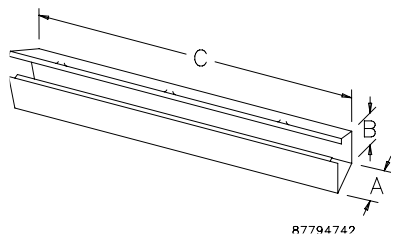

87794749

Available in lengths from 12.00 in. (305 mm), with or without knockouts.

BULLETIN: F40, F40PF

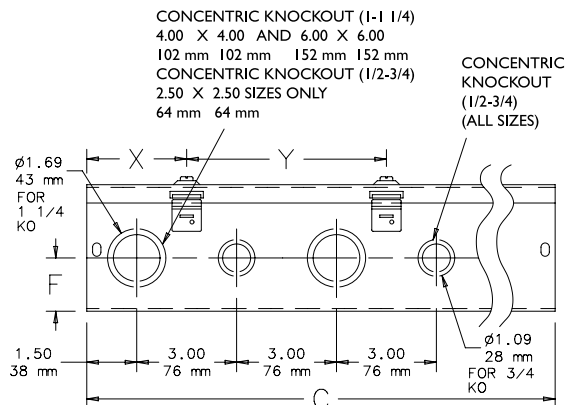

87794694

Patented hidden hinge permits usual plated steel screw cover arrangement to be converted to hinge cover system on all sizes except 12.00 in x 12.00 in. (305mm x 305mm).

Straight Sections

Catalog Number	AxBxC in.	AxBxC mm	Number of Knockouts, .50 in.-.75 in.	Number of Knockouts, 1.00 in.-1.25 in.	F (in.)	F (mm)	X (in.)	X (mm)	Y (in.)	Y (mm)
F22G12WK	2.50 x 2.50 x 12.00	64 x 64 x 305	8	—	1.06	27	3.00	76	6.00	152
F22G12	2.50 x 2.50 x 12.00	64 x 64 x 305	—	—	—	—	—	—	—	—
F22G24WK	2.50 x 2.50 x 24.00	64 x 64 x 610	16	—	1.06	27	6.00	152	12.00	305
F22G24	2.50 x 2.50 x 24.00	64 x 64 x 610	—	—	—	—	—	—	—	—
F22G36WK	2.50 x 2.50 x 36.00	64 x 64 x 914	24	—	1.06	27	6.00	152	12.00	305
F22G36	2.50 x 2.50 x 36.00	64 x 64 x 914	—	—	—	—	—	—	—	—
F22G48WK	2.50 x 2.50 x 48.00	64 x 64 x 1219	32	—	1.06	27	6.00	152	12.00	305
F22G48	2.50 x 2.50 x 48.00	64 x 64 x 1219	—	—	—	—	—	—	—	—
F22G60WK	2.50 x 2.50 x 60.00	64 x 64 x 1524	40	—	1.06	27	6.00	152	12.00	305
F22G60	2.50 x 2.50 x 60.00	64 x 64 x 1524	—	—	—	—	—	—	—	—
F22G120WK	2.50 x 2.50 x 120.00	64 x 64 x 3048	80	—	1.06	27	6.00	152	12.00	305
F22G120	2.50 x 2.50 x 120.00	64 x 64 x 3048	—	—	—	—	—	—	—	—
F44G12WK	4.00 x 4.00 x 12.00	102 x 102 x 305	4	4	1.62	41	3.00	76	6.00	152
F44G12	4.00 x 4.00 x 12.00	102 x 102 x 305	—	—	—	—	—	—	—	—
F44G18	4.00 x 4.00 x 18.00	102 x 102 x 457	—	—	—	—	—	—	—	—
F44G24WK	4.00 x 4.00 x 24.00	102 x 102 x 610	8	8	1.62	41	6.00	152	12.00	305
F44G24	4.00 x 4.00 x 24.00	102 x 102 x 610	—	—	—	—	—	—	—	—
F44G36WK	4.00 x 4.00 x 36.00	102 x 102 x 914	12	12	1.62	41	6.00	152	12.00	305
F44G36	4.00 x 4.00 x 36.00	102 x 102 x 914	—	—	—	—	—	—	—	—
F44G48WK	4.00 x 4.00 x 48.00	102 x 102 x 1219	16	16	1.62	41	6.00	152	12.00	305
F44G48	4.00 x 4.00 x 48.00	102 x 102 x 1219	—	—	—	—	—	—	—	—
F44G60WK	4.00 x 4.00 x 60.00	102 x 102 x 1524	20	20	1.62	41	6.00	152	12.00	305
F44G60	4.00 x 4.00 x 60.00	102 x 102 x 1524	—	—	—	—	—	—	—	—
F44G72WK	4.00 x 4.00 x 72.00	102 x 102 x 1829	24	24	1.62	41	6.00	152	12.00	305
F44G72	4.00 x 4.00 x 72.00	102 x 102 x 1829	—	—	—	—	—	—	—	—
F44G96	4.00 x 4.00 x 96.00	102 x 102 x 2438	—	—	—	—	—	—	—	—
F44G120WK	4.00 x 4.00 x 120.00	102 x 102 x 3048	40	40	1.62	41	6.00	152	12.00	305
F44G120	4.00 x 4.00 x 120.00	102 x 102 x 3048	—	—	—	—	—	—	—	—
F66G12WK	6.00 x 6.00 x 12.00	152 x 152 x 305	4	4	1.62	41	3.00	76	6.00	152
F66G12	6.00 x 6.00 x 12.00	152 x 152 x 305	—	—	—	—	—	—	—	—
F66G18	6.00 x 6.00 x 18.00	152 x 152 x 457	—	—	—	—	—	—	—	—
F66G24WK	6.00 x 6.00 x 24.00	152 x 152 x 610	8	8	1.62	41	6.00	152	12.00	305
F66G24	6.00 x 6.00 x 24.00	152 x 152 x 610	—	—	—	—	—	—	—	—
F66G36WK	6.00 x 6.00 x 36.00	152 x 152 x 914	12	12	1.62	41	6.00	152	12.00	305
F66G36	6.00 x 6.00 x 36.00	152 x 152 x 914	—	—	—	—	—	—	—	—
F66G48WK	6.00 x 6.00 x 48.00	152 x 152 x 1219	16	16	1.62	41	6.00	152	12.00	305
F66G48	6.00 x 6.00 x 48.00	152 x 152 x 1219	—	—	—	—	—	—	—	—
F66G60WK	6.00 x 6.00 x 60.00	152 x 152 x 1524	20	20	1.62	41	6.00	152	12.00	305
F66G60	6.00 x 6.00 x 60.00	152 x 152 x 1524	—	—	—	—	—	—	—	—
F66G72WK	6.00 x 6.00 x 72.00	152 x 152 x 1829	24	24	1.62	41	6.00	152	12.00	305
F66G72	6.00 x 6.00 x 72.00	152 x 152 x 1829	—	—	—	—	—	—	—	—
F66G96	6.00 x 6.00 x 96.00	152 x 152 x 2438	—	—	—	—	—	—	—	—
F66G120WK	6.00 x 6.00 x 120.00	152 x 152 x 3048	40	40	1.62	41	6.00	152	12.00	305
F66G120	6.00 x 6.00 x 120.00	152 x 152 x 3048	—	—	—	—	—	—	—	—
F88G12	8.00 x 8.00 x 12.00	203 x 203 x 305	—	—	—	—	—	—	—	—
F88G18	8.00 x 8.00 x 18.00	203 x 203 x 457	—	—	—	—	—	—	—	—
F88G24	8.00 x 8.00 x 24.00	203 x 203 x 610	—	—	—	—	—	—	—	—
F88G36	8.00 x 8.00 x 36.00	203 x 203 x 914	—	—	—	—	—	—	—	—
F88G48	8.00 x 8.00 x 48.00	203 x 203 x 1219	—	—	—	—	—	—	—	—
F88G60	8.00 x 8.00 x 60.00	203 x 203 x 1524	—	—	—	—	—	—	—	—
F88G72	8.00 x 8.00 x 72.00	203 x 203 x 1829	—	—	—	—	—	—	—	—
F88G96	8.00 x 8.00 x 96.00	203 x 203 x 2438	—	—	—	—	—	—	—	—
F88G120	8.00 x 8.00 x 120.00	203 x 203 x 3048	—	—	—	—	—	—	—	—
F1010G12	10.00 x 10.00 x 12.00	254 x 254 x 305	—	—	—	—	—	—	—	—
F1010G24	10.00 x 10.00 x 24.00	254 x 254 x 610	—	—	—	—	—	—	—	—
F1010G36	10.00 x 10.00 x 36.00	254 x 254 x 914	—	—	—	—	—	—	—	—
F1010G48	10.00 x 10.00 x 48.00	254 x 254 x 1219	—	—	—	—	—	—	—	—
F1010G60	10.00 x 10.00 x 60.00	254 x 254 x 1524	—	—	—	—	—	—	—	—
F1010G72	10.00 x 10.00 x 72.00	254 x 254 x 1829	—	—	—	—	—	—	—	—
F1010G96	10.00 x 10.00 x 96.00	254 x 254 x 2438	—	—	—	—	—	—	—	—
F1010G120	10.00 x 10.00 x 120.00	254 x 254 x 3048	—	—	—	—	—	—	—	—
F1212G12	12.00 x 12.00 x 12.00	305 x 305 x 305	—	—	—	—	—	—	—	—
F1212G12H	12.00 x 12.00 x 12.00	305 x 305 x 305	—	—	—	—	—	—	—	—
F1212G24	12.00 x 12.00 x 24.00	305 x 305 x 610	—	—	—	—	—	—	—	—
F1212G24H	12.00 x 12.00 x 24.00	305 x 305 x 610	—	—	—	—	—	—	—	—
F1212G36	12.00 x 12.00 x 36.00	305 x 305 x 914	—	—	—	—	—	—	—	—
F1212G36H	12.00 x 12.00 x 36.00	305 x 305 x 914	—	—	—	—	—	—	—	—
F1212G48	12.00 x 12.00 x 48.00	305 x 305 x 1219	—	—	—	—	—	—	—	—

Catalog Number	AxBxC in.	AxBxC mm	Number of Knockouts, .50 in. - .75 in.	Number of Knockouts, 1.00 in. - 1.25 in.	F (in.)	F (mm)	X (in.)	X (mm)	Y (in.)	Y (mm)
F1212G48H	12.00 x 12.00 x 48.00	305 x 305 x 1219	—	—	—	—	—	—	—	—
F1212G60	12.00 x 12.00 x 60.00	305 x 305 x 1524	—	—	—	—	—	—	—	—
F1212G60H	12.00 x 12.00 x 60.00	305 x 305 x 1524	—	—	—	—	—	—	—	—
F1212G72	12.00 x 12.00 x 72.00	305 x 305 x 1829	—	—	—	—	—	—	—	—
F1212G72H	12.00 x 12.00 x 72.00	305 x 305 x 1829	—	—	—	—	—	—	—	—
F1212G96	12.00 x 12.00 x 96.00	305 x 305 x 2438	—	—	—	—	—	—	—	—
F1212G120	12.00 x 12.00 x 120.00	305 x 305 x 3048	—	—	—	—	—	—	—	—
F1212G120H	12.00 x 12.00 x 120.00	305 x 305 x 3048	—	—	—	—	—	—	—	—

F1212GXX catalog numbers without "H" are not hinged. F1212GXXH catalog numbers are hinged.

90-DEGREE FLUSH TEE

For flush mounting against a vertical or horizontal surface.

BULLETIN: F40PF

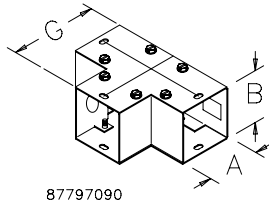

Catalog Number	AxB in./mm	G in./mm
F22GT	2.50 x 2.50 64 x 64	4.50 114
F33GT	3.00 x 3.00 76 x 76	5.00 127
F44GT	4.00 x 4.00 102 x 102	6.00 152
F66GT	6.00 x 6.00 152 x 152	8.00 203
F88GT	8.00 x 8.00 203 x 203	10.00 254
F1010GT	10.00 x 10.00 254 x 254	12.00 305
F1212GT	12.00 x 12.00 305 x 305	14.00 356

SWEEP TEE

For large radius turns. Mounts against vertical or horizontal surfaces. Top and inside covers removable.

BULLETIN: F40PF

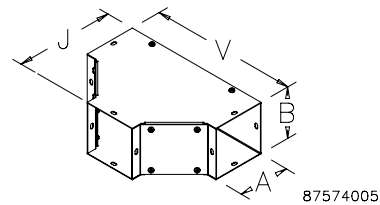

CROSS FITTING

For routing cables in four directions. Top, bottom and side covers removable.

BULLETIN: F40PF

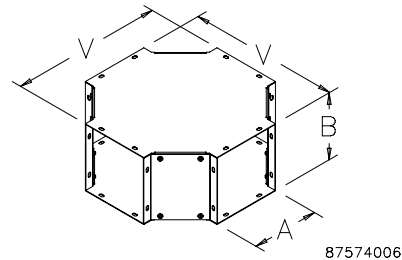

90-DEGREE SWEEP ELBOW

For large radius turns.

BULLETIN: F40PF

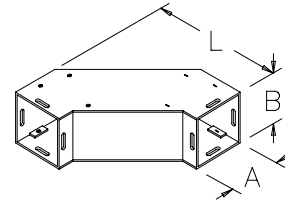

87797091

90-DEGREE ELBOW-TEE-CROSS

Forms left or right 90-degree turns. Can be used as a tee or cross. Use with open adapter for cable entrance in top and bottom. Includes two closure plates.

BULLETIN: F40PF

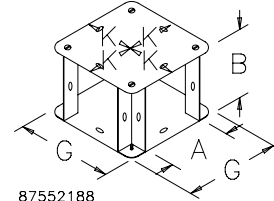

87552188

90-DEGREE ELBOW

Any side can be removed, retaining lay-in feature regardless of how the elbow is oriented. Sides are held together with screws.

BULLETIN: F40PF

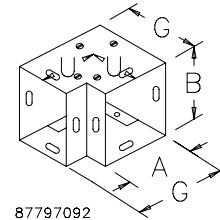

87797092

90-DEGREE ELBOW—OUTSIDE OPENING

For continuous run with 90-degree turns. Top, bottom and outside covers removable.

BULLETIN: F40PF

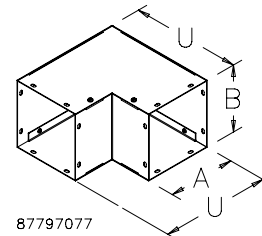

87797077

90-DEGREE ELBOW—INSIDE OPENING

For continuous run with 90-degree turns. Top and inside covers removable.

BULLETIN: F40PF

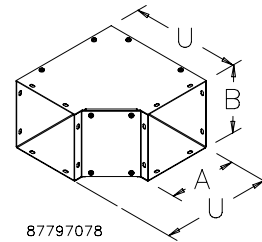

45-DEGREE ELBOW

For continuous run with 45-degree turns. Top and inside covers removable.

BULLETIN: F40PF

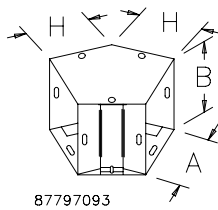

Catalog Number	AxB in./mm	H in./mm
F22G45E	2.50 x 2.50 64 x 64	2.75 70
F33G45E	3.00 x 3.00 76 x 76	2.99 76
F44G45E	4.00 x 4.00 102 x 102	3.38 86
F66G45E	6.00 x 6.00 152 x 152	4.25 108
F88G45E	8.00 x 8.00 203 x 203	5.06 129
F1010G45E	10.00 x 10.00 254 x 254	6.00 152
F1212G45E	12.00 x 12.00 305 x 305	6.75 171

TELESCOPE FITTING

Length easily adjusts to approximately 12.00 in. (305 mm). No cutting or welding required.

BULLETIN: F40PF

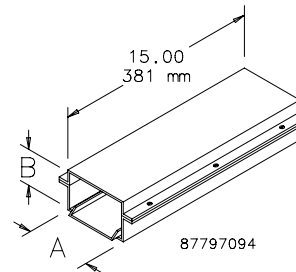

OPEN ADAPTER

Used with the 90-Degree Elbow-Tee-Cross fitting to permit a run directly up or down.

BULLETIN: F40PF

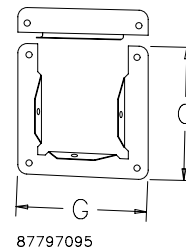

Catalog Number	G (in.)	G (mm)
F22GOA	4.50	114
F44GOA	6.00	152

PANEL ADAPTER

A flanged fitting which allows the wireway to be securely connected to an enclosure.

BULLETIN: F40PF

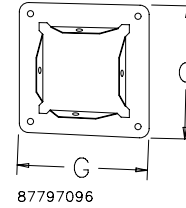

Catalog Number	G (in.)	G (mm)
F22GPA	4.50	114
F33GPA	5.00	127

CLOSURE PLATE

Closes the end of a wireway section or run.

BULLETIN: F40PF

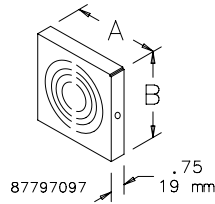

Catalog Number	AxB in.	AxB mm	Knockouts
F22GCP	2.50 x 2.50	64 x 64	With knockouts
F22GCPNK	2.50 x 2.50	64 x 64	Without knockouts
F44GCP	4.00 x 4.00	102 x 102	With knockouts
F33GCPNK	3.00 x 3.00	76 x 76	Without knockouts
F44GCPNK	4.00 x 4.00	102 x 102	Without knockouts
F66GCP	6.00 x 6.00	152 x 152	With knockouts
F66GCPNK	6.00 x 6.00	152 x 152	Without knockouts
F88GCP	8.00 x 8.00	203 x 203	With knockouts
F88GCPNK	8.00 x 8.00	203 x 203	Without knockouts
F1010GCP	10.00 x 10.00	254 x 254	With knockouts
F1010GCPNK	10.00 x 10.00	254 x 254	Without knockouts
F1212GCP	12.00 x 12.00	305 x 305	With knockouts
F1212GCPNK	12.00 x 12.00	305 x 305	Without knockouts

REDUCER

Reduces wireway to a smaller size.

BULLETIN: F40PF

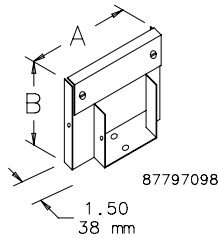

Catalog Number	AxB in./mm
F33G22R	3.00 x 3.00 76 x 76
F44G22R	4.00 x 4.00 102 x 102
F44G33R	4.00 x 4.00 101 x 101
F66G44R	6.00 x 6.00 152 x 152
F88G66R	8.00 x 8.00 203 x 203
F1010G88R	10.00 x 10.00 254 x 254
F1212G88R	12.00 x 12.00 305 x 305
F1212G1010R	12.00 x 12.00 305 x 305

DROP AND BRACKET HANGERS

Drop and bracket hangers support a wireway run.

BULLETIN: F40PF

Catalog Number	N max. (in.)	N max. (mm)	P (in.)	P (mm)	R (in.)	R (mm)	S (in.)	S (mm)	T (in.)	T (mm)
F22GDB	8.50	216	4.50	114	3.38	86	7.25	184	3.75	95
F44GDB	10.50	267	6.00	152	4.12	105	9.25	235	4.50	114
F66GDB	15.00	381	7.12	181	5.12	130	13.75	349	5.50	140
F88GDB	21.00	533	10.81	275	7.00	178	13.75	349	7.75	197
F1010GDB	22.00	559	13.81	335	8.38	213	13.75	349	10.25	260
F1212GDB	23.00	584	15.56	395	9.78	248	13.75	349	12.50	318

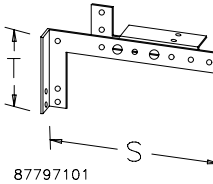
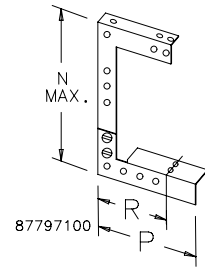

SUPPORT HANGER

For floor or wall installations.

BULLETIN: F40PF

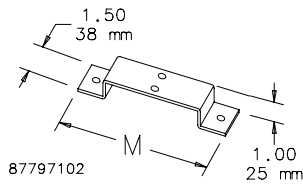

Catalog Number	AxB in./mm	M in./mm
F22GSH	2.50 x 2.50 64 x 64	4.62 117
F44GSH	4.00 x 4.00 102 x 102	6.12 155
F66GSH	6.00 x 6.00 152 x 152	8.12 206
F88GSH	8.00 x 8.00 203 x 203	10.12 257
F1010GSH	10.00 x 10.00 254 x 254	12.12 308
F1212GSH	12.00 x 12.00 305 x 305	14.12 359

UNIVERSAL U-CONNECTOR

Joins wireway sections and fittings. Top swings aside to retain the lay-in feature. One U-connector required at each wireway joint except telescope fittings, panel adapters, open adapters, closure plates or reducers.

BULLETIN: F40PF

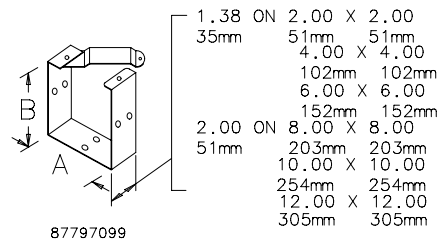

Catalog Number	AxB in./mm
F22GUC	2.50 x 2.50 64 x 64
F33GUC	3.00 x 3.00 76 x 76

LAY-IN HINGED-COVER WIREWAY, NEMA TYPE 1



INDUSTRY STANDARDS

UL 870 Listed; File No. E27524
 cUL Listed per CSA C22.2 No. 26; File No. E27524

NEMA/EEMAC Type 1
 IEC 60529, IP30

APPLICATION

This wireway provides convenient cable installation and maintenance with its top hinged cover and an opening on one side so wires and cables can be laid in along the entire run without pulling. A variety of lengths and fittings provide increased design flexibility.

FEATURES

- Open top assembly
- Removable hinged cover latches with captive screws
- 12.00 x 12.00-in. models available in hinged or non-hinged styles
- Available with or without knockouts on wireway sides
- Covers include captivated plated screw fasteners

SPECIFICATIONS

- 16 gauge or 14 gauge steel covers and bodies

FINISH

ANSI 61 gray polyester powder paint finish inside and out over pretreated surfaces.

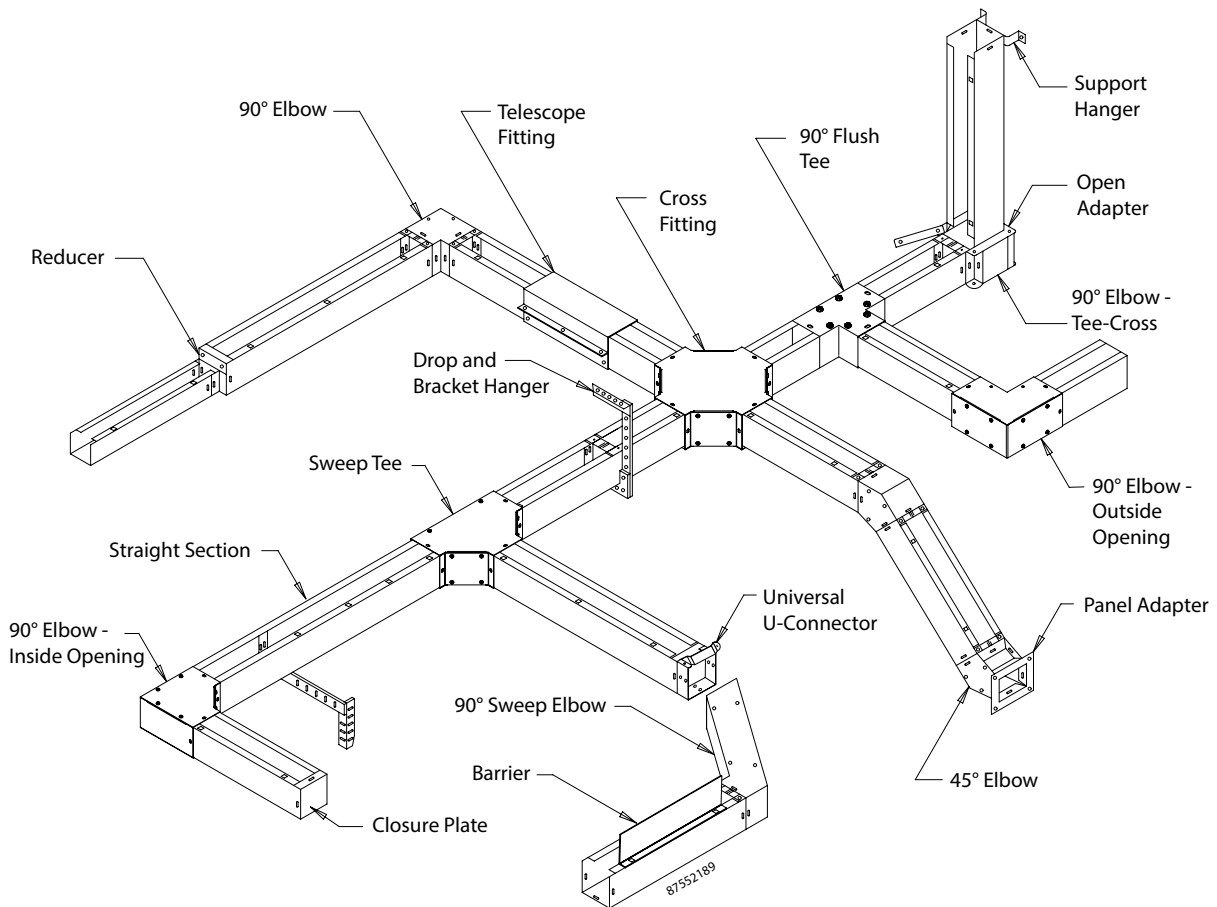

Standard Product Selection Matrix

Description	2.50 x 2.50 in. (64 x 64 mm) 16 Gauge	4.00 x 4.00 in. (102 x 102 mm) 16 Gauge	6.00 x 6.00 in. (152 x 152 mm) 16 Gauge	8.00 x 8.00 in. (203 x 203 mm) 14 Gauge	10.00 x 10.00 in. (254 x 254 mm) 14 Gauge	Not Hinged 12.00 x 12.00 in. (305 x 305 mm) 14 Gauge	Hinged 12.00 x 12.00 in. (305 x 305 mm) 14 Gauge
12.00-in. (305mm) Straight Section with knockouts	F22G12WK	F44G12WK	F66G12WK	—	—	—	—
12.00-in. (305mm) Straight Section without knockouts	F22G12	F44G12	F66G12	F88G12	F1010G12	F1212G12	F1212G12H
18.00-in. (455mm) Straight Section without knockouts	—	F44G18	F66G18	F88G18	—	—	—
24.00-in. (610mm) Straight Section with knockouts	F22G24WK	F44G24WK	F66G24WK	—	—	—	—
24.00-in. (610mm) Straight Section without knockouts	F22G24	F44G24	F66G24	F88G24	F1010G24	F1212G24	F1212G24H
36.00-in. (914mm) Straight Section with knockouts	F22G36WK	F44G36WK	F66G36WK	—	—	—	—
36.00-in. (914mm) Straight Section without knockouts	F22G36	F44G36	F66G36	F88G36	F1010G36	F1212G36	F1212G36H
48.00-in. (1219mm) Straight Section with knockouts	F22G48WK	F44G48WK	F66G48WK	—	—	—	—
48.00-in. (1219mm) Straight Section without knockouts	F22G48	F44G48	F66G48	F88G48	F1010G48	F1212G48	F1212G48H
60.00-in. (1524mm) Straight Section with knockouts	F22G60WK	F44G60WK	F66G60WK	—	—	—	—
60.00-in. (1524mm) Straight Section without knockouts	F22G60	F44G60	F66G60	F88G60	F1010G60	F1212G60	F1212G60H
72.00-in. (1829mm) Straight Section with knockouts	—	F44G72WK	F66G72WK	—	—	—	—
72.00-in. (1829mm) Straight Section without knockouts	—	F44G72	F66G72	F88G72	F1010G72	F1212G72	F1212G72H
96.00-in. (2438mm) Straight Section without knockouts	—	F44G96	F66G96	F88G96	F1010G96	F1212G96	—
120.00-in. (3048mm) Straight Section with knockouts	F22G120WK	F44G120WK	F66G120WK	—	—	—	—
120.00-in. (3048mm) Straight Section without knockouts	F22G120	F44G120	F66G120	F88G120	F1010G120	F1212G120	F1212G120H
90° Flush Tee	F22GT	F44GT	F66GT	F88GT	F1010GT	F1212GT	F1212GT
Sweep Tee	F22T	F44T	F66T	F88T	F1010T	F1212T	F1212T
Cross Fitting	F22X	F44X	F66X	F88X	F1010X	F1212X	F1212X
90° Sweep Elbow	F22G90SE	F44G90SE	F66G90SE	F88G90SE	F1010G90SE	F1212G90SE	F1212G90SE
90° Elbow-Tee-Cross	F22G90TX	F44G90TX	F66G90TX	F88G90TX	F1010G90TX	F1212G90TX	F1212G90TX
90° Elbow	F22G90E	F44G90E	F66G90E	F88G90E	F1010G90E	F1212G90E	F1212G90E
90° Elbow Outside Opening	F2290EOUT	F4490EOUT	F6690EOUT	F8890EOUT	F101090EOUT	F121290EOUT	F121290EOUT
90° Elbow Inside Opening	F2290EIN	F4490EIN	F6690EIN	F8890EIN	F101090EIN	F121290EIN	F121290EIN
45° Elbow	F22G45E	F44G45E	F66G45E	F88G45E	F1010G45E	F1212G45E	F1212G45E
Telescope Fitting ^a	F22GA	F44GA	F66GA	F88GA	F1010GA	F1212GA	F1212GA
Open Adapter	F22GOA	F44GOA	F66GOA	F88GOA	F1010GOA	F1212GOA	F1212GOA
Panel Adapter	F22GPA	F44GPA	F66GPA	F88GPA	F1010GPA	F1212GPA	F1212GPA
Closure Plate without knockouts	F22GCPNK	F44GCPNK	F66GCPNK	F88GCPNK	F1010GCPNK	F1212GCPNK	F1212GCPNK
Closure Plate with knockouts	F22GCP	F44GCP	F66GCP	F88GCP	F1010GCP	F1212GCP	F1212GCP
Reducer	—	F44G22R	F66G44R	F88G66R	F1010G88R	F1212G88R F1212G1010R	F1212G88R F1212G1010R
Drop and Bracket Hanger	F22GDB	F44GDB	F66GDB	F88GDB	F1010GDB	F1212GDB	F1212GDB
Support Hanger	F22GSH	F44GSH	F66GSH	F88GSH	F1010GSH	F1212GSH	F1212GSH
Universal U-Connector	F22GUC	F44GUC	F66GUC	F88GUC	F1010GUC	F1212GUC	F1212GUC
Barrier Kit, bolt-on h barrier 60.00 in. (1524 mm)	—	F44BK60	F66BK60	F88BK60	—	—	—

^aNot UL/cUL listed.

STRAIGHT SECTION

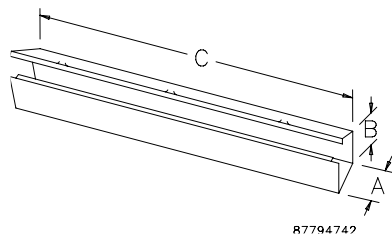

87794749

Available in lengths from 12.00 in. (305 mm), with or without knockouts.

BULLETIN: F40, F40PF

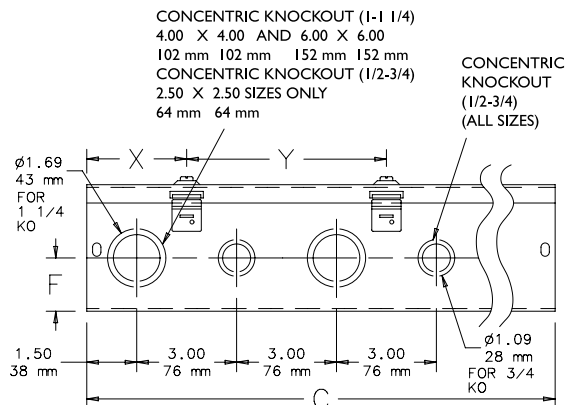

87794694

Patented hidden hinge permits usual plated steel screw cover arrangement to be converted to hinge cover system on all sizes except 12.00 in x 12.00 in. (305mm x 305mm).

Straight Sections

Catalog Number	AxBxC in.	AxBxC mm	Number of Knockouts, .50 in. - .75 in.	Number of Knockouts, 1.00 in. - 1.25 in.	F (in.)	F (mm)	X (in.)	X (mm)	Y (in.)	Y (mm)
F22G12WK	2.50 x 2.50 x 12.00	64 x 64 x 305	8	—	1.06	27	3.00	76	6.00	152
F22G12	2.50 x 2.50 x 12.00	64 x 64 x 305	—	—	—	—	—	—	—	—
F22G24WK	2.50 x 2.50 x 24.00	64 x 64 x 610	16	—	1.06	27	6.00	152	12.00	305
F22G24	2.50 x 2.50 x 24.00	64 x 64 x 610	—	—	—	—	—	—	—	—
F22G36WK	2.50 x 2.50 x 36.00	64 x 64 x 914	24	—	1.06	27	6.00	152	12.00	305
F22G36	2.50 x 2.50 x 36.00	64 x 64 x 914	—	—	—	—	—	—	—	—
F22G48WK	2.50 x 2.50 x 48.00	64 x 64 x 1219	32	—	1.06	27	6.00	152	12.00	305
F22G48	2.50 x 2.50 x 48.00	64 x 64 x 1219	—	—	—	—	—	—	—	—
F22G60WK	2.50 x 2.50 x 60.00	64 x 64 x 1524	40	—	1.06	27	6.00	152	12.00	305
F22G60	2.50 x 2.50 x 60.00	64 x 64 x 1524	—	—	—	—	—	—	—	—
F22G120WK	2.50 x 2.50 x 120.00	64 x 64 x 3048	80	—	1.06	27	6.00	152	12.00	305
F22G120	2.50 x 2.50 x 120.00	64 x 64 x 3048	—	—	—	—	—	—	—	—
F44G12WK	4.00 x 4.00 x 12.00	102 x 102 x 305	4	4	1.62	41	3.00	76	6.00	152
F44G12	4.00 x 4.00 x 12.00	102 x 102 x 305	—	—	—	—	—	—	—	—
F44G18	4.00 x 4.00 x 18.00	102 x 102 x 457	—	—	—	—	—	—	—	—
F44G24WK	4.00 x 4.00 x 24.00	102 x 102 x 610	8	8	1.62	41	6.00	152	12.00	305
F44G24	4.00 x 4.00 x 24.00	102 x 102 x 610	—	—	—	—	—	—	—	—
F44G36WK	4.00 x 4.00 x 36.00	102 x 102 x 914	12	12	1.62	41	6.00	152	12.00	305
F44G36	4.00 x 4.00 x 36.00	102 x 102 x 914	—	—	—	—	—	—	—	—
F44G48WK	4.00 x 4.00 x 48.00	102 x 102 x 1219	16	16	1.62	41	6.00	152	12.00	305
F44G48	4.00 x 4.00 x 48.00	102 x 102 x 1219	—	—	—	—	—	—	—	—
F44G60WK	4.00 x 4.00 x 60.00	102 x 102 x 1524	20	20	1.62	41	6.00	152	12.00	305
F44G60	4.00 x 4.00 x 60.00	102 x 102 x 1524	—	—	—	—	—	—	—	—
F44G72WK	4.00 x 4.00 x 72.00	102 x 102 x 1829	24	24	1.62	41	6.00	152	12.00	305
F44G72	4.00 x 4.00 x 72.00	102 x 102 x 1829	—	—	—	—	—	—	—	—
F44G96	4.00 x 4.00 x 96.00	102 x 102 x 2438	—	—	—	—	—	—	—	—
F44G120WK	4.00 x 4.00 x 120.00	102 x 102 x 3048	40	40	1.62	41	6.00	152	12.00	305
F44G120	4.00 x 4.00 x 120.00	102 x 102 x 3048	—	—	—	—	—	—	—	—
F66G12WK	6.00 x 6.00 x 12.00	152 x 152 x 305	4	4	1.62	41	3.00	76	6.00	152
F66G12	6.00 x 6.00 x 12.00	152 x 152 x 305	—	—	—	—	—	—	—	—
F66G18	6.00 x 6.00 x 18.00	152 x 152 x 457	—	—	—	—	—	—	—	—
F66G24WK	6.00 x 6.00 x 24.00	152 x 152 x 610	8	8	1.62	41	6.00	152	12.00	305
F66G24	6.00 x 6.00 x 24.00	152 x 152 x 610	—	—	—	—	—	—	—	—
F66G36WK	6.00 x 6.00 x 36.00	152 x 152 x 914	12	12	1.62	41	6.00	152	12.00	305
F66G36	6.00 x 6.00 x 36.00	152 x 152 x 914	—	—	—	—	—	—	—	—
F66G48WK	6.00 x 6.00 x 48.00	152 x 152 x 1219	16	16	1.62	41	6.00	152	12.00	305
F66G48	6.00 x 6.00 x 48.00	152 x 152 x 1219	—	—	—	—	—	—	—	—
F66G60WK	6.00 x 6.00 x 60.00	152 x 152 x 1524	20	20	1.62	41	6.00	152	12.00	305
F66G60	6.00 x 6.00 x 60.00	152 x 152 x 1524	—	—	—	—	—	—	—	—
F66G72WK	6.00 x 6.00 x 72.00	152 x 152 x 1829	24	24	1.62	41	6.00	152	12.00	305
F66G72	6.00 x 6.00 x 72.00	152 x 152 x 1829	—	—	—	—	—	—	—	—
F66G96	6.00 x 6.00 x 96.00	152 x 152 x 2438	—	—	—	—	—	—	—	—
F66G120WK	6.00 x 6.00 x 120.00	152 x 152 x 3048	40	40	1.62	41	6.00	152	12.00	305
F66G120	6.00 x 6.00 x 120.00	152 x 152 x 3048	—	—	—	—	—	—	—	—
F88G12	8.00 x 8.00 x 12.00	203 x 203 x 305	—	—	—	—	—	—	—	—
F88G18	8.00 x 8.00 x 18.00	203 x 203 x 457	—	—	—	—	—	—	—	—
F88G24	8.00 x 8.00 x 24.00	203 x 203 x 610	—	—	—	—	—	—	—	—
F88G36	8.00 x 8.00 x 36.00	203 x 203 x 914	—	—	—	—	—	—	—	—
F88G48	8.00 x 8.00 x 48.00	203 x 203 x 1219	—	—	—	—	—	—	—	—
F88G60	8.00 x 8.00 x 60.00	203 x 203 x 1524	—	—	—	—	—	—	—	—
F88G72	8.00 x 8.00 x 72.00	203 x 203 x 1829	—	—	—	—	—	—	—	—
F88G96	8.00 x 8.00 x 96.00	203 x 203 x 2438	—	—	—	—	—	—	—	—
F88G120	8.00 x 8.00 x 120.00	203 x 203 x 3048	—	—	—	—	—	—	—	—
F1010G12	10.00 x 10.00 x 12.00	254 x 254 x 305	—	—	—	—	—	—	—	—
F1010G24	10.00 x 10.00 x 24.00	254 x 254 x 610	—	—	—	—	—	—	—	—
F1010G36	10.00 x 10.00 x 36.00	254 x 254 x 914	—	—	—	—	—	—	—	—
F1010G48	10.00 x 10.00 x 48.00	254 x 254 x 1219	—	—	—	—	—	—	—	—
F1010G60	10.00 x 10.00 x 60.00	254 x 254 x 1524	—	—	—	—	—	—	—	—
F1010G72	10.00 x 10.00 x 72.00	254 x 254 x 1829	—	—	—	—	—	—	—	—
F1010G96	10.00 x 10.00 x 96.00	254 x 254 x 2438	—	—	—	—	—	—	—	—
F1010G120	10.00 x 10.00 x 120.00	254 x 254 x 3048	—	—	—	—	—	—	—	—
F1212G12	12.00 x 12.00 x 12.00	305 x 305 x 305	—	—	—	—	—	—	—	—
F1212G12H	12.00 x 12.00 x 12.00	305 x 305 x 305	—	—	—	—	—	—	—	—
F1212G24	12.00 x 12.00 x 24.00	305 x 305 x 610	—	—	—	—	—	—	—	—
F1212G24H	12.00 x 12.00 x 24.00	305 x 305 x 610	—	—	—	—	—	—	—	—
F1212G36	12.00 x 12.00 x 36.00	305 x 305 x 914	—	—	—	—	—	—	—	—
F1212G36H	12.00 x 12.00 x 36.00	305 x 305 x 914	—	—	—	—	—	—	—	—
F1212G48	12.00 x 12.00 x 48.00	305 x 305 x 1219	—	—	—	—	—	—	—	—

Catalog Number	AxBxC in.	AxBxC mm	Number of Knockouts, .50 in. - .75 in.	Number of Knockouts, 1.00 in. - 1.25 in.	F (in.)	F (mm)	X (in.)	X (mm)	Y (in.)	Y (mm)
F1212G48H	12.00 x 12.00 x 48.00	305 x 305 x 1219	—	—	—	—	—	—	—	—
F1212G60	12.00 x 12.00 x 60.00	305 x 305 x 1524	—	—	—	—	—	—	—	—
F1212G60H	12.00 x 12.00 x 60.00	305 x 305 x 1524	—	—	—	—	—	—	—	—
F1212G72	12.00 x 12.00 x 72.00	305 x 305 x 1829	—	—	—	—	—	—	—	—
F1212G72H	12.00 x 12.00 x 72.00	305 x 305 x 1829	—	—	—	—	—	—	—	—
F1212G96	12.00 x 12.00 x 96.00	305 x 305 x 2438	—	—	—	—	—	—	—	—
F1212G120	12.00 x 12.00 x 120.00	305 x 305 x 3048	—	—	—	—	—	—	—	—
F1212G120H	12.00 x 12.00 x 120.00	305 x 305 x 3048	—	—	—	—	—	—	—	—

F1212GXX catalog numbers without "H" are not hinged. F1212GXXH catalog numbers are hinged.

90-DEGREE FLUSH TEE

For flush mounting against a vertical or horizontal surface.

BULLETIN: F40PF

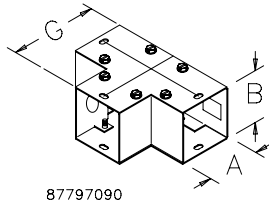

Catalog Number	AxB in./mm	G in./mm
F22GT	2.50 x 2.50 64 x 64	4.50 114
F33GT	3.00 x 3.00 76 x 76	5.00 127
F44GT	4.00 x 4.00 102 x 102	6.00 152
F66GT	6.00 x 6.00 152 x 152	8.00 203
F88GT	8.00 x 8.00 203 x 203	10.00 254
F1010GT	10.00 x 10.00 254 x 254	12.00 305
F1212GT	12.00 x 12.00 305 x 305	14.00 356

SWEEP TEE

For large radius turns. Mounts against vertical or horizontal surfaces. Top and inside covers removable.

BULLETIN: F40PF

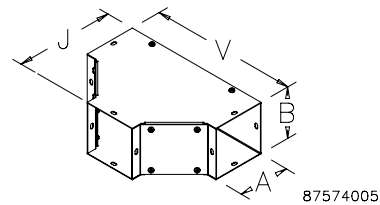

CROSS FITTING

For routing cables in four directions. Top, bottom and side covers removable.

BULLETIN: F40PF

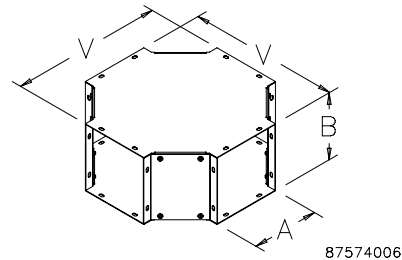

90-DEGREE SWEEP ELBOW

For large radius turns.

BULLETIN: F40PF

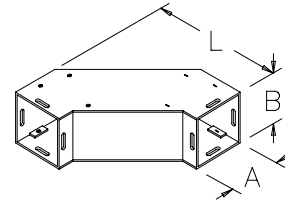

87797091

90-DEGREE ELBOW-TEE-CROSS

Forms left or right 90-degree turns. Can be used as a tee or cross. Use with open adapter for cable entrance in top and bottom. Includes two closure plates.

BULLETIN: F40PF

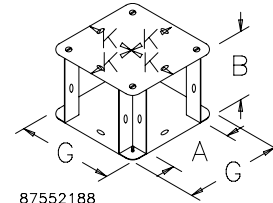

87552188

90-DEGREE ELBOW

Any side can be removed, retaining lay-in feature regardless of how the elbow is oriented. Sides are held together with screws.

BULLETIN: F40PF

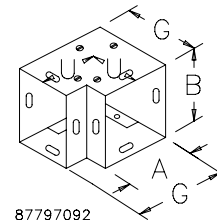

87797092

90-DEGREE ELBOW—OUTSIDE OPENING

For continuous run with 90-degree turns. Top, bottom and outside covers removable.

BULLETIN: F40PF

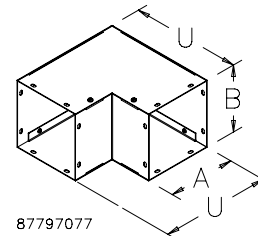

87797077

90-DEGREE ELBOW—INSIDE OPENING

For continuous run with 90-degree turns. Top and inside covers removable.

BULLETIN: F40PF

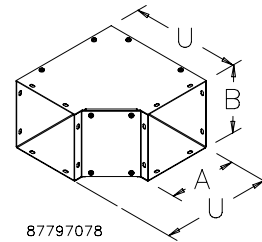

45-DEGREE ELBOW

For continuous run with 45-degree turns. Top and inside covers removable.

BULLETIN: F40PF

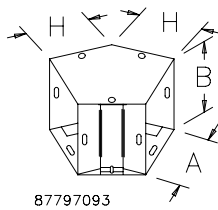

Catalog Number	AxB in./mm	H in./mm
F22G45E	2.50 x 2.50 64 x 64	2.75 70
F33G45E	3.00 x 3.00 76 x 76	2.99 76
F44G45E	4.00 x 4.00 102 x 102	3.38 86
F66G45E	6.00 x 6.00 152 x 152	4.25 108
F88G45E	8.00 x 8.00 203 x 203	5.06 129
F1010G45E	10.00 x 10.00 254 x 254	6.00 152
F1212G45E	12.00 x 12.00 305 x 305	6.75 171

TELESCOPE FITTING

Length easily adjusts to approximately 12.00 in. (305 mm). No cutting or welding required.

BULLETIN: F40PF

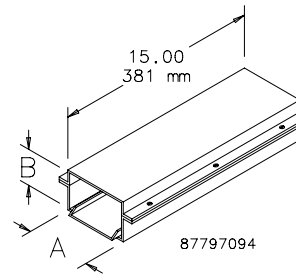

OPEN ADAPTER

Used with the 90-Degree Elbow-Tee-Cross fitting to permit a run directly up or down.

BULLETIN: F40PF

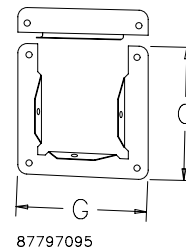

Catalog Number	G (in.)	G (mm)
F22GOA	4.50	114
F44GOA	6.00	152

PANEL ADAPTER

A flanged fitting which allows the wireway to be securely connected to an enclosure.

BULLETIN: F40PF

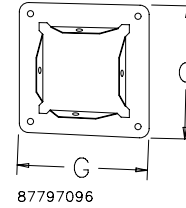

Catalog Number	G (in.)	G (mm)
F22GPA	4.50	114
F33GPA	5.00	127

CLOSURE PLATE

Closes the end of a wireway section or run.

BULLETIN: F40PF

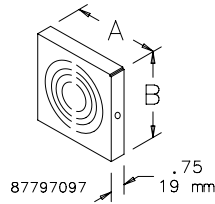

Catalog Number	AxB in.	AxB mm	Knockouts
F22GCP	2.50 x 2.50	64 x 64	With knockouts
F22GCPNK	2.50 x 2.50	64 x 64	Without knockouts
F44GCP	4.00 x 4.00	102 x 102	With knockouts
F33GCPNK	3.00 x 3.00	76 x 76	Without knockouts
F44GCPNK	4.00 x 4.00	102 x 102	Without knockouts
F66GCP	6.00 x 6.00	152 x 152	With knockouts
F66GCPNK	6.00 x 6.00	152 x 152	Without knockouts
F88GCP	8.00 x 8.00	203 x 203	With knockouts
F88GCPNK	8.00 x 8.00	203 x 203	Without knockouts
F1010GCP	10.00 x 10.00	254 x 254	With knockouts
F1010GCPNK	10.00 x 10.00	254 x 254	Without knockouts
F1212GCP	12.00 x 12.00	305 x 305	With knockouts
F1212GCPNK	12.00 x 12.00	305 x 305	Without knockouts

REDUCER

Reduces wireway to a smaller size.

BULLETIN: F40PF

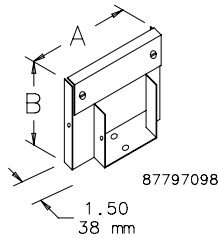

Catalog Number	AxB in./mm
F33G22R	3.00 x 3.00 76 x 76
F44G22R	4.00 x 4.00 102 x 102
F44G33R	4.00 x 4.00 101 x 101
F66G44R	6.00 x 6.00 152 x 152
F88G66R	8.00 x 8.00 203 x 203
F1010G88R	10.00 x 10.00 254 x 254
F1212G88R	12.00 x 12.00 305 x 305
F1212G1010R	12.00 x 12.00 305 x 305

DROP AND BRACKET HANGERS

Drop and bracket hangers support a wireway run.

BULLETIN: F40PF

Catalog Number	N max. (in.)	N max. (mm)	P (in.)	P (mm)	R (in.)	R (mm)	S (in.)	S (mm)	T (in.)	T (mm)
F22GDB	8.50	216	4.50	114	3.38	86	7.25	184	3.75	95
F44GDB	10.50	267	6.00	152	4.12	105	9.25	235	4.50	114
F66GDB	15.00	381	7.12	181	5.12	130	13.75	349	5.50	140
F88GDB	21.00	533	10.81	275	7.00	178	13.75	349	7.75	197
F1010GDB	22.00	559	13.81	335	8.38	213	13.75	349	10.25	260
F1212GDB	23.00	584	15.56	395	9.78	248	13.75	349	12.50	318

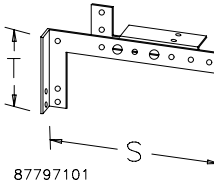
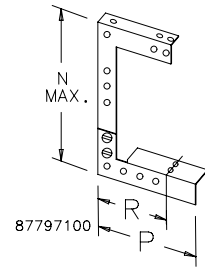

SUPPORT HANGER

For floor or wall installations.

BULLETIN: F40PF

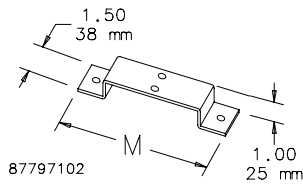

Catalog Number	AxB in./mm	M in./mm
F22GSH	2.50 x 2.50 64 x 64	4.62 117
F44GSH	4.00 x 4.00 102 x 102	6.12 155
F66GSH	6.00 x 6.00 152 x 152	8.12 206
F88GSH	8.00 x 8.00 203 x 203	10.12 257
F1010GSH	10.00 x 10.00 254 x 254	12.12 308
F1212GSH	12.00 x 12.00 305 x 305	14.12 359

UNIVERSAL U-CONNECTOR

Joins wireway sections and fittings. Top swings aside to retain the lay-in feature. One U-connector required at each wireway joint except telescope fittings, panel adapters, open adapters, closure plates or reducers.

BULLETIN: F40PF

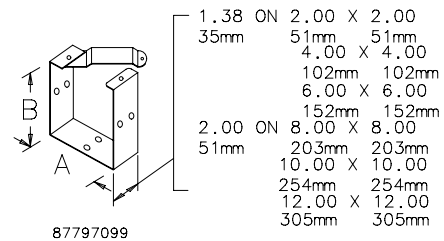

Catalog Number	AxB in./mm
F22GUC	2.50 x 2.50 64 x 64
F33GUC	3.00 x 3.00 76 x 76