

NEW!
more on
reverse

Non-metallic ONE BOX™ for Ceiling Fixtures

For New Work or Retrofit • Secure Mounting to Joist



F426
One Box™
for fixtures

NEW!

NEW WORK Position box and mount to side of joist using the supplied captive screws. Pull cable through installed NM942 cable connector.

GREAT FOR RETROFIT TOO!



Lines indicate joist

1 Determine box location. Locate joist. Make opening next to it.



2 Pull cable...



3 ...through installed NM942 cable connector. Insert box into opening



4 Mount box to side of joist using the supplied captive installation screws.

Arlington's ONE BOX™ *for ceiling fixtures* is our versatile, non-conductive box for new construction *or retrofit*. It side mounts to a wood or steel joist for an *extra secure* installation.

- F426 One Box for fixtures... easy installation
- Listed for fixtures up to 50 lbs



- 28.0 cubic inch round, non-metallic box
- Captive installation screws; installed NM942 cable connector
- UL/CSA Listed
- **2-Hour Fire Rating**

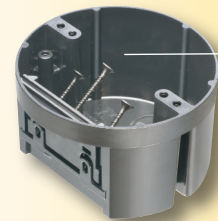

Captive installation screws

F426
Patent pending



Rated for Fixtures up to 50 lbs



Arlington

1 Stauffer Industrial Park
Scranton, PA 18517
800/233.4717
Fax 570/562.0646
www.aifittings.com

Catalog Number	UPC/DEI/NAED Mfg. #018997	Description ONE BOX™	Cubic Inches	Unit/Std Pkg
F426	06904	Round, non-metallic box for fixtures up to 50 lbs.	28.0	20

More ONE BOX™ ...Non-Metallic and Steel

Secure Joist-Mount Installation in New Work or Retrofit

NON-METALLIC ONE BOX for devices for New Construction ...and Retrofit

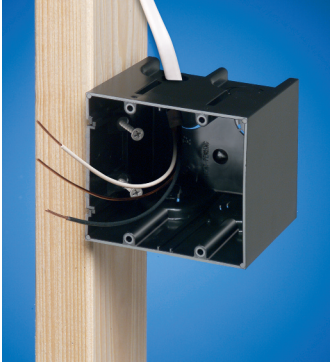

Box set too far forward or back?
Back the screws out to reposition it.

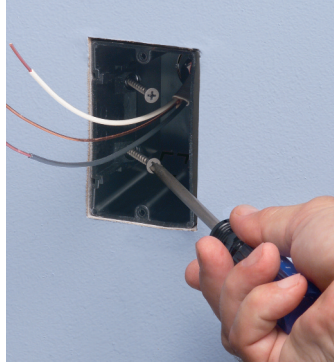

Mounts securely to the stud –
not the drywall

Catalog Number	UPC/DEI/NAED Mfg. #018997	Description Non-Metallic ONE BOX™	Cubic Inches	Unit/Std Pkg
F101	43626	Single-gang	22.5	50
F101H	43634	Single-gang, Horizontal	22.5	20
F102	43640	Two-gang, vertical	42.0	25
F103	43641	Three-gang, vertical	61.0	20
F104	43642	Four-gang, vertical	80.0	20
F102D	43544	Voltage Divider	---	25



F101
Single gang



F101H
Single Horizontal

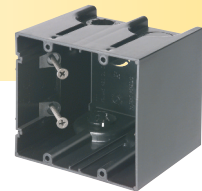

F102
Two-gang



Fan-Rated STEEL ONE BOX for New Construction ...and Retrofit

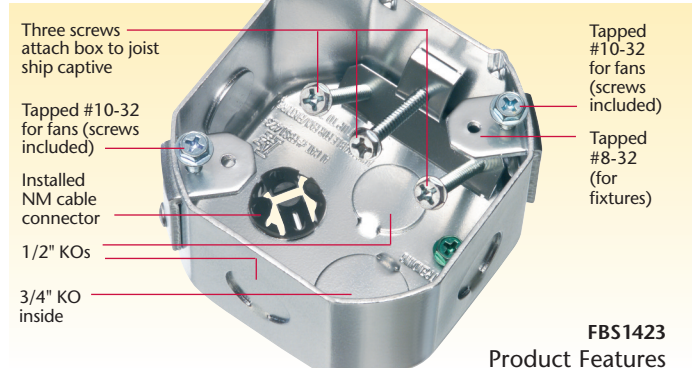
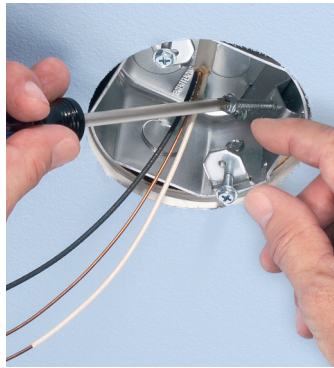

FBS1423 Steel Box includes installed NM cable connector, three (captive) box installation screws and two (captive) #10-32 screws for fan installation.

Catalog Number	UPC/DEI/NAED Mfg. #018997	Cubic Inches	Side-Mount Box Depth	Unit/Std Pkg
FBS1423	76190	23.0	2.375"	10



1 Stauffer Industrial Park
Scranton, PA 18517
800/233.4717
Fax 570/562.0646
www.aifittings.com

Patented. Other patents pending
F426 0116/15M

Distributed by

NEW!
more on
reverse

Non-metallic ONE BOX™ for Ceiling Fixtures

For New Work or Retrofit • Secure Mounting to Joist



F426
One Box™
for fixtures

NEW!

NEW WORK Position box and mount to side of joist using the supplied captive screws. Pull cable through installed NM942 cable connector.

GREAT FOR RETROFIT TOO!



Lines indicate joist

1 Determine box location. Locate joist. Make opening next to it.



2 Pull cable...



3 ...through installed NM942 cable connector. Insert box into opening



4 Mount box to side of joist using the supplied captive installation screws.

Arlington's ONE BOX™ *for ceiling fixtures* is our versatile, non-conductive box for new construction *or retrofit*. It side mounts to a wood or steel joist for an *extra secure* installation.

- F426 One Box for fixtures... easy installation
- Listed for fixtures up to 50 lbs



- 28.0 cubic inch round, non-metallic box
- Captive installation screws; installed NM942 cable connector
- UL/CSA Listed
- **2-Hour Fire Rating**

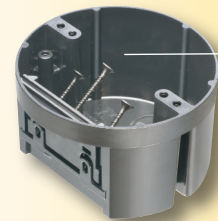

Captive installation screws

F426
Patent pending



Rated for Fixtures up to 50 lbs



Arlington

1 Stauffer Industrial Park
Scranton, PA 18517
800/233.4717
Fax 570/562.0646
www.aifittings.com

Catalog Number	UPC/DEI/NAED Mfg. #018997	Description ONE BOX™	Cubic Inches	Unit/Std Pkg
F426	06904	Round, non-metallic box for fixtures up to 50 lbs.	28.0	20

More ONE BOX™ ...Non-Metallic and Steel

Secure Joist-Mount Installation in New Work or Retrofit

NON-METALLIC ONE BOX for devices for New Construction ...and Retrofit

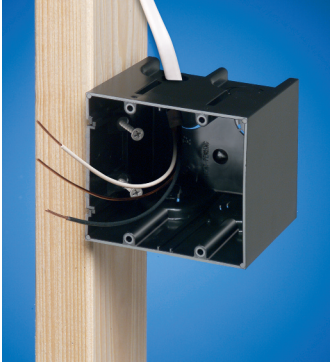

Box set too far forward or back?
Back the screws out to reposition it.

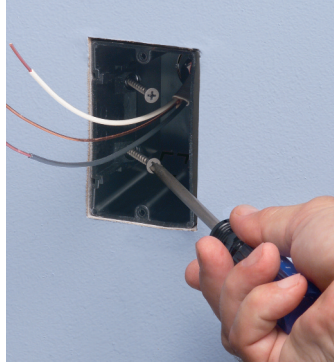

Mounts securely to the stud –
not the drywall

Catalog Number	UPC/DEI/NAED Mfg. #018997	Description Non-Metallic ONE BOX™	Cubic Inches	Unit/Std Pkg
F101	43626	Single-gang	22.5	50
F101H	43634	Single-gang, Horizontal	22.5	20
F102	43640	Two-gang, vertical	42.0	25
F103	43641	Three-gang, vertical	61.0	20
F104	43642	Four-gang, vertical	80.0	20
F102D	43544	Voltage Divider	---	25



F101
Single gang



F101H
Single Horizontal

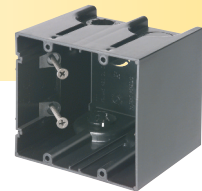

F102
Two-gang



Fan-Rated STEEL ONE BOX for New Construction ...and Retrofit

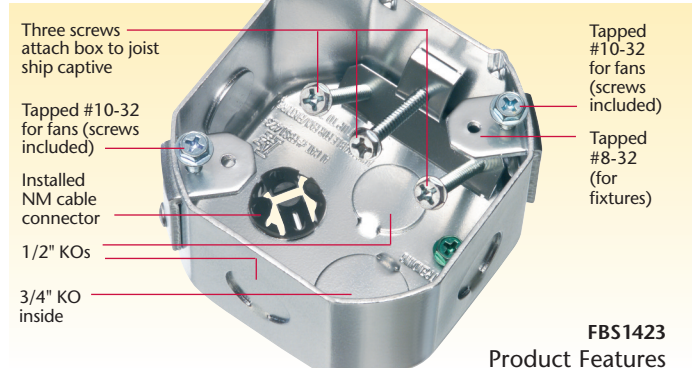
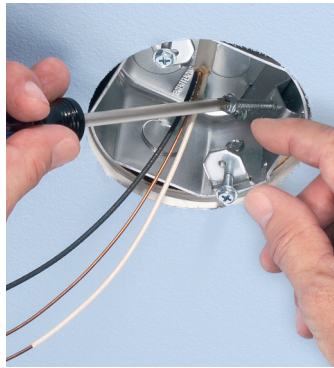

FBS1423 Steel Box includes installed NM cable connector, three (captive) box installation screws and two (captive) #10-32 screws for fan installation.

Catalog Number	UPC/DEI/NAED Mfg. #018997	Cubic Inches	Side-Mount Box Depth	Unit/Std Pkg
FBS1423	76190	23.0	2.375"	10



1 Stauffer Industrial Park
Scranton, PA 18517
800/233.4717
Fax 570/562.0646
www.aifittings.com

Patented. Other patents pending
F426 0116/15M

Distributed by