

GROUNDING BUSBAR - ELECTRICAL BUSBAR

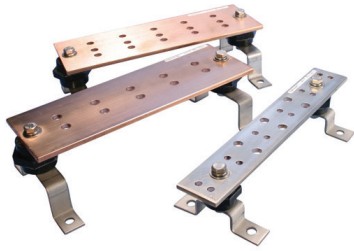

FEATURED HIGHLIGHTS

- Provides a convenient, single-point grounding and bonding location
- Conductors are welded to the bar using a Cadweld exothermic connection or are mechanically fastened by using lugs
- Custom bars can be designed and manufactured to customer specifications

E G B A 1 4 4 1 2 C C

nVent ERICO Ground Bar Designation

Configuration

A = Insul & Brkt C = None (Bar only)
B = Brkt only D = Insul only

Thickness

18 = 1/8" 58 = 5/8" 12 = 1/2"
38 = 3/8" 14 = 1/4" 34 = 3/4"

Width

1 = 1" 4 = 4" 7 = 7"
2 = 2" 5 = 5" 8 = 8"
3 = 3" 6 = 6" 9 = 9"

Pig Tail Length Ft. (Empty if none)

A = 1 E = 5 J = 9 N = 16 S = 24 W = 32
B = 2 F = 6 K = 10 O = 17 T = 25 X = 34
C = 3 G = 7 L = 11 P = 18 U = 26 Y = 36
D = 4 H = 8 M = 12 Q = 19 V = 27 Z = 38

nVent ERICO Cable Code (Empty if none)

1K = #4 Sol Tin 2C = 1/0 2V = 250 KCM
1T = #2 Sol Tin SG = 2/0 3D = 350 KCM
2L = 3/0 3Q = 500 KCM
2Q = 4/0 4L = 750 KCM

Tin Plating (Empty if none)
T = Tinned

Hole Pattern

Length (rounded to the nearest inch, up to 96 inch max.)

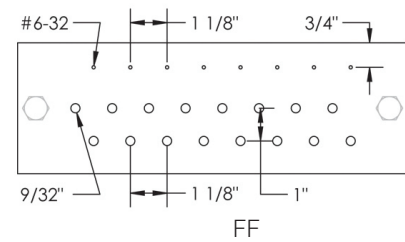
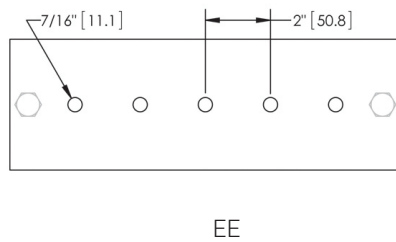
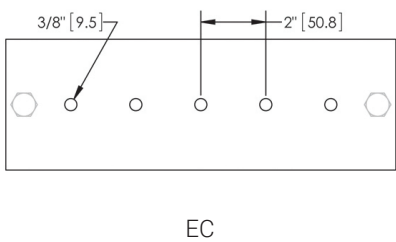
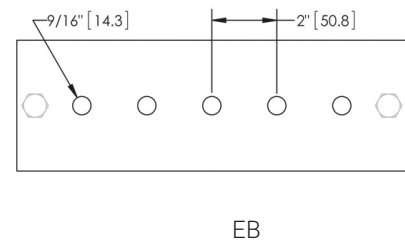
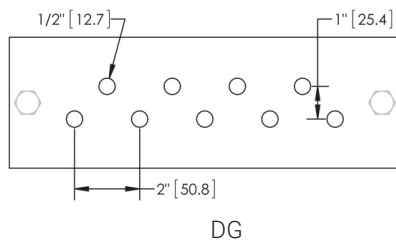
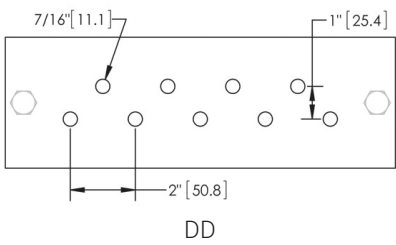
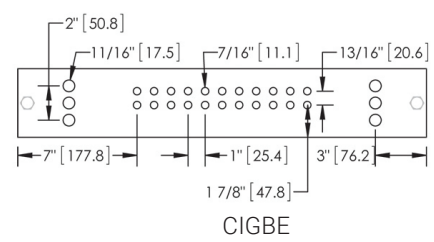
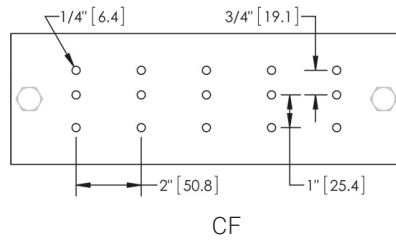
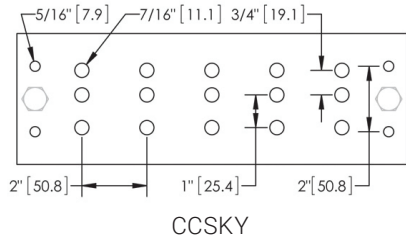
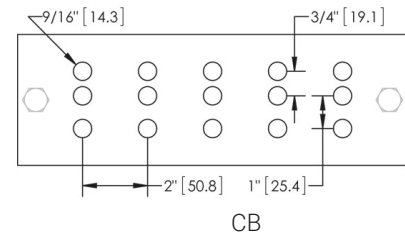
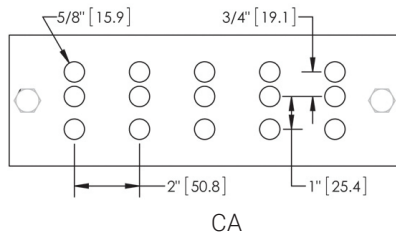
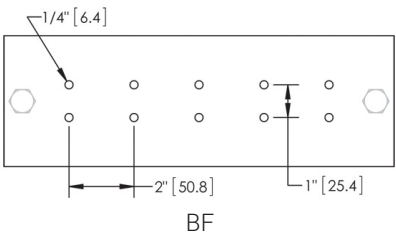
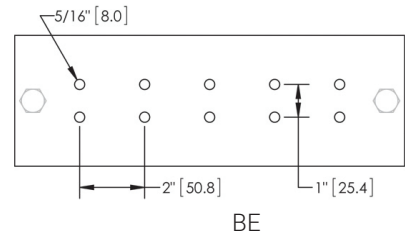
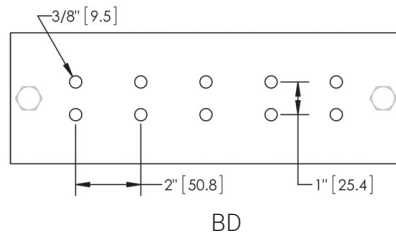
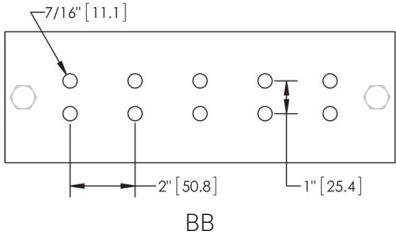
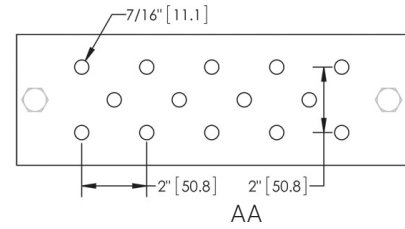
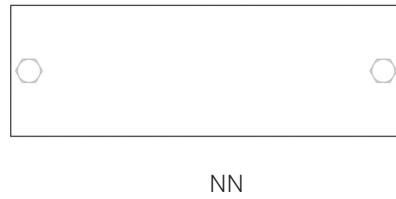
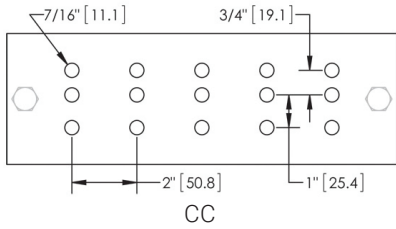

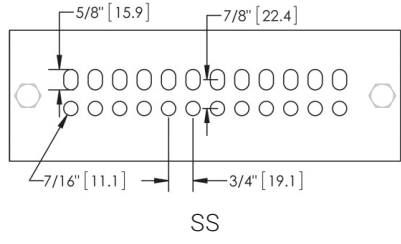
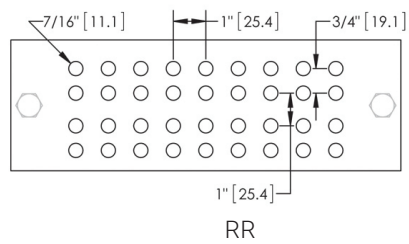
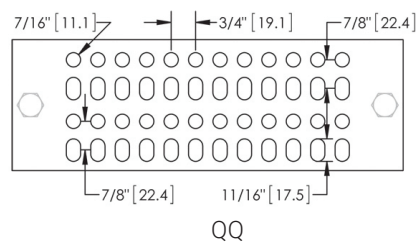
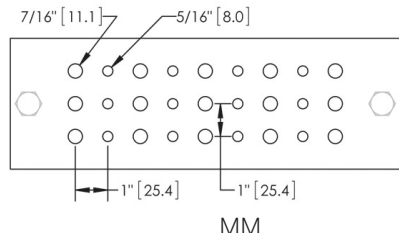
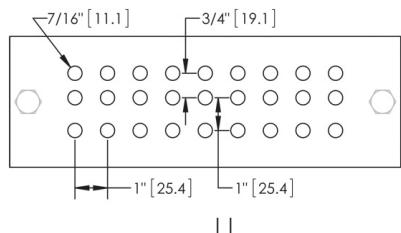
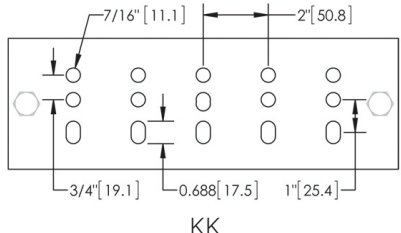
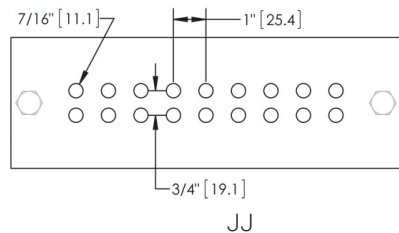
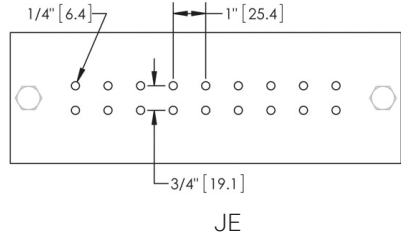
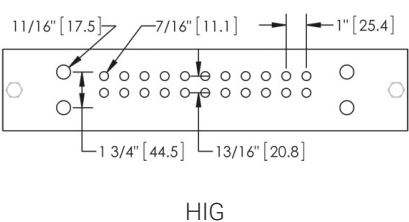
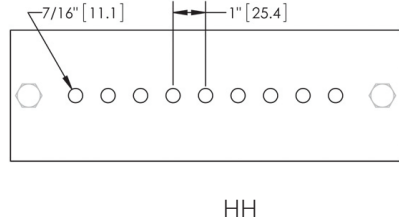
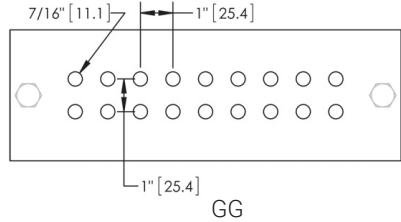
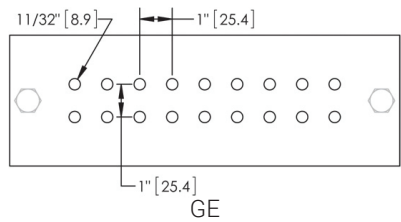

Global Part Number	Hole Pattern	Mounting Hole Size	Length	Width	Thickness	Tin Plating	Pigtail Included
EGBA14112EE	EE	0.438"	12"	1"	1/4"	No	No
EGBA14212BB	BB	0.438"	12"	2"	1/4"	No	No
EGBA14212EE	EE	0.438"	12"	2"	1/4"	No	No
EGBA14212HH	HH	0.438"	12"	2"	1/4"	No	No
EGBA14212NN	NN	0.438"	12"	2"	1/4"	No	No
EGBA14212TES	TES	0.438"	12"	2"	1/4"	No	No
EGBA14215JJ	JJ	0.438"	15"	2"	1/4"	No	No
EGBA14215TES	TES	0.438"	15"	2"	1/4"	No	No
EGBA14224NN	NN	0.438"	24"	2"	1/4"	No	No
EGBA14406CC	CC	0.438"	6"	4"	1/4"	No	No
EGBA14410FF	FF	0.438"	10"	4"	1/4"	No	No
EGBA14412AA	AA	0.438"	12"	4"	1/4"	No	No
EGBA14412BB	BB	0.438"	12"	4"	1/4"	No	No
EGBA14412CC	CC	0.438"	12"	4"	1/4"	No	No
EGBA14412GG	GG	0.438"	12"	4"	1/4"	No	No
EGBA14412LL	LL	0.438"	12"	4"	1/4"	No	No
EGBA14412MM	MM	0.438"	12"	4"	1/4"	No	No
EGBA14412NN	NN	0.438"	12"	4"	1/4"	No	No
EGBA14420CC	CC	0.438"	20"	4"	1/4"	No	No
EGBA14420CCT	CC	0.438"	20"	4"	1/4"	Yes	No
EGBA14420NN	NN	0.438"	20"	4"	1/4"	No	No
EGBA14424CC	CC	0.438"	24"	4"	1/4"	No	No
EGBA14424GG	GG	0.438"	24"	4"	1/4"	No	No
EGBA14424LL	LL	0.438"	24"	4"	1/4"	No	No
EGBA14424MM	MM	0.438"	24"	4"	1/4"	No	No
EGBA14424NN	NN	0.438"	24"	4"	1/4"	No	No
EGBA14436CC	CC	0.438"	36"	4"	1/4"	No	No

GROUNDING BUSBAR - ELECTRICAL BUSBAR

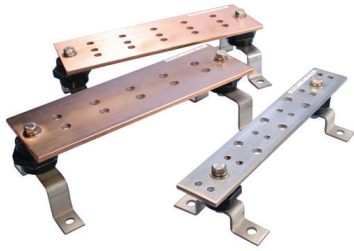

FEATURED HIGHLIGHTS

- Provides a convenient, single-point grounding and bonding location
- Conductors are welded to the bar using a Cadweld exothermic connection or are mechanically fastened by using lugs
- Custom bars can be designed and manufactured to customer specifications

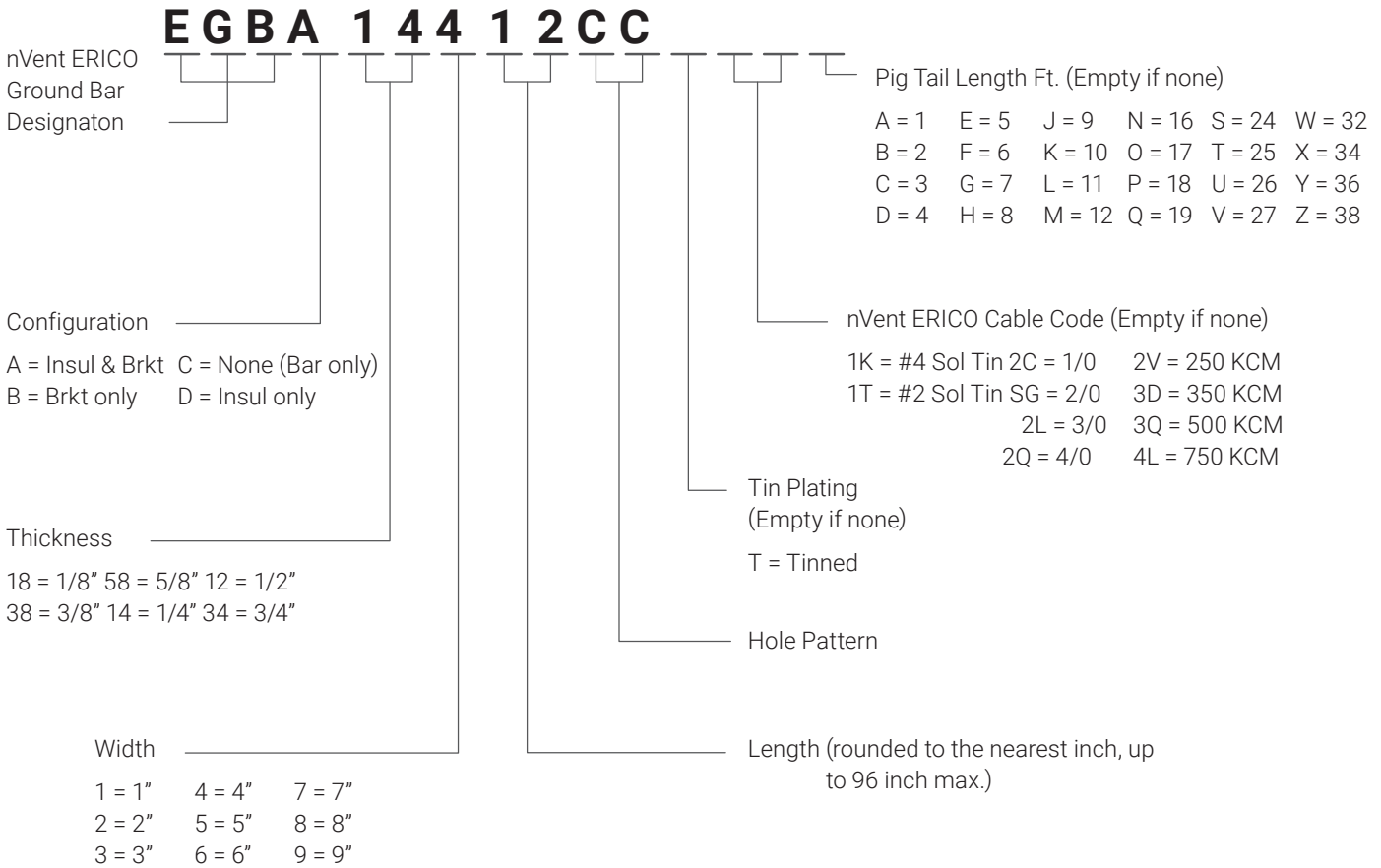

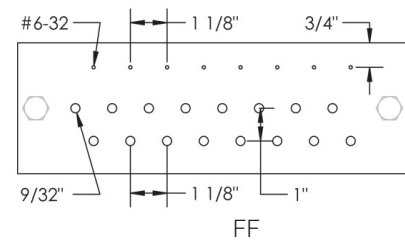
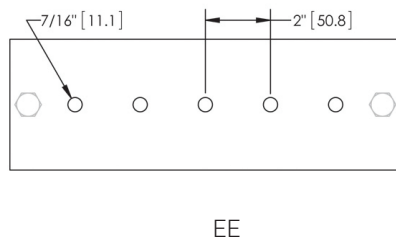
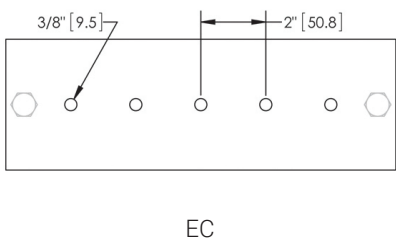
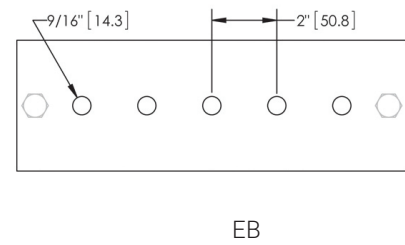
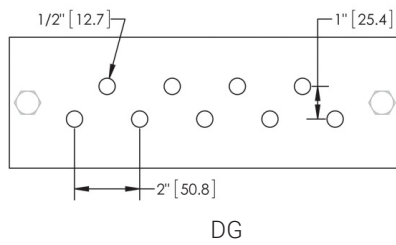
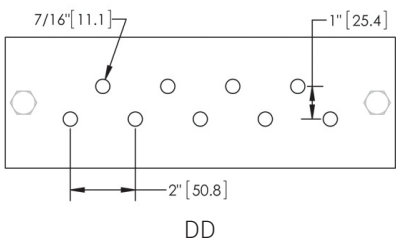
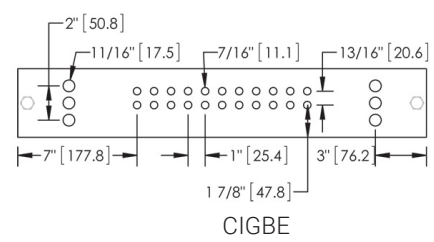
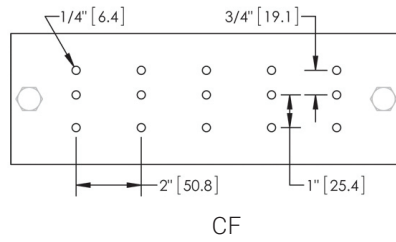
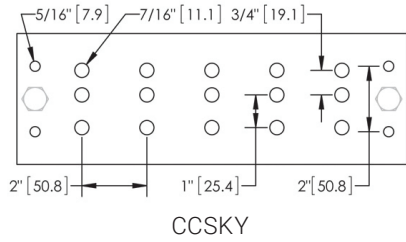
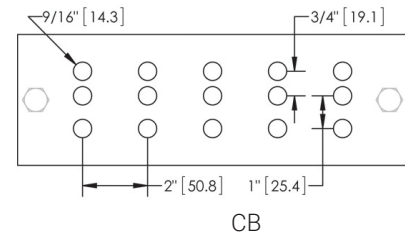
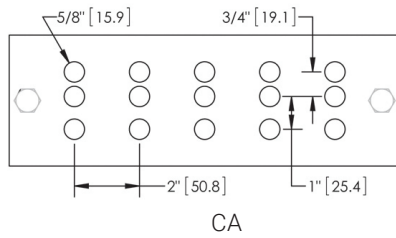
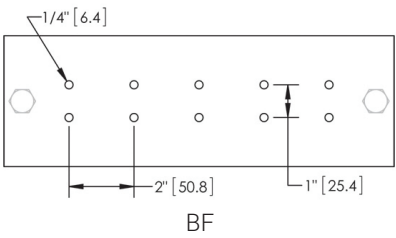
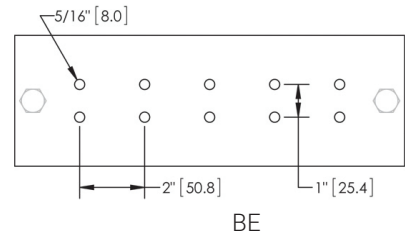
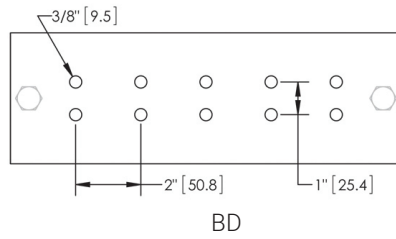
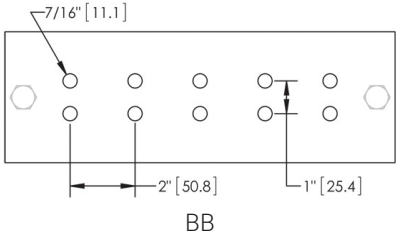
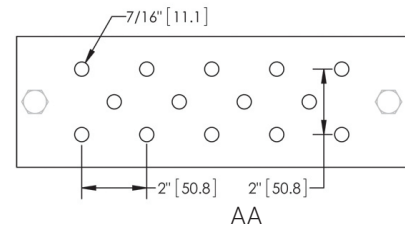
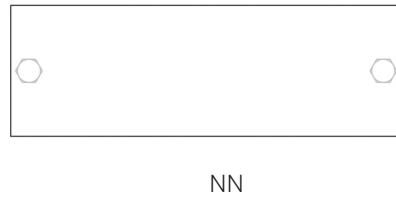
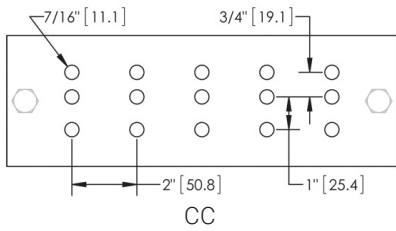

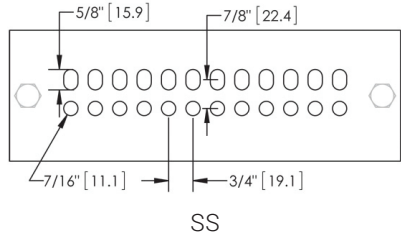
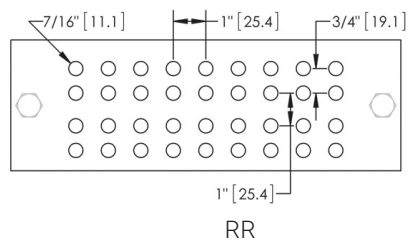
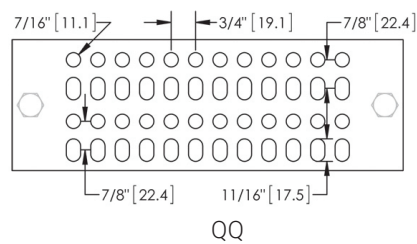
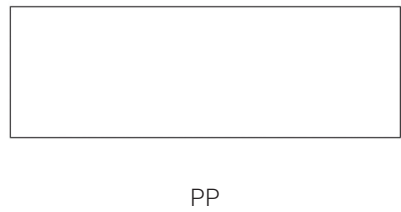
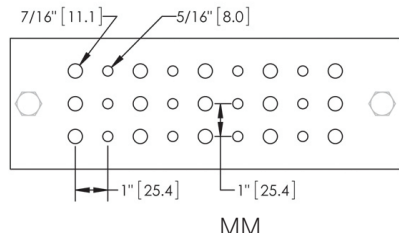
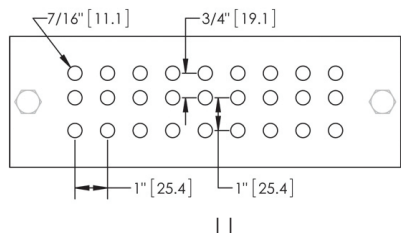
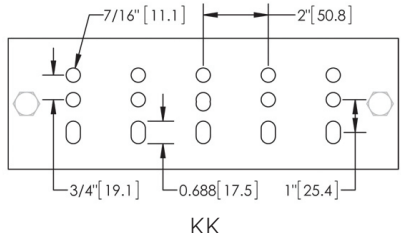
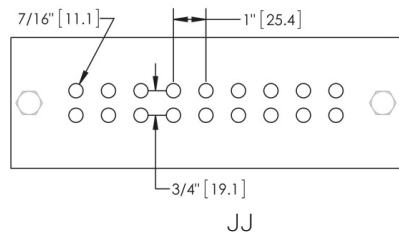
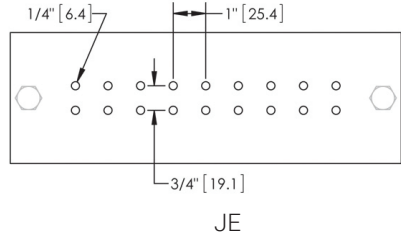
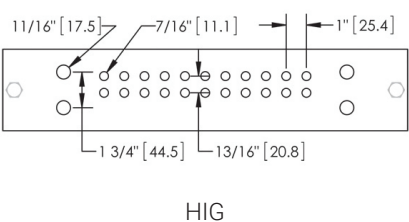
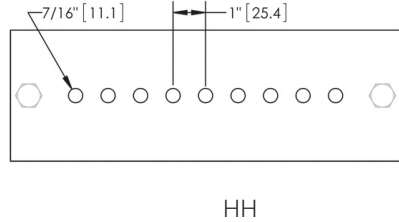
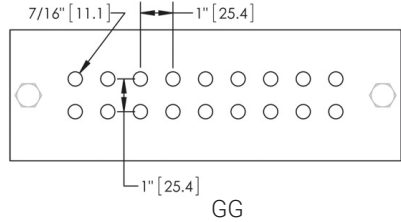
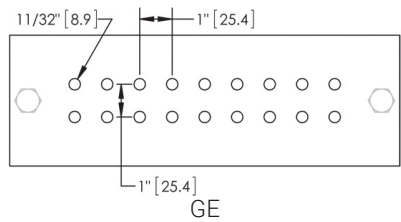

Global Part Number	Hole Pattern	Mounting Hole Size	Length	Width	Thickness	Tin Plating	Pigtail Included
EGBA14112EE	EE	0.438"	12"	1"	1/4"	No	No
EGBA14212BB	BB	0.438"	12"	2"	1/4"	No	No
EGBA14212EE	EE	0.438"	12"	2"	1/4"	No	No
EGBA14212HH	HH	0.438"	12"	2"	1/4"	No	No
EGBA14212NN	NN	0.438"	12"	2"	1/4"	No	No
EGBA14212TES	TES	0.438"	12"	2"	1/4"	No	No
EGBA14215JJ	JJ	0.438"	15"	2"	1/4"	No	No
EGBA14215TES	TES	0.438"	15"	2"	1/4"	No	No
EGBA14224NN	NN	0.438"	24"	2"	1/4"	No	No
EGBA14406CC	CC	0.438"	6"	4"	1/4"	No	No
EGBA14410FF	FF	0.438"	10"	4"	1/4"	No	No
EGBA14412AA	AA	0.438"	12"	4"	1/4"	No	No
EGBA14412BB	BB	0.438"	12"	4"	1/4"	No	No
EGBA14412CC	CC	0.438"	12"	4"	1/4"	No	No
EGBA14412GG	GG	0.438"	12"	4"	1/4"	No	No
EGBA14412LL	LL	0.438"	12"	4"	1/4"	No	No
EGBA14412MM	MM	0.438"	12"	4"	1/4"	No	No
EGBA14412NN	NN	0.438"	12"	4"	1/4"	No	No
EGBA14420CC	CC	0.438"	20"	4"	1/4"	No	No
EGBA14420CCT	CC	0.438"	20"	4"	1/4"	Yes	No
EGBA14420NN	NN	0.438"	20"	4"	1/4"	No	No
EGBA14424CC	CC	0.438"	24"	4"	1/4"	No	No
EGBA14424GG	GG	0.438"	24"	4"	1/4"	No	No
EGBA14424LL	LL	0.438"	24"	4"	1/4"	No	No
EGBA14424MM	MM	0.438"	24"	4"	1/4"	No	No
EGBA14424NN	NN	0.438"	24"	4"	1/4"	No	No
EGBA14436CC	CC	0.438"	36"	4"	1/4"	No	No