

The designer dimmer that matches your paddle switches.



PRODUCT FAMILY FEATURES

- Large paddle switch with a captive linear-slide dimmer for a standard designer wallplate opening
- Full family of products for most lighting sources
- Dimmers feature built-in soft-glow nightlight
- Uses standard single-pole and 3-way wiring for easy installation in any home
- For more Diva choices, see the new Diva Satin Colors product line

DIMENSIONS



CONTROLS AND ACCESSORIES

Preset Dimmers



15 A Receptacle

Fan-Speed Controls



15 A GFCI Receptacle

Switches



20 A Receptacle

20 A GFCI Receptacle

Receptacles



Telephone/Cable TV Jacks



Single Telephone Jack



Cable TV Jack

Ports



6-Port Frame

Standard Multigang Wallplates



2-gang to 6-gang wallplates

SPECIFICATION SERIES STANDARD FEATURES



- Square Law Dimming
 - Power-failure memory
 - Electrostatic discharge tested
 - Mechanical air-gap switch to disconnect load power
 - RFI suppression
 - Captive linear slider
 - Precise color matching
- Lutron controls are rated at 120 V~, 60 Hz unless otherwise noted.

JOB NAME	AREA CONTROLLED
LOCATION	JOB NUMBER
TITLE	PAGE NO.

Description	Maximum Capacity ^{1,6}	Model #
-------------	---------------------------------	---------

DIMMERS

 Incandescent		
<i>Preset Dimmers with Nightlight</i>		
 Single-pole	600 W	DV-600P-
Single-pole	1000 W	DV-10P-
3-way	600 W	DV-603P-
3-way	1000 W	DV-103P-

Note: The nightlight is visible best on the lighter colors. For 3-way and 4-way switching, use with Claro switches or other mechanical switches.

 Electronic Low-Voltage		
---	--	--

<i>Preset Dimmers with Nightlight</i>		
 Single-pole	300 W	DVELV-300P-
3-way	300 W	DVELV-303P-

Note: Requires neutral wire connection. The nightlight is visible best on the lighter colors. For 3-way and 4-way switching, use with Claro switches or other mechanical switches.

 Magnetic Low-Voltage		
---	--	--

<i>Preset Dimmers with Nightlight</i>		
 Single-pole	600 VA (450 W) ²	DVLV-600P-
Single-pole	1000 VA (800 W) ²	DVLV-10P-
3-way	600 VA (450 W) ²	DVLV-603P-
3-way	1000 VA (800 W) ²	DVLV-103P-

Note: The nightlight is visible best on the lighter colors. For 3-way and 4-way switching, use with Claro switches or other mechanical switches.

 3-Wire LED/Fluorescent Ballast		
---	--	--

<i>Preset Dimmers with Nightlight</i> ⁴		
 Single-pole/ 3-way	8 A	DVF-103P-
Single-pole/ 3-way, 277 V~	6 A	DVF-103P-277-

Note: Requires neutral wire connection. The nightlight is visible best on the lighter colors. For 3-way and 4-way switching, use with Claro switches or other mechanical switches.

Description	Maximum Capacity ^{1,6}	Model #
-------------	---------------------------------	---------

FAN-SPEED CONTROLS

 Quiet Controls		
---	--	--

For use with one ceiling paddle fan.		
<i>Preset Fan-Speed Controls</i> ^{3, 4}		
 Single-pole/3-way,	1.5 A	DVFSQ-F-
3-speed		

*Light Switch/ Fan-Speed Control*⁴

Fan 3-speed with off	1.5 A	DVFSQ-LF-
----------------------	-------	-----------

Single-pole switch:		
Inc./ Hal.	2 A	
CFL/ LED	1 A	

Note: Does not have soft-glow nightlight.

SWITCHES⁴

General Purpose Switching of all Sources and Motor Loads

 Single-pole, 120/277 V~	15 A	CA-1PS-
3-way, 120/277 V~	15 A	CA-3PS-
4-way, 120/277 V~	15 A	CA-4PS-

ACCESSORIES

Receptacles

<i>Receptacle</i> ⁴		
 125 V~	15 A	CAR-15-
125 V~	20 A	CAR-20-

<i>GFCI Receptacle</i> ⁴		
 125 V~	15 A	CAR-15-GFST-
125 V~	20 A	CAR-20-GFST-

Telephone and Cable Television Jacks

A physical barrier (partition) must exist when ganging with line-voltage products		
<i>Single Telephone Jack</i> ⁵		
 6-conductor, RJ11		CA-PJ-

Note: Also accepts most 4-conductor plugs.

<i>Cable TV Jack</i> ^{4, 5}		
 F-STYLE		
75 Ω, coaxial cable jack		CA-CJ-

1 For capacities in multigang installations see **Derating/Maximum Capacity** on pg. 4

2 Actual lamp wattages.

3 For 3-way and 4-way switching, use with Claro switches or other mechanical switches.

4 No derating required if ganged.

5 A physical barrier (partition) must exist when ganging with line-voltage products.

6 For minimum load requirements see **Minimum Load Requirements** on pg. 4

Description	Rating	Model #
-------------	--------	---------

ACCESSORIES

Field Customizable Multi-Port Frame



6-Port Frame	Shipped with 6 blanks <i>Shown with blanks</i>	CA-6PF- <input type="checkbox"/>
--------------	---	----------------------------------

Product above: For use with Lutron connectors shown below. Also compatible with Hubble Xcelerator and snap-fit connectors.

Connectors

For use with 6-port frame (CA-6PF-). Each connector fills one port.

	Phone Jack	6-conductor, RJ11, Category 3	CON-1P-C3-WH
	Phone Jack	8-conductor, RJ45, Category 5e	CON-1P-C5E-WH
	Phone Jack	8-conductor, RJ45, Category 6	CON-1P-C6-WH
	Fiber Jack	MT-RJ Feed-Through	CON-1F-MTRJ-WH
	Fiber Jack	SC Simplex	CON-1F-SC-WH
	Fiber Jack	LC Non-Flush Mount	CON-1F-LC-WH
	Fiber Jack	ST Style	CON-1F-ST-WH
	Cable Jack	F-Style, 75 Ω Coaxial cable	CON-1C-WH
	BNC Jack	BNC connector	CON-1B-WH

Connectors available in white (WH) only. For information about additional colors contact Lutron Customer Service.

Description Model #

STANDARD WALLPLATES

	1-Gang 2.94 in (75 mm) W x 4.69 in (119 mm) H x 0.30 in (7.6 mm) D	CW-1-
	2-Gang 4.75 in (121 mm) W x 4.69 in (119 mm) H x 0.30 in (7.6 mm) D	CW-2-
	3-Gang 6.56 in (167 mm) W x 4.69 in (119 mm) H x 0.30 in (7.6 mm) D	CW-3-
	4-Gang 8.37 in (213 mm) W x 4.69 in (119 mm) H x 0.30 in (7.6 mm) D	CW-4-
	5-Gang 10.18 in (259 mm) W x 4.69 in (119 mm) H x 0.30 in (7.6 mm) D	CW-5-
	6-Gang 12.00 in (305 mm) W x 4.69 in (119 mm) H x 0.30 in (7.6 mm) D	CW-6-

STANDARD COLORS/FINISHES



Gloss Finishes

Add color/finish suffix to model number to order.
Example: DV-600P-SW

SW	Snow	MN	Midnight
TP	Taupe	BI	Biscuit
ES	Eggshell	PD	Palladium
HT	Hot	MR	Merlot
PL	Plum	SI	Sienna
TC	Terracotta	BG	Bluestone
GB	Green Briar	GS	Goldstone
MS	Mocha Stone	ST	Stone
DS	Desert Stone	LS	Limestone

For the latest color offerings please see our website:
<http://www.lutron.com/satincolors>

DERATING/MAXIMUM CAPACITY

		
No side sections removed (Full Capacity)	One side section removed (End Units)	Two side sections removed (Middle Unit)

Incandescent Dimmers

600 W	500 W	400 W
1000 W	800 W	650 W

Electronic Low-Voltage

300 W	250 W	200 W
-------	-------	-------

Magnetic Low-Voltage

600 VA (450 W ¹)	500 VA (375 W ¹)	400 VA (300 W ¹)
1000 VA (800 W ¹)	800 VA (650 W ¹)	650 VA (500 W ¹)

Fluorescent

Hi-lume/Eco-10 20 ballasts/ 8 A No derating required
(ECO-Series)

Fan-Speed Controls

1.5 A	No derating required
-------	----------------------

¹ Actual lamp wattage.

MINIMUM LOAD REQUIREMENTS

Incandescent/Magnetic Low-Voltage

40 W

Electronic Low-Voltage

5 W

Fluorescent

Hi-lume/Eco-10 1 ballast
(ECO-Series)

Fan-Speed Controls

.33 A (40 W)

WIRING DIAGRAMS

**Wiring Diagram 1
Single-Pole Wiring**

Model #

DV-600P-
DV-10P-
DVLV-600P-
DVLV-10P-
CA-1PS-



Ground
 Wire Connectors
 * or Brass screw terminal
 ** or Green screw terminal

**Wiring Diagram 4
3-Way Wiring**

Model #

DVELV-303P-
CA-3PS-



Ground
 Wire Connectors
 * or Copper/Black screw terminal
 ** or Brass/Gold screw terminal

Note: 3-way switch must be wired on the line side of the dimmer.

**Wiring Diagram 2
Single-Pole Wiring of 3-Way Control**

Model #

DVFSQ-F-
DVLV-103P-
DVLV-603P-
DV-103P-
DV-603P-



Ground
 Wire Connectors
 * or Copper/Black screw terminal
 ** or Brass screw terminal
 *** or Green screw terminal
 † or Red/White stripe (cap off)

**Wiring Diagram 5
3-Way Used as Single-Pole**

Model #

DVELV-303P-



Ground
 Wire Connectors

**Wiring Diagram 3
Single-Pole Wiring**

Model #

DVELV-300P-

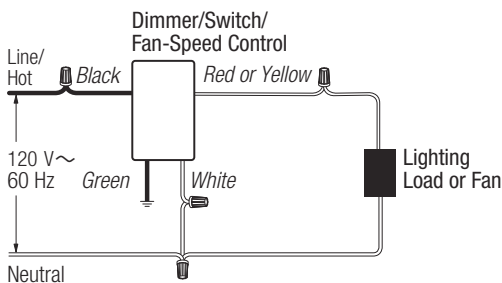

Ground
 Wire Connectors

WIRING DIAGRAMS

Wiring Diagram 6
3-Way Wiring



Wiring Diagram 7
4-Way Wiring

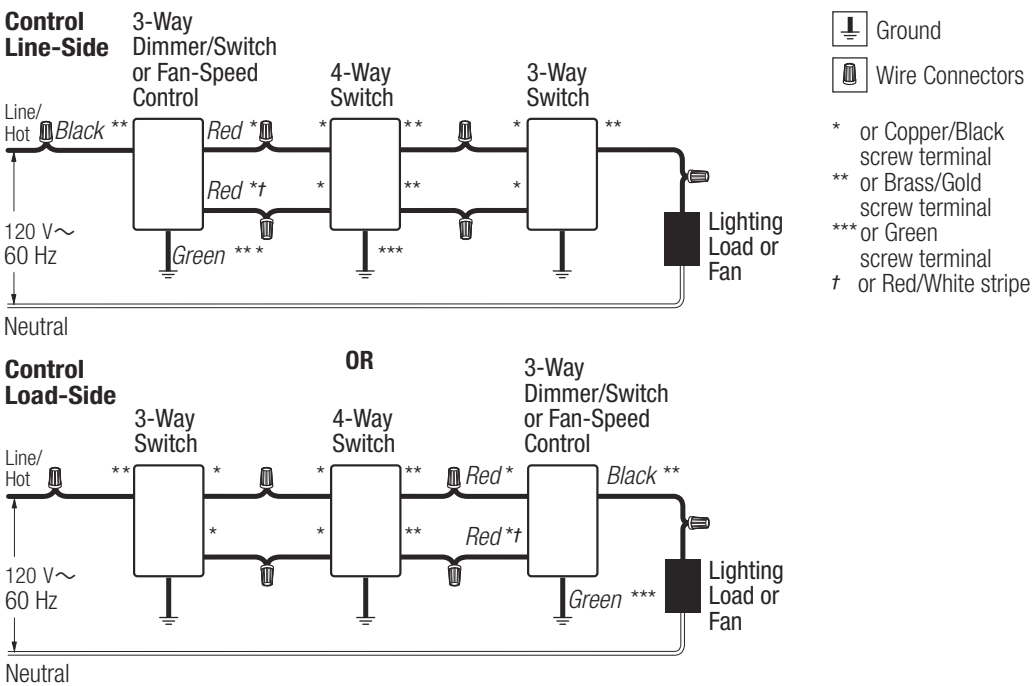

WIRING DIAGRAMS

Wiring Diagram 8
Single-Pole Wiring of a 3-Way Control

Model #



DVF-103P-
DVF-103P-277-

Wiring Diagram 9
3-Way Wiring

Model #

Control Load-Side



DVF-103P-
DVF-103P-277-
CA-3PS-

* 3-Way switch must be wired on line side of dimmer
 ** must use lamp disconnect sockets with magnetic dimming ballasts
 *** or Yellow/Blue or Yellow/Green when used with magnetic dimming ballasts
 † or Copper/Black screw terminal
 †† or Brass/Gold screw terminal

WIRING DIAGRAMS

**Wiring Diagram 10
Cable TV Jack Wiring**

Model #



CA-CJ-

**Wiring Diagram 11
Telephone Jack Wiring**

Model #



CA-PJ-

* accepts most 4-conductor jacks

**Wiring Diagram 12
Receptacle Wiring**

Model #

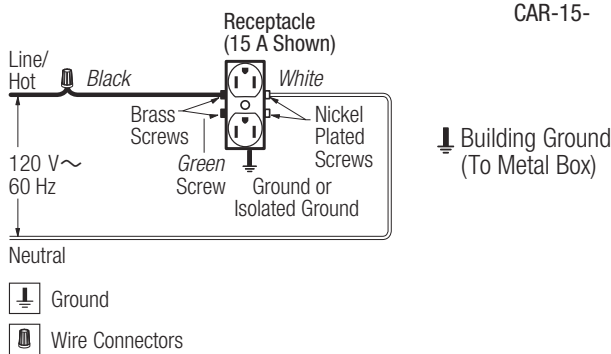

CAR-15-

**Wiring Diagram 13
GFCI Receptacle Wiring**

Model #



CAR-15-GFST-

P-Protected
NP-Not Protected

Wire Connectors

Lutron, Lutron, Diva, Claro, Hi-lume, Eco-10, and Tu-Wire are trademarks of Lutron Electronics Co., Inc., registered in the U.S. and other countries.
©2017-2019 Lutron Electronics Co., Inc.

The designer dimmer that matches your paddle switches.



PRODUCT FAMILY FEATURES

- Large paddle switch with a captive linear-slide dimmer for a standard designer wallplate opening
- Full family of products for most lighting sources
- Dimmers feature built-in soft-glow nightlight
- Uses standard single-pole and 3-way wiring for easy installation in any home
- For more Diva choices, see the new Diva Satin Colors product line

DIMENSIONS



CONTROLS AND ACCESSORIES

Preset Dimmers



15 A Receptacle

Fan-Speed Controls



15 A GFCI Receptacle

Switches



20 A Receptacle

20 A GFCI Receptacle

Receptacles



Telephone/Cable TV Jacks



Single Telephone Jack



Cable TV Jack

Ports



6-Port Frame

Standard Multigang Wallplates



2-gang to 6-gang wallplates

SPECIFICATION SERIES STANDARD FEATURES



- Square Law Dimming
 - Power-failure memory
 - Electrostatic discharge tested
 - Mechanical air-gap switch to disconnect load power
 - RFI suppression
 - Captive linear slider
 - Precise color matching
- Lutron controls are rated at 120 V~, 60 Hz unless otherwise noted.

JOB NAME	AREA CONTROLLED
LOCATION	JOB NUMBER
TITLE	PAGE NO.

Description	Maximum Capacity ^{1,6}	Model #
-------------	---------------------------------	---------

DIMMERS

 Incandescent		
<i>Preset Dimmers with Nightlight</i>		
 Single-pole	600 W	DV-600P-
Single-pole	1000 W	DV-10P-
3-way	600 W	DV-603P-
3-way	1000 W	DV-103P-

Note: The nightlight is visible best on the lighter colors. For 3-way and 4-way switching, use with Claro switches or other mechanical switches.

 Electronic Low-Voltage		
---	--	--

<i>Preset Dimmers with Nightlight</i>		
 Single-pole	300 W	DVELV-300P-
3-way	300 W	DVELV-303P-

Note: Requires neutral wire connection. The nightlight is visible best on the lighter colors. For 3-way and 4-way switching, use with Claro switches or other mechanical switches.

 Magnetic Low-Voltage		
---	--	--

<i>Preset Dimmers with Nightlight</i>		
 Single-pole	600 VA (450 W) ²	DVLV-600P-
Single-pole	1000 VA (800 W) ²	DVLV-10P-
3-way	600 VA (450 W) ²	DVLV-603P-
3-way	1000 VA (800 W) ²	DVLV-103P-

Note: The nightlight is visible best on the lighter colors. For 3-way and 4-way switching, use with Claro switches or other mechanical switches.

 3-Wire LED/Fluorescent Ballast		
---	--	--

<i>Preset Dimmers with Nightlight</i> ⁴		
 Single-pole/ 3-way	8 A	DVF-103P-
Single-pole/ 3-way, 277 V~	6 A	DVF-103P-277-

Note: Requires neutral wire connection. The nightlight is visible best on the lighter colors. For 3-way and 4-way switching, use with Claro switches or other mechanical switches.

Description	Maximum Capacity ^{1,6}	Model #
-------------	---------------------------------	---------

FAN-SPEED CONTROLS

 Quiet Controls		
---	--	--

For use with one ceiling paddle fan.		
<i>Preset Fan-Speed Controls</i> ^{3,4}		
 Single-pole/3-way,	1.5 A	DVFSQ-F-
3-speed		

<i>Light Switch/ Fan-Speed Control</i> ⁴		
Fan 3-speed with off	1.5 A	DVFSQ-LF-
Single-pole switch:		
Inc./ Hal.	2 A	
CFL/ LED	1 A	

Note: Does not have soft-glow nightlight.

SWITCHES⁴

General Purpose Switching of all Sources and Motor Loads

 Single-pole, 120/277 V~	15 A	CA-1PS-
3-way, 120/277 V~	15 A	CA-3PS-
4-way, 120/277 V~	15 A	CA-4PS-

ACCESSORIES

Receptacles

<i>Receptacle</i> ⁴		
 125 V~	15 A	CAR-15-
125 V~	20 A	CAR-20-

<i>GFCI Receptacle</i> ⁴		
 125 V~	15 A	CAR-15-GFST-
125 V~	20 A	CAR-20-GFST-

Telephone and Cable Television Jacks

A physical barrier (partition) must exist when ganging with line-voltage products		
<i>Single Telephone Jack</i> ⁵		
 6-conductor, RJ11		CA-PJ-

Note: Also accepts most 4-conductor plugs.

<i>Cable TV Jack</i> ^{4,5}		
 F-STYLE		
75 Ω, coaxial cable jack		CA-CJ-

1 For capacities in multigang installations see **Derating/Maximum Capacity** on pg. 4

2 Actual lamp wattages.

3 For 3-way and 4-way switching, use with Claro switches or other mechanical switches.

4 No derating required if ganged.

5 A physical barrier (partition) must exist when ganging with line-voltage products.

6 For minimum load requirements see **Minimum Load Requirements** on pg. 4

Description	Rating	Model #
-------------	--------	---------

ACCESSORIES

Field Customizable Multi-Port Frame



6-Port Frame	Shipped with 6 blanks <i>Shown with blanks</i>	CA-6PF- <input type="checkbox"/>
--------------	---	----------------------------------

Product above: For use with Lutron connectors shown below. Also compatible with Hubble Xcelerator and snap-fit connectors.

Connectors

For use with 6-port frame (CA-6PF-). Each connector fills one port.

	Phone Jack	6-conductor, RJ11, Category 3	CON-1P-C3-WH
	Phone Jack	8-conductor, RJ45, Category 5e	CON-1P-C5E-WH
	Phone Jack	8-conductor, RJ45, Category 6	CON-1P-C6-WH
	Fiber Jack	MT-RJ Feed-Through	CON-1F-MTRJ-WH
	Fiber Jack	SC Simplex	CON-1F-SC-WH
	Fiber Jack	LC Non-Flush Mount	CON-1F-LC-WH
	Fiber Jack	ST Style	CON-1F-ST-WH
	Cable Jack	F-Style, 75 Ω Coaxial cable	CON-1C-WH
	BNC Jack	BNC connector	CON-1B-WH

Connectors available in white (WH) only. For information about additional colors contact Lutron Customer Service.

Description	Model #
-------------	---------

STANDARD WALLPLATES

	1-Gang 2.94 in (75 mm) W x 4.69 in (119 mm) H x 0.30 in (7.6 mm) D CW-1-
	2-Gang 4.75 in (121 mm) W x 4.69 in (119 mm) H x 0.30 in (7.6 mm) D CW-2-
	3-Gang 6.56 in (167 mm) W x 4.69 in (119 mm) H x 0.30 in (7.6 mm) D CW-3-
	4-Gang 8.37 in (213 mm) W x 4.69 in (119 mm) H x 0.30 in (7.6 mm) D CW-4-
	5-Gang 10.18 in (259 mm) W x 4.69 in (119 mm) H x 0.30 in (7.6 mm) D CW-5-
	6-Gang 12.00 in (305 mm) W x 4.69 in (119 mm) H x 0.30 in (7.6 mm) D CW-6-

STANDARD COLORS/FINISHES



Gloss Finishes

Add color/finish suffix to model number to order.
Example: DV-600P-SW

SW	Snow	MN	Midnight
TP	Taupe	BI	Biscuit
ES	Eggshell	PD	Palladiom
HT	Hot	MR	Merlot
PL	Plum	SI	Sienna
TC	Terracotta	BG	Bluestone
GB	Green Briar	GS	Goldstone
MS	Mocha Stone	ST	Stone
DS	Desert Stone	LS	Limestone

For the latest color offerings please see our website:
<http://www.lutron.com/satincolors>

DERATING/MAXIMUM CAPACITY

 No side sections removed (Full Capacity)	 One side section removed (End Units)	 Two side sections removed (Middle Unit)
---	--	---

Incandescent Dimmers

600 W	500 W	400 W
1000 W	800 W	650 W

Electronic Low-Voltage

300 W	250 W	200 W
-------	-------	-------

Magnetic Low-Voltage

600 VA (450 W ¹)	500 VA (375 W ¹)	400 VA (300 W ¹)
1000 VA (800 W ¹)	800 VA (650 W ¹)	650 VA (500 W ¹)

Fluorescent

Hi-lume/Eco-10 20 ballasts/ 8 A No derating required (ECO-Series)

Fan-Speed Controls

1.5 A	No derating required
-------	----------------------

¹ Actual lamp wattage.

MINIMUM LOAD REQUIREMENTS

Incandescent/Magnetic Low-Voltage

40 W

Electronic Low-Voltage

5 W

Fluorescent

Hi-lume/Eco-10 1 ballast (ECO-Series)

Fan-Speed Controls

.33 A (40 W)

WIRING DIAGRAMS

Wiring Diagram 1
Single-Pole Wiring

Model #

DV-600P-
DV-10P-
DVLV-600P-
DVLV-10P-
CA-1PS-



Ground
Wire Connectors
* or Brass screw terminal
** or Green screw terminal

Wiring Diagram 4
3-Way Wiring

Model #

DVELV-303P-
CA-3PS-



Ground
Wire Connectors
* or Copper/Black screw terminal
** or Brass/Gold screw terminal

Note: 3-way switch must be wired on the line side of the dimmer.

Wiring Diagram 2
Single-Pole Wiring of 3-Way Control

Model #

DVFSQ-F-
DVLV-103P-
DVLV-603P-
DV-103P-
DV-603P-



Ground
Wire Connectors
* or Copper/Black screw terminal
** or Brass screw terminal
*** or Green screw terminal
‡ or Red/White stripe (cap off)

Wiring Diagram 5
3-Way Used as Single-Pole

Model #

DVELV-303P-



Ground
Wire Connectors

Wiring Diagram 3
Single-Pole Wiring

Model #

DVELV-300P-

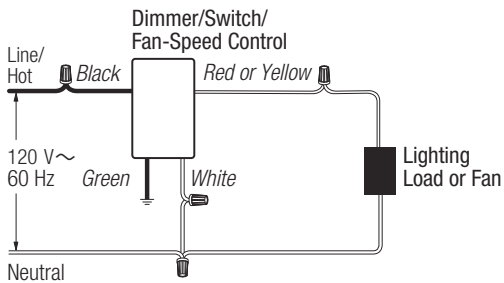

Ground
Wire Connectors

WIRING DIAGRAMS

Wiring Diagram 6
3-Way Wiring



Model #

- DV-603P-
- DV-103P-
- DVLV-603P-
- DVLV-103P-
- DVFSQ-F-
- CA-3PS-

Wiring Diagram 7
4-Way Wiring



Model #

- DV-603P-
- DV-103P-
- DVLV-603P-
- DVLV-103P-
- DVFSQ-F-
- CA-3PS-
- CA-4PS-

WIRING DIAGRAMS

Wiring Diagram 8
Single-Pole Wiring of a 3-Way Control

Model #

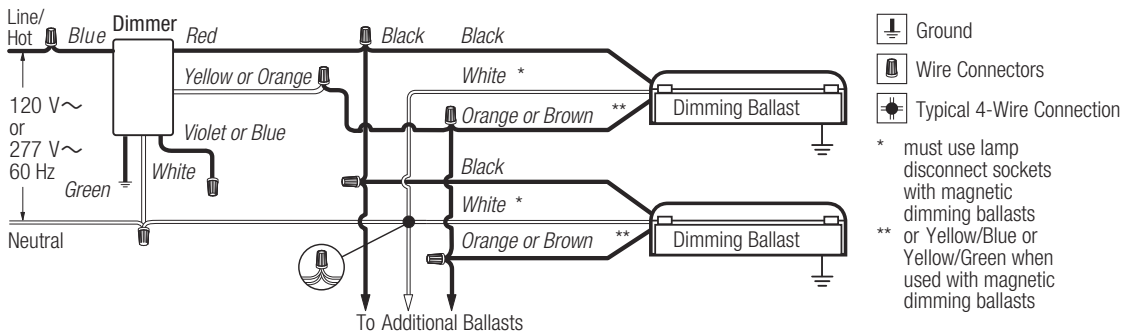

DVF-103P-
DVF-103P-277-

Wiring Diagram 9
3-Way Wiring

Model #

Control
Load-Side



DVF-103P-
DVF-103P-277-
CA-3PS-

* 3-Way switch must be wired on line side of dimmer
 ** must use lamp disconnect sockets with magnetic dimming ballasts
 *** or Yellow/Blue or Yellow/Green when used with magnetic dimming ballasts
 † or Copper/Black screw terminal
 †† or Brass/Gold screw terminal

WIRING DIAGRAMS

**Wiring Diagram 10
Cable TV Jack Wiring**

Model #



CA-CJ-

**Wiring Diagram 11
Telephone Jack Wiring**

Model #



CA-PJ-

* accepts most 4-conductor jacks

**Wiring Diagram 12
Receptacle Wiring**

Model #

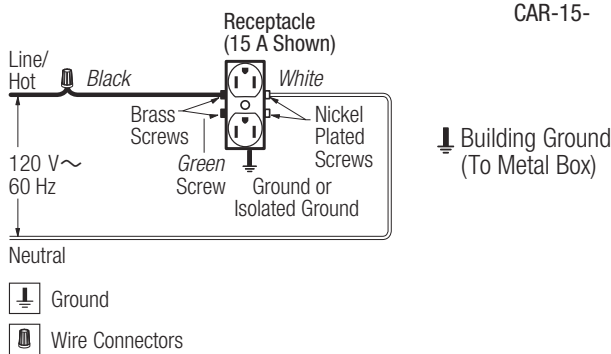

CAR-15-

**Wiring Diagram 13
GFCI Receptacle Wiring**

Model #



CAR-15-GFST-

P-Protected
NP-Not Protected

Wire Connectors

Lutron, Lutron, Diva, Claro, Hi-lume, Eco-10, and Tu-Wire are trademarks of Lutron Electronics Co., Inc., registered in the U.S. and other countries.
©2017-2019 Lutron Electronics Co., Inc.