

Wrenches

Klein's line of wrenches are forged from the finest steel and are designed to deliver great strength and long working life. Regardless of the job type, Klein has a wrench that will help the professional complete the task at hand.

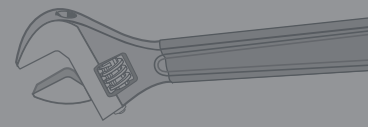

For Professionals...
Since 1857™



Adjustable Wrenches

Precision-machined jaws are individually chosen and assembled by hand for smooth operation

Chrome-plated for corrosion resistance

Standard and metric scales for faster adjustment

Knurl turns smoothly for easy operation

Contoured handles for comfortable use

Rail is ground for precision fit

Minimally protruding jaw shank for greater capacity in tight spaces

4-threaded knurl worm gear for improved balance



Adjustable Wrenches - High Capacity

Additional Features:

- Extra capacity allows use of a smaller size wrench to handle bigger jobs, especially in confined spaces
- Forged heat-treated alloy steel for maximum strength and light weight



D507-8

Cat. No.	Handle Finish	Handle Color	Length	Capacity	Weight
507-6	High-Polish Chrome	Chrome	6-3/8" (161.9 mm)	15/16" (23.8 mm)	4.6 oz. (130 g)
507-8	High-Polish Chrome	Chrome	8-1/8" (206.4 mm)	1-1/8" (28.6 mm)	9.8 oz. (278 g)
507-10	High-Polish Chrome	Chrome	10-1/8" (257.2 mm)	1-5/16" (33.3 mm)	15.7 oz. (445 g)
507-12	High-Polish Chrome	Chrome	12-1/4" (311.2 mm)	1-1/2" (38.1 mm)	26.4 oz. (748 g)
D507-6	Plastic-Dipped	Transparent Red	6-1/2" (165.1 mm)	15/16" (23.8 mm)	5.3 oz. (150 g)
D507-8	Plastic-Dipped	Transparent Red	8-1/4" (209.6 mm)	1-1/8" (28.6 mm)	10.6 oz. (301 g)
D507-10	Plastic-Dipped	Transparent Red	10-1/4" (260.4 mm)	1-5/16" (33.3 mm)	17.8 oz. (503 g)
D507-12	Plastic-Dipped	Transparent Red	12-3/8" (314.3 mm)	1-1/2" (38.1 mm)	28.8 oz. (816 g)

Adjustable Wrench - Extra-Wide Jaw

Additional Features:

- Extra wide 1-1/2" jaw provides same capacity as a standard 12" adjustable wrench
- Forged heat-treated alloy steel for maximum strength and light weight



D509-8

Cat. No.	Handle Finish	Handle Color	Length	Capacity	Weight
D509-8	Plastic-Dipped	Solid Blue	8-1/2" (215.9 mm)	1-1/2" (38.1 mm)	12.3 oz. (349 g)

Adjustable Wrenches - Standard Capacity

Additional Features:

- Forged heat-treated alloy steel for maximum strength and light weight



506-15

Cat. No.	Handle Finish	Handle Color	Length	Capacity	Weight
D506-4	Plastic-Dipped	Transparent Red	4-1/2" (114.3 mm)	1/2" (12.7 mm)	2.1 oz. (60 g)
506-15	High-Polish Chrome	Chrome	15-7/8" (403.2 mm)	1-11/16" (42.9 mm)	2.9 lbs. (1.32 kg)
500-18	High-Polish Chrome	Chrome	18-1/4" (463.6 mm)	2-1/16" (52.4 mm)	4.7 lbs. (2.13 kg)
500-24	High-Polish Chrome	Chrome	24" (609.6 mm)	2-1/2" (63.5 mm)	7.8 lbs. (3.54 kg)

See page 310 for additional information on warnings.



Combination Wrenches

Corrosion resistant

Forged from the highest quality alloy steel

Durable chrome-plated finish

Open ends are offset at standard 15° angle for confined working areas

Combination wrenches have the same size opening on each end

Box ends have 15° angle offset to provide clearance over obstructions



7-Piece Combination Wrench Set - SAE

Cat. No.	Set Contains	Weight	
68400		1.2 lbs. (0.54 kg)	
Cat. No.	Size	Length	Box End Point
68410	1/4"	5-1/8" (130.2 mm)	12
68411	5/16"	4-3/8" (111.1 mm)	12
68412	3/8"	6-1/8" (155.6 mm)	12
68413	7/16"	6-5/8" (168.3 mm)	12
68414	1/2"	7-1/8" (181.0 mm)	12
68415	9/16"	7-1/2" (190.5 mm)	12
68416	5/8"	8-1/2" (215.9 mm)	12

Includes pouch with marked pockets for each wrench. Individual wrenches sold separately.



68400

9-Piece Combination Wrench Set - SAE

Cat. No.	Set Contains	Weight	
68402		2.1 lbs. (0.95 kg)	
Cat. No.	Size	Length	Box End Point
68410	1/4"	5-1/8" (130.2 mm)	12
68411	5/16"	4-3/8" (111.1 mm)	12
68412	3/8"	6-1/8" (155.6 mm)	12
68413	7/16"	6-5/8" (168.3 mm)	12
68414	1/2"	7-1/8" (181.0 mm)	12
68415	9/16"	7-1/2" (190.5 mm)	12
68416	5/8"	8-1/2" (215.9 mm)	12
68417	11/16"	9" (228.6 mm)	12
68418	3/4"	9-7/8" (250.8 mm)	12

Includes pouch with marked pockets for each wrench. Individual wrenches sold separately.



68402



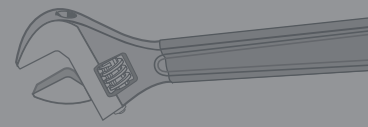

Combination Wrenches

12-Piece Combination Wrench Set - SAE

Cat. No.	Set Contains	Weight
68404		4.1 lbs. (1.86 kg)

Cat. No.	Size	Length	Box End Point
68410	1/4"	5-1/8" (130.2 mm)	12
68411	5/16"	4-3/8" (111.1 mm)	12
68412	3/8"	6-1/8" (155.6 mm)	12
68413	7/16"	6-5/8" (168.3 mm)	12
68414	1/2"	7-1/8" (181.0 mm)	12
68415	9/16"	7-1/2" (190.5 mm)	12
68416	5/8"	8-1/2" (215.9 mm)	12
68417	11/16"	9" (228.6 mm)	12
68418	3/4"	9-7/8" (250.8 mm)	12
68419	13/16"	10-5/8" (269.9 mm)	12
68420	7/8"	11-1/2" (292.1 mm)	12
68421	15/16"	12-1/2" (317.5 mm)	12

Includes pouch with marked pockets for each wrench.
Individual wrenches sold separately.



68404

14-Piece Combination Wrench Set - SAE

Cat. No.	Set Contains	Weight
68406		9.8 lbs. (4.45 kg)

Cat. No.	Size	Length	Box End Point
68412	3/8"	6-1/8" (155.6 mm)	12
68413	7/16"	6-5/8" (168.3 mm)	12
68414	1/2"	7-1/8" (181.0 mm)	12
68415	9/16"	7-1/2" (190.5 mm)	12
68416	5/8"	8-1/2" (215.9 mm)	12
68417	11/16"	9" (228.6 mm)	12
68418	3/4"	9-7/8" (250.8 mm)	12
68419	13/16"	10-5/8" (269.9 mm)	12
68420	7/8"	11-1/2" (292.1 mm)	12
68421	15/16"	12-1/2" (317.5 mm)	12
68422	1"	13-1/4" (336.6 mm)	12
68423	1-1/16"	14-1/4" (362.0 mm)	12
68424	1-1/8"	15-1/2" (393.7 mm)	12
68425	1-1/4"	16-1/4" (412.8 mm)	12

Includes pouch with marked pockets for each wrench.
Individual wrenches sold separately.



68406

Combination Wrenches - SAE

Cat. No.	Size	Length	Box End Point	Weight
68421	15/16"	12-1/2" (317.5 mm)	12	12.6 oz. (357 g)
68418	3/4"	9-7/8" (250.8 mm)	12	7.4 oz. (210 g)
68412	3/8"	6-1/8" (155.6 mm)	12	1.6 oz. (45 g)
68410	1/4"	5-1/8" (130.2 mm)	12	0.8 oz. (23 g)
68415	9/16"	7-1/2" (190.5 mm)	12	3.7 oz. (107 g)
68420	7/8"	11-1/2" (292.1 mm)	12	10.7 oz. (303 g)
68413	7/16"	6-5/8" (168.3 mm)	12	2.2 oz. (62 g)
68411	5/16"	4-3/8" (111.1 mm)	12	0.8 oz. (23 g)

Cat. No.	Size	Length	Box End Point	Weight
68423	1-1/16"	14-1/4" (362.0 mm)	12	1.2 lbs. (0.54 kg)
68414	1/2"	7-1/8" (181.0 mm)	12	2.9 oz. (82 g)
68422	1"	13-1/4" (336.6 mm)	12	14.9 oz. (422 g)
68417	11/16"	9" (228.6 mm)	12	5.9 oz. (167 g)
68425	1-1/4"	16-1/4" (412.8 mm)	12	1.9 lbs. (0.86 kg)
68419	13/16"	10-5/8" (269.9 mm)	12	8.5 oz. (241 g)
68416	5/8"	8-1/2" (215.9 mm)	12	4.5 oz. (128 g)
68424	1-1/8"	15-1/2" (393.7 mm)	12	1.5 lbs. (0.68 kg)



68417

See page 310 for additional information on warnings.



Combination Wrenches

7-Piece Combination Wrench Set - Metric

Cat. No.	Set Contains	Weight	
68500		1.2 lbs. (0.54 kg)	
Cat. No.	Size	Length	Box End Point
68507	7 mm	5-1/8" (130.2 mm)	12
68509	9 mm	6-1/8" (155.6 mm)	12
68510	10 mm	6-1/2" (165.1 mm)	12
68511	11 mm	6-1/2" (165.1 mm)	12
68513	13 mm	7-1/8" (181.0 mm)	12
68514	14 mm	7-1/2" (190.5 mm)	12
68515	15 mm	7-1/2" (190.5 mm)	12

Includes pouch with marked pockets for each wrench.
Individual wrenches sold separately.



68500

11-Piece Combination Wrench Set - Metric

Cat. No.	Set Contains	Weight	
68502		2.4 lbs. (1.09 kg)	
Cat. No.	Size	Length	Box End Point
68507	7 mm	5-1/8" (130.2 mm)	12
68508	8 mm	5-3/8" (136.5 mm)	12
68509	9 mm	6-1/8" (155.6 mm)	12
68510	10 mm	6-1/2" (165.1 mm)	12
68511	11 mm	6-1/2" (165.1 mm)	12
68512	12 mm	7-1/8" (181.0 mm)	12
68513	13 mm	7-1/8" (181.0 mm)	12
68514	14 mm	7-1/2" (190.5 mm)	12
68515	15 mm	7-1/2" (190.5 mm)	12
68517	17 mm	9" (228.6 mm)	12
68519	19 mm	9-3/4" (247.7 mm)	12

Includes pouch with marked pockets for each wrench.
Individual wrenches sold separately.



68502

Combination Wrenches - Metric

Cat. No.	Size	Length	Box End Point	Weight
68507	7 mm	5-1/8" (130.2 mm)	12	0.8 oz. (23 g)
68508	8 mm	5-3/8" (136.5 mm)	12	1.3 oz. (37 g)
68509	9 mm	6-1/8" (155.6 mm)	12	1.6 oz. (45 g)
68510	10 mm	6-1/2" (165.1 mm)	12	2.1 oz. (60 g)
68511	11 mm	6-1/2" (165.1 mm)	12	2.1 oz. (60 g)
68512	12 mm	7-1/8" (181.0 mm)	12	2.9 oz. (82 g)
68513	13 mm	7-1/8" (181.0 mm)	12	2.6 oz. (74 g)
68514	14 mm	7-1/2" (190.5 mm)	12	3.5 oz. (99 g)
68515	15 mm	7-1/2" (190.5 mm)	12	3.5 oz. (99 g)
68517	17 mm	9" (228.6 mm)	12	6.2 oz. (176 g)
68519	19 mm	9-3/4" (247.7 mm)	12	6.7 oz. (190 g)



68512



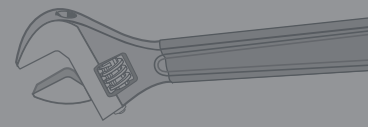

Open-End Wrenches

Corrosion resistant

Forged from the highest quality alloy steel

Different size opening on each end of wrench

Ends are offset at 15° angle for clearance over obstructions

Durable chrome-plated finish



5-Piece Open-End Wrench Set - SAE

Cat. No.	Set Contains	Weight	
68450		1.1 lbs. (0.50 kg)	
Cat. No.	Small Size	Large Size	Length
68460	1/4"	5/16"	4-3/4" (120.7 mm)
68461	3/8"	7/16"	6" (152.4 mm)
68462	1/2"	9/16"	7" (177.8 mm)
68463	9/16"	5/8"	7-1/2" (190.5 mm)
68464	11/16"	3/4"	9" (228.6 mm)

Includes pouch with marked pockets for each wrench.
Individual wrenches sold separately.



68450

7-Piece Open-End Wrench Set - SAE

Cat. No.	Set Contains	Weight	
68452		2.5 lbs. (1.13 kg)	
Cat. No.	Small Size	Large Size	Length
68460	1/4"	5/16"	4-3/4" (120.7 mm)
68461	3/8"	7/16"	6" (152.4 mm)
68462	1/2"	9/16"	7" (177.8 mm)
68463	9/16"	5/8"	7-1/2" (190.5 mm)
68464	11/16"	3/4"	9" (228.6 mm)
68465	13/16"	7/8"	10" (254.0 mm)
68466	15/16"	1"	11" (279.4 mm)

Includes pouch with marked pockets for each wrench.
Individual wrenches sold separately.



68452

Open-End Wrenches - SAE

Cat. No.	Small Size	Large Size	Length	Weight
68460	1/4"	5/16"	4-3/4" (120.7 mm)	0.6 oz. (17 g)
68461	3/8"	7/16"	6" (152.4 mm)	1.6 oz. (45 g)
68462	1/2"	9/16"	7" (177.8 mm)	2.7 oz. (77 g)
68463	9/16"	5/8"	7-1/2" (190.5 mm)	3.2 oz. (91 g)
68464	11/16"	3/4"	9" (228.6 mm)	5.8 oz. (164 g)
68465	13/16"	7/8"	10" (254.0 mm)	8.8 oz. (249 g)
68466	15/16"	1"	11" (279.4 mm)	12.8 oz. (363 g)



68463



Socket Wrench Sets

8-Piece 1/2" Drive Deep-Socket Set



65514

Set consists of the following pieces:

- Eight 12-point deep sockets: 1/2", 9/16", 5/8", 11/16", 3/4", 13/16", 7/8", and 15/16"
- Hinged metal box

Cat. No.	Description	Weight
65514	1/2" Drive Deep Socket Wrench Set, 8 Pc	4.5 lbs. (2.04 kg)

12-Piece 1/2-Inch Drive Socket Wrench Set



65510

Set consists of the following pieces:

- Nine 12-point sockets: 7/16", 1/2", 9/16", 5/8", 11/16", 3/4", 13/16", 7/8", and 15/16"
- One extension: 5" long
- One spark plug socket: 5/8"
- One ratchet
- Hinged metal box

Cat. No.	Description	Weight
65510	1/2" Drive Socket Wrench Set, 12 Pc	5.4 lbs. (2.45 kg)

16-Piece 1/2" Drive Socket Wrench Set



65512

Set consists of the following pieces:

- Thirteen 12-point sockets: 7/16", 1/2", 9/16", 5/8", 11/16", 3/4", 13/16", 7/8", 15/16", 1", 1-1/16", 1-1/8", and 1-1/4"
- One extension: 5" long
- One flex handle: 17" long
- One ratchet
- Hinged metal box

Cat. No.	Description	Weight
65512	1/2" Drive Socket Wrench Set, 16 Pc	9.6 lbs. (4.35 kg)

13-Piece 3/8-Inch Drive Socket Set - Metric



65506

Set consists of the following pieces:

- Thirteen 6-point sockets: 7, 8, 9, 10, 11, 12, 13, 14, 15, 16, 17, 18, and 19 mm
- Handy, flip-lock tray

Cat. No.	Description	Weight
65506	3/8" Drive Socket Set, Metric, 13 Pc	1.3 lbs. (0.59 kg)



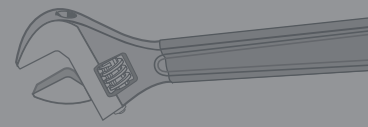

Socket Wrench Sets

8-Piece 3/8" Drive Deep-Socket Set



65502

Set consists of the following pieces:

- Eight 6-point deep sockets: 3/8", 7/16", 1/2", 9/16", 5/8", 11/16", 3/4", and 13/16"
- Hinged metal box

Cat. No.	Description	Weight
65502	3/8" Drive Deep Socket Wrench Set, 8 Pc	2.7 lbs. (1.22 kg)

20-Piece 3/8" Drive Socket Wrench Set



65508

Set consists of the following pieces:

- Four 6-point sockets: 3/8", 7/16", 1/2", and 9/16"
- Five 12-point sockets: 5/8", 11/16", 3/4", 13/16", and 7/8"
- Eight 6-point deep sockets: 3/8", 7/16", 1/2", 9/16", 5/8", 11/16", 3/4", and 13/16"
- Two extensions: 1-3/4" and 3" long
- One ratchet
- Hinged metal box

Cat. No.	Description	Weight
65508	3/8" Drive Socket Wrench Set, 20 Pc	5.4 lbs. (2.45 kg)

12-Piece 3/8" Drive Socket Wrench Set



65504

Set consists of the following pieces:

- Four 6-point sockets: 3/8", 7/16", 1/2", and 9/16"
- Four 12-point sockets: 5/8", 11/16", 3/4", and 13/16"
- One spark plug socket: 5/8"
- Two extensions: 1-3/4" and 6" long
- One ratchet
- Hinged metal box

Cat. No.	Description	Weight
65504	3/8" Drive Socket Wrench Set, 12 Pc	3.6 lbs. (1.63 kg)

13-Piece 1/4" Drive Socket Wrench Set



65500

Set consists of the following pieces:

- Nine 6-point sockets: 3/16", 7/32", 1/4", 9/32", 5/16", 11/32", 3/8", 7/16", and 1/2"
- One spinner handle
- Two extensions: 2" and 6" long
- One ratchet
- Hinged metal box

Cat. No.	Description	Weight
65500	1/4" Drive Socket Wrench Set, 13 Pc	2.1 lbs. (0.95 kg)

See page 310 for additional information on warnings.



Socket Wrenches

1/4-Inch Drivers and Extensions



Cat. No.	Description	Weight
65620	4-3/4" Ratchet	5.1 oz. (145 g)
65621	Spinner Handle	3.0 oz. (86 g)
65622	2" Extension	0.8 oz. (23 g)
65623	6" Extension	2.2 oz. (64 g)

3/8" Drivers and Extensions

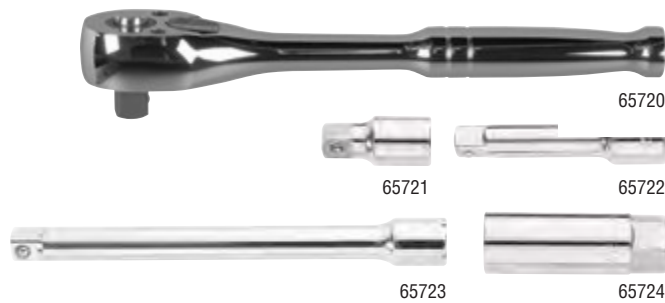

Cat. No.	Description	Weight
65720	7-1/2" Ratchet	11.7 oz. (331 g)
65721	1-1/2" Extension	1.4 oz. (41 g)
65722	3" Extension	2.4 oz. (68 g)
65723	6" Extension 3/8" Socket Size	4.8 oz. (136 g)
65724	5/8" Spark Plug Socket 3/8" Drive	3.4 oz. (96 g)

1/2" Drivers and Extensions

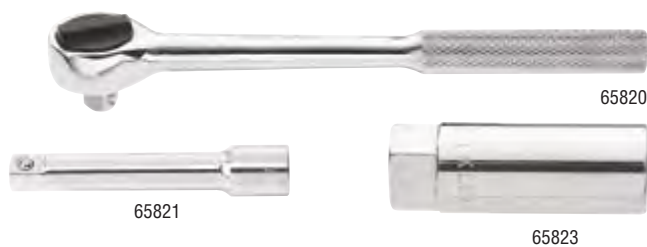

Cat. No.	Description	Weight
65820	10-1/2" Ratchet	1.3 lbs. (0.59 kg)
65821	5" Extension	7.2 oz. (204 g)
65823	5/8" Spark Plug Socket 1/2" Drive	2.9 oz. (82 g)

1/4" Drive Sockets



65604

Cat. No.	Size	Weight
Standard — 6-Point		
65600	3/16"	0.3 oz. (8.5 g)
65601	7/32"	0.3 oz. (8.5 g)
65602	1/4"	0.3 oz. (8.5 g)
65603	9/32"	0.3 oz. (8.5 g)
65604	5/16"	0.3 oz. (8.5 g)
65605	11/32"	0.5 oz. (14 g)
65606	3/8"	0.6 oz. (17 g)
65607	7/16"	0.6 oz. (17 g)
65608	1/2"	0.8 oz. (23 g)

3/8" Drive Sockets



65702

Cat. No.	Size	Weight
Standard — 6-Point		
65700	3/8"	0.8 oz. (23 g)
65701	7/16"	0.8 oz. (23 g)
65702	1/2"	1 oz. (27 g)
65703	9/16"	1 oz. (27 g)
Standard Deep — 6-Point		
65710	3/8"	1.4 oz. (41 g)
65711	7/16"	1.6 oz. (45 g)
65712	1/2"	2.1 oz. (59 g)
65713	9/16"	2.4 oz. (68 g)
65714	5/8"	3.5 oz. (99 g)
65715	11/16"	4.3 oz. (122 g)
65716	3/4"	4.5 oz. (128 g)
65717	13/16"	5.4 oz. (153 g)
Standard — 12-Point		
65704	5/8"	1.3 oz. (37 g)
65705	11/16"	1.8 oz. (50 g)
65706	3/4"	1.9 oz. (54 g)
65707	13/16"	2.4 oz. (68 g)
65708	7/8"	3.0 oz. (86 g)
Metric — 6-Point		
65907	7 mm	0.6 oz. (17 g)
65908	8 mm	0.6 oz. (17 g)
65909	9 mm	0.8 oz. (23 g)
65910	10 mm	0.8 oz. (23 g)
65911	11 mm	0.8 oz. (23 g)
65912	12 mm	1.0 oz. (27 g)
65913	13 mm	1.1 oz. (31 g)
65914	14 mm	1.3 oz. (37 g)
65915	15 mm	1.6 oz. (45 g)
65916	16 mm	1.4 oz. (41 g)
65917	17 mm	1.6 oz. (45 g)
65918	18 mm	1.8 oz. (50 g)
65919	19 mm	2.2 oz. (64 g)



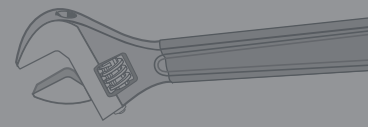

Socket Wrench Sets

1/2" Drive Sockets

Cat. No.	Size	Weight
Standard — 12-Point		
65800	7/16"	1.9 oz. (54 g)
65801	1/2"	1.9 oz. (54 g)
65802	9/16"	1.9 oz. (54 g)
65803	5/8"	1.9 oz. (54 g)
65804	11/16"	2.4 oz. (68 g)
65805	3/4"	3.2 oz. (91 g)
65806	13/16"	3.2 oz. (91 g)
65807	7/8"	3.2 oz. (91 g)
65808	15/16"	4.0 oz. (113 g)
65809	1"	4.8 oz. (136 g)
65810	1-1/16"	5.6 oz. (159 g)
65811	1-1/8"	6.4 oz. (181 g)
65812	1-1/4"	8.0 oz. (227 g)



65800



65829

Cat. No.	Size	Weight
Standard Deep — 12-Point		
65825	1/2"	4.8 oz. (136 g)
65826	9/16"	5.0 oz. (142 g)
65827	5/8"	3.8 oz. (108 g)
65828	11/16"	5.1 oz. (145 g)
65829	3/4"	5.8 oz. (164 g)
65830	13/16"	6.6 oz. (187 g)
65831	7/8"	6.6 oz. (187 g)
65832	15/16"	8.8 oz. (249 g)

Ratcheting Box Wrenches

For use in confined spaces and on long studs

Different size opening on each end



Reverse ratcheting action by simply turning wrench over

7-Piece Ratcheting Box Wrench Set

Additional Features:

- Ratcheting box wrenches in vinyl roll-up pouch
- Wrenches flip over to reverse ratchet

Cat. No.	Set Contains	Weight	
68222		2.7 lbs. (1.22 kg)	
Cat. No.	Point	Size	Length
68200	12	1/4" x 5/16"	4-3/8" (111.1 mm)
68201	12	3/8" x 7/16"	5-1/2" (139.7 mm)
68202	12	1/2" x 9/16"	6-7/8" (174.6 mm)
68203	12	5/8" x 11/16"	8-1/4" (209.6 mm)
68204	12	5/8" x 3/4"	8-1/4" (209.6 mm)
68205	12	11/16" x 3/4"	9-1/4" (235.0 mm)
68206	12	13/16" x 7/8"	9-1/4" (235.0 mm)



68222

See page 310 for additional information on warnings.



Ratcheting Box Wrenches

5-Piece Ratcheting Box Wrench Set

Additional Features:

- Ratcheting box wrenches in vinyl roll-up pouch
- Wrenches flip over to reverse ratchet



68221

Cat. No.	Set Contains	Weight
68221		1.5 lbs. (0.68 kg)

Cat. No.	Point	Size	Length
68200	12	1/4" x 5/16"	4-3/8" (111.1 mm)
68201	12	3/8" x 7/16"	5-1/2" (139.7 mm)
68202	12	1/2" x 9/16"	6-7/8" (174.6 mm)
68203	12	5/8" x 11/16"	8-1/4" (209.6 mm)
68204	12	5/8" x 3/4"	8-1/4" (209.6 mm)

Ratcheting Box Wrenches

Cat. No.	Point	Size	Length	Weight
68200	12	1/4" x 5/16"	4-3/8" (111.1 mm)	2.1 oz. (60 g)
68201	12	3/8" x 7/16"	5-1/2" (139.7 mm)	2.9 oz. (82 g)
68202	12	1/2" x 9/16"	6-7/8" (174.6 mm)	4.6 oz. (130 g)
68203	12	5/8" x 11/16"	8-1/4" (209.6 mm)	6.9 oz. (196 g)
68204	12	5/8" x 3/4"	8-1/4" (209.6 mm)	6.7 oz. (190 g)
68205	12	11/16" x 3/4"	9-1/4" (235.0 mm)	8.3 oz. (235 g)
68206	12	13/16" x 7/8"	9-1/4" (235.0 mm)	11.0 oz. (312 g)



68201

Ratcheting Offset Box Wrenches

5-Piece Fully Reversible Ratcheting Offset Box Wrench Set

- Set of offset reversible ratchet box wrenches in vinyl roll-up pouch

Cat. No.	Set Contains	Weight
68245		1.6 lbs. (0.73 kg)

Cat. No.	Point	Size	Length
68234	6	1/4" x 5/16"	4-3/8" (111.1 mm)
68236	6	3/8" x 7/16"	5-1/2" (139.7 mm)
68238	6	1/2" x 9/16"	6-3/4" (171.5 mm)
68240	12	5/8" x 11/16"	8-1/8" (206.4 mm)
68242	12	3/4" x 7/8"	9-1/8" (231.8 mm)



68245

3-Piece Fully Reversible Ratcheting Offset Box Wrench Set

- Set of offset reversible ratchet box wrenches in vinyl roll-up pouch

Cat. No.	Set Contains	Weight
68244		9.8 oz. (278 g)

Cat. No.	Point	Size	Length
68234	6	1/4" x 5/16"	4-3/8" (111.1 mm)
68236	6	3/8" x 7/16"	5-1/2" (139.7 mm)
68238	6	1/2" x 9/16"	6-3/4" (171.5 mm)



68244



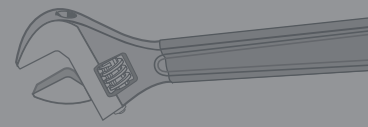

Ratcheting Offset Box Wrenches

Fully Reversible Ratcheting Offset Box Wrenches

- Both ends are offset 25° for more convenient use in confined spaces
- Quick-flip reversing lever for instant ratchet reversal
- Laminated construction for greater strength
- Chrome-plated for rust resistance
- Different size openings at each end



68236

Cat. No.	Point	Size	Length	Weight
68238	6	1/2" x 9/16"	6-3/4" (171.5 mm)	4.8 oz. (136 g)
68236	6	3/8" x 7/16"	5-1/2" (139.7 mm)	2.9 oz. (82 g)
68242	12	3/4" x 7/8"	9-1/8" (231.8 mm)	8.0 oz. (227 g)
68240	12	5/8" x 11/16"	8-1/8" (206.4 mm)	7.4 oz. (210 g)
68234	6	1/4" x 5/16"	4-3/8" (111.1 mm)	2.1 oz. (60 g)

Ratcheting Refrigeration Wrenches

- Fully reversible for refrigeration-packing gland nuts, valve stem sockets and beam-clamp installation
- Compact in size, with clearly marked sockets for four nut sizes
- Quick-flip reversing lever permits instant ratchet reversal
- Ruggedly built with polished chrome finish for smooth edges for comfort



68310

Cat. No.	Socket Size	Length	Weight
68309	3/16" and 1/4" Sq. x 1/2" and 9/16" Hex		6.9 oz. (196 g)
68310	3/16" and 5/16" Sq. x 1/4" and 3/8" Sq.		3.2 oz. (91 g)

Specialty Wrenches

Can Wrench

- Two tools in one saves space in your pouch
- One end opens telephone box fasteners, the other end tightens nuts on binding-post terminals
- The 7/16" socket has a black finish and the 3/8" socket has a silver finish
- Sockets are 1-1/4" (32 mm) deep to fit over long binding posts and are thin-walled for easy access into tight areas
- Socket ends are color-coded for quick identification of socket sizes
- Hex-socket design enables using a wrench to obtain extra torque
- High-impact, break-resistant handle for long and dependable service
- Sockets are heat-treated, alloy steel



68005



Cat. No.	Size	Length	Handle Diameter	Weight
68005	3/8" and 7/16" Hex Nut	7" (177.8 mm)	1" (25.4 mm)	5.6 oz. (159 g)

Lineman's Wrenches

- Forged from special bar steel and heat-treated for long life
- Each end has two different size openings
- Hole is provided at larger end for turning-in standard pole steps
- Wrench is suited for use on heavy three-bolt guy clamps on which clearance is limited
- Small end is painted silver on Cat. No. 3146A
- Cat. No. 3146B features end openings sized to NEMA hardware specifications



3146



3146B

Cat. No.	Application	Large End Opening	Small End Opening	Color	Length	Weight
3146	5/8" (15.9 mm) Hardware	29/32" and 1-3/32"	5/8" and 13/16"	Dark Blue	13" (330.2 mm)	1.9 lbs. (0.86 kg)
3146A	3/4" (19.1 mm) Hardware	1-1/16" and 1-5/16"	5/8" and 7/8"	Dark Blue	13" (330.2 mm)	1.7 lbs. (0.77 kg)
3146B	Bell System Type	1-1/16" and 1-3/16"	11/16" and 7/8"	Silver	13" (330.2 mm)	1.8 lbs. (0.82 kg)



Specialty Wrenches

Lineman's Ratcheting Wrenches

- Bolt-through design allows bolts to pass through the socket
- KT152T features side ridges that provide a better grip and includes 13/16" square socket size
- 3/4" and 1" x 1-1/8" combination square socket sizes for most common utility hardware
- Bright yellow socket for easy visibility
- Works on most common utility pole hardware, such as lag bolts, "C" clamps and suspension bolts
- KT155T and KT155HD also offer two popular 12-point wrench sizes: 9/16" and 3/4"



Cat. No.	Description	Length	Weight
KT151T	Lineman's Ratcheting Wrench	13" (330.2 mm)	2.1 lbs. (0.95 kg)
KT152T	Lineman's Slim Ratcheting Wrench	13-1/4" (336.6 mm)	2.1 lbs. (0.95 kg)
KT155HD	5-in-1 Lineman's Wrench, Heavy Duty	12" (304.8 mm)	2.1 lbs. (0.95 kg)
KT155T	5-in-1 Lineman's Wrench	9-3/8" (238.1 mm)	1.4 lbs. (0.64 kg)

Lineman's Box Wrenches

- Chrome plated finish resists corrosion
- 1/2", 9/16", 5/8" and 3/4" sizes in one tool; 12-point sockets
- Reverse ratcheting action by reversing switches on each end of the wrench
- "See-through" insulating handle confirms metal ends are not connected (Cat. No. KT223X4-INS)
- Textured grooves in handle prevent slipping (Cat. No. KT223X4-INS)
- Solid, one piece design (Cat. No. KT223X4) NOT INSULATED



Cat. No.	Description	Size	Length	Weight
KT223X4	Lineman's Ratcheting 4-in-1 Box Wrench	1/2", 9/16" 5/8", 3/4"	9" (228.6 mm)	11.2 oz. (318 g)
KT223X4-INS	Lineman's Insulating 4-in-1 Box Wrench	1/2", 9/16", 5/8", 3/4"	9" (228.6 mm)	11.2 oz. (318 g)
KT223-INS	Lineman's Insulating Box Wrench	9/16", 3/4"	8-1/4" (209.6 mm)	10.00 lbs. (4.54 kg)

Impact Socket Wrenches and Adapters

- Features three square socket sizes: 3/4", 1", and 1-1/8"
- Fine-tuned ball detent provides improved retention, minimizing drops
- Long hollow shaft allows use on long threaded bolts
- 7/16" hex quick-change adapter included
- Adapters extend or retract head for easy access to the size you need
- Do not exceed 200 ft./lbs. of torque



Cat. No.	Description	Size	Length	Weight
NRHD	3-in-1 Impact Socket Wrench	3/4", 1", 1-1/8"	7-3/4" (196.9 mm)	2.0 lbs. (0.91 kg)
NRHD3	Single Ended Impact Socket Wrench	to 1-1/8" (28.6 mm) Square	10" (254.0 mm)	2.1 lbs. (0.95 kg)
NRHDA	Impact Socket Adapter for NRHD	7/16"	4-29/32" (124.6 mm)	5.8 oz. (164 g)
NRHDA3	Impact Socket Adapter for NRHD3	1/2"	2-15/32" (62.7 mm)	2.9 oz. (82 g)



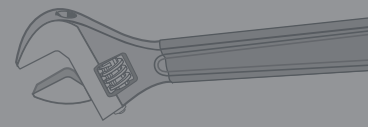

Construction Wrenches

Adjustable-Head Construction Wrenches

- Eliminates the need for carrying several fixed-size wrenches
- Forged from select alloy steel with continuous taper handle for aligning bolt and/or rivet holes
- Industrial black finish for corrosion resistance
- Includes lanyard hole for easy tool tethering



Cat. No.	Max. Size Capacity	Overall Length	Weight
3227	1-5/16" (33.3 mm)	11" (279.4 mm)	1.2 lbs. (0.54 kg)
3239	1-1/2" (38.1 mm)	16" (406.4 mm)	2.4 lbs. (1.09 kg)

1/2"-Drive Ratcheting Construction Wrench

- Accepts 1/2" (12.7 mm) square-drive hex socket
- Reversible ratchet
- Eliminates the need for carrying several fixed-size wrenches
- Forged from select alloy steel with continuous taper handle for aligning bolt and/or rivet holes
- Industrial black finish for corrosion resistance



Cat. No.	Overall Length	Weight
3238	15" (381.0 mm)	2.1 lbs. (0.95 kg)

Erection Wrenches

- Forged from select alloy steel to withstand high-leverage and heavy loads
- Extra-heavy-duty head area gives maximum strength and durability
- Continuous taper of handle makes lining-up bolt holes easy and works on a range of bolt-hole sizes without binding
- Extra-large hub area works on larger diameter holes better than other wrenches
- Catalog number, bolt size and nominal opening size are stamped on every wrench for easy identification
- American Bridge design
- Cat. Nos. 3212TT, 3213TT, and 3214TT feature tether hole for working at height



Cat. No.	Nut Type	Bolt Size	Nominal Opening	Head Width	Taper Diameter	Overall Length	Weight
3210	U.S. Heavy	1/2" (12.7 mm)	7/8" (22.2 mm)	2-1/4" (57.2 mm)	7/8" to 3/16" (22.2 to 4.8 mm)	14-3/4" (374.7 mm)	1.4 lbs. (0.64 kg)
3211	U.S. Heavy	5/8" (15.9 mm)	1-1/16" (27.0 mm)	2-1/4" (57.2 mm)	7/8" to 3/16" (22.2 to 4.8 mm)	14-3/4" (374.7 mm)	1.3 lbs. (0.59 kg)
3212	U.S. Heavy	3/4" (19.1 mm)	1-1/4" (31.8 mm)	2-1/2" (63.5 mm)	1" to 1/4" (25.4 to 6.4 mm)	16-5/8" (422.3 mm)	2.0 lbs. (0.91 kg)
3213	U.S. Heavy	7/8" (22.2 mm)	1-7/16" (36.5 mm)	3" (76.2 mm)	1-1/8" to 9/32" (28.6 to 7.1 mm)	17-3/8" (441.3 mm)	2.7 lbs. (1.22 kg)
3214	U.S. Heavy	1" (25.4 mm)	1-5/8" (41.3 mm)	3-5/8" (92.1 mm)	1-1/8" to 1/4" (28.6 to 6.4 mm)	18" (457.2 mm)	3.4 lbs. (1.54 kg)
3219	U.S. Regular	1/2" (12.7 mm)	3/4" (19.1 mm)	2-1/4" (57.2 mm)	7/8" x 1/2" (22.2 to 12.7 mm)	14-3/4" (374.7 mm)	1.4 lbs. (0.64 kg)
3220	U.S. Regular	1/2" (12.7 mm)	13/16" (20.6 mm)	2-1/4" (57.2 mm)	7/8" to 3/16" (22.2 to 4.8 mm)	14-3/4" (374.7 mm)	1.4 lbs. (0.64 kg)
3221	U.S. Regular	5/8" (15.9 mm)	1" (25.4 mm)	2-1/4" (57.2 mm)	7/8" to 3/16" (22.2 to 4.8 mm)	14-3/4" (374.7 mm)	1.3 lbs. (0.59 kg)
3222	U.S. Regular	3/4" (19.1 mm)	1-1/8" (28.6 mm)	2-1/2" (63.5 mm)	1" to 1/4" (25.4 to 6.4 mm)	16-5/8" (422.3 mm)	2.0 lbs. (0.91 kg)
3223	U.S. Regular	7/8" (22.2 mm)	1-5/16" (33.3 mm)	3" (76.2 mm)	1-1/8" to 9/32" (28.6 to 7.1 mm)	17-3/8" (441.3 mm)	2.9 lbs. (1.32 kg)
3224	U.S. Regular	1" (25.4 mm)	1-1/2" (38.1 mm)	3-5/8" (92.1 mm)	1-1/8" to 1/4" (28.6 to 6.4 mm)	18" (457.2 mm)	3.4 lbs. (1.54 kg)
3231	Utility	5/8" (15.9 mm)	15/16" (23.8 mm)	2-1/4" (57.2 mm)	7/8" to 3/16" (22.2 to 4.8 mm)	14-3/4" (374.7 mm)	1.3 lbs. (0.59 kg)
3232	Utility	3/4" (19.1 mm)	1-1/16" (27.0 mm)	2-1/2" (63.5 mm)	1" to 1/4" (25.4 to 6.4 mm)	16-5/8" (422.3 mm)	2.0 lbs. (0.91 kg)

Erection Wrenches with Tether Hole							
3212TT	NEW! U.S. Heavy	3/4" (19.1 mm)	1-1/4" (31.8 mm)	2-1/2" (63.5 mm)	1" to 1/4" (25.4 to 6.4 mm)	16-5/8" (422.3 mm)	2.0 lbs. (0.91 kg)
3213TT	NEW! U.S. Heavy	7/8" (22.2 mm)	1-7/16" (36.5 mm)	3" (76.2 mm)	1-1/8" to 9/32" (28.6 to 7.1 mm)	17-3/8" (441.3 mm)	2.7 lbs. (1.22 kg)
3214TT	NEW! U.S. Heavy	1" (25.4 mm)	1-5/8" (41.3 mm)	3-5/8" (92.1 mm)	1-1/8" to 1/4" (28.6 to 6.4 mm)	18" (457.2 mm)	3.4 lbs. (1.54 kg)

See page 310 for additional information on warnings.



Strap Wrenches

Grip-It® Strap Wrenches

- Completely adjustable strap wrench
- Works in the tightest quarters
- Urethane-covered, high-strength belting attached to lightweight, I-beam handle
- Cam-action design permits uniform, high-torque application
- Under normal conditions, will not scratch, damage or deform polished pipe and fittings, plastic pipe and fittings, oil and water filters, glass pipe, PVC conduit, or polished shafts
- Also works on alternator belts, flywheels, and propeller assemblies



S12H

Cat. No.	Handle Length	Diameter Capacity O.D.	Weight
S-6H	6" (152.4 mm)	1-1/2" to 5" (38.1 mm to 127.0 mm)	3.2 oz. (91 g)
S-12H	12" (304.8 mm)	1-1/2" to 5" (38.1 mm to 127.0 mm)	12.0 oz. (340 g)
S-18H	18" (457.2 mm)	1-1/8" to 8" (28.6 to 203.2 mm)	2.8 lbs. (1.27 kg)

Torque Wrenches

Micro-Adjustable Torque-Sensing Wrenches with Square-Drive Ratchet Head

- Micro-adjustable for increased accuracy
- Easy to read and adjust with quick release lever
- Stainless steel handle provides improved, more comfortable grip
- N.I.S.T. traceable calibration certificate meeting the ASME standard of ±4%



57005

Cat. No.	Drive Size	Range	Length	Weight
57000	3/8" (9.5 mm)	10 - 100 ft. lb. (13.6 - 135.6 Nm)	14-1/8" (358.8 mm)	2.0 lbs. (0.91 kg)
57005	3/8" (9.5 mm)	30 - 250 in. lb. (40.7 - 338.9 Nm)	10-5/8" (269.9 mm)	1.2 lbs. (0.54 kg)
57010	1/2" (12.7 mm)	30 - 250 ft. lb. (40.7 - 338.9 Nm)	24-1/4" (616.0 mm)	3.7 lbs. (1.68 kg)

Master Electrician's Torque Tool Kit

- Two micrometer-adjustable torque wrenches
- Nine hex-wrench bits
- Two 7/16" hex-wrench extensions
- One 7/16" female hex-wrench adapter coupler
- One hex-to-square adapter for wrenches and one adapter for screwdrivers
- One adjustable torque screwdriver
- Seven screwdriver bits; five slotted, two Phillips
- Hinged metal box
- Additional torque screwdrivers available in screwdriver section

Cat. No.	Description	Weight
57060	Master Electrician's Torque Kit 25 Pc	9.6 lbs. (4.35 kg)



57060

Wrenches

Klein's line of wrenches are forged from the finest steel and are designed to deliver great strength and long working life. Regardless of the job type, Klein has a wrench that will help the professional complete the task at hand.



For Professionals...
Since 1857™

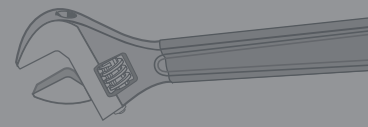

Adjustable Wrenches

Precision-machined jaws are individually chosen and assembled by hand for smooth operation

Chrome-plated for corrosion resistance

Standard and metric scales for faster adjustment

Knurl turns smoothly for easy operation

Contoured handles for comfortable use

Rail is ground for precision fit

Minimally protruding jaw shank for greater capacity in tight spaces

4-threaded knurl worm gear for improved balance



Adjustable Wrenches - High Capacity

Additional Features:

- Extra capacity allows use of a smaller size wrench to handle bigger jobs, especially in confined spaces
- Forged heat-treated alloy steel for maximum strength and light weight



D507-8

Cat. No.	Handle Finish	Handle Color	Length	Capacity	Weight
507-6	High-Polish Chrome	Chrome	6-3/8" (161.9 mm)	15/16" (23.8 mm)	4.6 oz. (130 g)
507-8	High-Polish Chrome	Chrome	8-1/8" (206.4 mm)	1-1/8" (28.6 mm)	9.8 oz. (278 g)
507-10	High-Polish Chrome	Chrome	10-1/8" (257.2 mm)	1-5/16" (33.3 mm)	15.7 oz. (445 g)
507-12	High-Polish Chrome	Chrome	12-1/4" (311.2 mm)	1-1/2" (38.1 mm)	26.4 oz. (748 g)
D507-6	Plastic-Dipped	Transparent Red	6-1/2" (165.1 mm)	15/16" (23.8 mm)	5.3 oz. (150 g)
D507-8	Plastic-Dipped	Transparent Red	8-1/4" (209.6 mm)	1-1/8" (28.6 mm)	10.6 oz. (301 g)
D507-10	Plastic-Dipped	Transparent Red	10-1/4" (260.4 mm)	1-5/16" (33.3 mm)	17.8 oz. (503 g)
D507-12	Plastic-Dipped	Transparent Red	12-3/8" (314.3 mm)	1-1/2" (38.1 mm)	28.8 oz. (816 g)

Adjustable Wrench - Extra-Wide Jaw

Additional Features:

- Extra wide 1-1/2" jaw provides same capacity as a standard 12" adjustable wrench
- Forged heat-treated alloy steel for maximum strength and light weight



D509-8

Cat. No.	Handle Finish	Handle Color	Length	Capacity	Weight
D509-8	Plastic-Dipped	Solid Blue	8-1/2" (215.9 mm)	1-1/2" (38.1 mm)	12.3 oz. (349 g)

Adjustable Wrenches - Standard Capacity

Additional Features:

- Forged heat-treated alloy steel for maximum strength and light weight



506-15

Cat. No.	Handle Finish	Handle Color	Length	Capacity	Weight
D506-4	Plastic-Dipped	Transparent Red	4-1/2" (114.3 mm)	1/2" (12.7 mm)	2.1 oz. (60 g)
506-15	High-Polish Chrome	Chrome	15-7/8" (403.2 mm)	1-11/16" (42.9 mm)	2.9 lbs. (1.32 kg)
500-18	High-Polish Chrome	Chrome	18-1/4" (463.6 mm)	2-1/16" (52.4 mm)	4.7 lbs. (2.13 kg)
500-24	High-Polish Chrome	Chrome	24" (609.6 mm)	2-1/2" (63.5 mm)	7.8 lbs. (3.54 kg)

See page 310 for additional information on warnings.



Combination Wrenches

Corrosion resistant

Forged from the highest quality alloy steel

Durable chrome-plated finish

Open ends are offset at standard 15° angle for confined working areas

Combination wrenches have the same size opening on each end

Box ends have 15° angle offset to provide clearance over obstructions



7-Piece Combination Wrench Set - SAE

Cat. No.	Set Contains	Weight
68400		1.2 lbs. (0.54 kg)

Cat. No.	Size	Length	Box End Point
68410	1/4"	5-1/8" (130.2 mm)	12
68411	5/16"	4-3/8" (111.1 mm)	12
68412	3/8"	6-1/8" (155.6 mm)	12
68413	7/16"	6-5/8" (168.3 mm)	12
68414	1/2"	7-1/8" (181.0 mm)	12
68415	9/16"	7-1/2" (190.5 mm)	12
68416	5/8"	8-1/2" (215.9 mm)	12

Includes pouch with marked pockets for each wrench. Individual wrenches sold separately.



68400

9-Piece Combination Wrench Set - SAE

Cat. No.	Set Contains	Weight
68402		2.1 lbs. (0.95 kg)

Cat. No.	Size	Length	Box End Point
68410	1/4"	5-1/8" (130.2 mm)	12
68411	5/16"	4-3/8" (111.1 mm)	12
68412	3/8"	6-1/8" (155.6 mm)	12
68413	7/16"	6-5/8" (168.3 mm)	12
68414	1/2"	7-1/8" (181.0 mm)	12
68415	9/16"	7-1/2" (190.5 mm)	12
68416	5/8"	8-1/2" (215.9 mm)	12
68417	11/16"	9" (228.6 mm)	12
68418	3/4"	9-7/8" (250.8 mm)	12

Includes pouch with marked pockets for each wrench. Individual wrenches sold separately.



68402



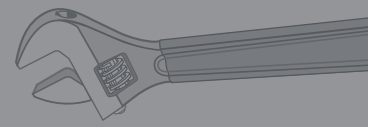

Combination Wrenches

12-Piece Combination Wrench Set - SAE

Cat. No.	Set Contains	Weight
68404		4.1 lbs. (1.86 kg)

Cat. No.	Size	Length	Box End Point
68410	1/4"	5-1/8" (130.2 mm)	12
68411	5/16"	4-3/8" (111.1 mm)	12
68412	3/8"	6-1/8" (155.6 mm)	12
68413	7/16"	6-5/8" (168.3 mm)	12
68414	1/2"	7-1/8" (181.0 mm)	12
68415	9/16"	7-1/2" (190.5 mm)	12
68416	5/8"	8-1/2" (215.9 mm)	12
68417	11/16"	9" (228.6 mm)	12
68418	3/4"	9-7/8" (250.8 mm)	12
68419	13/16"	10-5/8" (269.9 mm)	12
68420	7/8"	11-1/2" (292.1 mm)	12
68421	15/16"	12-1/2" (317.5 mm)	12

Includes pouch with marked pockets for each wrench.
Individual wrenches sold separately.



68404

14-Piece Combination Wrench Set - SAE

Cat. No.	Set Contains	Weight
68406		9.8 lbs. (4.45 kg)

Cat. No.	Size	Length	Box End Point
68412	3/8"	6-1/8" (155.6 mm)	12
68413	7/16"	6-5/8" (168.3 mm)	12
68414	1/2"	7-1/8" (181.0 mm)	12
68415	9/16"	7-1/2" (190.5 mm)	12
68416	5/8"	8-1/2" (215.9 mm)	12
68417	11/16"	9" (228.6 mm)	12
68418	3/4"	9-7/8" (250.8 mm)	12
68419	13/16"	10-5/8" (269.9 mm)	12
68420	7/8"	11-1/2" (292.1 mm)	12
68421	15/16"	12-1/2" (317.5 mm)	12
68422	1"	13-1/4" (336.6 mm)	12
68423	1-1/16"	14-1/4" (362.0 mm)	12
68424	1-1/8"	15-1/2" (393.7 mm)	12
68425	1-1/4"	16-1/4" (412.8 mm)	12

Includes pouch with marked pockets for each wrench.
Individual wrenches sold separately.



68406

Combination Wrenches - SAE

Cat. No.	Size	Length	Box End Point	Weight
68421	15/16"	12-1/2" (317.5 mm)	12	12.6 oz. (357 g)
68418	3/4"	9-7/8" (250.8 mm)	12	7.4 oz. (210 g)
68412	3/8"	6-1/8" (155.6 mm)	12	1.6 oz. (45 g)
68410	1/4"	5-1/8" (130.2 mm)	12	0.8 oz. (23 g)
68415	9/16"	7-1/2" (190.5 mm)	12	3.7 oz. (107 g)
68420	7/8"	11-1/2" (292.1 mm)	12	10.7 oz. (303 g)
68413	7/16"	6-5/8" (168.3 mm)	12	2.2 oz. (62 g)
68411	5/16"	4-3/8" (111.1 mm)	12	0.8 oz. (23 g)

Cat. No.	Size	Length	Box End Point	Weight
68423	1-1/16"	14-1/4" (362.0 mm)	12	1.2 lbs. (0.54 kg)
68414	1/2"	7-1/8" (181.0 mm)	12	2.9 oz. (82 g)
68422	1"	13-1/4" (336.6 mm)	12	14.9 oz. (422 g)
68417	11/16"	9" (228.6 mm)	12	5.9 oz. (167 g)
68425	1-1/4"	16-1/4" (412.8 mm)	12	1.9 lbs. (0.86 kg)
68419	13/16"	10-5/8" (269.9 mm)	12	8.5 oz. (241 g)
68416	5/8"	8-1/2" (215.9 mm)	12	4.5 oz. (128 g)
68424	1-1/8"	15-1/2" (393.7 mm)	12	1.5 lbs. (0.68 kg)



68417

See page 310 for additional information on warnings.



Combination Wrenches

7-Piece Combination Wrench Set - Metric

Cat. No.	Set Contains	Weight	
68500		1.2 lbs. (0.54 kg)	
Cat. No.	Size	Length	Box End Point
68507	7 mm	5-1/8" (130.2 mm)	12
68509	9 mm	6-1/8" (155.6 mm)	12
68510	10 mm	6-1/2" (165.1 mm)	12
68511	11 mm	6-1/2" (165.1 mm)	12
68513	13 mm	7-1/8" (181.0 mm)	12
68514	14 mm	7-1/2" (190.5 mm)	12
68515	15 mm	7-1/2" (190.5 mm)	12

Includes pouch with marked pockets for each wrench.
Individual wrenches sold separately.



68500

11-Piece Combination Wrench Set - Metric

Cat. No.	Set Contains	Weight	
68502		2.4 lbs. (1.09 kg)	
Cat. No.	Size	Length	Box End Point
68507	7 mm	5-1/8" (130.2 mm)	12
68508	8 mm	5-3/8" (136.5 mm)	12
68509	9 mm	6-1/8" (155.6 mm)	12
68510	10 mm	6-1/2" (165.1 mm)	12
68511	11 mm	6-1/2" (165.1 mm)	12
68512	12 mm	7-1/8" (181.0 mm)	12
68513	13 mm	7-1/8" (181.0 mm)	12
68514	14 mm	7-1/2" (190.5 mm)	12
68515	15 mm	7-1/2" (190.5 mm)	12
68517	17 mm	9" (228.6 mm)	12
68519	19 mm	9-3/4" (247.7 mm)	12

Includes pouch with marked pockets for each wrench.
Individual wrenches sold separately.



68502

Combination Wrenches - Metric

Cat. No.	Size	Length	Box End Point	Weight
68507	7 mm	5-1/8" (130.2 mm)	12	0.8 oz. (23 g)
68508	8 mm	5-3/8" (136.5 mm)	12	1.3 oz. (37 g)
68509	9 mm	6-1/8" (155.6 mm)	12	1.6 oz. (45 g)
68510	10 mm	6-1/2" (165.1 mm)	12	2.1 oz. (60 g)
68511	11 mm	6-1/2" (165.1 mm)	12	2.1 oz. (60 g)
68512	12 mm	7-1/8" (181.0 mm)	12	2.9 oz. (82 g)
68513	13 mm	7-1/8" (181.0 mm)	12	2.6 oz. (74 g)
68514	14 mm	7-1/2" (190.5 mm)	12	3.5 oz. (99 g)
68515	15 mm	7-1/2" (190.5 mm)	12	3.5 oz. (99 g)
68517	17 mm	9" (228.6 mm)	12	6.2 oz. (176 g)
68519	19 mm	9-3/4" (247.7 mm)	12	6.7 oz. (190 g)



68512



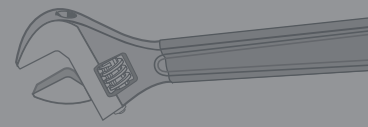

Open-End Wrenches

Corrosion resistant

Forged from the highest quality alloy steel

Different size opening on each end of wrench

Ends are offset at 15° angle for clearance over obstructions

Durable chrome-plated finish

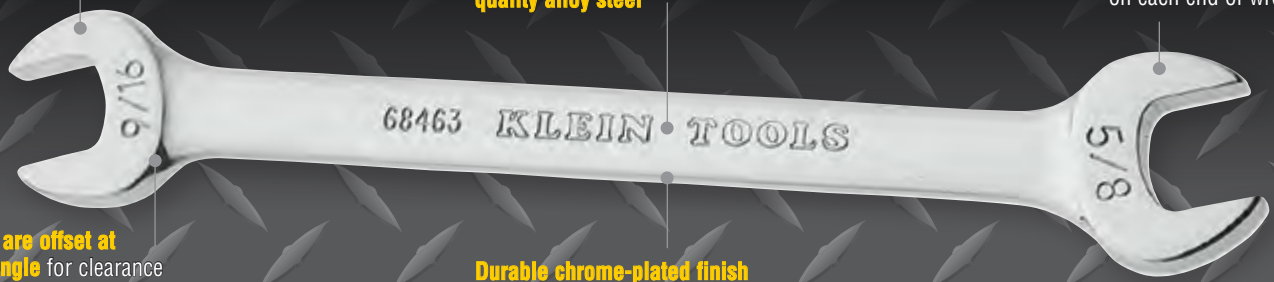

5-Piece Open-End Wrench Set - SAE

Cat. No.	Set Contains	Weight	
68450		1.1 lbs. (0.50 kg)	
Cat. No.	Small Size	Large Size	Length
68460	1/4"	5/16"	4-3/4" (120.7 mm)
68461	3/8"	7/16"	6" (152.4 mm)
68462	1/2"	9/16"	7" (177.8 mm)
68463	9/16"	5/8"	7-1/2" (190.5 mm)
68464	11/16"	3/4"	9" (228.6 mm)

Includes pouch with marked pockets for each wrench.
Individual wrenches sold separately.



68450

7-Piece Open-End Wrench Set - SAE

Cat. No.	Set Contains	Weight	
68452		2.5 lbs. (1.13 kg)	
Cat. No.	Small Size	Large Size	Length
68460	1/4"	5/16"	4-3/4" (120.7 mm)
68461	3/8"	7/16"	6" (152.4 mm)
68462	1/2"	9/16"	7" (177.8 mm)
68463	9/16"	5/8"	7-1/2" (190.5 mm)
68464	11/16"	3/4"	9" (228.6 mm)
68465	13/16"	7/8"	10" (254.0 mm)
68466	15/16"	1"	11" (279.4 mm)

Includes pouch with marked pockets for each wrench.
Individual wrenches sold separately.



68452

Open-End Wrenches - SAE

Cat. No.	Small Size	Large Size	Length	Weight
68460	1/4"	5/16"	4-3/4" (120.7 mm)	0.6 oz. (17 g)
68461	3/8"	7/16"	6" (152.4 mm)	1.6 oz. (45 g)
68462	1/2"	9/16"	7" (177.8 mm)	2.7 oz. (77 g)
68463	9/16"	5/8"	7-1/2" (190.5 mm)	3.2 oz. (91 g)
68464	11/16"	3/4"	9" (228.6 mm)	5.8 oz. (164 g)
68465	13/16"	7/8"	10" (254.0 mm)	8.8 oz. (249 g)
68466	15/16"	1"	11" (279.4 mm)	12.8 oz. (363 g)



68463



Socket Wrench Sets

8-Piece 1/2" Drive Deep-Socket Set



65514

Set consists of the following pieces:

- Eight 12-point deep sockets: 1/2", 9/16", 5/8", 11/16", 3/4", 13/16", 7/8", and 15/16"
- Hinged metal box

Cat. No.	Description	Weight
65514	1/2" Drive Deep Socket Wrench Set, 8 Pc	4.5 lbs. (2.04 kg)

12-Piece 1/2-Inch Drive Socket Wrench Set



65510

Set consists of the following pieces:

- Nine 12-point sockets: 7/16", 1/2", 9/16", 5/8", 11/16", 3/4", 13/16", 7/8", and 15/16"
- One extension: 5" long
- One spark plug socket: 5/8"
- One ratchet
- Hinged metal box

Cat. No.	Description	Weight
65510	1/2" Drive Socket Wrench Set, 12 Pc	5.4 lbs. (2.45 kg)

16-Piece 1/2" Drive Socket Wrench Set



65512

Set consists of the following pieces:

- Thirteen 12-point sockets: 7/16", 1/2", 9/16", 5/8", 11/16", 3/4", 13/16", 7/8", 15/16", 1", 1-1/16", 1-1/8", and 1-1/4"
- One extension: 5" long
- One flex handle: 17" long
- One ratchet
- Hinged metal box

Cat. No.	Description	Weight
65512	1/2" Drive Socket Wrench Set, 16 Pc	9.6 lbs. (4.35 kg)

13-Piece 3/8-Inch Drive Socket Set - Metric



65506

Set consists of the following pieces:

- Thirteen 6-point sockets: 7, 8, 9, 10, 11, 12, 13, 14, 15, 16, 17, 18, and 19 mm
- Handy, flip-lock tray

Cat. No.	Description	Weight
65506	3/8" Drive Socket Set, Metric, 13 Pc	1.3 lbs. (0.59 kg)



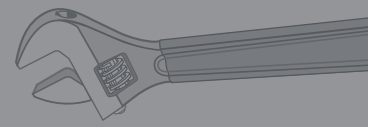

Socket Wrench Sets

8-Piece 3/8" Drive Deep-Socket Set



65502

Set consists of the following pieces:

- Eight 6-point deep sockets: 3/8", 7/16", 1/2", 9/16", 5/8", 11/16", 3/4", and 13/16"
- Hinged metal box

Cat. No.	Description	Weight
65502	3/8" Drive Deep Socket Wrench Set, 8 Pc	2.7 lbs. (1.22 kg)

20-Piece 3/8" Drive Socket Wrench Set



65508

Set consists of the following pieces:

- Four 6-point sockets: 3/8", 7/16", 1/2", and 9/16"
- Five 12-point sockets: 5/8", 11/16", 3/4", 13/16", and 7/8"
- Eight 6-point deep sockets: 3/8", 7/16", 1/2", 9/16", 5/8", 11/16", 3/4", and 13/16"
- Two extensions: 1-3/4" and 3" long
- One ratchet
- Hinged metal box

Cat. No.	Description	Weight
65508	3/8" Drive Socket Wrench Set, 20 Pc	5.4 lbs. (2.45 kg)

12-Piece 3/8" Drive Socket Wrench Set



65504

Set consists of the following pieces:

- Four 6-point sockets: 3/8", 7/16", 1/2", and 9/16"
- Four 12-point sockets: 5/8", 11/16", 3/4", and 13/16"
- One spark plug socket: 5/8"
- Two extensions: 1-3/4" and 6" long
- One ratchet
- Hinged metal box

Cat. No.	Description	Weight
65504	3/8" Drive Socket Wrench Set, 12 Pc	3.6 lbs. (1.63 kg)

13-Piece 1/4" Drive Socket Wrench Set



65500

Set consists of the following pieces:

- Nine 6-point sockets: 3/16", 7/32", 1/4", 9/32", 5/16", 11/32", 3/8", 7/16", and 1/2"
- One spinner handle
- Two extensions: 2" and 6" long
- One ratchet
- Hinged metal box

Cat. No.	Description	Weight
65500	1/4" Drive Socket Wrench Set, 13 Pc	2.1 lbs. (0.95 kg)

See page 310 for additional information on warnings.



Socket Wrenches

1/4-Inch Drivers and Extensions



Cat. No.	Description	Weight
65620	4-3/4" Ratchet	5.1 oz. (145 g)
65621	Spinner Handle	3.0 oz. (86 g)
65622	2" Extension	0.8 oz. (23 g)
65623	6" Extension	2.2 oz. (64 g)

3/8" Drivers and Extensions

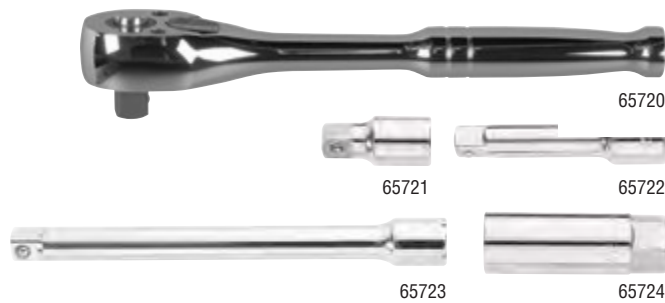

Cat. No.	Description	Weight
65720	7-1/2" Ratchet	11.7 oz. (331 g)
65721	1-1/2" Extension	1.4 oz. (41 g)
65722	3" Extension	2.4 oz. (68 g)
65723	6" Extension 3/8" Socket Size	4.8 oz. (136 g)
65724	5/8" Spark Plug Socket 3/8" Drive	3.4 oz. (96 g)

1/2" Drivers and Extensions

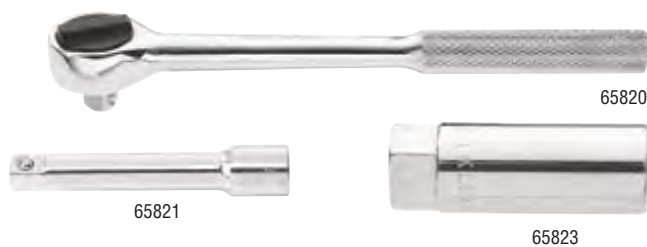

Cat. No.	Description	Weight
65820	10-1/2" Ratchet	1.3 lbs. (0.59 kg)
65821	5" Extension	7.2 oz. (204 g)
65823	5/8" Spark Plug Socket 1/2" Drive	2.9 oz. (82 g)

1/4" Drive Sockets



65604

Cat. No.	Size	Weight
Standard — 6-Point		
65600	3/16"	0.3 oz. (8.5 g)
65601	7/32"	0.3 oz. (8.5 g)
65602	1/4"	0.3 oz. (8.5 g)
65603	9/32"	0.3 oz. (8.5 g)
65604	5/16"	0.3 oz. (8.5 g)
65605	11/32"	0.5 oz. (14 g)
65606	3/8"	0.6 oz. (17 g)
65607	7/16"	0.6 oz. (17 g)
65608	1/2"	0.8 oz. (23 g)

3/8" Drive Sockets



65702

Cat. No.	Size	Weight
Standard — 6-Point		
65700	3/8"	0.8 oz. (23 g)
65701	7/16"	0.8 oz. (23 g)
65702	1/2"	1 oz. (27 g)
65703	9/16"	1 oz. (27 g)
Standard Deep — 6-Point		
65710	3/8"	1.4 oz. (41 g)
65711	7/16"	1.6 oz. (45 g)
65712	1/2"	2.1 oz. (59 g)
65713	9/16"	2.4 oz. (68 g)
65714	5/8"	3.5 oz. (99 g)
65715	11/16"	4.3 oz. (122 g)
65716	3/4"	4.5 oz. (128 g)
65717	13/16"	5.4 oz. (153 g)
Standard — 12-Point		
65704	5/8"	1.3 oz. (37 g)
65705	11/16"	1.8 oz. (50 g)
65706	3/4"	1.9 oz. (54 g)
65707	13/16"	2.4 oz. (68 g)
65708	7/8"	3.0 oz. (86 g)
Metric — 6-Point		
65907	7 mm	0.6 oz. (17 g)
65908	8 mm	0.6 oz. (17 g)
65909	9 mm	0.8 oz. (23 g)
65910	10 mm	0.8 oz. (23 g)
65911	11 mm	0.8 oz. (23 g)
65912	12 mm	1.0 oz. (27 g)
65913	13 mm	1.1 oz. (31 g)
65914	14 mm	1.3 oz. (37 g)
65915	15 mm	1.6 oz. (45 g)
65916	16 mm	1.4 oz. (41 g)
65917	17 mm	1.6 oz. (45 g)
65918	18 mm	1.8 oz. (50 g)
65919	19 mm	2.2 oz. (64 g)



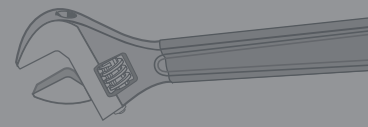

Socket Wrench Sets

1/2" Drive Sockets

Cat. No.	Size	Weight
Standard — 12-Point		
65800	7/16"	1.9 oz. (54 g)
65801	1/2"	1.9 oz. (54 g)
65802	9/16"	1.9 oz. (54 g)
65803	5/8"	1.9 oz. (54 g)
65804	11/16"	2.4 oz. (68 g)
65805	3/4"	3.2 oz. (91 g)
65806	13/16"	3.2 oz. (91 g)
65807	7/8"	3.2 oz. (91 g)
65808	15/16"	4.0 oz. (113 g)
65809	1"	4.8 oz. (136 g)
65810	1-1/16"	5.6 oz. (159 g)
65811	1-1/8"	6.4 oz. (181 g)
65812	1-1/4"	8.0 oz. (227 g)



65800



65829

Cat. No.	Size	Weight
Standard Deep — 12-Point		
65825	1/2"	4.8 oz. (136 g)
65826	9/16"	5.0 oz. (142 g)
65827	5/8"	3.8 oz. (108 g)
65828	11/16"	5.1 oz. (145 g)
65829	3/4"	5.8 oz. (164 g)
65830	13/16"	6.6 oz. (187 g)
65831	7/8"	6.6 oz. (187 g)
65832	15/16"	8.8 oz. (249 g)

Ratcheting Box Wrenches

For use in confined spaces and on long studs

Different size opening on each end

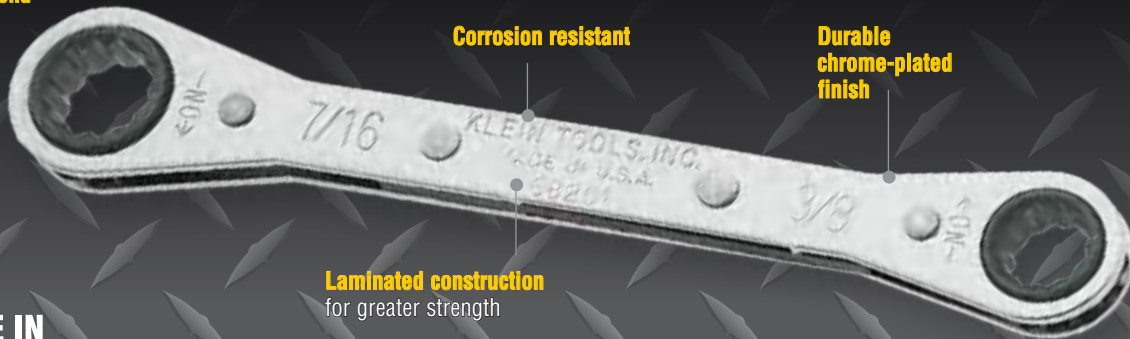

Reverse ratcheting action by simply turning wrench over

7-Piece Ratcheting Box Wrench Set

Additional Features:

- Ratcheting box wrenches in vinyl roll-up pouch
- Wrenches flip over to reverse ratchet

Cat. No.	Set Contains	Weight	
68222		2.7 lbs. (1.22 kg)	
Cat. No.	Point	Size	Length
68200	12	1/4" x 5/16"	4-3/8" (111.1 mm)
68201	12	3/8" x 7/16"	5-1/2" (139.7 mm)
68202	12	1/2" x 9/16"	6-7/8" (174.6 mm)
68203	12	5/8" x 11/16"	8-1/4" (209.6 mm)
68204	12	5/8" x 3/4"	8-1/4" (209.6 mm)
68205	12	11/16" x 3/4"	9-1/4" (235.0 mm)
68206	12	13/16" x 7/8"	9-1/4" (235.0 mm)



68222

See page 310 for additional information on warnings.



Ratcheting Box Wrenches

5-Piece Ratcheting Box Wrench Set

Additional Features:

- Ratcheting box wrenches in vinyl roll-up pouch
- Wrenches flip over to reverse ratchet



68221

Cat. No.	Set Contains	Weight
68221		1.5 lbs. (0.68 kg)

Cat. No.	Point	Size	Length
68200	12	1/4" x 5/16"	4-3/8" (111.1 mm)
68201	12	3/8" x 7/16"	5-1/2" (139.7 mm)
68202	12	1/2" x 9/16"	6-7/8" (174.6 mm)
68203	12	5/8" x 11/16"	8-1/4" (209.6 mm)
68204	12	5/8" x 3/4"	8-1/4" (209.6 mm)

Ratcheting Box Wrenches

Cat. No.	Point	Size	Length	Weight
68200	12	1/4" x 5/16"	4-3/8" (111.1 mm)	2.1 oz. (60 g)
68201	12	3/8" x 7/16"	5-1/2" (139.7 mm)	2.9 oz. (82 g)
68202	12	1/2" x 9/16"	6-7/8" (174.6 mm)	4.6 oz. (130 g)
68203	12	5/8" x 11/16"	8-1/4" (209.6 mm)	6.9 oz. (196 g)
68204	12	5/8" x 3/4"	8-1/4" (209.6 mm)	6.7 oz. (190 g)
68205	12	11/16" x 3/4"	9-1/4" (235.0 mm)	8.3 oz. (235 g)
68206	12	13/16" x 7/8"	9-1/4" (235.0 mm)	11.0 oz. (312 g)



68201

Ratcheting Offset Box Wrenches

5-Piece Fully Reversible Ratcheting Offset Box Wrench Set

- Set of offset reversible ratchet box wrenches in vinyl roll-up pouch

Cat. No.	Set Contains	Weight
68245		1.6 lbs. (0.73 kg)

Cat. No.	Point	Size	Length
68234	6	1/4" x 5/16"	4-3/8" (111.1 mm)
68236	6	3/8" x 7/16"	5-1/2" (139.7 mm)
68238	6	1/2" x 9/16"	6-3/4" (171.5 mm)
68240	12	5/8" x 11/16"	8-1/8" (206.4 mm)
68242	12	3/4" x 7/8"	9-1/8" (231.8 mm)



68245

3-Piece Fully Reversible Ratcheting Offset Box Wrench Set

- Set of offset reversible ratchet box wrenches in vinyl roll-up pouch

Cat. No.	Set Contains	Weight
68244		9.8 oz. (278 g)

Cat. No.	Point	Size	Length
68234	6	1/4" x 5/16"	4-3/8" (111.1 mm)
68236	6	3/8" x 7/16"	5-1/2" (139.7 mm)
68238	6	1/2" x 9/16"	6-3/4" (171.5 mm)



68244



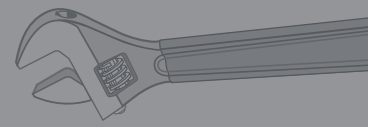

Ratcheting Offset Box Wrenches

Fully Reversible Ratcheting Offset Box Wrenches

- Both ends are offset 25° for more convenient use in confined spaces
- Quick-flip reversing lever for instant ratchet reversal
- Laminated construction for greater strength
- Chrome-plated for rust resistance
- Different size openings at each end



68236

Cat. No.	Point	Size	Length	Weight
68238	6	1/2" x 9/16"	6-3/4" (171.5 mm)	4.8 oz. (136 g)
68236	6	3/8" x 7/16"	5-1/2" (139.7 mm)	2.9 oz. (82 g)
68242	12	3/4" x 7/8"	9-1/8" (231.8 mm)	8.0 oz. (227 g)
68240	12	5/8" x 11/16"	8-1/8" (206.4 mm)	7.4 oz. (210 g)
68234	6	1/4" x 5/16"	4-3/8" (111.1 mm)	2.1 oz. (60 g)

Ratcheting Refrigeration Wrenches

- Fully reversible for refrigeration-packing gland nuts, valve stem sockets and beam-clamp installation
- Compact in size, with clearly marked sockets for four nut sizes
- Quick-flip reversing lever permits instant ratchet reversal
- Ruggedly built with polished chrome finish for smooth edges for comfort



68310

Cat. No.	Socket Size	Length	Weight
68309	3/16" and 1/4" Sq. x 1/2" and 9/16" Hex		6.9 oz. (196 g)
68310	3/16" and 5/16" Sq. x 1/4" and 3/8" Sq.		3.2 oz. (91 g)

Specialty Wrenches

Can Wrench

- Two tools in one saves space in your pouch
- One end opens telephone box fasteners, the other end tightens nuts on binding-post terminals
- The 7/16" socket has a black finish and the 3/8" socket has a silver finish
- Sockets are 1-1/4" (32 mm) deep to fit over long binding posts and are thin-walled for easy access into tight areas
- Socket ends are color-coded for quick identification of socket sizes
- Hex-socket design enables using a wrench to obtain extra torque
- High-impact, break-resistant handle for long and dependable service
- Sockets are heat-treated, alloy steel



68005



Cat. No.	Size	Length	Handle Diameter	Weight
68005	3/8" and 7/16" Hex Nut	7" (177.8 mm)	1" (25.4 mm)	5.6 oz. (159 g)

Lineman's Wrenches

- Forged from special bar steel and heat-treated for long life
- Each end has two different size openings
- Hole is provided at larger end for turning-in standard pole steps
- Wrench is suited for use on heavy three-bolt guy clamps on which clearance is limited
- Small end is painted silver on Cat. No. 3146A
- Cat. No. 3146B features end openings sized to NEMA hardware specifications



3146



3146B

Cat. No.	Application	Large End Opening	Small End Opening	Color	Length	Weight
3146	5/8" (15.9 mm) Hardware	29/32" and 1-3/32"	5/8" and 13/16"	Dark Blue	13" (330.2 mm)	1.9 lbs. (0.86 kg)
3146A	3/4" (19.1 mm) Hardware	1-1/16" and 1-5/16"	5/8" and 7/8"	Dark Blue	13" (330.2 mm)	1.7 lbs. (0.77 kg)
3146B	Bell System Type	1-1/16" and 1-3/16"	11/16" and 7/8"	Silver	13" (330.2 mm)	1.8 lbs. (0.82 kg)



Specialty Wrenches

Lineman's Ratcheting Wrenches

- Bolt-through design allows bolts to pass through the socket
- KT152T features side ridges that provide a better grip and includes 13/16" square socket size
- 3/4" and 1" x 1-1/8" combination square socket sizes for most common utility hardware
- Bright yellow socket for easy visibility
- Works on most common utility pole hardware, such as lag bolts, "C" clamps and suspension bolts
- KT155T and KT155HD also offer two popular 12-point wrench sizes: 9/16" and 3/4"



Cat. No.	Description	Length	Weight
KT151T	Lineman's Ratcheting Wrench	13" (330.2 mm)	2.1 lbs. (0.95 kg)
KT152T	Lineman's Slim Ratcheting Wrench	13-1/4" (336.6 mm)	2.1 lbs. (0.95 kg)
KT155HD	5-in-1 Lineman's Wrench, Heavy Duty	12" (304.8 mm)	2.1 lbs. (0.95 kg)
KT155T	5-in-1 Lineman's Wrench	9-3/8" (238.1 mm)	1.4 lbs. (0.64 kg)

Lineman's Box Wrenches

- Chrome plated finish resists corrosion
- 1/2", 9/16", 5/8" and 3/4" sizes in one tool; 12-point sockets
- Reverse ratcheting action by reversing switches on each end of the wrench
- "See-through" insulating handle confirms metal ends are not connected (Cat. No. KT223X4-INS)
- Textured grooves in handle prevent slipping (Cat. No. KT223X4-INS)
- Solid, one piece design (Cat. No. KT223X4) NOT INSULATED



Cat. No.	Description	Size	Length	Weight
KT223X4	Lineman's Ratcheting 4-in-1 Box Wrench	1/2", 9/16" 5/8", 3/4"	9" (228.6 mm)	11.2 oz. (318 g)
KT223X4-INS	Lineman's Insulating 4-in-1 Box Wrench	1/2", 9/16", 5/8", 3/4"	9" (228.6 mm)	11.2 oz. (318 g)
KT223-INS	Lineman's Insulating Box Wrench	9/16", 3/4"	8-1/4" (209.6 mm)	10.00 lbs. (4.54 kg)

Impact Socket Wrenches and Adapters

- Features three square socket sizes: 3/4", 1", and 1-1/8"
- Fine-tuned ball detent provides improved retention, minimizing drops
- Long hollow shaft allows use on long threaded bolts
- 7/16" hex quick-change adapter included
- Adapters extend or retract head for easy access to the size you need
- Do not exceed 200 ft./lbs. of torque



Cat. No.	Description	Size	Length	Weight
NRHD	3-in-1 Impact Socket Wrench	3/4", 1", 1-1/8"	7-3/4" (196.9 mm)	2.0 lbs. (0.91 kg)
NRHD3	Single Ended Impact Socket Wrench	to 1-1/8" (28.6 mm) Square	10" (254.0 mm)	2.1 lbs. (0.95 kg)
NRHDA	Impact Socket Adapter for NRHD	7/16"	4-29/32" (124.6 mm)	5.8 oz. (164 g)
NRHDA3	Impact Socket Adapter for NRHD3	1/2"	2-15/32" (62.7 mm)	2.9 oz. (82 g)



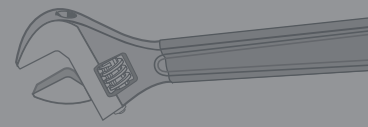

Construction Wrenches

Adjustable-Head Construction Wrenches

- Eliminates the need for carrying several fixed-size wrenches
- Forged from select alloy steel with continuous taper handle for aligning bolt and/or rivet holes
- Industrial black finish for corrosion resistance
- Includes lanyard hole for easy tool tethering



Cat. No.	Max. Size Capacity	Overall Length	Weight
3227	1-5/16" (33.3 mm)	11" (279.4 mm)	1.2 lbs. (0.54 kg)
3239	1-1/2" (38.1 mm)	16" (406.4 mm)	2.4 lbs. (1.09 kg)

1/2"-Drive Ratcheting Construction Wrench

- Accepts 1/2" (12.7 mm) square-drive hex socket
- Reversible ratchet
- Eliminates the need for carrying several fixed-size wrenches
- Forged from select alloy steel with continuous taper handle for aligning bolt and/or rivet holes
- Industrial black finish for corrosion resistance



Cat. No.	Overall Length	Weight
3238	15" (381.0 mm)	2.1 lbs. (0.95 kg)

Erection Wrenches

- Forged from select alloy steel to withstand high-leverage and heavy loads
- Extra-heavy-duty head area gives maximum strength and durability
- Continuous taper of handle makes lining-up bolt holes easy and works on a range of bolt-hole sizes without binding
- Extra-large hub area works on larger diameter holes better than other wrenches
- Catalog number, bolt size and nominal opening size are stamped on every wrench for easy identification
- American Bridge design
- Cat. Nos. 3212TT, 3213TT, and 3214TT feature tether hole for working at height



Cat. No.	Nut Type	Bolt Size	Nominal Opening	Head Width	Taper Diameter	Overall Length	Weight
3210	U.S. Heavy	1/2" (12.7 mm)	7/8" (22.2 mm)	2-1/4" (57.2 mm)	7/8" to 3/16" (22.2 to 4.8 mm)	14-3/4" (374.7 mm)	1.4 lbs. (0.64 kg)
3211	U.S. Heavy	5/8" (15.9 mm)	1-1/16" (27.0 mm)	2-1/4" (57.2 mm)	7/8" to 3/16" (22.2 to 4.8 mm)	14-3/4" (374.7 mm)	1.3 lbs. (0.59 kg)
3212	U.S. Heavy	3/4" (19.1 mm)	1-1/4" (31.8 mm)	2-1/2" (63.5 mm)	1" to 1/4" (25.4 to 6.4 mm)	16-5/8" (422.3 mm)	2.0 lbs. (0.91 kg)
3213	U.S. Heavy	7/8" (22.2 mm)	1-7/16" (36.5 mm)	3" (76.2 mm)	1-1/8" to 9/32" (28.6 to 7.1 mm)	17-3/8" (441.3 mm)	2.7 lbs. (1.22 kg)
3214	U.S. Heavy	1" (25.4 mm)	1-5/8" (41.3 mm)	3-5/8" (92.1 mm)	1-1/8" to 1/4" (28.6 to 6.4 mm)	18" (457.2 mm)	3.4 lbs. (1.54 kg)
3219	U.S. Regular	1/2" (12.7 mm)	3/4" (19.1 mm)	2-1/4" (57.2 mm)	7/8" x 1/2" (22.2 to 12.7 mm)	14-3/4" (374.7 mm)	1.4 lbs. (0.64 kg)
3220	U.S. Regular	1/2" (12.7 mm)	13/16" (20.6 mm)	2-1/4" (57.2 mm)	7/8" to 3/16" (22.2 to 4.8 mm)	14-3/4" (374.7 mm)	1.4 lbs. (0.64 kg)
3221	U.S. Regular	5/8" (15.9 mm)	1" (25.4 mm)	2-1/4" (57.2 mm)	7/8" to 3/16" (22.2 to 4.8 mm)	14-3/4" (374.7 mm)	1.3 lbs. (0.59 kg)
3222	U.S. Regular	3/4" (19.1 mm)	1-1/8" (28.6 mm)	2-1/2" (63.5 mm)	1" to 1/4" (25.4 to 6.4 mm)	16-5/8" (422.3 mm)	2.0 lbs. (0.91 kg)
3223	U.S. Regular	7/8" (22.2 mm)	1-5/16" (33.3 mm)	3" (76.2 mm)	1-1/8" to 9/32" (28.6 to 7.1 mm)	17-3/8" (441.3 mm)	2.9 lbs. (1.32 kg)
3224	U.S. Regular	1" (25.4 mm)	1-1/2" (38.1 mm)	3-5/8" (92.1 mm)	1-1/8" to 1/4" (28.6 to 6.4 mm)	18" (457.2 mm)	3.4 lbs. (1.54 kg)
3231	Utility	5/8" (15.9 mm)	15/16" (23.8 mm)	2-1/4" (57.2 mm)	7/8" to 3/16" (22.2 to 4.8 mm)	14-3/4" (374.7 mm)	1.3 lbs. (0.59 kg)
3232	Utility	3/4" (19.1 mm)	1-1/16" (27.0 mm)	2-1/2" (63.5 mm)	1" to 1/4" (25.4 to 6.4 mm)	16-5/8" (422.3 mm)	2.0 lbs. (0.91 kg)

Erection Wrenches with Tether Hole							
3212TT	NEW! U.S. Heavy	3/4" (19.1 mm)	1-1/4" (31.8 mm)	2-1/2" (63.5 mm)	1" to 1/4" (25.4 to 6.4 mm)	16-5/8" (422.3 mm)	2.0 lbs. (0.91 kg)
3213TT	NEW! U.S. Heavy	7/8" (22.2 mm)	1-7/16" (36.5 mm)	3" (76.2 mm)	1-1/8" to 9/32" (28.6 to 7.1 mm)	17-3/8" (441.3 mm)	2.7 lbs. (1.22 kg)
3214TT	NEW! U.S. Heavy	1" (25.4 mm)	1-5/8" (41.3 mm)	3-5/8" (92.1 mm)	1-1/8" to 1/4" (28.6 to 6.4 mm)	18" (457.2 mm)	3.4 lbs. (1.54 kg)

See page 310 for additional information on warnings.



Strap Wrenches

Grip-It® Strap Wrenches

- Completely adjustable strap wrench
- Works in the tightest quarters
- Urethane-covered, high-strength belting attached to lightweight, I-beam handle
- Cam-action design permits uniform, high-torque application
- Under normal conditions, will not scratch, damage or deform polished pipe and fittings, plastic pipe and fittings, oil and water filters, glass pipe, PVC conduit, or polished shafts
- Also works on alternator belts, flywheels, and propeller assemblies



S12H

Cat. No.	Handle Length	Diameter Capacity O.D.	Weight
S-6H	6" (152.4 mm)	1-1/2" to 5" (38.1 mm to 127.0 mm)	3.2 oz. (91 g)
S-12H	12" (304.8 mm)	1-1/2" to 5" (38.1 mm to 127.0 mm)	12.0 oz. (340 g)
S-18H	18" (457.2 mm)	1-1/8" to 8" (28.6 to 203.2 mm)	2.8 lbs. (1.27 kg)

Torque Wrenches

Micro-Adjustable Torque-Sensing Wrenches with Square-Drive Ratchet Head

- Micro-adjustable for increased accuracy
- Easy to read and adjust with quick release lever
- Stainless steel handle provides improved, more comfortable grip
- N.I.S.T. traceable calibration certificate meeting the ASME standard of ±4%



57005

Cat. No.	Drive Size	Range	Length	Weight
57000	3/8" (9.5 mm)	10 - 100 ft. lb. (13.6 - 135.6 Nm)	14-1/8" (358.8 mm)	2.0 lbs. (0.91 kg)
57005	3/8" (9.5 mm)	30 - 250 in. lb. (40.7 - 338.9 Nm)	10-5/8" (269.9 mm)	1.2 lbs. (0.54 kg)
57010	1/2" (12.7 mm)	30 - 250 ft. lb. (40.7 - 338.9 Nm)	24-1/4" (616.0 mm)	3.7 lbs. (1.68 kg)

Master Electrician's Torque Tool Kit

- Two micrometer-adjustable torque wrenches
- Nine hex-wrench bits
- Two 7/16" hex-wrench extensions
- One 7/16" female hex-wrench adapter coupler
- One hex-to-square adapter for wrenches and one adapter for screwdrivers
- One adjustable torque screwdriver
- Seven screwdriver bits; five slotted, two Phillips
- Hinged metal box
- Additional torque screwdrivers available in screwdriver section

Cat. No.	Description	Weight
57060	Master Electrician's Torque Kit 25 Pc	9.6 lbs. (4.35 kg)



57060