

CI-300, CI-355 360° PIR Sensor



Architecturally appealing low profile appearance

SmartSet automatically selects optimal time delay and sensitivity

Depluggable terminal wiring for quick and easy installation

Accepts low voltage switch input for manual-on operation (CI-300, CI-305)

Line and low voltage models available

Walk-through mode increases savings potential

Specifications

- CI-300, CI-305: 24 VDC/VAC
- CI-355: 120/230/277/347 VAC, 50/60 Hz
- Time delays: SmartSet (automatic), fixed (5, 10, 15, 20, or 30 minutes), walk-through, test-mode
- Sensitivity adjustment: SmartSet (automatic) or reduced sensitivity
- Built-in light level sensor; 10 to 300 fc (107 to 3,229 lux) (CI-300, CI-355)
- Isolated relay with N/O and N/C outputs rated for 1 Amp at 30 VDC/VAC (CI-300)
- Mounting options: ceiling tile; 4 square junction box with double gang mudring (CI-300, CI-305)
- Mounting options: 4 square junction box with double gang mudring; 4 inch octagonal junction box (CI-355)
- Units per power pack: CI-300 up to 5 (B), up to 7 (BZ); CI-305 up to 12 (B), up to 16 (BZ)
- 4.5" diameter x 1.02" (144.3mm x 25.9mm); (83.8mm x 55.9mm) extends approx .36" from ceiling
- UL and CUL listed, 5 year warranty

Applications

- Open offices
- Conference rooms
- Classrooms
- Offices
- Storage rooms
- Computer rooms

Wiring Diagrams

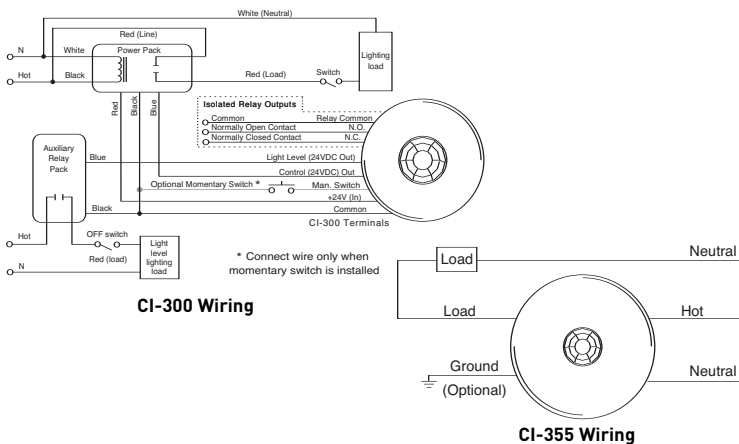

Coverage Patterns

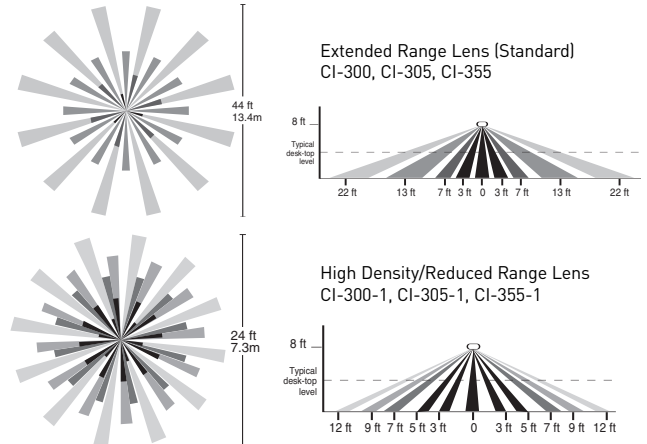

















Order Information

CATALOG #	VOLTAGE	CURRENT/LOAD REQ	COVERAGE
CI-300	24 VDC	20 mA	up to 1200 ft ² (111.5 m ²)
CI-300-1	24 VDC	20 mA	up to 500 ft ² (46.5 m ²)
CI-305	24 VDC	9 mA	up to 1200 ft ² (111.5 m ²)
CI-305-1	24 VDC	9 mA	up to 500 ft ² (46.5 m ²)
CI-355	120 VAC, 50/60 Hz	0-800 W Ballast/Tungsten	up to 1200 ft ² (111.5 m ²)
	230/277 VAC, 50/60 Hz	0-1200 W Ballast	
	347 VAC, 50/60 Hz	0-1500 W Ballast	
CI-355-1	120 VAC, 50/60 Hz	0-800 W Ballast/Tungsten	up to 500 ft ² (46.5 m ²)
	230/277 VAC, 50/60 Hz	0-1200 W Ballast	
	347 VAC, 50/60 Hz	0-1500 W Ballast	

All units are white and low voltage models use Watt Stopper power packs. For line voltage installations requiring an adapter plate, order cat # CA-1.

Product Line Summary

	WS-200	120/277 VAC; 60 Hz	Automatic wall switch	Passive infrared
	WA-200 WA-300	120/277 230/277 VAC, 50/60 Hz 120/277 230/277 VAC, 50/60 Hz	Automatic wall switch -with dual relays	Passive infrared Passive infrared
	WI-200 WI-300	120/277 VAC; 60 Hz 120/277 VAC; 60 Hz	Automatic wall switch -with dual relays	Passive infrared Passive infrared
	WN-100-120 WN-100-277	120 VAC, 60 Hz 277 VAC, 60 Hz	Motion sensor nightlight switch Motion sensor nightlight switch	Passive infrared Passive infrared
	WD Series	120 or 277 VAC; 60 Hz	Dimmable wall switch	Passive infrared
	CN-100 CW-100	120 VAC, 60 Hz 120 VAC, 60 Hz	Residential vacancy sensor Residential vacancy sensor	Passive infrared Passive infrared
	WPIR	24 VDC	Ceiling mount sensor	Passive infrared
	CX Series	24 VDC	Ceiling/wall mount sensor	Passive infrared
	CI-200 Series	24 VDC	Ceiling mount sensor	Passive infrared
	CI-300 Series CI-355 Series	24 VDC 120/230/277/347 VAC; 50/60 Hz	Ceiling mount sensor Ceiling mount sensor	Passive infrared Passive infrared
	CI-12/24	12/24 VDC	Sensor for HVAC, BAS	Passive infrared
	CB-100	24 VDC	Low temperature sensor	Passive infrared
	W Series	24 VDC	Ceiling mount sensor	Ultrasonic
	WT Series	24 VDC	Ceiling mount sensor	Ultrasonic
	UT-300 Series UT-355 Series	24 VDC 120/230/277/347 VAC; 50/60 Hz	Ceiling mount sensor Ceiling mount sensor	Ultrasonic Ultrasonic
	DT-200 Series	24 VDC	Ceiling/wall mount sensor	Dual technology
	DT-300 Series DT-355 Series	24 VDC 120/230/277/347 VAC; 50/60 Hz	Ceiling mount sensor Ceiling mount sensor	Dual technology Dual technology



CI-300, CI-355 360° PIR Sensor



Architecturally appealing low profile appearance

SmartSet automatically selects optimal time delay and sensitivity

Depluggable terminal wiring for quick and easy installation

Accepts low voltage switch input for manual-on operation (CI-300, CI-305)

Line and low voltage models available

Walk-through mode increases savings potential

Specifications

- CI-300, CI-305: 24 VDC/VAC
- CI-355: 120/230/277/347 VAC, 50/60 Hz
- Time delays: SmartSet (automatic), fixed (5, 10, 15, 20, or 30 minutes), walk-through, test-mode
- Sensitivity adjustment: SmartSet (automatic) or reduced sensitivity
- Built-in light level sensor; 10 to 300 fc (107 to 3,229 lux) (CI-300, CI-355)
- Isolated relay with N/O and N/C outputs rated for 1 Amp at 30 VDC/VAC (CI-300)
- Mounting options: ceiling tile; 4 square junction box with double gang mudring (CI-300, CI-305)
- Mounting options: 4 square junction box with double gang mudring; 4 inch octagonal junction box (CI-355)
- Units per power pack: CI-300 up to 5 (B), up to 7 (BZ); CI-305 up to 12 (B), up to 16 (BZ)
- 4.5" diameter x 1.02" (144.3mm x 25.9mm); (83.8mm x 55.9mm) extends approx .36" from ceiling
- UL and CUL listed, 5 year warranty

Applications

- Open offices
- Conference rooms
- Classrooms
- Offices
- Storage rooms
- Computer rooms

Wiring Diagrams

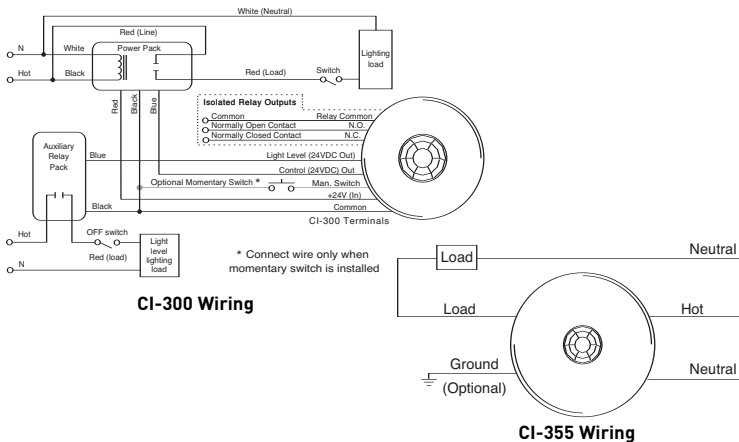

Coverage Patterns

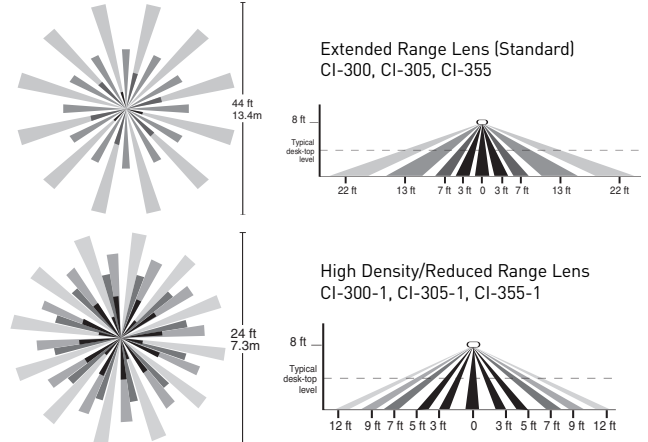

















Order Information

CATALOG #	VOLTAGE	CURRENT/LOAD REQ	COVERAGE
CI-300	24 VDC	20 mA	up to 1200 ft ² (111.5 m ²)
CI-300-1	24 VDC	20 mA	up to 500 ft ² (46.5 m ²)
CI-305	24 VDC	9 mA	up to 1200 ft ² (111.5 m ²)
CI-305-1	24 VDC	9 mA	up to 500 ft ² (46.5 m ²)
CI-355	120 VAC, 50/60 Hz	0-800 W Ballast/Tungsten	up to 1200 ft ² (111.5 m ²)
	230/277 VAC, 50/60 Hz	0-1200 W Ballast	
	347 VAC, 50/60 Hz	0-1500 W Ballast	
CI-355-1	120 VAC, 50/60 Hz	0-800 W Ballast/Tungsten	up to 500 ft ² (46.5 m ²)
	230/277 VAC, 50/60 Hz	0-1200 W Ballast	
	347 VAC, 50/60 Hz	0-1500 W Ballast	

All units are white and low voltage models use Watt Stopper power packs. For line voltage installations requiring an adapter plate, order cat # CA-1.

Product Line Summary

	WS-200	120/277 VAC; 60 Hz	Automatic wall switch	Passive infrared
	WA-200 WA-300	120/277 230/277 VAC, 50/60 Hz 120/277 230/277 VAC, 50/60 Hz	Automatic wall switch -with dual relays	Passive infrared Passive infrared
	WI-200 WI-300	120/277 VAC; 60 Hz 120/277 VAC; 60 Hz	Automatic wall switch -with dual relays	Passive infrared Passive infrared
	WN-100-120 WN-100-277	120 VAC, 60 Hz 277 VAC, 60 Hz	Motion sensor nightlight switch Motion sensor nightlight switch	Passive infrared Passive infrared
	WD Series	120 or 277 VAC; 60 Hz	Dimmable wall switch	Passive infrared
	CN-100 CW-100	120 VAC, 60 Hz 120 VAC, 60 Hz	Residential vacancy sensor Residential vacancy sensor	Passive infrared Passive infrared
	WPIR	24 VDC	Ceiling mount sensor	Passive infrared
	CX Series	24 VDC	Ceiling/wall mount sensor	Passive infrared
	CI-200 Series	24 VDC	Ceiling mount sensor	Passive infrared
	CI-300 Series CI-355 Series	24 VDC 120/230/277/347 VAC; 50/60 Hz	Ceiling mount sensor Ceiling mount sensor	Passive infrared Passive infrared
	CI-12/24	12/24 VDC	Sensor for HVAC, BAS	Passive infrared
	CB-100	24 VDC	Low temperature sensor	Passive infrared
	W Series	24 VDC	Ceiling mount sensor	Ultrasonic
	WT Series	24 VDC	Ceiling mount sensor	Ultrasonic
	UT-300 Series UT-355 Series	24 VDC 120/230/277/347 VAC; 50/60 Hz	Ceiling mount sensor Ceiling mount sensor	Ultrasonic Ultrasonic
	DT-200 Series	24 VDC	Ceiling/wall mount sensor	Dual technology
	DT-300 Series DT-355 Series	24 VDC 120/230/277/347 VAC; 50/60 Hz	Ceiling mount sensor Ceiling mount sensor	Dual technology Dual technology

