

Residential and light commercial distribution products



EATON

Powering Business Worldwide

Contents

Description	Page
Type CPM/CPL plug-in loadcentres	5
Combination (main circuit breaker) single-phase Type 1	6
Combination (main circuit breaker) single-phase Type 3R	7
Combination (main circuit breaker) three-phase Type 1	8
Combination (main circuit breaker) three-phase Type 3R	9
Type CPL plug-in loadcentres	5
Non-combination (main lug only) three-phase Type 1	10
Non-combination (main lug only) single-phase Type 3R	11
Non-combination (main lug only) three-phase Type 1	12
Non-combination (main lug only) three-phase Type 3R	13
Non-combination (main lug only) 70 A single-phase	14
Type CPM/CPL plug-in loadcentre Accessories	15
Plug-in circuit breakers for CPM/CPL	16
Type BR, DNPL, GFTCB, GFEP and GFXB	16
Type BR single- and multi-pole	17
Type DNPL Duplex, Independent Quadplex and circuit breaker packs	18
Type BR arc fault circuit interrupter	19
Types GFCB and GFEP ground fault	20
Types GFCB ground fault and Type BR internationally rated	21
Types GFXB internationally rated ground fault and Type BR moulded case switches	22
Plug-in loadcentre main circuit breakers for CPM/CPL	23
Types CSR and CC	23
Plug-in circuit breaker accessories for CPM/CPL loadcentres	24
Plug-in OEM loadcentre interior assemblies	25
Type CH plug-in loadcentres	29
Combination and non-combination single-phase	30
Plug-in circuit breakers for CH	31
Type CH single-, multi-pole and twin	31
Type CHP commercial	32
Type CHP arc fault circuit interrupter	33
Type CHP ground fault	34
Plug-in loadcentre main circuit breakers for CH	35
Type CSR	35
Plug-in loadcentres and circuit breaker accessories for CH	36
Type CH accessories	36

Contents (continued)

Description	Page
Type CBM bolt-on loadcentres	37
Combination (main circuit breakers) single- and three-phase aluminum bus	37
Combination (main circuit breakers) single- and three-phase copper bus	38
Non-combination (main lug only) single- and three-phase aluminum bus	39
Non-combination (main lug only) single- and three-phase copper bus	40
Bolt-on circuit breakers for CMB/CBL	41
Type BAB and QBHW single- and multi-pole	41
Type QBA arc fault circuit interrupter and DNBA duplex	42
Type QBGF and QBGFEP ground fault	43
Bolt-on loadcentre and circuit breaker accessories	44
Manual transfer switches/generator panels	45
Spa panels	47
Surge suppression products	48
Stage 1 and Stage 1 Type 2	48
Accessories	49
Street lighting panels	50
In-pole	50
On-pole	51
Pedestal	52
Combined loadcentre and meter socket	53
Metered temporary ground fault power panel	54
Mini-power centres	55
Plug-in mini-power centres	56
Plug-in	56
Bolt-on mini-power centres	57
Bolt-on	57
Residential fuse panel inserts	58
Insert interiors	59
Trims	60
Replacement classic circuit breakers	61
Bolt-on Type BQL single-, multi-pole, Duplex and Quadplex	61
Bolt-on Type BQL ground fault and moulded case switches	62
Bolt-on Type QBH single-, multi-pole and accessories	63
Plug-in Type BJ two- and three-pole	64
Pressure switches	65
Index	66

Type CPM/CPL plug-in loadcentres

Product description

Loadcentres feature factory installed main lugs or main breakers. The BR interiors are manufactured of formed, plated aluminum. Eaton also supplies a full line of Eaton brand BR, DNPL, GFCB and GFEP type branch circuit breakers and accessories for these loadcentres.

Product application

Designed for the protection and distribution of single and multi-dwelling residential and light commercial loads to 120/240 volts AC, such as lighting, heating, appliance and small motor branch circuits.

All main breaker combination loadcentres are CSAT listed for use as service entrance equipment.

Ratings

Single-phase, three-wire, 120/240 volts AC and three-phase, four-wire, 120/208 volts AC. Mains through 400 A. Available with up to 84 branch circuits. Main breakers on 150 and 200 A panels are rated at 25,000 AIC.

Metal enclosure specifications

Enclosures are made of 16 gauge sheet steel, either galvanized or epoxy painted. These coatings provide superior corrosion protection. All trims used on BR loadcentres are chromate sealed and finished with an electro-disposition epoxy paint in grey (ANSI-61) or white, which exceeds requirements for outdoor and indoor applications. A combination surface/flush cover with integral door is supplied with indoor loadcentres rated from 100 through 400 A.

All plug-in loadcentres are CSA listed to file LL98266. CSA certified to C22.2 No.29.

Warranty

10 year limited.

Type CPM/CPL loadcentre features and benefits

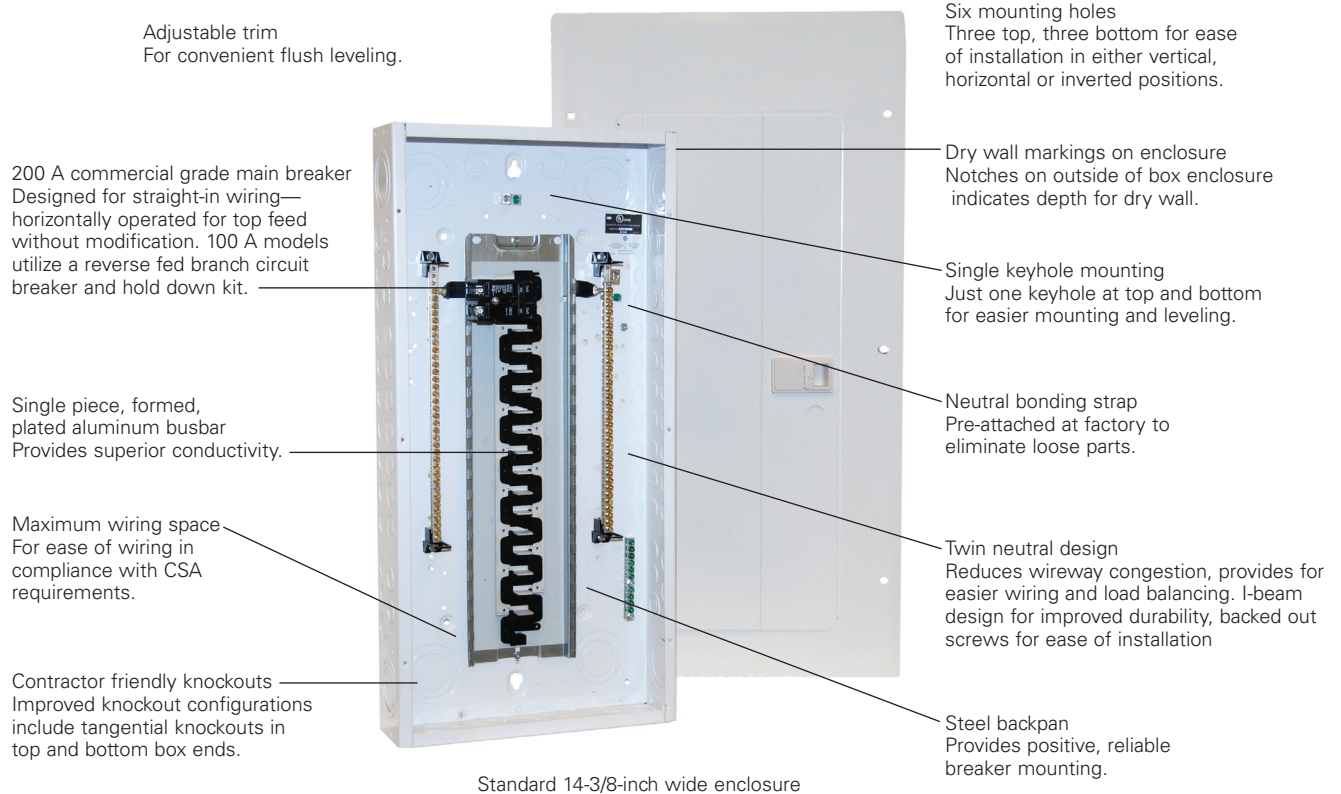

Type CPM plug-in loadcentres

Combination (main circuit breaker) single-phase Type 1

Three-wire, 120/240 Vac combination service entrance Type 1 (indoor)

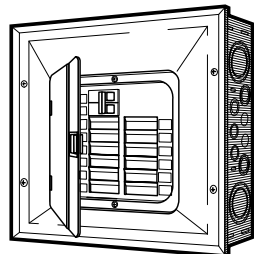

CPM112

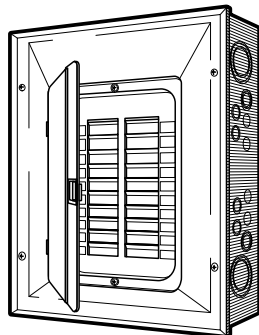

CPM120WL

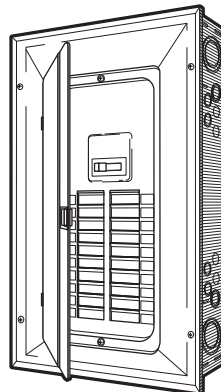

CPM1520

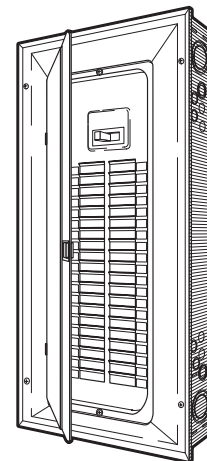

CPM240WL

Product selection

Table 1. Main circuit breaker indoor Type 1 loadcentres

Maximum ampere rating	Main breaker rating	Catalogue number	Max. no. 1-inch spaces	Max. no. 1/2-inch spaces	Cover style	Type of main breaker	Dimensions (inches)			Wire size range for main CU/AL
							H	W	D	
125	100	CPM112WL ^d	12	24	Flush/surface	BRH ^b	18-3/4	14-3/8	3-7/8	#8-1/0
125	100	CPM116WL ^d	16	32	Flush/surface	BRH ^b	21	14-3/8	3-7/8	#8-1/0
125	125	CPM116Z	16	32	Flush/surface	BRH ^c	21	14-3/8	3-7/8	#4-2/0
125	100	CPM120WL ^d	20	40	Flush/surface	BRH ^b	27	14-3/8	3-7/8	#8-1/0
125	125	CPM120Z	20	40	Flush/surface	BRH ^c	27	14-3/8	3-7/8	#4-2/0
125	100	CPM130WL ^d	30	60	Flush/surface	BRH ^b	29-1/8	14-3/8	3-7/8	#8-1/0
125	125	CPM130Z	30	60	Flush/surface	BRH ^c	29-1/8	14-3/8	3-7/8	#4-2/0
125	100	CPM140WL ^d	40	80	Flush/surface	BRH ^b	34-1/8	14-3/8	3-7/8	#8-1/0
125	125	CPM140Z	40	80	Flush/surface	BRH ^b	34-1/8	14-3/8	3-7/8	#8-1/0
150	150	CPM1520WL ^d	20	40	Flush/surface	CSR ^e	29-1/8	14-3/8	3-7/8	#2-300 MCM
150	150	CPM1530WL ^d	30	60	Flush/surface	CSR ^e	34-1/8	14-3/8	3-7/8	#2-300 MCM
150	150	CPM1540WL ^d	40	80	Flush/surface	CSR ^e	39	14-3/8	3-7/8	#2-300 MCM
200	200	CPM216WL ^d	16	32	Flush/surface	CSR ^e	29-1/8	14-3/8	3-7/8	#2-300 MCM
200	200	CPM220WL ^d	20	40	Flush/surface	CSR ^e	29-1/8	14-3/8	3-7/8	#2-300 MCM
200	200	CPM230WL ^d	30	60	Flush/surface	CSR ^e	34-1/8	14-3/8	3-7/8	#2-300 MCM
200	200	CPM240WL ^d	40	80	Flush/surface	CSR ^e	39	14-3/8	3-7/8	#2-300 MCM
200	200	CPM260	60	120	Flush/surface	CSR ^e	49	14-3/8	3-7/8	#2-300 MCM
400	300	CPM342	42	84	Flush/surface	DK ^f	66-1/2	16-1/8	6-5/16	(2)#2/0-250 MCM or (1)#2/0-500 MCM ^h
400	400	CPM442	42	42 ^g	Flush/surface	DK ^f	66-1/2	16-1/8	6-5/16	(2)#2/0-250 MCM or (1)#2/0-500 MCM ^h

a Type BR—100 A 10 kAIC main circuit breaker is factory installed (BR2100).

b High Interrupting 22 kAIC BRH breakers

c 22 kAIC BRH2125 main breaker is factory installed.

d Suffix WL denotes "white loadcentre" painted tub and trim.

e Factory installed 25 kAIC main breaker.

f DK breaker is a 65 kAIC, factory-sealed breaker.

g Restricted due to available neutrals, extra neutrals are available on **page 15** which will expand available circuitry to a maximum of 84 circuits.

h 3TA401K must be ordered separately for #2/0-500-MCM.

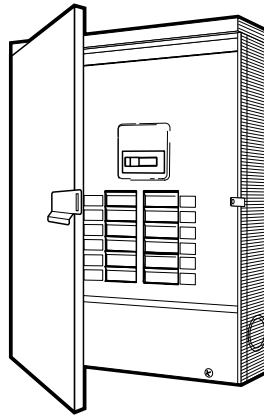
Combination (main circuit breaker) single-phase Type 3RThree-wire 120/240 Vac combination service entrance Type 3R (outdoor/raintight) ^a

RCPM220

Table 2. Main circuit breaker outdoor/raintight Type 3R loadcentres ^a

Maximum ampere rating	Main breaker rating	Catalogue number	Max. no. 1-inch spaces	Max. no. 1/2-inch spaces	Cover style	Type of main breaker	Dimensions (inches)			Wire size range for main Cu/Al
							H	W	D	
125	100	RCPM112 ^b	12	24	Outdoor	BR ^{cd}	18-1/2	14-3/8	5	#8-1/0
125	100	RCPM120 ^b	20	40	Outdoor	BR ^{cd}	25	14-3/8	5	#8-1/0
125	100	RCPM130 ^b	30	60	Outdoor	BR ^{cd}	28-7/8	14-3/8	5	#8-1/0
150	150	RCPM1530 ^b	30	60	Outdoor	CSR ^e	33-7/8	14-3/8	5	#2-300 MCM
200	200	RCPM220 ^b	20	40	Outdoor	CSR ^e	28-7/8	14-3/8	5	#2-300 MCM
200	200	RCPM230 ^b	30	60	Outdoor	CSR ^e	33-7/8	14-3/8	5	#2-300 MCM
200	200	RCPM240 ^b	40	80	Outdoor	CSR ^e	38-3/4	14-3/8	5	#2-300 MCM

^a Outdoor loadcentres accommodate Type DS conduit hubs. Hubs not included. See **page 15** for selection.

^b All enclosures include a locking hasp as an integral part of the door latching mechanism.

^c Type BR—100 A 10 kAIC main circuit breaker is factory installed (BR2100).

^d High interrupting BRH breakers are available on **page 17**.

^e Factory installed 25 kAIC main breaker.

Combination (main circuit breaker) three-phase Type 1

Four-wire 120/208 Vac combination service entrance Type 1 (indoor)

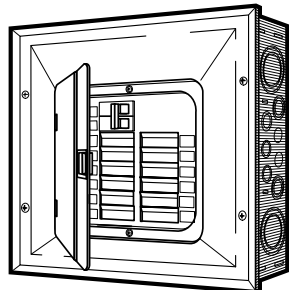

3CPM112

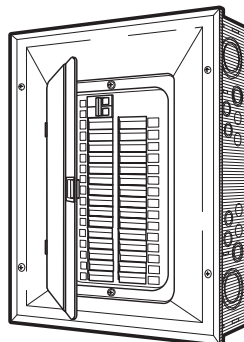

3CPM130

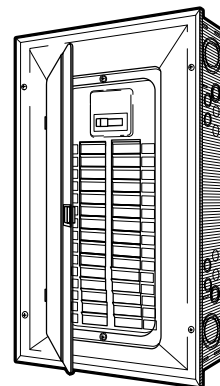

3CPM230

Table 3. Main circuit breaker indoor Type 1 loadcentres

Maximum ampere rating	Main breaker rating	Catalogue number	Max. no. 1-inch spaces	Max. no. 1/2-inch spaces	Cover style	Type of main breaker	Dimensions (inches)			Wire size range for main Cu/Al
							H	W	D	
125	100	3CPM112	12	24	Flush/surface	BR ^{bc}	21	14-3/8	3-3/4	#4-1/0
125	100	3CPM130	30	60	Flush/surface	CC ^d	39	14-3/8	3-3/4	#4-4/0
200	200	3CPM230	30	60	Flush/surface	CC ^d	39	14-3/8	3-3/4	#1-250 MCM
400	400	3CPM442 ^a	42	42 ^a	Flush/surface	DK ^e	66-1/2	16-1/8	6-5/16	(2) 2/0-250 MCM (1) 2/0-500 MCM ^f

^a Extra neutrals which will expand available circuitry to a maximum of 84 circuits are available on [page 15](#).

^b Type BR—100 A 10 kAIC main circuit breaker is factory installed (BR3100).

^c High interrupting BRH breakers are available on [page 17](#).

^d Factory installed 10 kAIC main breaker.

^e DK Breaker is a 65 kAIC factory-sealed main breaker.

^f Circuit breaker lug kit 3TA401 must be ordered separately to accept #2/0-500 MCM cabling.

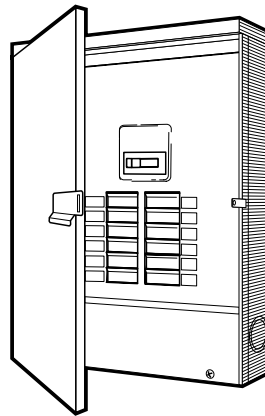
Combination (main circuit breaker) three-phase Type 3RFour-wire 120/208 Vac combination service entrance Type 3R (outdoor/raintight) ^{ab}

R3CPM230

Table 4. Main circuit breaker outdoor/raintight Type 3R loadcentres ^{ab}

Maximum ampere rating	Main breaker rating	Catalogue number	Max. no. 1-inch spaces	Max. no. 1/2-inch spaces	Cover style	Type of main breaker	Dimensions (in)			Wire size range for main Cu/Al
							H	W	D	
100	100	R3CPM112 ^b	12	24	Outdoor	BR ^{cd}	20-3/4	14-3/8	5	#4-1/0
125	100	R3CPM130 ^b	30	60	Outdoor	CC ^e	38-3/4	14-3/8	3-3/4	#4-4/0
200	200	R3CPM230 ^b	30	60	Outdoor	CC ^e	38-3/4	14-3/8	3-3/4	#1-250 MCM

^a Outdoor loadcentres accommodate Type DS conduit hubs. Hubs not included. See **page 15** for selection.

^b All enclosures include a locking hasp as an integral part of the door latching mechanism.

^c Type BR—100 A 10 kAIC main circuit breaker is factory installed (BR3100).

^d High interrupting BRH breakers are available on **page 17**.

^e Factory installed 10 kAIC main breaker.

Type CPL plug-in loadcentres

Non-combination (main lug only) single-phase Type 1

Three-wire 120/240 Vac non-combination Type 1 (indoor)

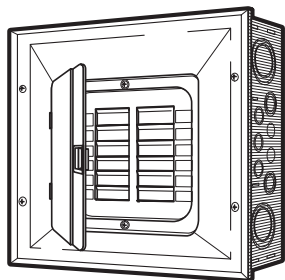

CPL112

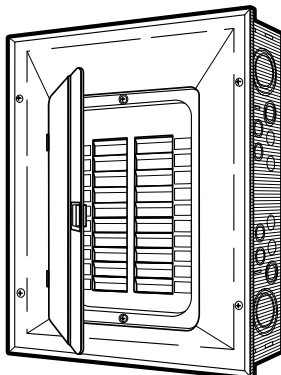

CPL220

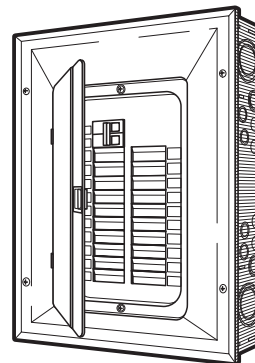

CPL120

Product selection

Table 5. Main lug only indoor Type 1 loadcentres

Maximum Ampere Rating	Catalogue Number	Max. no. 1-inch spaces	Max. no. 1/2-inch spaces	Cover style	Dimensions (inches)			Wire size range for main Cu/Al
					H	W	D	
100	CCPL102	2 ^a	4	Surface	11-1/2	6-3/4	3-1/4	#14-1/0
125	CCPL104	4	8	Flush/surface	13	11	3-1/2	#14-2/0
125	CCPL108	8	16	Flush/surface	13	11	3-1/2	#14-2/0
125	CPL112WL ^b	12	24	Flush/surface	16-3/4	14-3/8	3-7/8	#14-2/0
125	CPL116WL ^b	16	32	Flush/surface	18-3/4	14-3/8	3-7/8	#14-2/0
125	CPL120WL ^b	20	40	Flush/surface	21	14-3/8	3-7/8	#14-2/0
125	CPL130WL ^b	30	60	Flush/surface	29-1/8	14-3/8	3-7/8	#14-2/0
200	CPL220WL ^b	20	40	Flush/surface	27	14-3/8	3-7/8	#1-300 MCM
200	CPL240WL ^b	40	80	Flush/surface	34-1/8	14-3/8	3-7/8	#1-300 MCM
400	CPL442	42	42 ^c	Flush/surface	54	16-1/8	6-5/16	(1) 250-750 MCM (2) 3/0-250 MCM

^a Service equipment approved when used with two-pole BR type breaker.

^b Suffix WL Loadcentre comes with a painted white case, trim and door.

^c Extra neutrals which will expand available circuitry to a maximum of 84 circuits are available on [page 15](#).

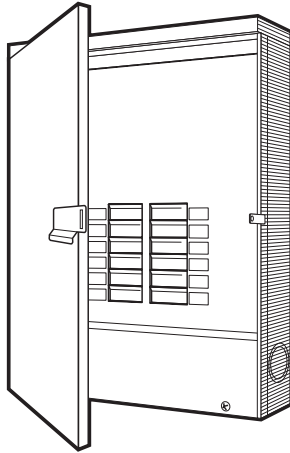
Non-combination (main lug only) single-phase Type 3RThree-Wire 120/240 Vac non-combination Type 3R (outdoor/raintight) ^a

RCPL112

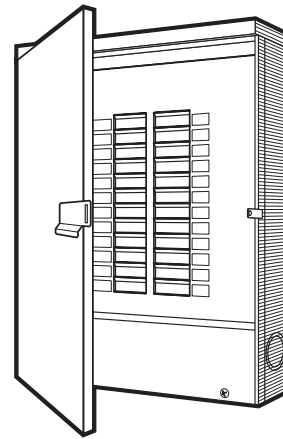

RCPL220

Table 6. Main lug only outdoor/raintight Type 3R loadcentres ^a

Maximum ampere rating	Catalogue number	Max. no. 1-inch spaces	Max. no. 1/2-inch spaces	Cover Style	Dimensions (inches)			Wire size range for main Cu/Al
					H	W	D	
125	RCCPL102 ^b	2 ^c	4	Outdoor	11-1/2	6-1/2	4	#14-2/0
125	RCCPL104 ^b	4	8	Outdoor	13	11	3-1/2	#14-2/0
125	RCCPL108 ^b	8	16	Outdoor	13	11	3-1/2	#14-2/0
125	RCPL112 ^b	12	24	Outdoor	16-1/2	14-3/8	5	#14-2/0
125	RCPL120 ^b	20	40	Outdoor	20-3/4	14-3/8	5	#14-2/0
125	RCPL130 ^b	30	60	Outdoor	28-7/8	14-3/8	5	#14-2/0
200	RCPL220 ^b	20	40	Outdoor	25	14-3/8	5	#1-300 MCM
200	RCPL240 ^b	40	80	Outdoor	33-7/8	14-3/8	5	#1-250 MCM

^a Outdoor loadcentres accommodate Type DS conduit hubs. Hubs not included. See **page 15** for selection.^b All enclosures include a locking hasp as an integral part of the door latching mechanism.^c Service equipment approved when used with two-pole BR type breaker.

Non-combination (main lug only) three-phase Type 1

Four-wire 120/208 Vac non-combination Type 1 (indoor)

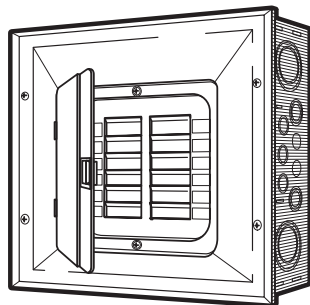

3CPL112

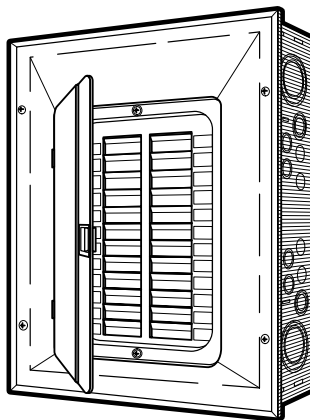

3CPL224

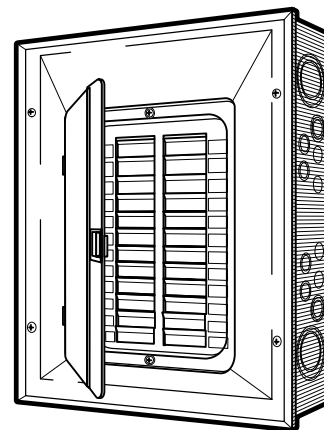

3CPL124

Table 7. Main lug only indoor Type 1 loadcentres

Maximum ampere rating	Catalogue number	Max. no. 1-inch spaces	Max. no. 1/2-inch spaces	Cover style	Dimensions (inches)			Wire size range for main Cu/Al
					H	W	D	
100	3CCPL103	3 ^a	6	Surface	14-1/4	6-1/2	3-1/4	#14-2/0
125	3CPL112	12	24	Flush/surface	21	14-3/8	3-7/8	#8-2/0
125	3CPL124	24	48	Flush/surface	29	14-3/8	3-3/4	#8-2/0
125	3CPL130	30	60	Flush/surface	34.12	14-3/8	3-3/4	#8-2/0
125	3CPL136	36	72	Flush/surface	39	14-3/8	3-3/4	#8-2/0
200	3CPL218	18	36	Flush/surface	27	14-3/8	3-7/8	#2-300 MCM
200	3CPL224	24	48	Flush/surface	34.12	14-3/8	3-7/8	#2-300 MCM
200	3CPL230	30	60	Flush/surface	34.12	14-3/8	3-3/4	#2-300 MCM
200	3CPL242	42	84	Flush/surface	39	14-3/8	3-7/8	#2-300 MCM
400	3CPL442	42	42 ^b	Flush/surface	54	16-3/8	6-5/16	(1) 250-750 MCM (2) 3/0-250 MCM

^a Suitable for use as service equipment when used with three-pole BR type breaker.

^b Extra neutrals which will expand available circuitry to a maximum of 84 circuits are available on **page 15**.

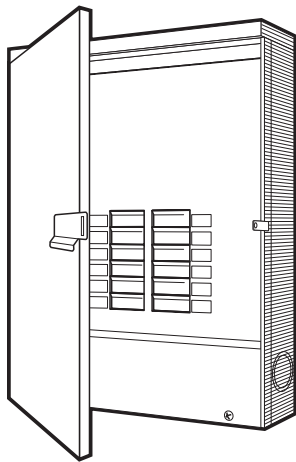
Non-combination (main lug only) three-phase Type 3RFour-wire 120/208 Vac non-combination Type 3R (outdoor/raintight) ^a

R3CPL112

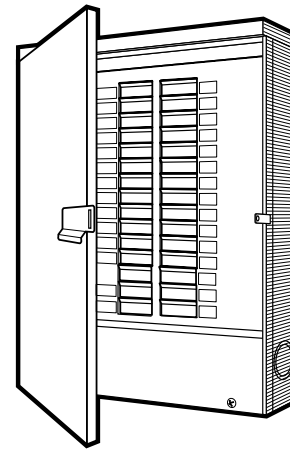

R3CPL230

Table 8. Main lug only outdoor/raintight Type 3R Loadcentres ^a

Maximum ampere rating	Catalogue number	Max. no. 1-inch spaces	Max. no. 1/2-inch spaces	Cover style	Dimensions (inches)			Wire size range for main Cu/Al
					H	W	D	
100	R3CCPL103 ^b	3 ^c	—	Outdoor	14-1/4	7	3-1/2	#14-2/0
125	R3CPL112 ^b	12	24	Outdoor	20-3/4	14-3/8	5	#14-2/0
125	R3CPL130 ^b	30	60	Outdoor	38-3/4	14-3/8	5	#14-2/0
125	R3CPL136 ^b	36	72	Outdoor	38-3/4	14-3/8	5	#14-2/0
200	R3CPL230 ^b	30	60	Outdoor	33-7/8	14-3/8	5	#2-300 MCM
200	R3CPL242 ^b	42	42 ^d	Outdoor	38-3/4	14-3/8	5	#2-300 MCM

^a Outdoor loadcentres accommodate Type DS conduit hubs. Hubs not included. See **page 15** for selection.

^b All enclosures include a locking hasp as an integral part of the door latching mechanism.

^c Suitable for use as service equipment when used with three-pole BR type breaker.

^d Extra neutrals to expand available circuitry to a maximum of 84 circuits are available on **page 15**.

Non-combination (main lug only) 70 A single-phase

Three-wire 250 Vac maximum non-combination

Service entrance approved when used with two-pole BR or BRH breakers. ^a

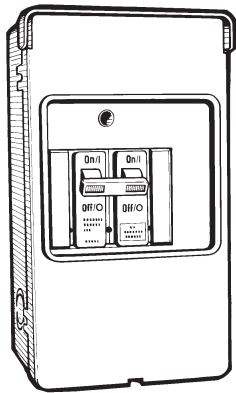

CPL072 indoor



CPL072R outdoor



CPL072FGP flush



CPL072SGP surface



CPL072RGP outdoor

Table 9. 70 A main lug only polymeric and metallic loadcentres

Maximum ampere rating	Enclosure style	Material	Catalogue number	Max. no. 1-inch spaces	Max. no. 1/2-inch spaces	Dimensions (inches)			Wire size range for main Cu/Al
						H	W	D	
70	Indoor Type 1 ^b	Polymeric	CPL072	2	4	8-5/8	5	3-1/4	#14-2
70	Indoor/outdoor Type 3R ^b	Polymeric	CPL072R ^c	2	4	8-11/16	6-1/4	4-5/16	#14-2
70	Indoor Type 1 flush mount ^b	Metallic	CPL072FGP	2	4	9-7/16	4-1/2	3	#14-2
70	Indoor Type 1 surface mount ^b	Metallic	CPL072SGP	2	4	9-7/16	4-1/2	3	#14-2
70	Indoor/outdoor Type 3R ^b	Metallic	CPL072RGP ^{cd}	2	4	9-7/16	4-1/2	3	#14-2

^a BR and BRH two-pole breakers can be found on **page 17**.

^b Service entrance approved when used with two-pole BR/BRH breakers.

^c The circuit breaker protective cover incorporates a locking hasp.

^d Uses DS*H1 style hubs found on **page 15**.

Type CPM/CPL plug-in loadcentre accessories

Table 10. Plug-in loadcentre accessories

Description	Catalogue number	Description	Catalogue number
Number strips for CPL/CPM 42 circuits a	NSP42	Door lock for 4–8 circuit 125 A (CPM/CPL)	CH9FL k
Circuit identification labels (e.g. hot water heater) b	BP3110C	Door lock for 12–42 circuit 100–225 A and 400 A (CPM/CPL)	TDL k
Replacement outer trim CPL112WL c	CBRTRIM16	Isolated ground kit	ISGRD
Replacement outer trim CPL116WL, CPM112WL c	CBRTRIM18	Trim screw kit (CPM/CPL) d	CVRSCRW
Replacement outer trim CPL120WL, CPM116WL c	CBRTRIM21	Trim screw kit white (order in quantities of 25)	LCCSW
Replacement outer trim CPL220WL, CPM120WL c	CBRTRIM27	3/4-inch hub for 100–125 A Type 3R loadcentres (3 x 2-3/4 inches) e	DS075H1
Replacement outer trim CPL130WL, CPM130WL, CPM1520WL, CPM216WL, CPM220WL c	CBRTRIM29	1-inch hub for 100–125 A Type 3R loadcentres (3 x 2-3/4 inches) e	DS100H1
Replacement outer trim CPL240WL, CPM140WL, CPM1530WL, CPM230WL c	CBTRTIM34	1-1/4 inch hub for 100–125 A Type 3R loadcentres (3 x 2-3/4 inches) e	DS125H1
Replacement outer trim CPM1540WL, CPM240WL c	CBRTRIM39	1-1/2 inch hub for 100–125 A Type 3R loadcentres (3 x 2-3/4 inches) e	DS150H1
Ground Bar Kit 5 position	GBK5	2-inch hub for 100–125 A Type 3R loadcentres (3 x 2-3/4 inches) e	DS200H1
Ground Bar Kit 8 position	GBK8	2-inch hub for 150 and 200 A Type 3R loadcentres (4-3/4 x 4-5/8 inches)	DS200H2
Ground Bar Kit 10 position	GBK10	2-1/2 inch hub for 150 and 200 A Type 3R loadcentres (4-3/4 x 4-5/8 inches)	DS250H2
Ground Bar Kit 14 position	GBK14	3-inch hub for 150 and 200 A Type 3R loadcentres (4-3/4 x 4-5/8 inches)	DS300H2
Ground Bar Kit 21 position	GBK21	3/4-inch hub for R3CCPL103 loadcentres (2-1/8 x 3-1/4 inches)	RH75P
		1-inch hub for R3CCPL103 loadcentres (2-1/8 x 3-1/4 inches)	RH100P
		1-1/4 inch hub for R3CCPL103 loadcentres (2-1/8 x 3-1/4 inches)	RH125P
		1-inch filler plate kit f	BRFP
		Subfeed kit for 125 A loadcentres #8–2/0 g	BRSF125
		Subfeed kit for 150 A three-phase loadcentres #8–2/0 g	3BRSF150
		Subfeed kit for 225 A loadcentres #2–300 MCM g	BRS225
		Subfeed kit for 225 A three-phase loadcentres #2–300 MCM g	3BRS225
		Subfeed kit for 400 A loadcentres #8–300 MCM g	BRS400
		Subfeed kit for 400 A three-phase loadcentres g	3BRS400
		Neutral/ground lug kit for 2/0 h	NL20
		Neutral/ground lug kit for 3/0 h	NL30
		Neutral/ground lug kit for 300 MCM (maximum) h	NL300
Neutral kit for 400 A non-combination loadcentres j	CPL400KIT	Neutral kit for 400 A combination loadcentres i	CPM400KIT
White plastic replacement door latch	52-3125-6	Grey plastic replacement door latch	52-3125-5
White spray can touch up paint	SPCWH	Grey spray can touch up paint	SPC61

a 25 per package. Catalogue number represents one package.

b 50 per package. Catalogue number represents one package.

c Includes outer trim only, no door, and no deadfront.

d 100 per package. Catalogue number represents one package.

e Except R3CCPL103.

f Kit includes 25 pieces.

g Line/Load terminals supplied only. Neutral conductor must be purchased separately. See above listed kits.

h Neutral bolts to main neutral bar i.e. remove screw and install lug kit.

i Kit includes 2 neutral bars.

j Kit includes 1 neutral bar.

k Comes with a set of keys.

Plug-in circuit breakers for CPM/CPL

Type BR, DNPL, GFCB, GFEP, and GFXB

BR circuit breakers

Eaton Type BR plug-in breakers in the standard 1-inch per pole moulded case and can be used as main and/or branch disconnect devices. All are CSA and UL listed. Typical ampacity range for BR breakers is 15 through 125 A. ^a

FIRE-GUARDE arc fault circuit interrupter (AFCI)

The FIRE-GUARD arc fault circuit interrupter (AFCI) is a residential circuit breaker with an integrated processor which recognizes the unique current and/or voltage signatures associated with arcing faults, and acts to interrupt the circuit to reduce the likelihood of an electrical fire. With the Eaton Fire-Guard AFCI, protection from arcing faults is combined with conventional thermal and magnetic overloads as found in standard residential circuit breakers protecting wiring from excessive heat or damage due to overloading or short circuits. Fire-Guard AFCI can also be equipped with 5 mA ground fault protection to protect from personal shock hazards. Now, there is a residential circuit breaker that provides protection from arcing faults, conductor damage due to thermal overloads and short circuits, as well as 5 mA ground fault protection in one integrated design.

GFTCB people protection breakers

Eaton Type GFCB (ground fault circuit breaker) combines state-of-the-art electronic technology with a circuit breaker mechanism in a compact 1-inch per pole moulded case. The GFCB automatically

senses hot wire-to-ground faults in a 4 to 6 mA range and shuts off the power thus providing an extra margin of safety beyond that of conventional circuit breakers. GFCB applications include bathrooms, basement outlets, swimming pools, outdoor branch circuits and kitchen branch circuits. Self testing compliant to new codes. Type GFCB breakers are also available in 30 mA equipment protectors. 30 mA breakers are for equipment requiring a higher interrupting value such as heat tracing.

DNPL twin circuit breakers

DNPL plug-in breakers have the same construction as Eaton Type BR 1-inch per pole devices except that two single-pole circuits are provided in a 1-inch space. ^a CSA listed interrupting rating is 10,000 AIC. All ratings are CSA and UL listed.

DNPL quad circuit breakers

QuadplexE construction of Eaton Type DNPL plug-in breakers provides various combinations of two-pole and single-pole devices in a 2-inch moulded case. All plug-in breakers are approved for HACR applications. ^a

- All ratings are CSA and UL listed
- CSA certified to C22.2 No. 5, file LR3300
- All loadcentre breakers are GOS listed for conformity

^a Single-pole 15 and 20 A units are switching duty (SWD) rated.

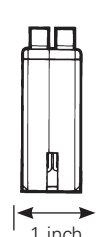
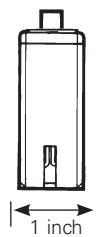
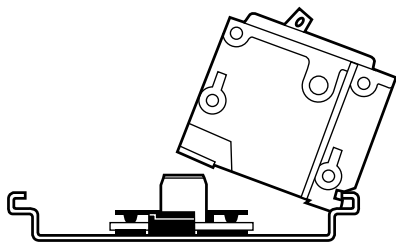
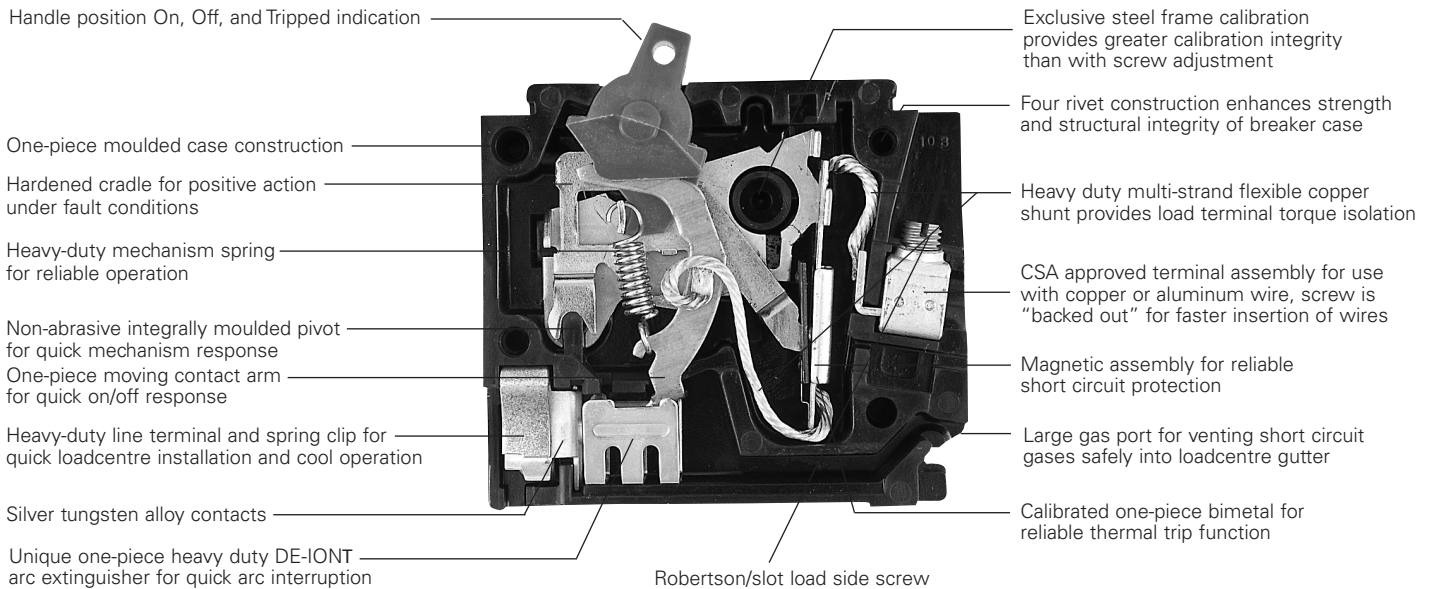

Type BR single- and multi-poleType BR ^{ab}

- 10,000/22,000 A interrupting capacity at 120 Vac, 120/240 Vac, and 240 Vac
- Two- and three-pole versions feature a common trip



BR120



BR215



BR320

Table 11. Single- and multi-pole plug-in circuit breakers

Ampere rating	Wire size range (Cu/Al 60 °C or 75 °C)	Catalogue numbers					
		Single-pole, 120/240 Vac 10 per shelf carton		Two-pole, 120/240 Vac 5 per shelf carton		Three-pole, 120/240 Vac 5 per shelf carton	
		10 kAIC	22 kAIC	10 kAIC	22 kAIC	10 kAIC	22 kAIC
15	#14-4	BR115 ^{cd}	BRH115	BR215	BRH215	BR315	BRH315
20	#14-4	BR120 ^{cd}	BRH120	BR220	BRH220	BR320	BRH320
25	#14-4	BR125 ^c	BRH125	BR225	BRH225	BR325	BRH325
30	#14-4	BR130 ^c	BRH130	BR230	BRH230	BR330	BRH330
35	#14-4	BR135 ^c	BRH135	BR235	BRH235	BR335	BRH335
40	#14-4	BR140 ^c	BRH140	BR240	BRH240	BR340	BRH340
45	#14-4	—	BRH145	BR245	BRH245	BR345	BRH345
50	#14-4	BR150 ^c	BRH150	BR250	BRH250	BR350	BRH350
60	#8-1/0	BR160 ^c	BRH160	BR260	BRH260	BR360	BRH360
70	#8-1/0	BR170 ^c	BRH170	BR270	BRH270	BR370	BRH370
80	#8-1/0	—	—	BR280	BRH280	BR380	BRH380
90	#8-1/0	—	—	BR290	BRH290	BR390	BRH390
100	#8-1/0	—	—	BR2100	BRH2100	BR3100	BRH3100
110	#8-1/0	—	—	—	—	—	—
125	#4-2/0 ^e	—	—	BR2125 ^e	—	e	—
150	e	—	—	e	—	e	—
175	e	—	—	e	—	e	—
200	e	—	—	e	—	e	—
Requires one 1-Inch (25.4 mm) space				Requires two 1-Inch (25.4 mm) spaces		Requires three 1-Inch (25.4 mm) spaces	

^a All Type BR single-, two-, and three-pole circuit breakers carry listing for HACR application.

^b Breaker shunt trips are available but only in 120 Vac format. Addition of a shunt trip adds a 1-inch space width. For circuit breakers requiring a shunt trip add an ST suffix to the end of the catalogue number (e.g. BR115ST).

^c Available with high magnetic setting for switching large tungsten lamp loads. Add suffix H to catalogue number (e.g. BR115H).

^d Switching duty rated.

^e For subfeed applications in 200 or 400 A loadcentres requiring a 125, 150, 175, or 200 A subfeed circuit breaker a Type BJ circuit breaker can be used. Refer to **page 64** for product space requirements and selection.

Type DNPL Duplex™, Independent Quadplex™ and circuit breaker packs

Type DNPL ^{ab}

- 10,000 A interrupting capacity at 120 Vac, 120/240 Vac, and 240 Vac

Table 12. Duplex and Independent Trip Quadplex plug-in circuit breakers

Duplex 2 single-pole circuits 10 per shelf carton		Quadplex independent trip 2 single-pole circuits and 1 two-pole circuit 5 per shelf carton				Quadplex independent trip 2 two-pole circuits 5 per shelf carton			
120 Vac		120 Vac	120/240 Vac	120 Vac	120/240 Vac				
Ampere rating	Catalogue number	Outer left (single-pole) ampere rating	Centre (two-pole) ampere rating	Outer right (single-pole) ampere rating	Catalogue number	Outer left and right (two-pole) ampere rating	Centre (two-pole) ampere rating	Catalogue number	Wire size range (Cu/Al 60 °C or 75 °C)
15-15	DNPL1515	15	15	15	DNPL151515	15	15	DNPL215215	#14-4 AWG
15-20	DNPL1520	15	20	15	DNPL152015	15	20	DNPL215220	#14-4 AWG
15-30	DNPL1530	15	25	15	DNPL152515	15	30	DNPL215230	#14-4 AWG
20-20	DNPL2020	15	30	15	DNPL153015	15	40	DNPL215240	#14-4 AWG
—	—	15	40	15	DNPL154015	20	20	DNPL220220	#14-4 AWG
—	—	15	50	15	DNPL155015	20	30	DNPL220230	#14-4 AWG

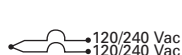

Requires one 1.00 inch (25.4 mm) space

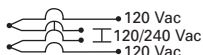

Independent trip requires two 1.00 inch (25.4 mm) spaces

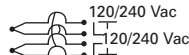

Independent trip requires two 1.00 inch (25.4 mm) spaces

a All Type DNPL Duplex and Quadplex circuit breakers carry listing for HACR applications.

b All 15 and 20 A single-pole are switch-duty rated.

Type BP (circuit breaker packs)

- Single carton packaged
- Represents common household combinations



DNPL2020



DNPL155015



DNPL230230

Table 13. Plug-in circuit breaker house packs

Contents	Catalogue number
(3) DNPL151515, (1) DNPL153015, (1) DNPL154015	BP2
(10) BR115, (3) BR215, (1) BR230, (1) BR240	BP4
(2) DNPL1515, (1) DNPL215215, (1) DNPL152015, (1) DNPL153015, (1) DNPL154015	BP16
(6) DNPL1515, (2) DNPL151515, (1) DNPL153015, (1) DNPL154015	BP18
(1) DNPL1515, (3) DNPL151515, (2) DNPL153015, (1) DNPL154015	BP21
(3) DNPL1515, (3) DNPL151515, (1) DNPL153015, (1) DNPL154015	BP23
(16) BR115, (3) BR215, (1) BR230, (1) BR240	BP24
(14) BR115, (2) BR120, (1) BR230, (1) BR240	BP27
5 of DNPL1515, 1 of DNPL2020, 1 of DNPL153015, 1 of DNPL154015	BP31
(1) BR120, (4) DNPL1515, (1) DNPL151515, (1) DNPL153015, (1) DNPL154015	BP32
(10) BR115, (2) BR120, (1) BR215, (1) BR220, (1) BR230, (1) BR240	BP41
(3) DNPL1515, (1) DNPL153015, (1) DNPL154015, (1) DNPL2020, (1) DNPL1520	BP54

Type BR arc fault circuit interrupter

Type BR arc fault circuit interrupter circuit breakers

- 10,000 A interrupting capacity at 120 Vac, 120/240 Vac, and 240 Vac

An arc fault circuit interrupter is a device intended to provide protection from the effects of arc faults by recognizing characteristics unique to arcing and by functioning to de-energize the circuit when the arc fault is detected. As of January 1, 2015, the Canadian Electrical Code now requires that all branch circuits that supply 125 V, single-phase, 15 and 20 A receptacle outlets installed in dwelling unit shall be protected by a combination arc fault circuit interrupter(s) (series arc and parallel arc detection).

Table 14. Single- and two-pole plug-in AFCI circuit breakers

Ampere rating	Configuration	Catalogue number		Wire size range (Cu/Al 60 °C or 75 °C)
		Single-pole 120/240 Vac 20 per shelf carton 10 kAIC	Two-pole ^{ab} 120/240 Vac 5 per shelf carton 10 kAIC	
15	Branch	BRAF115	—	#14–4 AWG
15	Combination	BRAF115C	—	#14–4 AWG
15	Common trip	—	BRL215CAF cd	#14–4 AWG
15	High interrupting 22 kAIC	BRHCAF115	—	#14–4 AWG
20	Branch	BRAF120	—	#14–4 AWG
20	Combination	BRAF120C	—	#14–4 AWG
20	Common trip	—	BRL220CAF cd	#14–4 AWG
20	High interrupting 22 kAIC	BRHCAF120	—	#14–4 AWG
		Requires one 1.00 inch (25.4 mm) space		Requires two 1.00 inch (25.4 mm) spaces

- a Common trip refers to two-pole 240 V load application sourced by 120/240 Vac (see **Figure 1**).
- b Independent trip refers to two-pole multi-wire, home run or shared neutral circuits (see **Figure 2** and **Figure 4**).
- c Will not fit into CPM112, CPL112, CPL116, CPL120, CPL220, CPL240, 3CPM112, 3CPL218, 3CPL224 or 3CPL230 prior to November 2004.
- d Long style circuit breakers. Please speak to your local Eaton sales rep for proper application.

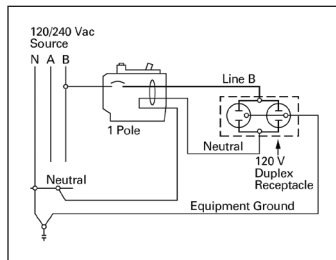

Figure 1. Single-pole, single 120 V load application sourced by 120/240 Vac

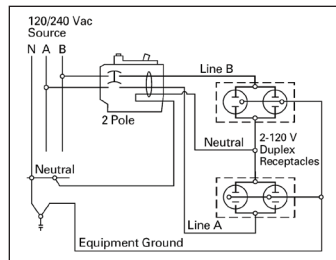

Figure 2. Two-pole, shared neutral with multi-duplex receptacle application

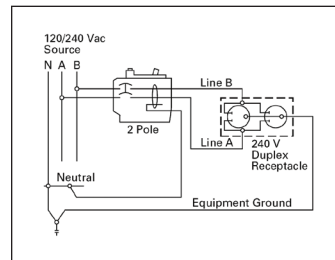

Figure 3. Two-pole, 240 V load application sourced by 120/240 Vac

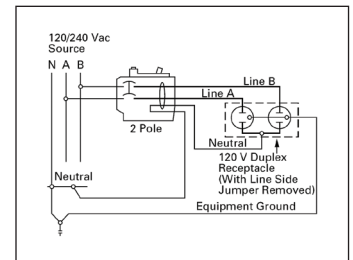
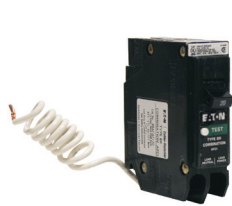

Figure 4. Two-pole, shared neutral with duplex receptacle application



Type BR combination AFCI circuit breaker



Type BR dual purpose AF/GF breaker



Type BR fire alarm breaker features red handle

Table 15. Single-pole plug-in dual purpose AF/GF breakers

Ampere rating	Configuration	Single-pole, 120/240 Vac 10 per shelf carton, 10 kAIC Catalogue number
15	CAFCI / 5 mA GF	BRAFGF115C
20	CAFCI / 5 mA GF	BRAFGF120C
Compact body breaker		Requires one 1.00 inch (25.4 mm) space

Table 16. Single-pole plug-in fire alarm breakers

Ampere rating	Configuration	Single-pole, 120/240 Vac 10 per shelf carton, 10 kAIC Catalogue number
15	Branch fire alarm	BRF115
20	Branch fire alarm	BRF120
Compact body breaker		Requires one 1.00 inch (25.4 mm) space

Types GFCB and GFEP ground fault

Type GFCB and GFEP ground fault circuit breakers

- 10,000/22,000 A interrupting capacity at 120 Vac and 120/240 Vac
- 5 mA “people protection”, 10 mA submersible pump protection, or 30 mA equipment protectors
- Two-pole version features common trip



GFTCB single-pole



GFTCB two-pole

Table 17. 5 mA single- and two-pole plug-in ground fault circuit breakers

Ampere rating	Wire size range Cu/Al 60 °C or 75 °C (AWG)	Catalogue number				
		Single-pole, 120 Vac 1 per shelf carton		Two-pole, 120/240 Vac 1 per shelf carton		
		10 kAIC	22 kAIC	10 kAIC	22 kAIC	
15	#14–8	GFTCB115 a	GFTCBH115	GFTCB215	GFTCBH215	
20	#14–8	GFTCB120 a	GFTCBH120	GFTCB220	GFTCBH220	
25	#14–8	GFTCB125 a	GFTCBH125	GFTCB225	GFTCBH225	
30	#14–8	GFTCB130 a	GFTCBH130	GFTCB230	GFTCBH230	
40	#14–8	GFTCB140 a	—	GFTCB240	—	
50	#14–8	—	—	GFTCB250 b	—	
60	#14–4	—	—	GFTCB260	—	
			Requires one 1.00 inch (25.4 mm) space		Requires two 1.00 inch (25.4 mm) spaces	

a Auxiliary switches and bell alarms are available under special order. Add suffix W1 for alarm switch and W2 for auxiliary switch.

b For use with copper wire only.

Table 18. 30 mA single- and two-pole plug-in ground fault circuit breaker equipment protectors

Ampere rating	Wire size range Cu/Al 60 °C or 75 °C (AWG)	Catalogue number			
		Single-pole, 120 Vac 1 per shelf carton	Two-pole, 120/240 Vac 1 per shelf carton		
		10 kAIC	10 kAIC		
15	#14–8	GFEP115	GFEP215		
20	#14–8	GFEP120	GFEP220		
25	#14–8	GFEP125	GFEP225		
30	#14–8	GFEP130	GFEP230		
40	#14–8	—	GFEP240		
50	#14–8	—	GFEP250 a		
		Requires one 1.00 inch (25.4 mm) space		Requires two 1.00 inch (25.4 mm) spaces	

a For use with copper wire only.

Ground fault application note

Single-pole ground fault circuit breakers (GFCBs) are designed for use in two-wire, 120 Vac circuits. **Figure 5** shows a typical wiring configuration. Two-pole GFCBs are designed for use in three-wire, 120/240 Vac circuits, 120 Vac multi-wire circuits employing common, neutral and two-wire, 240 Vac circuits obtained from a 120/240 Vac source. **Figure 6** and **Figure 8** illustrate typical wiring configurations for 120/240 Vac multi-wire circuits. **Figure 7** depicts a 240 Vac, two-wire circuit.

Note: The “panel neutral” conductor connects to the neutral bar, even though the neutral is not included in the load circuit. This connection is necessary to supply a 120 Vac power source to the ground fault sensing circuit. The figures are shown with a 120/240 Vac, single-phase, three-wire power source, but are also applicable to a 120/208 Vac, three-phase, four-wire power supply. For all figures, the electrical operation of the GFCB is not affected by the equipment ground.

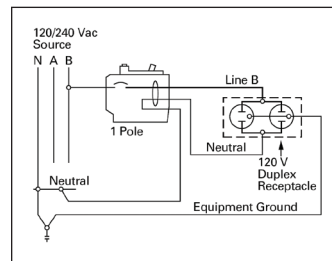

Figure 5. Single-pole

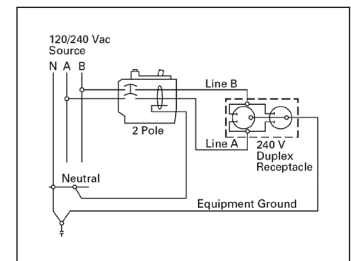

Figure 7. Two-pole

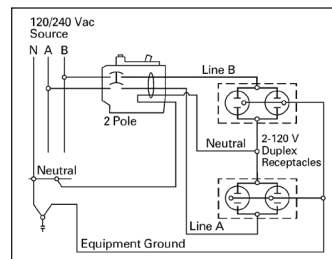

Figure 6. Two-pole

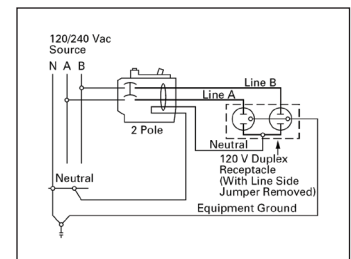

Figure 8. Two-pole

Type GFCB ground fault and Type BR internationally rated

Type BR internationally rated circuit breakers

- 3000/6000 A interrupting capacity at 240/415 Vac
- Two- and three-pole versions feature common trip



BR120E



BR215E



BR320E

Table 19. Single-, two-, and three-pole plug-in internationally rated circuit breakers ^{ab}

Ampere rating	Wire size range Cu/Al 60 °C or 75 °C (AWG)	Catalogue number					
		Single-pole, 240/415 Vac 10 per shelf carton		Two-pole, 240/415 Vac 5 per shelf carton		Three-pole, 240-415 Vac 5 per shelf carton	
		3 kAIC	6 kAIC	3 kAIC	6 kAIC	3 kAIC	6 kAIC
15	#14-4	BR115E	BRH115E	BR215E	BRH215E	BR315E	BRH315E
20	#14-4	BR120E	BRH120E	BR220E	BRH220E	BR320E	BRH320E
25	#14-4	BR125E	BRH125E	BR225E	BRH225E	BR325E	BRH325E
30	#14-4	BR130E	BRH130E	BR230E	BRH230E	BR330E	BRH330E
35	#14-4	BR135E	BRH135E	BR235E	BRH235E	BR335E	BRH335E
40	#14-4	BR140E	BRH140E	BR240E	BRH240E	BR340E	BRH340E
45	#14-4	—	BRH145E	BR245E	BRH245E	BR345E	BRH345E
50	#14-4	BR150E	BRH150E	BR250E	BRH250E	BR350E	BRH350E
60	#4-1/0	BR160E	BRH160E	BR260E	BRH260E	BR360E	BRH360E
70	#4-1/0	BR170E	BRH170E	BR270E	BRH270E	BR370E	BRH370E
80	#4-1/0	—	—	BR280E	BRH280E	BR380E	BRH380E
90	#4-1/0	—	—	BR290E	BRH290E	BR390E	BRH390E
100	#4-1/0	—	—	BR2100E	BRH2100E	BR3100E	BRH3100E
				Requires one 1.00 inch (25.4 mm) space		Requires two 1.00 inch (25.4 mm) spaces	
						Requires three 1.00 inch (25.4 mm) spaces	

^a Built to British Standard BS3871.

^b Non-stocked item requiring special order. Speak to your local Eaton sales rep for lead times.

Table 20. Duplex, 2 single-pole circuits, 240/415 Vac

Ampere rating	Catalogue number
15-15	DNPL1515E
15-20	DNPL1520E
20-20	DNPL2020E
—	—
—	—
Requires one 1.00 inch (25.4 mm) space	

Type GFXB internationally rated ground fault and Type BR moulded case switches

Type GFXB internationally rated ground fault circuit breakers

- 3000 A interrupting capacity at 120/240 Vac, 220/380 Vac, and 240/415 Vac



Type GFXB

Table 21. 30 mA single-pole plug-in ground fault circuit breakers ^{abc}

Ampere rating	Wire size range Cu/Al 60 °C or 75 °C (AWG)	Catalogue number ^a Single-pole, 120 Vac 1 per shelf carton 3 kAIC
15	#14-4	GFXB115B2
20	#14-4	GFXB120B2
25	#14-4	GFXB125B2
30	#14-4	GFXB130B2

Requires one 1.00 inch (25.4 mm) space

^a Auxiliary switches and bell alarms are available under special order. Add suffix W1 for alarm switch and W2 for auxiliary switch.

^b Meets requirements of BS3871 section 31C and BS4293.

^c Non-stocked part requiring special ordering. Speak to your local Eaton sales rep for lead times.

Type BR non-automatic moulded case switches



BR250NA

Table 22. Two-pole plug-in non-automatic moulded case switches ^a

Ampere rating	Wire size range Cu/Al 60 °C or 75 °C (AWG)	Catalogue number ^a Two-pole, 120/240 Vac 5 per shelf carton
50	#4-1/0	BR250NA
60	#4-1/0	BR260NA
100	#4-1/0	BR2100NA

Requires two 1.00 inch (25.4 mm) spaces

^a Non-stocked part requiring special ordering. Speak to your local Eaton sales rep for lead times.

Plug-in loadcentre main circuit breakers for CPM/CPL

Type CSR, and CC

Type CSR loadcentre main circuit breaker kit

- 25,000 A interrupting capacity at 120/240 Vac



CSR2150N

Type CC loadcentre main circuit breaker kit



CC3150

Table 23. Two-pole main circuit breakers for single-phase plug-in combination loadcentres

Ampere rating	Wire size range Cu/Al 60 °C or 75 °C	Catalogue number
		Two-pole, 120/240 Vac 1 per shelf carton 25 kAIC
125	#2 AWG–300 kcmil	CSR2125N
150	#2 AWG–300 kcmil	CSR2150N
200	#2 AWG–300 kcmil	CSR2200N

Table 24. Three-pole main circuit breakers for three-phase plug-in combination loadcentres

Ampere rating	Wire size range Cu/Al 60 °C or 75 °C	Catalogue number
		Three-pole, 120/240 Vac 1 per shelf carton 10 kAIC
100	#4 AWG–4/0 AWG	CC3100
125	#2 AWG–300 kcmil	CC3125
150	#2 AWG–300 kcmil	CC3150
200	#2 AWG–300 kcmil	CC3200

Plug-in circuit breaker accessories for CPM/CPL loadcentres

Plug-in circuit breaker accessories

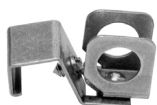

BRLW2-10



BHLW2-10



BRQLW-10



BHLW-10



MCBPL
(installed)



THOW-10
(installed)

Table 25. Field installation kits and parts for plug-in loadcentre circuit breakers

Description	Ordering quantity ^a	Catalogue number
Handle tie for single-pole Type BR circuit breakers. Joins handles on breakers mounted adjacent to each other via a clip-on mechanism.	1	BQHT-10
Handle tie for Type DNPL circuit breakers. Joins the two outside independent poles on two adjacent duplex or one quadplex circuit breakers.	1	THOW-10
Handle tie for Type DNPL circuit breakers. Joins the outside independent poles on adjacent duplex or quadplex circuit breakers.	1	THS1
Handle lockoff (escutcheon mounted). Single-, two-, or three-pole Type BR; single-pole of a Type DNPL duplex or; one independent outside pole of a Type DNPL quadplex circuit breakers.	1	BRLW-10
Handle lockoff (handle mounted). Single-pole Type BR circuit breakers. ^b	1	BRLW1-10
Handle lockoff (handle mounted). Two- and three-pole Type BR circuit breakers. ^b	1	BRLW2-10
Handle lockoff (handle mounted). Single-pole Type DNPL quadplex circuit breakers. ^b	1	BRDL1-10
Handle lockoff (escutcheon mounted). Two-pole Type DNPL quadplex circuit breakers. ^b	1	BRQLW-10
Handle lockoff (screw mounted). Locks the handle of main circuit breaker types CC and CHH in the OFF or ON position. ^b	1	CCPL
Handle lockoff (escutcheon mounted). Locks the handle of main circuit breaker type CSR and BWH in the OFF or ON position. ^b	1	MCBPL
Handle lockdog (escutcheon mounted). Single-, two-, and three-pole Type BR; single-pole of a Type DNPL duplex or; one independent pole of a Type DNPL quadplex circuit breaker. Secures handle in the ON or OFF position. ^b	1	BHLW-10
Handle lockdog (handle mounted). Single-pole Type BR circuit breakers. Secures handle in the ON or OFF position. ^b	1	BHLW1-10
Handle lockdog (handle mounted). Two- and three-pole Type BR circuit breakers. Secures handle in the ON or OFF position. ^b	1	BHLW2-10
Handle lockdog (handle mounted). Single-pole Type GFCB ground fault circuit breakers. Secures handle in the ON or OFF position. ^b	1	BHGW-10
Handle lockdog (handle mounted). Single-pole Type DNPL duplex or 1 outside independent pole of a quadplex. Secures handle in the ON or OFF position. ^b	1	HLW1-10
Main breaker lug kit. Types CC and CHH circuit breakers (2) 300 kcmil	1	CCL300
Main breaker lug kit. Types CSR, BW, and BWH circuit breakers (2) 300 kcmil	1	MCBL300
Electronic breaker lockoff (escutcheon mounted): Type BR long body AF/GF	1	BRLAFGFLOFF
Electronic breaker lockoff (escutcheon mounted): Type BR compact body AF	1	BRCAFLOFF

^a Must be purchased in multiples of ordering quantities indicated.

^b Refer to your local Eaton sales representative for handle position changeability chart.

Definitions

Handle ties: Devices used to join two similar independent single-pole circuit breakers to form a two-pole non-common trip breaker.

Handle lockoffs: Devices that use a padlock to lock a circuit breaker's handle in either the ON or OFF position.

Handle lockdogs: Devices used to secure a circuit breaker's handle in the ON or OFF position. They are not padlockable devices.

Escutcheon mounted: A semipermanent mounting to the face of the circuit breaker and secured by the loadcentre's deadfront cover.

Handle mounted: A mounting made directly to the handle of the circuit breaker by means of a set screw.

Screw mounted: A permanent mounting to the face of the circuit breaker by means of a non-removable screw.

Plug-in OEM loadcentre interior assemblies

Product description

As a leader in the electrical distribution equipment business, Eaton has a unique product offering for equipment manufacturers, panel builders and virtually any OEM that has a need for power distribution within their equipment. The OEM interior offering consists of a wide variety of power distribution options utilizing components from Eaton's BR Loadcentre product lines. With high-volume, standardized products, OEMs can expect to receive high-quality products covering configurations meeting virtually any power distribution need.

Coupled with Eaton's expertise in circuit breaker design and manufacturing, our OEM interiors provide solid power distribution and circuit protection in a compact, easy-to-install package.

Product offering

The BR interiors are manufactured of formed, plated aluminum, and use the Eaton Type BR 1.00 inch (25.4 mm) wide circuit breaker by Eaton. This design affords customers the most circuit flexibility as many of these interiors allow the installation of standard single- and two-pole breakers as well duplex (two-pole in a 1.00 inch (25.4 mm) space) or quadplex (four-pole in a 2.00 inch (50.8 mm) space) breakers. The stab rating of the BR interiors is 140 A maximum, meaning that the handle rating of the breakers that are mounted across from one another may not exceed 140 A.

The interiors are designed for either horizontal (single-row breaker mounting), or vertical (double-row breaker mounting).

Product selection

Standards and certifications

Canadian Standards Association listing

All single- and two-pole, 120/240 V breakers, both 1-inch (25.4 mm), 1/2-inch (12.7 mm) and 3/4-inch (19.1 mm) per pole, 225 A maximum, are listed as certified by the Canadian Standards Association, Guide No. 69-11.19, Class 1432, File 18328.

Underwriters Laboratories listing

All grounding bars manufactured comply with Underwriters Laboratories standards and are listed under Guide No. DHJR, File E31424, Volume W, Section 17.

All circuit breakers 10 A and larger comply with the Underwriters Laboratories "Standard for Branch Circuit and Service Circuit-Breakers" UL 489; Guide No. 60 10.2 File E31424, and "Requirements for Wire Connectors and Soldering Lugs," UL 486B, Guide No. 461 10-C File E7830.

All Eaton breakers where marked, are suitable for use with 60/75 ° rated wire, unless otherwise specified.

All devices comply with the 22–10 kAIC UL series connected components File DKS2 of the Recognized Components Index.

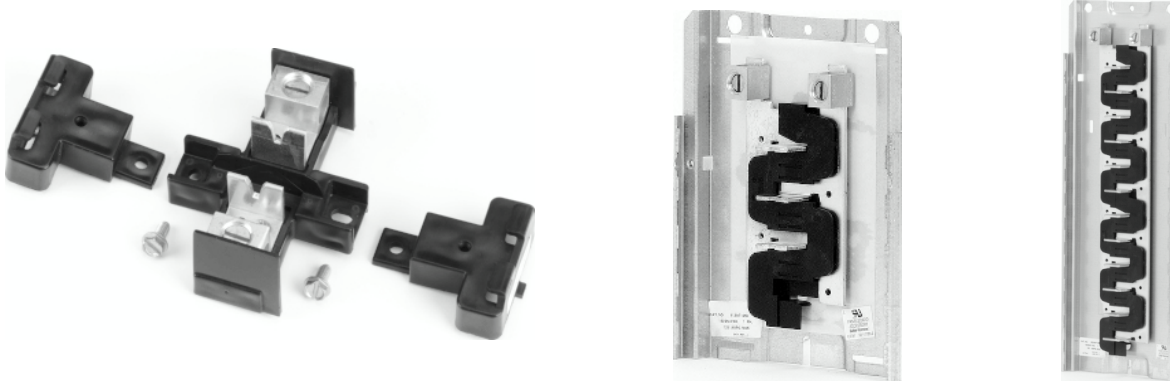

Table 26. Plug-in OEM loadcentre interior assemblies

Ampere rating	1-inch spaces	½-inch spaces	Main terminal size (per phase)	Package quantity	Catalogue number
125	4	8	(1) 2/0-#14 AWG Cu/Al	20	48INT125B
125	8	16	(1) 2/0-#14 AWG Cu/Al	20	816INT125B
125	12	24	(1) 2/0-#14 AWG Cu/Al	20	1224INT125B
125	16	24	(1) 2/0-#14 AWG Cu/Al	20	1624INT125B
125	20	24	(1) 2/0-#14 AWG Cu/Al	10	2024INT125B
125	24	24	(1) 2/0-#14 AWG Cu/Al	10	2424INT125B

Dimensions

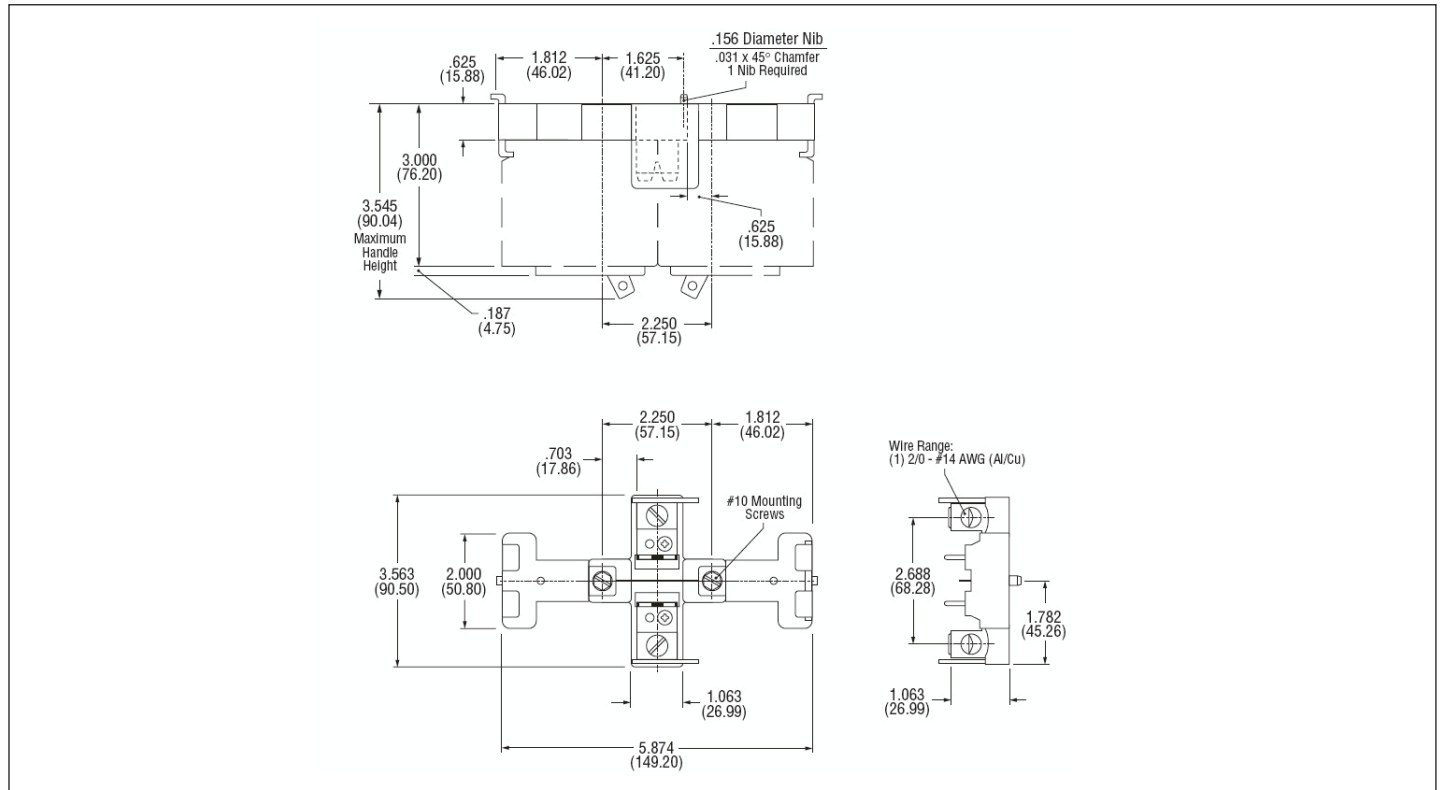

Figure 9. 48INT125B

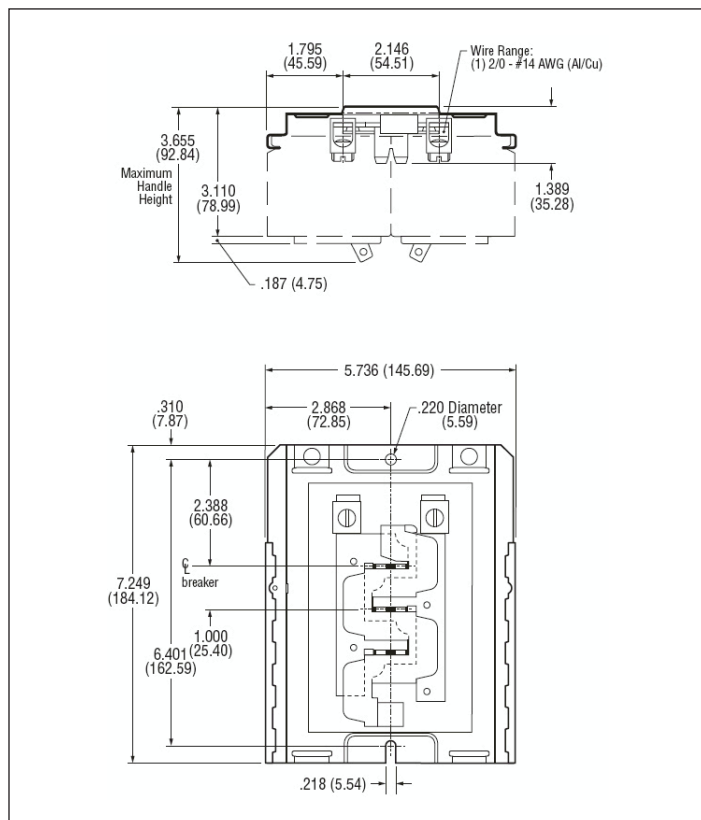

Figure 10. 816INT125B

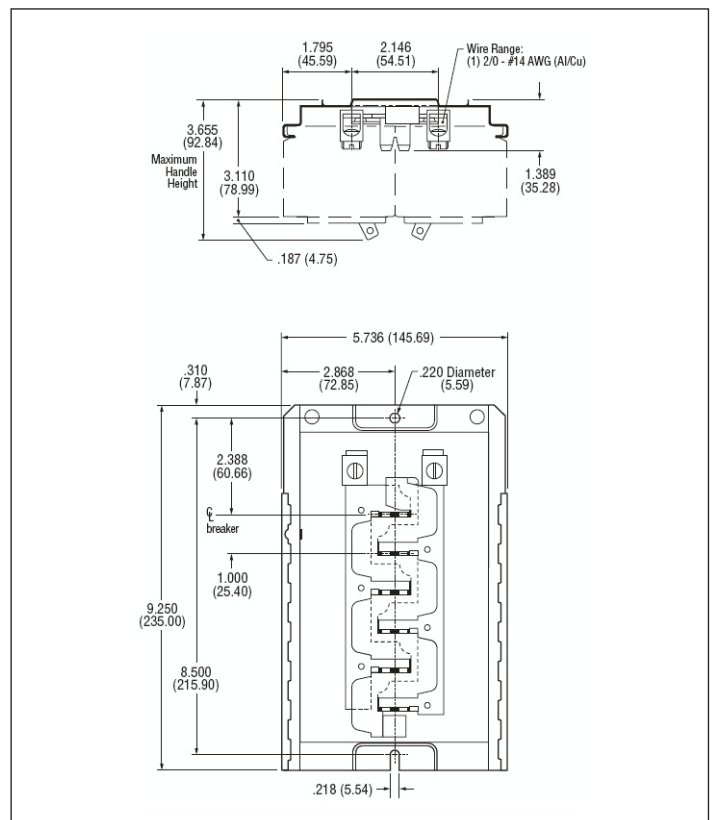

Figure 11. 1224INT125B

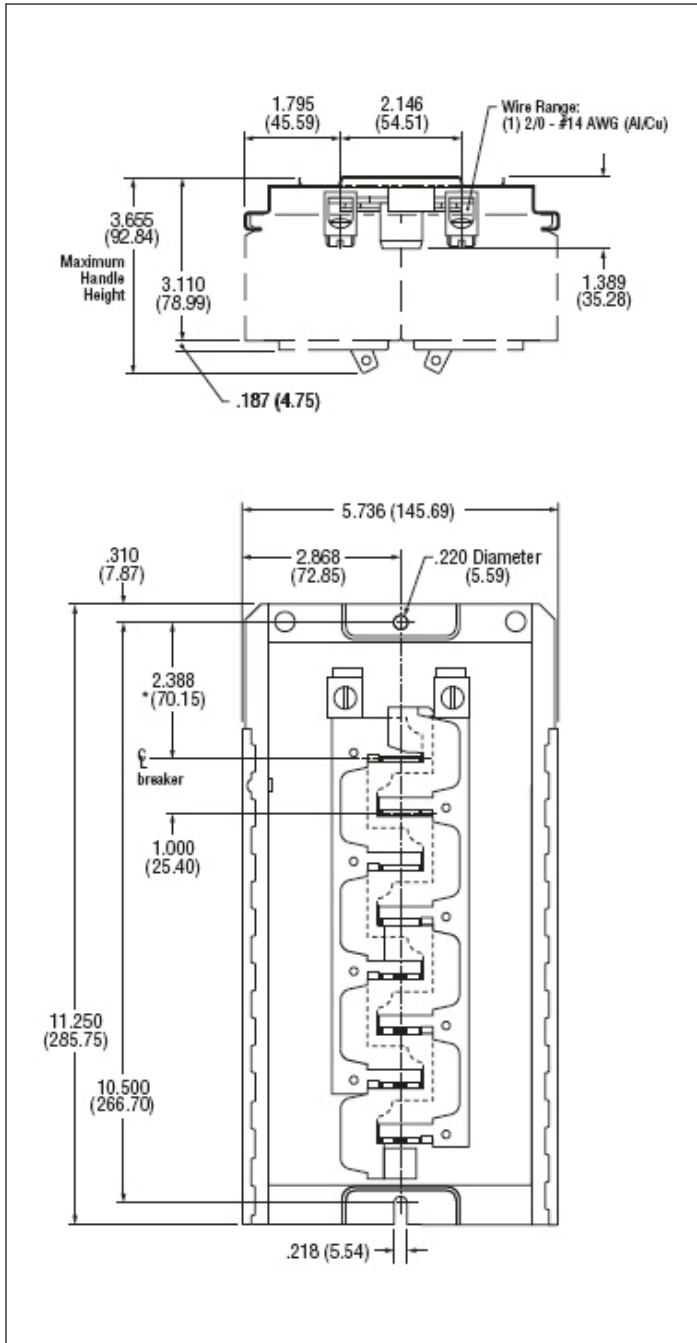

Figure 12. 1624INT125B

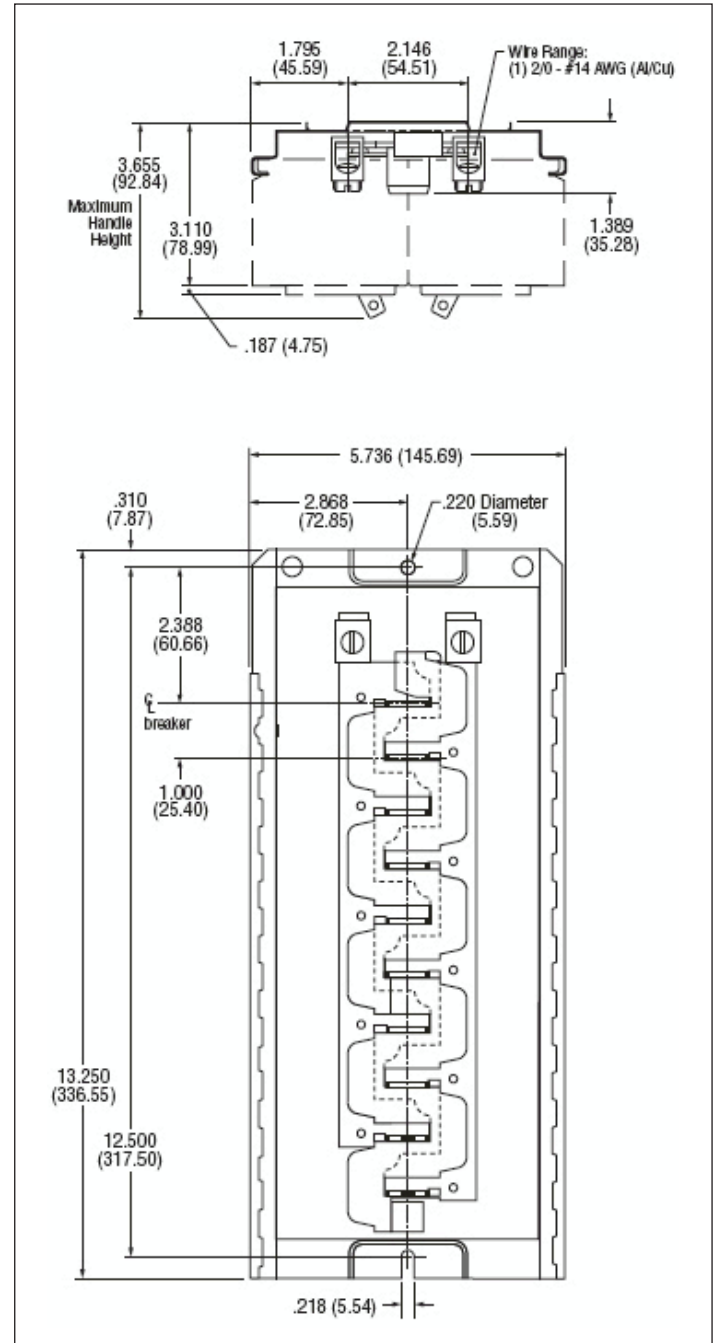

Figure 13. 2024INT125B

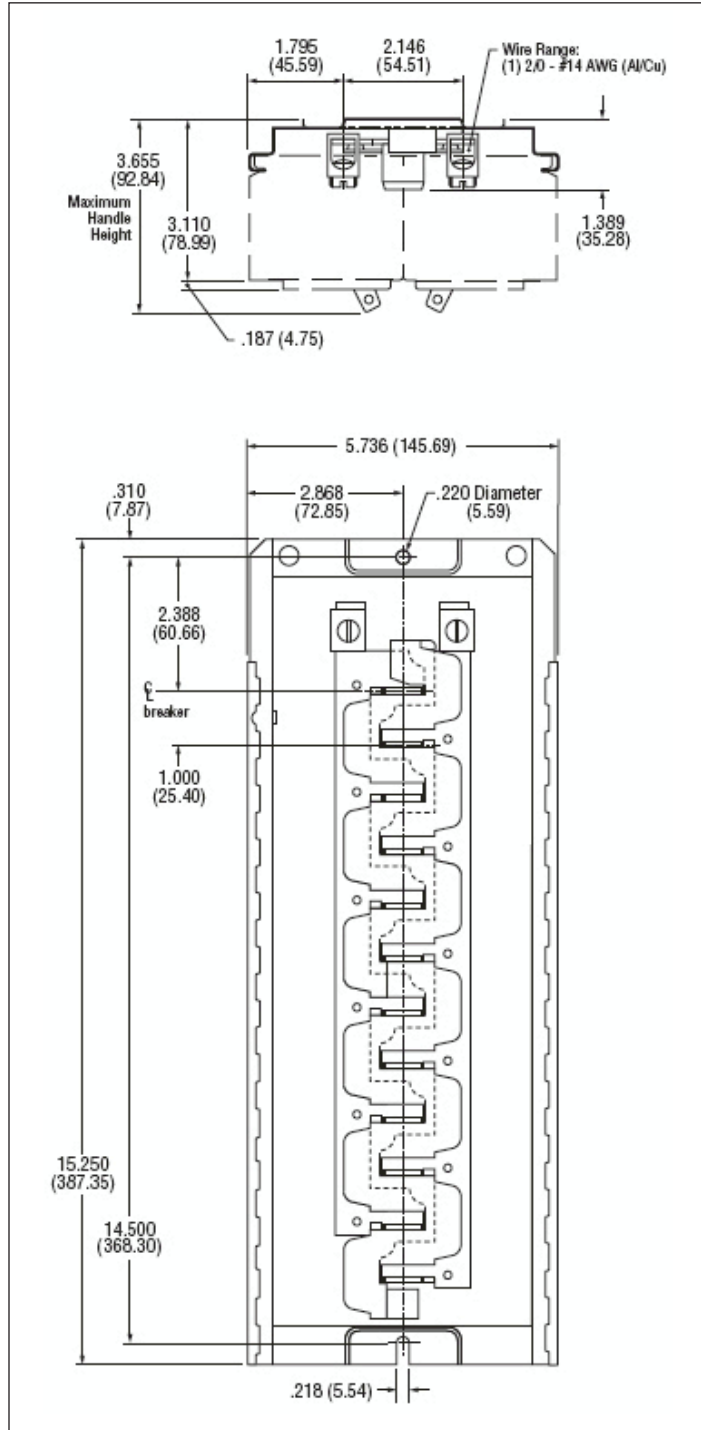

Figure 14. 2424INT125B

Type CH plug-in loadcentres

Product description

Loadcentres feature factory installed main lugs or main circuit breakers. The CH interiors are manufactured of formed, silver flash plated copper. Eaton also supplies a full line of Type CH branch circuit breakers and accessories for these loadcentres.

Product application

Designed for the protection and distribution of single and multi-dwelling residential and light commercial loads to 120/240 volts AC, such as lighting, heating, appliance and small motor branch circuits. All main circuit breaker combination loadcentres are CSA listed for use as service entrance equipment.

Ratings

Single-phase, three-wire, 120/240 volts AC. Mains through 200 A. Available with up to 120 branch circuits. Main breakers on 100 and 200 A panels are rated at 35,000 AIC.

Metal enclosure specifications

Enclosures are made of 16 gauge galvanized sheet steel powder coated sandalwood beige. The galvanized coating provides corrosion protection. Trims are similarly scratch-resistant powder coated a sandalwood beige colour to match the tub. A combination surface/flush cover with integral door is supplied.

All plug-in loadcentres are CSA listed to file LL98266.

Warranty

Limited lifetime.

Type CH plug-on neutral loadcentre features and benefits

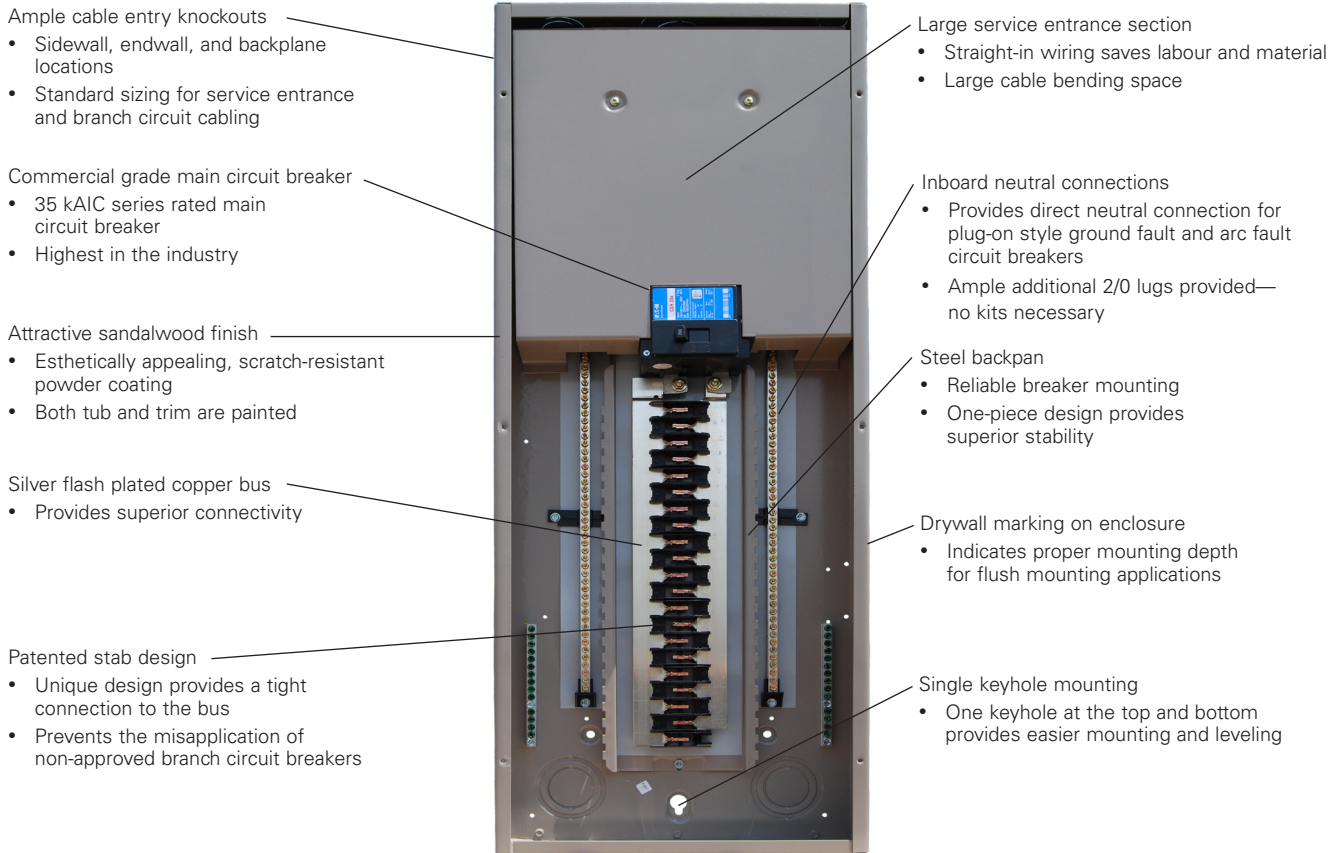

Combination and non-combination single-phase

Three-wire 120/240 Vac plug-on neutral style combination service entrance Type 1 (indoor)

Table 27. Type CH Main circuit breaker plug-on neutral indoor Type 1 loadcentres

Maximum ampere rating	Main breaker rating	Max. no. 3/4-inch spaces	Cover style	Type of main circuit breaker	Dimensions in inches (mm)			Wire size range for main Cu/Al	Catalogue number
					H	W	D		
100	100	24	Flush/surface	CSR	29.13 (739.8)	14.19 (360.4)	3.69 (93.7)	#2–300 kcmil	CHM24PN100
100	100	32	Flush/surface	CSR	34.13 (866.8)	14.19 (360.4)	3.69 (93.7)	#2–300 kcmil	CHM32PN100
100	100	42	Flush/surface	CSR	37.00 (939.8)	14.19 (360.4)	3.69 (93.7)	#2–300 kcmil	CHM42PN100
200	200	32	Flush/surface	CSR	34.13 (866.8)	14.19 (360.4)	3.69 (93.7)	#2–300 kcmil	CHM32PN200
200	200	42	Flush/surface	CSR	37.00 (939.8)	14.19 (360.4)	3.69 (93.7)	#2–300 kcmil	CHM42PN200
200	200	60	Flush/surface	CSR	39.00 (990.6)	14.19 (360.4)	3.69 (93.7)	#2–300 kcmil	CHM60PN200L

Three-wire 120/240 Vac plug-on neutral style non-combination service entrance Type 1 (indoor)

Table 28. Type CH main lug only plug-on neutral indoor Type 1 loadcentres

Maximum ampere rating	Max. no. 3/4-inch spaces	Cover style	Dimensions in inches (mm)			Wire size range for main Cu/Al	Catalogue number
			H	W	D		
125	24	Flush/surface	29.13 (739.8)	14.19 (360.4)	3.69 (93.7)	#2–300 kcmil	CHNL24PN125
125	32	Flush/surface	34.13 (866.8)	14.19 (360.4)	3.69 (93.7)	#2–300 kcmil	CHNL32PN125
225	32	Flush/surface	34.13 (866.8)	14.19 (360.4)	3.69 (93.7)	#2–300 kcmil	CHNL32PN225
225	42	Flush/surface	37.00 (939.8)	14.19 (360.4)	3.69 (93.7)	#2–300 kcmil	CHNL42PN225

Three-wire 120/240 Vac standard neutral non-combination Type 3R (outdoor/raintight) ^{ab}



CH6L125R



RCCHL102

Table 29. Type CH main lug only standard neutral outdoor/raintight Type 3R loadcentres ^a

Maximum ampere rating	Catalogue number	Max. no. 3/4-inch spaces	Max. no. 3/8-inch spaces	Enclosure style	Dimensions in inches (mm)			Wire size range for main CU/AL
					H	W	D	
100	RCCHL102	2	4	Indoor/outdoor Type 3R ^{ac}	12.00 (304.8)	6.88 (174.62)	4.38 (111.13)	#14–1/0
125	CH6L125R	6	12	Indoor/outdoor Type 3R	12.00 (304.8)	6.88 (174.62)	4.38 (111.13)	#14–1/0

^a Outdoor loadcentres accommodate Type DS conduit hubs. Hubs not included. See **page 15** for selection.

^b Does not accept plug-on neutral style of arc fault and ground fault circuit breakers. Uses standard type arc fault and ground fault circuit breakers.

^c Enclosure assembly incorporates a swing out locking hasp for the cover.

Plug-in circuit breakers for CH

Type CH single, multi-pole, and twin

Type CH plug-in circuit breakers ^a

- 10,000 A interrupting capacity at 120/240 Vac
- Flag trip models provide visual indication of trip

Product selection

Table 30. Single- and multi-pole plug-in breakers

Ampere rating	Wire size range (Cu/AL 60 °C or 75 °C) (AWG)	Catalogue Number		
		Single-pole, 120/240 Vac Flag trip indication 10 per shelf carton	Two-pole, 120/240 Vac Flag trip indication 5 per shelf carton	Three-pole, 240 Vac Standard 5 per shelf carton
10	(1) #14-8 b, (2) #14-10 bc, (1) #14-6 d	—	—	—
15	(1) #14-8 b, (2) #14-10 bc, (1) #14-6 d	CHF115	CHF215	CH315 h
20	(1) #14-8 b, (2) #14-10 bc, (1) #14-6 d	CHF120	CHF220	CH320 h
25	(1) #14-8 b, (2) #14-10 bc, (1) #14-6 d	CHF125	CHF225	CH325 h
30	(1) #14-8 b, (2) #14-10 bc, (1) #14-6 d	CHF130	CHF230	CH330 h
35	#14-2 b, #14-6 d	CHF135	CHF235	CH335 h
40	#10-1/0 e, #14-2 f, #3-0 g	CHF140	CHF240	CH340 h
45	#10-1/0 e, #14-2 f, #3-0 g	CHF145	CHF245	CH345 h
50	#10-1/0 e, #14-2 f, #3-0 g	CHF150	CHF250	CH350 h
60	#10-1/0 e, #14-2 f, #3-0 g	CH160	CH260	CH360 h
70	#10-1/0 e, #14-2 f, #3-0 g	CH170	CH270	CH370 h
80	#10-1/0 e, #14-2 f, #3-0 g	—	CH280	CH380
90	#10-1/0 e, #14-2 f, #3-0 g	—	CH290	CH390
100	#10-1/0 e, #14-2 f, #3-0 g	—	—	CH3100
110	#10-1/0 e, #14-2 f, #3-0 g	—	—	—
125	#10-1/0 e, #14-2 f, #3-0 g	—	—	—

Requires three ¾-inch (19.1 mm) spaces

^a Not for use in Type BR loadcentres i.e. CPM or CPL prefixed catalogue numbers.

^b For single- and two-pole breakers.

^c Solid and stranded wire can be used together.

^d For three-pole breakers.

^e Single-pole 60-70 A, two-pole 80-125 A, three-pole 40-100 A.

^f Single-pole 40-50 A, two-pole 40-70 A.

^g Two-pole 150 A.

^h HACR rated.

Type CH Twin Circuit Breakers ^{abc}

- 10,000 A interrupting capacity at 120/240 Vac
- Provides 2 single-pole circuits in one ¾-inch space

Table 31. Twin plug-in circuit breakers

Ampere rating	Wire size range (Cu/Al 60 °C or 75 °C) (AWG)	Catalogue number
		Single-pole, 120/240 Vac 10 per shelf carton
15-15	#14-8	CHT1515
15-20	#14-8	CHT1520
20-20	#14-8	CHT2020

Requires one ¾-inch (19.1 mm) space

^a Switching duty rated.

^b HACR rated.

^c Not for use in Type BR loadcentres i.e. CPM or CPL prefixed catalogue numbers.

Type CHP commercialType CHP commercial circuit breakers ^a

- 10,000 A interrupting capacity at 120 Vac, 120/240 Vac, and 240 Vac
- Three-position trip breakers for commercial applications when On-Off and Trip position is required

Table 32. Commercial plug-in circuit breakers

Ampere rating	Wire size range (Cu/Al 60 °C or 75 °C) (AWG)	Catalogue number		
		Single-pole 120/240 Vac 10 per shelf carton	Two-pole 120/240 Vac 5 per shelf carton	Three-pole 240 Vac 5 per shelf carton
10	(1) #14-8 b, (2) #14-10 bc, (1) #14-6 d	CHP110	—	CHP310
15	(1) #14-8 b, (2) #14-10 bc, (1) #14-6 d	CHP115 gh	CHP215 h	CHP315 h
20	(1) #14-8 b, (2) #14-10 bc, (1) #14-6 d	CHP120 gh	CHP220 h	CHP320 h
25	(1) #14-8 b, (2) #14-10 bc, (1) #14-6 d	CHP125 h	CHP225 h	CHP325 h
30	(1) #14-8 b, (2) #14-10 bc, (1) #14-6 d	CHP130 h	CHP230 h	CHP330 h
35	#14-2 b, #14-6 d	CHP135 h	CHP235 h	CHP335 h
40	#10-1/0 e, #14-2 f	CHP140 h	CHP240 h	CHP340 h
45	#10-1/0 e, #14-2 f	CHP145 h	CHP245 h	CHP345 h
50	#10-1/0 e, #14-2 f	CHP150 h	CHP250 h	CHP350 h
60	#10-1/0 e, #14-2 f	— h	CHP260 h	CHP360 h
70	#10-1/0 e, #14-2 f	—	CHP270	CHP370
80	#10-1/0 e, #14-2 f	—	CHP280	—
90	#10-1/0 e, #14-2 f	—	CHP290	—
100	#10-1/0 e, #14-2 f	—	CHP2100	CHP3100
110	#10-1/0 e, #14-2 f	—	—	—
125	#10-1/0 e, #14-2 f	—	CHP2125	—
		Requires one ¾-inch (19.1 mm) space	Requires two ¾-inch (19.1 mm) spaces	Requires three ¾-inch (19.1 mm) spaces

^a Not for use in Type BR loadcentres i.e. CPM or CPL prefixed catalogue numbers.

^b For single- and two-pole breakers.

^c Solid and stranded wire can be used together.

^d For three-pole breakers.

^e Single-pole 60-70 A, two-pole 80-125 A, three-pole 40-100 A.

^f Single-pole 40-50 A, two-pole 40-70 A.

^g Switching duty rated.

^h HACR rated.

Type CH arc fault circuit interrupter

Type CH arc fault circuit interrupter circuit breakers ^a

- 10,000 A interrupting capacity at 120 Vac, and 120/240 Vac
- Plug-on neutral style for plug-on neutral type CH loadcentres

A combination type arc fault circuit interrupter is a device intended to mitigate series and parallel arcing faults in the complete circuit, including connected cords. Parallel arcing faults can occur from line to neutral or line to ground. These arcing faults are in parallel with the load and produce the most energy of all arcing faults.

Table 33. Single- and two-pole plug-in FIRE-GUARDE AFCI circuit breakers

Ampere rating	Wire size range (Cu/Al 60 °C or 75 °C) (AWG)	Configuration	Catalogue number	
			Single-pole, 120/240 Vac 10 per shelf carton 10 kAIC	Two-pole, 120/240 Vac 5 per shelf carton 10 kAIC ^{bc}
15	#14-4	Standard	CHFCAF115	—
15	#14-4	Common trip	—	CH215CAF
15	#14-4	Plug-on neutral ^d	CHFCAF115PN	—
20	#14-4	Standard	CHFCAF120	—
20	#14-4	Common trip	—	CH220CAF
20	#14-4	Plug-on neutral ^d	CHFCAF120PN	—
			Requires one ¾-inch (19.1 mm) space	Requires two ¾-inch (19.1 mm) spaces

- ^a Not for use in Type BR loadcentres i.e. CPM or CPL prefixed catalogue numbers.
- ^b Common trip refers to two-pole 240 V load application sourced by 120/240 Vac (see **Figure 17**).
- ^c Independent trip refers to two-pole multi-wire, home run or shared neutral circuits (see **Figure 16** and **Figure 18**).
- ^d Only for use in the Type CH plug-on neutral style of combination and non-combination loadcentres.

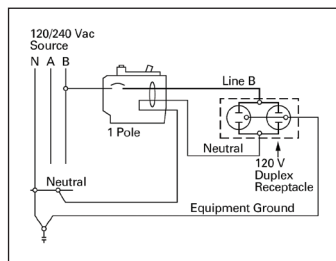

Figure 15. Single-pole, single 120 V load application sourced by 120/240 Vac

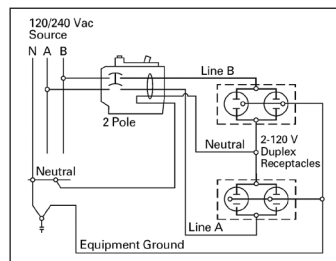

Figure 16. Two-pole, shared neutral with multi-duplex receptacle application

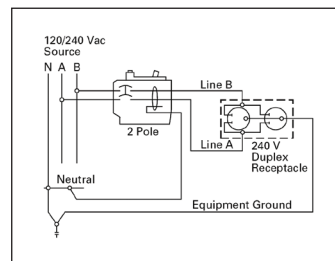

Figure 17. Two-pole, 240 V load application sourced by 120/240 Vac

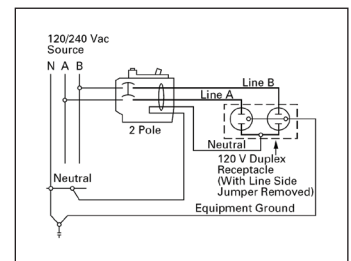
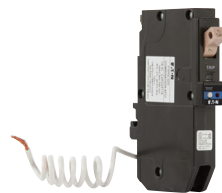

Figure 18. Two-pole, shared neutral with duplex receptacle application



Type CH single-pole AFCI circuit breaker



Type CH single-pole dual-purpose AFGF breaker

Table 34. Single-pole plug-in dual purpose AF/GF circuit breakers

Ampere rating	Wire size range (Cu/Al 60 °C or 75 °C) (AWG)	Configuration	Catalogue number
			Single-pole 120/240 Vac 10 per shelf carton 10 kAIC
15	#14-4	Standard	CHFAGF115
15	#14-4	Plug-on neutral ^a	CHFAGF115PN
20	#14-4	Standard	CHFAGF120
20	#14-4	Plug-on neutral ^a	CHFAGF120PN
Combination AFCI and 5 mA people protection ground fault			Requires one ¾-inch (19.1 mm) space

- ^a Only for use in the Type CH plug-on neutral style of combination and non-combination loadcentres.

Type CH ground fault

Type CH ground fault circuit breakers ^a

- 10,000 A interrupting capacity at 120 Vac and 120/240 Vac
- 5 mA “people protection” or 30 mA equipment protectors
- Two-pole version features common trip

Table 35. 5 mA single- and two-pole plug-in ground fault circuit breakers

Ampere rating	Wire size range Cu/Al 60 °C or 75 °C (AWG)	Catalogue number		
		Single-pole, 120 Vac Standard 1 per shelf carton 10 kAIC	Single-pole, 120 Vac Plug-on neutral ^b 1 per shelf carton 10 kAIC	Two-pole 120/240 Vac Standard 1 per shelf carton 10 kAIC
15	#14–6 ^c	CHFGFT115	CHFGFT115PN ^b	CH215GFT
20	#14–6 ^c	CHFGFT120	CHFGFT120PN ^b	CH220GFT
25	#14–6 ^c	CHFGFT125	—	CH225GFT
30	#14–6 ^c	CHFGFT130	CHFGFT130PN	CH230GFT
35	#14–6 ^c	—	—	CH235GFT
40	#14–6 ^c	—	—	CH240GFT
45	#14–6 ^c	—	—	CH245GFT
50	#14–6 ^c	—	—	CH250GFT
60	#14–6 ^c	—	—	CH260GFT
		Requires one ¾-inch (19.1 mm) space		Requires two ¾-inch (19.1 mm) spaces

^a Not for use in Type BR loadcentres i.e. CPM or CPL prefixed catalogue numbers.
^b Only for use in the Type CH plug-on neutral style of combination and non-combination loadcentres.
^c 60 A breaker listed for 75 °C Cu wire only.

Table 36. 30 mA single- and two-pole plug-in ground fault circuit breaker equipment protectors

Ampere rating	Wire size range Cu/Al 60 °C or 75 °C (AWG)	Catalogue number	
		Single-pole, 120 Vac 1 per shelf carton 10 kAIC	Two-pole, 120/240 Vac 1 per shelf carton 10 kAIC
15	#14–6 ^a	CHFEP115	CH215EPD
20	#14–6 ^a	CHFEP120	CH220EPD
25	#14–6 ^a	CHFEP125	—
30	#14–6 ^a	CHFEP130	CH230EPD
40	#14–6 ^a	—	CH240EPD
50	#14–6 ^a	—	CH250EPD
60	#14–6 ^a	—	CH260EPD
		Requires one ¾-inch (19.1 mm) space	Requires two ¾-inch (19.1 mm) spaces

^a 60 A breaker listed for 75 °C Cu wire only.

Ground fault application

Single-pole ground fault circuit breakers (Type CHGFIs) are designed for use in two-wire, 120 Vac circuits. **Figure 19** shows a typical wiring configuration. Two-pole ground fault circuit breakers (Type CHGFIs) are designed for use in three-wire, 120/240 Vac circuits, 120 Vac multi-wire circuits employing common, neutral and two-wire, 240 Vac circuits obtained from a 120/240 Vac source. **Figure 20** and **Figure 21** illustrate typical wiring configurations for 120/240 Vac multi-wire circuits. **Figure 22** depicts a 240 Vac, two-wire circuit. Note the “panel neutral” conductor connects to the neutral bar, even though the neutral is not included in the load circuit. This connection is necessary to supply a 120 Vac power source to the ground fault sensing circuit. The figures are shown with a 120/240 Vac, single-phase, three-wire power source, but are also applicable to a 120/208 Vac, three-phase, four-wire power supply. For all figures the electrical operation of the Type CHGFI is not affected by the equipment ground.



Type CH two-pole GFCI circuit breaker

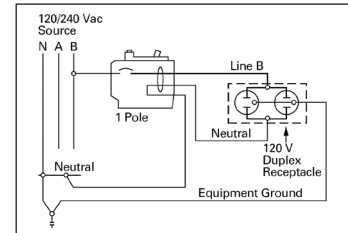

Figure 19. Single-pole single 120 V duplex receptacle application

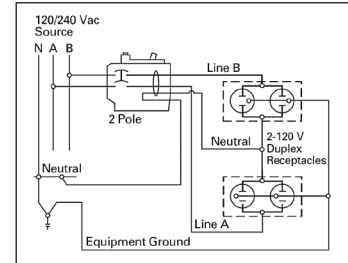

Figure 20. Two-pole 120 V multi-duplex receptacle application

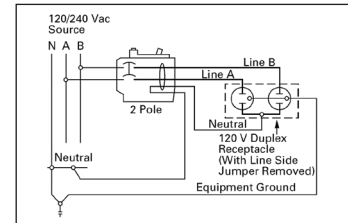

Figure 21. Two-pole 120 V duplex receptacle application

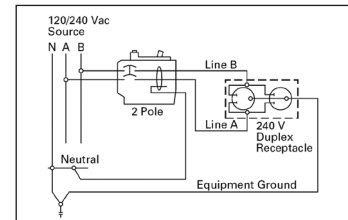

Figure 22. Two-pole 240 V duplex receptacle application

Plug-in loadcentre main circuit breakers for CH

Type CSR

Type CSR loadcentre main circuit breaker kit

- 25,000 A interrupting capacity at 120/240 Vac



CSR2150N

Product selection

Table 37. Two-pole main circuit breakers for single-phase plug-in combination loadcentres

Ampere rating	Wire size range Cu/Al 60 °C or 75 °C	Catalogue number
		Two-pole, 120/240 Vac 1 per shelf carton 25 kAIC
100	#2 AWG–300 kcmil	CSR2100N
125	#2 AWG–300 kcmil	CSR2125N
150	#2 AWG–300 kcmil	CSR2150N
200	#2 AWG–300 kcmil	CSR2200N

Plug-in loadcentres and circuit breaker accessories for CH

Type CH accessories

Plug-in loadcentre and circuit breaker accessories for CH

Product selection

Table 38. Field installation kits and parts for plug-in loadcentres and circuit breakers

Description	Ordering quantity ^a	Catalogue number
Handle tie for single-pole Type CH circuit breakers. Joins handles on breakers mounted adjacent to each other via a moulded plastic handle cover.	1	CHHT
Handle lockoff (escutcheon mounted). Single- or two-pole Type CH circuit breakers.	1	CHPL
Handle lockoff (escutcheon mounted). Single- or two-pole Type CHGFI circuit breakers.	1	CHPLGF
Handle lockoff (escutcheon mounted). Locks the handle of main circuit breaker type CSH in the OFF or ON position.	1	MCBPL
Handle lockdog (handle mounted). Single-pole Type CH circuit breakers. Secures handle in the ON or OFF position.	1	CHLO
Subfeed kit for 125 A loadcentres. Requires two 3/4-inch (19.1 mm) spaces.	1	CHSF2125
3/4-inch (19.1 mm) filler plate kit ^a	1	CHFP ^a
Door lock for 24–60 circuit 100 and 200 A (CH)	1	TDL ^b
Trim screw kit (CH)	1	LCSS ^c
Sandalwood plastic replacement door latch	1	CHRLS
Branch circuit numbering strip kit for CH	1	CHMS ^d
Electronic breaker lockoff (escutcheon mounted) for type CHFCAF and CHFAGF		CHFAGFLOFF

^a Kit includes 25 pieces.

^b Comes with a set of keys.

^c Kit includes 25 pieces.

^d Kit includes 20 pieces.

Definitions

Handle ties: Devices used to join two similar independent single-pole circuit breakers to form a two-pole non-common trip breaker.

Handle lockoffs: Devices that use a padlock to lock a circuit breaker's handle in either the ON or OFF position.

Handle lockdogs: Devices used to secure a circuit breaker's handle in the ON or OFF position. They are not padlockable devices.

Escutcheon mounted: A semipermanent mounting to the face of the circuit breaker and secured by the loadcentre's deadfront cover.

Handle mounted: A mounting made directly to the handle of the circuit breaker by means of a set screw.

Screw mounted: A permanent mounting to the face of the circuit breaker by means of a non-removable screw.

Type CBM bolt-on loadcentres

Combination Service Entrance (main circuit breaker) single- and three-phase aluminum bus

Single-phase 120/240 Vac Type 1 (indoor) loadcentres combination service entrance

- CSA certified only (not UL approved)
- Utilize Type BAB, QBHW, QBA, DNBA, or QBGF circuit breakers as branch circuit breakers



3CBM242

Product selection

Table 39. Single-phase, three-wire 120/240 Vac aluminum bus loadcentres

Maximum ampere rating	Main breaker rating	Max. no. 1-inch spaces	Max. no. 1/2-inch spaces	Cover style	Dimensions in inches (mm)			Wire size range for main Cu/Al	Catalogue number
					H	W	D		
125	100	18	36	Flush/surface	27.00 (685.8)	14.25 (361.9)	3.75 (95.3)	#8-#1 Cu / #8-1/0 Al	CBM118 ^a
125	100	30	60	Flush/surface	34.13 (866.8)	14.25 (361.9)	3.75 (95.3)	#8-#1 Cu / #8-1/0 Al	CBM130 ^a
125	100	42	84	Flush/surface	39.00 (990.6)	14.25 (361.9)	3.75 (95.3)	#8-#1 Cu / #8-1/0 Al	CBM142 ^a
225	200	18	36	Flush/surface	34.13 (866.8)	14.25 (361.9)	3.75 (95.3)	#4-4/0	CBM218 ^b
225	200	30	60	Flush/surface	39.00 (990.6)	14.25 (361.9)	3.75 (95.3)	#4-4/0	CBM230 ^b
225	200	42	84	Flush/surface	45.00 (1143.0)	14.25 (361.9)	3.75 (95.3)	#4-4/0	CBM242 ^b

^a BAB2100 main circuit breaker factory installed.

^b ED2200 main circuit breaker factory installed.

Three-phase Combination service entrance 240 Vac Type 1 (indoor) loadcentres

- CSA certified only (not UL approved)
- Utilize Type BAB, QBHW, QBA, DNBA, or QBGF circuit breakers as branch circuit breakers

Table 40. Three-phase, four-wire 240 Vac maximum aluminum bus loadcentres

Maximum ampere rating	Main breaker rating	Max. no. 1-inch spaces	Max. no. 1/2-inch spaces	Cover style	Dimensions in inches (mm)			Wire size range for main Cu/Al	Catalogue number
					H	W	D		
125	100	18	36	Flush/surface	27.00 (685.8)	14.25 (361.9)	3.75 (95.3)	#8-#1 Cu / #8-1/0 Al	3CBM118 ^a
125	100	30	60	Flush/surface	34.13 (866.8)	14.25 (361.9)	3.75 (95.3)	#8-#1 Cu / #8-1/0 Al	3CBM130 ^a
125	100	42	84	Flush/surface	39.00 (990.6)	14.25 (361.9)	3.75 (95.3)	#8-#1 Cu / #8-1/0 Al	3CBM142 ^a
225	200	18	36	Flush/surface	34.13 (866.8)	14.25 (361.9)	3.75 (95.3)	#4-4/0	3CBM218 ^b
225	200	30	60	Flush/surface	39.00 (990.6)	14.25 (361.9)	3.75 (95.3)	#4-4/0	3CBM230 ^b
225	200	42	84	Flush/surface	45.00 (1143.0)	14.25 (361.9)	3.75 (95.3)	#4-4/0	3CBM242 ^b

^a BAB3100H main circuit breaker factory installed.

^b ED3200 main circuit breaker factory installed.

Effective December 2017

Combination (main circuit breaker) single- and three-phase copper bus

Single-phase 120/240 Vac Type 1 (indoor) loadcentres combination service entrance

- CSA certified only (not UL approved)
- Utilize Type BAB, QBHW, QBA, DNBA, or QBGF circuit breakers as branch circuit breakers

Table 41. Single-phase, three-wire 120/240 Vac copper bus loadcentres

Maximum ampere rating	Main breaker rating	Max. no. 1-inch spaces	Max. no. 1/2-inch spaces	Cover style	Dimensions in inches (mm)			Wire size range for main Cu/Al	Catalogue number
					H	W	D		
125	100	18	36	Flush/surface	27.00 (685.8)	14.25 (361.9)	3.75 (95.3)	#8-#1 Cu / #8-1/0 Al	CBM118CU ^a
125	100	30	60	Flush/surface	34.13 (866.8)	14.25 (361.9)	3.75 (95.3)	#8-#1 Cu / #8-1/0 Al	CBM130CU ^a
125	100	42	84	Flush/surface	39.00 (990.6)	14.25 (361.9)	3.75 (95.3)	#8-#1 Cu / #8-1/0 Al	CBM142CU ^a
225	200	18	36	Flush/surface	34.13 (866.8)	14.25 (361.9)	3.75 (95.3)	#4-4/0	CBM218CU ^b
225	200	30	60	Flush/surface	39.00 (990.6)	14.25 (361.9)	3.75 (95.3)	#4-4/0	CBM230CU ^b

^a BAB2100 main circuit breaker factory installed.^b ED2200 main circuit breaker factory installed.

Three-phase combination service entrance 240 Vac Type 1 (indoor) loadcentres

- CSA certified only (not UL approved)
- Utilize Type BAB, QBHW, QBA, DNBA, or QBGFT circuit breakers as branch circuit breakers

Table 42. Three-phase, four-wire 240 Vac maximum copper bus loadcentres

Maximum ampere rating	Main breaker rating	Max. no. 1-inch spaces	Max. no. 1/2-inch spaces	Cover style	Dimensions in inches (mm)			Wire size range for main Cu/Al	Catalogue number
					H	W	D		
125	100	18	36	Flush/surface	27.00 (685.8)	14.25 (361.9)	3.75 (95.3)	#8-#1 Cu / #8-1/0 Al	3CBM118CU ^a
125	100	30	60	Flush/surface	34.13 (866.8)	14.25 (361.9)	3.75 (95.3)	#8-#1 Cu / #8-1/0 Al	3CBM130CU ^a
125	100	42	84	Flush/surface	39.00 (990.6)	14.25 (361.9)	3.75 (95.3)	#8-#1 Cu / #8-1/0 Al	3CBM142CU ^a
225	200	30	60	Flush/surface	39.00 (990.6)	14.25 (361.9)	3.75 (95.3)	#4-4/0	3CBM230CU ^b

^a BAB3100H main circuit breaker factory installed.^b ED3200 main circuit breaker factory installed.

Non-combination (main lug only) single- and three-phase aluminum bus

Single-phase 120/240 Vac Type 1 (indoor) loadcentres

- CSA certified only (not UL approved)
- Utilize Type BAB, QBHW, QBA, DNBA, or QBGF circuit breakers as branch circuit breakers



CBL130

Table 43. Single-phase, three-wire 120/240 Vac aluminum bus loadcentres

Maximum ampere rating	Max. no. 1-inch spaces	Max. no. 1/2-inch spaces	Cover style	Dimensions in inches (mm)			Wire size range for main Cu/Al	Catalogue number
				H	W	D		
125	18	36	Flush/surface	27.00 (685.8)	14.25 (361.9)	3.75 (95.3)	#6–300 MCM	CBL118
125	30	60	Flush/surface	34.13 (866.8)	14.25 (361.9)	3.75 (95.3)	#6–300 MCM	CBL130
125	42	84	Flush/surface	39.00 (990.6)	14.25 (361.9)	3.75 (95.3)	#6–300 MCM	CBL142
225	18	36	Flush/surface	27.00 (685.8)	14.25 (361.9)	3.75 (95.3)	#6–300 MCM	CBL218
225	30	60	Flush/surface	34.13 (866.8)	14.25 (361.9)	3.75 (95.3)	#6–300 MCM	CBL230
225	42	84	Flush/surface	39.00 (990.6)	14.25 (361.9)	3.75 (95.3)	#6–300 MCM	CBL242

Three-phase 240 Vac Type 1 (indoor) loadcentres

- CSA certified only (not UL approved)
- Utilize Type BAB, QBHW, QBA, DNBA, or QBGF circuit breakers as branch circuit breakers

Table 44. Three-phase, four-wire 240 Vac aluminum bus loadcentres

Maximum ampere rating	Max. no. 1-inch spaces	Max. no. 1/2-inch spaces	Cover style	Dimensions in inches (mm)			Wire size range for main Cu/Al	Catalogue number
				H	W	D		
125	18	36	Flush/surface	27.00 (685.8)	14.25 (361.9)	3.75 (95.3)	#6–300 MCM	3CBL118
125	30	60	Flush/surface	34.13 (866.8)	14.25 (361.9)	3.75 (95.3)	#6–300 MCM	3CBL130
125	42	84	Flush/surface	39.00 (990.6)	14.25 (361.9)	3.75 (95.3)	#6–300 MCM	3CBL142
225	18	36	Flush/surface	27.00 (685.8)	14.25 (361.9)	3.75 (95.3)	#6–300 MCM	3CBL218
225	30	60	Flush/surface	34.13 (866.8)	14.25 (361.9)	3.75 (95.3)	#6–300 MCM	3CBL230
225	42	84	Flush/surface	39.00 (990.6)	14.25 (361.9)	3.75 (95.3)	#6–300 MCM	3CBL242

Non-combination (main lug only) single- and three-phase copper bus

Single-phase 120/240 Vac Type 1 (indoor) loadcentres

- CSA certified only (not UL approved)
- Utilize Type BAB, QBHW, QBA, DNBA, or QBGF circuit breakers as branch circuit breakers

Table 45. Single-phase, three-wire 120/240 Vac copper bus loadcentres

Maximum ampere rating	Max. no. 1-inch spaces	Max. no. 1/2-inches spaces	Cover style	Dimensions in inches (mm)			Wire size range for main Cu/Al	Catalogue number
				H	W	D		
125	18	36	Flush/surface	27.00 (685.8)	14.25 (361.9)	3.75 (95.3)	#6–300 MCM	CBL118CU
125	30	60	Flush/surface	34.13 (866.8)	14.25 (361.9)	3.75 (95.3)	#6–300 MCM	CBL130CU
125	42	84	Flush/surface	39.00 (990.6)	14.25 (361.9)	3.75 (95.3)	#6–300 MCM	CBL142CU
225	18	36	Flush/surface	27.00 (685.8)	14.25 (361.9)	3.75 (95.3)	#6–300 MCM	CBL218CU
225	30	60	Flush/surface	34.13 (866.8)	14.25 (361.9)	3.75 (95.3)	#6–300 MCM	CBL230CU
225	42	84	Flush/surface	39.00 (990.6)	14.25 (361.9)	3.75 (95.3)	#6–300 MCM	CBL242CU

Three-phase 240 Vac Type 1 (indoor) loadcentres

- CSA certified only (not UL approved)
- Utilize Type BAB, QBHW, QBA, DNBA, or QBGF circuit breakers as branch circuit breakers

Table 46. Three-phase, four-wire 240 Vac copper bus loadcentres

Maximum ampere rating	Max. no. 1-inch spaces	Max. no. 1/2-inches spaces	Cover style	Dimensions in inches (mm)			Wire size range for main Cu/Al	Catalogue number
				H	W	D		
125	18	36	Flush/surface	27.00 (685.8)	14.25 (361.9)	3.75 (95.3)	#6–300 MCM	3CBL118CU
125	30	60	Flush/surface	34.13 (866.8)	14.25 (361.9)	3.75 (95.3)	#6–300 MCM	3CBL130CU
125	42	84	Flush/surface	39.00 (990.6)	14.25 (361.9)	3.75 (95.3)	#6–300 MCM	3CBL142CU
225	30	60	Flush/surface	34.13 (866.8)	14.25 (361.9)	3.75 (95.3)	#6–300 MCM	3CBL230CU
225	42	84	Flush/surface	39.00 (990.6)	14.25 (361.9)	3.75 (95.3)	#6–300 MCM	3CBL242CU

Bolt-on circuit breakers for CBM/CBL

Type BAB and QBHW single- and multi-pole

Type BAB and QBHW

- 10,000/22,000 A interrupting capacity at 120 Vac, 120/240 Vac, and 240 Vac

Product selection

Table 47. Single- and multi-pole bolt-on circuit breakers

Ampere rating	Wire size range (Cu/Al 60 °C or 75 °C) (AWG)	Catalogue number					
		Single-pole, 120/240 Vac		Two-pole, 120/240 Vac		Three-pole, 120/240 Vac	
		10 kAIC	22 kAIC	10 kAIC	22 kAIC	10 kAIC	22 kAIC
10	#14-4	BAB1010	—	—	—	—	—
15	#14-4	BAB1015	QBHW1015	BAB2015	QBHW2015	BAB3015H	QBHW3015
20	#14-4	BAB1020	QBHW1020	BAB2020	QBHW2020	BAB3020H	QBHW3020
25	#14-4	BAB1025	—	—	—	—	—
30	#14-4	BAB1030	QBHW1030	BAB2030	QBHW2030	BAB3030H	QBHW3030
40	#14-4	BAB1040	QBHW1040	BAB2040	QBHW2040	BAB3040H	QBHW3040
50	#14-4	BAB1050	QBHW1050	BAB2050	QBHW2050	BAB3050H	QBHW3050
60	#8-1 Cu, #8-1/0 Al	BAB1060	QBHW1060	BAB2060	QBHW2060	BAB3060H	QBHW3060
70	#8-1 Cu, #8-1/0 Al	BAB1070	QBHW1070	BAB2070	QBHW2070	BAB3070H	QBHW3070
90	#8-1 Cu, #8-1/0 Al	—	—	BAB2090	QBHW2090	BAB3090H	QBHW3090
100	#8-1 Cu, #8-1/0 Al	—	—	BAB2100	QBHW2100	BAB3100H	QBHW3100
125	#8-1 Cu, #8-1/0 Al	—	—	BAB2125	QBHW2125	—	—
			Requires one 1-inch (25.4 mm) space		Requires two 1-inch (25.4 mm) spaces		Requires three 1-inch (25.4 mm) spaces

Type BAB high intensity discharge (HID) rated

- 10,000 A interrupting capacity at 120 Vac, 120/240 Vac, and 240 Vac

Table 48. Single-pole HID rated bolt-on circuit breakers

Ampere rating	Wire size range (Cu/Al 60 °C or 75 °C) (AWG)	Catalogue number
		Single-pole, 120/240 Vac 10 kAIC
15	#14-4	BAB1015D
20	#14-4	BAB1020D
Requires one 1-inch (25.4 mm) space		

Table 49. Single-pole bolt-on fire alarm breakers

Ampere rating	Configuration	Catalogue number
		Single-pole, 120/240 Vac 10 per shelf carton 10 kAIC
15	Branch fire alarm	BABF1015
20	Branch fire alarm	BABF1020
	Compact body breaker	Requires one 1-inch (25.4 mm) space

Type QBA arc fault circuit interrupter and DNBA duplex

Type QBA Arc fault circuit interrupter circuit breakers

- 10,000/22,000 A interrupting capacity at 120 Vac 120/240 Vac, and 240 Vac

Table 50. Single- and two-pole bolt-on FIRE-GUARD AFCI circuit breakers

Ampere rating	Configuration	Catalogue number				Wire size range (Cu/Al 60 °C or 75 °C) (AWG)
		Single-pole 120/240 Vac		Two-pole, 120/240 Vac ^{ab}		
		10 kAIC	22 kAIC	10 kAIC	22 kAIC	
15	Standard	QBAF1015	QBHAF1015	—	—	#14–4
15	Combination	QBCAF1015	QBHCAF1015	—	—	#14–4
15	Dual With GFCI 5mA	QB1015AFGF	QBH1015AFGF	—	—	#14–4
15	Common trip	—	—	QBAF2015	QBHAF2015	#14–4
15	Independent trip	—	—	QBAF2015IT	QBHAF2015IT	#14–4
20	Standard	QBAF1020	QBHAF1020	—	—	#14–4
20	Combination	QBCAF1020	QBHCAF1020	—	—	#14–4
20	Dual With GFCI 5mA	QB1020AFGF	QBH1020AFGF	—	—	#14–4
		Requires one 1-inch (25.4 mm) space	Requires one 1-inch (25.4 mm) space	Requires two 1-inch (25.4 mm) spaces	Requires two 1-inch (25.4 mm) spaces	

a Common trip refers to two-pole 240 V load application sourced by 120/240 Vac (see **Figure 25**).

b Independent trip refers to two-pole multi-wire, home run or shared neutral circuits (see **Figure 24** and **Figure 26**).

Type DNBA duplex circuit breakers

- 10,000 A interrupting capacity at 120/240 Vac
- Provides 2 single-pole circuits in one 1-inch space

Table 51. Twin plug-in circuit breakers

Ampere rating	Wire size range (Cu/Al 60 °C or 75 °C) (AWG)	Catalogue number
		Single-pole, 120/240 Vac 10 per shelf carton
15–15	#14–4	DNBA1515
20–20	#14–4	DNBA2020
30–30	#14–4	DNBA3030
Requires one 1-inch (25.4 mm) space		

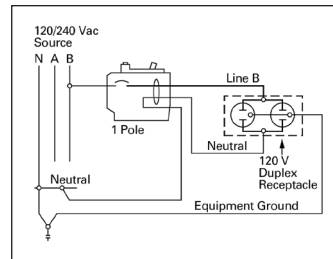

Figure 23. Single-pole, single 120 V load application sourced by 120/240 Vac

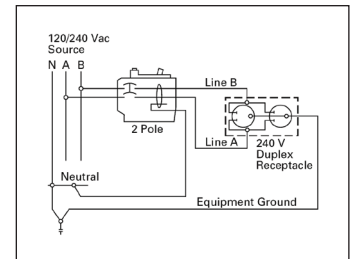

Figure 25. Two-pole, 240 V load application sourced by 120/240 Vac

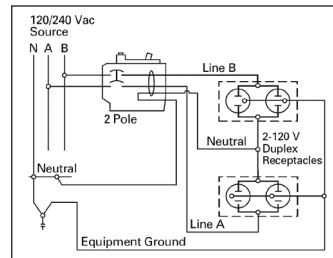

Figure 24. Two-pole, shared neutral with multi-duplex receptacle application

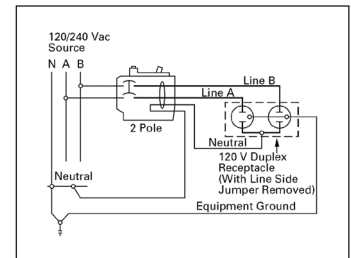

Figure 26. Two-pole, shared neutral with duplex receptacle application

Type QBGF and QBGFEP ground fault

Type QBGF and QBGFEP ground fault circuit breakers

- 10,000/22,000 A interrupting capacity at 120 Vac and 120/240 Vac
- 5 mA “people protection” or 30 mA equipment protectors
- Two-pole version features common trip

Table 52. 5 mA single- and two-pole bolt-on ground fault circuit breakers

Ampere rating	Wire size range Cu/Al 60 °C or 75 °C (AWG)	Catalogue number	
		Single-pole, 120 Vac 1 per shelf carton 10 kAIC	Two-pole, 120/240 Vac 1 per shelf carton 10 kAIC
15	#14–10 Cu, #12–10 Al	QBGFT1015	QBGFT2015
20	#14–10 Cu, #12–10 Al	QBGFT1020	QBGFT2020
30	#10 Cu, #8 Al	QBGFT1030	QBGFT2030
40	#8 Cu, #8–6 Al	QBGFT1040	QBGFT2040
50	#8–6 Cu, #6–4 Al	—	QBGFT2050
		Requires one 1-inch (25.4 mm) space	Requires two 1-inch (25.4 mm) spaces

Table 53. 30 mA single- and two-pole bolt-on ground fault circuit breaker equipment protectors

Ampere rating	Wire size range Cu/Al 60 °C or 75 °C (AWG)	Catalogue number			
		Single-pole, 120 Vac 1 per shelf carton 10 kAIC		Two-pole, 120/240 Vac 1 per shelf carton	
		10 kAIC	22 kAIC	10 kAIC	22 kAIC
15	#14–4	QBGFEP1015	QBHGFEP1015	QBGFEP2015	QBHGFEP2015
20	#14–4	QBGFEP1020	QBHGFEP1020	QBGFEP2020	QBHGFEP2020
25	#14–4	QBGFEP1025	QBHGFEP1025	QBGFEP2025	QBHGFEP2025
30	#14–4	QBGFEP1030	QBHGFEP1030	QBGFEP2030	QBHGFEP2030
		Requires one 1-inch (25.4 mm) space	Requires one 1-inch (25.4 mm) space	Requires two 1-inch (25.4 mm) spaces	Requires two 1-inch (25.4 mm) spaces

Bolt-on loadcentre and circuit breaker accessories

Bolt-on accessories

Table 54. Field installation kits and parts for bolt-on loadcentres and circuit breakers

Description	Ordering quantity	Catalogue number
Handle lockoff single-pole of Type DNBA duplex circuit breakers (package of 10)	1	BRDL1-10
Handle lockoff Type BQL circuit breakers	1	BQL-10
Handle lockoff Type BAB and QBHW circuit breakers	1	QL123PL
Handle lockdog single-pole Type BAB and QBHW circuit breakers	1	QL1NPL
Handle lockdog two- and three-pole Type BAB and QBHW circuit breakers	1	QL23NPL
Filler plates 1-inch space (package of 24)	1	BRFP
Subfeed lug 100 A (for main lug panel style)	1	CBSF100
Subfeed lug 225 A (for main lug panel style)	1	CBSF225
Subfeed lug kit 100 A three-phase (for main lug panel style)	1	3CBSF100
Subfeed lug kit 225 A three-phase (for main lug panel style)	1	3CBSF225
Circuit breaker directory card 1–42 (package of 50)	1	DIRCARD42
Circuit breaker directory sleeve (package of 25)	1	DIRSLEEVE
Loadcentre door lock	1	TDL
Isolated ground kit	1	ISGRD

Definitions

Handle lockoffs: Devices that use a padlock to lock a circuit breaker's handle in either the ON or OFF position.

Handle lockdogs: Devices used to secure a circuit breaker's handle in the ON or OFF position. They are not padlockable devices.

Manual transfer switches/generator panels

Product description

A transfer switch panel is a device that is mounted next to or incorporated within the loadcentre (distribution panel) in the home or small business. The transfer switch panel is used in conjunction with an emergency generator (usually supplied by others) and serves the purpose of turning selected circuits on and off during a power outage. The transfer switch panel allows the owner to start up a generator and then restore power to critical circuits when utility power is not available.

The owner designates which circuits are critical such as their refrigerator, furnace, and certain lighting loads. Sometimes called emergency power panels, emergency generator panels, gen. panels, transfer switches or emergency panels; transfer switch panels provide the homeowner or small business owner with a safe and easy way to continue using essential electrical loads when utility power is not available.

Application description

Transfer switch panels are most often used in residential, agricultural and light commercial applications. Comfort and safety are key concerns of many homeowners who are dependent on an uninterrupted supply of electricity.

The increase in our dependence on power is due in part to the popularity of home business and in-home care. In addition, various rural and urban regions in North America experience periodic power outages due to extreme weather conditions such as ice and snowstorms, heat waves, tornadoes or hurricanes. Regions such as Pacific, Atlantic, and Central are the strongest markets for portable generators and transfer switch panels.

Features, functions, and benefits

Eaton offers two unique manual transfer switch emergency power solutions.

- Manual transfer switches or a generator sub-panel
- Combination service entrance loadcentre with generator sub-panel

IMPORTANT

BEFORE INSTALLATION, CONSULT APPROPRIATE ELECTRICAL CODES. INSTALLATION INFORMATION IS INCLUDED IN THE CARTON.

Manual transfer switches/generator panels

- Main utility and emergency (generator) breaker factory installed
- Available in 30 and 60 A design
- Utility breaker and generator breakers are mechanically interlocked to protect equipment and personnel by preventing dangerous dual-source feeding
- Critical loads permanently connected to allow for quick and convenient switching from utility power to stand-by generator power
- Designed for switched neutral applications. Can be reconfigured in field for non-switched neutral applications
- Sturdy and reliable 125 A rated aluminum bus design
- Type BR/DNPL branch breakers sold separately
- Ideal for new and retrofit installations
- EEMAC 1 indoor enclosure design
- Standards and certifications
- CSA approved

Product specifications

- 10,000 AIC rating
- Switching devices must be circuit breakers
- Transfer switch panel must be supplied with neutral and ground



Combination service entrance loadcentre generator panel CPM126GEN

- Single enclosure (EEMAC 1) to house both loadcentre and generator breakers
- Factory installed main breakers
- Available in 100 and 200 A designs
- Utility and emergency transfer switch breaker factory installed
- Utility breaker and generator breakers are mechanically interlocked to protect equipment and personnel by preventing dangerous dual-source feeding
- Critical loads permanently connected to allow for quick and convenient switching from utility power to stand-by generator power
- Designed for switched neutral applications. Can be reconfigured in field for non-switched neutral applications
- Type BR/DNPL branch breakers sold separately
- Ideal for new and retrofit installations
- EEMAC 1 indoor enclosure design

Standards and certifications

- CSA approved

Product specifications

- 10,000 AIC rating for CPM126GEN
- 25,000 AIC rating for CPM236GEN
- Switching devices must be circuit breakers
- Transfer switch panel must be supplied with neutral and ground

Product selection

Table 55. Manual transfer switches/generator panels

Bus rating (A)	Generator breaker (A)	Switched neutral	Enclosure rating	Max. total branch circuits (1-inch/½-inch)	Inlet receptacle type	Height branch circuits in inches (mm)	Width in inches (mm)	Depth in inches (mm)	Catalogue number
125	30	Yes	EEMAC 1	6/12	—	16.75 (425.5)	14.38 (365.1)	3.88 (98.4)	CPL112G3
125	60	Yes	EEMAC 1	6/12	—	16.75 (425.5)	14.38 (365.1)	3.88 (98.4)	CPL112G6
125	60	Yes	EEMAC 1	14/28	—	21.00 (533.4)	14.38 (365.1)	3.88 (98.4)	CPL120G6
125	60	Yes	EEMAC 1	24/48	—	29.13 (739.8)	14.38 (365.1)	3.88 (98.4)	CPL130G6

Table 56. Combination service entrance loadcentre generator panel

Bus rating (A)	Loadcentre main breaker (A)	Max. total branch circuits (1-inch/½-inch)	Generator breaker (A)	Switched neutral	Max. generator branch circuits	Height in inches (mm)	Width in inches (mm)	Depth in inches (mm)	Catalogue number
125	100	26/52	30	Yes	6/12	39.00 (990.6)	14.38 (365.1)	3.88 (98.4)	CPM126GEN
200	200	36/72	60	Yes	6/12	45.00 (1143.0)	14.38 (365.1)	3.88 (98.4)	CPM236GEN

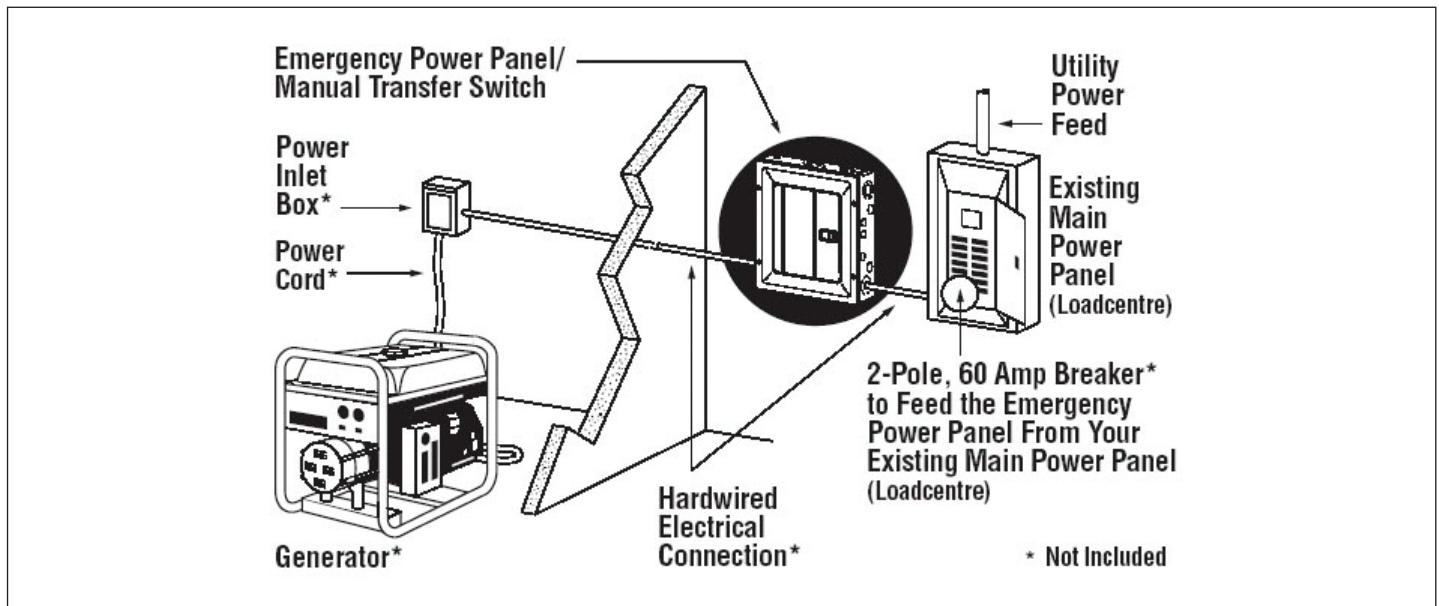

Figure 27. Typical installation diagram

Notes:

Combination service entrance loadcentre generator panels come complete with an integrated emergency generator panel.

Combination service entrance loadcentre generator panels come complete with factory installed utility feeder breaker for emergency generator panel section.

* Not Included

Spa panels

Single-phase, three-wire 120/240 Vac ground fault circuit interrupter spa panels

- Factory assembled, prewired, tested, and ready to install
- Two-pole 5 mA “people protection” Type CH ground fault circuit interrupter circuit breaker
- Two additional one-pole circuits available
- Test button provides a means of confirming proper GFCI circuit breaker operation
- 10,000 A interrupting capacity
- 120/240 Vac single-phase, three-wire
- Pre-installed neutral and ground bars
- Type 3R enclosure good for indoor or outdoor mounting
- Interior deadfront provides protection from energized parts
- Padlockable cover provides added security and safety
- Audible alarm option field installable
- Can be used as a disconnect to turn the spa pump on and off
- Main lug connections will accommodate a single #14–1/0 AWG conductor ^a

^a Refer to **page 34** for Type CH ground fault circuit breaker accepted load conductor sizes.



Product description

CEC Rule 68-086 (1) and (6) requires that a ground fault circuit interrupter, of a Class A Type, be installed not closer than 3 m (10 ft) to a pool or spa water. In cases where a spa is installed some distance from your main loadcentre it is often more convenient to locate this protection device in a small panel closer to the spa. Excessive cable lengths required to connect directly back to a protection device in your main loadcentre may be more susceptible to insulation breakage and result in nuisance tripping of the breaker. The reduced distance the owner must travel to reset a tripped circuit breaker in a localized spa panel may also be an excellent selling point for the owner.

Product selection

Table 57. Two-pole plug-in Type 3R spa panels

Breaker amperage (A)	Breaker type	Enclosure style	Audible alarm	Height in inches (mm)	Width in inches (mm)	Depth in inches (mm)	Catalogue number
30	CH	Indoor/outdoor Type 3R ^a	N	12.00 (304.8)	6.88 (174.6)	4.50 (114.3)	CH30SPAST
40	CH	Indoor/outdoor Type 3R ^a	N	12.00 (304.8)	6.88 (174.6)	4.50 (114.3)	CH40SPAST
50	CH	Indoor/outdoor Type 3R ^a	N	12.00 (304.8)	6.88 (174.6)	4.50 (114.3)	CH50SPAST
60	CH	Indoor/outdoor Type 3R ^a	N	12.00 (304.8)	6.88 (174.6)	4.50 (114.3)	CH60SPAST

^a Outdoor loadcentres accommodate Type DS conduit hubs. Hubs not included. See **page 15** for selection.

Table 58. Spa panel accessories

Description	Catalogue number
Field installable audible alarm kit (breaker and panel not included)	CHSPALARM

Note: CEC Rule 68-086 (1) and (6) requires that a ground fault circuit interrupter, of a Class A type, be installed not closer than 3 m (10 ft) to a pool or spa water.

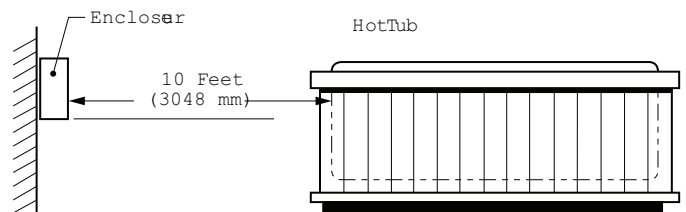

Check national and local codes for compliance.

Surge suppression products

Stage 1 and Stage 1 Type 2

Residential surge suppression products

- Stage 1 surge protection as well as Type 1 and Type 2 offering
- Convenient in-panel mount unit for Type BR loadcentres
- Knockout mount or surface mount CHSP design. DIN mount adapter for Type 1
- Limited lifetime warranty on CHSPT2ULTRA
- Dovetail clip together cable surge accessories for CHSPT2 design
- Flush mount kit for CHSPT2 design knockout mounting
- Type 2 surge suppression product designed to meet CSA C22.2 No.269-2 and UL 1449 3rd edition standard, cULus Listed No. N 024005



Product description

Today's homes are filled with increasing quantities of devices containing sensitive electronic components. These devices can easily be damaged by common power surges also some times called line transients, spikes, or voltage impulses. Lighting strikes, utility grid switching, other users on the powerline, and internal surges from air conditioners and powers tools are the most common sources these damaging line transients. To protect your investment it is recommended that a surge suppression device be installed. Surge protection can be broken into two stages. Stage 1 protection is primary protection for your service entrance. This protection is typically installed inside or adjacent to a home's service entrance distribution panel. Stage 2 protection is secondary protection or protection at the point of use. For proper surge protection both a stage 1 and stage 2 device must be installed. Eaton offers surge products to provide stage 1 protection to your sensitive equipment as well as both Type 1 and Type 2 surge devices that meet the latest CSA C22.2 No. 269 and UL 1449 3rd standard. We also offer surge protection devices for cable/satellite and Ethernet protection since surges are not isolated to the utility lines only.



Product selection Combination of Surge Protection and Surge/Breaker Protection

Ideal for applications with limited space in the panel.

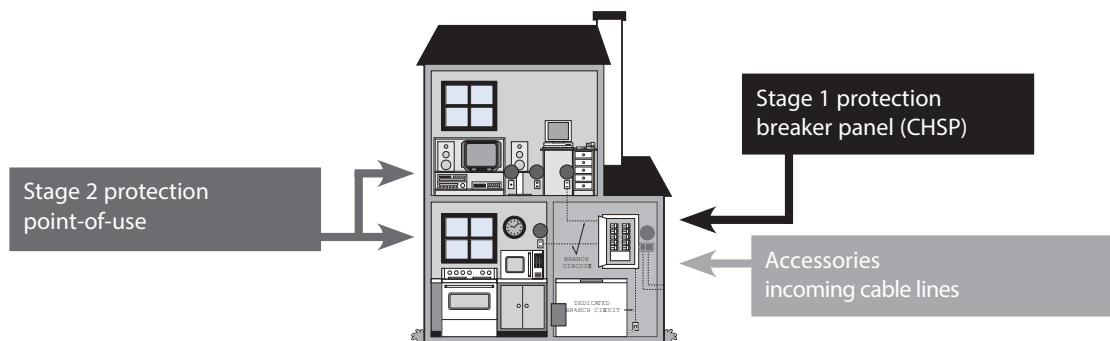

Table 59. Stage 1 Type 2 (point-of-service entrance) residential surge suppression products for Type BR/CH plug-in loadcentres

Connection	Voltage (Vac)	Phase	Frequency (Hz)	Maximum continuous operating voltage (V) ^a	Voltage protection rating ^b	Nominal discharge current (A) ^c	Short circuit current rating (A) ^d	Surge current capacity per phase (A) ^e	Catalogue number
Plug-on to loadcentre bus in Type BR loadcentres	120/240	Single	50/60	200 Line-to-Neutral (L-N) 400 Line-to-Line (L-L)	600 V L-N 1000 V L-L	3000	10,000	18,000	BRSURGE Surge only
Plug-on to loadcentre bus in Type BR loadcentres	120/240	Single	50/60	150 Line-to-Neutral (L-N) 300 Line-to-Line (L-L)	600 V L-N 1000 V L-L	10,000	10,000	36,000	BR250SUR Surge and Breaker
Plug-on to loadcentre bus in Type BR loadcentres	120/240	Single	50/60	150 Line-to-Neutral (L-N) 300 Line-to-Line (L-L)	600 V L-N 1000 V L-L	10,000	10,000	36,000	BR250SUR Surge and Breaker
Plug-on to loadcentre bus in Type CH loadcentres	120/240	Single	50/60	150 Line-to-Neutral (L-N) 300 Line-to-Line (L-L)	600 V L-N 1000 V L-L	10,000	10,000	36,000	CH230SUR Surge and Breaker
Plug-on to loadcentre bus in Type CH loadcentres	120/240	Single	50/60	150 Line-to-Neutral (L-N) 300 Line-to-Line (L-L)	600 V L-N 1000V L-L	10,000	10,000	36,000	CH250SUR Surge and breaker

^a Maximum continuous operating voltage that may be applied to the device per mode.

^b Voltage protection rating is the measured limiting voltage after a surge event.

^c Nominal discharge current is the current that the device can withstand for 15 impulses.

^d The amount of current the product can withstand under short circuit conditions.

^e The maximum one time surge current rating per phase.

Table 60. Stage 1 Type 2 (point-of-service entrance) residential surge suppression products for any loadcentre

Connection	Voltage (Vac)	Phase	Frequency (Hz)	Maximum continuous operating voltage (V) ^a	Voltage protection rating ^b	Nominal discharge current (A) ^c	Short circuit current rating (A) ^d	Surge current capacity per phase (A) ^e	Catalogue number
Can be attached to the outside of any manufacturer's loadcentre (breaker box). This product should be connected on the load side of the loadcentre main service disconnect through a dedicated circuit breaker (follow CEC guidelines).	120/240	Single	60	150 Line-to-Neutral (L-N)	600 V L-N	5,000	22,000	36,000	CHSPT2SURGE
	120/240	Single	60	300 Line-to-Line (L-L)	1000 V L-L	20,000 ^f	22,000	108,000	CHSPT2ULTRA
	120/240	Single	60		800 V N-G	20,000 ^f	22,000	108,000	CHSPT22PACK

- ^a Maximum continuous operating voltage that may be applied to the device per mode.
- ^b Voltage protection rating is the measured limiting voltage after a surge event.
- ^c Nominal discharge current is the current that the device can withstand for 15 impulses.
- ^d The amount of current the product can withstand under short circuit conditions.
- ^e The maximum one time surge current rating per phase.
- ^f When used with a 50 A two-pole breaker, 10 kA when used with a 15 A two-pole breaker.
- ^g CHSPT22PACK contains one each of CHSPT2ULTRA, CHSPCABLE.

Accessories



CHSPCABLE

Table 61. Residential surge suppression accessories

Description	Application	Product warranty	Connected equipment warranty	Maximum surge current (A) ^a	Catalogue number
SurgeCable™	Cable TV, satellite, cable modems (2 lines)	Lifetime	\$10,000	20,000	CHSPCABLE
Flushmount Kit™	Flush mount kit for finished wall installations	—	N/A	N/A	CHSPFMKIT

- ^a Maximum surge rating is the sum of all modes of protection.

Installation

CHSP and accessories can be mounted on the side, top, or bottom of a circuit breaker panel.

Note: CHSP SURGE, ULTRA or the 2-pack can be used interchangeably depending on protection required.

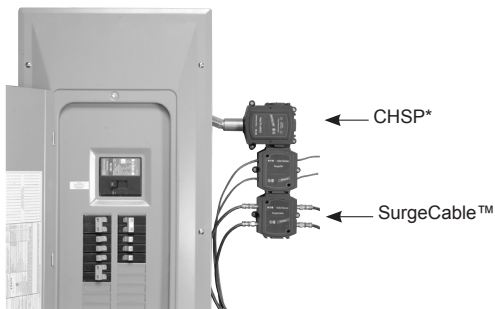

Street lighting panels

In-pole



Service entrance approved street and roadway lighting panels

- Compact in-pole panel fits into lighting pole hand well
- Pole mount 3R (rain-tight) street lighting panels can be mounted right onto the pole
- Pedestal mount 3R (rain-tight) street lighting panels feature a Eaton loadcentre housed in a Pencil enclosure

Product description

Since January 1, 2003 the Ontario Electric Safety Code requires that all roadway lighting shall meet the service entrance requirements of Rule 30-1002. Eaton has developed several designs of approved products to suit the various installation points (pole mounted, within an enclosure etc.). All products are CSA approved.

In-pole street lighting panels

- Fits into most pole manufacturers' hand well
- Service entrance approved
- 3R rain-tight
- Pre-wired
- Single- or two-pole, 22 kA, 50 A versions
- Removable mounting plates accommodate multiple hand wells
- CSA approved
- Approximate dimensions 9 x 2.25 x 4 inches
- Line power connections via #6 AWG conductor pigtail
- Load power connections via #14 AWG conductor pigtail
- #6 AWG conductor pigtail provided for daisy chaining of additional light poles

Product selection

Table 62. In-pole street lighting panels

Description	Voltage (Vac)	Main circuit breaker	Interrupting (kAIC)	Catalogue number
120 Vac in-pole compact street lighting panel	120	Single-pole 15 A	22	1SL150PCO
120 Vac in-pole compact street lightning panel	120	Single-pole 30 A	22	1SL300PCO
120 Vac in-pole compact street lighting panel	120	Single-pole 50 A	22	1SL500PCO
240 Vac in-pole compact street lighting panel	120/240	Two-pole 15 A	22	2SL150PCO
240 Vac in-pole compact street lighting panel	120/240	Two-pole 30 A	22	2SL300PCO
240 Vac in-pole compact street lighting panel	120/240	Two-pole 50 A	22	2SL500PCO

On-pole**On-pole street lighting panels**

- Mounts directly onto the pole
- Strap mount version includes slots in the enclosure back to allow for strap mounting
- Two extra 1-inch breaker locations that accept Type BR and DNPL plug-in circuit breakers for additional lighting loads
- Service entrance approved
- 3R rain-tight
- Single- or two-pole, 22 kA, 50, 60, or 70 A versions
- CSA approved
- Approximate dimensions 13 x 11 x 4.50 inches
- Bottom entry service entrance cabling only

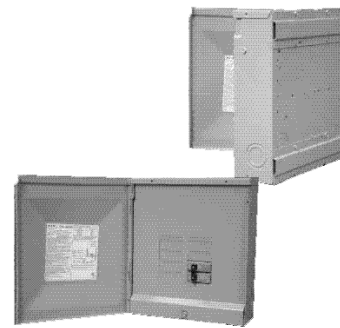
**Product selection****Table 63. On-pole street lighting panels standard mount**

Voltage (Vac)	Main circuit breaker	Interrupting (kAIC)	Branch circuits (1-inch/½-inch)	Main circuit breaker wire size range (Cu/Al 60 °C or 75 °C) (AWG)	Catalogue number
120	Single-pole 50 A	22	2/4	#14–4	1SL502
120	Single-pole 60 A	22	2/4	#4–1/0	1SL602
120	Single-pole 70 A	22	2/4	#4–1/0	1SL702
120/240	Two-pole 50 A	22	2/4	#14–4	2SL502
120/240	Two-pole 60 A	22	2/4	#4–1/0	2SL602
120/240	Two-pole 70 A	22	2/4	#4–1/0	2SL702

Table 64. On-pole street lighting panels strap mount

Voltage (Vac)	Main circuit breaker	Interrupting (kAIC)	Branch circuits (1-inch/½-inch)	Main circuit breaker wire size range (Cu/Al 60 °C or 75 °C) (AWG)	Catalogue number
120	Single-pole 50 A	22	2/4	#14–4	1SL502S
120	Single-pole 60 A	22	2/4	#4–1/0	1SL602S
120	Single-pole 70 A	22	2/4	#4–1/0	1SL702S
120/240	Two-pole 50 A	22	2/4	#14–4	2SL502S
120/240	Two-pole 60 A	22	2/4	#4–1/0	2SL602S
120/240	Two-pole 70 A	22	2/4	#4–1/0	2SL702S
120/240	Two-pole 70 A	22	6/12	#4–1/0	2SL706S

Pedestal

Pedestal mounted street lighting panels

- Lightweight, stand-alone units mount on the ground
- Polyethylene Pencil enclosure provides rugged, low profile, rain-tight assembly
- Penta head and key lock provision for security
- Vented or non-vented enclosure styles
- Two extra 1-inch breaker locations accept Type BR and DNPL plug-in circuit breakers for additional lighting loads
- Service entrance approved
- 3R rain-tight
- Single- or two-pole 22 kA, 50, 60, or 70 A versions
- CSA approved
- Underground duct or direct burial cable accessible



Product selection

Table 65. Pedestal mount non-vented street lighting panels

Voltage (Vac)	Main circuit breaker	Interrupting (kAIC)	Branch circuits (1-inch/½-inch)	Extension	Main circuit breaker wire size range (Cu/Al 60 °C or 75 °C) (AWG)	Catalogue number
120	Single-pole 50 A	22	2/4	No	#14-4	1SL502NV
120	Single-pole 60 A	22	2/4	No	#4-1/0	1SL602NV
120	Single-pole 70 A	22	2/4	No	#4-1/0	1SL702NV
120/240	Two-pole 50 A	22	2/4	No	#14-4	2SL502NV
120/240	Two-pole 60 A	22	2/4	No	#4-1/0	2SL602NV
120/240	Two-pole 70 A	22	2/4	No	#4-1/0	2SL702NV
120	Single-pole 50 A	22	2/4	Yes	#14-4	1SL502NVE
120	Single-pole 60 A	22	2/4	Yes	#4-1/0	1SL602NVE
120	Single-pole 70 A	22	2/4	Yes	#4-1/0	1SL702NVE
120/240	Two-pole 50 A	22	2/4	Yes	#14-4	2SL502NVE
120/240	Two-pole 60 A	22	2/4	Yes	#4-1/0	2SL602NVE
120/240	Two-pole 70 A	22	2/4	Yes	#4-1/0	2SL702NVE

Table 66. Pedestal mount vented street lighting panels

Voltage (Vac)	Main circuit breaker	Interrupting (kAIC)	Branch circuits (1-inch/½-inch)	Extension	Main circuit breaker wire size range (Cu/Al 60 °C or 75 °C) (AWG)	Catalogue number
120	Single-pole 50 A	22	2/4	Yes	#14-4	1SL502VE
120	Single-pole 60 A	22	2/4	Yes	#4-1/0	1SL602VE
120	Single-pole 70 A	22	2/4	Yes	#4-1/0	1SL702VE
120/240	Two-pole 50 A	22	2/4	Yes	#14-4	2SL502VE
120/240	Two-pole 60 A	22	2/4	Yes	#4-1/0	2SL602VE
120/240	Two-pole 70 A	22	2/4	Yes	#4-1/0	2SL702VE

Combined loadcentre and meter socket

Combined loadcentre and meter socket

- 4 Jaw, 100 and 200 A, 120/240 V, 22 kAIC
- Service entrance rated with 100 or 200 A main circuit breaker included
- Suitable for underground or overhead service entrance
- Meter socket mechanical lugs accommodate #6–250 MCM Cu/Al line conductors and (2) #6–300 MCM Cu/Al neutral conductors
- Loadcentre mechanical lugs load and neutral (2) #6–300 MCM Cu/Al
- CSR circuit breaker mechanical load lugs #2–300 MCM
- Suitable for overhead or underground service entrance
- Suitable applications include farming, temporary service, construction sites, trailers, and mobile homes
- Hub opening and plate included. Hubs ordered separately (use DS type hubs)
- 3R enclosure
- CSA approved



Product selection

Table 67. Combined loadcentre and meter socket

Enclosure	Voltage (V)	Amperage (A)	Interrupting (kAIC)	Entrance type	Branch circuits (1-inch/½-inch)	Weight in lb (kg)	Dimensions in inches (mm)	Catalogue number
Indoor/outdoor Type 3R	120/240	100	22	Underground/overhead	8/16	36.5 (16.6)	28.38 x 14.44 x 5.38 (974.7 x 366.7 x 136.5)	RCPM108M
Indoor/outdoor Type 3R	120/240	200	22	Underground/overhead	8/16	36.5 (16.6)	28.38 x 14.44 x 5.38 (974.7 x 366.7 x 136.5)	RCPM208M

Table 68. Knockout legend

Location	Knockout size in inches (mm)	Quantity
Bottom end wall	0.50 (12.7)	7
Bottom end wall	0.50, 0.75 (12.7, 19.1)	4
Bottom end wall	0.50, 0.75, 1.00 (12.7, 19.1, 25.4)	1
Bottom end wall	1.00, 1.25, 1.50, 2.00 (25.4, 31.8, 38.1, 50.8)	1
Bottom end wall	1.25, 1.50, 2.00, 2.50, 3.00 (31.8, 38.1, 50.8, 63.5, 76.2)	1
Top end wall	Provision for Hub ^a (e.g. DS200H2, DS250H2, DS300H2)	2
Backplane	1.25, 1.50, 2.00, 2.50 (31.8, 38.1, 50.8, 63.5)	1
Backplane	1.25, 1.50, 2.00 (31.8, 38.1, 50.8)	1
Right sidewall	1.25, 1.50, 2.00, 2.50 (31.8, 38.1, 50.8, 63.5)	1

^a Accommodate Type DS conduit hubs. Hubs not included. See **page 15** for selection.

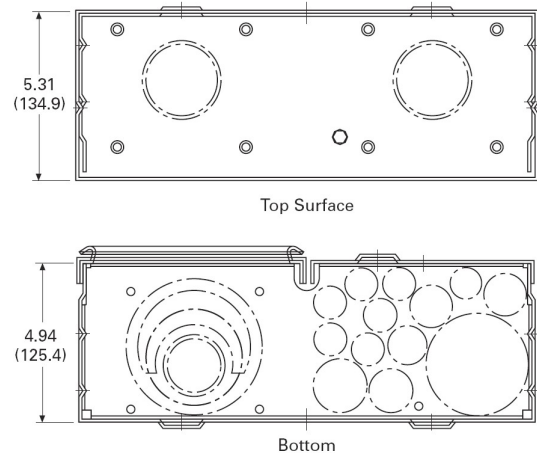

Metered temporary ground fault power panel

Metered temporary power panel with ground fault protection

- Combination loadcentre, meter socket, and electrical outlets for temporary work site installations
- Single-phase, three-wire
- 4 jaw, 100 or 200 A, 120/240 V, 22 kAIC meter socket
- Suitable for overhead or underground service entrance
- CSA approved for service entrance
- 3R enclosure suitable for outdoor installations
- Two different receptacle combinations 6X20A and 2X30A or 10X20A
- Hub opening and plate included. Hubs ordered separately (uses DS type hubs)
- Meter socket mechanical lugs accommodate #6–250 MCM Cu/Al line conductors and #6–300 MCM Cu/Al neutral conductors



Product selection

Table 69. Metered temporary ground fault protected power panel

Enclosure	Voltage (V)	Amperage (A)	Interrupting (kAIC)	Entrance Type	20 A receptacles	30 A receptacles	Dimensions in inches (mm)	Catalogue number
Indoor/outdoor Type 3R	120/240	100	22	Underground/overhead	6	2	34.38 x 22.00 x 5.38 (873.1 x 558.8 x 136.5)	RCPM1GF6H
Indoor/outdoor Type 3R	120/240	100	22	Underground/overhead	10	0	34.38 x 22.00 x 5.38 (873.1 x 558.8 x 136.5)	RCPM1GF10
Indoor/outdoor Type 3R	120/240	200	22	Underground/overhead	6	2	34.38 x 22.00 x 5.38 (873.1 x 558.8 x 136.5)	RCPM2GF6H
Indoor/outdoor Type 3R	120/240	200	22	Underground/overhead	10	0	34.38 x 22.00 x 5.38 (873.1 x 558.8 x 136.5)	RCPM2GF10

Table 70. Knockout legend

Catalogue number	Knockout size (inches)	Quantity
Bottom endwall	0.50, 0.75	6
Bottom endwall	0.50, 0.75, 1.00, 1.25	2
Bottom endwall	1.00, 1.25, 1.50, 2.00, 2.50	1
Bottom endwall	1.00, 1.25, 1.50, 2.00, 2.50, 3.00	1
Top endwall	Provision for Hub ^a (e.g. DS200H2, DS250H2, DS300H2)	1

^a Accommodate Type DS conduit hubs. Hubs not included. See **page 15** for selection.



Top Surface

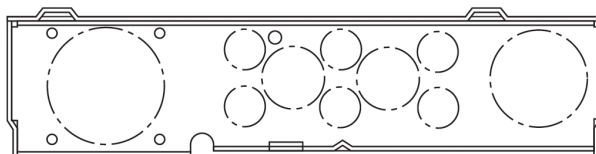

Bottom

Mini-power centres



Mini-power centres

- Distribution transformer, breaker protection, and loadcentre all in one compact package
- Primary and secondary breaker protection via factory installed EHD or FDB type MCCBs
- 18, 25, or 35 kAIC interrupting capacity versions available on select models through special order
- Two styles of interior; one for plug-in or bolt-on (breakers not included)
- Loadcentre accommodates up to 24 feeder circuit breakers (breakers purchased separately)
- Aluminum chassis on plug-in type, copper chassis on bolt-on type, standard ground bar, and enclosure grounded neutral bar
- All live parts are enclosed
- Hinged, padlockable cover prevents removal
- Enclosure includes grounding terminal
- Type 3R enclosure with baked polymer polyester powder coating is good for indoor or outdoor mounting
- Optional Type 3R, 316 grade stainless steel enclosure
- Main circuit breaker barrier provides CSA approval for service entrance applications
- Electrical grade aluminum windings standard on the distribution transformer (copper optional)
- Copper windings standard on bolt-on style units
- 185 °C insulation system
- 115 °C winding temperature rise
- Full capacity taps (FCBN) 2–5%
- Resin encapsulated, core-coil assembly (cores grounded with copper lead)

Product description

Contemporary electrical distribution systems are required to do more in less space while at the same time being cost-effective. Eaton provides a solution to these requirements with the proven mini-power centre. It occupies considerably less space and can save up to 31 percent of the installation costs normally required when individual components are used. The solution is possible because a mini-power centre combines three individual components into one NEMA Type 3R enclosure: a main breaker, an encapsulated Type EP or EPT dry-type transformer, and a secondary distribution loadcentre with main breaker. Interconnecting wiring is completed at the factory. A mini-power centre is delivered ready for installation. It's suitable for use as service entrance equipment, too. Mini-power centres are used wherever there is a 480 V or 600 V distribution system and loads requiring 208Y/120 V three-phase or 120/240 V single-phase.

Typical installations include:

- Industrial plant assembly lines
- Plant expansions
- Commercial buildings
- Test equipment
- Temporary power at construction sites
- Sewage disposal plants
- Warehouses
- Car washes
- Parking lots

The mini-power centre saves you space, time, and money. A mini-power centre installation takes up only 42% of the space taken up by a typical installation. A typical installation being comprised of a separately mounted distribution transformer, disconnect switch, loadcentre and all associated wiring and connectors.

The installation costs of a mini-power centre are 31% less when compared with the same typical installation.

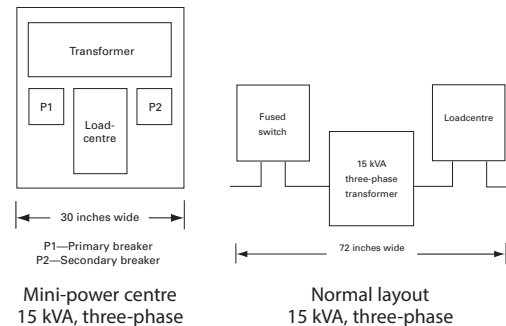

Installation	Time to perform task(s) a (hours)			
	Typical installation 15 kVA	Mini-power centre installation 15 kVA	Typical installation 25 kVA	Mini-power centre installation 25 kVA
Switch and fuse mounting	5	0	5	0
Transformer layout (remove knockout, etc.)	16	16	24	24
Fasten transformer to wall	4	0	4	0
Layout loadcentre, mount and connect source	4	4	6	4
Total hours	29	20	39	28
% time saved by using a eaton mini-power centre		31%		28%

Plug-in mini-power centres

Plug-in

Table 71. Single-phase plug-in mini-power centres

kVA	Primary and secondary voltage (V)	Catalogue number ^a	Main circuit breaker ^b		Maximum number of feeder circuit breakers			Maximum amperage	Dimensions in inches (mm) ^c			Weight in lb (kg)
			Primary	Secondary	Single-pole	Two-pole	Three-pole		Height	Width	Depth	
3	480 to 120/240	P48G11S03P	EHD2015	BR215	8	4	—	12	27.05 (699.0)	12.60 (320.0)	9.70 (245.0)	105 (47)
5	480 to 120/240	P48G11S05P	EHD2020	BR225	12	6	—	20	29.50 (749.0)	12.60 (320.0)	9.70 (245.0)	105 (47)
7.5	480 to 120/240	P48G11S07P	EHD2030	BR230	12	6	—	30	29.50 (749.0)	12.60 (320.0)	9.70 (245.0)	125 (56)
10	480 to 120/240	P48G11S10P	EHD2040	BR250	12	6	—	40	38.20 (970.0)	13.50 (343.0)	11.80 (300.0)	177 (80)
15	480 to 120/240	P48G11S15P	EHD2060	BR270	20	10	—	60	38.20 (970.0)	13.50 (343.0)	11.80 (300.0)	212 (96)
25	480 to 120/240	P48G11S25P	EHD2100	BR2125	26	13	—	100	43.90 (1115.0)	16.40 (417.0)	11.80 (300.0)	373 (169)
5	600 to 120/240	P60G11S05P	FDB2015	BR225	12	6	—	20	29.50 (749.0)	12.60 (320.0)	14.60 (370.0)	105 (47)
7.5	600 to 120/240	P60G11S07P	FDB2030	BR230	12	6	—	30	29.50 (749.0)	12.60 (320.0)	9.70 (245.0)	125 (56)
10	600 to 120/240	P60G11S10P	FDB2040	BR250	12	6	—	40	38.20 (970.0)	13.50 (343.0)	9.70 (245.0)	177 (80)
15	600 to 120/240	P60G11S15P	FDB2060	BR270	20	10	—	60	38.20 (970.0)	13.50 (343.0)	11.80 (300.0)	212 (96)
25	600 to 120/240	P60G11S25P	FDB2100	BR2125	26	13	—	100	43.90 (1115.0)	16.40 (417.0)	14.60 (370.0)	373 (169)

^a For a primary main circuit breaker interrupting capacity greater than 10 kAIC, add the following suffixes to the catalogue number; for 18 kAIC, add "F"; for 25 kAIC, add "H"; and for 35 kAIC, add "C".

^b Main circuit breakers fixed only. No substitutes.

^c Not for construction purposes.

Note: For price and delivery on a unit with copper transformer windings or 316 grade stainless steel enclosure, contact your local Eaton sales representative or our Customer Service centre at 1-800-268-3578. Feeder circuit breakers not included. Uses Eaton Type BR circuit breakers.

Table 72. Three-phase plug-in mini-power centres

kVA	Primary and secondary voltage (V)	Catalogue number ^a	Main circuit breaker ^b		Maximum number of feeder circuit breakers			Maximum amperage	Dimensions in inches (mm) ^c			Weight in lb (kg)
			Primary	Secondary	Single-pole	Two-pole	Three-pole		Height	Width	Depth	
15	480 to 120/208	P48G28T15P	EHD3040	BR350	18	9	6	40	36.10 (917.0)	28.80 (732.0)	9.70 (245.0)	320 (145)
22.5	480 to 120/208	P48G28T21P	EHD3070	BR370	18	9	6	60	40.90 (1039.0)	29.90 (759.0)	11.80 (300.0)	565 (256)
30	480 to 120/208	P48G28T30P	EHD3090	BR3100	24	12	8	80	41.90 (1064.0)	29.90 (759.0)	13.60 (346.0)	635 (288)
15	600 to 120/208	P60G28T15P	FDB3030	BR350	18	9	6	40	36.10 (917.0)	28.80 (732.0)	9.40 (238.0)	320 (145)
22.5	600 to 120/208	P60G28T21P	FDB3050	BR370	18	9	6	60	40.90 (1039.0)	29.90 (759.0)	5650 (256.0)	565 (256)
30	600 to 120/208	P60G28T30P	FDB3070	BR3100	24	12	8	80	41.90 (1064.0)	29.90 (759.0)	6350 (288.0)	635 (288)

^a For a primary main circuit breaker interrupting capacity greater than 10 kAIC, add the following suffixes to the catalogue number; for 18 kAIC add "F", for 25 kAIC add "H", and for 35 kAIC add "C".

^b Main circuit breakers fixed only. No substitutes.

^c Not for construction purposes.

Note: For price and delivery on a unit with copper transformer windings or 316 grade stainless steel enclosure, contact your local Eaton sales representative or our Customer Service centre at 1-800-268-3578. Feeder circuit breakers not included. Uses Eaton Type BR circuit breakers.

Bolt-on mini-power centres

Bolt-on

Table 73. Single-phase bolt-on mini-power centres

kVA	Primary and secondary voltage (V)	Catalogue number	Main circuit breaker ^a		Maximum number of feeder circuit breakers ^{bc}			Maximum amperage	Dimensions in inches (mm) ^d			Weight in lb (kg)
			Primary	Secondary	Single-pole	Two-pole	Three-pole		Height	Width	Depth	
3	480 to 120/240	P48G11S03CUB	EHD2015L	BAB2015	12	6	—	12	33.20 (845.0)	12.60 (320.0)	9.70 (245.0)	105 (47)
5	480 to 120/240	P48G11S05CUB	EHD2020L	BAB2025	18	9	—	20	36.10 (918.0)	12.60 (320.0)	9.70 (245.0)	110 (50)
7.5	480 to 120/240	P48G11S07CUB	EHD2030L	BAB2030	18	9	—	30	36.10 (918.0)	12.60 (320.0)	9.70 (245.0)	110 (50)
10	480 to 120/240	P48G11S10CUB	EHD2040L	BAB2050	18	9	—	40	40.90 (1038.0)	13.50 (343.0)	11.80 (300.0)	180 (82)
15	480 to 120/240	P48G11S15CUB	EHD2060L	BAB2070	24	12	—	60	43.90 (1115.0)	15.00 (380.0)	11.80 (300.0)	215 (98)
25	480 to 120/240	P48G11S25CUB	EHD2100L	BAB2125	30	15	—	100	43.40 (1102.0)	20.40 (518.0)	14.60 (370.0)	385 (175)
3	600 to 120/240	P60G11S03CUB	FDB2015L	BAB2015	12	6	—	12	33.20 (845.0)	12.60 (320.0)	9.70 (245.0)	105 (47)
5	600 to 120/240	P60G11S05CUB	FDB2020L	BAB2025	18	9	—	20	36.10 (918.0)	12.60 (320.0)	9.70 (245.0)	110 (50)
7.5	600 to 120/240	P60G11S07CUB	FDB2030L	BAB2030	18	9	—	30	36.10 (918.0)	12.60 (320.0)	9.70 (245.0)	110 (50)
10	600 to 120/240	P60G11S10CUB	FDB2040L	BAB2050	18	9	—	40	40.90 (1038.0)	13.50 (343.0)	11.80 (300.0)	180 (82)
15	600 to 120/240	P60G11S15CUB	FDB2060L	BAB2070	24	12	—	60	43.90 (1115.0)	15.00 (380.0)	11.80 (300.0)	215 (98)
25	600 to 120/240	P60G11S25CUB	FDB2100L	BAB2125	30	15	—	100	43.40 (1102.0)	20.40 (518.0)	14.60 (370.0)	385 (175)

^a Main circuit breakers fixed only. No substitutes.

^b Feeder circuit breakers not included. Uses Eaton Type BAB circuit breakers.

^c Combinations can be selected.

^d Not for construction purposes.

Table 74. Three-phase bolt-on mini-power centres

kVA	Primary and secondary voltage (V)	Catalogue number	Main circuit breaker ^a		Maximum number of feeder circuit breakers ^{bc}			Maximum amperage	Dimensions in inches (mm) ^d			Weight in lb (kg)
			Primary	Secondary	Single-pole	Two-pole	Three-pole		Height	Width	Depth	
15	480 to 120/208	P48G28T15CUB	EHD3040L	BAB3050H	18	9	6	40	36.10 (917.0)	28.70 (730.0)	9.40 (238.0)	320 (148)
22.5	480 to 120/208	P48G28T21CUB	EHD3070L	BAB3070H	18	9	6	60	40.90 (1038.0)	29.90 (759.0)	13.60 (346.0)	565 (257)
30	480 to 120/208	P48G28T30CUB	EHD3090L	BAB3100H	24	12	8	80	41.90 (1063.0)	29.90 (759.0)	13.60 (346.0)	635 (288)
15	600 to 120/208	P60G28T15CUB	FDB3030	BAB3050H	18	9	6	40	36.10 (917.0)	28.70 (730.0)	9.40 (238.0)	320 (148)
22.5	600 to 120/208	P60G28T21CUB	FDB3050	BAB3070H	18	9	6	60	40.90 (1038.0)	29.90 (759.0)	13.60 (346.0)	565 (257)
30	600 to 120/208	P60G28T30CUB	FDB3070	BAB3100H	24	12	8	80	41.90 (1063.0)	29.90 (759.0)	13.60 (346.0)	635 (288)

^a Main circuit breakers fixed only. No substitutes.

^b Feeder circuit breakers not included. Uses Eaton Type BAB circuit breakers.

^c Combinations can be selected.

^d Not for construction purposes.

Residential fuse panel inserts

Residential fuse panel inserts ^a

- Convenient and economical option to completely replacing an entire fuse panel assembly
- Original fuse panel tub and wiring remains in place and only the fuse panel trim and interior is removed and replaced
- 16 and 24 circuit breaker interiors designed to fit any manufacturers' fuse panel or discontinued design circuit breaker panel
- Custom trim and door oversized to ensure fit with existing tub
- Circuit breaker interior replacement eliminates the possibility of improperly sized amperage protection
- No more loose fuses causing arcing and damage to the panel or wiring
- CSA certified to mount into any existing box under file LL264-222
- Can be mounted in any orientation as defined by the existing fuse panel tub orientation
- Accepts plug-in Type BR, DNPL, or GFCB circuit breakers (circuit breakers sold separately, refer to **page 17** to **page 20** for selection)
- Trim comes complete with hinged door, non-locking spring latch, clear plastic card holder, and circuit directory card
- Tin plated aluminum bus bars

^a Not for use as service entrance equipment.

Product description

Fuses and fuse panels were designed decades ago, to prevent the overload of circuit wiring that could lead to fires caused by overloaded electrical circuit connections and/or short circuits. Records show however, that problems of fire and smoke inhalation are the more serious causes of death or injury.

Since early 1960's, technology has allowed a tremendous increase in the number and use of appliances, tools, and control systems, many of which are automatically controlled and cycle on and off. We now know that a cycling load will actually cause a plug (screw-on-type) fuse to loosen in its holder (that explains why you can always find one or two fuses that can be tightened a quarter turn). Loose connections such as these develop heat, and in turn increase the risk of fire.

Small overloads can be absorbed by the margin of safety built into CSA certified devices. However, prolonged overloads or loose fuses will cause arcing and ultimately, melting of the connections in either the panel or wiring, wherever the weakest link may be.

Eaton has designed a low cost method of replacing fuse panels with modern circuit breaker panels. This method eliminates the need for cutting, re-plastering and repainting the walls around the old panel.

Another risk with the old fuse panel design was the ease with which incorrect fuses could be used or changed without realization of the risks involved.

To eliminate these potential hazards Eaton has a new circuit breaker interior and trim kit that will quickly upgrade the existing installation to today's electrical standards and needs. An average upgrade takes one hour and thus creates the minimum of inconvenience to the homeowner/occupant.

Sample specification

- Supply and install a new circuit breaker interior to replace existing plug fuse panel interior or out of date circuit breaker interior in each apartment or condominium
- Interior to be 16 or 24 circuit, rated 100 A and 120/240 V, designed in a single row breaker arrangement for fitting into existing recessed electrical panels
- Supply and install new trim and door assembly slightly larger than discarded fuse trim to minimize any requirements for patching or repainting
- Bus bars shall be tin plated aluminum suitable for plug-in circuit breakers
- Supply and install a trim and door assembly with latch, to protect the circuit breaker toggle handles
- Inserts must be CSA certified for mounting in any position, for ease in connecting to existing wiring
- Install circuit breakers with ratings as indicated in specifications or drawings
- Interiors to be mounted with directions template and hardware supplied by Eaton
- Inserts, trim and door assembly and circuit breakers, shall be manufactured by Eaton
- Provide a circuit identification card, mounted under clear plastic on the inside of the door

Insert interiors

Residential fuse panel insert interiors

- 100 A single-phase, three-wire 120/240 Vac
- 16 and 24 circuit breaker capacity ^a
- CSA certified to mount into any existing box under file LL264-222
- Accepts plug-in type BR and DNPL circuit breakers ^{ab}
- Tin plated aluminum bus bars
- Neutral available with 16 or 24 Cu/Al terminals
- Main and neutral lugs located at the same end
- All terminals accept #14–3 AWG cabling

^a Filler plates for unused fuse panel insert circuit breaker installation locations can be ordered as BRFP (package of 24).

^b Refer to **page 17** to **page 20** for plug-in circuit breaker selection.

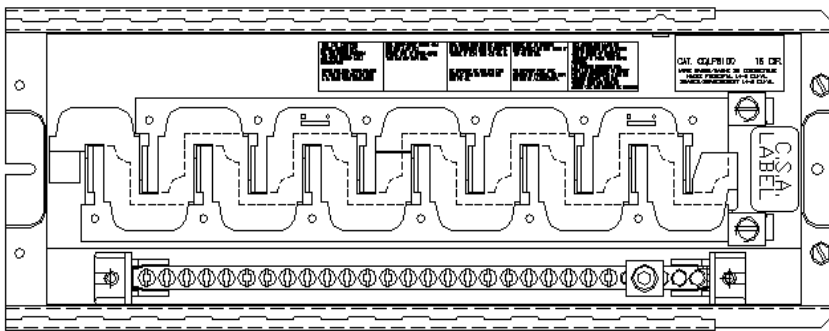
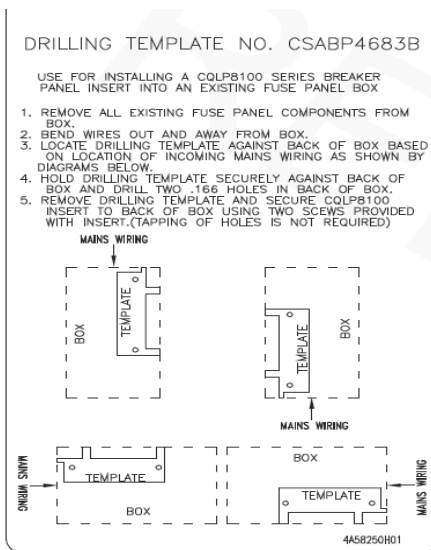

Table 75. Three-wire 120/240 Vac fuse panel insert interiors

Amperage rating (A)	Voltage (V)	Number of installable circuit breakers		Bus material	Neutral material	Wire size range Cu/Al	Catalogue number	Drilling template catalogue number ^a
		1-inch spaces	1/2-inch spaces					
100	120/240	8	16	Aluminum	Aluminum	#14–3 AWG	CQLP8100	CSABP4683B
100	120/240	12	24	Aluminum	Aluminum	#14–3 AWG	CQLP12100	CSABP4734B

^a We suggest the use of templates to ensure proper sizing for installation.



Trims

Residential fuse panel insert trims

- Doors are die formed with sloping sides and rounded corners and permanently mounted to the trim
- Semi concealed hinges ^a
- Includes circuit directory card and self adhesive clear plastic directory holder
- Painted ASA61 light grey baked on enamel
- Mounting hardware included ^b
- Trims are custom sized larger than the existing trim and door
- Trim mounting holes located to line up with existing box holes ^c

- ^a If the main service entrance is bottom entry, the door hinges left. If it is top entry, then the door hinges right.
- ^b The hardware supplied will accommodate boxes that are mounted up to 1/2-inch too deep or equal to 3-1/2 inches net depth.
- ^c Measure the existing box holes locations as they may be part of the end walls, side walls, or tapped into a box flange.

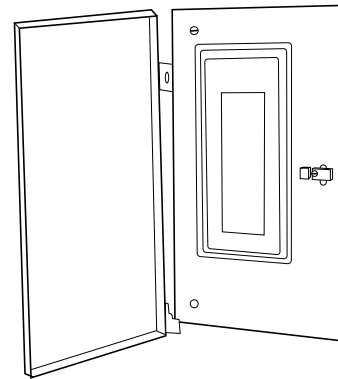

Table 76. Fuse panel insert trims

Original manufacturer	Fuse panel catalogue number	Box dimensions (inches)			Replacement trim catalogue number	Trim size (inches)		Replacement interior catalogue number	Trim mounting holes (inches)	
		Height	Width	Depth		Height	Width		Height	Width
Amalgamated	4112	16-1/8	8-1/2	2-15/16	QLPT16D	18-1/4	9-3/4	CQLP8100	16-1/6	4
Amalgamated	4116	19-1/2	8-1/2	2-15/16	QLPT19D	20-7/8	9-3/4	CQLP8100	18-11/16	4
Amalgamated	4120	22-7/8	8-1/2	2-15/16	QLPT22AD	25	10-1/2	CQLP12100 ^a	22-1/4	6
Amalgamated	4208	16-1/8	8-1/2	2-15/16	QLPT16AD	18-1/4	10-5/16	CQLP8100	15-1/2	6
Amalgamated	4212	19-1/2	8-1/2	2-15/16	QLPT20AD	20-7/8	9-3/4	CQLP8100	18-11/16	6
Amalgamated	4216	22-7/8	8-1/2	2-15/16	QLPT22AD	25	10-1/2	CQLP12100 ^a	22-1/4	6
Amalgamated	4220	24-1/8	8-1/2	2-15/16	QLPT24D	26	9-3/4	CQLP12100 ^a	23-13/16	4
Amalgamated	4312	22-7/8	8-1/2	2-15/16	QLPT22AD	25	10-1/2	CQLP12100 ^a	22-1/4	6
CEB	NHP10-636-3 ^b	24	10	3	QLPT24LD	26	12	CQLP12100 ^a	23-13/16	4
CEB	NHP6-60 ^c	14	7-3/4	3	QLPT14D	16	9-3/4	CQLP8100	13-3/16	4
CEB	NHP12-60	20	7-3/4	3	QLPT20D	21-3/4	9-3/4	CQLP12100 ^a	19-9/16	4
CEB	NHP12-633	23	7-3/4	3	QLPT24D	26	9-3/4	CQLP12100 ^a	23-13/16	4
CEB	NHP4-632	16-1/4	7-3/4	3	QLPT16D	18-1/4	9-3/4	CQLP8100	16-1/6	4
CEB	NHP6-633	20	7-3/4	3	QLPT19D	20-7/8	9-3/4	CQLP8100	18-11/16	4
CEB	NHP6-636-4	24	7-3/4	3	QLPT24D	26	9-3/4	CQLP12100 ^a	23-13/16	4
CEB	NHP8-60	16-1/8	7-3/4	3	QLPT16D	18-1/4	9-3/4	CQLP8100	16-1/6	4
CEB	NHP8-635-3	23	7-3/4	3	QLPT24D	26	9-3/4	CQLP12100 ^a	23-13/16	4
Taylor (Crouse-Hinds)	NHP6-30-60	21	7-3/8	3	QLPT20D	21-3/4	9-3/4	CQLP12100 ^a	19-9/16	4
Taylor (Crouse-Hinds)	NHP20-1231	24-1/2	9-1/2	3	QLPT24D	26	9-3/4	CQLP12100 ^a	23-13/16	4
Taylor (Crouse-Hinds)	NHP20-0821-6	24-1/2	9-1/2	3	QLPT24D	26	9-3/4	CQLP12100 ^a	23-13/16	4
Taylor (Crouse-Hinds)	NHP12B-1000-2	17-1/8	9-1/2	3	QLPT16AD	18-1/8	10-5/16	CQLP8100	15-1/2	6
Taylor (Crouse-Hinds)	NHP10-0401-4	17-1/8	9-1/2	3	QLPT16AD	18-1/8	10-5/16	CQLP8100	15-1/2	6
Taylor (Crouse-Hinds)	NHP10-0601-2	17-1/8	9-1/2	3	QLPT16AD	18-1/8	10-5/16	CQLP8100	15-1/2	6
Taylor (Crouse-Hinds)	NHP10-0611	17-1/8	9-1/2	3	QLPT16AD	18-1/8	10-5/16	CQLP8100	15-1/2	6
Taylor (Crouse-Hinds)	NHP10-0801	17-1/8	9-1/2	3	QLPT16AD	18-1/8	10-5/16	CQLP8100	15-1/2	6
Taylor (Crouse-Hinds)	NHP12-0811	19-1/4	9-1/2	3	QLPT22AD	25	10-1/2	CQLP12100 ^a	22-1/4	6
Taylor (Crouse-Hinds)	NHP14-0801-4	19-1/4	9-1/2	3	QLPT22AD	25	10-1/2	CQLP12100 ^a	22-1/4	6
Taylor (Crouse-Hinds)	NHP14-0621-2	19-1/4	9-1/2	3	QLPT22AD	25	10-1/2	CQLP12100 ^a	22-1/4	6

^a Panel insert CQLP8100 can also be used with this size trim.

^b For box sizes either 26 inches or 27-1/2 inches high, no insert or trim is available.

^c For box size 14" only

Replacement classic circuit breakers

Bolt-on Type BQL single-, multi-pole, Duplex, and Quadplex

Type BQL ^a

- 10,000/22,000 A interrupting capacity at 120/240 Vac
- Captive line screw included (#2 Robertson/Slot)

^a HACR rated.

Product selection

Table 77. Single- and multi-pole bolt-on classic replacement circuit breakers

Ampere rating	Wire size range (Cu/Al 60 °C or 75 °C) (AWG)	Catalogue number					
		Single-pole, 120/240 Vac		Two-pole, 120/240 Vac		Three-pole, 120/240 Vac	
		10 kAIC	22 kAIC	10 kAIC	10 kAIC	22 kAIC	22 kAIC
15	#14–8	BQL15 ^a	HBQL15	BQL215		BQL315	HBQL315
20	#14–8	BQL20 ^a	HBQL20	BQL220		BQL320	—
25	#14–8	BQL25	HBQL25	BQL225		—	—
30	#14–8	BQL30	HBQL30	BQL230		BQL330	HBQL330
40	#14–4	BQL40	HBQL40	BQL240		BQL340	—
50	#14–4	BQL50	HBQL50	BQL250		BQL350	HBQL350
60	#8–2/0	BQL60	HBQL60	BQL260		BQL360	HBQL360
70	#8–2/0	—	—	BQL270		BQL370	HBQL370
90	#8–2/0	—	—	BQL290		BQL390	HBQL390
100	#8–2/0	—	—	BQL2100		BQL3100	HBQL3100
125	#8–2/0	—	—	BQL2125		—	—
135	#8–2/0	—	—	BQL2135		—	—
Requires one 1-inch (25.4 mm) space				Requires two 1-inch (25.4 mm) spaces		Requires three 1-inch (25.4 mm) spaces	

^a Switching duty rated (SWD).

Type BQL Duplex and Quadplex ^a

- 10,000 A interrupting capacity at 120/240 Vac
- Captive line screw included (#2 Robertson/Slot)

^a HACR rated.

Table 78. Type BQL Duplex and Quadplex bolt-on classic replacement circuit breakers

Duplex		Quadplex independent trip							
Two single-pole circuits		Two single-pole circuits and one two-pole circuit				Two two-pole circuits			
Ampere rating		Ampere rating				Ampere rating			
		120 Vac	120/240 Vac	120 Vac	120/240 Vac				
120 Vac	Catalogue number	Outer left (single-pole)	Centre (two-pole)	Outer right (single-pole)	Catalogue number	Outer left and right (two-pole)	Centre (two-pole)	Catalogue number	Wire size range (Cu/Al 60 °C or 75 °C) (AWG)
15–15	BQLT15 ^a	15	15	15	BQLT15215	15	15	BQLT215215	#14–4
20–20	BQLT20 ^a	15	20	15	BQLT15220	20	20	BQLT220220	#14–4
30–30	BQLT30 ^a	15	25	15	BQLT15225	15	30	BQLT215230	#14–4
—	—	15	30	15	BQLT15230	15	40	BQLT215240	#14–4
—	—	15	40	15	BQLT15240	—	—	—	#14–4
Requires one 1-inch (25.4 mm) space		Requires two 1-inch (25.4 mm) spaces				Requires two 1-inch (25.4 mm) spaces			

^a Switching duty rated (SWD).

Bolt-on Type BQL ground fault and moulded case switches

Type BQL ground fault circuit breakers

- 10,000 A interrupting capacity at 120/240 Vac
- 5 mA “people protection”

Product selection

5 mA single- and two-pole bolt-on ground fault circuit breakers are no longer able to be manufactured due to change in UL standard to require all GF devices to “Self Test.”

Type BQL non-automatic circuit breakers (moulded case switches)

- 240 Vac
- Two- and three-pole versions

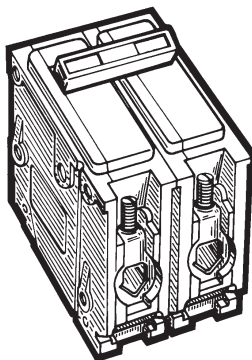

Non-automatic circuit breaker (moulded case switch)

Table 79. Two- and three-pole bolt-on non-automatic circuit breakers (moulded case switches)

Ampere rating	Wire size range Cu/Al 60 °C or 75 °C (AWG)	Catalogue number	
		Two-pole, 240 Vac	Three-pole, 240 Vac
60	#8-1 Cu #8-1/0 Al	BQL260NA Requires two 1-inch (25.4 mm) spaces	BQL360NA Requires three 1-inch (25.4 mm) spaces

Note: When the Canadian Electrical Code requires the use of an unfused disconnect device as a local isolation switch, then a circuit breaker enclosure may be used in conjunction with a moulded case switch (a.k.a. a non-automatic circuit breaker). For example, with an air conditioning unit, the protective device for these applications is located upstream.

Bolt-on Type QBH single-, multi-pole and accessories

Type QBH

- 120/240 Vac
- 3/4-inch form factor
- Designed to fit the classic CEB, Sylvania or Commander Electric design bolt-on loadcentres
- Suitable for loadcentres, lighting and distribution panelboards, and meter centres
- Silver Tungsten contacts with wiping action to prevent carbon buildup on the contact surface
- Handle provides clear indication of ON/OFF/TRIPPED position
- Quick-make / quick-break mechanism provides tease-proof operation
- Internal common trip mechanism on two-pole circuit breakers
- Each breaker is electronically calibrated for 40 °C
- Compression moulded housing and handle for durability and service

Table 80. Single- and two-pole bolt-on classic replacement circuit breakers

Ampere rating	Wire size range 60 °C or 75 °C (AWG)	Catalogue number	
		Single-pole, 120 Vac 10 kAIC	Two-pole, 120/240 Vac 10 kAIC
15	#14–10 Cu, #12–10 Al	QBH15	QBH215
20	#14–10 Cu, #12–10 Al	QBH20	QBH220
25	#14–10 Cu, #12–10 Al	QBH25	QBH225
30	#10–2 Cu, #10–1 Al	QBH30	QBH230
40	#10–2 Cu, #10–1 Al	QBH40	QBH240
50	#10–2 Cu, #10–1 Al	QBH50	QBH250
60	#10–2 Cu, #10–1 Al	QBH60	QBH260
70	#10–2 Cu, #10–1 Al	—	QBH270
90	#10–2 Cu, #10–1 Al	—	QBH290
100	#10–2 Cu, #10–1 Al	—	QBH2100
125	#10–1 Cu	—	QBH2125
		Requires one 3/4-inch (19.1 mm) space	Requires two 3/4-inch (19.1 mm) spaces

Type QBH accessories

Table 81. Type QBH classic bolt-on circuit breaker accessories

Description	Catalogue number
Handle tie	QBHT

Plug-in Type BJ two- and three-pole**Type BJ ^a**

- Main circuit breakers for classic Westinghouse NovaLine loadcentres
- 10,000 A interrupting capacity at 120/240 Vac

^a BJ breakers are also approved as branch circuit breakers on CPM/CPL panels 200 A and greater.

Table 82. Type BJ two- and three-pole plug-in classic replacement circuit breakers

Ampere rating	Wire size range Cu/Al 60 °C or 75 °C (AWG)	Catalogue number	
		Two-pole, 120/240 Vac 1 per shelf carton 10 kAIC	Three-pole, 120/240 Vac 1 per shelf carton 10 kAIC
125	#2–300 MCM	BJ2125	BJ3125
150	#2–300 MCM	BJ2150	BJ3150
175	#2–300 MCM	BJ2175	BJ3175
200	#2–300 MCM	BJ2200	BJ3200
		Requires four 1-inch (25.4 mm) spaces ^a	Requires six 1-inch (25.4 mm) spaces ^b

^a When mounted, the Type BJ circuit breakers span both sides of the bus bar occupying an equivalent number of pole spaces on both the left and right side of the loadcentre. For example a two-pole Type BJ circuit breaker occupies 2 pole spaces on the left and the same number of spaces on the right thus requiring four 1-inch spaces.

^b When mounted, the Type BJ circuit breakers span both sides of the bus bar occupying an equivalent number of pole spaces on both the left and right side of the loadcentre. For example a three-pole Type BJ circuit breaker occupies 3 pole spaces on the left and the same number of spaces on the right thus requiring six 1-inch spaces.

Pressure switches

- Ensures smooth delivery of water into your home
- Commercial, residential, or agricultural applications
- Can be used on all types of pumps
- Pressure ratings 20–40 PSI, 30–50 PSI, and 40–60 PSI
- Adjustable cut-in and cut-out pressure
- Easy installation
- CSA certified and UL listed
- Pulsation plug models prevent pump cycling due to water surges
- Low pressure cut-off models prevent pump burn out due to lack of well water (10 PSI below turn on pressure)
- 3-year product warranty



Pressure switch

Product selection

Table 83. Pressure switches

Description	Enclosure style	Catalogue number
20–40 PSI pressure switch	NEMA 1	CHWPS2040D
20–40 PSI pressure switch with pulsation plug	NEMA 1	CHWPS2040DP
20–40 PSI pressure switch with low pressure cut-off	NEMA 1	CHWPS2040DL
30–50 PSI pressure switch	NEMA 1	CHWPS3050D
30–50 PSI pressure switch with low pressure cut-off	NEMA 1	CHWPS3050DL
40–60 PSI pressure switch	NEMA 1	CHWPS4060D

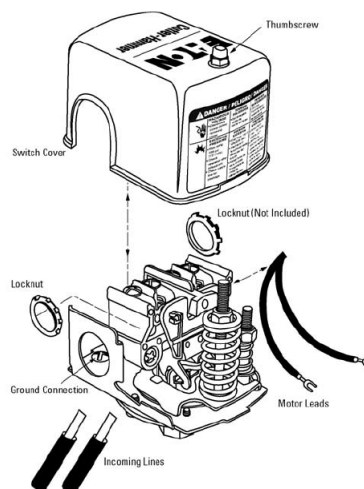

Table 84. Pressure switch ratings

Phase	Voltage (AC)	Amperage	Horsepower
Single	115	20	1.5
Handle tie	230	12	2.0

Table 85. Pressure switch cross-reference

Description	Catalogue number				
	Eaton	Square DT	Flotec ^T	Water Ace ^T	Furnas ^T
20–40 PSI pressure switch	CHWPS2040D	9013FSG2J20	—	15767A510	69WA4Z2040
20–40 PSI pressure switch with pulsation plug	CHWPS2040DP	9013FSG2J20P	—	—	69WA4Z2040B
20–40 PSI pressure switch with low pressure cut-off	CHWPS2040DL	9013FSG2J20M4	—	—	69WEC
30–50 PSI pressure switch	CHWPS3050D	9013FSG2J21	TC2151	15760A501	69WA4
30–50 PSI pressure switch with low pressure cut-off	CHWPS3050DL	9013FSG2J21M4	FP217-1140	19180A501	—
40–60 PSI pressure switch	CHWPS4060D	9013FSG2J24	TC2153	—	69WA4Z4060

Notes:

- CSA is a registered trademark of the Canadian Standards Association
- UL is a federally registered trademark of Underwriters Laboratories Inc.
- NEMA is the registered trademark and service mark of the National Electrical Manufacturers Association
- Square D is a federally registered trademark of Schneider Electric
- Flotec is a registered trademark of Flotec
- Furnas is a registered trademark of Siemens Energy and Automation, Inc.
- Water Ace is a registered trademark of the Pentair Pump Group

Index

1SL150PCO	50	3CBL230CU	40	BAB1010	41	BP27	18
1SL300PCO	50	3CBL242	39	BAB1015	41	BP31	18
1SL500PCO	50	3CBL242CU	40	BAB1015D	41	BP32	18
1SL502	51	3CBM118	37	BAB1020	41	BP41	18
1SL502NV	52	3CBM118CU	38	BAB1020D	41	BP54	18
1SL502NVE	52	3CBM130	37	BAB1025	41	BP3110C	15
1SL502S	51	3CBM130CU	38	BAB1030	41	BQHT-10	24
1SL502VE	52	3CBM142	37	BAB1040	41	BQL-10	44
1SL602	51	3CBM142CU	38	BAB1050	41	BQL15	61
1SL602NV	52	3CBM218	37	BAB1060	41	BQL20	61
1SL602NVE	52	3CBM230	37	BAB1070	41	BQL25	61
1SL602S	51	3CBM230CU	38	BAB2015	41	BQL30	61
1SL602VE	52	3CBM242	37	BAB2020	41	BQL40	61
1SL702	51	3CBSF100	44	BAB2030	41	BQL50	61
1SL702NV	52	3CBSF225	44	BAB2040	41	BQL60	61
1SL702NVE	52	3CCPL103	12	BAB2050	41	BQL215	61
1SL702S	51	3CPL112	12	BAB2060	41	BQL220	61
1SL702VE	52	3CPL112COV	15	BAB2070	41	BQL225	61
2SL150PCO	50	3CPL124	12	BAB2090	41	BQL230	61
2SL300PCO	50	3CPL124COV	15	BAB2100	41	BQL240	61
2SL500PCO	50	3CPL130	12	BAB2125	41	BQL250	61
2SL502	51	3CPL130COV	15	BAB3015H	41	BQL260	61
2SL502NV	52	3CPL136	12	BAB3020H	41	BQL260NA	62
2SL502NVE	52	3CPL136COV	15	BAB3030H	41	BQL270	61
2SL502S	51	3CPL218	12	BAB3040H	41	BQL290	61
2SL502VE	52	3CPL218COV	15	BAB3050H	41	BQL315	61
2SL602	51	3CPL224	12	BAB3060H	41	BQL320	61
2SL602NV	52	3CPL224COV	15	BAB3070H	41	BQL330	61
2SL602NVE	52	3CPL230	12	BAB3090H	41	BQL340	61
2SL602S	51	3CPL230COV	15	BAB3100H	41	BQL350	61
2SL602VE	52	3CPL242	12	BHGW-10	24	BQL360	61
2SL702	51	3CPL242COV	15	BHLW1-10	24	BQL360NA	62
2SL702NV	52	3CPL442	12	BHLW2-10	24	BQL370	61
2SL702NVE	52	3CPM112	8	BHLW-10	24	BQL390	61
2SL702S	51	3CPM112COV	15	BJ2125	64	BQL2100	61
2SL702VE	52	3CPM130	8	BJ2150	64	BQL2125	61
2SL706S	51	3CPM130COV	15	BJ2175	64	BQL2135	61
3BRS225	15	3CPM230	8	BJ2200	64	BQL3100	61
3BRS400	15	3CPM230COV	15	BJ3125	64	BQLT-15	61
3BRSF150	15	3CPM442	8	BJ3150	64	BQLT-15-215	61
3CBL118	39	48INT125B	25	BJ3175	64	BQLT-15-220	61
3CBL118CU	40	52-3125-5	15	BJ3200	64	BQLT-15-225	61
3CBL130	39	52-3125-6	15	BP2	18	BQLT-15-230	61
3CBL130CU	40	816INT125B	25	BP4	18	BQLT-15-240	61
3CBL142	39	1224INT125B	25	BP16	18	BQLT-20	61
3CBL142CU	40	1624INT125B	25	BP18	18	BQLT-30	61
3CBL218	39	2024INT125B	25	BP21	18	BQLT-215-215	61
3CBL230	39	2424INT125B	25	BP23	18	BQLT-215-230	61
				BP24	18	BQLT-215-240	61

BQLT-220-220 61	BR320E 21	BRH150E 21	BRH380E 21
BR115 17	BR325 17	BRH160 17	BRH390 17
BR115AF 19	BR325E 21	BRH160E 21	BRH390E 21
BR115E 21	BR330 17	BRH170 17	BRH2100 17
BR120 17	BR330E 21	BRH170E 21	BRH2100E 21
BR120AF 19	BR335 17	BRH215 17	BRH3100 17
BR120E 21	BR335E 21	BRH215E 21	BRH3100E 21
BR125 17	BR340 17	BRH220 17	BRL215AF 19
BR125E 21	BR340E 21	BRH220E 21	BRL220AF 19
BR130 17	BR345 17	BRH225 17	BRL220AFIT 19
BR130E 21	BR345E 21	BRH225E 21	BRLAFGFLOFF 24
BR135 17	BR350 17	BRH230 17	BRLW1-10 24
BR135E 21	BR350E 21	BRH230E 21	BRLW2-10 24
BR140 17	BR360 17	BRH235 17	BRLW-10 24
BR140E 21	BR360E 21	BRH235E 21	BRQLW-10 24
BR150 17	BR370 17	BRH240 17	BRS225 15
BR150E 21	BR370E 21	BRH240E 21	BRS400 15
BR160 17	BR380 17	BRH245 17	BRSF125 15
BR160E 21	BR380E 21	BRH245E 21	BRSURGE 48
BR170 17	BR390 17	BRH250 17	BR230SUR 48
BR170E 21	BR390E 21	BRH250E 21	BR250SUR 48
BR215 17	BR2100 17	BRH260 17	
BR215E 21	BR2100E 21	BRH260E 21	CBL118 39
BR220 17	BR2100NA 22	BRH270 17	CBL118CU 40
BR220E 21	BR2125 17	BRH270E 21	CBL130 39
BR225 17	BR3100 17	BRH280 17	CBL130CU 40
BR225E 21	BR3100E 21	BRH280E 21	CBL142 39
BR230 17	BRAF115C 19, 41	BRH290 17	CBL142CU 40
BR230E 21	BRAF120C 19	BRH290E 21	CBL218 39
BR235 17	BRCAFLOFF 24	BRH315 17	CBL218CU 40
BR235E 21	BRDL1-10 24, 44	BRH315E 21	CBL230 39
BR240 17	BRF115 19	BRH320 17	CBL230CU 40
BR240E 21	BRFP 15, 44	BRH320E 21	CBL242 39
BR245 17	BRH115 17	BRH325 17	CBL242CU 40
BR245E 21	BRH115CAF 19	BRH325E 21	CBM118 37
BR250 17	BRH115E 21	BRH330 17	CBM118CU 38
BR250E 21	BRH120 17	BRH330E 21	CBM130 37
BR250NA 22	BRH120CAF 19	BRH335 17	CBM130CU 38
BR260 17	BRH120E 21	BRH335E 21	CBM142 37
BR260E 21	BRH125 17	BRH340 17	CBM142CU 38
BR260NA 22	BRH125E 21	BRH340E 21	CBM218 37
BR270 17	BRH130 17	BRH345 17	CBM218CU 38
BR270E 21	BRH130E 21	BRH345E 21	CBM230 37
BR280 17	BRH135 17	BRH350 17	CBM230CU 38
BR280E 21	BRH135E 21	BRH350E 21	CBM242 37
BR290 17	BRH140 17	BRH360 17	CBSF100 44
BR290E 21	BRH140E 21	BRH360E 21	CBSF225 44
BR315 17	BRH145 17	BRH370 17	CC3100 23
BR315E 21	BRH145E 21	BRH370E 21	CC3125 23
BR320 17	BRH150 17	BRH380 17	CC3150 23

CC3200 23	CH310 31	CHP110 32	CHWPS2040DL 65
CCL300 24	CH315 31	CHP115 32	CHWPS2040DP 65
CCPL 24	CH320 31	CHP120 32	CHWPS3050D 65
CCPL102 10	CH325 31	CHP125 32	CHWPS3050DL 65
CCPL104 10	CH330 31	CHP130 32	CHWPS4060D 65
CCPL108 10	CH335 31	CHP135 32	CPL072 14
CH6L125R 30	CH340 31	CHP140 32	CPL072FGP 14
CH9FL 15	CH345 31	CHP145 32	CPL072R 14
CH30SPA 47	CH350 31	CHP150 32	CPL072RGP 14
CH40SPA 47	CH360 31	CHP160 32	CPL072SGP 14
CH50SPA 47	CH370 31	CHP170 32	CPL112WL 10
CH60SPA 47	CH380 31	CHP210 32	CPL112G3 46
CH115AF 33	CH390 31	CHP215 32	CPL112G6 46
CH115AFPN 33	CH3100 31	CHP220 32	CPL116WL 10
CH115EPD 34	CHF115 31	CHP225 32	CPL116W 10
CH115GF 34	CHF120 31	CHP230 32	CPL120WL 10
CH115GFPN 34	CHF125 31	CHP235 32	CPL120G6 46
CH120AF 33	CHF130 31	CHP240 32	CPL130WL 10
CH120AFPN 33	CHF135 31	CHP245 32	CPL130G6 46
CH120EPD 34	CHF140 31	CHP250 32	CPL220WL 10
CH120GF 34	CHF145 31	CHP260 32	CPL240WL 10
CH120GFPN 34	CHF150 31	CHP270 32	CPL400KIT 15
CH125EPD 34	CHF215 31	CHP280 32	CPL442 10
CH125GF 34	CHF220 31	CHP290 32	CPM112WL 6
CH130EPD 34	CHF225 31	CHP310 32	CPM116WL 6
CH160 31	CHF230 31	CHP315 32	CPM116Z 6
CH170 31	CHF235 31	CHP320 32	CPM120WL 6
CH215AF 33	CHF240 31	CHP325 32	CPM120Z 6
CH215EPD 34	CHF245 31	CHP330 32	CPM126GEN 46
CH215GF 34	CHF250 31	CHP335 32	CPM130WL 6
CH220AF 33	CHFAFGFLOFF 36	CHP340 32	CPM130Z 6
CH220EPD 34	CHFGFT130 34	CHP345 32	CPM140WL 6
CH220GF 34	CHFGFT130PN 34	CHP350 32	CPM140Z 6
CH225GF 34	CHFP 36	CHP360 32	CPM216WL 6
CH230EPD 34	CHHT 36	CHP370 32	CPM220WL 6
CH230GF 34	CHLO 36	CHP2100 32	CPM230WL 6
CH230SUR 48	CHM24PN100 30	CHP2110 32	CPM236GEN 46
CH235GF 34	CHM32PN100 30	CHP2125 32	CPM240WL 6
CH240EPD 34	CHM32PN200 30	CHP3100 32	CPM260 6
CH240GF 34	CHM42PN100 30	CHPL 36	CPM342 6
CH245GF 34	CHM42PN200 30	CHPLGF 36	CPM400KIT 15
CH250EPD 34	CHM60PN200L 30	CHRLS 36	CPM442 6
CH250GF 34	CHNL24PN125 30	CHSF2125 36	CPM1520WL 6
CH250SUR 48	CHNL32PN125 30	CHSPALARM 47	CPM1530WL 6
CH260 31	CHNL32PN225 30	CHSPCABLE 49	CPM1540WL 6
CH260EPD 34	CHNL42PN225 30	CHSPFMKIT 49	CQLP8100 59
CH260GF 34	CHNS 36	CHSPT2MICRO 49	CQLP12100 59
CH270 31	CHNT1515 31	CHSPT2ULTRA 49	CSABP4683B 59
CH280 31	CHNT1520 31	CHSPT23PACK 49	CSABP4734B 59
CH290 31	CHNT2020 31	CHWPS2040D 65	CSH2100N 35

CSH2150N 35	GFCBH125 20	P48G11S03P 56	QBG2050 43
CSH2200N 35	GFCBH130 20	P48G11S05CUB 57	QBGFEF1015 43
CSR2125N 23	GFCBH215 20	P48G11S05P 56	QBGFEF1020 43
CSR2150N 23	GFCBH220 20	P48G11S07CUB 57	QBGFEF1025 43
CSR2200N 23	GFCBH225 20	P48G11S07P 56	QBGFEF1030 43
CVRSCRW 15	GFCBH230 20	P48G11S10CUB 57	QBGFEF2015 43
	GFEP115 20	P48G11S10P 56	QBGFEF2020 43
DIRCARD42 44	GFEP120 20	P48G11S15CUB 57	QBGFEF2025 43
DIRSLEEVE 44	GFEP125 20	P48G11S15P 56	QBGFEF2030 43
DNBA1515 42	GFEP130 20	P48G11S25CUB 57	QBH15 63
DNBA2020 42	GFEP215 20	P48G11S25P 56	QBH20 63
DNBA3030 42	GFEP220 20	P48G28T15CUB 57	QBH25 63
DNPL1515 18, 21	GFEP225 20	P48G28T15P 56	QBH30 63
DNPL1520 18, 21	GFEP230 20	P48G28T21CUB 57	QBH40 63
DNPL1530 18	GFEP240 20	P48G28T21P 56	QBH50 63
DNPL2020 18, 21	GFEP250 20	P48G28T30CUB 57	QBH60 63
DNPL151515 18	GFXB115B2 22	P48G28T30P 56	QBH215 63
DNPL152015 18	GFXB120B2 22	P60G11S03CUB 57	QBH220 63
DNPL152515 18	GFXB125B2 22	P60G11S05CUB 57	QBH225 63
DNPL153015 18	GFXB130B2 22	P60G11S05P 56	QBH230 63
DNPL154015 18		P60G11S07CUB 57	QBH240 63
DNPL155015 18	HBQL15 61	P60G11S07P 56	QBH250 63
DNPL215215 18	HBQL20 61	P60G11S10CUB 57	QBH260 63
DNPL215220 18	HBQL25 61	P60G11S10P 56	QBH270 63
DNPL215230 18	HBQL30 61	P60G11S15CUB 57	QBH290 63
DNPL215240 18	HBQL40 61	P60G11S15P 56	QBH2100 63
DNPL220220 18	HBQL50 61	P60G11S25CUB 57	QBH2125 63
DNPL220230 18	HBQL60 61	P60G11S25P 56	QBHAF1015 42
DS075H1 15	HBQL315 61	P60G28T15CUB 57	QBHAF1020 42
DS100H1 15	HBQL330 61	P60G28T15P 56	QBHAF2015 42
DS125H1 15	HBQL350 61	P60G28T21CUB 57	QBHAF2015IT 42
DS150H1 15	HBQL360 61	P60G28T21P 56	QBHAG1020 42
DS200H1 15	HBQL370 61	P60G28T30CUB 57	QBHCAF102 42
DS200H2 15	HBQL390 61	P60G28T30P 56	QBHCAF1015 42
DS250H2 15	HBQL3100 61		QBHGFEP1015 43
DS300H2 15	HLW1-10 24	QBAF1015 42	QBHGFEP1020 43
GFCB115 20		QBAF1020 42	QBHGFEP1025 43
GFCB120 20	ISGRD 15, 44	QBAF2015 42	QBHGFEP1030 43
GFCB125 20		QBAF2015IT 42	QBHGFEP2015 43
GFCB130 20	LCCS 36	QBAG1020 42	QBHGFEP2020 43
GFCB140 20		QBCAF1015 42	QBHGFEP2025 43
GFCB215 20	MCBL300 24	QBCAF1020 42	QBHGFEP2030 43
GFCB220 20	MCBPL 24, 36	QBGF1015 43	QBHT 63
GFCB225 20		QBGF1020 43	QBHW1015 41
GFCB230 20	NL20 15	QBGF1030 43	QBHW1020 41
GFCB240 20	NL30 15	QBGF1040 43	QBHW1030 41
GFCB250 20	NL300 15	QBGF2015 43	QBHW1040 41
GFCB260 20	NSP42 15	QBGF2020 43	QBHW1050 41
GFCBH115 20		QBGF2030 43	QBHW1060 41
GFCBH120 20	P48G11S03CUB 57	QBGF2040 43	QBHW1070 41

QBHW2015 41	QLPT19D 60	RCPM2GF6H 54
QBHW2020 41	QLPT20AD 60	RCPM2GF10 54
QBHW2030 41	QLPT22AD 60	RCPM108M 53
QBHW2040 41	QLPT24D 60	RCPM112 7
QBHW2050 41	R3CCPL103 13	RCPM120 7
QBHW2060 41	R3CPL112 13	RCPM130 7
QBHW2070 41	R3CPL130 13	RCPM208M 53
QBHW2090 41	R3CPL136 13	RCPM220 7
QBHW2100 41	R3CPL230 13	RCPM230 7
QBHW2125 41	R3CPL242 13	RCPM240 7
QBHW3015 41	R3CPM112 9	RCPM1530 7
QBHW3020 41	R3CPM130 9	RH75P 15
QBHW3030 41	R3CPM230 9	RH100P 15
QBHW3040 41	RCCHL102 30	RH125P 15
QBHW3050 41	RCCPL102 11	SPC61 15
QBHW3060 41	RCCPL104 11	SPCWH 15
QBHW3070 41	RCCPL108 11	
QBHW3090 41	RCPL112 11	
QBHW3100 41	RCPL120 11	TDL 15, 36, 44
QL1NPL 44	RCPL130 11	THOW-10 24
QL23NPL 44	RCPL220 11	THS1 24
QL123PL 44	RCPL240 11	
QLPT16AD 60	RCPM1GF6H 54	
QLPT16D 60	RCPM1GF10 54	

Eaton
1000 Eaton Boulevard
Cleveland, OH 44122
United States
Eaton.com

Canadian Operations
5050 Mainway
Burlington, ON L7L 5Z1
Canada
EatonCanada.ca

© 2017 Eaton
All Rights Reserved
Printed in Canada
Publication No. CA003008EN
December 2017

Residential and light commercial distribution products



EATON

Powering Business Worldwide

Contents

Description	Page
Type CPM/CPL plug-in loadcentres	5
Combination (main circuit breaker) single-phase Type 1	6
Combination (main circuit breaker) single-phase Type 3R	7
Combination (main circuit breaker) three-phase Type 1	8
Combination (main circuit breaker) three-phase Type 3R	9
Type CPL plug-in loadcentres	5
Non-combination (main lug only) three-phase Type 1	10
Non-combination (main lug only) single-phase Type 3R	11
Non-combination (main lug only) three-phase Type 1	12
Non-combination (main lug only) three-phase Type 3R	13
Non-combination (main lug only) 70 A single-phase	14
Type CPM/CPL plug-in loadcentre Accessories	15
Plug-in circuit breakers for CPM/CPL	16
Type BR, DNPL, GFTCB, GFEP and GFXB	16
Type BR single- and multi-pole	17
Type DNPL Duplex, Independent Quadplex and circuit breaker packs	18
Type BR arc fault circuit interrupter	19
Types GFCB and GFEP ground fault	20
Types GFCB ground fault and Type BR internationally rated	21
Types GFXB internationally rated ground fault and Type BR moulded case switches	22
Plug-in loadcentre main circuit breakers for CPM/CPL	23
Types CSR and CC	23
Plug-in circuit breaker accessories for CPM/CPL loadcentres	24
Plug-in OEM loadcentre interior assemblies	25
Type CH plug-in loadcentres	29
Combination and non-combination single-phase	30
Plug-in circuit breakers for CH	31
Type CH single-, multi-pole and twin	31
Type CHP commercial	32
Type CHP arc fault circuit interrupter	33
Type CHP ground fault	34
Plug-in loadcentre main circuit breakers for CH	35
Type CSR	35
Plug-in loadcentres and circuit breaker accessories for CH	36
Type CH accessories	36

Contents (continued)

Description	Page
Type CBM bolt-on loadcentres	37
Combination (main circuit breakers) single- and three-phase aluminum bus	37
Combination (main circuit breakers) single- and three-phase copper bus	38
Non-combination (main lug only) single- and three-phase aluminum bus	39
Non-combination (main lug only) single- and three-phase copper bus	40
Bolt-on circuit breakers for CMB/CBL	41
Type BAB and QBHW single- and multi-pole	41
Type QBA arc fault circuit interrupter and DNBA duplex	42
Type QBGF and QBGFEP ground fault	43
Bolt-on loadcentre and circuit breaker accessories	44
Manual transfer switches/generator panels	45
Spa panels	47
Surge suppression products	48
Stage 1 and Stage 1 Type 2	48
Accessories	49
Street lighting panels	50
In-pole	50
On-pole	51
Pedestal	52
Combined loadcentre and meter socket	53
Metered temporary ground fault power panel	54
Mini-power centres	55
Plug-in mini-power centres	56
Plug-in	56
Bolt-on mini-power centres	57
Bolt-on	57
Residential fuse panel inserts	58
Insert interiors	59
Trims	60
Replacement classic circuit breakers	61
Bolt-on Type BQL single-, multi-pole, Duplex and Quadplex	61
Bolt-on Type BQL ground fault and moulded case switches	62
Bolt-on Type QBH single-, multi-pole and accessories	63
Plug-in Type BJ two- and three-pole	64
Pressure switches	65
Index	66

Type CPM/CPL plug-in loadcentres

Product description

Loadcentres feature factory installed main lugs or main breakers. The BR interiors are manufactured of formed, plated aluminum. Eaton also supplies a full line of Eaton brand BR, DNPL, GFCB and GFEP type branch circuit breakers and accessories for these loadcentres.

Product application

Designed for the protection and distribution of single and multi-dwelling residential and light commercial loads to 120/240 volts AC, such as lighting, heating, appliance and small motor branch circuits.

All main breaker combination loadcentres are CSAT listed for use as service entrance equipment.

Ratings

Single-phase, three-wire, 120/240 volts AC and three-phase, four-wire, 120/208 volts AC. Mains through 400 A. Available with up to 84 branch circuits. Main breakers on 150 and 200 A panels are rated at 25,000 AIC.

Metal enclosure specifications

Enclosures are made of 16 gauge sheet steel, either galvanized or epoxy painted. These coatings provide superior corrosion protection. All trims used on BR loadcentres are chromate sealed and finished with an electro-disposition epoxy paint in grey (ANSI-61) or white, which exceeds requirements for outdoor and indoor applications. A combination surface/flush cover with integral door is supplied with indoor loadcentres rated from 100 through 400 A.

All plug-in loadcentres are CSA listed to file LL98266. CSA certified to C22.2 No.29.

Warranty

10 year limited.

Type CPM/CPL loadcentre features and benefits

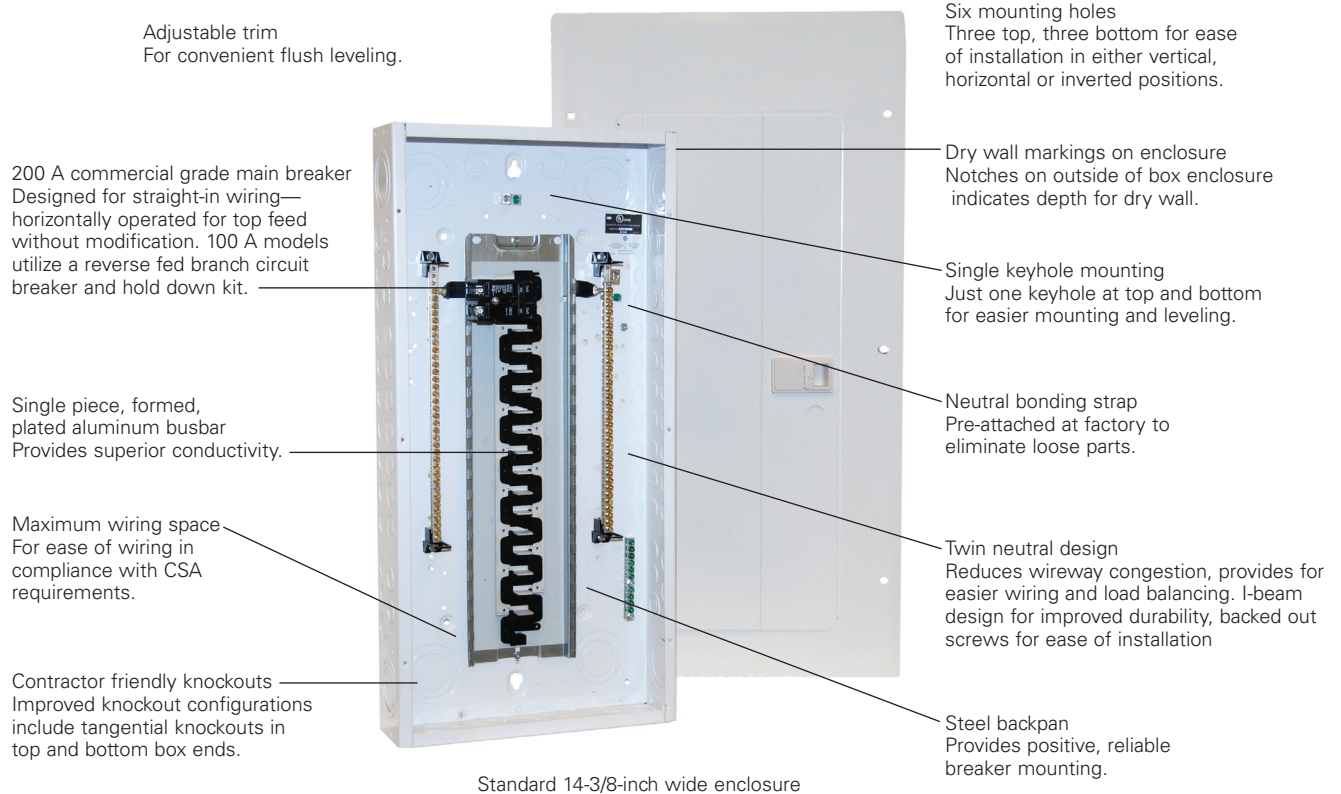

Type CPM plug-in loadcentres

Combination (main circuit breaker) single-phase Type 1

Three-wire, 120/240 Vac combination service entrance Type 1 (indoor)

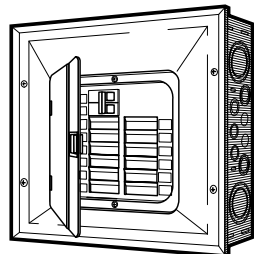

CPM112

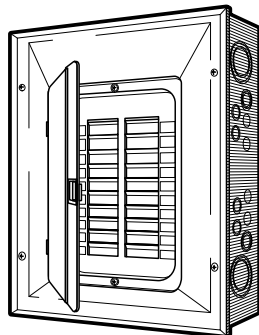

CPM120WL

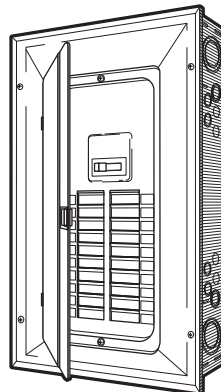

CPM1520

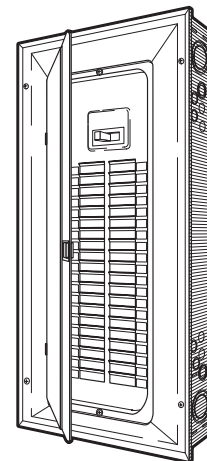

CPM240WL

Product selection

Table 1. Main circuit breaker indoor Type 1 loadcentres

Maximum ampere rating	Main breaker rating	Catalogue number	Max. no. 1-inch spaces	Max. no. 1/2-inch spaces	Cover style	Type of main breaker	Dimensions (inches)			Wire size range for main CU/AL
							H	W	D	
125	100	CPM112WL ^d	12	24	Flush/surface	BRH ^b	18-3/4	14-3/8	3-7/8	#8-1/0
125	100	CPM116WL ^d	16	32	Flush/surface	BRH ^b	21	14-3/8	3-7/8	#8-1/0
125	125	CPM116Z	16	32	Flush/surface	BRH ^c	21	14-3/8	3-7/8	#4-2/0
125	100	CPM120WL ^d	20	40	Flush/surface	BRH ^b	27	14-3/8	3-7/8	#8-1/0
125	125	CPM120Z	20	40	Flush/surface	BRH ^c	27	14-3/8	3-7/8	#4-2/0
125	100	CPM130WL ^d	30	60	Flush/surface	BRH ^b	29-1/8	14-3/8	3-7/8	#8-1/0
125	125	CPM130Z	30	60	Flush/surface	BRH ^c	29-1/8	14-3/8	3-7/8	#4-2/0
125	100	CPM140WL ^d	40	80	Flush/surface	BRH ^b	34-1/8	14-3/8	3-7/8	#8-1/0
125	125	CPM140Z	40	80	Flush/surface	BRH ^b	34-1/8	14-3/8	3-7/8	#8-1/0
150	150	CPM1520WL ^d	20	40	Flush/surface	CSR ^e	29-1/8	14-3/8	3-7/8	#2-300 MCM
150	150	CPM1530WL ^d	30	60	Flush/surface	CSR ^e	34-1/8	14-3/8	3-7/8	#2-300 MCM
150	150	CPM1540WL ^d	40	80	Flush/surface	CSR ^e	39	14-3/8	3-7/8	#2-300 MCM
200	200	CPM216WL ^d	16	32	Flush/surface	CSR ^e	29-1/8	14-3/8	3-7/8	#2-300 MCM
200	200	CPM220WL ^d	20	40	Flush/surface	CSR ^e	29-1/8	14-3/8	3-7/8	#2-300 MCM
200	200	CPM230WL ^d	30	60	Flush/surface	CSR ^e	34-1/8	14-3/8	3-7/8	#2-300 MCM
200	200	CPM240WL ^d	40	80	Flush/surface	CSR ^e	39	14-3/8	3-7/8	#2-300 MCM
200	200	CPM260	60	120	Flush/surface	CSR ^e	49	14-3/8	3-7/8	#2-300 MCM
400	300	CPM342	42	84	Flush/surface	DK ^f	66-1/2	16-1/8	6-5/16	(2)#2/0-250 MCM or (1)#2/0-500 MCM ^h
400	400	CPM442	42	42 ^g	Flush/surface	DK ^f	66-1/2	16-1/8	6-5/16	(2)#2/0-250 MCM or (1)#2/0-500 MCM ^h

a Type BR—100 A 10 kAIC main circuit breaker is factory installed (BR2100).

b High Interrupting 22 kAIC BRH breakers

c 22 kAIC BRH2125 main breaker is factory installed.

d Suffix WL denotes "white loadcentre" painted tub and trim.

e Factory installed 25 kAIC main breaker.

f DK breaker is a 65 kAIC, factory-sealed breaker.

g Restricted due to available neutrals, extra neutrals are available on **page 15** which will expand available circuitry to a maximum of 84 circuits.

h 3TA401K must be ordered separately for #2/0-500-MCM.

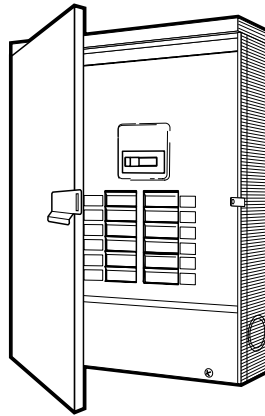
Combination (main circuit breaker) single-phase Type 3RThree-wire 120/240 Vac combination service entrance Type 3R (outdoor/raintight) ^a

RCPM220

Table 2. Main circuit breaker outdoor/raintight Type 3R loadcentres ^a

Maximum ampere rating	Main breaker rating	Catalogue number	Max. no. 1-inch spaces	Max. no. 1/2-inch spaces	Cover style	Type of main breaker	Dimensions (inches)			Wire size range for main Cu/Al
							H	W	D	
125	100	RCPM112 ^b	12	24	Outdoor	BR ^{cd}	18-1/2	14-3/8	5	#8-1/0
125	100	RCPM120 ^b	20	40	Outdoor	BR ^{cd}	25	14-3/8	5	#8-1/0
125	100	RCPM130 ^b	30	60	Outdoor	BR ^{cd}	28-7/8	14-3/8	5	#8-1/0
150	150	RCPM1530 ^b	30	60	Outdoor	CSR ^e	33-7/8	14-3/8	5	#2-300 MCM
200	200	RCPM220 ^b	20	40	Outdoor	CSR ^e	28-7/8	14-3/8	5	#2-300 MCM
200	200	RCPM230 ^b	30	60	Outdoor	CSR ^e	33-7/8	14-3/8	5	#2-300 MCM
200	200	RCPM240 ^b	40	80	Outdoor	CSR ^e	38-3/4	14-3/8	5	#2-300 MCM

^a Outdoor loadcentres accommodate Type DS conduit hubs. Hubs not included. See **page 15** for selection.

^b All enclosures include a locking hasp as an integral part of the door latching mechanism.

^c Type BR—100 A 10 kAIC main circuit breaker is factory installed (BR2100).

^d High interrupting BRH breakers are available on **page 17**.

^e Factory installed 25 kAIC main breaker.

Combination (main circuit breaker) three-phase Type 1

Four-wire 120/208 Vac combination service entrance Type 1 (indoor)

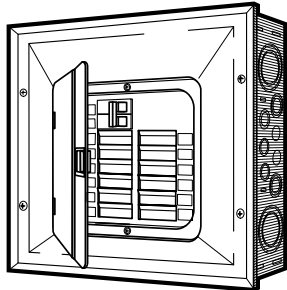

3CPM112

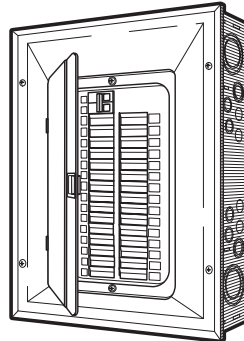

3CPM130

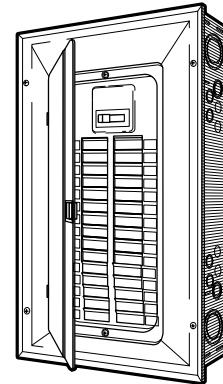

3CPM230

Table 3. Main circuit breaker indoor Type 1 loadcentres

Maximum ampere rating	Main breaker rating	Catalogue number	Max. no. 1-inch spaces	Max. no. 1/2-inch spaces	Cover style	Type of main breaker	Dimensions (inches)			Wire size range for main Cu/Al
							H	W	D	
125	100	3CPM112	12	24	Flush/surface	BR ^{bc}	21	14-3/8	3-3/4	#4-1/0
125	100	3CPM130	30	60	Flush/surface	CC ^d	39	14-3/8	3-3/4	#4-4/0
200	200	3CPM230	30	60	Flush/surface	CC ^d	39	14-3/8	3-3/4	#1-250 MCM
400	400	3CPM442 ^a	42	42 ^a	Flush/surface	DK ^e	66-1/2	16-1/8	6-5/16	(2) 2/0-250 MCM (1) 2/0-500 MCM ^f

^a Extra neutrals which will expand available circuitry to a maximum of 84 circuits are available on [page 15](#).

^b Type BR—100 A 10 kAIC main circuit breaker is factory installed (BR3100).

^c High interrupting BRH breakers are available on [page 17](#).

^d Factory installed 10 kAIC main breaker.

^e DK Breaker is a 65 kAIC factory-sealed main breaker.

^f Circuit breaker lug kit 3TA401 must be ordered separately to accept #2/0-500 MCM cabling.

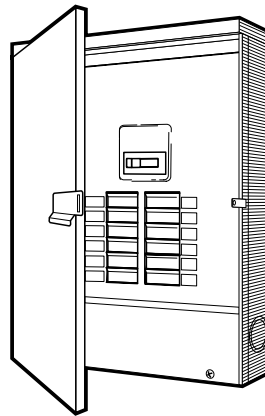
Combination (main circuit breaker) three-phase Type 3RFour-wire 120/208 Vac combination service entrance Type 3R (outdoor/raintight) ^{ab}

R3CPM230

Table 4. Main circuit breaker outdoor/raintight Type 3R loadcentres ^{ab}

Maximum ampere rating	Main breaker rating	Catalogue number	Max. no. 1-inch spaces	Max. no. 1/2-inch spaces	Cover style	Type of main breaker	Dimensions (in)			Wire size range for main Cu/Al
							H	W	D	
100	100	R3CPM112 ^b	12	24	Outdoor	BR ^{cd}	20-3/4	14-3/8	5	#4-1/0
125	100	R3CPM130 ^b	30	60	Outdoor	CC ^e	38-3/4	14-3/8	3-3/4	#4-4/0
200	200	R3CPM230 ^b	30	60	Outdoor	CC ^e	38-3/4	14-3/8	3-3/4	#1-250 MCM

^a Outdoor loadcentres accommodate Type DS conduit hubs. Hubs not included. See **page 15** for selection.

^b All enclosures include a locking hasp as an integral part of the door latching mechanism.

^c Type BR—100 A 10 kAIC main circuit breaker is factory installed (BR3100).

^d High interrupting BRH breakers are available on **page 17**.

^e Factory installed 10 kAIC main breaker.

Type CPL plug-in loadcentres

Non-combination (main lug only) single-phase Type 1

Three-wire 120/240 Vac non-combination Type 1 (indoor)

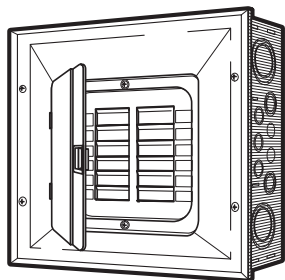

CPL112

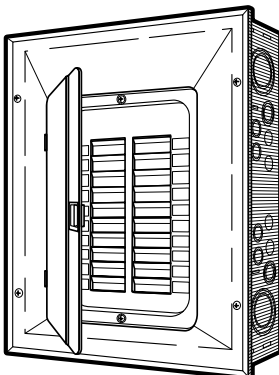

CPL220

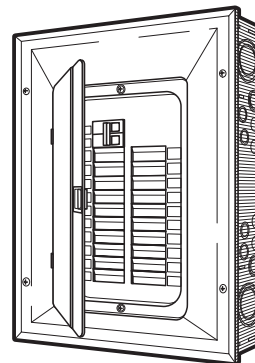

CPL120

Product selection

Table 5. Main lug only indoor Type 1 loadcentres

Maximum Ampere Rating	Catalogue Number	Max. no. 1-inch spaces	Max. no. 1/2-inch spaces	Cover style	Dimensions (inches)			Wire size range for main Cu/Al
					H	W	D	
100	CCPL102	2 ^a	4	Surface	11-1/2	6-3/4	3-1/4	#14-1/0
125	CCPL104	4	8	Flush/surface	13	11	3-1/2	#14-2/0
125	CCPL108	8	16	Flush/surface	13	11	3-1/2	#14-2/0
125	CPL112WL ^b	12	24	Flush/surface	16-3/4	14-3/8	3-7/8	#14-2/0
125	CPL116WL ^b	16	32	Flush/surface	18-3/4	14-3/8	3-7/8	#14-2/0
125	CPL120WL ^b	20	40	Flush/surface	21	14-3/8	3-7/8	#14-2/0
125	CPL130WL ^b	30	60	Flush/surface	29-1/8	14-3/8	3-7/8	#14-2/0
200	CPL220WL ^b	20	40	Flush/surface	27	14-3/8	3-7/8	#1-300 MCM
200	CPL240WL ^b	40	80	Flush/surface	34-1/8	14-3/8	3-7/8	#1-300 MCM
400	CPL442	42	42 ^c	Flush/surface	54	16-1/8	6-5/16	(1) 250-750 MCM (2) 3/0-250 MCM

^a Service equipment approved when used with two-pole BR type breaker.

^b Suffix WL Loadcentre comes with a painted white case, trim and door.

^c Extra neutrals which will expand available circuitry to a maximum of 84 circuits are available on [page 15](#).

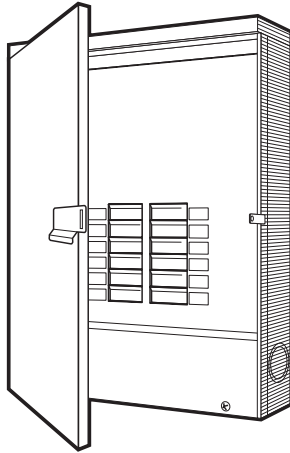
Non-combination (main lug only) single-phase Type 3RThree-Wire 120/240 Vac non-combination Type 3R (outdoor/raintight) ^a

RCPL112

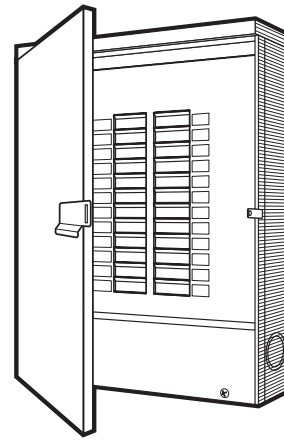

RCPL220

Table 6. Main lug only outdoor/raintight Type 3R loadcentres ^a

Maximum ampere rating	Catalogue number	Max. no. 1-inch spaces	Max. no. 1/2-inch spaces	Cover Style	Dimensions (inches)			Wire size range for main Cu/Al
					H	W	D	
125	RCCPL102 ^b	2 ^c	4	Outdoor	11-1/2	6-1/2	4	#14-2/0
125	RCCPL104 ^b	4	8	Outdoor	13	11	3-1/2	#14-2/0
125	RCCPL108 ^b	8	16	Outdoor	13	11	3-1/2	#14-2/0
125	RCPL112 ^b	12	24	Outdoor	16-1/2	14-3/8	5	#14-2/0
125	RCPL120 ^b	20	40	Outdoor	20-3/4	14-3/8	5	#14-2/0
125	RCPL130 ^b	30	60	Outdoor	28-7/8	14-3/8	5	#14-2/0
200	RCPL220 ^b	20	40	Outdoor	25	14-3/8	5	#1-300 MCM
200	RCPL240 ^b	40	80	Outdoor	33-7/8	14-3/8	5	#1-250 MCM

^a Outdoor loadcentres accommodate Type DS conduit hubs. Hubs not included. See **page 15** for selection.^b All enclosures include a locking hasp as an integral part of the door latching mechanism.^c Service equipment approved when used with two-pole BR type breaker.

Non-combination (main lug only) three-phase Type 1

Four-wire 120/208 Vac non-combination Type 1 (indoor)

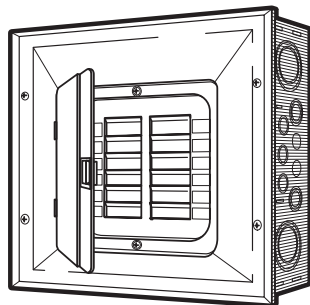

3CPL112

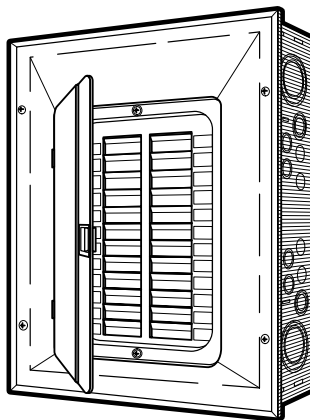

3CPL224

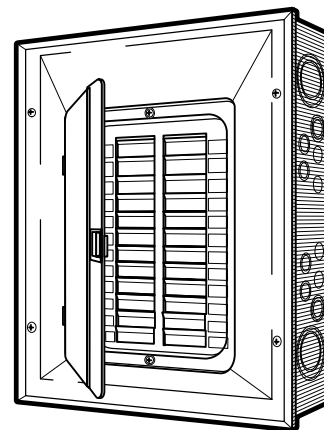

3CPL124

Table 7. Main lug only indoor Type 1 loadcentres

Maximum ampere rating	Catalogue number	Max. no. 1-inch spaces	Max. no. 1/2-inch spaces	Cover style	Dimensions (inches)			Wire size range for main Cu/Al
					H	W	D	
100	3CCPL103	3 ^a	6	Surface	14-1/4	6-1/2	3-1/4	#14-2/0
125	3CPL112	12	24	Flush/surface	21	14-3/8	3-7/8	#8-2/0
125	3CPL124	24	48	Flush/surface	29	14-3/8	3-3/4	#8-2/0
125	3CPL130	30	60	Flush/surface	34.12	14-3/8	3-3/4	#8-2/0
125	3CPL136	36	72	Flush/surface	39	14-3/8	3-3/4	#8-2/0
200	3CPL218	18	36	Flush/surface	27	14-3/8	3-7/8	#2-300 MCM
200	3CPL224	24	48	Flush/surface	34.12	14-3/8	3-7/8	#2-300 MCM
200	3CPL230	30	60	Flush/surface	34.12	14-3/8	3-3/4	#2-300 MCM
200	3CPL242	42	84	Flush/surface	39	14-3/8	3-7/8	#2-300 MCM
400	3CPL442	42	42 ^b	Flush/surface	54	16-3/8	6-5/16	(1) 250-750 MCM (2) 3/0-250 MCM

^a Suitable for use as service equipment when used with three-pole BR type breaker.

^b Extra neutrals which will expand available circuitry to a maximum of 84 circuits are available on **page 15**.

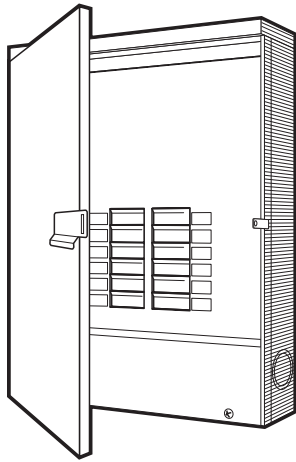
Non-combination (main lug only) three-phase Type 3RFour-wire 120/208 Vac non-combination Type 3R (outdoor/raintight) ^a

R3CPL112

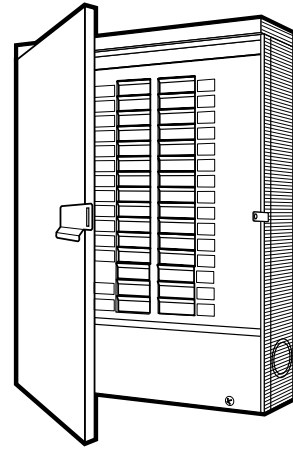

R3CPL230

Table 8. Main lug only outdoor/raintight Type 3R Loadcentres ^a

Maximum ampere rating	Catalogue number	Max. no. 1-inch spaces	Max. no. 1/2-inch spaces	Cover style	Dimensions (inches)			Wire size range for main Cu/Al
					H	W	D	
100	R3CCPL103 ^b	3 ^c	—	Outdoor	14-1/4	7	3-1/2	#14-2/0
125	R3CPL112 ^b	12	24	Outdoor	20-3/4	14-3/8	5	#14-2/0
125	R3CPL130 ^b	30	60	Outdoor	38-3/4	14-3/8	5	#14-2/0
125	R3CPL136 ^b	36	72	Outdoor	38-3/4	14-3/8	5	#14-2/0
200	R3CPL230 ^b	30	60	Outdoor	33-7/8	14-3/8	5	#2-300 MCM
200	R3CPL242 ^b	42	42 ^d	Outdoor	38-3/4	14-3/8	5	#2-300 MCM

^a Outdoor loadcentres accommodate Type DS conduit hubs. Hubs not included. See **page 15** for selection.

^b All enclosures include a locking hasp as an integral part of the door latching mechanism.

^c Suitable for use as service equipment when used with three-pole BR type breaker.

^d Extra neutrals to expand available circuitry to a maximum of 84 circuits are available on **page 15**.

Non-combination (main lug only) 70 A single-phase

Three-wire 250 Vac maximum non-combination

Service entrance approved when used with two-pole BR or BRH breakers. ^a

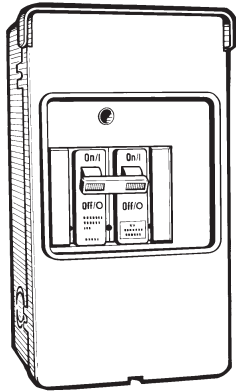

CPL072 indoor



CPL072R outdoor



CPL072FGP flush



CPL072SGP surface



CPL072RGP outdoor

Table 9. 70 A main lug only polymeric and metallic loadcentres

Maximum ampere rating	Enclosure style	Material	Catalogue number	Max. no. 1-inch spaces	Max. no. 1/2-inch spaces	Dimensions (inches)			Wire size range for main Cu/Al
						H	W	D	
70	Indoor Type 1 ^b	Polymeric	CPL072	2	4	8-5/8	5	3-1/4	#14-2
70	Indoor/outdoor Type 3R ^b	Polymeric	CPL072R ^c	2	4	8-11/16	6-1/4	4-5/16	#14-2
70	Indoor Type 1 flush mount ^b	Metallic	CPL072FGP	2	4	9-7/16	4-1/2	3	#14-2
70	Indoor Type 1 surface mount ^b	Metallic	CPL072SGP	2	4	9-7/16	4-1/2	3	#14-2
70	Indoor/outdoor Type 3R ^b	Metallic	CPL072RGP ^{cd}	2	4	9-7/16	4-1/2	3	#14-2

^a BR and BRH two-pole breakers can be found on **page 17**.

^b Service entrance approved when used with two-pole BR/BRH breakers.

^c The circuit breaker protective cover incorporates a locking hasp.

^d Uses DS*H1 style hubs found on **page 15**.

Type CPM/CPL plug-in loadcentre accessories

Table 10. Plug-in loadcentre accessories

Description	Catalogue number	Description	Catalogue number
Number strips for CPL/CPM 42 circuits a	NSP42	Door lock for 4–8 circuit 125 A (CPM/CPL)	CH9FL k
Circuit identification labels (e.g. hot water heater) b	BP3110C	Door lock for 12–42 circuit 100–225 A and 400 A (CPM/CPL)	TDL k
Replacement outer trim CPL112WL c	CBRTRIM16	Isolated ground kit	ISGRD
Replacement outer trim CPL116WL, CPM112WL c	CBRTRIM18	Trim screw kit (CPM/CPL) d	CVRSCRW
Replacement outer trim CPL120WL, CPM116WL c	CBRTRIM21	Trim screw kit white (order in quantities of 25)	LCCSW
Replacement outer trim CPL220WL, CPM120WL c	CBRTRIM27	3/4-inch hub for 100–125 A Type 3R loadcentres (3 x 2-3/4 inches) e	DS075H1
Replacement outer trim CPL130WL, CPM130WL, CPM1520WL, CPM216WL, CPM220WL c	CBRTRIM29	1-inch hub for 100–125 A Type 3R loadcentres (3 x 2-3/4 inches) e	DS100H1
Replacement outer trim CPL240WL, CPM140WL, CPM1530WL, CPM230WL c	CBTRTIM34	1-1/4 inch hub for 100–125 A Type 3R loadcentres (3 x 2-3/4 inches) e	DS125H1
Replacement outer trim CPM1540WL, CPM240WL c	CBRTRIM39	1-1/2 inch hub for 100–125 A Type 3R loadcentres (3 x 2-3/4 inches) e	DS150H1
Ground Bar Kit 5 position	GBK5	2-inch hub for 100–125 A Type 3R loadcentres (3 x 2-3/4 inches) e	DS200H1
Ground Bar Kit 8 position	GBK8	2-inch hub for 150 and 200 A Type 3R loadcentres (4-3/4 x 4-5/8 inches)	DS200H2
Ground Bar Kit 10 position	GBK10	2-1/2 inch hub for 150 and 200 A Type 3R loadcentres (4-3/4 x 4-5/8 inches)	DS250H2
Ground Bar Kit 14 position	GBK14	3-inch hub for 150 and 200 A Type 3R loadcentres (4-3/4 x 4-5/8 inches)	DS300H2
Ground Bar Kit 21 position	GBK21	3/4-inch hub for R3CCPL103 loadcentres (2-1/8 x 3-1/4 inches)	RH75P
		1-inch hub for R3CCPL103 loadcentres (2-1/8 x 3-1/4 inches)	RH100P
		1-1/4 inch hub for R3CCPL103 loadcentres (2-1/8 x 3-1/4 inches)	RH125P
		1-inch filler plate kit f	BRFP
		Subfeed kit for 125 A loadcentres #8–2/0 g	BRSF125
		Subfeed kit for 150 A three-phase loadcentres #8–2/0 g	3BRSF150
		Subfeed kit for 225 A loadcentres #2–300 MCM g	BRS225
		Subfeed kit for 225 A three-phase loadcentres #2–300 MCM g	3BRS225
		Subfeed kit for 400 A loadcentres #8–300 MCM g	BRS400
		Subfeed kit for 400 A three-phase loadcentres g	3BRS400
		Neutral/ground lug kit for 2/0 h	NL20
		Neutral/ground lug kit for 3/0 h	NL30
		Neutral/ground lug kit for 300 MCM (maximum) h	NL300
Neutral kit for 400 A non-combination loadcentres j	CPL400KIT	Neutral kit for 400 A combination loadcentres i	CPM400KIT
White plastic replacement door latch	52-3125-6	Grey plastic replacement door latch	52-3125-5
White spray can touch up paint	SPCWH	Grey spray can touch up paint	SPC61

a 25 per package. Catalogue number represents one package.

b 50 per package. Catalogue number represents one package.

c Includes outer trim only, no door, and no deadfront.

d 100 per package. Catalogue number represents one package.

e Except R3CCPL103.

f Kit includes 25 pieces.

g Line/Load terminals supplied only. Neutral conductor must be purchased separately. See above listed kits.

h Neutral bolts to main neutral bar i.e. remove screw and install lug kit.

i Kit includes 2 neutral bars.

j Kit includes 1 neutral bar.

k Comes with a set of keys.

Plug-in circuit breakers for CPM/CPL

Type BR, DNPL, GFCB, GFEP, and GFXB

BR circuit breakers

Eaton Type BR plug-in breakers in the standard 1-inch per pole moulded case and can be used as main and/or branch disconnect devices. All are CSA and UL listed. Typical ampacity range for BR breakers is 15 through 125 A. ^a

FIRE-GUARDE arc fault circuit interrupter (AFCI)

The FIRE-GUARD arc fault circuit interrupter (AFCI) is a residential circuit breaker with an integrated processor which recognizes the unique current and/or voltage signatures associated with arcing faults, and acts to interrupt the circuit to reduce the likelihood of an electrical fire. With the Eaton Fire-Guard AFCI, protection from arcing faults is combined with conventional thermal and magnetic overloads as found in standard residential circuit breakers protecting wiring from excessive heat or damage due to overloading or short circuits. Fire-Guard AFCI can also be equipped with 5 mA ground fault protection to protect from personal shock hazards. Now, there is a residential circuit breaker that provides protection from arcing faults, conductor damage due to thermal overloads and short circuits, as well as 5 mA ground fault protection in one integrated design.

GFTCB people protection breakers

Eaton Type GFCB (ground fault circuit breaker) combines state-of-the-art electronic technology with a circuit breaker mechanism in a compact 1-inch per pole moulded case. The GFCB automatically

senses hot wire-to-ground faults in a 4 to 6 mA range and shuts off the power thus providing an extra margin of safety beyond that of conventional circuit breakers. GFCB applications include bathrooms, basement outlets, swimming pools, outdoor branch circuits and kitchen branch circuits. Self testing compliant to new codes. Type GFCB breakers are also available in 30 mA equipment protectors. 30 mA breakers are for equipment requiring a higher interrupting value such as heat tracing.

DNPL twin circuit breakers

DNPL plug-in breakers have the same construction as Eaton Type BR 1-inch per pole devices except that two single-pole circuits are provided in a 1-inch space. ^a CSA listed interrupting rating is 10,000 AIC. All ratings are CSA and UL listed.

DNPL quad circuit breakers

QuadplexE construction of Eaton Type DNPL plug-in breakers provides various combinations of two-pole and single-pole devices in a 2-inch moulded case. All plug-in breakers are approved for HACR applications. ^a

- All ratings are CSA and UL listed
- CSA certified to C22.2 No. 5, file LR3300
- All loadcentre breakers are GOS listed for conformity

^a Single-pole 15 and 20 A units are switching duty (SWD) rated.

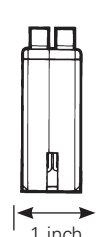
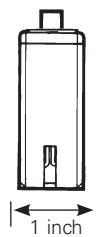
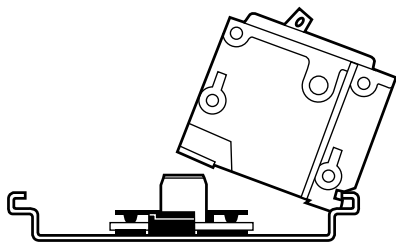
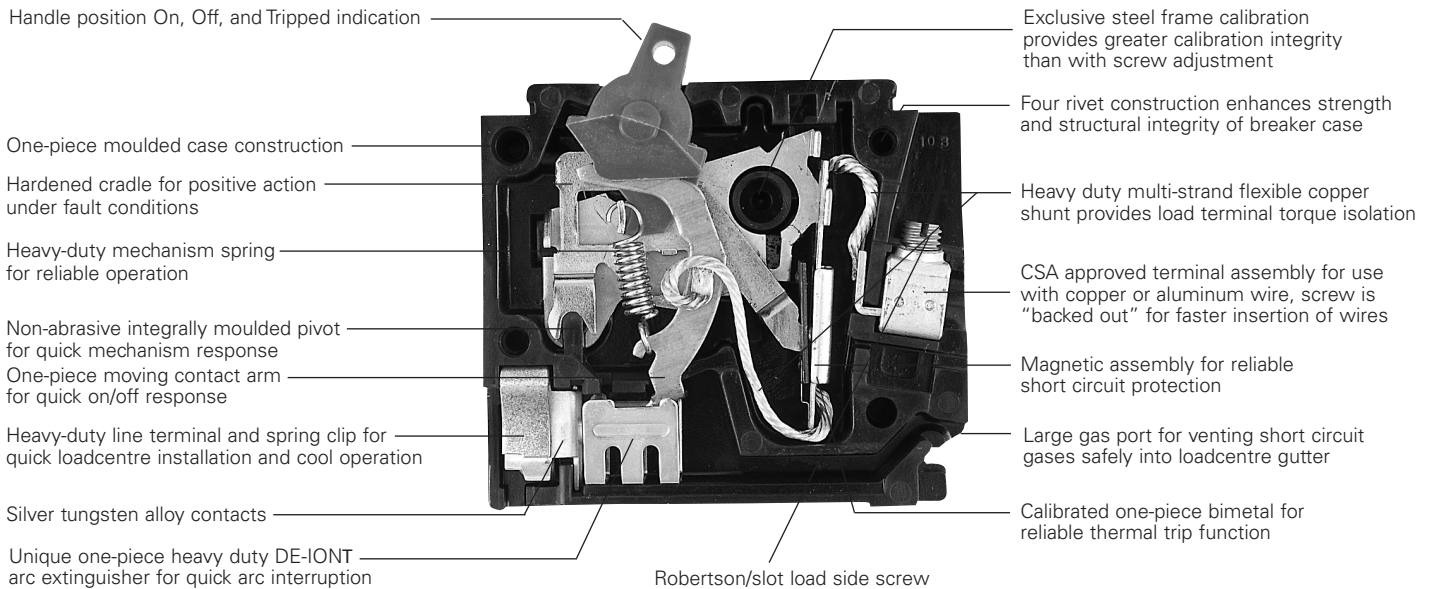

Type BR single- and multi-poleType BR ^{ab}

- 10,000/22,000 A interrupting capacity at 120 Vac, 120/240 Vac, and 240 Vac
- Two- and three-pole versions feature a common trip



BR120



BR215



BR320

Table 11. Single- and multi-pole plug-in circuit breakers

Ampere rating	Wire size range (Cu/Al 60 °C or 75 °C)	Catalogue numbers					
		Single-pole, 120/240 Vac 10 per shelf carton		Two-pole, 120/240 Vac 5 per shelf carton		Three-pole, 120/240 Vac 5 per shelf carton	
		10 kAIC	22 kAIC	10 kAIC	22 kAIC	10 kAIC	22 kAIC
15	#14-4	BR115 ^{cd}	BRH115	BR215	BRH215	BR315	BRH315
20	#14-4	BR120 ^{cd}	BRH120	BR220	BRH220	BR320	BRH320
25	#14-4	BR125 ^c	BRH125	BR225	BRH225	BR325	BRH325
30	#14-4	BR130 ^c	BRH130	BR230	BRH230	BR330	BRH330
35	#14-4	BR135 ^c	BRH135	BR235	BRH235	BR335	BRH335
40	#14-4	BR140 ^c	BRH140	BR240	BRH240	BR340	BRH340
45	#14-4	—	BRH145	BR245	BRH245	BR345	BRH345
50	#14-4	BR150 ^c	BRH150	BR250	BRH250	BR350	BRH350
60	#8-1/0	BR160 ^c	BRH160	BR260	BRH260	BR360	BRH360
70	#8-1/0	BR170 ^c	BRH170	BR270	BRH270	BR370	BRH370
80	#8-1/0	—	—	BR280	BRH280	BR380	BRH380
90	#8-1/0	—	—	BR290	BRH290	BR390	BRH390
100	#8-1/0	—	—	BR2100	BRH2100	BR3100	BRH3100
110	#8-1/0	—	—	—	—	—	—
125	#4-2/0 ^e	—	—	BR2125 ^e	—	e	—
150	e	—	—	e	—	e	—
175	e	—	—	e	—	e	—
200	e	—	—	e	—	e	—
Requires one 1-Inch (25.4 mm) space				Requires two 1-Inch (25.4 mm) spaces		Requires three 1-Inch (25.4 mm) spaces	

a All Type BR single-, two-, and three-pole circuit breakers carry listing for HACR application..

b Breaker shunt trips are available but only in 120 Vac format. Addition of a shunt trip adds a 1-inch space width. For circuit breakers requiring a shunt trip add an ST suffix to the end of the catalogue number (e.g. BR115ST).

c Available with high magnetic setting for switching large tungsten lamp loads. Add suffix H to catalogue number (e.g. BR115H).

d Switching duty rated.

e For subfeed applications in 200 or 400 A loadcentres requiring a 125, 150, 175, or 200 A subfeed circuit breaker a Type BJ circuit breaker can be used. Refer to **page 64** for product space requirements and selection.

Type DNPL Duplex™, Independent Quadplex™ and circuit breaker packs

Type DNPL ^{ab}

- 10,000 A interrupting capacity at 120 Vac, 120/240 Vac, and 240 Vac

Table 12. Duplex and Independent Trip Quadplex plug-in circuit breakers

Duplex 2 single-pole circuits 10 per shelf carton		Quadplex independent trip 2 single-pole circuits and 1 two-pole circuit 5 per shelf carton				Quadplex independent trip 2 two-pole circuits 5 per shelf carton			
120 Vac		120 Vac	120/240 Vac	120 Vac	120/240 Vac				
Ampere rating	Catalogue number	Outer left (single-pole) ampere rating	Centre (two-pole) ampere rating	Outer right (single-pole) ampere rating	Catalogue number	Outer left and right (two-pole) ampere rating	Centre (two-pole) ampere rating	Catalogue number	Wire size range (Cu/Al 60 °C or 75 °C)
15-15	DNPL1515	15	15	15	DNPL151515	15	15	DNPL215215	#14-4 AWG
15-20	DNPL1520	15	20	15	DNPL152015	15	20	DNPL215220	#14-4 AWG
15-30	DNPL1530	15	25	15	DNPL152515	15	30	DNPL215230	#14-4 AWG
20-20	DNPL2020	15	30	15	DNPL153015	15	40	DNPL215240	#14-4 AWG
—	—	15	40	15	DNPL154015	20	20	DNPL220220	#14-4 AWG
—	—	15	50	15	DNPL155015	20	30	DNPL220230	#14-4 AWG

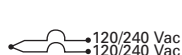

Requires one 1.00 inch (25.4 mm) space

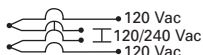

Independent trip requires two 1.00 inch (25.4 mm) spaces

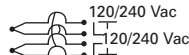

Independent trip requires two 1.00 inch (25.4 mm) spaces

a All Type DNPL Duplex and Quadplex circuit breakers carry listing for HACR applications.

b All 15 and 20 A single-pole are switch-duty rated.

Type BP (circuit breaker packs)

- Single carton packaged
- Represents common household combinations



DNPL2020



DNPL155015



DNPL230230

Table 13. Plug-in circuit breaker house packs

Contents	Catalogue number
(3) DNPL151515, (1) DNPL153015, (1) DNPL154015	BP2
(10) BR115, (3) BR215, (1) BR230, (1) BR240	BP4
(2) DNPL1515, (1) DNPL215215, (1) DNPL152015, (1) DNPL153015, (1) DNPL154015	BP16
(6) DNPL1515, (2) DNPL151515, (1) DNPL153015, (1) DNPL154015	BP18
(1) DNPL1515, (3) DNPL151515, (2) DNPL153015, (1) DNPL154015	BP21
(3) DNPL1515, (3) DNPL151515, (1) DNPL153015, (1) DNPL154015	BP23
(16) BR115, (3) BR215, (1) BR230, (1) BR240	BP24
(14) BR115, (2) BR120, (1) BR230, (1) BR240	BP27
5 of DNPL1515, 1 of DNPL2020, 1 of DNPL153015, 1 of DNPL154015	BP31
(1) BR120, (4) DNPL1515, (1) DNPL151515, (1) DNPL153015, (1) DNPL154015	BP32
(10) BR115, (2) BR120, (1) BR215, (1) BR220, (1) BR230, (1) BR240	BP41
(3) DNPL1515, (1) DNPL153015, (1) DNPL154015, (1) DNPL2020, (1) DNPL1520	BP54

Type BR arc fault circuit interrupter

Type BR arc fault circuit interrupter circuit breakers

- 10,000 A interrupting capacity at 120 Vac, 120/240 Vac, and 240 Vac

An arc fault circuit interrupter is a device intended to provide protection from the effects of arc faults by recognizing characteristics unique to arcing and by functioning to de-energize the circuit when the arc fault is detected. As of January 1, 2015, the Canadian Electrical Code now requires that all branch circuits that supply 125 V, single-phase, 15 and 20 A receptacle outlets installed in dwelling unit shall be protected by a combination arc fault circuit interrupter(s) (series arc and parallel arc detection).

Table 14. Single- and two-pole plug-in AFCI circuit breakers

Ampere rating	Configuration	Catalogue number		Wire size range (Cu/Al 60 °C or 75 °C)
		Single-pole 120/240 Vac 20 per shelf carton 10 kAIC	Two-pole ^{ab} 120/240 Vac 5 per shelf carton 10 kAIC	
15	Branch	BRAF115	—	#14–4 AWG
15	Combination	BRAF115C	—	#14–4 AWG
15	Common trip	—	BRL215CAF cd	#14–4 AWG
15	High interrupting 22 kAIC	BRHCAF115	—	#14–4 AWG
20	Branch	BRAF120	—	#14–4 AWG
20	Combination	BRAF120C	—	#14–4 AWG
20	Common trip	—	BRL220CAF cd	#14–4 AWG
20	High interrupting 22 kAIC	BRHCAF120	—	#14–4 AWG
		Requires one 1.00 inch (25.4 mm) space		Requires two 1.00 inch (25.4 mm) spaces

- a Common trip refers to two-pole 240 V load application sourced by 120/240 Vac (see **Figure 1**).
- b Independent trip refers to two-pole multi-wire, home run or shared neutral circuits (see **Figure 2** and **Figure 4**).
- c Will not fit into CPM112, CPL112, CPL116, CPL120, CPL220, CPL240, 3CPM112, 3CPL218, 3CPL224 or 3CPL230 prior to November 2004.
- d Long style circuit breakers. Please speak to your local Eaton sales rep for proper application.

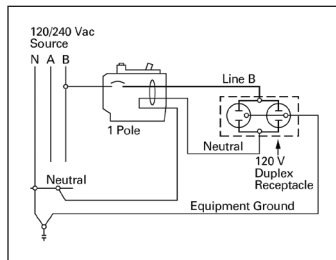

Figure 1. Single-pole, single 120 V load application sourced by 120/240 Vac

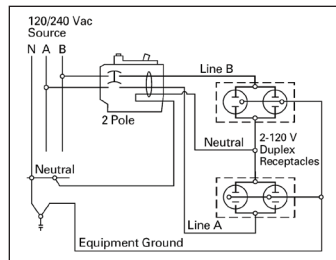

Figure 2. Two-pole, shared neutral with multi-duplex receptacle application

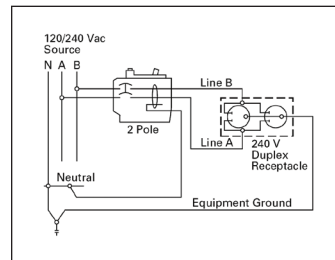

Figure 3. Two-pole, 240 V load application sourced by 120/240 Vac

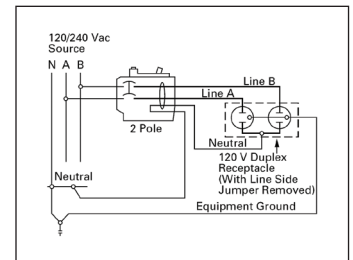
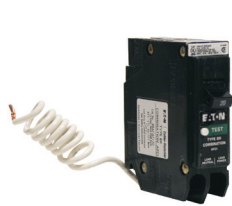

Figure 4. Two-pole, shared neutral with duplex receptacle application



Type BR combination AFCI circuit breaker



Type BR dual purpose AF/GF breaker



Type BR fire alarm breaker features red handle

Table 15. Single-pole plug-in dual purpose AF/GF breakers

Ampere rating	Configuration	Single-pole, 120/240 Vac 10 per shelf carton, 10 kAIC Catalogue number
15	CAFCI / 5 mA GF	BRAFGF115C
20	CAFCI / 5 mA GF	BRAFGF120C
Compact body breaker		Requires one 1.00 inch (25.4 mm) space

Table 16. Single-pole plug-in fire alarm breakers

Ampere rating	Configuration	Single-pole, 120/240 Vac 10 per shelf carton, 10 kAIC Catalogue number
15	Branch fire alarm	BRF115
20	Branch fire alarm	BRF120
Compact body breaker		Requires one 1.00 inch (25.4 mm) space

Types GFCB and GFEP ground fault

Type GFCB and GFEP ground fault circuit breakers

- 10,000/22,000 A interrupting capacity at 120 Vac and 120/240 Vac
- 5 mA “people protection”, 10 mA submersible pump protection, or 30 mA equipment protectors
- Two-pole version features common trip



GFTCB single-pole



GFTCB two-pole

Table 17. 5 mA single- and two-pole plug-in ground fault circuit breakers

Ampere rating	Wire size range Cu/Al 60 °C or 75 °C (AWG)	Catalogue number				
		Single-pole, 120 Vac 1 per shelf carton		Two-pole, 120/240 Vac 1 per shelf carton		
		10 kAIC	22 kAIC	10 kAIC	22 kAIC	
15	#14–8	GFTCB115 a	GFTCBH115	GFTCB215	GFTCBH215	
20	#14–8	GFTCB120 a	GFTCBH120	GFTCB220	GFTCBH220	
25	#14–8	GFTCB125 a	GFTCBH125	GFTCB225	GFTCBH225	
30	#14–8	GFTCB130 a	GFTCBH130	GFTCB230	GFTCBH230	
40	#14–8	GFTCB140 a	—	GFTCB240	—	
50	#14–8	—	—	GFTCB250 b	—	
60	#14–4	—	—	GFTCB260	—	
			Requires one 1.00 inch (25.4 mm) space		Requires two 1.00 inch (25.4 mm) spaces	

a Auxiliary switches and bell alarms are available under special order. Add suffix W1 for alarm switch and W2 for auxiliary switch.

b For use with copper wire only.

Table 18. 30 mA single- and two-pole plug-in ground fault circuit breaker equipment protectors

Ampere rating	Wire size range Cu/Al 60 °C or 75 °C (AWG)	Catalogue number			
		Single-pole, 120 Vac 1 per shelf carton	Two-pole, 120/240 Vac 1 per shelf carton		
		10 kAIC	10 kAIC		
15	#14–8	GFEP115	GFEP215		
20	#14–8	GFEP120	GFEP220		
25	#14–8	GFEP125	GFEP225		
30	#14–8	GFEP130	GFEP230		
40	#14–8	—	GFEP240		
50	#14–8	—	GFEP250 a		
		Requires one 1.00 inch (25.4 mm) space		Requires two 1.00 inch (25.4 mm) spaces	

a For use with copper wire only.

Ground fault application note

Single-pole ground fault circuit breakers (GFCBs) are designed for use in two-wire, 120 Vac circuits. **Figure 5** shows a typical wiring configuration. Two-pole GFCBs are designed for use in three-wire, 120/240 Vac circuits, 120 Vac multi-wire circuits employing common, neutral and two-wire, 240 Vac circuits obtained from a 120/240 Vac source. **Figure 6** and **Figure 8** illustrate typical wiring configurations for 120/240 Vac multi-wire circuits. **Figure 7** depicts a 240 Vac, two-wire circuit.

Note: The “panel neutral” conductor connects to the neutral bar, even though the neutral is not included in the load circuit. This connection is necessary to supply a 120 Vac power source to the ground fault sensing circuit. The figures are shown with a 120/240 Vac, single-phase, three-wire power source, but are also applicable to a 120/208 Vac, three-phase, four-wire power supply. For all figures, the electrical operation of the GFCB is not affected by the equipment ground.

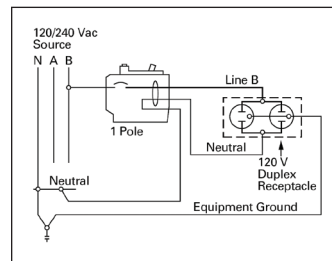

Figure 5. Single-pole

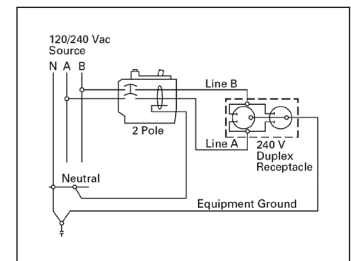

Figure 7. Two-pole

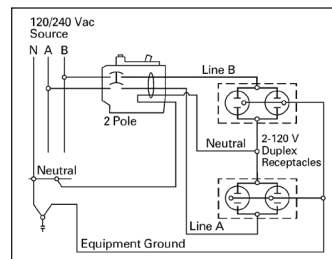

Figure 6. Two-pole

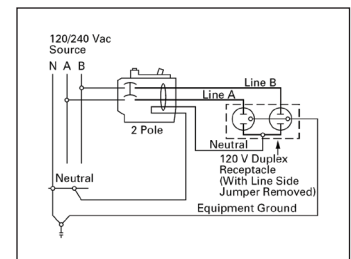

Figure 8. Two-pole

Type GFCB ground fault and Type BR internationally rated

Type BR internationally rated circuit breakers

- 3000/6000 A interrupting capacity at 240/415 Vac
- Two- and three-pole versions feature common trip



BR120E



BR215E



BR320E

Table 19. Single-, two-, and three-pole plug-in internationally rated circuit breakers ^{ab}

Ampere rating	Wire size range Cu/Al 60 °C or 75 °C (AWG)	Catalogue number							
		Single-pole, 240/415 Vac 10 per shelf carton		Two-pole, 240/415 Vac 5 per shelf carton		Three-pole, 240-415 Vac 5 per shelf carton			
		3 kAIC	6 kAIC	3 kAIC	6 kAIC	3 kAIC	6 kAIC		
15	#14-4	BR115E	BRH115E	BR215E	BRH215E	BR315E	BRH315E		
20	#14-4	BR120E	BRH120E	BR220E	BRH220E	BR320E	BRH320E		
25	#14-4	BR125E	BRH125E	BR225E	BRH225E	BR325E	BRH325E		
30	#14-4	BR130E	BRH130E	BR230E	BRH230E	BR330E	BRH330E		
35	#14-4	BR135E	BRH135E	BR235E	BRH235E	BR335E	BRH335E		
40	#14-4	BR140E	BRH140E	BR240E	BRH240E	BR340E	BRH340E		
45	#14-4	—	BRH145E	BR245E	BRH245E	BR345E	BRH345E		
50	#14-4	BR150E	BRH150E	BR250E	BRH250E	BR350E	BRH350E		
60	#4-1/0	BR160E	BRH160E	BR260E	BRH260E	BR360E	BRH360E		
70	#4-1/0	BR170E	BRH170E	BR270E	BRH270E	BR370E	BRH370E		
80	#4-1/0	—	—	BR280E	BRH280E	BR380E	BRH380E		
90	#4-1/0	—	—	BR290E	BRH290E	BR390E	BRH390E		
100	#4-1/0	—	—	BR2100E	BRH2100E	BR3100E	BRH3100E		
				Requires one 1.00 inch (25.4 mm) space		Requires two 1.00 inch (25.4 mm) spaces		Requires three 1.00 inch (25.4 mm) spaces	

^a Built to British Standard BS3871.

^b Non-stocked item requiring special order. Speak to your local Eaton sales rep for lead times.

Table 20. Duplex, 2 single-pole circuits, 240/415 Vac

Ampere rating	Catalogue number
15-15	DNPL1515E
15-20	DNPL1520E
20-20	DNPL2020E
—	—
—	—
Requires one 1.00 inch (25.4 mm) space	

Type GFXB internationally rated ground fault and Type BR moulded case switches

Type GFXB internationally rated ground fault circuit breakers

- 3000 A interrupting capacity at 120/240 Vac, 220/380 Vac, and 240/415 Vac



Type GFXB

Table 21. 30 mA single-pole plug-in ground fault circuit breakers ^{abc}

Ampere rating	Wire size range Cu/Al 60 °C or 75 °C (AWG)	Catalogue number ^a Single-pole, 120 Vac 1 per shelf carton 3 kAIC
15	#14-4	GFXB115B2
20	#14-4	GFXB120B2
25	#14-4	GFXB125B2
30	#14-4	GFXB130B2

Requires one 1.00 inch (25.4 mm) space

^a Auxiliary switches and bell alarms are available under special order. Add suffix W1 for alarm switch and W2 for auxiliary switch.

^b Meets requirements of BS3871 section 31C and BS4293.

^c Non-stocked part requiring special ordering. Speak to your local Eaton sales rep for lead times.

Type BR non-automatic moulded case switches



BR250NA

Table 22. Two-pole plug-in non-automatic moulded case switches ^a

Ampere rating	Wire size range Cu/Al 60 °C or 75 °C (AWG)	Catalogue number ^a Two-pole, 120/240 Vac 5 per shelf carton
50	#4-1/0	BR250NA
60	#4-1/0	BR260NA
100	#4-1/0	BR2100NA

Requires two 1.00 inch (25.4 mm) spaces

^a Non-stocked part requiring special ordering. Speak to your local Eaton sales rep for lead times.

Plug-in loadcentre main circuit breakers for CPM/CPL

Type CSR, and CC

Type CSR loadcentre main circuit breaker kit

- 25,000 A interrupting capacity at 120/240 Vac



CSR2150N

Type CC loadcentre main circuit breaker kit



CC3150

Table 23. Two-pole main circuit breakers for single-phase plug-in combination loadcentres

Ampere rating	Wire size range Cu/Al 60 °C or 75 °C	Catalogue number
		Two-pole, 120/240 Vac 1 per shelf carton 25 kAIC
125	#2 AWG–300 kcmil	CSR2125N
150	#2 AWG–300 kcmil	CSR2150N
200	#2 AWG–300 kcmil	CSR2200N

Table 24. Three-pole main circuit breakers for three-phase plug-in combination loadcentres

Ampere rating	Wire size range Cu/Al 60 °C or 75 °C	Catalogue number
		Three-pole, 120/240 Vac 1 per shelf carton 10 kAIC
100	#4 AWG–4/0 AWG	CC3100
125	#2 AWG–300 kcmil	CC3125
150	#2 AWG–300 kcmil	CC3150
200	#2 AWG–300 kcmil	CC3200

Plug-in circuit breaker accessories for CPM/CPL loadcentres

Plug-in circuit breaker accessories

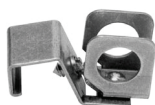

BRLW2-10



BHLW2-10



BRQLW-10



BHLW-10



MCBPL
(installed)



THOW-10
(installed)

Table 25. Field installation kits and parts for plug-in loadcentre circuit breakers

Description	Ordering quantity ^a	Catalogue number
Handle tie for single-pole Type BR circuit breakers. Joins handles on breakers mounted adjacent to each other via a clip-on mechanism.	1	BQHT-10
Handle tie for Type DNPL circuit breakers. Joins the two outside independent poles on two adjacent duplex or one quadplex circuit breakers.	1	THOW-10
Handle tie for Type DNPL circuit breakers. Joins the outside independent poles on adjacent duplex or quadplex circuit breakers.	1	THS1
Handle lockoff (escutcheon mounted). Single-, two-, or three-pole Type BR; single-pole of a Type DNPL duplex or; one independent outside pole of a Type DNPL quadplex circuit breakers.	1	BRLW-10
Handle lockoff (handle mounted). Single-pole Type BR circuit breakers. ^b	1	BRLW1-10
Handle lockoff (handle mounted). Two- and three-pole Type BR circuit breakers. ^b	1	BRLW2-10
Handle lockoff (handle mounted). Single-pole Type DNPL quadplex circuit breakers. ^b	1	BRDL1-10
Handle lockoff (escutcheon mounted). Two-pole Type DNPL quadplex circuit breakers. ^b	1	BRQLW-10
Handle lockoff (screw mounted). Locks the handle of main circuit breaker types CC and CHH in the OFF or ON position. ^b	1	CCPL
Handle lockoff (escutcheon mounted). Locks the handle of main circuit breaker type CSR and BWH in the OFF or ON position. ^b	1	MCBPL
Handle lockdog (escutcheon mounted). Single-, two-, and three-pole Type BR; single-pole of a Type DNPL duplex or; one independent pole of a Type DNPL quadplex circuit breaker. Secures handle in the ON or OFF position. ^b	1	BHLW-10
Handle lockdog (handle mounted). Single-pole Type BR circuit breakers. Secures handle in the ON or OFF position. ^b	1	BHLW1-10
Handle lockdog (handle mounted). Two- and three-pole Type BR circuit breakers. Secures handle in the ON or OFF position. ^b	1	BHLW2-10
Handle lockdog (handle mounted). Single-pole Type GFCB ground fault circuit breakers. Secures handle in the ON or OFF position. ^b	1	BHGW-10
Handle lockdog (handle mounted). Single-pole Type DNPL duplex or 1 outside independent pole of a quadplex. Secures handle in the ON or OFF position. ^b	1	HLW1-10
Main breaker lug kit. Types CC and CHH circuit breakers (2) 300 kcmil	1	CCL300
Main breaker lug kit. Types CSR, BW, and BWH circuit breakers (2) 300 kcmil	1	MCBL300
Electronic breaker lockoff (escutcheon mounted): Type BR long body AF/GF	1	BRLAFGFLOFF
Electronic breaker lockoff (escutcheon mounted): Type BR compact body AF	1	BRCAFLOFF

^a Must be purchased in multiples of ordering quantities indicated.

^b Refer to your local Eaton sales representative for handle position changeability chart.

Definitions

Handle ties: Devices used to join two similar independent single-pole circuit breakers to form a two-pole non-common trip breaker.

Handle lockoffs: Devices that use a padlock to lock a circuit breaker's handle in either the ON or OFF position.

Handle lockdogs: Devices used to secure a circuit breaker's handle in the ON or OFF position. They are not padlockable devices.

Escutcheon mounted: A semipermanent mounting to the face of the circuit breaker and secured by the loadcentre's deadfront cover.

Handle mounted: A mounting made directly to the handle of the circuit breaker by means of a set screw.

Screw mounted: A permanent mounting to the face of the circuit breaker by means of a non-removable screw.

Plug-in OEM loadcentre interior assemblies

Product description

As a leader in the electrical distribution equipment business, Eaton has a unique product offering for equipment manufacturers, panel builders and virtually any OEM that has a need for power distribution within their equipment. The OEM interior offering consists of a wide variety of power distribution options utilizing components from Eaton's BR Loadcentre product lines. With high-volume, standardized products, OEMs can expect to receive high-quality products covering configurations meeting virtually any power distribution need.

Coupled with Eaton's expertise in circuit breaker design and manufacturing, our OEM interiors provide solid power distribution and circuit protection in a compact, easy-to-install package.

Product offering

The BR interiors are manufactured of formed, plated aluminum, and use the Eaton Type BR 1.00 inch (25.4 mm) wide circuit breaker by Eaton. This design affords customers the most circuit flexibility as many of these interiors allow the installation of standard single- and two-pole breakers as well duplex (two-pole in a 1.00 inch (25.4 mm) space) or quadplex (four-pole in a 2.00 inch (50.8 mm) space) breakers. The stab rating of the BR interiors is 140 A maximum, meaning that the handle rating of the breakers that are mounted across from one another may not exceed 140 A.

The interiors are designed for either horizontal (single-row breaker mounting), or vertical (double-row breaker mounting).

Product selection

Standards and certifications

Canadian Standards Association listing

All single- and two-pole, 120/240 V breakers, both 1-inch (25.4 mm), 1/2-inch (12.7 mm) and 3/4-inch (19.1 mm) per pole, 225 A maximum, are listed as certified by the Canadian Standards Association, Guide No. 69-11.19, Class 1432, File 18328.

Underwriters Laboratories listing

All grounding bars manufactured comply with Underwriters Laboratories standards and are listed under Guide No. DHJR, File E31424, Volume W, Section 17.

All circuit breakers 10 A and larger comply with the Underwriters Laboratories "Standard for Branch Circuit and Service Circuit-Breakers" UL 489; Guide No. 60 10.2 File E31424, and "Requirements for Wire Connectors and Soldering Lugs," UL 486B, Guide No. 461 10-C File E7830.

All Eaton breakers where marked, are suitable for use with 60/75 ° rated wire, unless otherwise specified.

All devices comply with the 22–10 kAIC UL series connected components File DKS2 of the Recognized Components Index.

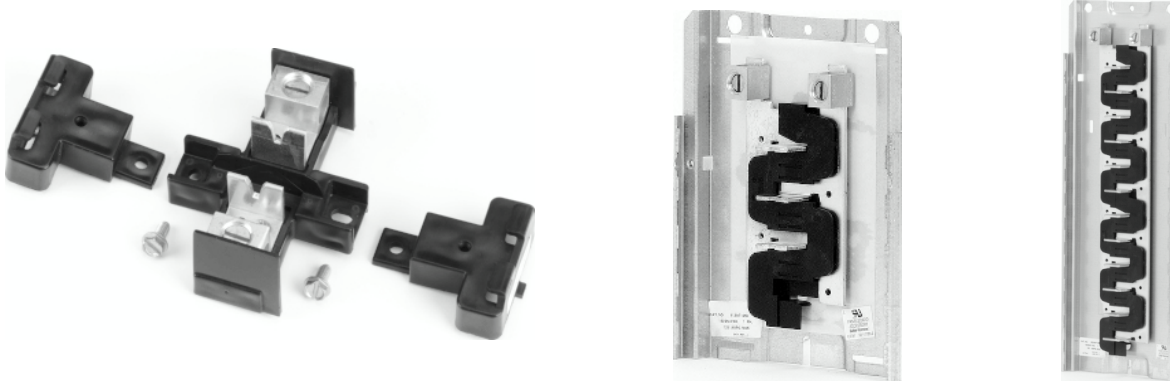

Table 26. Plug-in OEM loadcentre interior assemblies

Ampere rating	1-inch spaces	½-inch spaces	Main terminal size (per phase)	Package quantity	Catalogue number
125	4	8	(1) 2/0-#14 AWG Cu/Al	20	48INT125B
125	8	16	(1) 2/0-#14 AWG Cu/Al	20	816INT125B
125	12	24	(1) 2/0-#14 AWG Cu/Al	20	1224INT125B
125	16	24	(1) 2/0-#14 AWG Cu/Al	20	1624INT125B
125	20	24	(1) 2/0-#14 AWG Cu/Al	10	2024INT125B
125	24	24	(1) 2/0-#14 AWG Cu/Al	10	2424INT125B

Dimensions

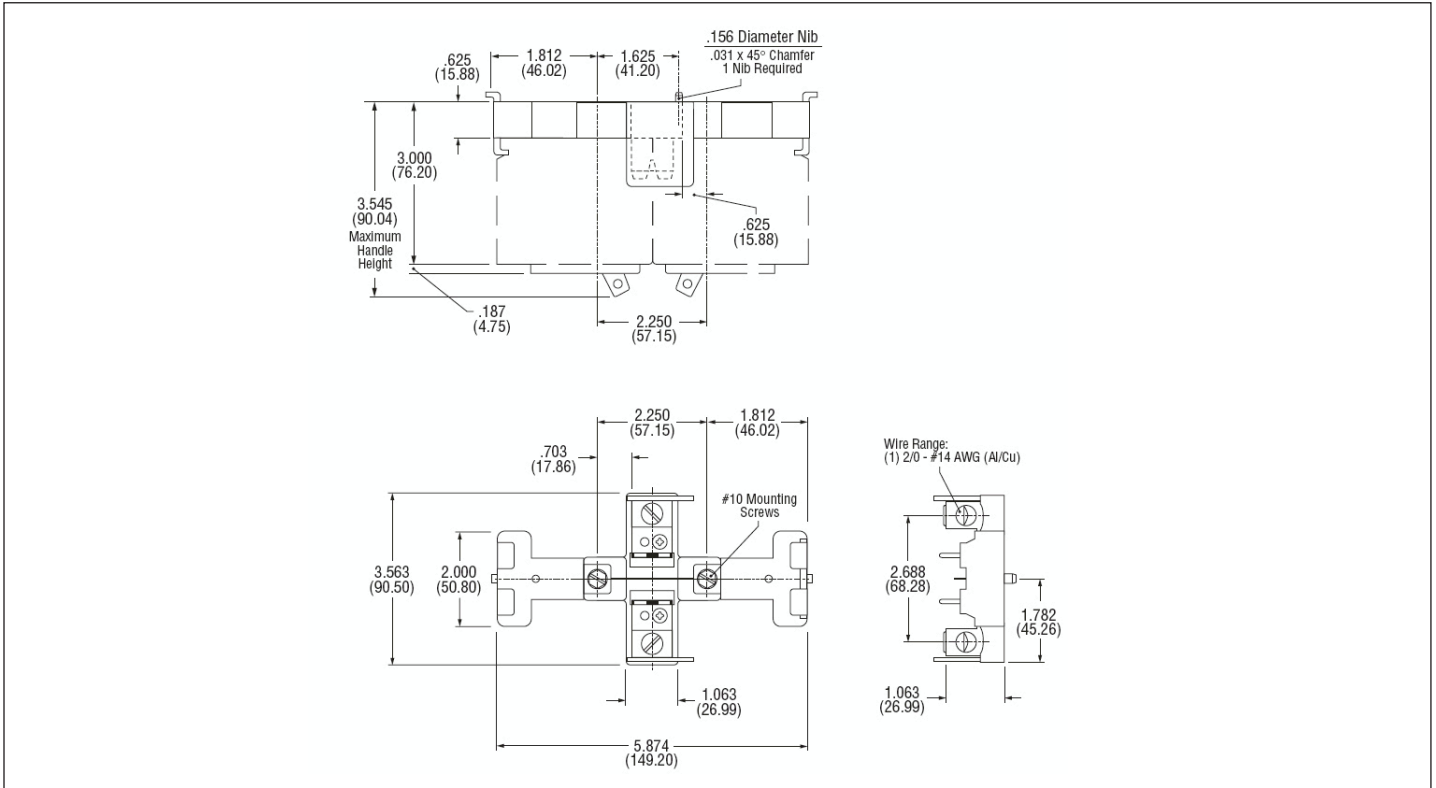

Figure 9. 48INT125B

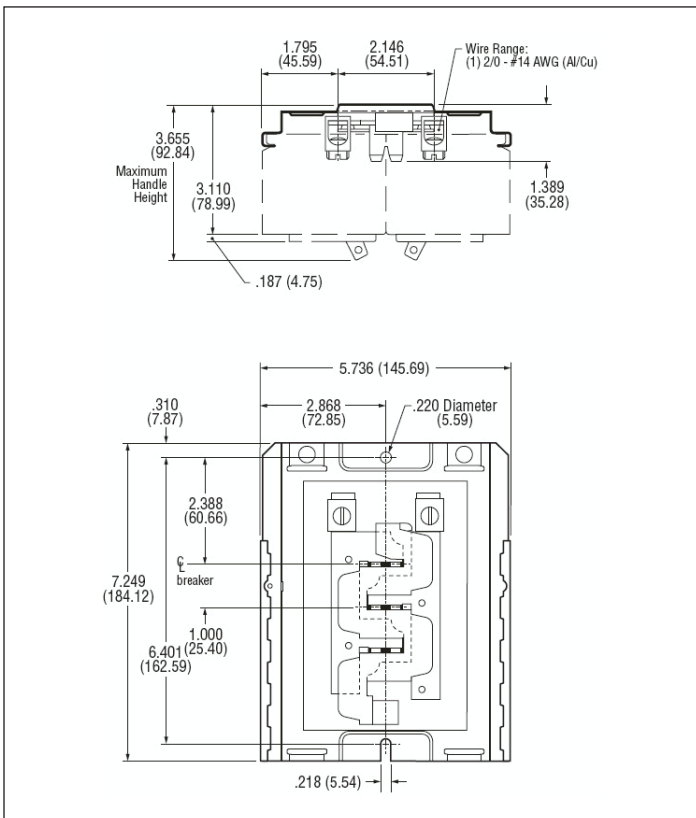

Figure 10. 816INT125B

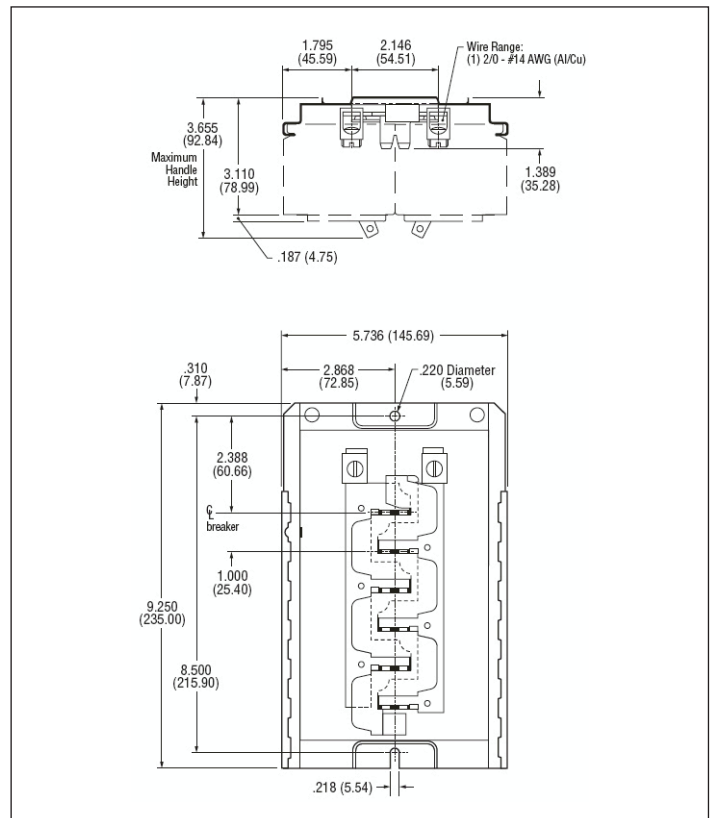

Figure 11. 1224INT125B

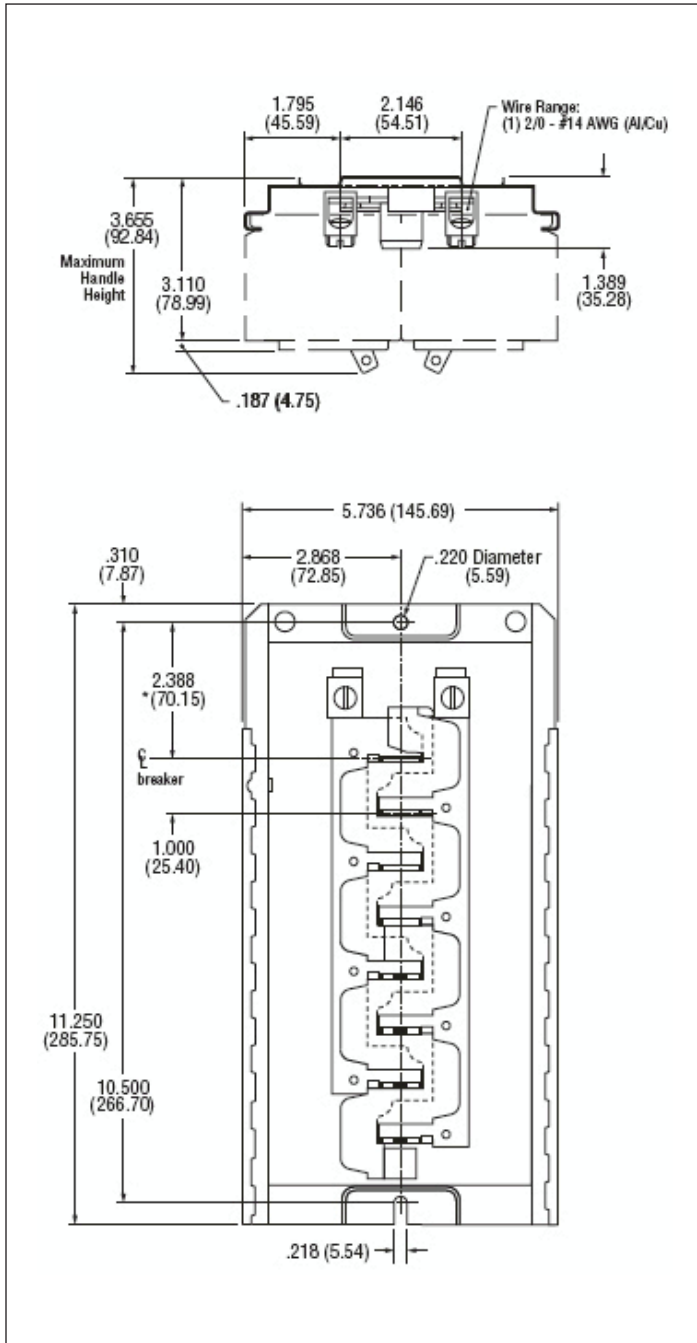

Figure 12. 1624INT125B

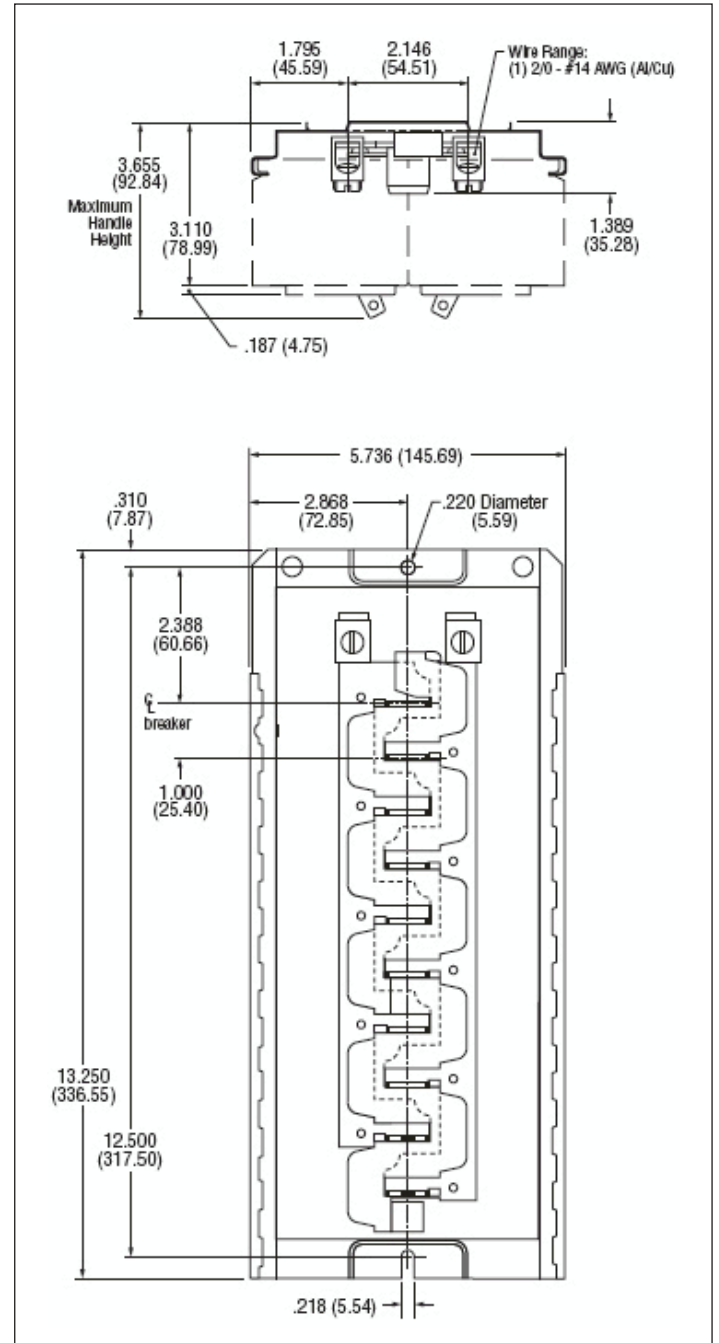

Figure 13. 2024INT125B

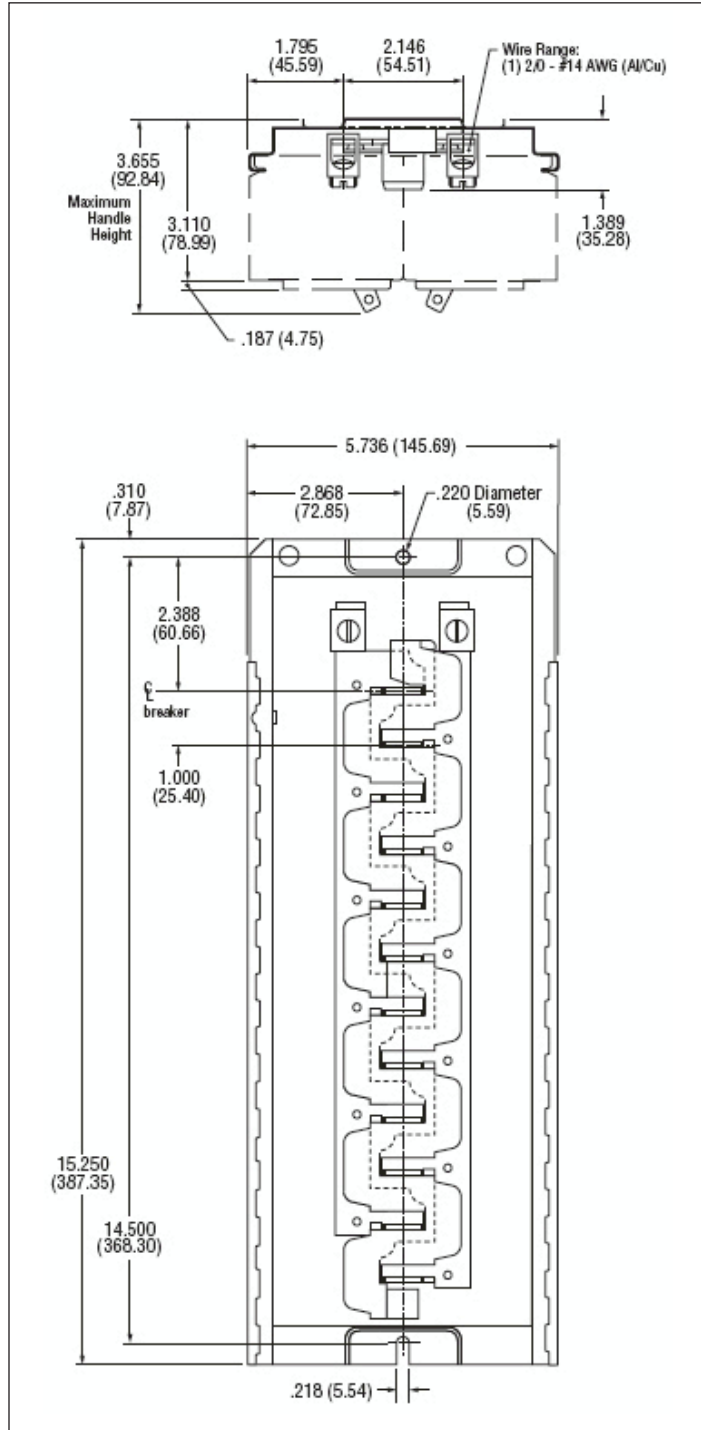

Figure 14. 2424INT125B

Type CH plug-in loadcentres

Product description

Loadcentres feature factory installed main lugs or main circuit breakers. The CH interiors are manufactured of formed, silver flash plated copper. Eaton also supplies a full line of Type CH branch circuit breakers and accessories for these loadcentres.

Product application

Designed for the protection and distribution of single and multi-dwelling residential and light commercial loads to 120/240 volts AC, such as lighting, heating, appliance and small motor branch circuits. All main circuit breaker combination loadcentres are CSA listed for use as service entrance equipment.

Ratings

Single-phase, three-wire, 120/240 volts AC. Mains through 200 A. Available with up to 120 branch circuits. Main breakers on 100 and 200 A panels are rated at 35,000 AIC.

Metal enclosure specifications

Enclosures are made of 16 gauge galvanized sheet steel powder coated sandalwood beige. The galvanized coating provides corrosion protection. Trims are similarly scratch-resistant powder coated a sandalwood beige colour to match the tub. A combination surface/flush cover with integral door is supplied.

All plug-in loadcentres are CSA listed to file LL98266.

Warranty

Limited lifetime.

Type CH plug-on neutral loadcentre features and benefits

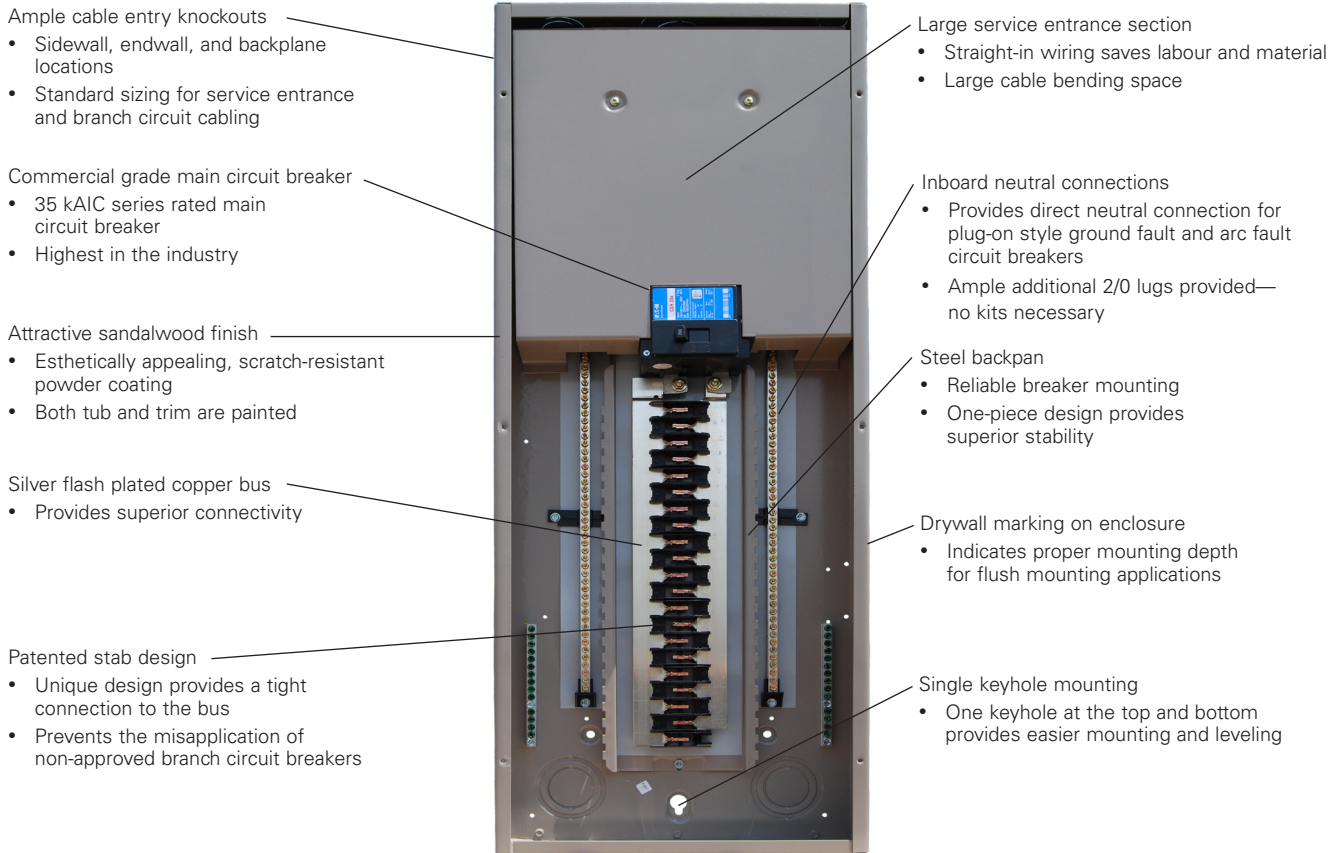

Combination and non-combination single-phase

Three-wire 120/240 Vac plug-on neutral style combination service entrance Type 1 (indoor)

Table 27. Type CH Main circuit breaker plug-on neutral indoor Type 1 loadcentres

Maximum ampere rating	Main breaker rating	Max. no. 3/4-inch spaces	Cover style	Type of main circuit breaker	Dimensions in inches (mm)			Wire size range for main Cu/Al	Catalogue number
					H	W	D		
100	100	24	Flush/surface	CSR	29.13 (739.8)	14.19 (360.4)	3.69 (93.7)	#2–300 kcmil	CHM24PN100
100	100	32	Flush/surface	CSR	34.13 (866.8)	14.19 (360.4)	3.69 (93.7)	#2–300 kcmil	CHM32PN100
100	100	42	Flush/surface	CSR	37.00 (939.8)	14.19 (360.4)	3.69 (93.7)	#2–300 kcmil	CHM42PN100
200	200	32	Flush/surface	CSR	34.13 (866.8)	14.19 (360.4)	3.69 (93.7)	#2–300 kcmil	CHM32PN200
200	200	42	Flush/surface	CSR	37.00 (939.8)	14.19 (360.4)	3.69 (93.7)	#2–300 kcmil	CHM42PN200
200	200	60	Flush/surface	CSR	39.00 (990.6)	14.19 (360.4)	3.69 (93.7)	#2–300 kcmil	CHM60PN200L

Three-wire 120/240 Vac plug-on neutral style non-combination service entrance Type 1 (indoor)

Table 28. Type CH main lug only plug-on neutral indoor Type 1 loadcentres

Maximum ampere rating	Max. no. 3/4-inch spaces	Cover style	Dimensions in inches (mm)			Wire size range for main Cu/Al	Catalogue number
			H	W	D		
125	24	Flush/surface	29.13 (739.8)	14.19 (360.4)	3.69 (93.7)	#2–300 kcmil	CHNL24PN125
125	32	Flush/surface	34.13 (866.8)	14.19 (360.4)	3.69 (93.7)	#2–300 kcmil	CHNL32PN125
225	32	Flush/surface	34.13 (866.8)	14.19 (360.4)	3.69 (93.7)	#2–300 kcmil	CHNL32PN225
225	42	Flush/surface	37.00 (939.8)	14.19 (360.4)	3.69 (93.7)	#2–300 kcmil	CHNL42PN225

Three-wire 120/240 Vac standard neutral non-combination Type 3R (outdoor/raintight) ^{ab}



CH6L125R



RCCHL102

Table 29. Type CH main lug only standard neutral outdoor/raintight Type 3R loadcentres ^a

Maximum ampere rating	Catalogue number	Max. no. 3/4-inch spaces	Max. no. 3/8-inch spaces	Enclosure style	Dimensions in inches (mm)			Wire size range for main CU/AL
					H	W	D	
100	RCCHL102	2	4	Indoor/outdoor Type 3R ^{ac}	12.00 (304.8)	6.88 (174.62)	4.38 (111.13)	#14–1/0
125	CH6L125R	6	12	Indoor/outdoor Type 3R	12.00 (304.8)	6.88 (174.62)	4.38 (111.13)	#14–1/0

^a Outdoor loadcentres accommodate Type DS conduit hubs. Hubs not included. See **page 15** for selection.

^b Does not accept plug-on neutral style of arc fault and ground fault circuit breakers. Uses standard type arc fault and ground fault circuit breakers.

^c Enclosure assembly incorporates a swing out locking hasp for the cover.

Plug-in circuit breakers for CH

Type CH single, multi-pole, and twin

Type CH plug-in circuit breakers ^a

- 10,000 A interrupting capacity at 120/240 Vac
- Flag trip models provide visual indication of trip

Product selection

Table 30. Single- and multi-pole plug-in breakers

Ampere rating	Wire size range (Cu/AL 60 °C or 75 °C) (AWG)	Catalogue Number		
		Single-pole, 120/240 Vac Flag trip indication 10 per shelf carton	Two-pole, 120/240 Vac Flag trip indication 5 per shelf carton	Three-pole, 240 Vac Standard 5 per shelf carton
10	(1) #14-8 b, (2) #14-10 bc, (1) #14-6 d	—	—	—
15	(1) #14-8 b, (2) #14-10 bc, (1) #14-6 d	CHF115	CHF215	CH315 h
20	(1) #14-8 b, (2) #14-10 bc, (1) #14-6 d	CHF120	CHF220	CH320 h
25	(1) #14-8 b, (2) #14-10 bc, (1) #14-6 d	CHF125	CHF225	CH325 h
30	(1) #14-8 b, (2) #14-10 bc, (1) #14-6 d	CHF130	CHF230	CH330 h
35	#14-2 b, #14-6 d	CHF135	CHF235	CH335 h
40	#10-1/0 e, #14-2 f, #3-0 g	CHF140	CHF240	CH340 h
45	#10-1/0 e, #14-2 f, #3-0 g	CHF145	CHF245	CH345 h
50	#10-1/0 e, #14-2 f, #3-0 g	CHF150	CHF250	CH350 h
60	#10-1/0 e, #14-2 f, #3-0 g	CH160	CH260	CH360 h
70	#10-1/0 e, #14-2 f, #3-0 g	CH170	CH270	CH370 h
80	#10-1/0 e, #14-2 f, #3-0 g	—	CH280	CH380
90	#10-1/0 e, #14-2 f, #3-0 g	—	CH290	CH390
100	#10-1/0 e, #14-2 f, #3-0 g	—	—	CH3100
110	#10-1/0 e, #14-2 f, #3-0 g	—	—	—
125	#10-1/0 e, #14-2 f, #3-0 g	—	—	—

Requires three ¾-inch (19.1 mm) spaces

^a Not for use in Type BR loadcentres i.e. CPM or CPL prefixed catalogue numbers.

^b For single- and two-pole breakers.

^c Solid and stranded wire can be used together.

^d For three-pole breakers.

^e Single-pole 60-70 A, two-pole 80-125 A, three-pole 40-100 A.

^f Single-pole 40-50 A, two-pole 40-70 A.

^g Two-pole 150 A.

^h HACR rated.

Type CH Twin Circuit Breakers ^{abc}

- 10,000 A interrupting capacity at 120/240 Vac
- Provides 2 single-pole circuits in one ¾-inch space

Table 31. Twin plug-in circuit breakers

Ampere rating	Wire size range (Cu/Al 60 °C or 75 °C) (AWG)	Catalogue number
		Single-pole, 120/240 Vac 10 per shelf carton
15-15	#14-8	CHT1515
15-20	#14-8	CHT1520
20-20	#14-8	CHT2020

Requires one ¾-inch (19.1 mm) space

^a Switching duty rated.

^b HACR rated.

^c Not for use in Type BR loadcentres i.e. CPM or CPL prefixed catalogue numbers.

Type CHP commercialType CHP commercial circuit breakers ^a

- 10,000 A interrupting capacity at 120 Vac, 120/240 Vac, and 240 Vac
- Three-position trip breakers for commercial applications when On-Off and Trip position is required

Table 32. Commercial plug-in circuit breakers

Ampere rating	Wire size range (Cu/Al 60 °C or 75 °C) (AWG)	Catalogue number		
		Single-pole 120/240 Vac 10 per shelf carton	Two-pole 120/240 Vac 5 per shelf carton	Three-pole 240 Vac 5 per shelf carton
10	(1) #14-8 b, (2) #14-10 bc, (1) #14-6 d	CHP110	—	CHP310
15	(1) #14-8 b, (2) #14-10 bc, (1) #14-6 d	CHP115 gh	CHP215 h	CHP315 h
20	(1) #14-8 b, (2) #14-10 bc, (1) #14-6 d	CHP120 gh	CHP220 h	CHP320 h
25	(1) #14-8 b, (2) #14-10 bc, (1) #14-6 d	CHP125 h	CHP225 h	CHP325 h
30	(1) #14-8 b, (2) #14-10 bc, (1) #14-6 d	CHP130 h	CHP230 h	CHP330 h
35	#14-2 b, #14-6 d	CHP135 h	CHP235 h	CHP335 h
40	#10-1/0 e, #14-2 f	CHP140 h	CHP240 h	CHP340 h
45	#10-1/0 e, #14-2 f	CHP145 h	CHP245 h	CHP345 h
50	#10-1/0 e, #14-2 f	CHP150 h	CHP250 h	CHP350 h
60	#10-1/0 e, #14-2 f	— h	CHP260 h	CHP360 h
70	#10-1/0 e, #14-2 f	—	CHP270	CHP370
80	#10-1/0 e, #14-2 f	—	CHP280	—
90	#10-1/0 e, #14-2 f	—	CHP290	—
100	#10-1/0 e, #14-2 f	—	CHP2100	CHP3100
110	#10-1/0 e, #14-2 f	—	—	—
125	#10-1/0 e, #14-2 f	—	CHP2125	—
		Requires one ¾-inch (19.1 mm) space	Requires two ¾-inch (19.1 mm) spaces	Requires three ¾-inch (19.1 mm) spaces

^a Not for use in Type BR loadcentres i.e. CPM or CPL prefixed catalogue numbers.

^b For single- and two-pole breakers.

^c Solid and stranded wire can be used together.

^d For three-pole breakers.

^e Single-pole 60-70 A, two-pole 80-125 A, three-pole 40-100 A.

^f Single-pole 40-50 A, two-pole 40-70 A.

^g Switching duty rated.

^h HACR rated.

Type CH arc fault circuit interrupter

Type CH arc fault circuit interrupter circuit breakers ^a

- 10,000 A interrupting capacity at 120 Vac, and 120/240 Vac
- Plug-on neutral style for plug-on neutral type CH loadcentres

A combination type arc fault circuit interrupter is a device intended to mitigate series and parallel arcing faults in the complete circuit, including connected cords. Parallel arcing faults can occur from line to neutral or line to ground. These arcing faults are in parallel with the load and produce the most energy of all arcing faults.

Table 33. Single- and two-pole plug-in FIRE-GUARDE AFCI circuit breakers

Ampere rating	Wire size range (Cu/Al 60 °C or 75 °C) (AWG)	Configuration	Catalogue number	
			Single-pole, 120/240 Vac 10 per shelf carton 10 kAIC	Two-pole, 120/240 Vac 5 per shelf carton 10 kAIC ^{bc}
15	#14-4	Standard	CHFCAF115	—
15	#14-4	Common trip	—	CH215CAF
15	#14-4	Plug-on neutral ^d	CHFCAF115PN	—
20	#14-4	Standard	CHFCAF120	—
20	#14-4	Common trip	—	CH220CAF
20	#14-4	Plug-on neutral ^d	CHFCAF120PN	—
			Requires one ¾-inch (19.1 mm) space	Requires two ¾-inch (19.1 mm) spaces

- ^a Not for use in Type BR loadcentres i.e. CPM or CPL prefixed catalogue numbers.
- ^b Common trip refers to two-pole 240 V load application sourced by 120/240 Vac (see **Figure 17**).
- ^c Independent trip refers to two-pole multi-wire, home run or shared neutral circuits (see **Figure 16** and **Figure 18**).
- ^d Only for use in the Type CH plug-on neutral style of combination and non-combination loadcentres.

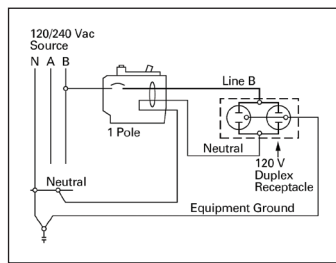

Figure 15. Single-pole, single 120 V load application sourced by 120/240 Vac

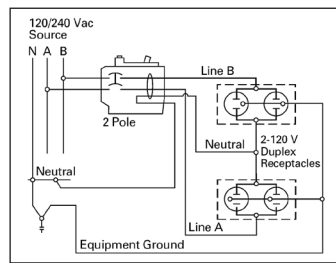

Figure 16. Two-pole, shared neutral with multi-duplex receptacle application

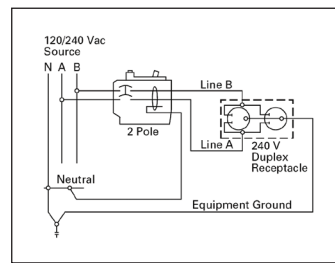

Figure 17. Two-pole, 240 V load application sourced by 120/240 Vac

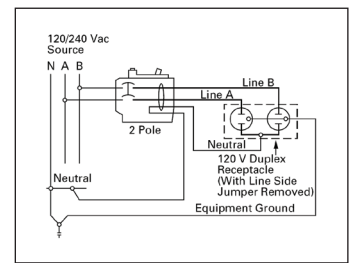
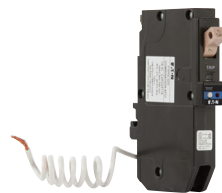

Figure 18. Two-pole, shared neutral with duplex receptacle application



Type CH single-pole AFCI circuit breaker



Type CH single-pole dual-purpose AFGF breaker

Table 34. Single-pole plug-in dual purpose AF/GF circuit breakers

Ampere rating	Wire size range (Cu/Al 60 °C or 75 °C) (AWG)	Configuration	Catalogue number
			Single-pole 120/240 Vac 10 per shelf carton 10 kAIC
15	#14-4	Standard	CHFAGF115
15	#14-4	Plug-on neutral ^a	CHFAGF115PN
20	#14-4	Standard	CHFAGF120
20	#14-4	Plug-on neutral ^a	CHFAGF120PN
Combination AFCI and 5 mA people protection ground fault			Requires one ¾-inch (19.1 mm) space

- ^a Only for use in the Type CH plug-on neutral style of combination and non-combination loadcentres.

Type CH ground fault

Type CH ground fault circuit breakers ^a

- 10,000 A interrupting capacity at 120 Vac and 120/240 Vac
- 5 mA “people protection” or 30 mA equipment protectors
- Two-pole version features common trip

Table 35. 5 mA single- and two-pole plug-in ground fault circuit breakers

Ampere rating	Wire size range Cu/Al 60 °C or 75 °C (AWG)	Catalogue number		
		Single-pole, 120 Vac Standard 1 per shelf carton 10 kAIC	Single-pole, 120 Vac Plug-on neutral ^b 1 per shelf carton 10 kAIC	Two-pole 120/240 Vac Standard 1 per shelf carton 10 kAIC
15	#14–6 ^c	CHFGFT115	CHFGFT115PN ^b	CH215GFT
20	#14–6 ^c	CHFGFT120	CHFGFT120PN ^b	CH220GFT
25	#14–6 ^c	CHFGFT125	—	CH225GFT
30	#14–6 ^c	CHFGFT130	CHFGFT130PN	CH230GFT
35	#14–6 ^c	—	—	CH235GFT
40	#14–6 ^c	—	—	CH240GFT
45	#14–6 ^c	—	—	CH245GFT
50	#14–6 ^c	—	—	CH250GFT
60	#14–6 ^c	—	—	CH260GFT
		Requires one ¾-inch (19.1 mm) space		Requires two ¾-inch (19.1 mm) spaces

^a Not for use in Type BR loadcentres i.e. CPM or CPL prefixed catalogue numbers.
^b Only for use in the Type CH plug-on neutral style of combination and non-combination loadcentres.
^c 60 A breaker listed for 75 °C Cu wire only.

Table 36. 30 mA single- and two-pole plug-in ground fault circuit breaker equipment protectors

Ampere rating	Wire size range Cu/Al 60 °C or 75 °C (AWG)	Catalogue number	
		Single-pole, 120 Vac 1 per shelf carton 10 kAIC	Two-pole, 120/240 Vac 1 per shelf carton 10 kAIC
15	#14–6 ^a	CHFEP115	CH215EPD
20	#14–6 ^a	CHFEP120	CH220EPD
25	#14–6 ^a	CHFEP125	—
30	#14–6 ^a	CHFEP130	CH230EPD
40	#14–6 ^a	—	CH240EPD
50	#14–6 ^a	—	CH250EPD
60	#14–6 ^a	—	CH260EPD
		Requires one ¾-inch (19.1 mm) space	Requires two ¾-inch (19.1 mm) spaces

^a 60 A breaker listed for 75 °C Cu wire only.

Ground fault application

Single-pole ground fault circuit breakers (Type CHGFIs) are designed for use in two-wire, 120 Vac circuits. **Figure 19** shows a typical wiring configuration. Two-pole ground fault circuit breakers (Type CHGFIs) are designed for use in three-wire, 120/240 Vac circuits, 120 Vac multi-wire circuits employing common, neutral and two-wire, 240 Vac circuits obtained from a 120/240 Vac source. **Figure 20** and **Figure 21** illustrate typical wiring configurations for 120/240 Vac multi-wire circuits. **Figure 22** depicts a 240 Vac, two-wire circuit. Note the “panel neutral” conductor connects to the neutral bar, even though the neutral is not included in the load circuit. This connection is necessary to supply a 120 Vac power source to the ground fault sensing circuit. The figures are shown with a 120/240 Vac, single-phase, three-wire power source, but are also applicable to a 120/208 Vac, three-phase, four-wire power supply. For all figures the electrical operation of the Type CHGFI is not affected by the equipment ground.



Type CH two-pole GFCI circuit breaker

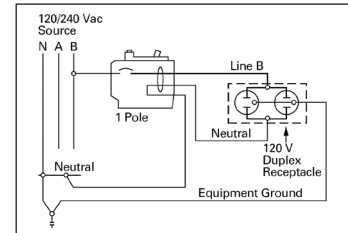

Figure 19. Single-pole single 120 V duplex receptacle application

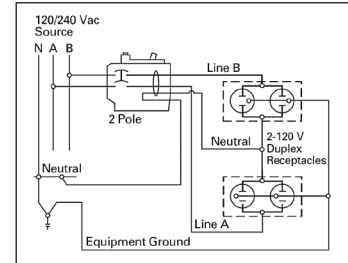

Figure 20. Two-pole 120 V multi-duplex receptacle application

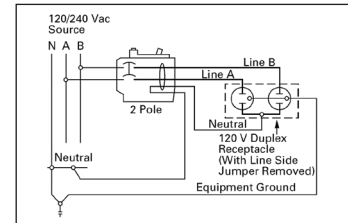

Figure 21. Two-pole 120 V duplex receptacle application

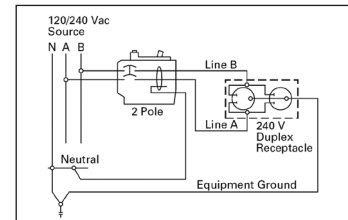

Figure 22. Two-pole 240 V duplex receptacle application

Plug-in loadcentre main circuit breakers for CH

Type CSR

Type CSR loadcentre main circuit breaker kit

- 25,000 A interrupting capacity at 120/240 Vac



CSR2150N

Product selection

Table 37. Two-pole main circuit breakers for single-phase plug-in combination loadcentres

Ampere rating	Wire size range Cu/Al 60 °C or 75 °C	Catalogue number
		Two-pole, 120/240 Vac 1 per shelf carton 25 kAIC
100	#2 AWG–300 kcmil	CSR2100N
125	#2 AWG–300 kcmil	CSR2125N
150	#2 AWG–300 kcmil	CSR2150N
200	#2 AWG–300 kcmil	CSR2200N

Plug-in loadcentres and circuit breaker accessories for CH

Type CH accessories

Plug-in loadcentre and circuit breaker accessories for CH

Product selection

Table 38. Field installation kits and parts for plug-in loadcentres and circuit breakers

Description	Ordering quantity ^a	Catalogue number
Handle tie for single-pole Type CH circuit breakers. Joins handles on breakers mounted adjacent to each other via a moulded plastic handle cover.	1	CHHT
Handle lockoff (escutcheon mounted). Single- or two-pole Type CH circuit breakers.	1	CHPL
Handle lockoff (escutcheon mounted). Single- or two-pole Type CHGFI circuit breakers.	1	CHPLGF
Handle lockoff (escutcheon mounted). Locks the handle of main circuit breaker type CSH in the OFF or ON position.	1	MCBPL
Handle lockdog (handle mounted). Single-pole Type CH circuit breakers. Secures handle in the ON or OFF position.	1	CHLO
Subfeed kit for 125 A loadcentres. Requires two 3/4-inch (19.1 mm) spaces.	1	CHSF2125
3/4-inch (19.1 mm) filler plate kit ^a	1	CHFP ^a
Door lock for 24–60 circuit 100 and 200 A (CH)	1	TDL ^b
Trim screw kit (CH)	1	LCSS ^c
Sandalwood plastic replacement door latch	1	CHRLS
Branch circuit numbering strip kit for CH	1	CHMS ^d
Electronic breaker lockoff (escutcheon mounted) for type CHFCAF and CHFAGF		CHFAGFLOFF

^a Kit includes 25 pieces.

^b Comes with a set of keys.

^c Kit includes 25 pieces.

^d Kit includes 20 pieces.

Definitions

Handle ties: Devices used to join two similar independent single-pole circuit breakers to form a two-pole non-common trip breaker.

Handle lockoffs: Devices that use a padlock to lock a circuit breaker's handle in either the ON or OFF position.

Handle lockdogs: Devices used to secure a circuit breaker's handle in the ON or OFF position. They are not padlockable devices.

Escutcheon mounted: A semipermanent mounting to the face of the circuit breaker and secured by the loadcentre's deadfront cover.

Handle mounted: A mounting made directly to the handle of the circuit breaker by means of a set screw.

Screw mounted: A permanent mounting to the face of the circuit breaker by means of a non-removable screw.

Type CBM bolt-on loadcentres

Combination Service Entrance (main circuit breaker) single- and three-phase aluminum bus

Single-phase 120/240 Vac Type 1 (indoor) loadcentres combination service entrance

- CSA certified only (not UL approved)
- Utilize Type BAB, QBHW, QBA, DNBA, or QBGF circuit breakers as branch circuit breakers



3CBM242

Product selection

Table 39. Single-phase, three-wire 120/240 Vac aluminum bus loadcentres

Maximum ampere rating	Main breaker rating	Max. no. 1-inch spaces	Max. no. 1/2-inch spaces	Cover style	Dimensions in inches (mm)			Wire size range for main Cu/Al	Catalogue number
					H	W	D		
125	100	18	36	Flush/surface	27.00 (685.8)	14.25 (361.9)	3.75 (95.3)	#8-#1 Cu / #8-1/0 Al	CBM118 ^a
125	100	30	60	Flush/surface	34.13 (866.8)	14.25 (361.9)	3.75 (95.3)	#8-#1 Cu / #8-1/0 Al	CBM130 ^a
125	100	42	84	Flush/surface	39.00 (990.6)	14.25 (361.9)	3.75 (95.3)	#8-#1 Cu / #8-1/0 Al	CBM142 ^a
225	200	18	36	Flush/surface	34.13 (866.8)	14.25 (361.9)	3.75 (95.3)	#4-4/0	CBM218 ^b
225	200	30	60	Flush/surface	39.00 (990.6)	14.25 (361.9)	3.75 (95.3)	#4-4/0	CBM230 ^b
225	200	42	84	Flush/surface	45.00 (1143.0)	14.25 (361.9)	3.75 (95.3)	#4-4/0	CBM242 ^b

^a BAB2100 main circuit breaker factory installed.

^b ED2200 main circuit breaker factory installed.

Three-phase Combination service entrance 240 Vac Type 1 (indoor) loadcentres

- CSA certified only (not UL approved)
- Utilize Type BAB, QBHW, QBA, DNBA, or QBGF circuit breakers as branch circuit breakers

Table 40. Three-phase, four-wire 240 Vac maximum aluminum bus loadcentres

Maximum ampere rating	Main breaker rating	Max. no. 1-inch spaces	Max. no. 1/2-inch spaces	Cover style	Dimensions in inches (mm)			Wire size range for main Cu/Al	Catalogue number
					H	W	D		
125	100	18	36	Flush/surface	27.00 (685.8)	14.25 (361.9)	3.75 (95.3)	#8-#1 Cu / #8-1/0 Al	3CBM118 ^a
125	100	30	60	Flush/surface	34.13 (866.8)	14.25 (361.9)	3.75 (95.3)	#8-#1 Cu / #8-1/0 Al	3CBM130 ^a
125	100	42	84	Flush/surface	39.00 (990.6)	14.25 (361.9)	3.75 (95.3)	#8-#1 Cu / #8-1/0 Al	3CBM142 ^a
225	200	18	36	Flush/surface	34.13 (866.8)	14.25 (361.9)	3.75 (95.3)	#4-4/0	3CBM218 ^b
225	200	30	60	Flush/surface	39.00 (990.6)	14.25 (361.9)	3.75 (95.3)	#4-4/0	3CBM230 ^b
225	200	42	84	Flush/surface	45.00 (1143.0)	14.25 (361.9)	3.75 (95.3)	#4-4/0	3CBM242 ^b

^a BAB3100H main circuit breaker factory installed.

^b ED3200 main circuit breaker factory installed.

Effective December 2017

Combination (main circuit breaker) single- and three-phase copper bus

Single-phase 120/240 Vac Type 1 (indoor) loadcentres combination service entrance

- CSA certified only (not UL approved)
- Utilize Type BAB, QBHW, QBA, DNBA, or QBGF circuit breakers as branch circuit breakers

Table 41. Single-phase, three-wire 120/240 Vac copper bus loadcentres

Maximum ampere rating	Main breaker rating	Max. no. 1-inch spaces	Max. no. 1/2-inch spaces	Cover style	Dimensions in inches (mm)			Wire size range for main Cu/Al	Catalogue number
					H	W	D		
125	100	18	36	Flush/surface	27.00 (685.8)	14.25 (361.9)	3.75 (95.3)	#8-#1 Cu / #8-1/0 Al	CBM118CU ^a
125	100	30	60	Flush/surface	34.13 (866.8)	14.25 (361.9)	3.75 (95.3)	#8-#1 Cu / #8-1/0 Al	CBM130CU ^a
125	100	42	84	Flush/surface	39.00 (990.6)	14.25 (361.9)	3.75 (95.3)	#8-#1 Cu / #8-1/0 Al	CBM142CU ^a
225	200	18	36	Flush/surface	34.13 (866.8)	14.25 (361.9)	3.75 (95.3)	#4-4/0	CBM218CU ^b
225	200	30	60	Flush/surface	39.00 (990.6)	14.25 (361.9)	3.75 (95.3)	#4-4/0	CBM230CU ^b

^a BAB2100 main circuit breaker factory installed.^b ED2200 main circuit breaker factory installed.

Three-phase combination service entrance 240 Vac Type 1 (indoor) loadcentres

- CSA certified only (not UL approved)
- Utilize Type BAB, QBHW, QBA, DNBA, or QBGFT circuit breakers as branch circuit breakers

Table 42. Three-phase, four-wire 240 Vac maximum copper bus loadcentres

Maximum ampere rating	Main breaker rating	Max. no. 1-inch spaces	Max. no. 1/2-inch spaces	Cover style	Dimensions in inches (mm)			Wire size range for main Cu/Al	Catalogue number
					H	W	D		
125	100	18	36	Flush/surface	27.00 (685.8)	14.25 (361.9)	3.75 (95.3)	#8-#1 Cu / #8-1/0 Al	3CBM118CU ^a
125	100	30	60	Flush/surface	34.13 (866.8)	14.25 (361.9)	3.75 (95.3)	#8-#1 Cu / #8-1/0 Al	3CBM130CU ^a
125	100	42	84	Flush/surface	39.00 (990.6)	14.25 (361.9)	3.75 (95.3)	#8-#1 Cu / #8-1/0 Al	3CBM142CU ^a
225	200	30	60	Flush/surface	39.00 (990.6)	14.25 (361.9)	3.75 (95.3)	#4-4/0	3CBM230CU ^b

^a BAB3100H main circuit breaker factory installed.^b ED3200 main circuit breaker factory installed.

Non-combination (main lug only) single- and three-phase aluminum bus

Single-phase 120/240 Vac Type 1 (indoor) loadcentres

- CSA certified only (not UL approved)
- Utilize Type BAB, QBHW, QBA, DNBA, or QBGF circuit breakers as branch circuit breakers



CBL130

Table 43. Single-phase, three-wire 120/240 Vac aluminum bus loadcentres

Maximum ampere rating	Max. no. 1-inch spaces	Max. no. 1/2-inch spaces	Cover style	Dimensions in inches (mm)			Wire size range for main Cu/Al	Catalogue number
				H	W	D		
125	18	36	Flush/surface	27.00 (685.8)	14.25 (361.9)	3.75 (95.3)	#6–300 MCM	CBL118
125	30	60	Flush/surface	34.13 (866.8)	14.25 (361.9)	3.75 (95.3)	#6–300 MCM	CBL130
125	42	84	Flush/surface	39.00 (990.6)	14.25 (361.9)	3.75 (95.3)	#6–300 MCM	CBL142
225	18	36	Flush/surface	27.00 (685.8)	14.25 (361.9)	3.75 (95.3)	#6–300 MCM	CBL218
225	30	60	Flush/surface	34.13 (866.8)	14.25 (361.9)	3.75 (95.3)	#6–300 MCM	CBL230
225	42	84	Flush/surface	39.00 (990.6)	14.25 (361.9)	3.75 (95.3)	#6–300 MCM	CBL242

Three-phase 240 Vac Type 1 (indoor) loadcentres

- CSA certified only (not UL approved)
- Utilize Type BAB, QBHW, QBA, DNBA, or QBGF circuit breakers as branch circuit breakers

Table 44. Three-phase, four-wire 240 Vac aluminum bus loadcentres

Maximum ampere rating	Max. no. 1-inch spaces	Max. no. 1/2-inch spaces	Cover style	Dimensions in inches (mm)			Wire size range for main Cu/Al	Catalogue number
				H	W	D		
125	18	36	Flush/surface	27.00 (685.8)	14.25 (361.9)	3.75 (95.3)	#6–300 MCM	3CBL118
125	30	60	Flush/surface	34.13 (866.8)	14.25 (361.9)	3.75 (95.3)	#6–300 MCM	3CBL130
125	42	84	Flush/surface	39.00 (990.6)	14.25 (361.9)	3.75 (95.3)	#6–300 MCM	3CBL142
225	18	36	Flush/surface	27.00 (685.8)	14.25 (361.9)	3.75 (95.3)	#6–300 MCM	3CBL218
225	30	60	Flush/surface	34.13 (866.8)	14.25 (361.9)	3.75 (95.3)	#6–300 MCM	3CBL230
225	42	84	Flush/surface	39.00 (990.6)	14.25 (361.9)	3.75 (95.3)	#6–300 MCM	3CBL242

Non-combination (main lug only) single- and three-phase copper bus

Single-phase 120/240 Vac Type 1 (indoor) loadcentres

- CSA certified only (not UL approved)
- Utilize Type BAB, QBHW, QBA, DNBA, or QBGF circuit breakers as branch circuit breakers

Table 45. Single-phase, three-wire 120/240 Vac copper bus loadcentres

Maximum ampere rating	Max. no. 1-inch spaces	Max. no. 1/2-inches spaces	Cover style	Dimensions in inches (mm)			Wire size range for main Cu/Al	Catalogue number
				H	W	D		
125	18	36	Flush/surface	27.00 (685.8)	14.25 (361.9)	3.75 (95.3)	#6–300 MCM	CBL118CU
125	30	60	Flush/surface	34.13 (866.8)	14.25 (361.9)	3.75 (95.3)	#6–300 MCM	CBL130CU
125	42	84	Flush/surface	39.00 (990.6)	14.25 (361.9)	3.75 (95.3)	#6–300 MCM	CBL142CU
225	18	36	Flush/surface	27.00 (685.8)	14.25 (361.9)	3.75 (95.3)	#6–300 MCM	CBL218CU
225	30	60	Flush/surface	34.13 (866.8)	14.25 (361.9)	3.75 (95.3)	#6–300 MCM	CBL230CU
225	42	84	Flush/surface	39.00 (990.6)	14.25 (361.9)	3.75 (95.3)	#6–300 MCM	CBL242CU

Three-phase 240 Vac Type 1 (indoor) loadcentres

- CSA certified only (not UL approved)
- Utilize Type BAB, QBHW, QBA, DNBA, or QBGF circuit breakers as branch circuit breakers

Table 46. Three-phase, four-wire 240 Vac copper bus loadcentres

Maximum ampere rating	Max. no. 1-inch spaces	Max. no. 1/2-inches spaces	Cover style	Dimensions in inches (mm)			Wire size range for main Cu/Al	Catalogue number
				H	W	D		
125	18	36	Flush/surface	27.00 (685.8)	14.25 (361.9)	3.75 (95.3)	#6–300 MCM	3CBL118CU
125	30	60	Flush/surface	34.13 (866.8)	14.25 (361.9)	3.75 (95.3)	#6–300 MCM	3CBL130CU
125	42	84	Flush/surface	39.00 (990.6)	14.25 (361.9)	3.75 (95.3)	#6–300 MCM	3CBL142CU
225	30	60	Flush/surface	34.13 (866.8)	14.25 (361.9)	3.75 (95.3)	#6–300 MCM	3CBL230CU
225	42	84	Flush/surface	39.00 (990.6)	14.25 (361.9)	3.75 (95.3)	#6–300 MCM	3CBL242CU

Bolt-on circuit breakers for CBM/CBL

Type BAB and QBHW single- and multi-pole

Type BAB and QBHW

- 10,000/22,000 A interrupting capacity at 120 Vac, 120/240 Vac, and 240 Vac

Product selection

Table 47. Single- and multi-pole bolt-on circuit breakers

Ampere rating	Wire size range (Cu/Al 60 °C or 75 °C) (AWG)	Catalogue number					
		Single-pole, 120/240 Vac		Two-pole, 120/240 Vac		Three-pole, 120/240 Vac	
		10 kAIC	22 kAIC	10 kAIC	22 kAIC	10 kAIC	22 kAIC
10	#14-4	BAB1010	—	—	—	—	—
15	#14-4	BAB1015	QBHW1015	BAB2015	QBHW2015	BAB3015H	QBHW3015
20	#14-4	BAB1020	QBHW1020	BAB2020	QBHW2020	BAB3020H	QBHW3020
25	#14-4	BAB1025	—	—	—	—	—
30	#14-4	BAB1030	QBHW1030	BAB2030	QBHW2030	BAB3030H	QBHW3030
40	#14-4	BAB1040	QBHW1040	BAB2040	QBHW2040	BAB3040H	QBHW3040
50	#14-4	BAB1050	QBHW1050	BAB2050	QBHW2050	BAB3050H	QBHW3050
60	#8-1 Cu, #8-1/0 Al	BAB1060	QBHW1060	BAB2060	QBHW2060	BAB3060H	QBHW3060
70	#8-1 Cu, #8-1/0 Al	BAB1070	QBHW1070	BAB2070	QBHW2070	BAB3070H	QBHW3070
90	#8-1 Cu, #8-1/0 Al	—	—	BAB2090	QBHW2090	BAB3090H	QBHW3090
100	#8-1 Cu, #8-1/0 Al	—	—	BAB2100	QBHW2100	BAB3100H	QBHW3100
125	#8-1 Cu, #8-1/0 Al	—	—	BAB2125	QBHW2125	—	—
			Requires one 1-inch (25.4 mm) space		Requires two 1-inch (25.4 mm) spaces		Requires three 1-inch (25.4 mm) spaces

Type BAB high intensity discharge (HID) rated

- 10,000 A interrupting capacity at 120 Vac, 120/240 Vac, and 240 Vac

Table 48. Single-pole HID rated bolt-on circuit breakers

Ampere rating	Wire size range (Cu/Al 60 °C or 75 °C) (AWG)	Catalogue number
		Single-pole, 120/240 Vac 10 kAIC
15	#14-4	BAB1015D
20	#14-4	BAB1020D
Requires one 1-inch (25.4 mm) space		

Table 49. Single-pole bolt-on fire alarm breakers

Ampere rating	Configuration	Catalogue number
		Single-pole, 120/240 Vac 10 per shelf carton 10 kAIC
15	Branch fire alarm	BABF1015
20	Branch fire alarm	BABF1020
	Compact body breaker	Requires one 1-inch (25.4 mm) space

Type QBA arc fault circuit interrupter and DNBA duplex

Type QBA Arc fault circuit interrupter circuit breakers

- 10,000/22,000 A interrupting capacity at 120 Vac 120/240 Vac, and 240 Vac

Table 50. Single- and two-pole bolt-on FIRE-GUARD AFCI circuit breakers

Ampere rating	Configuration	Catalogue number				Wire size range (Cu/Al 60 °C or 75 °C) (AWG)
		Single-pole 120/240 Vac		Two-pole, 120/240 Vac ^{ab}		
		10 kAIC	22 kAIC	10 kAIC	22 kAIC	
15	Standard	QBAF1015	QBHAF1015	—	—	#14–4
15	Combination	QBCAF1015	QBHCAF1015	—	—	#14–4
15	Dual With GFCI 5mA	QB1015AFGF	QBH1015AFGF	—	—	#14–4
15	Common trip	—	—	QBAF2015	QBHAF2015	#14–4
15	Independent trip	—	—	QBAF2015IT	QBHAF2015IT	#14–4
20	Standard	QBAF1020	QBHAF1020	—	—	#14–4
20	Combination	QBCAF1020	QBHCAF1020	—	—	#14–4
20	Dual With GFCI 5mA	QB1020AFGF	QBH1020AFGF	—	—	#14–4
		Requires one 1-inch (25.4 mm) space	Requires one 1-inch (25.4 mm) space	Requires two 1-inch (25.4 mm) spaces	Requires two 1-inch (25.4 mm) spaces	

a Common trip refers to two-pole 240 V load application sourced by 120/240 Vac (see **Figure 25**).

b Independent trip refers to two-pole multi-wire, home run or shared neutral circuits (see **Figure 24** and **Figure 26**).

Type DNBA duplex circuit breakers

- 10,000 A interrupting capacity at 120/240 Vac
- Provides 2 single-pole circuits in one 1-inch space

Table 51. Twin plug-in circuit breakers

Ampere rating	Wire size range (Cu/Al 60 °C or 75 °C) (AWG)	Catalogue number
		Single-pole, 120/240 Vac 10 per shelf carton
15–15	#14–4	DNBA1515
20–20	#14–4	DNBA2020
30–30	#14–4	DNBA3030
Requires one 1-inch (25.4 mm) space		

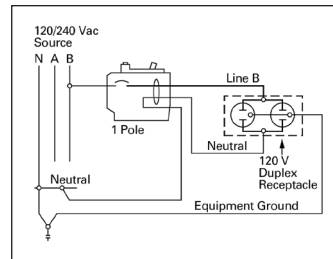

Figure 23. Single-pole, single 120 V load application sourced by 120/240 Vac

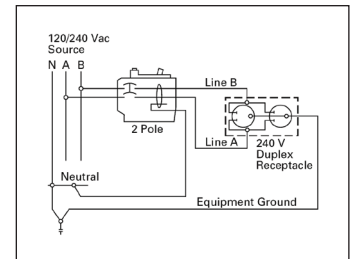

Figure 25. Two-pole, 240 V load application sourced by 120/240 Vac

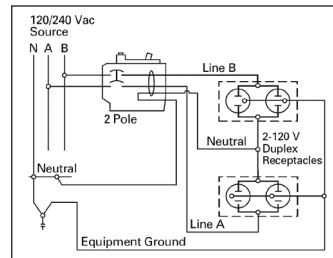

Figure 24. Two-pole, shared neutral with multi-duplex receptacle application

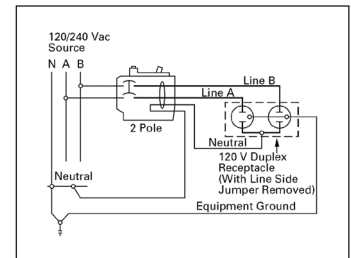

Figure 26. Two-pole, shared neutral with duplex receptacle application

Type QBGF and QBGFEP ground fault

Type QBGF and QBGFEP ground fault circuit breakers

- 10,000/22,000 A interrupting capacity at 120 Vac and 120/240 Vac
- 5 mA “people protection” or 30 mA equipment protectors
- Two-pole version features common trip

Table 52. 5 mA single- and two-pole bolt-on ground fault circuit breakers

Ampere rating	Wire size range Cu/Al 60 °C or 75 °C (AWG)	Catalogue number	
		Single-pole, 120 Vac 1 per shelf carton 10 kAIC	Two-pole, 120/240 Vac 1 per shelf carton 10 kAIC
15	#14–10 Cu, #12–10 Al	QBGFT1015	QBGFT2015
20	#14–10 Cu, #12–10 Al	QBGFT1020	QBGFT2020
30	#10 Cu, #8 Al	QBGFT1030	QBGFT2030
40	#8 Cu, #8–6 Al	QBGFT1040	QBGFT2040
50	#8–6 Cu, #6–4 Al	—	QBGFT2050
		Requires one 1-inch (25.4 mm) space	Requires two 1-inch (25.4 mm) spaces

Table 53. 30 mA single- and two-pole bolt-on ground fault circuit breaker equipment protectors

Ampere rating	Wire size range Cu/Al 60 °C or 75 °C (AWG)	Catalogue number			
		Single-pole, 120 Vac 1 per shelf carton 10 kAIC		Two-pole, 120/240 Vac 1 per shelf carton	
		10 kAIC	22 kAIC	10 kAIC	22 kAIC
15	#14–4	QBGFEP1015	QBHGFEP1015	QBGFEP2015	QBHGFEP2015
20	#14–4	QBGFEP1020	QBHGFEP1020	QBGFEP2020	QBHGFEP2020
25	#14–4	QBGFEP1025	QBHGFEP1025	QBGFEP2025	QBHGFEP2025
30	#14–4	QBGFEP1030	QBHGFEP1030	QBGFEP2030	QBHGFEP2030
		Requires one 1-inch (25.4 mm) space	Requires one 1-inch (25.4 mm) space	Requires two 1-inch (25.4 mm) spaces	Requires two 1-inch (25.4 mm) spaces

Bolt-on loadcentre and circuit breaker accessories

Bolt-on accessories

Table 54. Field installation kits and parts for bolt-on loadcentres and circuit breakers

Description	Ordering quantity	Catalogue number
Handle lockoff single-pole of Type DNBA duplex circuit breakers (package of 10)	1	BRDL1-10
Handle lockoff Type BQL circuit breakers	1	BQL-10
Handle lockoff Type BAB and QBHW circuit breakers	1	QL123PL
Handle lockdog single-pole Type BAB and QBHW circuit breakers	1	QL1NPL
Handle lockdog two- and three-pole Type BAB and QBHW circuit breakers	1	QL23NPL
Filler plates 1-inch space (package of 24)	1	BRFP
Subfeed lug 100 A (for main lug panel style)	1	CBSF100
Subfeed lug 225 A (for main lug panel style)	1	CBSF225
Subfeed lug kit 100 A three-phase (for main lug panel style)	1	3CBSF100
Subfeed lug kit 225 A three-phase (for main lug panel style)	1	3CBSF225
Circuit breaker directory card 1–42 (package of 50)	1	DIRCARD42
Circuit breaker directory sleeve (package of 25)	1	DIRSLEEVE
Loadcentre door lock	1	TDL
Isolated ground kit	1	ISGRD

Definitions

Handle lockoffs: Devices that use a padlock to lock a circuit breaker's handle in either the ON or OFF position.

Handle lockdogs: Devices used to secure a circuit breaker's handle in the ON or OFF position. They are not padlockable devices.

Manual transfer switches/generator panels

Product description

A transfer switch panel is a device that is mounted next to or incorporated within the loadcentre (distribution panel) in the home or small business. The transfer switch panel is used in conjunction with an emergency generator (usually supplied by others) and serves the purpose of turning selected circuits on and off during a power outage. The transfer switch panel allows the owner to start up a generator and then restore power to critical circuits when utility power is not available.

The owner designates which circuits are critical such as their refrigerator, furnace, and certain lighting loads. Sometimes called emergency power panels, emergency generator panels, gen. panels, transfer switches or emergency panels; transfer switch panels provide the homeowner or small business owner with a safe and easy way to continue using essential electrical loads when utility power is not available.

Application description

Transfer switch panels are most often used in residential, agricultural and light commercial applications. Comfort and safety are key concerns of many homeowners who are dependent on an uninterrupted supply of electricity.

The increase in our dependence on power is due in part to the popularity of home business and in-home care. In addition, various rural and urban regions in North America experience periodic power outages due to extreme weather conditions such as ice and snowstorms, heat waves, tornadoes or hurricanes. Regions such as Pacific, Atlantic, and Central are the strongest markets for portable generators and transfer switch panels.

Features, functions, and benefits

Eaton offers two unique manual transfer switch emergency power solutions.

- Manual transfer switches or a generator sub-panel
- Combination service entrance loadcentre with generator sub-panel

IMPORTANT

BEFORE INSTALLATION, CONSULT APPROPRIATE ELECTRICAL CODES. INSTALLATION INFORMATION IS INCLUDED IN THE CARTON.

Manual transfer switches/generator panels

- Main utility and emergency (generator) breaker factory installed
- Available in 30 and 60 A design
- Utility breaker and generator breakers are mechanically interlocked to protect equipment and personnel by preventing dangerous dual-source feeding
- Critical loads permanently connected to allow for quick and convenient switching from utility power to stand-by generator power
- Designed for switched neutral applications. Can be reconfigured in field for non-switched neutral applications
- Sturdy and reliable 125 A rated aluminum bus design
- Type BR/DNPL branch breakers sold separately
- Ideal for new and retrofit installations
- EEMAC 1 indoor enclosure design
- Standards and certifications
- CSA approved

Product specifications

- 10,000 AIC rating
- Switching devices must be circuit breakers
- Transfer switch panel must be supplied with neutral and ground



Combination service entrance loadcentre generator panel CPM126GEN

- Single enclosure (EEMAC 1) to house both loadcentre and generator breakers
- Factory installed main breakers
- Available in 100 and 200 A designs
- Utility and emergency transfer switch breaker factory installed
- Utility breaker and generator breakers are mechanically interlocked to protect equipment and personnel by preventing dangerous dual-source feeding
- Critical loads permanently connected to allow for quick and convenient switching from utility power to stand-by generator power
- Designed for switched neutral applications. Can be reconfigured in field for non-switched neutral applications
- Type BR/DNPL branch breakers sold separately
- Ideal for new and retrofit installations
- EEMAC 1 indoor enclosure design

Standards and certifications

- CSA approved

Product specifications

- 10,000 AIC rating for CPM126GEN
- 25,000 AIC rating for CPM236GEN
- Switching devices must be circuit breakers
- Transfer switch panel must be supplied with neutral and ground

Product selection

Table 55. Manual transfer switches/generator panels

Bus rating (A)	Generator breaker (A)	Switched neutral	Enclosure rating	Max. total branch circuits (1-inch/½-inch)	Inlet receptacle type	Height branch circuits in inches (mm)	Width in inches (mm)	Depth in inches (mm)	Catalogue number
125	30	Yes	EEMAC 1	6/12	—	16.75 (425.5)	14.38 (365.1)	3.88 (98.4)	CPL112G3
125	60	Yes	EEMAC 1	6/12	—	16.75 (425.5)	14.38 (365.1)	3.88 (98.4)	CPL112G6
125	60	Yes	EEMAC 1	14/28	—	21.00 (533.4)	14.38 (365.1)	3.88 (98.4)	CPL120G6
125	60	Yes	EEMAC 1	24/48	—	29.13 (739.8)	14.38 (365.1)	3.88 (98.4)	CPL130G6

Table 56. Combination service entrance loadcentre generator panel

Bus rating (A)	Loadcentre main breaker (A)	Max. total branch circuits (1-inch/½-inch)	Generator breaker (A)	Switched neutral	Max. generator branch circuits	Height in inches (mm)	Width in inches (mm)	Depth in inches (mm)	Catalogue number
125	100	26/52	30	Yes	6/12	39.00 (990.6)	14.38 (365.1)	3.88 (98.4)	CPM126GEN
200	200	36/72	60	Yes	6/12	45.00 (1143.0)	14.38 (365.1)	3.88 (98.4)	CPM236GEN

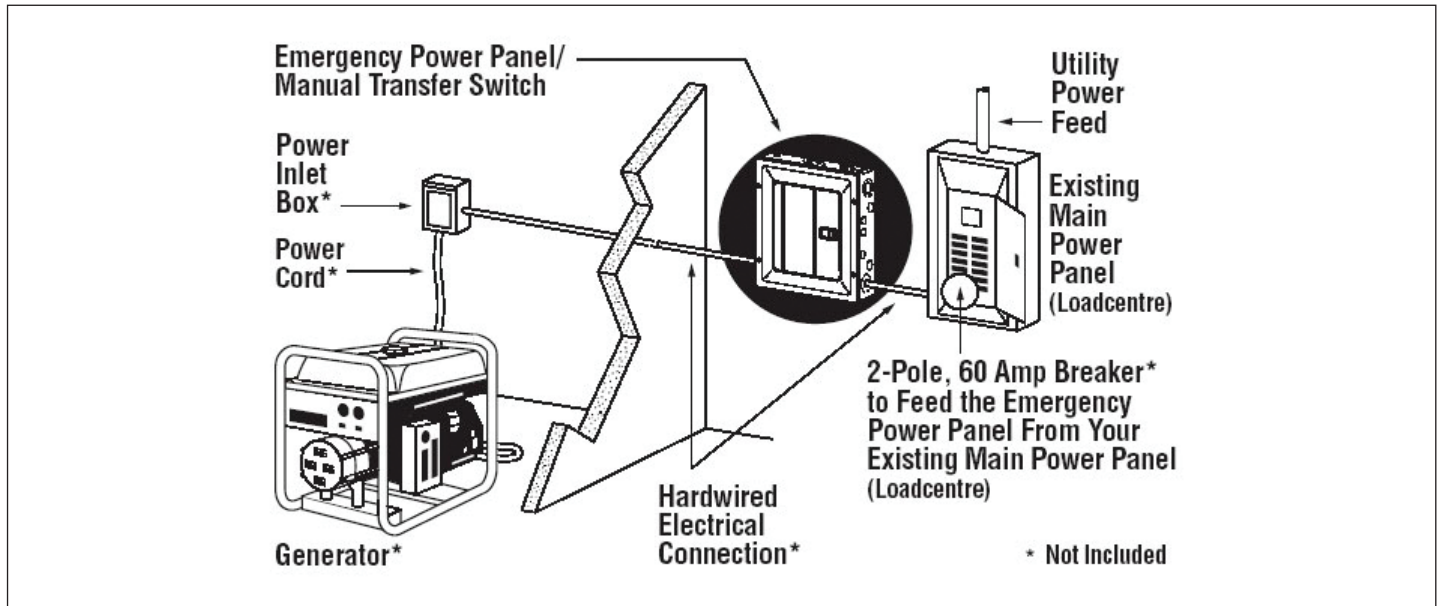

Figure 27. Typical installation diagram

Notes:

Combination service entrance loadcentre generator panels come complete with an integrated emergency generator panel.

Combination service entrance loadcentre generator panels come complete with factory installed utility feeder breaker for emergency generator panel section.

* Not Included

Spa panels

Single-phase, three-wire 120/240 Vac ground fault circuit interrupter spa panels

- Factory assembled, prewired, tested, and ready to install
- Two-pole 5 mA “people protection” Type CH ground fault circuit interrupter circuit breaker
- Two additional one-pole circuits available
- Test button provides a means of confirming proper GFCI circuit breaker operation
- 10,000 A interrupting capacity
- 120/240 Vac single-phase, three-wire
- Pre-installed neutral and ground bars
- Type 3R enclosure good for indoor or outdoor mounting
- Interior deadfront provides protection from energized parts
- Padlockable cover provides added security and safety
- Audible alarm option field installable
- Can be used as a disconnect to turn the spa pump on and off
- Main lug connections will accommodate a single #14–1/0 AWG conductor ^a

^a Refer to **page 34** for Type CH ground fault circuit breaker accepted load conductor sizes.



Product description

CEC Rule 68-086 (1) and (6) requires that a ground fault circuit interrupter, of a Class A Type, be installed not closer than 3 m (10 ft) to a pool or spa water. In cases where a spa is installed some distance from your main loadcentre it is often more convenient to locate this protection device in a small panel closer to the spa. Excessive cable lengths required to connect directly back to a protection device in your main loadcentre may be more susceptible to insulation breakage and result in nuisance tripping of the breaker. The reduced distance the owner must travel to reset a tripped circuit breaker in a localized spa panel may also be an excellent selling point for the owner.

Product selection

Table 57. Two-pole plug-in Type 3R spa panels

Breaker amperage (A)	Breaker type	Enclosure style	Audible alarm	Height in inches (mm)	Width in inches (mm)	Depth in inches (mm)	Catalogue number
30	CH	Indoor/outdoor Type 3R ^a	N	12.00 (304.8)	6.88 (174.6)	4.50 (114.3)	CH30SPAST
40	CH	Indoor/outdoor Type 3R ^a	N	12.00 (304.8)	6.88 (174.6)	4.50 (114.3)	CH40SPAST
50	CH	Indoor/outdoor Type 3R ^a	N	12.00 (304.8)	6.88 (174.6)	4.50 (114.3)	CH50SPAST
60	CH	Indoor/outdoor Type 3R ^a	N	12.00 (304.8)	6.88 (174.6)	4.50 (114.3)	CH60SPAST

^a Outdoor loadcentres accommodate Type DS conduit hubs. Hubs not included. See **page 15** for selection.

Table 58. Spa panel accessories

Description	Catalogue number
Field installable audible alarm kit (breaker and panel not included)	CHSPALARM

Note: CEC Rule 68-086 (1) and (6) requires that a ground fault circuit interrupter, of a Class A type, be installed not closer than 3 m (10 ft) to a pool or spa water.

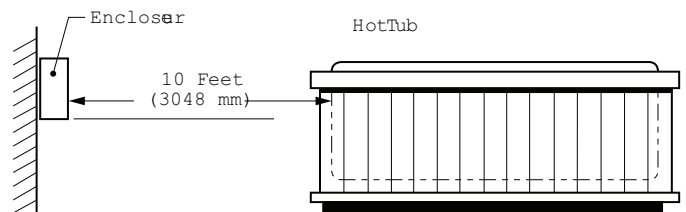

Check national and local codes for compliance.

Surge suppression products

Stage 1 and Stage 1 Type 2

Residential surge suppression products

- Stage 1 surge protection as well as Type 1 and Type 2 offering
- Convenient in-panel mount unit for Type BR loadcentres
- Knockout mount or surface mount CHSP design. DIN mount adapter for Type 1
- Limited lifetime warranty on CHSPT2ULTRA
- Dovetail clip together cable surge accessories for CHSPT2 design
- Flush mount kit for CHSPT2 design knockout mounting
- Type 2 surge suppression product designed to meet CSA C22.2 No.269-2 and UL 1449 3rd edition standard, cULus Listed No. N 024005



Product description

Today's homes are filled with increasing quantities of devices containing sensitive electronic components. These devices can easily be damaged by common power surges also some times called line transients, spikes, or voltage impulses. Lighting strikes, utility grid switching, other users on the powerline, and internal surges from air conditioners and powers tools are the most common sources these damaging line transients. To protect your investment it is recommended that a surge suppression device be installed. Surge protection can be broken into two stages. Stage 1 protection is primary protection for your service entrance. This protection is typically installed inside or adjacent to a home's service entrance distribution panel. Stage 2 protection is secondary protection or protection at the point of use. For proper surge protection both a stage 1 and stage 2 device must be installed. Eaton offers surge products to provide stage 1 protection to your sensitive equipment as well as both Type 1 and Type 2 surge devices that meet the latest CSA C22.2 No. 269 and UL 1449 3rd standard. We also offer surge protection devices for cable/satellite and Ethernet protection since surges are not isolated to the utility lines only.



Product selection Combination of Surge Protection and Surge/Breaker Protection

Ideal for applications with limited space in the panel.

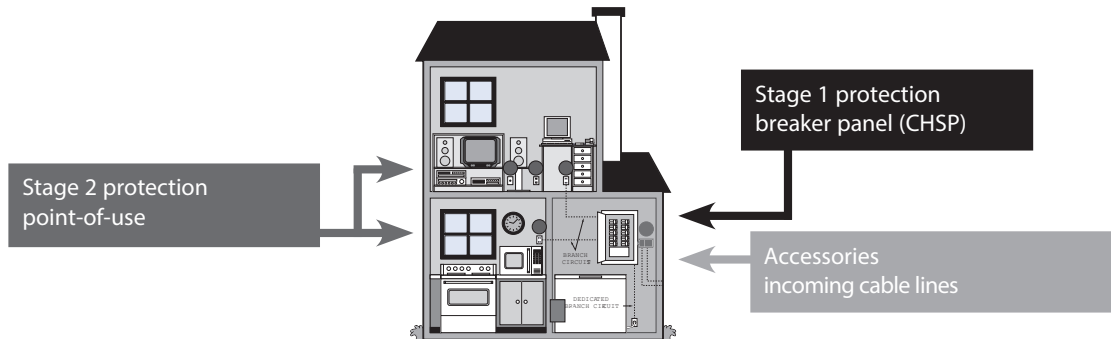

Table 59. Stage 1 Type 2 (point-of-service entrance) residential surge suppression products for Type BR/CH plug-in loadcentres

Connection	Voltage (Vac)	Phase	Frequency (Hz)	Maximum continuous operating voltage (V) ^a	Voltage protection rating ^b	Nominal discharge current (A) ^c	Short circuit current rating (A) ^d	Surge current capacity per phase (A) ^e	Catalogue number
Plug-on to loadcentre bus in Type BR loadcentres	120/240	Single	50/60	200 Line-to-Neutral (L-N) 400 Line-to-Line (L-L)	600 V L-N 1000 V L-L	3000	10,000	18,000	BRSURGE Surge only
Plug-on to loadcentre bus in Type BR loadcentres	120/240	Single	50/60	150 Line-to-Neutral (L-N) 300 Line-to-Line (L-L)	600 V L-N 1000 V L-L	10,000	10,000	36,000	BR250SUR Surge and Breaker
Plug-on to loadcentre bus in Type BR loadcentres	120/240	Single	50/60	150 Line-to-Neutral (L-N) 300 Line-to-Line (L-L)	600 V L-N 1000 V L-L	10,000	10,000	36,000	BR250SUR Surge and Breaker
Plug-on to loadcentre bus in Type CH loadcentres	120/240	Single	50/60	150 Line-to-Neutral (L-N) 300 Line-to-Line (L-L)	600 V L-N 1000 V L-L	10,000	10,000	36,000	CH230SUR Surge and Breaker
Plug-on to loadcentre bus in Type CH loadcentres	120/240	Single	50/60	150 Line-to-Neutral (L-N) 300 Line-to-Line (L-L)	600 V L-N 1000V L-L	10,000	10,000	36,000	CH250SUR Surge and breaker

^a Maximum continuous operating voltage that may be applied to the device per mode.
^b Voltage protection rating is the measured limiting voltage after a surge event.
^c Nominal discharge current is the current that the device can withstand for 15 impulses.
^d The amount of current the product can withstand under short circuit conditions.
^e The maximum one time surge current rating per phase.

Table 60. Stage 1 Type 2 (point-of-service entrance) residential surge suppression products for any loadcentre

Connection	Voltage (Vac)	Phase	Frequency (Hz)	Maximum continuous operating voltage (V) ^a	Voltage protection rating ^b	Nominal discharge current (A) ^c	Short circuit current rating (A) ^d	Surge current capacity per phase (A) ^e	Catalogue number
Can be attached to the outside of any manufacturer's loadcentre (breaker box). This product should be connected on the load side of the loadcentre main service disconnect through a dedicated circuit breaker (follow CEC guidelines).	120/240	Single	60	150 Line-to-Neutral (L-N)	600 V L-N	5,000	22,000	36,000	CHSPT2SURGE
	120/240	Single	60	300 Line-to-Line (L-L)	1000 V L-L	20,000 ^f	22,000	108,000	CHSPT2ULTRA
	120/240	Single	60		800 V N-G	20,000 ^f	22,000	108,000	CHSPT22PACK

- ^a Maximum continuous operating voltage that may be applied to the device per mode.
- ^b Voltage protection rating is the measured limiting voltage after a surge event.
- ^c Nominal discharge current is the current that the device can withstand for 15 impulses.
- ^d The amount of current the product can withstand under short circuit conditions.
- ^e The maximum one time surge current rating per phase.
- ^f When used with a 50 A two-pole breaker, 10 kA when used with a 15 A two-pole breaker.
- ^g CHSPT22PACK contains one each of CHSPT2ULTRA, CHSPCABLE.

Accessories



CHSPCABLE

Table 61. Residential surge suppression accessories

Description	Application	Product warranty	Connected equipment warranty	Maximum surge current (A) ^a	Catalogue number
SurgeCable™	Cable TV, satellite, cable modems (2 lines)	Lifetime	\$10,000	20,000	CHSPCABLE
Flushmount Kit™	Flush mount kit for finished wall installations	—	N/A	N/A	CHSPFMKIT

- ^a Maximum surge rating is the sum of all modes of protection.

Installation

CHSP and accessories can be mounted on the side, top, or bottom of a circuit breaker panel.

Note: CHSP SURGE, ULTRA or the 2-pack can be used interchangeably depending on protection required.

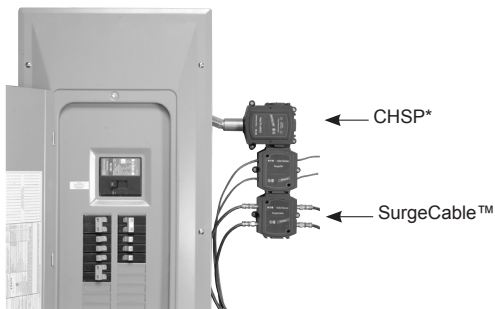

Street lighting panels

In-pole



Service entrance approved street and roadway lighting panels

- Compact in-pole panel fits into lighting pole hand well
- Pole mount 3R (rain-tight) street lighting panels can be mounted right onto the pole
- Pedestal mount 3R (rain-tight) street lighting panels feature a Eaton loadcentre housed in a Pencil enclosure

Product description

Since January 1, 2003 the Ontario Electric Safety Code requires that all roadway lighting shall meet the service entrance requirements of Rule 30-1002. Eaton has developed several designs of approved products to suit the various installation points (pole mounted, within an enclosure etc.). All products are CSA approved.

In-pole street lighting panels

- Fits into most pole manufacturers' hand well
- Service entrance approved
- 3R rain-tight
- Pre-wired
- Single- or two-pole, 22 kA, 50 A versions
- Removable mounting plates accommodate multiple hand wells
- CSA approved
- Approximate dimensions 9 x 2.25 x 4 inches
- Line power connections via #6 AWG conductor pigtail
- Load power connections via #14 AWG conductor pigtail
- #6 AWG conductor pigtail provided for daisy chaining of additional light poles

Product selection

Table 62. In-pole street lighting panels

Description	Voltage (Vac)	Main circuit breaker	Interrupting (kAIC)	Catalogue number
120 Vac in-pole compact street lighting panel	120	Single-pole 15 A	22	1SL150PCO
120 Vac in-pole compact street lightning panel	120	Single-pole 30 A	22	1SL300PCO
120 Vac in-pole compact street lighting panel	120	Single-pole 50 A	22	1SL500PCO
240 Vac in-pole compact street lighting panel	120/240	Two-pole 15 A	22	2SL150PCO
240 Vac in-pole compact street lighting panel	120/240	Two-pole 30 A	22	2SL300PCO
240 Vac in-pole compact street lighting panel	120/240	Two-pole 50 A	22	2SL500PCO

On-pole**On-pole street lighting panels**

- Mounts directly onto the pole
- Strap mount version includes slots in the enclosure back to allow for strap mounting
- Two extra 1-inch breaker locations that accept Type BR and DNPL plug-in circuit breakers for additional lighting loads
- Service entrance approved
- 3R rain-tight
- Single- or two-pole, 22 kA, 50, 60, or 70 A versions
- CSA approved
- Approximate dimensions 13 x 11 x 4.50 inches
- Bottom entry service entrance cabling only

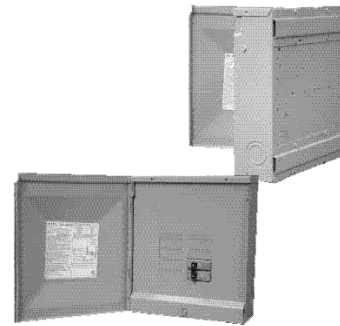
**Product selection****Table 63. On-pole street lighting panels standard mount**

Voltage (Vac)	Main circuit breaker	Interrupting (kAIC)	Branch circuits (1-inch/½-inch)	Main circuit breaker wire size range (Cu/Al 60 °C or 75 °C) (AWG)	Catalogue number
120	Single-pole 50 A	22	2/4	#14-4	1SL502
120	Single-pole 60 A	22	2/4	#4-1/0	1SL602
120	Single-pole 70 A	22	2/4	#4-1/0	1SL702
120/240	Two-pole 50 A	22	2/4	#14-4	2SL502
120/240	Two-pole 60 A	22	2/4	#4-1/0	2SL602
120/240	Two-pole 70 A	22	2/4	#4-1/0	2SL702

Table 64. On-pole street lighting panels strap mount

Voltage (Vac)	Main circuit breaker	Interrupting (kAIC)	Branch circuits (1-inch/½-inch)	Main circuit breaker wire size range (Cu/Al 60 °C or 75 °C) (AWG)	Catalogue number
120	Single-pole 50 A	22	2/4	#14-4	1SL502S
120	Single-pole 60 A	22	2/4	#4-1/0	1SL602S
120	Single-pole 70 A	22	2/4	#4-1/0	1SL702S
120/240	Two-pole 50 A	22	2/4	#14-4	2SL502S
120/240	Two-pole 60 A	22	2/4	#4-1/0	2SL602S
120/240	Two-pole 70 A	22	2/4	#4-1/0	2SL702S
120/240	Two-pole 70 A	22	6/12	#4-1/0	2SL706S

Pedestal

Pedestal mounted street lighting panels

- Lightweight, stand-alone units mount on the ground
- Polyethylene Pencil enclosure provides rugged, low profile, rain-tight assembly
- Penta head and key lock provision for security
- Vented or non-vented enclosure styles
- Two extra 1-inch breaker locations accept Type BR and DNPL plug-in circuit breakers for additional lighting loads
- Service entrance approved
- 3R rain-tight
- Single- or two-pole 22 kA, 50, 60, or 70 A versions
- CSA approved
- Underground duct or direct burial cable accessible



Product selection

Table 65. Pedestal mount non-vented street lighting panels

Voltage (Vac)	Main circuit breaker	Interrupting (kAIC)	Branch circuits (1-inch/½-inch)	Extension	Main circuit breaker wire size range (Cu/Al 60 °C or 75 °C) (AWG)	Catalogue number
120	Single-pole 50 A	22	2/4	No	#14-4	1SL502NV
120	Single-pole 60 A	22	2/4	No	#4-1/0	1SL602NV
120	Single-pole 70 A	22	2/4	No	#4-1/0	1SL702NV
120/240	Two-pole 50 A	22	2/4	No	#14-4	2SL502NV
120/240	Two-pole 60 A	22	2/4	No	#4-1/0	2SL602NV
120/240	Two-pole 70 A	22	2/4	No	#4-1/0	2SL702NV
120	Single-pole 50 A	22	2/4	Yes	#14-4	1SL502NVE
120	Single-pole 60 A	22	2/4	Yes	#4-1/0	1SL602NVE
120	Single-pole 70 A	22	2/4	Yes	#4-1/0	1SL702NVE
120/240	Two-pole 50 A	22	2/4	Yes	#14-4	2SL502NVE
120/240	Two-pole 60 A	22	2/4	Yes	#4-1/0	2SL602NVE
120/240	Two-pole 70 A	22	2/4	Yes	#4-1/0	2SL702NVE

Table 66. Pedestal mount vented street lighting panels

Voltage (Vac)	Main circuit breaker	Interrupting (kAIC)	Branch circuits (1-inch/½-inch)	Extension	Main circuit breaker wire size range (Cu/Al 60 °C or 75 °C) (AWG)	Catalogue number
120	Single-pole 50 A	22	2/4	Yes	#14-4	1SL502VE
120	Single-pole 60 A	22	2/4	Yes	#4-1/0	1SL602VE
120	Single-pole 70 A	22	2/4	Yes	#4-1/0	1SL702VE
120/240	Two-pole 50 A	22	2/4	Yes	#14-4	2SL502VE
120/240	Two-pole 60 A	22	2/4	Yes	#4-1/0	2SL602VE
120/240	Two-pole 70 A	22	2/4	Yes	#4-1/0	2SL702VE

Combined loadcentre and meter socket

Combined loadcentre and meter socket

- 4 Jaw, 100 and 200 A, 120/240 V, 22 kAIC
- Service entrance rated with 100 or 200 A main circuit breaker included
- Suitable for underground or overhead service entrance
- Meter socket mechanical lugs accommodate #6–250 MCM Cu/Al line conductors and (2) #6–300 MCM Cu/Al neutral conductors
- Loadcentre mechanical lugs load and neutral (2) #6–300 MCM Cu/Al
- CSR circuit breaker mechanical load lugs #2–300 MCM
- Suitable for overhead or underground service entrance
- Suitable applications include farming, temporary service, construction sites, trailers, and mobile homes
- Hub opening and plate included. Hubs ordered separately (use DS type hubs)
- 3R enclosure
- CSA approved



Product selection

Table 67. Combined loadcentre and meter socket

Enclosure	Voltage (V)	Amperage (A)	Interrupting (kAIC)	Entrance type	Branch circuits (1-inch/½-inch)	Weight in lb (kg)	Dimensions in inches (mm)	Catalogue number
Indoor/outdoor Type 3R	120/240	100	22	Underground/overhead	8/16	36.5 (16.6)	28.38 x 14.44 x 5.38 (974.7 x 366.7 x 136.5)	RCPM108M
Indoor/outdoor Type 3R	120/240	200	22	Underground/overhead	8/16	36.5 (16.6)	28.38 x 14.44 x 5.38 (974.7 x 366.7 x 136.5)	RCPM208M

Table 68. Knockout legend

Location	Knockout size in inches (mm)	Quantity
Bottom end wall	0.50 (12.7)	7
Bottom end wall	0.50, 0.75 (12.7, 19.1)	4
Bottom end wall	0.50, 0.75, 1.00 (12.7, 19.1, 25.4)	1
Bottom end wall	1.00, 1.25, 1.50, 2.00 (25.4, 31.8, 38.1, 50.8)	1
Bottom end wall	1.25, 1.50, 2.00, 2.50, 3.00 (31.8, 38.1, 50.8, 63.5, 76.2)	1
Top end wall	Provision for Hub ^a (e.g. DS200H2, DS250H2, DS300H2)	2
Backplane	1.25, 1.50, 2.00, 2.50 (31.8, 38.1, 50.8, 63.5)	1
Backplane	1.25, 1.50, 2.00 (31.8, 38.1, 50.8)	1
Right sidewall	1.25, 1.50, 2.00, 2.50 (31.8, 38.1, 50.8, 63.5)	1

^a Accommodate Type DS conduit hubs. Hubs not included. See **page 15** for selection.

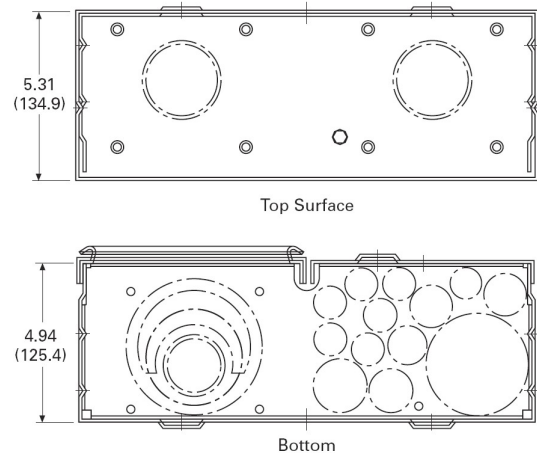

Metered temporary ground fault power panel

Metered temporary power panel with ground fault protection

- Combination loadcentre, meter socket, and electrical outlets for temporary work site installations
- Single-phase, three-wire
- 4 jaw, 100 or 200 A, 120/240 V, 22 kAIC meter socket
- Suitable for overhead or underground service entrance
- CSA approved for service entrance
- 3R enclosure suitable for outdoor installations
- Two different receptacle combinations 6X20A and 2X30A or 10X20A
- Hub opening and plate included. Hubs ordered separately (uses DS type hubs)
- Meter socket mechanical lugs accommodate #6–250 MCM Cu/Al line conductors and #6–300 MCM Cu/Al neutral conductors



Product selection

Table 69. Metered temporary ground fault protected power panel

Enclosure	Voltage (V)	Amperage (A)	Interrupting (kAIC)	Entrance Type	20 A receptacles	30 A receptacles	Dimensions in inches (mm)	Catalogue number
Indoor/outdoor Type 3R	120/240	100	22	Underground/overhead	6	2	34.38 x 22.00 x 5.38 (873.1 x 558.8 x 136.5)	RCPM1GF6H
Indoor/outdoor Type 3R	120/240	100	22	Underground/overhead	10	0	34.38 x 22.00 x 5.38 (873.1 x 558.8 x 136.5)	RCPM1GF10
Indoor/outdoor Type 3R	120/240	200	22	Underground/overhead	6	2	34.38 x 22.00 x 5.38 (873.1 x 558.8 x 136.5)	RCPM2GF6H
Indoor/outdoor Type 3R	120/240	200	22	Underground/overhead	10	0	34.38 x 22.00 x 5.38 (873.1 x 558.8 x 136.5)	RCPM2GF10

Table 70. Knockout legend

Catalogue number	Knockout size (inches)	Quantity
Bottom endwall	0.50, 0.75	6
Bottom endwall	0.50, 0.75, 1.00, 1.25	2
Bottom endwall	1.00, 1.25, 1.50, 2.00, 2.50	1
Bottom endwall	1.00, 1.25, 1.50, 2.00, 2.50, 3.00	1
Top endwall	Provision for Hub ^a (e.g. DS200H2, DS250H2, DS300H2)	1

^a Accommodate Type DS conduit hubs. Hubs not included. See **page 15** for selection.



Top Surface

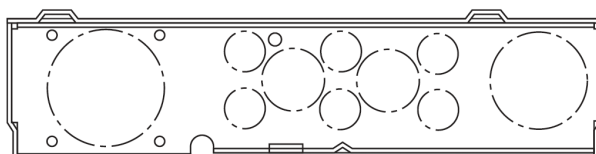

Bottom

Mini-power centres



Mini-power centres

- Distribution transformer, breaker protection, and loadcentre all in one compact package
- Primary and secondary breaker protection via factory installed EHD or FDB type MCCBs
- 18, 25, or 35 kAIC interrupting capacity versions available on select models through special order
- Two styles of interior; one for plug-in or bolt-on (breakers not included)
- Loadcentre accommodates up to 24 feeder circuit breakers (breakers purchased separately)
- Aluminum chassis on plug-in type, copper chassis on bolt-on type, standard ground bar, and enclosure grounded neutral bar
- All live parts are enclosed
- Hinged, padlockable cover prevents removal
- Enclosure includes grounding terminal
- Type 3R enclosure with baked polymer polyester powder coating is good for indoor or outdoor mounting
- Optional Type 3R, 316 grade stainless steel enclosure
- Main circuit breaker barrier provides CSA approval for service entrance applications
- Electrical grade aluminum windings standard on the distribution transformer (copper optional)
- Copper windings standard on bolt-on style units
- 185 °C insulation system
- 115 °C winding temperature rise
- Full capacity taps (FCBN) 2–5%
- Resin encapsulated, core-coil assembly (cores grounded with copper lead)

Product description

Contemporary electrical distribution systems are required to do more in less space while at the same time being cost-effective. Eaton provides a solution to these requirements with the proven mini-power centre. It occupies considerably less space and can save up to 31 percent of the installation costs normally required when individual components are used. The solution is possible because a mini-power centre combines three individual components into one NEMA Type 3R enclosure: a main breaker, an encapsulated Type EP or EPT dry-type transformer, and a secondary distribution loadcentre with main breaker. Interconnecting wiring is completed at the factory. A mini-power centre is delivered ready for installation. It's suitable for use as service entrance equipment, too. Mini-power centres are used wherever there is a 480 V or 600 V distribution system and loads requiring 208Y/120 V three-phase or 120/240 V single-phase.

Typical installations include:

- Industrial plant assembly lines
- Plant expansions
- Commercial buildings
- Test equipment
- Temporary power at construction sites
- Sewage disposal plants
- Warehouses
- Car washes
- Parking lots

The mini-power centre saves you space, time, and money. A mini-power centre installation takes up only 42% of the space taken up by a typical installation. A typical installation being comprised of a separately mounted distribution transformer, disconnect switch, loadcentre and all associated wiring and connectors.

The installation costs of a mini-power centre are 31% less when compared with the same typical installation.

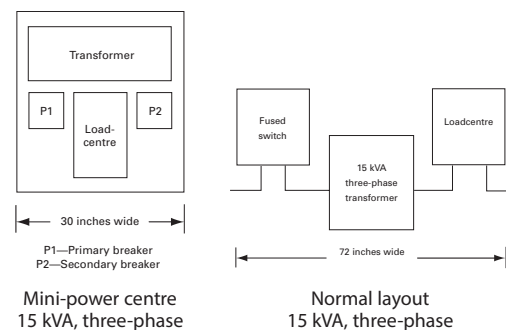

Installation	Time to perform task(s) a (hours)			
	Typical installation 15 kVA	Mini-power centre installation 15 kVA	Typical installation 25 kVA	Mini-power centre installation 25 kVA
Switch and fuse mounting	5	0	5	0
Transformer layout (remove knockout, etc.)	16	16	24	24
Fasten transformer to wall	4	0	4	0
Layout loadcentre, mount and connect source	4	4	6	4
Total hours	29	20	39	28
% time saved by using a eaton mini-power centre		31%		28%

Plug-in mini-power centres

Plug-in

Table 71. Single-phase plug-in mini-power centres

kVA	Primary and secondary voltage (V)	Catalogue number ^a	Main circuit breaker ^b		Maximum number of feeder circuit breakers			Maximum amperage	Dimensions in inches (mm) ^c			Weight in lb (kg)
			Primary	Secondary	Single-pole	Two-pole	Three-pole		Height	Width	Depth	
3	480 to 120/240	P48G11S03P	EHD2015	BR215	8	4	—	12	27.05 (699.0)	12.60 (320.0)	9.70 (245.0)	105 (47)
5	480 to 120/240	P48G11S05P	EHD2020	BR225	12	6	—	20	29.50 (749.0)	12.60 (320.0)	9.70 (245.0)	105 (47)
7.5	480 to 120/240	P48G11S07P	EHD2030	BR230	12	6	—	30	29.50 (749.0)	12.60 (320.0)	9.70 (245.0)	125 (56)
10	480 to 120/240	P48G11S10P	EHD2040	BR250	12	6	—	40	38.20 (970.0)	13.50 (343.0)	11.80 (300.0)	177 (80)
15	480 to 120/240	P48G11S15P	EHD2060	BR270	20	10	—	60	38.20 (970.0)	13.50 (343.0)	11.80 (300.0)	212 (96)
25	480 to 120/240	P48G11S25P	EHD2100	BR2125	26	13	—	100	43.90 (1115.0)	16.40 (417.0)	11.80 (300.0)	373 (169)
5	600 to 120/240	P60G11S05P	FDB2015	BR225	12	6	—	20	29.50 (749.0)	12.60 (320.0)	14.60 (370.0)	105 (47)
7.5	600 to 120/240	P60G11S07P	FDB2030	BR230	12	6	—	30	29.50 (749.0)	12.60 (320.0)	9.70 (245.0)	125 (56)
10	600 to 120/240	P60G11S10P	FDB2040	BR250	12	6	—	40	38.20 (970.0)	13.50 (343.0)	9.70 (245.0)	177 (80)
15	600 to 120/240	P60G11S15P	FDB2060	BR270	20	10	—	60	38.20 (970.0)	13.50 (343.0)	11.80 (300.0)	212 (96)
25	600 to 120/240	P60G11S25P	FDB2100	BR2125	26	13	—	100	43.90 (1115.0)	16.40 (417.0)	14.60 (370.0)	373 (169)

^a For a primary main circuit breaker interrupting capacity greater than 10 kAIC, add the following suffixes to the catalogue number; for 18 kAIC, add "F"; for 25 kAIC, add "H"; and for 35 kAIC, add "C".

^b Main circuit breakers fixed only. No substitutes.

^c Not for construction purposes.

Note: For price and delivery on a unit with copper transformer windings or 316 grade stainless steel enclosure, contact your local Eaton sales representative or our Customer Service centre at 1-800-268-3578. Feeder circuit breakers not included. Uses Eaton Type BR circuit breakers.

Table 72. Three-phase plug-in mini-power centres

kVA	Primary and secondary voltage (V)	Catalogue number ^a	Main circuit breaker ^b		Maximum number of feeder circuit breakers			Maximum amperage	Dimensions in inches (mm) ^c			Weight in lb (kg)
			Primary	Secondary	Single-pole	Two-pole	Three-pole		Height	Width	Depth	
15	480 to 120/208	P48G28T15P	EHD3040	BR350	18	9	6	40	36.10 (917.0)	28.80 (732.0)	9.70 (245.0)	320 (145)
22.5	480 to 120/208	P48G28T21P	EHD3070	BR370	18	9	6	60	40.90 (1039.0)	29.90 (759.0)	11.80 (300.0)	565 (256)
30	480 to 120/208	P48G28T30P	EHD3090	BR3100	24	12	8	80	41.90 (1064.0)	29.90 (759.0)	13.60 (346.0)	635 (288)
15	600 to 120/208	P60G28T15P	FDB3030	BR350	18	9	6	40	36.10 (917.0)	28.80 (732.0)	9.40 (238.0)	320 (145)
22.5	600 to 120/208	P60G28T21P	FDB3050	BR370	18	9	6	60	40.90 (1039.0)	29.90 (759.0)	5650 (256.0)	565 (256)
30	600 to 120/208	P60G28T30P	FDB3070	BR3100	24	12	8	80	41.90 (1064.0)	29.90 (759.0)	6350 (288.0)	635 (288)

^a For a primary main circuit breaker interrupting capacity greater than 10 kAIC, add the following suffixes to the catalogue number; for 18 kAIC add "F", for 25 kAIC add "H", and for 35 kAIC add "C".

^b Main circuit breakers fixed only. No substitutes.

^c Not for construction purposes.

Note: For price and delivery on a unit with copper transformer windings or 316 grade stainless steel enclosure, contact your local Eaton sales representative or our Customer Service centre at 1-800-268-3578. Feeder circuit breakers not included. Uses Eaton Type BR circuit breakers.

Bolt-on mini-power centres

Bolt-on

Table 73. Single-phase bolt-on mini-power centres

kVA	Primary and secondary voltage (V)	Catalogue number	Main circuit breaker ^a		Maximum number of feeder circuit breakers ^{bc}			Maximum amperage	Dimensions in inches (mm) ^d			Weight in lb (kg)
			Primary	Secondary	Single-pole	Two-pole	Three-pole		Height	Width	Depth	
3	480 to 120/240	P48G11S03CUB	EHD2015L	BAB2015	12	6	—	12	33.20 (845.0)	12.60 (320.0)	9.70 (245.0)	105 (47)
5	480 to 120/240	P48G11S05CUB	EHD2020L	BAB2025	18	9	—	20	36.10 (918.0)	12.60 (320.0)	9.70 (245.0)	110 (50)
7.5	480 to 120/240	P48G11S07CUB	EHD2030L	BAB2030	18	9	—	30	36.10 (918.0)	12.60 (320.0)	9.70 (245.0)	110 (50)
10	480 to 120/240	P48G11S10CUB	EHD2040L	BAB2050	18	9	—	40	40.90 (1038.0)	13.50 (343.0)	11.80 (300.0)	180 (82)
15	480 to 120/240	P48G11S15CUB	EHD2060L	BAB2070	24	12	—	60	43.90 (1115.0)	15.00 (380.0)	11.80 (300.0)	215 (98)
25	480 to 120/240	P48G11S25CUB	EHD2100L	BAB2125	30	15	—	100	43.40 (1102.0)	20.40 (518.0)	14.60 (370.0)	385 (175)
3	600 to 120/240	P60G11S03CUB	FDB2015L	BAB2015	12	6	—	12	33.20 (845.0)	12.60 (320.0)	9.70 (245.0)	105 (47)
5	600 to 120/240	P60G11S05CUB	FDB2020L	BAB2025	18	9	—	20	36.10 (918.0)	12.60 (320.0)	9.70 (245.0)	110 (50)
7.5	600 to 120/240	P60G11S07CUB	FDB2030L	BAB2030	18	9	—	30	36.10 (918.0)	12.60 (320.0)	9.70 (245.0)	110 (50)
10	600 to 120/240	P60G11S10CUB	FDB2040L	BAB2050	18	9	—	40	40.90 (1038.0)	13.50 (343.0)	11.80 (300.0)	180 (82)
15	600 to 120/240	P60G11S15CUB	FDB2060L	BAB2070	24	12	—	60	43.90 (1115.0)	15.00 (380.0)	11.80 (300.0)	215 (98)
25	600 to 120/240	P60G11S25CUB	FDB2100L	BAB2125	30	15	—	100	43.40 (1102.0)	20.40 (518.0)	14.60 (370.0)	385 (175)

^a Main circuit breakers fixed only. No substitutes.

^b Feeder circuit breakers not included. Uses Eaton Type BAB circuit breakers.

^c Combinations can be selected.

^d Not for construction purposes.

Table 74. Three-phase bolt-on mini-power centres

kVA	Primary and secondary voltage (V)	Catalogue number	Main circuit breaker ^a		Maximum number of feeder circuit breakers ^{bc}			Maximum amperage	Dimensions in inches (mm) ^d			Weight in lb (kg)
			Primary	Secondary	Single-pole	Two-pole	Three-pole		Height	Width	Depth	
15	480 to 120/208	P48G28T15CUB	EHD3040L	BAB3050H	18	9	6	40	36.10 (917.0)	28.70 (730.0)	9.40 (238.0)	320 (148)
22.5	480 to 120/208	P48G28T21CUB	EHD3070L	BAB3070H	18	9	6	60	40.90 (1038.0)	29.90 (759.0)	13.60 (346.0)	565 (257)
30	480 to 120/208	P48G28T30CUB	EHD3090L	BAB3100H	24	12	8	80	41.90 (1063.0)	29.90 (759.0)	13.60 (346.0)	635 (288)
15	600 to 120/208	P60G28T15CUB	FDB3030	BAB3050H	18	9	6	40	36.10 (917.0)	28.70 (730.0)	9.40 (238.0)	320 (148)
22.5	600 to 120/208	P60G28T21CUB	FDB3050	BAB3070H	18	9	6	60	40.90 (1038.0)	29.90 (759.0)	13.60 (346.0)	565 (257)
30	600 to 120/208	P60G28T30CUB	FDB3070	BAB3100H	24	12	8	80	41.90 (1063.0)	29.90 (759.0)	13.60 (346.0)	635 (288)

^a Main circuit breakers fixed only. No substitutes.

^b Feeder circuit breakers not included. Uses Eaton Type BAB circuit breakers.

^c Combinations can be selected.

^d Not for construction purposes.

Residential fuse panel inserts

Residential fuse panel inserts^a

- Convenient and economical option to completely replacing an entire fuse panel assembly
- Original fuse panel tub and wiring remains in place and only the fuse panel trim and interior is removed and replaced
- 16 and 24 circuit breaker interiors designed to fit any manufacturers' fuse panel or discontinued design circuit breaker panel
- Custom trim and door oversized to ensure fit with existing tub
- Circuit breaker interior replacement eliminates the possibility of improperly sized amperage protection
- No more loose fuses causing arcing and damage to the panel or wiring
- CSA certified to mount into any existing box under file LL264-222
- Can be mounted in any orientation as defined by the existing fuse panel tub orientation
- Accepts plug-in Type BR, DNPL, or GFCB circuit breakers (circuit breakers sold separately, refer to **page 17** to **page 20** for selection)
- Trim comes complete with hinged door, non-locking spring latch, clear plastic card holder, and circuit directory card
- Tin plated aluminum bus bars

^a Not for use as service entrance equipment.

Product description

Fuses and fuse panels were designed decades ago, to prevent the overload of circuit wiring that could lead to fires caused by overloaded electrical circuit connections and/or short circuits. Records show however, that problems of fire and smoke inhalation are the more serious causes of death or injury.

Since early 1960's, technology has allowed a tremendous increase in the number and use of appliances, tools, and control systems, many of which are automatically controlled and cycle on and off. We now know that a cycling load will actually cause a plug (screw-on-type) fuse to loosen in its holder (that explains why you can always find one or two fuses that can be tightened a quarter turn). Loose connections such as these develop heat, and in turn increase the risk of fire.

Small overloads can be absorbed by the margin of safety built into CSA certified devices. However, prolonged overloads or loose fuses will cause arcing and ultimately, melting of the connections in either the panel or wiring, wherever the weakest link may be.

Eaton has designed a low cost method of replacing fuse panels with modern circuit breaker panels. This method eliminates the need for cutting, re-plastering and repainting the walls around the old panel.

Another risk with the old fuse panel design was the ease with which incorrect fuses could be used or changed without realization of the risks involved.

To eliminate these potential hazards Eaton has a new circuit breaker interior and trim kit that will quickly upgrade the existing installation to today's electrical standards and needs. An average upgrade takes one hour and thus creates the minimum of inconvenience to the homeowner/occupant.

Sample specification

- Supply and install a new circuit breaker interior to replace existing plug fuse panel interior or out of date circuit breaker interior in each apartment or condominium
- Interior to be 16 or 24 circuit, rated 100 A and 120/240 V, designed in a single row breaker arrangement for fitting into existing recessed electrical panels
- Supply and install new trim and door assembly slightly larger than discarded fuse trim to minimize any requirements for patching or repainting
- Bus bars shall be tin plated aluminum suitable for plug-in circuit breakers
- Supply and install a trim and door assembly with latch, to protect the circuit breaker toggle handles
- Inserts must be CSA certified for mounting in any position, for ease in connecting to existing wiring
- Install circuit breakers with ratings as indicated in specifications or drawings
- Interiors to be mounted with directions template and hardware supplied by Eaton
- Inserts, trim and door assembly and circuit breakers, shall be manufactured by Eaton
- Provide a circuit identification card, mounted under clear plastic on the inside of the door

Insert interiors

Residential fuse panel insert interiors

- 100 A single-phase, three-wire 120/240 Vac
- 16 and 24 circuit breaker capacity ^a
- CSA certified to mount into any existing box under file LL264-222
- Accepts plug-in type BR and DNPL circuit breakers ^{ab}
- Tin plated aluminum bus bars
- Neutral available with 16 or 24 Cu/Al terminals
- Main and neutral lugs located at the same end
- All terminals accept #14–3 AWG cabling

^a Filler plates for unused fuse panel insert circuit breaker installation locations can be ordered as BRFP (package of 24).

^b Refer to **page 17** to **page 20** for plug-in circuit breaker selection.

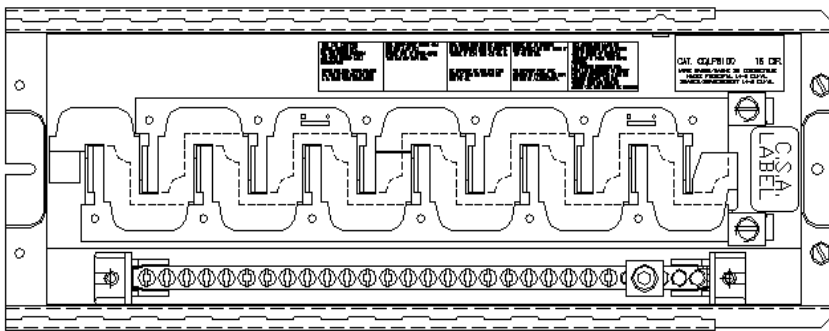
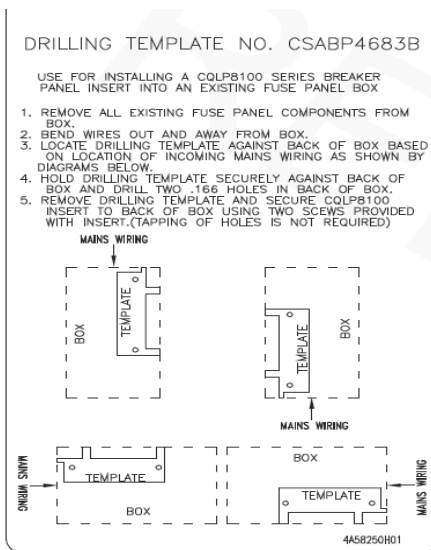

Table 75. Three-wire 120/240 Vac fuse panel insert interiors

Amperage rating (A)	Voltage (V)	Number of installable circuit breakers		Bus material	Neutral material	Wire size range Cu/Al	Catalogue number	Drilling template catalogue number ^a
		1-inch spaces	1/2-inch spaces					
100	120/240	8	16	Aluminum	Aluminum	#14–3 AWG	CQLP8100	CSABP4683B
100	120/240	12	24	Aluminum	Aluminum	#14–3 AWG	CQLP12100	CSABP4734B

^a We suggest the use of templates to ensure proper sizing for installation.



Trims

Residential fuse panel insert trims

- Doors are die formed with sloping sides and rounded corners and permanently mounted to the trim
- Semi concealed hinges ^a
- Includes circuit directory card and self adhesive clear plastic directory holder
- Painted ASA61 light grey baked on enamel
- Mounting hardware included ^b
- Trims are custom sized larger than the existing trim and door
- Trim mounting holes located to line up with existing box holes ^c

- ^a If the main service entrance is bottom entry, the door hinges left. If it is top entry, then the door hinges right.
- ^b The hardware supplied will accommodate boxes that are mounted up to 1/2-inch too deep or equal to 3-1/2 inches net depth.
- ^c Measure the existing box holes locations as they may be part of the end walls, side walls, or tapped into a box flange.

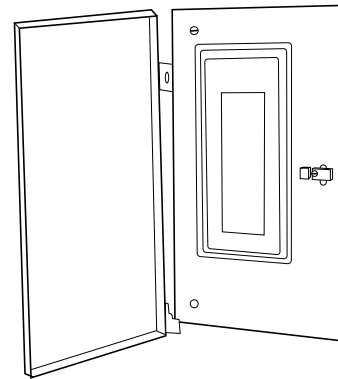

Table 76. Fuse panel insert trims

Original manufacturer	Fuse panel catalogue number	Box dimensions (inches)			Replacement trim catalogue number	Trim size (inches)		Replacement interior catalogue number	Trim mounting holes (inches)	
		Height	Width	Depth		Height	Width		Height	Width
Amalgamated	4112	16-1/8	8-1/2	2-15/16	QLPT16D	18-1/4	9-3/4	CQLP8100	16-1/6	4
Amalgamated	4116	19-1/2	8-1/2	2-15/16	QLPT19D	20-7/8	9-3/4	CQLP8100	18-11/16	4
Amalgamated	4120	22-7/8	8-1/2	2-15/16	QLPT22AD	25	10-1/2	CQLP12100 ^a	22-1/4	6
Amalgamated	4208	16-1/8	8-1/2	2-15/16	QLPT16AD	18-1/4	10-5/16	CQLP8100	15-1/2	6
Amalgamated	4212	19-1/2	8-1/2	2-15/16	QLPT20AD	20-7/8	9-3/4	CQLP8100	18-11/16	6
Amalgamated	4216	22-7/8	8-1/2	2-15/16	QLPT22AD	25	10-1/2	CQLP12100 ^a	22-1/4	6
Amalgamated	4220	24-1/8	8-1/2	2-15/16	QLPT24D	26	9-3/4	CQLP12100 ^a	23-13/16	4
Amalgamated	4312	22-7/8	8-1/2	2-15/16	QLPT22AD	25	10-1/2	CQLP12100 ^a	22-1/4	6
CEB	NHP10-636-3 ^b	24	10	3	QLPT24LD	26	12	CQLP12100 ^a	23-13/16	4
CEB	NHP6-60 ^c	14	7-3/4	3	QLPT14D	16	9-3/4	CQLP8100	13-3/16	4
CEB	NHP12-60	20	7-3/4	3	QLPT20D	21-3/4	9-3/4	CQLP12100 ^a	19-9/16	4
CEB	NHP12-633	23	7-3/4	3	QLPT24D	26	9-3/4	CQLP12100 ^a	23-13/16	4
CEB	NHP4-632	16-1/4	7-3/4	3	QLPT16D	18-1/4	9-3/4	CQLP8100	16-1/6	4
CEB	NHP6-633	20	7-3/4	3	QLPT19D	20-7/8	9-3/4	CQLP8100	18-11/16	4
CEB	NHP6-636-4	24	7-3/4	3	QLPT24D	26	9-3/4	CQLP12100 ^a	23-13/16	4
CEB	NHP8-60	16-1/8	7-3/4	3	QLPT16D	18-1/4	9-3/4	CQLP8100	16-1/6	4
CEB	NHP8-635-3	23	7-3/4	3	QLPT24D	26	9-3/4	CQLP12100 ^a	23-13/16	4
Taylor (Crouse-Hinds)	NHP6-30-60	21	7-3/8	3	QLPT20D	21-3/4	9-3/4	CQLP12100 ^a	19-9/16	4
Taylor (Crouse-Hinds)	NHP20-1231	24-1/2	9-1/2	3	QLPT24D	26	9-3/4	CQLP12100 ^a	23-13/16	4
Taylor (Crouse-Hinds)	NHP20-0821-6	24-1/2	9-1/2	3	QLPT24D	26	9-3/4	CQLP12100 ^a	23-13/16	4
Taylor (Crouse-Hinds)	NHP12B-1000-2	17-1/8	9-1/2	3	QLPT16AD	18-1/8	10-5/16	CQLP8100	15-1/2	6
Taylor (Crouse-Hinds)	NHP10-0401-4	17-1/8	9-1/2	3	QLPT16AD	18-1/8	10-5/16	CQLP8100	15-1/2	6
Taylor (Crouse-Hinds)	NHP10-0601-2	17-1/8	9-1/2	3	QLPT16AD	18-1/8	10-5/16	CQLP8100	15-1/2	6
Taylor (Crouse-Hinds)	NHP10-0611	17-1/8	9-1/2	3	QLPT16AD	18-1/8	10-5/16	CQLP8100	15-1/2	6
Taylor (Crouse-Hinds)	NHP10-0801	17-1/8	9-1/2	3	QLPT16AD	18-1/8	10-5/16	CQLP8100	15-1/2	6
Taylor (Crouse-Hinds)	NHP12-0811	19-1/4	9-1/2	3	QLPT22AD	25	10-1/2	CQLP12100 ^a	22-1/4	6
Taylor (Crouse-Hinds)	NHP14-0801-4	19-1/4	9-1/2	3	QLPT22AD	25	10-1/2	CQLP12100 ^a	22-1/4	6
Taylor (Crouse-Hinds)	NHP14-0621-2	19-1/4	9-1/2	3	QLPT22AD	25	10-1/2	CQLP12100 ^a	22-1/4	6

^a Panel insert CQLP8100 can also be used with this size trim.

^b For box sizes either 26 inches or 27-1/2 inches high, no insert or trim is available.

^c For box size 14" only

Replacement classic circuit breakers

Bolt-on Type BQL single-, multi-pole, Duplex, and Quadplex

Type BQL ^a

- 10,000/22,000 A interrupting capacity at 120/240 Vac
- Captive line screw included (#2 Robertson/Slot)

^a HACR rated.

Product selection

Table 77. Single- and multi-pole bolt-on classic replacement circuit breakers

Ampere rating	Wire size range (Cu/Al 60 °C or 75 °C) (AWG)	Catalogue number							
		Single-pole, 120/240 Vac		Two-pole, 120/240 Vac		Three-pole, 120/240 Vac			
		10 kAIC	22 kAIC	10 kAIC	10 kAIC	22 kAIC	22 kAIC		
15	#14–8	BQL15 ^a	HBQL15	BQL215		BQL315	HBQL315		
20	#14–8	BQL20 ^a	HBQL20	BQL220		BQL320	—		
25	#14–8	BQL25	HBQL25	BQL225		—	—		
30	#14–8	BQL30	HBQL30	BQL230		BQL330	HBQL330		
40	#14–4	BQL40	HBQL40	BQL240		BQL340	—		
50	#14–4	BQL50	HBQL50	BQL250		BQL350	HBQL350		
60	#8–2/0	BQL60	HBQL60	BQL260		BQL360	HBQL360		
70	#8–2/0	—	—	BQL270		BQL370	HBQL370		
90	#8–2/0	—	—	BQL290		BQL390	HBQL390		
100	#8–2/0	—	—	BQL2100		BQL3100	HBQL3100		
125	#8–2/0	—	—	BQL2125		—	—		
135	#8–2/0	—	—	BQL2135		—	—		
				Requires one 1-inch (25.4 mm) space		Requires two 1-inch (25.4 mm) spaces		Requires three 1-inch (25.4 mm) spaces	

^a Switching duty rated (SWD).

Type BQL Duplex and Quadplex ^a

- 10,000 A interrupting capacity at 120/240 Vac
- Captive line screw included (#2 Robertson/Slot)

^a HACR rated.

Table 78. Type BQL Duplex and Quadplex bolt-on classic replacement circuit breakers

Duplex		Quadplex independent trip							Wire size range (Cu/Al 60 °C or 75 °C) (AWG)	
Two single-pole circuits		Two single-pole circuits and one two-pole circuit				Two two-pole circuits				
Ampere rating		Ampere rating				Ampere rating				
		120 Vac		120/240 Vac		120 Vac		120/240 Vac		
120 Vac	Catalogue number	Outer left (single-pole)	Centre (two-pole)	Outer right (single-pole)	Catalogue number	Outer left and right (two-pole)	Centre (two-pole)	Catalogue number		
15–15	BQLT15 ^a	15	15	15	BQLT15215	15	15	BQLT215215	#14–4	
20–20	BQLT20 ^a	15	20	15	BQLT15220	20	20	BQLT220220	#14–4	
30–30	BQLT30 ^a	15	25	15	BQLT15225	15	30	BQLT215230	#14–4	
—	—	15	30	15	BQLT15230	15	40	BQLT215240	#14–4	
—	—	15	40	15	BQLT15240	—	—	—	#14–4	
Requires one 1-inch (25.4 mm) space		Requires two 1-inch (25.4 mm) spaces				Requires two 1-inch (25.4 mm) spaces				

^a Switching duty rated (SWD).

Bolt-on Type BQL ground fault and moulded case switches

Type BQL ground fault circuit breakers

- 10,000 A interrupting capacity at 120/240 Vac
- 5 mA “people protection”

Product selection

5 mA single- and two-pole bolt-on ground fault circuit breakers are no longer able to be manufactured due to change in UL standard to require all GF devices to “Self Test.”

Type BQL non-automatic circuit breakers (moulded case switches)

- 240 Vac
- Two- and three-pole versions

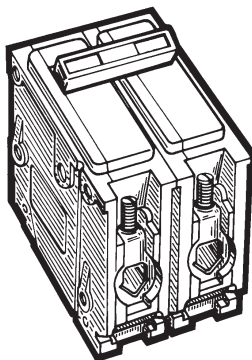

Non-automatic circuit breaker (moulded case switch)

Table 79. Two- and three-pole bolt-on non-automatic circuit breakers (moulded case switches)

Ampere rating	Wire size range Cu/Al 60 °C or 75 °C (AWG)	Catalogue number	
		Two-pole, 240 Vac	Three-pole, 240 Vac
60	#8-1 Cu #8-1/0 Al	BQL260NA Requires two 1-inch (25.4 mm) spaces	BQL360NA Requires three 1-inch (25.4 mm) spaces

Note: When the Canadian Electrical Code requires the use of an unfused disconnect device as a local isolation switch, then a circuit breaker enclosure may be used in conjunction with a moulded case switch (a.k.a. a non-automatic circuit breaker). For example, with an air conditioning unit, the protective device for these applications is located upstream.

Bolt-on Type QBH single-, multi-pole and accessories

Type QBH

- 120/240 Vac
- 3/4-inch form factor
- Designed to fit the classic CEB, Sylvania or Commander Electric design bolt-on loadcentres
- Suitable for loadcentres, lighting and distribution panelboards, and meter centres
- Silver Tungsten contacts with wiping action to prevent carbon buildup on the contact surface
- Handle provides clear indication of ON/OFF/TRIPPED position
- Quick-make / quick-break mechanism provides tease-proof operation
- Internal common trip mechanism on two-pole circuit breakers
- Each breaker is electronically calibrated for 40 °C
- Compression moulded housing and handle for durability and service

Table 80. Single- and two-pole bolt-on classic replacement circuit breakers

Ampere rating	Wire size range 60 °C or 75 °C (AWG)	Catalogue number	
		Single-pole, 120 Vac 10 kAIC	Two-pole, 120/240 Vac 10 kAIC
15	#14–10 Cu, #12–10 Al	QBH15	QBH215
20	#14–10 Cu, #12–10 Al	QBH20	QBH220
25	#14–10 Cu, #12–10 Al	QBH25	QBH225
30	#10–2 Cu, #10–1 Al	QBH30	QBH230
40	#10–2 Cu, #10–1 Al	QBH40	QBH240
50	#10–2 Cu, #10–1 Al	QBH50	QBH250
60	#10–2 Cu, #10–1 Al	QBH60	QBH260
70	#10–2 Cu, #10–1 Al	—	QBH270
90	#10–2 Cu, #10–1 Al	—	QBH290
100	#10–2 Cu, #10–1 Al	—	QBH2100
125	#10–1 Cu	—	QBH2125
		Requires one 3/4-inch (19.1 mm) space	Requires two 3/4-inch (19.1 mm) spaces

Type QBH accessories

Table 81. Type QBH classic bolt-on circuit breaker accessories

Description	Catalogue number
Handle tie	QBHT

Plug-in Type BJ two- and three-pole**Type BJ ^a**

- Main circuit breakers for classic Westinghouse NovaLine loadcentres
- 10,000 A interrupting capacity at 120/240 Vac

^a BJ breakers are also approved as branch circuit breakers on CPM/CPL panels 200 A and greater.

Table 82. Type BJ two- and three-pole plug-in classic replacement circuit breakers

Ampere rating	Wire size range Cu/Al 60 °C or 75 °C (AWG)	Catalogue number	
		Two-pole, 120/240 Vac 1 per shelf carton 10 kAIC	Three-pole, 120/240 Vac 1 per shelf carton 10 kAIC
125	#2–300 MCM	BJ2125	BJ3125
150	#2–300 MCM	BJ2150	BJ3150
175	#2–300 MCM	BJ2175	BJ3175
200	#2–300 MCM	BJ2200	BJ3200
		Requires four 1-inch (25.4 mm) spaces ^a	Requires six 1-inch (25.4 mm) spaces ^b

^a When mounted, the Type BJ circuit breakers span both sides of the bus bar occupying an equivalent number of pole spaces on both the left and right side of the loadcentre. For example a two-pole Type BJ circuit breaker occupies 2 pole spaces on the left and the same number of spaces on the right thus requiring four 1-inch spaces.

^b When mounted, the Type BJ circuit breakers span both sides of the bus bar occupying an equivalent number of pole spaces on both the left and right side of the loadcentre. For example a three-pole Type BJ circuit breaker occupies 3 pole spaces on the left and the same number of spaces on the right thus requiring six 1-inch spaces.

Pressure switches

- Ensures smooth delivery of water into your home
- Commercial, residential, or agricultural applications
- Can be used on all types of pumps
- Pressure ratings 20–40 PSI, 30–50 PSI, and 40–60 PSI
- Adjustable cut-in and cut-out pressure
- Easy installation
- CSA certified and UL listed
- Pulsation plug models prevent pump cycling due to water surges
- Low pressure cut-off models prevent pump burn out due to lack of well water (10 PSI below turn on pressure)
- 3-year product warranty



Pressure switch

Product selection

Table 83. Pressure switches

Description	Enclosure style	Catalogue number
20–40 PSI pressure switch	NEMA 1	CHWPS2040D
20–40 PSI pressure switch with pulsation plug	NEMA 1	CHWPS2040DP
20–40 PSI pressure switch with low pressure cut-off	NEMA 1	CHWPS2040DL
30–50 PSI pressure switch	NEMA 1	CHWPS3050D
30–50 PSI pressure switch with low pressure cut-off	NEMA 1	CHWPS3050DL
40–60 PSI pressure switch	NEMA 1	CHWPS4060D

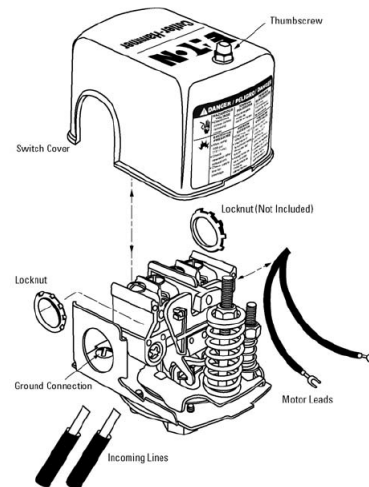

Table 84. Pressure switch ratings

Phase	Voltage (AC)	Amperage	Horsepower
Single	115	20	1.5
Handle tie	230	12	2.0

Table 85. Pressure switch cross-reference

Description	Catalogue number				
	Eaton	Square DT	Flotec ^T	Water Ace ^T	Furnas ^T
20–40 PSI pressure switch	CHWPS2040D	9013FSG2J20	—	15767A510	69WA4Z2040
20–40 PSI pressure switch with pulsation plug	CHWPS2040DP	9013FSG2J20P	—	—	69WA4Z2040B
20–40 PSI pressure switch with low pressure cut-off	CHWPS2040DL	9013FSG2J20M4	—	—	69WEC
30–50 PSI pressure switch	CHWPS3050D	9013FSG2J21	TC2151	15760A501	69WA4
30–50 PSI pressure switch with low pressure cut-off	CHWPS3050DL	9013FSG2J21M4	FP217-1140	19180A501	—
40–60 PSI pressure switch	CHWPS4060D	9013FSG2J24	TC2153	—	69WA4Z4060

Notes:

- CSA is a registered trademark of the Canadian Standards Association
- UL is a federally registered trademark of Underwriters Laboratories Inc.
- NEMA is the registered trademark and service mark of the National Electrical Manufacturers Association
- Square D is a federally registered trademark of Schneider Electric
- Flotec is a registered trademark of Flotec
- Furnas is a registered trademark of Siemens Energy and Automation, Inc.
- Water Ace is a registered trademark of the Pentair Pump Group

Index

1SL150PCO	50	3CBL230CU	40	BAB1010	41	BP27	18
1SL300PCO	50	3CBL242	39	BAB1015	41	BP31	18
1SL500PCO	50	3CBL242CU	40	BAB1015D	41	BP32	18
1SL502	51	3CBM118	37	BAB1020	41	BP41	18
1SL502NV	52	3CBM118CU	38	BAB1020D	41	BP54	18
1SL502NVE	52	3CBM130	37	BAB1025	41	BP3110C	15
1SL502S	51	3CBM130CU	38	BAB1030	41	BQHT-10	24
1SL502VE	52	3CBM142	37	BAB1040	41	BQL-10	44
1SL602	51	3CBM142CU	38	BAB1050	41	BQL15	61
1SL602NV	52	3CBM218	37	BAB1060	41	BQL20	61
1SL602NVE	52	3CBM230	37	BAB1070	41	BQL25	61
1SL602S	51	3CBM230CU	38	BAB2015	41	BQL30	61
1SL602VE	52	3CBM242	37	BAB2020	41	BQL40	61
1SL702	51	3CBSF100	44	BAB2030	41	BQL50	61
1SL702NV	52	3CBSF225	44	BAB2040	41	BQL60	61
1SL702NVE	52	3CCPL103	12	BAB2050	41	BQL215	61
1SL702S	51	3CPL112	12	BAB2060	41	BQL220	61
1SL702VE	52	3CPL112COV	15	BAB2070	41	BQL225	61
2SL150PCO	50	3CPL124	12	BAB2090	41	BQL230	61
2SL300PCO	50	3CPL124COV	15	BAB2100	41	BQL240	61
2SL500PCO	50	3CPL130	12	BAB2125	41	BQL250	61
2SL502	51	3CPL130COV	15	BAB3015H	41	BQL260	61
2SL502NV	52	3CPL136	12	BAB3020H	41	BQL260NA	62
2SL502NVE	52	3CPL136COV	15	BAB3030H	41	BQL270	61
2SL502S	51	3CPL218	12	BAB3040H	41	BQL290	61
2SL502VE	52	3CPL218COV	15	BAB3050H	41	BQL315	61
2SL602	51	3CPL224	12	BAB3060H	41	BQL320	61
2SL602NV	52	3CPL224COV	15	BAB3070H	41	BQL330	61
2SL602NVE	52	3CPL230	12	BAB3090H	41	BQL340	61
2SL602S	51	3CPL230COV	15	BAB3100H	41	BQL350	61
2SL602VE	52	3CPL242	12	BHGW-10	24	BQL360	61
2SL702	51	3CPL242COV	15	BHLW1-10	24	BQL360NA	62
2SL702NV	52	3CPL442	12	BHLW2-10	24	BQL370	61
2SL702NVE	52	3CPM112	8	BHLW-10	24	BQL390	61
2SL702S	51	3CPM112COV	15	BJ2125	64	BQL2100	61
2SL702VE	52	3CPM130	8	BJ2150	64	BQL2125	61
2SL706S	51	3CPM130COV	15	BJ2175	64	BQL2135	61
3BRS225	15	3CPM230	8	BJ2200	64	BQL3100	61
3BRS400	15	3CPM230COV	15	BJ3125	64	BQLT-15	61
3BRSF150	15	3CPM442	8	BJ3150	64	BQLT-15-215	61
3CBL118	39	48INT125B	25	BJ3175	64	BQLT-15-220	61
3CBL118CU	40	52-3125-5	15	BJ3200	64	BQLT-15-225	61
3CBL130	39	52-3125-6	15	BP2	18	BQLT-15-230	61
3CBL130CU	40	816INT125B	25	BP4	18	BQLT-15-240	61
3CBL142	39	1224INT125B	25	BP16	18	BQLT-20	61
3CBL142CU	40	1624INT125B	25	BP18	18	BQLT-30	61
3CBL218	39	2024INT125B	25	BP21	18	BQLT-215-215	61
3CBL230	39	2424INT125B	25	BP23	18	BQLT-215-230	61
				BP24	18	BQLT-215-240	61

BQLT-220-220 61	BR320E 21	BRH150E 21	BRH380E 21
BR115 17	BR325 17	BRH160 17	BRH390 17
BR115AF 19	BR325E 21	BRH160E 21	BRH390E 21
BR115E 21	BR330 17	BRH170 17	BRH2100 17
BR120 17	BR330E 21	BRH170E 21	BRH2100E 21
BR120AF 19	BR335 17	BRH215 17	BRH3100 17
BR120E 21	BR335E 21	BRH215E 21	BRH3100E 21
BR125 17	BR340 17	BRH220 17	BRL215AF 19
BR125E 21	BR340E 21	BRH220E 21	BRL220AF 19
BR130 17	BR345 17	BRH225 17	BRL220AFIT 19
BR130E 21	BR345E 21	BRH225E 21	BRLAFGFLOFF 24
BR135 17	BR350 17	BRH230 17	BRLW1-10 24
BR135E 21	BR350E 21	BRH230E 21	BRLW2-10 24
BR140 17	BR360 17	BRH235 17	BRLW-10 24
BR140E 21	BR360E 21	BRH235E 21	BRQLW-10 24
BR150 17	BR370 17	BRH240 17	BRS225 15
BR150E 21	BR370E 21	BRH240E 21	BRS400 15
BR160 17	BR380 17	BRH245 17	BRSF125 15
BR160E 21	BR380E 21	BRH245E 21	BRSURGE 48
BR170 17	BR390 17	BRH250 17	BR230SUR 48
BR170E 21	BR390E 21	BRH250E 21	BR250SUR 48
BR215 17	BR2100 17	BRH260 17	
BR215E 21	BR2100E 21	BRH260E 21	CBL118 39
BR220 17	BR2100NA 22	BRH270 17	CBL118CU 40
BR220E 21	BR2125 17	BRH270E 21	CBL130 39
BR225 17	BR3100 17	BRH280 17	CBL130CU 40
BR225E 21	BR3100E 21	BRH280E 21	CBL142 39
BR230 17	BRAF115C 19, 41	BRH290 17	CBL142CU 40
BR230E 21	BRAF120C 19	BRH290E 21	CBL218 39
BR235 17	BRCAFLOFF 24	BRH315 17	CBL218CU 40
BR235E 21	BRDL1-10 24, 44	BRH315E 21	CBL230 39
BR240 17	BRF115 19	BRH320 17	CBL230CU 40
BR240E 21	BRFP 15, 44	BRH320E 21	CBL242 39
BR245 17	BRH115 17	BRH325 17	CBL242CU 40
BR245E 21	BRH115CAF 19	BRH325E 21	CBM118 37
BR250 17	BRH115E 21	BRH330 17	CBM118CU 38
BR250E 21	BRH120 17	BRH330E 21	CBM130 37
BR250NA 22	BRH120CAF 19	BRH335 17	CBM130CU 38
BR260 17	BRH120E 21	BRH335E 21	CBM142 37
BR260E 21	BRH125 17	BRH340 17	CBM142CU 38
BR260NA 22	BRH125E 21	BRH340E 21	CBM218 37
BR270 17	BRH130 17	BRH345 17	CBM218CU 38
BR270E 21	BRH130E 21	BRH345E 21	CBM230 37
BR280 17	BRH135 17	BRH350 17	CBM230CU 38
BR280E 21	BRH135E 21	BRH350E 21	CBM242 37
BR290 17	BRH140 17	BRH360 17	CBSF100 44
BR290E 21	BRH140E 21	BRH360E 21	CBSF225 44
BR315 17	BRH145 17	BRH370 17	CC3100 23
BR315E 21	BRH145E 21	BRH370E 21	CC3125 23
BR320 17	BRH150 17	BRH380 17	CC3150 23

CC3200 23	CH310 31	CHP110 32	CHWPS2040DL 65
CCL300 24	CH315 31	CHP115 32	CHWPS2040DP 65
CCPL 24	CH320 31	CHP120 32	CHWPS3050D 65
CCPL102 10	CH325 31	CHP125 32	CHWPS3050DL 65
CCPL104 10	CH330 31	CHP130 32	CHWPS4060D 65
CCPL108 10	CH335 31	CHP135 32	CPL072 14
CH6L125R 30	CH340 31	CHP140 32	CPL072FGP 14
CH9FL 15	CH345 31	CHP145 32	CPL072R 14
CH30SPA 47	CH350 31	CHP150 32	CPL072RGP 14
CH40SPA 47	CH360 31	CHP160 32	CPL072SGP 14
CH50SPA 47	CH370 31	CHP170 32	CPL112WL 10
CH60SPA 47	CH380 31	CHP210 32	CPL112G3 46
CH115AF 33	CH390 31	CHP215 32	CPL112G6 46
CH115AFPN 33	CH3100 31	CHP220 32	CPL116WL 10
CH115EPD 34	CHF115 31	CHP225 32	CPL116W 10
CH115GF 34	CHF120 31	CHP230 32	CPL120WL 10
CH115GFPN 34	CHF125 31	CHP235 32	CPL120G6 46
CH120AF 33	CHF130 31	CHP240 32	CPL130WL 10
CH120AFPN 33	CHF135 31	CHP245 32	CPL130G6 46
CH120EPD 34	CHF140 31	CHP250 32	CPL220WL 10
CH120GF 34	CHF145 31	CHP260 32	CPL240WL 10
CH120GFPN 34	CHF150 31	CHP270 32	CPL400KIT 15
CH125EPD 34	CHF215 31	CHP280 32	CPL442 10
CH125GF 34	CHF220 31	CHP290 32	CPM112WL 6
CH130EPD 34	CHF225 31	CHP310 32	CPM116WL 6
CH160 31	CHF230 31	CHP315 32	CPM116Z 6
CH170 31	CHF235 31	CHP320 32	CPM120WL 6
CH215AF 33	CHF240 31	CHP325 32	CPM120Z 6
CH215EPD 34	CHF245 31	CHP330 32	CPM126GEN 46
CH215GF 34	CHF250 31	CHP335 32	CPM130WL 6
CH220AF 33	CHFAFGFLOFF 36	CHP340 32	CPM130Z 6
CH220EPD 34	CHFGFT130 34	CHP345 32	CPM140WL 6
CH220GF 34	CHFGFT130PN 34	CHP350 32	CPM140Z 6
CH225GF 34	CHFP 36	CHP360 32	CPM216WL 6
CH230EPD 34	CHHT 36	CHP370 32	CPM220WL 6
CH230GF 34	CHLO 36	CHP2100 32	CPM230WL 6
CH230SUR 48	CHM24PN100 30	CHP2110 32	CPM236GEN 46
CH235GF 34	CHM32PN100 30	CHP2125 32	CPM240WL 6
CH240EPD 34	CHM32PN200 30	CHP3100 32	CPM260 6
CH240GF 34	CHM42PN100 30	CHPL 36	CPM342 6
CH245GF 34	CHM42PN200 30	CHPLGF 36	CPM400KIT 15
CH250EPD 34	CHM60PN200L 30	CHRLS 36	CPM442 6
CH250GF 34	CHNL24PN125 30	CHSF2125 36	CPM1520WL 6
CH250SUR 48	CHNL32PN125 30	CHSPALARM 47	CPM1530WL 6
CH260 31	CHNL32PN225 30	CHSPCABLE 49	CPM1540WL 6
CH260EPD 34	CHNL42PN225 30	CHSPFMKIT 49	CQLP8100 59
CH260GF 34	CHNS 36	CHSPT2MICRO 49	CQLP12100 59
CH270 31	CHNT1515 31	CHSPT2ULTRA 49	CSABP4683B 59
CH280 31	CHNT1520 31	CHSPT23PACK 49	CSABP4734B 59
CH290 31	CHNT2020 31	CHWPS2040D 65	CSH2100N 35

CSH2150N 35	GFCBH125 20	P48G11S03P 56	QBG2050 43
CSH2200N 35	GFCBH130 20	P48G11S05CUB 57	QBGFEF1015 43
CSR2125N 23	GFCBH215 20	P48G11S05P 56	QBGFEF1020 43
CSR2150N 23	GFCBH220 20	P48G11S07CUB 57	QBGFEF1025 43
CSR2200N 23	GFCBH225 20	P48G11S07P 56	QBGFEF1030 43
CVRSCRW 15	GFCBH230 20	P48G11S10CUB 57	QBGFEF2015 43
	GFEP115 20	P48G11S10P 56	QBGFEF2020 43
DIRCARD42 44	GFEP120 20	P48G11S15CUB 57	QBGFEF2025 43
DIRSLEEVE 44	GFEP125 20	P48G11S15P 56	QBGFEF2030 43
DNBA1515 42	GFEP130 20	P48G11S25CUB 57	QBH15 63
DNBA2020 42	GFEP215 20	P48G11S25P 56	QBH20 63
DNBA3030 42	GFEP220 20	P48G28T15CUB 57	QBH25 63
DNPL1515 18, 21	GFEP225 20	P48G28T15P 56	QBH30 63
DNPL1520 18, 21	GFEP230 20	P48G28T21CUB 57	QBH40 63
DNPL1530 18	GFEP240 20	P48G28T21P 56	QBH50 63
DNPL2020 18, 21	GFEP250 20	P48G28T30CUB 57	QBH60 63
DNPL151515 18	GFXB115B2 22	P48G28T30P 56	QBH215 63
DNPL152015 18	GFXB120B2 22	P60G11S03CUB 57	QBH220 63
DNPL152515 18	GFXB125B2 22	P60G11S05CUB 57	QBH225 63
DNPL153015 18	GFXB130B2 22	P60G11S05P 56	QBH230 63
DNPL154015 18		P60G11S07CUB 57	QBH240 63
DNPL155015 18	HBQL15 61	P60G11S07P 56	QBH250 63
DNPL215215 18	HBQL20 61	P60G11S10CUB 57	QBH260 63
DNPL215220 18	HBQL25 61	P60G11S10P 56	QBH270 63
DNPL215230 18	HBQL30 61	P60G11S15CUB 57	QBH290 63
DNPL215240 18	HBQL40 61	P60G11S15P 56	QBH2100 63
DNPL220220 18	HBQL50 61	P60G11S25CUB 57	QBH2125 63
DNPL220230 18	HBQL60 61	P60G11S25P 56	QBHAF1015 42
DS075H1 15	HBQL315 61	P60G28T15CUB 57	QBHAF1020 42
DS100H1 15	HBQL330 61	P60G28T15P 56	QBHAF2015 42
DS125H1 15	HBQL350 61	P60G28T21CUB 57	QBHAF2015IT 42
DS150H1 15	HBQL360 61	P60G28T21P 56	QBHAG1020 42
DS200H1 15	HBQL370 61	P60G28T30CUB 57	QBHCAF102 42
DS200H2 15	HBQL390 61	P60G28T30P 56	QBHCAF1015 42
DS250H2 15	HBQL3100 61		QBHGFEP1015 43
DS300H2 15	HLW1-10 24	QBAF1015 42	QBHGFEP1020 43
GFCB115 20		QBAF1020 42	QBHGFEP1025 43
GFCB120 20	ISGRD 15, 44	QBAF2015 42	QBHGFEP1030 43
GFCB125 20		QBAF2015IT 42	QBHGFEP2015 43
GFCB130 20	LCCS 36	QBAG1020 42	QBHGFEP2020 43
GFCB140 20		QBACAF1015 42	QBHGFEP2025 43
GFCB215 20	MCBL300 24	QBACAF1020 42	QBHGFEP2030 43
GFCB220 20	MCBPL 24, 36	QBG1015 43	QBHT 63
GFCB225 20		QBG1020 43	QBHW1015 41
GFCB230 20	NL20 15	QBG1030 43	QBHW1020 41
GFCB240 20	NL30 15	QBG1040 43	QBHW1030 41
GFCB250 20	NL300 15	QBG2015 43	QBHW1040 41
GFCB260 20	NSP42 15	QBG2020 43	QBHW1050 41
GFCBH115 20		QBG2030 43	QBHW1060 41
GFCBH120 20	P48G11S03CUB 57	QBG2040 43	QBHW1070 41

QBHW2015 41	QLPT19D 60	RCPM2GF6H 54
QBHW2020 41	QLPT20AD 60	RCPM2GF10 54
QBHW2030 41	QLPT22AD 60	RCPM108M 53
QBHW2040 41	QLPT24D 60	RCPM112 7
QBHW2050 41	R3CCPL103 13	RCPM120 7
QBHW2060 41	R3CPL112 13	RCPM130 7
QBHW2070 41	R3CPL130 13	RCPM208M 53
QBHW2090 41	R3CPL136 13	RCPM220 7
QBHW2100 41	R3CPL230 13	RCPM230 7
QBHW2125 41	R3CPL242 13	RCPM240 7
QBHW3015 41	R3CPM112 9	RCPM1530 7
QBHW3020 41	R3CPM130 9	RH75P 15
QBHW3030 41	R3CPM230 9	RH100P 15
QBHW3040 41	RCCHL102 30	RH125P 15
QBHW3050 41	RCCPL102 11	SPC61 15
QBHW3060 41	RCCPL104 11	SPCWH 15
QBHW3070 41	RCCPL108 11	
QBHW3090 41	RCPL112 11	
QBHW3100 41	RCPL120 11	TDL 15, 36, 44
QL1NPL 44	RCPL130 11	THOW-10 24
QL23NPL 44	RCPL220 11	THS1 24
QL123PL 44	RCPL240 11	
QLPT16AD 60	RCPM1GF6H 54	
QLPT16D 60	RCPM1GF10 54	

Eaton
1000 Eaton Boulevard
Cleveland, OH 44122
United States
Eaton.com

Canadian Operations
5050 Mainway
Burlington, ON L7L 5Z1
Canada
EatonCanada.ca

© 2017 Eaton
All Rights Reserved
Printed in Canada
Publication No. CA003008EN
December 2017