

Concrete/Masonry Boxes and Accessories

Bars for Hanging Ceiling Boxes

CAT. NO.	LENGTH (IN.)	STD. CTN.
HBB 18	18	40
HBB-24	24	40
HBB-30	30	40



Two bars required for each box.

Concrete Box Covers

CAT. NO.	DESCRIPTION	STD. CTN.
911	Flat — 4" octagon Two 1/2" KOs and two 3/4" KOs with 3/8" fixture stud*	25

Fits any Steel City® concrete box.

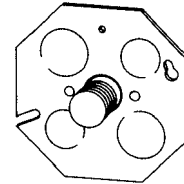

911

Concrete Box Cover Plate

- Thread size: 3/8"-18 NPS

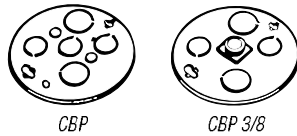

CAT. NO.	DESCRIPTION	STD. CTN.
CBP	No Stud; 3/2" and 2 3/4" KOs	25
CBP 3/8	With 3/8" fixture stud; 2 1/2" and 3/4" KOs	25

Concrete Box Adapter



CBA

CAT. NO.	DESCRIPTION	STD. CTN.
CBA	For quick mounting and alignment of 4" octagon extension ring on concrete box or hung ceiling box	25

4" Octagon Concrete Boxes

CAT. NO.	DEPTH (IN.)	CU. IN. CAPACITY	KNOCKOUTS	STD. CTN.
<i>With Conduit KOs</i>				
54531 1/2 3/4	2	23.0	1/2" & 3/4" single row	25
54541 1/2 3/4	2 1/2	29.0	1/2" & 3/4" single row	25
54551 1/2 & 3/4	3	35.0	1/2" & 3/4" single row	20
54551-3/4 & 1	3	35.0	3/4" & 1" single row	20
54561 1/2	3 1/2	41.0	1/2" double row	20
54561-1/2 & 3/4	3 1/2	41.0	1/2" & 3/4" double row	20
54561-3/4 & 1	3 1/2	41.0	3/4" & 1" double row	20
54571 1/2 3/4	4	47.0	1/2" & 3/4" double row	10
54571-3/4 & 1	4	47.0	3/4" & 1" double row	10
54581 1/2 & 3/4	5	58.0	1/2" & 3/4" double row	10
54591 1/2 & 3/4	6	70.0	1/2" & 3/4" three rows	10

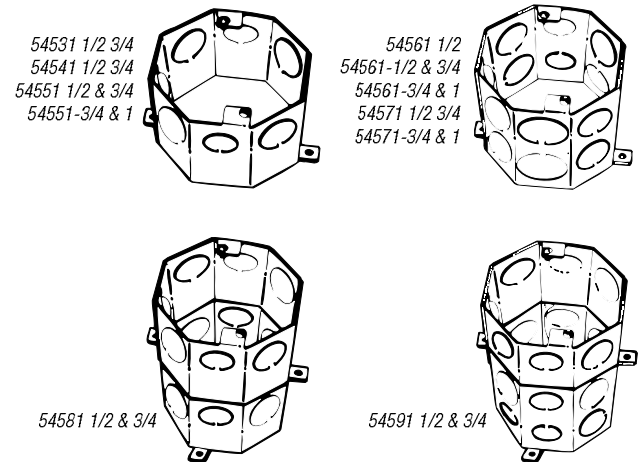

4" Octagon Hanging Ceiling Boxes

CAT. NO.	DEPTH (IN.)	CU. IN. CAPACITY	KNOCKOUTS	STD. CTN.
<i>With Conduit KOs</i>				
H-54561-1/2 & 3/4	3 1/2	41.0	1/2" & 3/4" double row	20
H-54561-3/4	3 1/2	41.0	3/4" double row	20

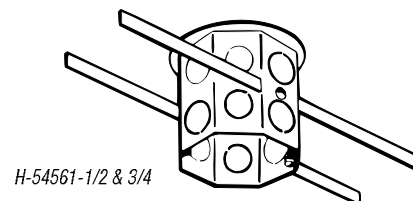

H-54561-1/2 & 3/4

Concrete/Masonry Boxes and Accessories

Gangable Masonry Boxes



ECCENTRIC KNOCKOUTS 1/2" & 3/4"

CAT. NO.	DEPTH (IN.)	HEIGHT (IN.)	LENGTH (IN.)	CU. IN. CAPACITY	EA. SIDE	EA. END	STD. BOTTOM	STD. CTN.
With Eccentric Conduit KOs								
GW 125 G*	2½	3¼	1¼	15.0	2	2	2	20
GW 225 G*	2½	3¼	3¼	31.6	2	4	4	10
GW 325 G*	2½	3¼	5¼	47.4	2	6	6	5
GW 425 G	2½	3¼	7¼	64.0	2	8	8	5
GW 525 G	2½	3¼	9¼	79.0	2	10	10	5
GW-625-G*	2½	3¼	11	94.8	2	12	12	1
GW 135 G*	3½	3¼	1¼	22.0	4	2	2	20
GW 235 G*	3½	3¼	3¼	46.9	4	4	4	10
GW 335 G	3½	3¼	5¼	71.0	4	6	6	10
GW 435 G*	3½	3¼	7¼	93.5	4	8	8	5
GW-535-G	3½	3¼	9¼	111.7	4	10	10	5
GW-635-G	3½	3¼	11	134.0	4	12	12	1

* Per NEC®, suitable for use without a bonding jumper in circuits above or below 250 volts.

† 4-, 5- and 6-gang supplied with partitions.

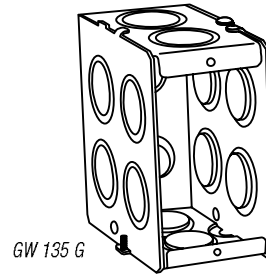

GW 135 G

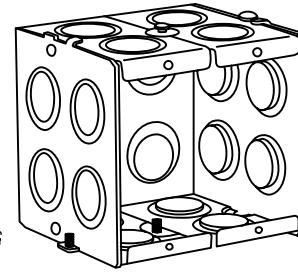

GW 235 G

Masonry Box Partitions



CAT. NO.	DESCRIPTION	STD. CTN.
PGW-25-G	Non-metallic partition for 2½"-deep steel tile wall boxes	25
PGW-35-G	Non-metallic partition for 3½"-deep steel tile wall boxes	25



PGW-25-G

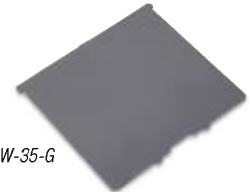

PGW-35-G

Shallow Masonry Boxes

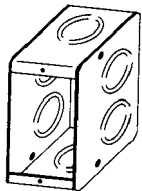

1-MBS

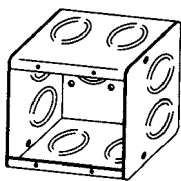

2-MBS

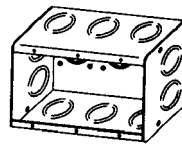

3-MBS

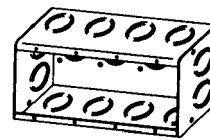

4-MBS

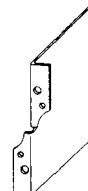

MBPS

CAT. NO.	DEPTH (IN.)	CU. IN. CAPACITY	DESCRIPTION	STD. CTN.
1-MBS	2½	16.5	A one-gang masonry box, 2½" deep x 3¼" long x 1¼" wide Six ½" and two ¾" concentric KOs. Two in each side and one in each end. Uses Steel City® 100 cover	10
2-MBS	2½	33.0	A two-gang masonry box, 2½" deep x 3¼" long x 3¼" wide Eight ½" and two ¾" concentric KOs. Two in each side and two in each end. Uses Steel City® SB-2 cover	10
3-MBS	2½	49.0	A three-gang masonry box, 2½" deep x 3¼" long x 5½" wide Ten ½" and ¾" concentric KOs. Three in each side and two in each end. Uses Steel City® SB-3 cover	5
4-MBS	2½	67.0	A four-gang masonry box, 2½" deep x 3¼" long x 7¾" wide Twelve ½" and ¾" concentric KOs. Four in each side and two in each end. Uses Steel City® SB-4 cover	5
MBPS	2½	—	Masonry Box Partition, 2½" deep x 3¼" wide A low-voltage partition drilled and tapped for mounting. Furnished with two 8/32 screws. For use with 2-MBS, 3-MBS or 4-MBS boxes	50

Concrete/Masonry Boxes and Accessories

Deep Masonry Boxes

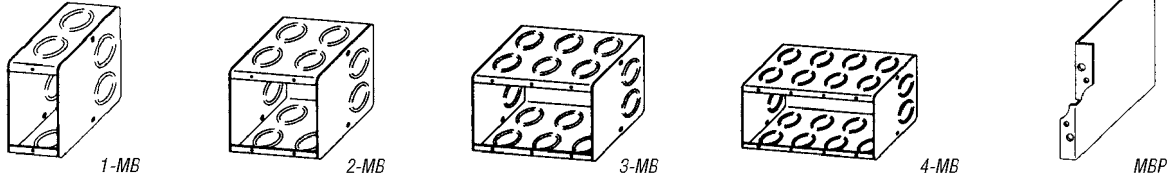

CAT. NO.	DEPTH (IN.)	CU. IN. CAPACITY	DESCRIPTION	STD. CTN.
1-MB	3½	23.3	One-Gang Masonry Box, 3½" deep x 3¼" long x 1½" wide Eight ½" and ¾" concentric KOs. Two in each side and two in each end. Uses Steel City® 100 series covers	10
2-MB	3½	46.8	Two-Gang Masonry Box, 3½" deep x 3¼" long x 3¼" wide Twelve ½" and ¾" concentric KOs. Four in each of two sides and two in each end. Uses Steel City® SB-2 cover	10
3-MB	3½	69.5	Three-Gang Box, 3½" deep x 3¼" long x 5½" wide Sixteen ½" and ¾" concentric KOs. Six in each of two sides and two in each end. Uses Steel City® SB-3 cover	5
4-MB	3½	92.0	Four-Gang Masonry Box, 3½" deep x 3¼" long x 7½" wide Twenty ½" and ¾" concentric KOs. Eight in each of two sides and two in each end. Uses Steel City® SB-4 cover	5
MBP	3½	—	Masonry Box Partition, 3½" deep x 3¼" wide A low-voltage partition drilled and tapped for mounting. Furnished with two 8/32 screws. For use with 2-MB, 3-MB or 4-MB boxes	50

1" KO Masonry Box

CAT. NO.	LENGTH (IN.)	CU. IN. CAPACITY	1" KNOCKOUTS			STD. CTN.
			EA. SIDE	EA. END	BOTTOM	
<i>Non-Gangable Single Gang</i>						
GW 135 NG-1	1½	22	2	1	2	10

GW 135 NG-1



Thru-Wall Boxes for Concrete Block

CAT. NO.	WIDTH (IN.)	HEIGHT (IN.)	DEPTH (IN.)	CU. IN. CAPACITY	KNOCKOUTS (IN.)		STD. CTN.
					EA. SIDE CONDUIT	EA. END CONDUIT	
<i>With Concentric Conduit KOs</i>							
CBTW 4	2½	3½	3½	24.0	(2) ½-¾	(1) ½-¾	10
CBTW 6	2½	3½	5½	38.0	(4) ½-¾	(2) ½-¾	10
CBTW 8	2½	3½	7½	52.3	(6) ½-¾	(3) ½-¾	10

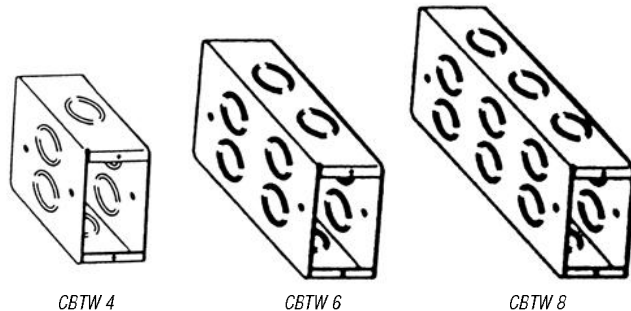

Welded Thru Boxes

CAT. NO.	CU. IN. CAPACITY	DESCRIPTION	STD. CTN.
4-DWS	25.5	3½" deep x 4" long x 2½" wide One ½" KO and one ¾" KO both on top, one ½" KO bottom side and one ½" KO on side opposite two flat brackets*	25

*Uses Steel City® and 100 series covers.

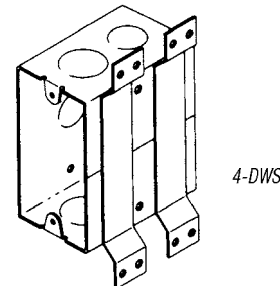

Concrete/Masonry Boxes and Accessories

Bars for Hanging Ceiling Boxes

CAT. NO.	LENGTH (IN.)	STD. CTN.
HBB 18	18	40
HBB-24	24	40
HBB-30	30	40



Two bars required for each box.

Concrete Box Covers

CAT. NO.	DESCRIPTION	STD. CTN.
911	Flat — 4" octagon Two 1/2" KOs and two 3/4" KOs with 3/8" fixture stud*	25

Fits any Steel City® concrete box.

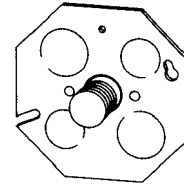

911

Concrete Box Cover Plate

- Thread size: 3/8"-18 NPS

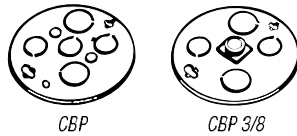

CBP

CBP 3/8

CAT. NO.	DESCRIPTION	STD. CTN.
CBP	No Stud; 3/2" and 2 3/4" KOs	25
CBP 3/8	With 3/8" fixture stud; 2 1/2" and 3/4" KOs	25

Concrete Box Adapter



CBA

CAT. NO.	DESCRIPTION	STD. CTN.
CBA	For quick mounting and alignment of 4" octagon extension ring on concrete box or hung ceiling box	25

4" Octagon Concrete Boxes

CAT. NO.	DEPTH (IN.)	CU. IN. CAPACITY	KNOCKOUTS	STD. CTN.
<i>With Conduit KOs</i>				
54531 1/2 3/4	2	23.0	1/2" & 3/4" single row	25
54541 1/2 3/4	2 1/2	29.0	1/2" & 3/4" single row	25
54551 1/2 & 3/4	3	35.0	1/2" & 3/4" single row	20
54551-3/4 & 1	3	35.0	3/4" & 1" single row	20
54561 1/2	3 1/2	41.0	1/2" double row	20
54561-1/2 & 3/4	3 1/2	41.0	1/2" & 3/4" double row	20
54561-3/4 & 1	3 1/2	41.0	3/4" & 1" double row	20
54571 1/2 3/4	4	47.0	1/2" & 3/4" double row	10
54571-3/4 & 1	4	47.0	3/4" & 1" double row	10
54581 1/2 & 3/4	5	58.0	1/2" & 3/4" double row	10
54591 1/2 & 3/4	6	70.0	1/2" & 3/4" three rows	10

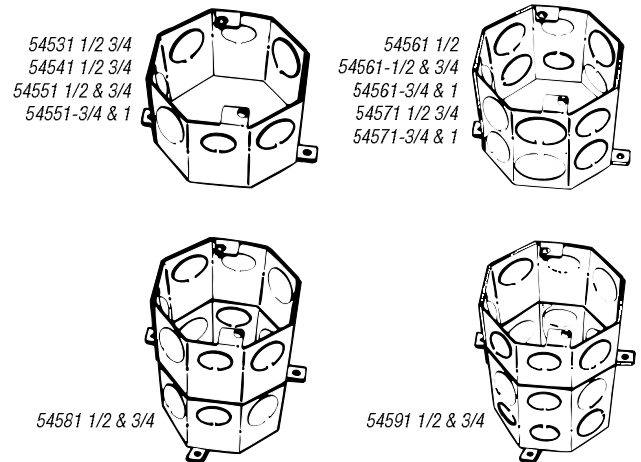

4" Octagon Hanging Ceiling Boxes

CAT. NO.	DEPTH (IN.)	CU. IN. CAPACITY	KNOCKOUTS	STD. CTN.
<i>With Conduit KOs</i>				
H-54561-1/2 & 3/4	3 1/2	41.0	1/2" & 3/4" double row	20
H-54561-3/4	3 1/2	41.0	3/4" double row	20

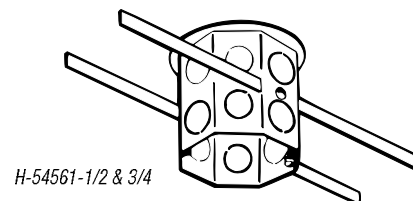

H-54561-1/2 & 3/4

Concrete/Masonry Boxes and Accessories

Gangable Masonry Boxes



ECCENTRIC KNOCKOUTS 1/2" & 3/4"

CAT. NO.	DEPTH (IN.)	HEIGHT (IN.)	LENGTH (IN.)	CU. IN. CAPACITY	EA. SIDE	EA. END	STD. BOTTOM	CTN.
With Eccentric Conduit KOs								
GW 125 G*	2½	3¼	1¼	15.0	2	2	2	20
GW 225 G*	2½	3¼	3¼	31.6	2	4	4	10
GW 325 G*	2½	3¼	5¼	47.4	2	6	6	5
GW 425 G	2½	3¼	7¼	64.0	2	8	8	5
GW 525 G	2½	3¼	9¼	79.0	2	10	10	5
GW-625-G*	2½	3¼	11	94.8	2	12	12	1
GW 135 G*	3½	3¼	1¼	22.0	4	2	2	20
GW 235 G*	3½	3¼	3¼	46.9	4	4	4	10
GW 335 G	3½	3¼	5¼	71.0	4	6	6	10
GW 435 G*	3½	3¼	7¼	93.5	4	8	8	5
GW-535-G	3½	3¼	9¼	111.7	4	10	10	5
GW-635-G	3½	3¼	11	134.0	4	12	12	1

* Per NEC®, suitable for use without a bonding jumper in circuits above or below 250 volts.

† 4-, 5- and 6-gang supplied with partitions.

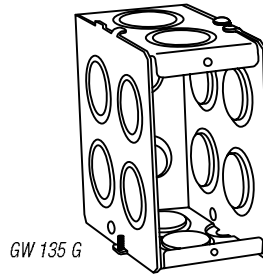

GW 135 G

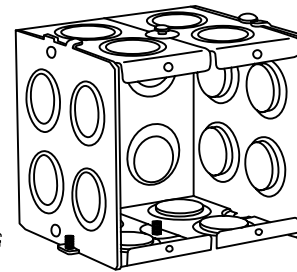

GW 235 G

Masonry Box Partitions



CAT. NO.	DESCRIPTION	STD. CTN.
PGW-25-G	Non-metallic partition for 2½"-deep steel tile wall boxes	25
PGW-35-G	Non-metallic partition for 3½"-deep steel tile wall boxes	25



PGW-25-G

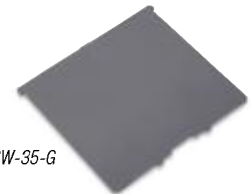

PGW-35-G

Shallow Masonry Boxes

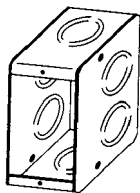

1-MBS

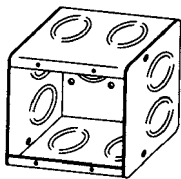

2-MBS

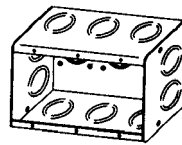

3-MBS

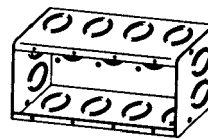

4-MBS

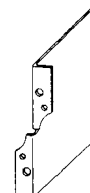

MBPS

CAT. NO.	DEPTH (IN.)	CU. IN. CAPACITY	DESCRIPTION	STD. CTN.
1-MBS	2½	16.5	A one-gang masonry box, 2½" deep x 3¼" long x 1¼" wide Six ½" and two ¾" concentric KOs. Two in each side and one in each end. Uses Steel City® 100 cover	10
2-MBS	2½	33.0	A two-gang masonry box, 2½" deep x 3¼" long x 3¼" wide Eight ½" and two ¾" concentric KOs. Two in each side and two in each end. Uses Steel City® SB-2 cover	10
3-MBS	2½	49.0	A three-gang masonry box, 2½" deep x 3¼" long x 5½" wide Ten ½" and ¾" concentric KOs. Three in each side and two in each end. Uses Steel City® SB-3 cover	5
4-MBS	2½	67.0	A four-gang masonry box, 2½" deep x 3¼" long x 7¾" wide Twelve ½" and ¾" concentric KOs. Four in each side and two in each end. Uses Steel City® SB-4 cover	5
MBPS	2½	—	Masonry Box Partition, 2½" deep x 3¼" wide A low-voltage partition drilled and tapped for mounting. Furnished with two 8/32 screws. For use with 2-MBS, 3-MBS or 4-MBS boxes	50

Concrete/Masonry Boxes and Accessories

Deep Masonry Boxes

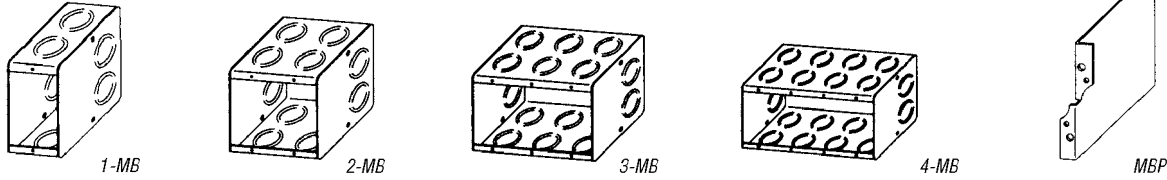

CAT. NO.	DEPTH (IN.)	CU. IN. CAPACITY	DESCRIPTION	STD. CTN.
1-MB	3½	23.3	One-Gang Masonry Box, 3½" deep x 3¼" long x 1½" wide Eight ½" and ¾" concentric KOs. Two in each side and two in each end. Uses Steel City® 100 series covers	10
2-MB	3½	46.8	Two-Gang Masonry Box, 3½" deep x 3¼" long x 3¼" wide Twelve ½" and ¾" concentric KOs. Four in each of two sides and two in each end. Uses Steel City® SB-2 cover	10
3-MB	3½	69.5	Three-Gang Box, 3½" deep x 3¼" long x 5½" wide Sixteen ½" and ¾" concentric KOs. Six in each of two sides and two in each end. Uses Steel City® SB-3 cover	5
4-MB	3½	92.0	Four-Gang Masonry Box, 3½" deep x 3¼" long x 7½" wide Twenty ½" and ¾" concentric KOs. Eight in each of two sides and two in each end. Uses Steel City® SB-4 cover	5
MBP	3½	—	Masonry Box Partition, 3½" deep x 3¼" wide A low-voltage partition drilled and tapped for mounting. Furnished with two 8/32 screws. For use with 2-MB, 3-MB or 4-MB boxes	50

1" KO Masonry Box

CAT. NO.	LENGTH (IN.)	CU. IN. CAPACITY	1" KNOCKOUTS			STD. CTN.
			EA. SIDE	EA. END	BOTTOM	
<i>Non-Gangable Single Gang</i>						
GW 135 NG-1	1½	22	2	1	2	10

GW 135 NG-1



Thru-Wall Boxes for Concrete Block

CAT. NO.	WIDTH (IN.)	HEIGHT (IN.)	DEPTH (IN.)	CU. IN. CAPACITY	KNOCKOUTS (IN.)		STD. CTN.
					EA. SIDE CONDUIT	EA. END CONDUIT	
<i>With Concentric Conduit KOs</i>							
CBTW 4	2½	3½	3½	24.0	(2) ½-¾	(1) ½-¾	10
CBTW 6	2½	3½	5½	38.0	(4) ½-¾	(2) ½-¾	10
CBTW 8	2½	3½	7½	52.3	(6) ½-¾	(3) ½-¾	10

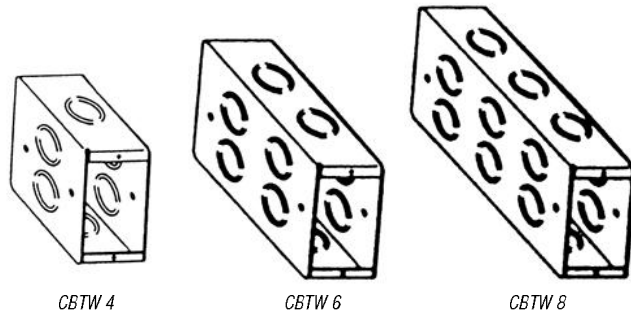

Welded Thru Boxes

CAT. NO.	CU. IN. CAPACITY	DESCRIPTION	STD. CTN.
4-DWS	25.5	3½" deep x 4" long x 2½" wide One ½" KO and one ¾" KO both on top, one ½" KO bottom side and one ½" KO on side opposite two flat brackets*	25

*Uses Steel City® and 100 series covers.

