

|             |  |           |  |      |  |
|-------------|--|-----------|--|------|--|
| Project     |  | Catalog # |  | Type |  |
| Prepared by |  | Notes     |  | Date |  |



# HALO

## BLD4 Series

4" Backlit LED Downlight  
90 CRI

### Typical Applications

Residential

### Interactive Menu

- Order Information [page 2](#)
- Product Specifications [page 2](#)
- Photometric Data [page 4](#)
- Energy & Performance Data [page 3](#)
- Product Warranty

### Product Certification



Refer to ENERGY STAR® Certified Products List.  
Can be used to comply with California Title 24 High Efficacy requirements.  
Certified to California Appliance Efficiency Database under J48.

### Product Features



### Top Product Features

- Backlit LED technology, with no housing
- Easy Install: Mounts to most junction boxes (including pancake boxes)
- Alternate Install: Mount to most recessed housings (hardware included)
- Adjustable white tuning, from 2700K–5000K
- Dimmable down to 5%

### Dimensional and Mounting Details

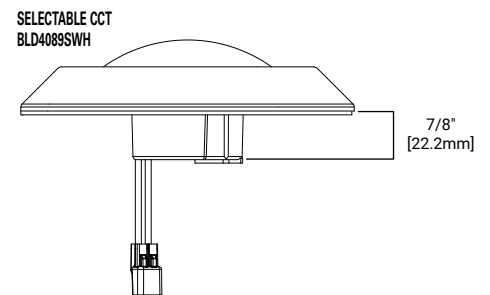
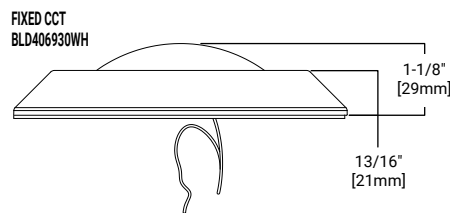
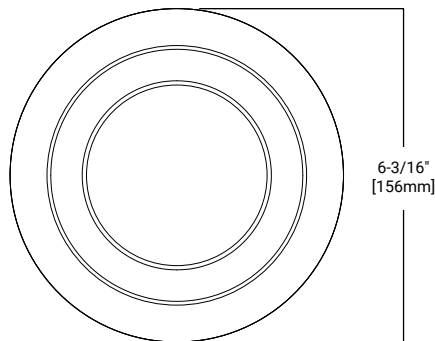

## Order Information

SAMPLE NUMBER: **BLD406930WH** = 4" Backlit LED Downlight, 90CRI, 3000K

| Models                          | Lumens                    | CRI/CCT                | Finish           | Voltage      | Packaging    |
|---------------------------------|---------------------------|------------------------|------------------|--------------|--------------|
| BLD4 = 4" Backlit LED Downlight | 06 = 600 lumens (nominal) | 930 = 90CRI, 3000K CCT | WH = Matte White | Blank = 120V | R = Recycled |

SAMPLE NUMBER: **BLD406930WH** = 4" Backlit LED Downlight, 90CRI, 3000K

| Models                          | Lumens                    | CRI/CCT   | Finish           | Voltage      | Packaging    |
|---------------------------------|---------------------------|---|------------------|--------------|--------------|
| BLD4 = 4" Backlit LED Downlight | 08 = 600 lumens (nominal) | 9S = 90 CRI, SeleCCTable 2700K, 3000K, 3500K, 4000K & 5000K | WH = Matte White | Blank = 120V | R = Recycled |

\*For T20 California product, apply "-CA" to the catalog number (i.e. BLD406930WH-CA)

## Housing Compatibility

The BLD4 is UL Certified in for use with **any** 4 inch diameter recessed housing constructed of steel or aluminum with an internal volume that exceeds 62.3 in<sup>3</sup> in addition to those noted below:

### Housing Compatibility

#### Compatible Halo LED Housings with LED luminaire connector (high-efficacy compliant)

H995ICAT = 4" IC, airtight shallow new construction housing, LED, 120 - 277V  
 H995RICAT = 4" IC, airtight shallow remodeler housing, LED, 120 - 277V  
 H245ICAT = 4" IC, airtight ultra-shallow new construction housing, LED, 120 - 277V  
 H245RICAT = 4" IC, airtight ultra-shallow remodeler housing, LED, 120 - 277V

### Housing Compatibility

#### Compatible Halo Incandescent E26 Screwbase Housings

H99ICAT = 4" IC, airtight shallow new construction housing, E26, 120V  
 H99TAT = 4" non-IC, airtight shallow new construction housing, E26, 120V  
 H99RTAT = 4" Non-Insulated Ceiling Shallow Remodel Housing, 120V  
 E4ICATSB = 4" non-IC, airtight shallow new construction housing, adjustable socket bracket, E26, 120V  
 E4TATSB = 4" non-IC, airtight shallow new construction housing, adjustable socket bracket, E26, 120V  
 E4RTATSB = 4" non-IC, airtight shallow remodeler housing, adjustable socket bracket, E26, 120V

## Product Specifications

### Construction

- Stamped aluminum housing and frame

### Optics

- Precision engineered optic provides uniform luminance from a low profile convex lens

### LED

- Backlit LED technology
- Color Temperature options include: standard 3000K dedicated or SeleCCTable configuration including 2700K, 3000K, 3500K, 4000K and 5000K options
- 90 CRI is standard
- L70 at 50,000 hours projected in accordance with TM-21

### Driver

- Integral 120V 60Hz constant current driver provides virtually noise free operation
- Continuous, flicker-free dimming from 100% to 5% with select leading or trailing edge 120V phase cut dimmers. See dimming guide.
- Dimming to 5% is best assured using dimmers with low end trim adjustment. Consult dimmer manufacturer for compatibility and conditions of use. (Note some dimmers require a neutral in the wallbox.)
- Inline electrical quick connect and E26 adapter (provided) provides mains connections

### Electrical Junction Box Mounting

- BLD may be used in compatible electrical junction boxes in direct contact with insulation including spray foam insulation
- Suitable for installation in many 3-1/2" and 4" octagon and round electrical junction boxes.
- Dedicated CCT SKUs are compatible with compact (pancake) junction boxes
- Selectable CCT configuration, driver consumes 3 cubic inches of junction box, selectable CCT configuration is not compatible with pancake junction boxes
- Installer must ensure compatibility of fit, wiring and proper mounting in the electrical junction box. This includes all applicable national and local electrical and building coded Recessed Housing Mounting
- Can be installed in industry standard 4-inch recessed housings using friction mounting springs and (E26) medium base adapter provided.
- Not for use in recessed housings in direct contact with spray foam insulation refer to NEMA LSD 57-2013

### Warranty

- Five year limited warranty, consult website for details. [www.eaton.com/lighting/legal](http://www.eaton.com/lighting/legal)

### Compliance

- cULus certified for use with Halo housings and other's housings, see instruction sheet for conditions of acceptability.
- Wet and Damp Location listed, airtight per ASTM-E283 (protected ceiling only)
- Suitable for use in clothes closets when installed in accordance with the NEC 410.16 spacing requirements.
- EMI/RFI emissions per FCC 47CFR Part 15B
- Contains no mercury or lead and RoHS compliant.
- Photometric testing in accordance with IES LM-79-08
- Lumen maintenance projections in accordance with IES LM-80-08 and TM-21-11
- Can be used for State of California Title 24 high efficacy luminaire compliance, reference the California Energy Commission Title 20 Appliance Efficiency Database for current listings
- Can be used for International Energy Conservation Coe (IECC) and Washington State Energy Code high efficiency luminaire Compliance
- ENERGY STAR® Certified luminaire - consult ENERGY STAR® Certified Product List

## Energy Data

| 3000K - dedicated |             |
|-------------------|-------------|
| Lumens            | 690         |
| Wattage           | 8.2W        |
| Input current     | 0.07        |
| Efficacy          | 84.1 LPW    |
| THD               | 15.1%       |
| Frequency         | 60 Hz       |
| T Ambient         | -30 - +40°C |
| Voltage           | 120V        |
| Sound Rating      | Class A     |
| Power Factor      | 0.99        |

| SeleCCTable 2700K - 5000K |             |
|---------------------------|-------------|
| Lumens                    | 802         |
| Wattage                   | 10.3W       |
| Input current             | 0.087       |
| Efficacy                  | 77.9 LPW    |
| THD                       | 11.9%       |
| Frequency                 | 60 Hz       |
| T Ambient                 | -30 - +40°C |
| Voltage                   | 120V        |
| Sound Rating              | Class A     |
| Power Factor              | 0.99        |

### COMPATIBLE WITH EATON'S CROUSE-HINDS JUNCTION BOXES

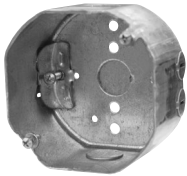

**TP316**  
for non-metallic cable  
4" x 4" x 2-1/8"  
(102mm x 102mm x 54mm)



**TP317**  
for metal clad cable  
4" x 4" x 2-1/8"  
(102mm x 102mm x 54mm)

- **TP316** - for non-metallic cable
- **TP317** - for metal clad cable
- UL Listed
- Refer to [www.crouse-hinds.com](http://www.crouse-hinds.com)

### COMPATIBLE WITH MANY OTHER JUNCTION BOXES\*



**4" octagon light fixture/fan steel box**  
4" x 4" x 2-1/8"  
(102mm x 102mm x 54mm)



**4" octagon steel box**  
4" x 4" x 1-1/2"  
(102mm x 102mm x 38mm)



**4" round new work non-metallic box with hanger bar assembly**  
4" diameter x 2-3/16" (102mm x 56mm)



**4" round new work non-metallic light fixture/fan box**  
4" diameter x 2-3/16"  
(102mm x 56mm)



**3-1/2" round new work non-metallic ceiling box**  
3-1/2" diameter x 2-3/4"  
(89mm x 70mm)



**3-1/2" round old work non-metallic box**  
4-1/4" O.D. flange, 3-1/2" I.D. x 2-5/8"  
(108mm O.D., 89mm I.D. x 67mm)



**4" round surface mount box**  
4" diameter x 1-1/2"  
(102mm x 38mm)



**Round ceiling pan**  
4" diameter x 13/16"  
(102mm x 21mm)  
Note: only compatible with fixed CCT BLD406930

\*This is a representative list of compatible junction boxes only. Information contained in this literature about other manufacturers' products is from published information made available by the manufacturer and is deemed to be reliable, but has not been verified. Eaton makes no specific recommendation on product selection and there are no warranties of performance or compatibility implied. Installer must determine that site conditions are suitable to allow proper installation of the mounting bracket in the box.

## Photometric Data

| BLD406930WH           |          |          |
|-----------------------|----------|----------|
| Luminaire lumens      | 690      |          |
| Input watts           | 8.2      |          |
| LER (LPW)             | 84.1     |          |
| Spacing Criteria      | 0-180    | 1.26     |
|                       | 90-270   | 1.26     |
|                       | Diagonal | 1.38     |
| Beam angle (degrees)  | 114.4    |          |
| Field angle (degrees) | 178.6    |          |
| Max. Candela          | 222      |          |
| Zonal lumen           | Lumens   | % Lumens |
| 0-30                  | 172      | 24.9%    |
| 0-40                  | 282      | 40.8%    |
| 0-60                  | 502      | 72.7%    |
| 0-90                  | 690      | 100.00%  |

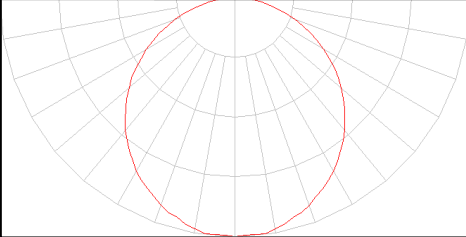

| BLD4089SWH            |          |          |
|-----------------------|----------|----------|
| Luminaire lumens      | 802      |          |
| Input watts           | 10.3     |          |
| LER (LPW)             | 77.9     |          |
| Spacing Criteria      | 0-180    | 1.28     |
|                       | 90-270   | 1.28     |
|                       | Diagonal | 1.4      |
| Beam angle (degrees)  | 116.8    |          |
| Field angle (degrees) | 180      |          |
| Max. Candela          | 250      |          |
| Zonal lumen           | Lumens   | % Lumens |
| 0-30                  | 195      | 24.3%    |
| 0-40                  | 321      | 40.0%    |
| 0-60                  | 576      | 71.8%    |
| 0-90                  | 802      | 100.00%  |

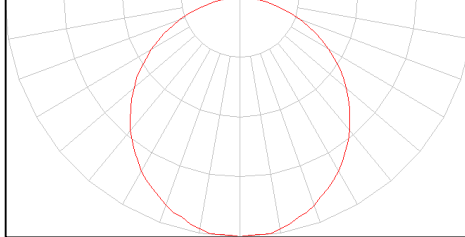

## Color Metric Summary

|          | BLD406930WH | BLD4089SWH |
|----------|-------------|------------|
| TM-30-15 | Rf = 91     | Rf = 91.8  |
|          | Rg = 101.1  | Rg = 101.3 |
| CRI/CIE  | Ra = 93     | Ra = 93    |
|          | R9 = 75     | R9 = 70    |

CCT - Range of 2700K- 5000K



| Foot-candle Values at Nadir<br>0 degree Aiming Angle |                  |          |                 |          |
|--|------------------|----------|-----------------|----------|
| DD (FT)  | BLD406930WH (FC) | DIA (FT) | BLD4089SWH (FC) | DIA (FT) |
| 5.5  | 7.3              | 6.8      | 8.2             | 6.8      |
| 7  | 4.5              | 8.6      | 5.1             | 8.8      |
| 8  | 3.5              | 10       | 3.9             | 10       |
| 9  | 2.7              | 11.2     | 3.1             | 11.4     |
| 10   | 2.2              | 12.4     | 2.5             | 12.6     |
| 12   | 1.5              | 15       | 1.7             | 15.2     |

DD = distance down to illuminated work plane  
FC = initial foot-candles at nadir  
DIA = diameter

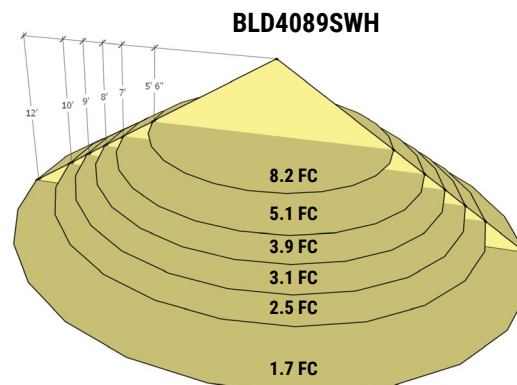
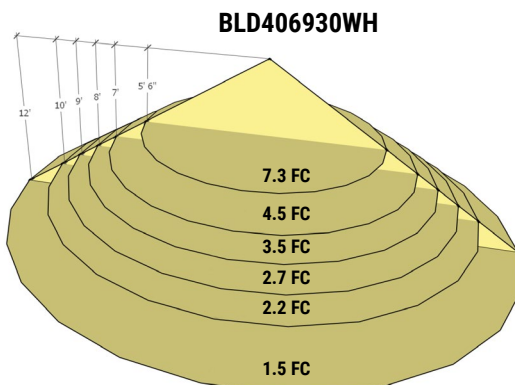

|             |  |           |  |      |  |
|-------------|--|-----------|--|------|--|
| Project     |  | Catalog # |  | Type |  |
| Prepared by |  | Notes     |  | Date |  |



# HALO

## BLD4 Series

4" Backlit LED Downlight  
90 CRI

### Typical Applications

Residential

### Interactive Menu

- Order Information [page 2](#)
- Product Specifications [page 2](#)
- Photometric Data [page 4](#)
- Energy & Performance Data [page 3](#)
- Product Warranty

### Product Certification



Refer to ENERGY STAR® Certified Products List.  
Can be used to comply with California Title 24 High Efficacy requirements.  
Certified to California Appliance Efficiency Database under J48.

### Product Features



### Top Product Features

- Backlit LED technology, with no housing
- Easy Install: Mounts to most junction boxes (including pancake boxes)
- Alternate Install: Mount to most recessed housings (hardware included)
- Adjustable white tuning, from 2700K–5000K
- Dimmable down to 5%

### Dimensional and Mounting Details

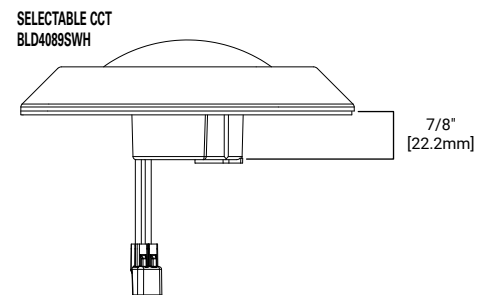
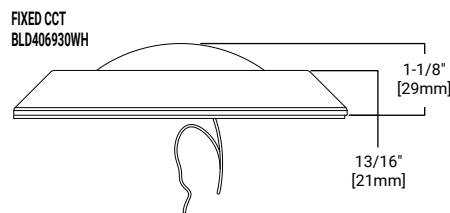
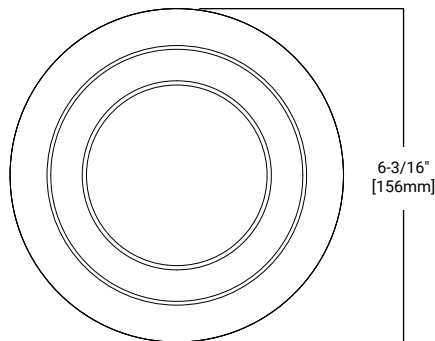

## Order Information

SAMPLE NUMBER: **BLD406930WH** = 4" Backlit LED Downlight, 90CRI, 3000K

| Models                          | Lumens                    | CRI/CCT                | Finish           | Voltage      | Packaging    |
|---------------------------------|---------------------------|------------------------|------------------|--------------|--------------|
| BLD4 = 4" Backlit LED Downlight | 06 = 600 lumens (nominal) | 930 = 90CRI, 3000K CCT | WH = Matte White | Blank = 120V | R = Recycled |

SAMPLE NUMBER: **BLD406930WH** = 4" Backlit LED Downlight, 90CRI, 3000K

| Models                          | Lumens                    | CRI/CCT   | Finish           | Voltage      | Packaging    |
|---------------------------------|---------------------------|---|------------------|--------------|--------------|
| BLD4 = 4" Backlit LED Downlight | 08 = 600 lumens (nominal) | 9S = 90 CRI, SeleCCTable 2700K, 3000K, 3500K, 4000K & 5000K | WH = Matte White | Blank = 120V | R = Recycled |

\*For T20 California product, apply "-CA" to the catalog number (i.e. BLD406930WH-CA)

## Housing Compatibility

The BLD4 is UL Certified in for use with **any** 4 inch diameter recessed housing constructed of steel or aluminum with an internal volume that exceeds 62.3 in<sup>3</sup> in addition to those noted below:

### Housing Compatibility

#### Compatible Halo LED Housings with LED luminaire connector (high-efficacy compliant)

H995ICAT = 4" IC, airtight shallow new construction housing, LED, 120 - 277V  
 H995RICAT = 4" IC, airtight shallow remodeler housing, LED, 120 - 277V  
 H245ICAT = 4" IC, airtight ultra-shallow new construction housing, LED, 120 - 277V  
 H245RICAT = 4" IC, airtight ultra-shallow remodeler housing, LED, 120 - 277V

### Housing Compatibility

#### Compatible Halo Incandescent E26 Screwbase Housings

H99ICAT = 4" IC, airtight shallow new construction housing, E26, 120V  
 H99TAT = 4" non-IC, airtight shallow new construction housing, E26, 120V  
 H99RTAT = 4" Non-Insulated Ceiling Shallow Remodel Housing, 120V  
 E4ICATSB = 4" non-IC, airtight shallow new construction housing, adjustable socket bracket, E26, 120V  
 E4TATSB = 4" non-IC, airtight shallow new construction housing, adjustable socket bracket, E26, 120V  
 E4RTATSB = 4" non-IC, airtight shallow remodeler housing, adjustable socket bracket, E26, 120V

## Product Specifications

### Construction

- Stamped aluminum housing and frame

### Optics

- Precision engineered optic provides uniform luminance from a low profile convex lens

### LED

- Backlit LED technology
- Color Temperature options include: standard 3000K dedicated or SeleCCTable configuration including 2700K, 3000K, 3500K, 4000K and 5000K options
- 90 CRI is standard
- L70 at 50,000 hours projected in accordance with TM-21

### Driver

- Integral 120V 60Hz constant current driver provides virtually noise free operation
- Continuous, flicker-free dimming from 100% to 5% with select leading or trailing edge 120V phase cut dimmers. See dimming guide.
- Dimming to 5% is best assured using dimmers with low end trim adjustment. Consult dimmer manufacturer for compatibility and conditions of use. (Note some dimmers require a neutral in the wallbox.)
- Inline electrical quick connect and E26 adapter (provided) provides mains connections

### Electrical Junction Box Mounting

- BLD may be used in compatible electrical junction boxes in direct contact with insulation including spray foam insulation
- Suitable for installation in many 3-1/2" and 4" octagon and round electrical junction boxes.
- Dedicated CCT SKUs are compatible with compact (pancake) junction boxes
- Selectable CCT configuration, driver consumes 3 cubic inches of junction box, selectable CCT configuration is not compatible with pancake junction boxes
- Installer must ensure compatibility of fit, wiring and proper mounting in the electrical junction box. This includes all applicable national and local electrical and building coded Recessed Housing Mounting
- Can be installed in industry standard 4-inch recessed housings using friction mounting springs and (E26) medium base adapter provided.
- Not for use in recessed housings in direct contact with spray foam insulation refer to NEMA LSD 57-2013

### Warranty

- Five year limited warranty, consult website for details. [www.eaton.com/lighting/legal](http://www.eaton.com/lighting/legal)

### Compliance

- cULus certified for use with Halo housings and other's housings, see instruction sheet for conditions of acceptability.
- Wet and Damp Location listed, airtight per ASTM-E283 (protected ceiling only)
- Suitable for use in clothes closets when installed in accordance with the NEC 410.16 spacing requirements.
- EMI/RFI emissions per FCC 47CFR Part 15B
- Contains no mercury or lead and RoHS compliant.
- Photometric testing in accordance with IES LM-79-08
- Lumen maintenance projections in accordance with IES LM-80-08 and TM-21-11
- Can be used for State of California Title 24 high efficacy luminaire compliance, reference the California Energy Commission Title 20 Appliance Efficiency Database for current listings
- Can be used for International Energy Conservation Coe (IECC) and Washington State Energy Code high efficiency luminaire Compliance
- ENERGY STAR® Certified luminaire - consult ENERGY STAR® Certified Product List

## Energy Data

| 3000K - dedicated |             |
|-------------------|-------------|
| Lumens            | 690         |
| Wattage           | 8.2W        |
| Input current     | 0.07        |
| Efficacy          | 84.1 LPW    |
| THD               | 15.1%       |
| Frequency         | 60 Hz       |
| T Ambient         | -30 - +40°C |
| Voltage           | 120V        |
| Sound Rating      | Class A     |
| Power Factor      | 0.99        |

| SeleCCTable 2700K - 5000K |             |
|---------------------------|-------------|
| Lumens                    | 802         |
| Wattage                   | 10.3W       |
| Input current             | 0.087       |
| Efficacy                  | 77.9 LPW    |
| THD                       | 11.9%       |
| Frequency                 | 60 Hz       |
| T Ambient                 | -30 - +40°C |
| Voltage                   | 120V        |
| Sound Rating              | Class A     |
| Power Factor              | 0.99        |

### COMPATIBLE WITH EATON'S CROUSE-HINDS JUNCTION BOXES

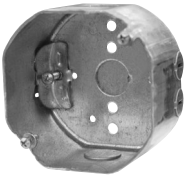

**TP316**  
for non-metallic cable  
4" x 4" x 2-1/8"  
(102mm x 102mm x 54mm)



**TP317**  
for metal clad cable  
4" x 4" x 2-1/8"  
(102mm x 102mm x 54mm)

- **TP316** - for non-metallic cable
- **TP317** - for metal clad cable
- UL Listed
- Refer to [www.crouse-hinds.com](http://www.crouse-hinds.com)

### COMPATIBLE WITH MANY OTHER JUNCTION BOXES\*



**4" octagon light fixture/fan steel box**  
4" x 4" x 2-1/8"  
(102mm x 102mm x 54mm)



**4" octagon steel box**  
4" x 4" x 1-1/2"  
(102mm x 102mm x 38mm)



**4" round new work non-metallic box with hanger bar assembly**  
4" diameter x 2-3/16" (102mm x 56mm)



**4" round new work non-metallic light fixture/fan box**  
4" diameter x 2-3/16"  
(102mm x 56mm)



**3-1/2" round new work non-metallic ceiling box**  
3-1/2" diameter x 2-3/4"  
(89mm x 70mm)



**3-1/2" round old work non-metallic box**  
4-1/4" O.D. flange, 3-1/2" I.D. x 2-5/8"  
(108mm O.D., 89mm I.D. x 67mm)



**4" round surface mount box**  
4" diameter x 1-1/2"  
(102mm x 38mm)



**Round ceiling pan**  
4" diameter x 13/16"  
(102mm x 21mm)  
Note: only compatible with fixed CCT BLD406930

\*This is a representative list of compatible junction boxes only. Information contained in this literature about other manufacturers' products is from published information made available by the manufacturer and is deemed to be reliable, but has not been verified. Eaton makes no specific recommendation on product selection and there are no warranties of performance or compatibility implied. Installer must determine that site conditions are suitable to allow proper installation of the mounting bracket in the box.



## Photometric Data

| BLD406930WH           |          |          |
|-----------------------|----------|----------|
| Luminaire lumens      | 690      |          |
| Input watts           | 8.2      |          |
| LER (LPW)             | 84.1     |          |
| Spacing Criteria      | 0-180    | 1.26     |
|                       | 90-270   | 1.26     |
|                       | Diagonal | 1.38     |
| Beam angle (degrees)  | 114.4    |          |
| Field angle (degrees) | 178.6    |          |
| Max. Candela          | 222      |          |
| Zonal lumen           | Lumens   | % Lumens |
| 0-30                  | 172      | 24.9%    |
| 0-40                  | 282      | 40.8%    |
| 0-60                  | 502      | 72.7%    |
| 0-90                  | 690      | 100.00%  |

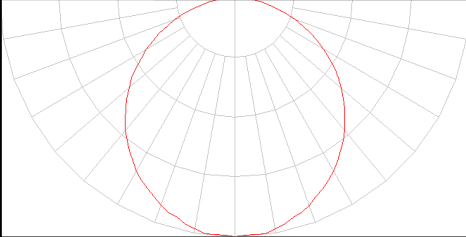

| BLD4089SWH            |          |          |
|-----------------------|----------|----------|
| Luminaire lumens      | 802      |          |
| Input watts           | 10.3     |          |
| LER (LPW)             | 77.9     |          |
| Spacing Criteria      | 0-180    | 1.28     |
|                       | 90-270   | 1.28     |
|                       | Diagonal | 1.4      |
| Beam angle (degrees)  | 116.8    |          |
| Field angle (degrees) | 180      |          |
| Max. Candela          | 250      |          |
| Zonal lumen           | Lumens   | % Lumens |
| 0-30                  | 195      | 24.3%    |
| 0-40                  | 321      | 40.0%    |
| 0-60                  | 576      | 71.8%    |
| 0-90                  | 802      | 100.00%  |

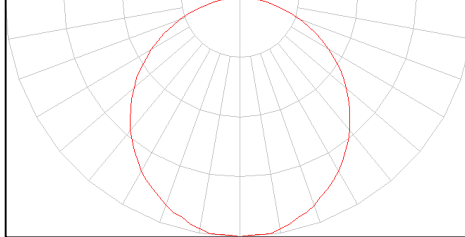

## Color Metric Summary

|          | BLD406930WH | BLD4089SWH |
|----------|-------------|------------|
| TM-30-15 | Rf = 91     | Rf = 91.8  |
|          | Rg = 101.1  | Rg = 101.3 |
| CRI/CIE  | Ra = 93     | Ra = 93    |
|          | R9 = 75     | R9 = 70    |

CCT - Range of 2700K- 5000K

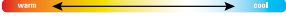

| Foot-candle Values at Nadir<br>0 degree Aiming Angle |                  |          |                 |          |
|--|------------------|----------|-----------------|----------|
| DD (FT)  | BLD406930WH (FC) | DIA (FT) | BLD4089SWH (FC) | DIA (FT) |
| 5.5  | 7.3              | 6.8      | 8.2             | 6.8      |
| 7  | 4.5              | 8.6      | 5.1             | 8.8      |
| 8  | 3.5              | 10       | 3.9             | 10       |
| 9  | 2.7              | 11.2     | 3.1             | 11.4     |
| 10   | 2.2              | 12.4     | 2.5             | 12.6     |
| 12   | 1.5              | 15       | 1.7             | 15.2     |

DD = distance down to illuminated work plane  
FC = initial foot-candles at nadir  
DIA = diameter

