

Fasteners

BLF-14

Spring steel fasteners



B-Line
by **EATON**



Energizing a world that demands more.

Discover today's Eaton.

Powering business worldwide

As a global power management company, we help customers worldwide manage the power needed for buildings, aircraft, trucks, cars, machinery and businesses.

Eaton's innovative technologies help customers manage electrical, hydraulic and mechanical power more reliably, efficiently, safely and sustainably.

**EAT•N**

Powering Business Worldwide



We deliver:

- **Electrical solutions** that use less energy, improve power reliability and make the places we live and work safer and more comfortable
- **Hydraulic and electrical solutions** that enable machines to deliver more productivity without wasting power
- **Aerospace solutions** that make aircraft lighter, safer and less costly to operate, and help airports operate more efficiently
- **Vehicle drivetrain and powertrain solutions** that deliver more power to cars, trucks and buses, while reducing fuel consumption and emissions

We provide integrated solutions that help make energy, in all its forms, more practical and accessible.

With 2013 sales of \$22 billion, Eaton has approximately 100,000 employees around the world and sells products in more than 175 countries.



Eaton's electrical business

Eaton is a global leader with expertise in:

- Power distribution and circuit protection
- Backup power protection
- Solutions for harsh and hazardous environments
- Lighting and security
- Structural solutions and wiring devices
- Control and automation
- Engineering services

Eaton is positioned through its global solutions to answer today's most critical electrical power management challenges. With 100 years of electrical experience behind us, we're energized by the challenge of powering up a world that demands twice as much energy as today. We're anticipating needs, engineering products and creating solutions to energize our markets today and in the future.

We are dedicated to ensuring that reliable, efficient and safe power is available when it's needed most.

Eaton.com

Introduction

The support you rely on.

Improving efficiency during installation with maximum return on investment.

An application is only as strong as its support systems. It's not only important to have reliable power, but determining how that power is distributed – whether in commercial, industrial or data center applications – is critical for efficiency. B-Line continues to be the brand for systems that effectively protect, connect and enclose engineered facility subsystems, keeping your processes running and costs down. From cable tray systems and strut systems to spring steel fastener solutions, the B-Line business is focused on innovative solutions.















Within this Spring Steel Fastener catalog, you will find several innovative, time-saving solutions that help drive your bottom line. Below are just a few of our most recent innovative additions.

- J-Hook color ID system that help verify cables are running in their correct, designated pathways. For more information, visit www.cooperbline.com/color-id.
- BB8 Series box mounting bracket with integrated cable containment for lower installed costs. For more information, visit www.cooperbline.com/BB816.
- Ruff-IN™ pre-fab systems that can save up to 75% during installation. For more information, visit www.cooperbline.com/ruff-in.
- Rapid Ring™ self-adjusting pre-fab ring that installs in as little as 15 seconds. For more information, visit www.cooperbline.com/rapidring.
- KwikWire™ hanging system and accessories that help save time during installation. For more information, visit www.cooperbline.com/kwikwire.
- To view more, visit www.cooperbline.com/laborsavings.

Eaton's B-Line Business
United States
509 West Monroe Street
Highland, IL 62249
United States
Phone: (800) 851-7415
www.cooperbline.com/contactus

Eaton's B-Line Business
Canada
5925 McLaughlin Road
Mississauga, ON L5R 1B8
Canada
Phone: (800) 569-3660
www.cooperbline.com/contactca

Table Of Contents

Ruff-IN™ Pre-Fab	3-8	
Pictorial Index	9-15	
Numbering Guide	16	
Technical Data	17-18	
Wall Studs	19-46	
Conduit & Cable	47-74	
Acoustical Tee	75-94	
Beams	95-118	
Hangers	119-144	
Lathers Channel	145-148	
Communication & Low Voltage	149-176	
Accessories	177-186	
Anchors	187-220	
NEC Requirements	221-236	
TIA/EIA Requirements	237-238	
Reference Data	239-246	
Alphanumeric Index	247-255	

Website: www.bline.com

Ruff-IN™ Pre-Fab

Ruff-IN™ Pre-Fab

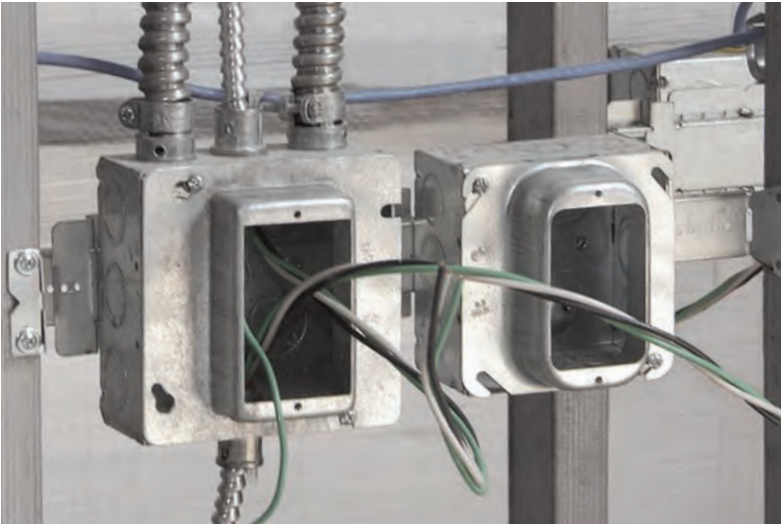

**B-Line's Ruff-IN product offering continues to expand with product and assembly options.
For the latest additions, visit www.cooperbline.com/ruff-in.**



Complete Pre-Fab Offering

Choose the pre-fab offering below that best fits your needs:

Basic Ruff-IN

Offering Contents: Bracket, Box, Mud Ring, Ground Wire

- Ideal solution for a contractor sampling pre-fab for the first time that wants to keep the control of his or her project.
- Published lead times of 3-5 days ARO, and NEXT DAY SHIPPING ON (16) QUICK-SHIP ASSEMBLIES. (See pages 5 & 6)

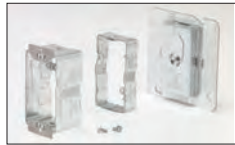

Ruff-IN with Wiring Devices and/or MC Cable Whips

Offering Contents: Basic Ruff-IN with Wiring Device, Protective Cover Plates, and MC Cable whip with connector(s)

- Assemblies are pre-wired for quick plug and-play installation using Wago™ or wire nut connectors.
- Wiring Device's ArrowLink™ connector offers additional labor savings with its plug in feature. (See page 4 for more details)
- Pre-wired Ruff-IN assemblies with devices and a pre-cut MC cable whip attached.
- Whip lengths available in 5-foot increments.
- Includes option to order MC cable whips only.



Total Ruff-IN™

Perfect for a contractor that desires take-off services and B-Line engineering support

- Perfect for a contractor interested in trying pre-fab for the first time that needs the engineering and assembly expertise of B-Line.
- Industry leading, published lead times for Total Ruff-IN quotation responses and order assembly.



† Wago™ is a trademark used by WAGO® Kontakttechnik GmbH & Co. KG

See Ruff-IN Pre-Fab Systems brochure for product information and part numbers.

Ruff-IN™ Pre-Fab

Distributor Quick Ship Program

Next Day Shipping Available on

12 Ruff-In Assemblies & 4 Rapid Ring™ Assemblies

- No need to request a lead time, order today and we'll ship out of stock tomorrow!
- Ask your B-Line Sales Representative for more information on stock-able Ruff-IN assemblies.

Ruff-IN Quick Ship Pre-Fab Assemblies

Part #	UPC #	Max. Order Qty.
BBF Series Floor-mount		
BBF18-1104DA	78205154072	50
18" BBF floor-mount, 1-gang 5/8" plaster ring, TP403 box, stranded ground wire		
BBF18-1104D	78205154065	50
18" BBF floor-mount, 1-gang 5/8" plaster ring, TP403 box, solid ground wire		
BBF18-1124DA	78205155199	25
18" BBF floor-mount, 1-gang 3/4" plaster ring, TP403 box, stranded ground wire		
BBF18-1124D	78205154176	25
18" BBF floor-mount, 1-gang 3/4" plaster ring, TP403 box, solid ground wire		
Double-Sided Box Support		
BB76-1104DA	78205155200	100
6" Double-sided box support 1-gang 5/8" plaster ring, TP403 box, stranded ground wire		
BB76-1104D	78205138768	25
6" Double-sided box support 1-gang 5/8" plaster ring, TP403 box, solid ground wire		
BB76-1124DA	78205154049	50
6" Double-sided box support 1-gang 3/4" plaster ring, TP403 box, stranded ground wire		
BB76-1124D	78205138771	25
6" Double-sided box support 1-gang 3/4" plaster ring, TP403 box, solid ground wire		
Telescoping Slider Bracket		
BB216TS-1104DA	78205139289	25
16" Telescoping Slider Brkt, 1-gang 5/8" plaster ring, TP403 box, stranded ground wire		
BB216TS-1104D	78205138619	25
16" Telescoping Slider Brkt, 1-gang 5/8" plaster ring, TP403 box, solid ground wire		
BB216TS-1124DA	78205139292	25
16" Telescoping Slider Brkt, 1-gang 3/4" plaster ring, TP403 box, stranded ground wire		
BB216TS-1124D	78205138621	25
16" Telescoping Slider Brkt, 1-gang 3/4" plaster ring, TP403 box, solid ground wire		



BBF18-1104DA



BB216TS-1104D



BB76-1104D

Rapid Ring™ Quick Ship Pre-Fab Assemblies

Part #	UPC #	Max. Order Qty.
BB216TS-1RR4DA 16" Telescoping Slider Brkt, 1-gang Rapid Ring, TP403 box, stranded ground wire	78205176294	50
BB216TS-1RR4D 16" Telescoping Slider Brkt, 1-gang Rapid Ring, TP403 box, solid ground wire	78205176295	50
BB216TS-2RR4DA 16" Telescoping Slider Brkt, 2-gang Rapid Ring, TP403 box, stranded ground wire	78205176296	50
BB216TS-2RR4D 16" Telescoping Slider Brkt, 2-gang Rapid Ring, TP403 box, solid ground wire	78205176297	50



**Telescoping
Slider Bracket
with Rapid Ring**

Ruff-IN™ Pre-Fab

Ruff-IN™ Pre-Fab

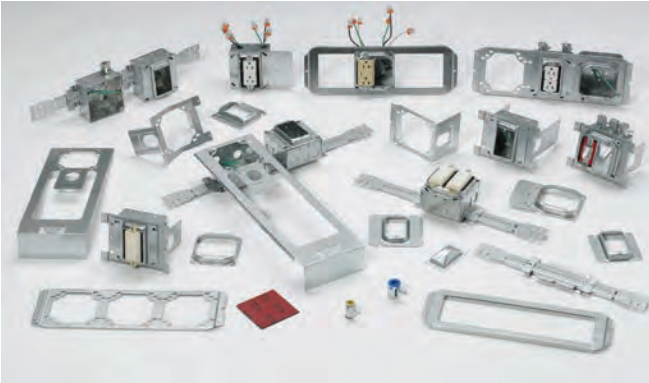

B-Line's Ruff-IN Configurator program helps simplify the planning process for pre-fab construction. The program will walk you through a component selection process, build customized pre-fab assemblies, and create a project BOM to accelerate the quotation process.

Configurator Features

- Build an assembly to your own specification by choosing from brackets, boxes, plaster rings, wiring devices, and other accessories.
- Check the assembly for accuracy by reviewing a 3D, rotatable image that is created in real time.
- Configure multiple assemblies and save them as a project.
- Divide the project into rooms and specify the types and quantities of assemblies that go in each location.
- Print a customized project submittal package with the push of a button.
- Submit the entire project with your specific job and assembly information to B-Line for a quote with one click.

All of these features translate into fewer mistakes and less time spent during the take-off process. Let the B-Line Ruff-IN Configurator go to work for you. Build your next project using B-Line's Ruff-IN pre-fabricated wiring assemblies today!

For more information, visit www.cooperbline.com/ruff-in.

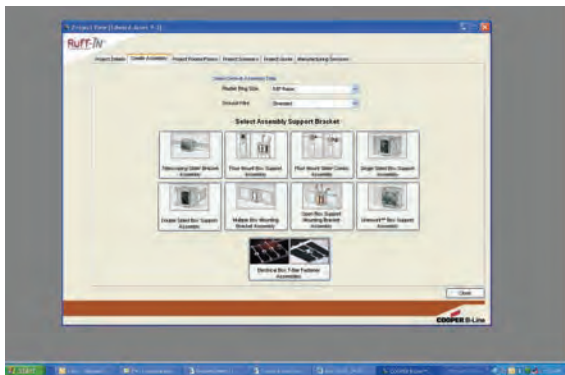
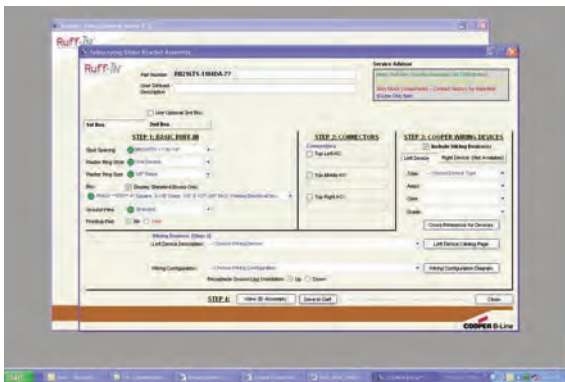

See Ruff-IN Pre-Fab Systems brochure for product information and part numbers.

Pictorial Index

Wall Studs

Pictorial Index

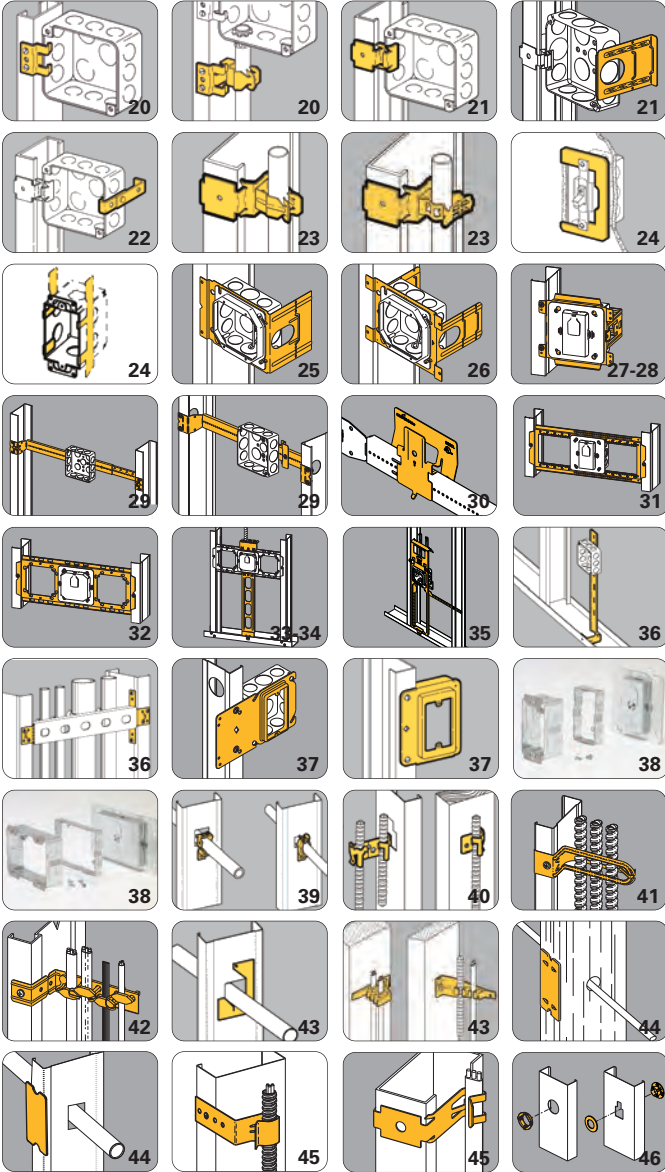

Conduit & Cable



Pictorial Index

Conduit & Cable

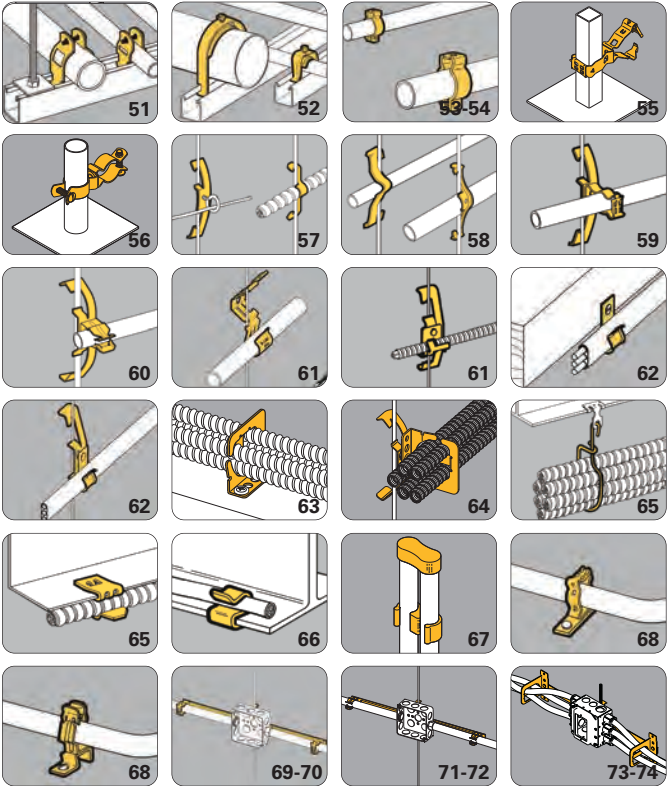

Pictorial Index

Acoustical Tee

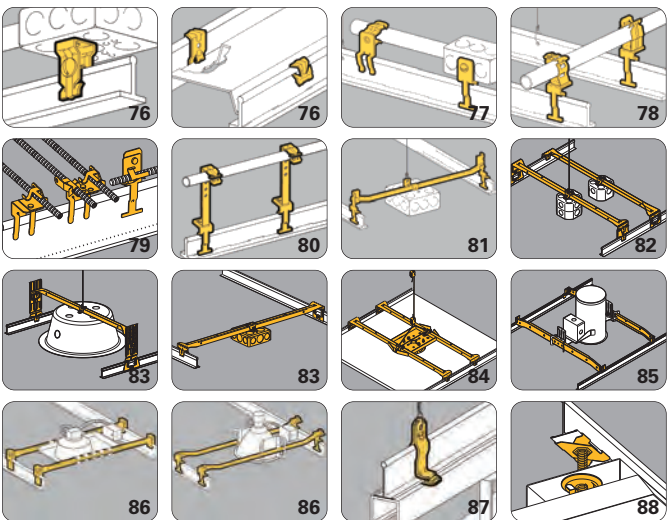

Pictorial Index

Acoustical Tee

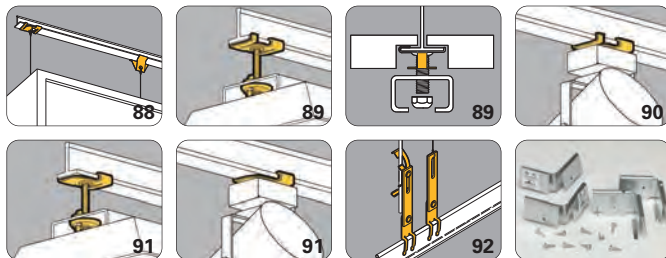

Beams

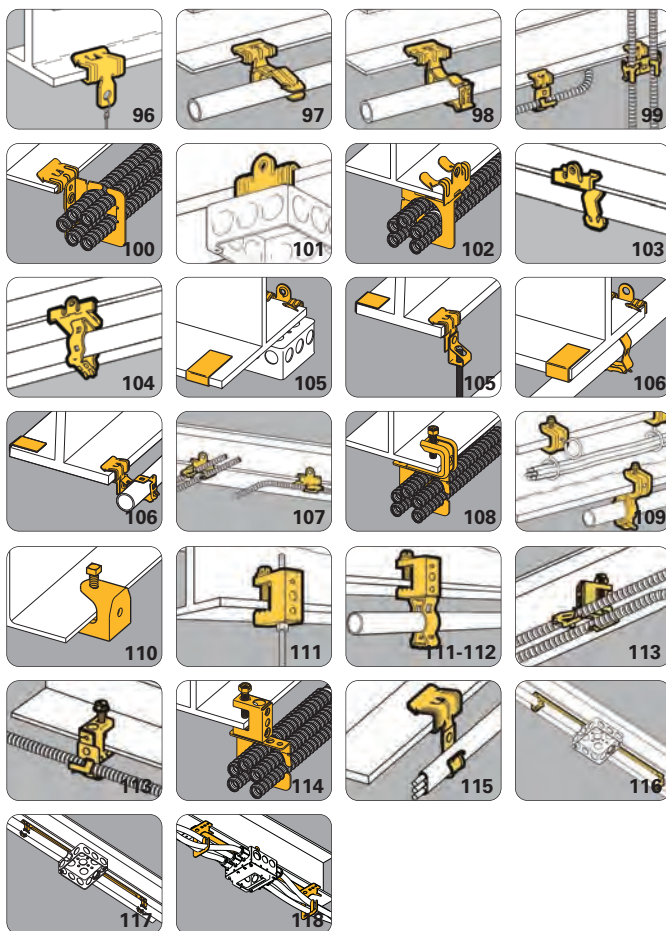

Pictorial Index

Hangers

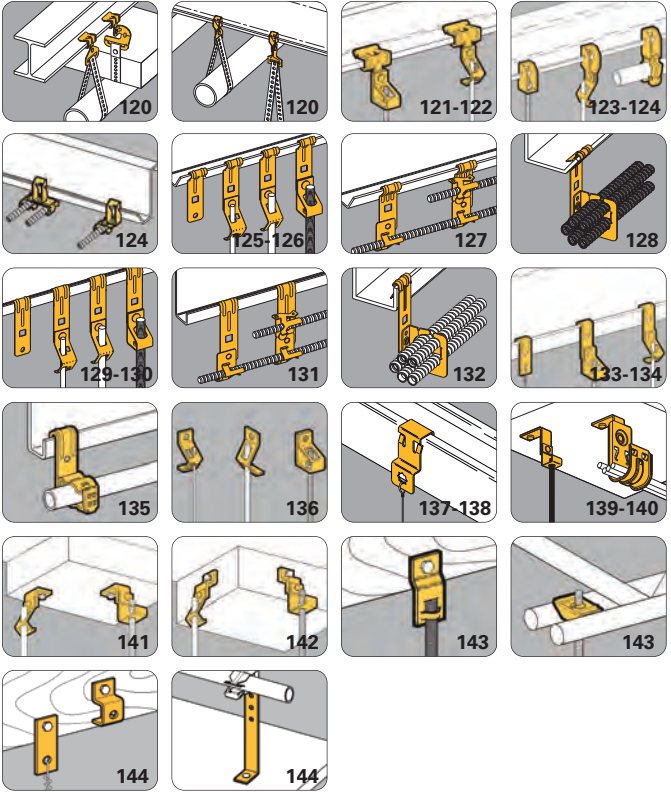

Pictorial Index

Lathers Channel



Pictorial Index

Communication & Low Voltage

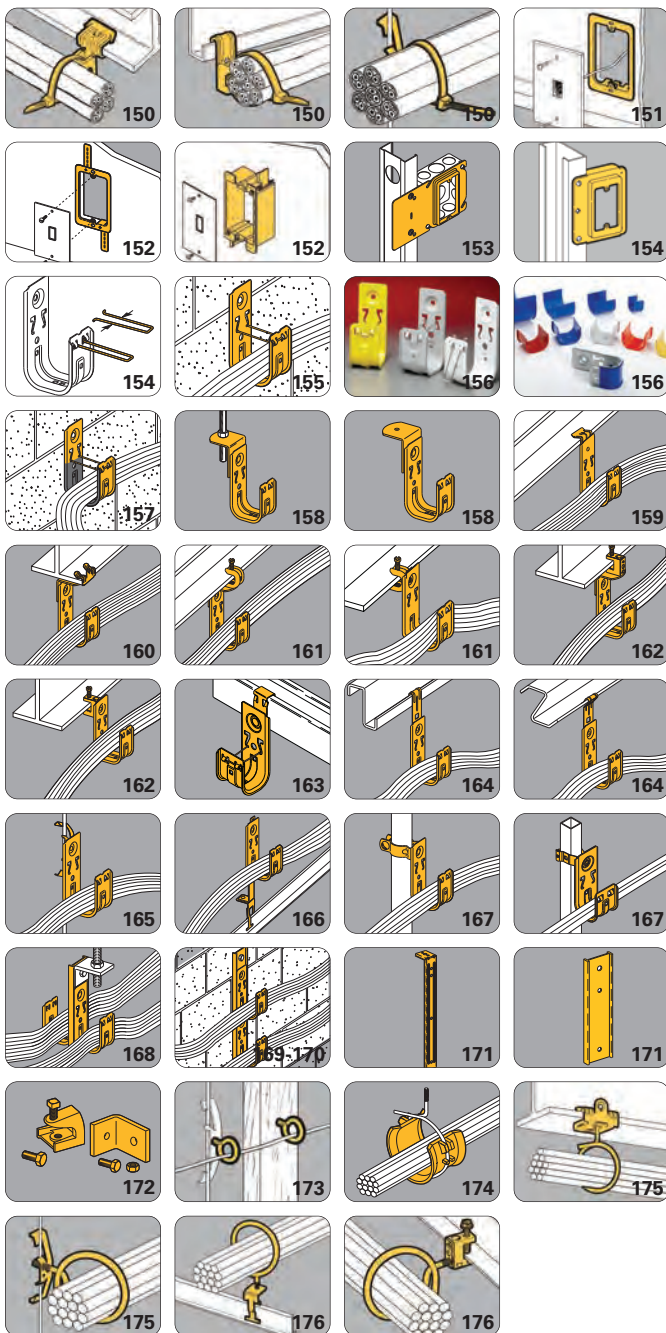

Accessories

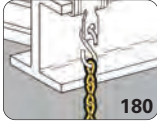
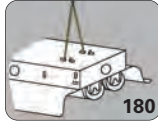
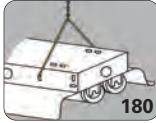
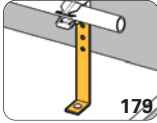
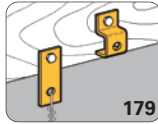
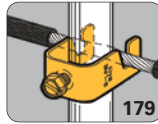
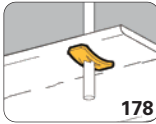

Pictorial Index

Anchors

Pictorial Index



189-190



191-192



191-192



193



194



195



196



197-198



199-200



201-202



203-204



205-206



207



208



209



210



211



212



213



214



215



216



217



218



219

Part Numbering Guide

This part numbering guide can be used to quickly translate our part numbers into meaningful data.

BG - 8-12 - 4T		
Family	Size	Suffix
A Series - Anchors	Based on 16th	AS - Anchor Strap
* B Series - Pipe Strap	of an inch	BL - Equipment Blue
BA - Acoustical Tee Component	1 - 1/16"	BN - Brass Nut
BB - Box Attachment	2 - 1/8"	BR - Brown
BC - Beam Clamp	4 - 1/4"	BW - Bright White
* BCH - Cable Hook	5 - 5/16"	CW - Computer White
* BCS/BES - Conduit Spacer	6 - 3/8"	D - Deep Box
BD - Deck Attachment	8 - 1/2"	FB - Flat Black
* BE - Edge Attachment	9 - 9/16"	GR - Green
BF - Flange Attachment	12 - 3/4"	H - Hanger
* BG - Guide-Rite™ Fastener	16 - 1"	LH - Less Hardware
BH - Hanger Attachment	20 - 1 1/4"	LN - Less Nut
BK - KwikWire	24 - 1 1/2"	LS - Less Stud
BL - Conduit Hangers (mini's)	32 - 2"	OR - Orange
BM - Miscellaneous	64 - 4"	R - Right Angle
BN - Push Nuts		RR - Regal Red
* BP - Push Type Fasteners		S - Stud
* BPC - Break Apart Straps		T - Threaded
* BR - Bridle Rings		TG - Telco Gray
BRC - Cable Fastener		W - White
* BRS - Bridle Ring Saddle		WBN - White /Brass Nut
BT - Installation Tools		WN - Wing Nut
* BU - Universal Beam Attachment		YL - Safety Yellow
BW - Bat Wing Fastener		4T - 1/4" Thread Imp.
BX - FMC Support		

* The data in the size column only applies to these product families.

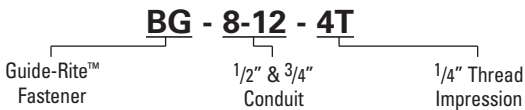

Materials

Steel	Specification
High Carbon Cold Rolled	ASTM A684, AISI 1055
Electrolytic Zinc Coated	ASTM A591
Pre-Galvanized	ASTM A653

Steel

B-Line spring steel fasteners are manufactured from spheroidized annealed high carbon cold rolled steel (ASTM A684, AISI 1055). Mild steel fasteners are manufactured from electrolytic zinc coated steel (ASTM A591) or pre-galvanized steel (ASTM A563).

Electrolytic zinc coated and pre-galvanized steel is produced by coating coils of sheet steel with zinc at the mills. These coils are then slit to size and fabricated into B-Line products.

Heat Treatment

B-Line spring steel fasteners are heat treated to make the steel hard and give the parts their spring quality and strength. The hardness for a given fastener depends on the required load carrying capacity and the application.

Load Data

The design load ratings for B-Line fasteners are specified in this catalog as static load capacity or ultimate static load capacity. By definition, the listed static load capacity has a safety factor of three (3.0), the listed ultimate static load capacity has no safety factor. In either case, these stated loads are not to be exceeded, and loads should be applied only as depicted in the catalog and/or instruction sheets. The load capacity of a fastener having more than one component is equal to the load capacity of the lowest rated component.

Fasteners having no load ratings are designed for proper placement of boxes, conduit, etc., and not for supporting loads.

B-Line fasteners are designed for use with support members (e.g.: angle iron, bar joists, beams, columns, flanges, purlins, wire, rod) that comply with the applicable AISI standards and threaded rod that complies with the applicable AISI standards.

Quality Assurance

B-Line has an established Q.C. program in which raw material and finished products are sampled, inspected and tested by certified inspectors to assure that all applicable standards are met. B-Line's fasteners are manufactured in controlled lots and each part is identified by a lot number stamped into the part. This number allows B-Line to track each step of the manufacturing process including raw material, die set-up, heat treating, and finishing. Samples are tested to verify correct hardness, corrosion resistance and load carrying capacity.

Part Numbering Guide

Finish	Specification
Zinc-Phosphate	MIL-P-16232 Type Z
Electro-galvanized Zinc	ASTM B633
Pre-Galvanized Zinc	ASTM A653, G90
Gloss White Paint	Acrylic Enamel

Zinc Phosphate

B-Line spring steel fasteners receive a coating* of sealant impregnated zinc phosphate. This type of coating was commercially developed by industry to inhibit oxidation of ferrous metals for up to 72 hours in a specified salt fog atmosphere. As applied to its fasteners, B-Line rates this coating for 30 hours when salt fog tested per ASTM B-117.

Although rust resistant, B-Line fasteners should be used only indoors and in non-corrosive environments.

Unless otherwise noted, the standard finish for B-Line's spring steel fasteners is Zinc Phosphate.

*At least 1000 milligrams of zinc phosphate per square foot.

Paint

Some standard fasteners have a gloss white acrylic enamel applied over the zinc phosphate finish for an enhanced appearance that compliments white ceiling grids.

Electro-galvanized Zinc

Electro-galvanized zinc (also known as zinc plated or electroplated) is the process by which a coating of zinc is deposited on the steel by electrolysis from a bath of zinc salts.

The coating is pure zinc and is mechanically bonded to the steel. A maximum of .5 mils of zinc can be applied by this method.

When exposed to air and moisture, zinc forms a tough, adherent, protective film consisting of a mixture of zinc oxides, hydroxides, and carbonates. This film is in itself a barrier coating which slows subsequent corrosive attack of the zinc.

This coating is usually recommended for indoor use in relatively dry areas.

Pre-Galvanized Zinc

Pre-galvanized steel is produced by coating coils of sheet steel with zinc by continuously rolling the material through molten zinc at the mills. This is also known as mill galvanized or hot-dip mill galvanized. These coils are then slit to size and fabricated into B-Line products.

The G90 specification calls for a coating of .90 ounces of zinc per square foot on each side of the sheet.

During fabrication, cut edges and welded areas are not normally zinc coated; however, the zinc near the uncoated metal becomes a sacrificial anode to protect the bare areas after a short period of time.

Pre-galvanized steel is recommended for indoor use in dry areas.

CAUTION: Do not use B-Line Fasteners outdoors or in corrosive environments. Proper application of each fastener is shown in this catalog and on the installation sheet inside each carton. Failure due to improper installation may cause harm to personnel and/or property. Allowable loads shown apply to the fastener only and do not account for the structure, which supports the fastener. Flanges, wires and rods used with these fasteners must meet A.I.S.I. standards. To improve personal safety on the jobsite, always observe all federal and local safety regulations: wear gloves, safety glasses and a hard hat.

Wall Studs

Wall Studs

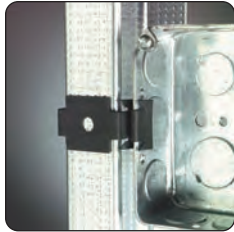
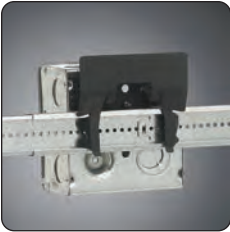
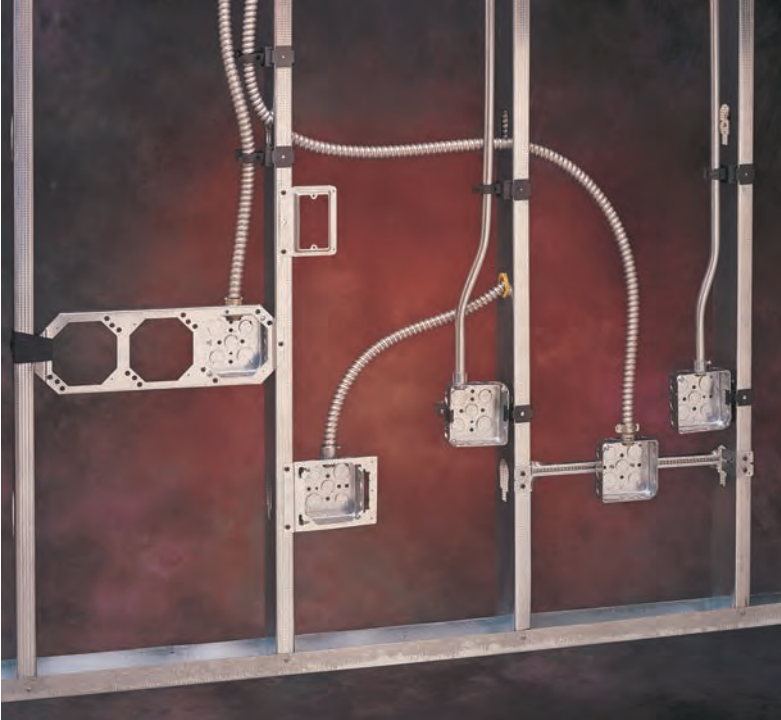

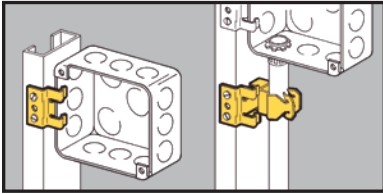

- Attaches with screws to metal studs.
- BB1 supports electrical box.
- BG series features Guide-Rite design.
- BP series features push-type design.

Box To Stud Fastener



UPC/Part Number	Catalog Number	Description	Box Qty.
78101118145	BB1	Electrical Box Support Clip	100

Guide-Rite™ Conduit To Stud Fastener



UPC/Part Number	Catalog Number	Conduit Size EMT & Rigid	Box Qty.
78101118420	BG-6-B1 *	3/8"	100
781011 18475	BG-8-12-B1	1/2", 3/4"	100
781011 18555	BG-16-B1	1"	100

Patent #4958792

- * BG-6 will accept the following range \varnothing .420 - \varnothing .675:
14/2 thru 10/4 MC/AC cable and 5/16 or 3/8 flexible conduit

Push Type Conduit To Stud Fastener



UPC/Part Number	Catalog Number	Conduit Size	Box Qty.
781011 19245	BP-8-B1	1/2" EMT	100
781011 19345	BP-12-B1	3/4" EMT, 1/2" IMC, Rigid	100
781011 19440	BP-16-B1	1" EMT, 3/4" IMC, Rigid	100

Read safety/installation instruction sheets in packages before use.
These products are designed for positioning only. No load rating.

Wall Studs

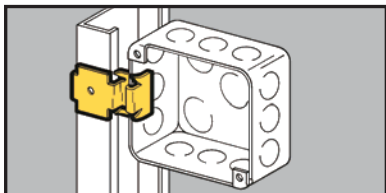

- Attaches electrical boxes (requiring plaster rings) to most metal studs.
- Box mounts flush to back of drywall.
- Simply installed with a hammer.

Box To Stud Fastener



Wall Studs

UPC/Part Number	Catalog Number	Description	Box Qty.
78101118270	BB9	Electrical Box Support	100

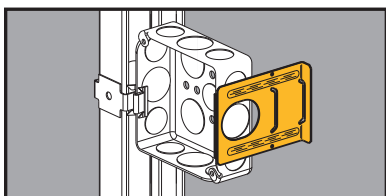

- Provides far-side support for electrical boxes in 2¹/₂" thru 6" studs.
- Cut outs facilitate bending to provide precise installation with greater stability.
- Easily snaps onto box side and is secured in place by plaster ring.

Adjustable Box Stabilizers



BB12



BB12-6



UPC/Part Number	Catalog Number	Metal Stud Size	Box Qty.
78101192876	BB12	2 ¹ / ₂ " thru 4"	100
78101192879	BB12-6	6"	100

Read safety/installation instruction sheets in packages before use.
These products are designed for positioning only. No load rating.

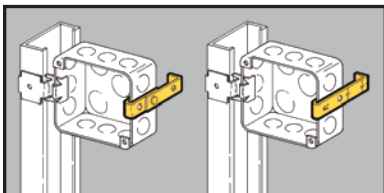

- Provides far-side support for electrical boxes.
- See BB12 Series for a better solution.

Box Stabilizer



BF1-96



BF1-64



BF1-56



BF1-40



UPC/Part Number	Catalog Number	Metal Stud Size	Box Qty.
78101118320	BF1-40	2 ¹ / ₂ "	100
78101118325	BF1-56	3 ¹ / ₂ "	100
78101118330	BF1-64	4"	100
78101118335	BF1-96	6"	100

*Read safety/installation instruction sheets in packages before use.
These products are designed for positioning only. No load rating.*

Wall Studs

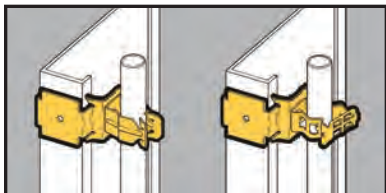

- Attaches conduit to most metal studs.
- BG Series features Guide-Rite design.
- BP Series feature push-type design.

Guide-Rite™ Conduit To Stud Fastener



UPC/Part Number	Catalog Number	Conduit Size EMT & Rigid	Box Qty.
78101118425	BG-6-B5 *	3/8" or BX	100
78101118480	BG-8-12-B5	1/2", 3/4"	100
78101118560	BG-16-B5	1"	100
78101118645	BG-20-B5	1 1/4"	50

Patent #4958792

- * BG-6 will accept the following range Ø.420 - Ø.675:
14/2 thru 10/4 MC/AC cable and 5/16 or 3/8 flexible conduit

Push Type Conduit To Stud Fastener



UPC/Part Number	Catalog Number	Conduit Size	Box Qty.
78101119250	BP-8-B5	1/2" EMT	100
78101119350	BP-12-B5	3/4" EMT, 1/2" IMC, Rigid	100
78101119445	BP-16-B5	1" EMT, 3/4" IMC, Rigid	100

Read safety/installation instruction sheets in packages before use.
These products are designed for positioning only. No load rating.

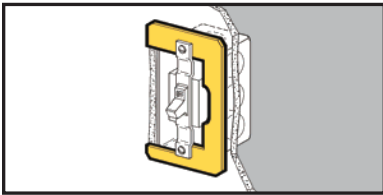

Retainer Leveler

- BB32 adds rigidity to devices in oversize wall openings.
- Holds wiring device firmly in drywall.
- Can be used with switches, receptacles, GFCIs and decorator devices.
- Ideal for positioning devices in pre-fab installations.
- Finish: Pre-Galvanized



UPC/Part Number	Catalog Number	Description	Box Qty.
78101118215	BB32	Adds Rigidity to Oversize Wall Openings	100

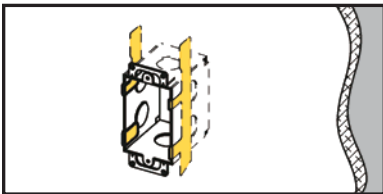

Box Support

- Attaches electrical boxes to finished drywall.
- Box is completely supported by drywall.
- Prevents box from pulling out of wall.
- Finish: Pre-Galvanized

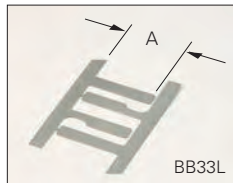
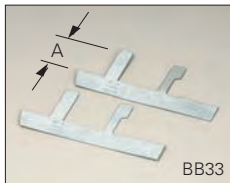

UPC/Part Number	Catalog Number	Description	Length A	Box Qty.
78101101138	BB33	Box Support	1 ¹ / ₂ "	100 pr.
78101104936	BB33L	Long Leg Box Support	2 ¹ / ₂ "	100

Read safety/installation instruction sheets in packages before use.
These products are designed for positioning only. No load rating.

Wall Studs

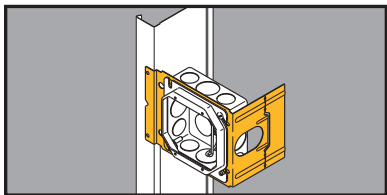

Box Support Brackets



- Improved far-side support stands up during drywall installation and outperforms competitor brackets.
- Supports 4" or 4¹¹/₁₆", square boxes.
- Brackets may be piggy-backed in series.
- Finish: Pre Galvanized.
- See Ruff-IN™ brochure for pre-fab box assemblies.

Wall Studs

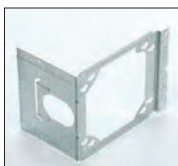

BB4-23



BB4-4



BB4-6

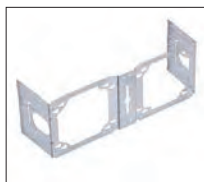

BB4-23D

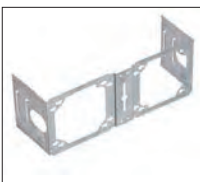

BB4-4D

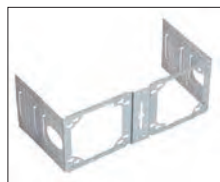

BB4-6D

UPC/Part Number	Catalog Number	Metal Stud Size	Box Qty.
78101118190	BB4-23	3 ⁵ / ₈ ", 2 ¹ / ₂ "	100
78101118200	BB4-4	4", 3 ⁵ / ₈ ", 2 ¹ / ₂ "	100
78101118202	BB4-6	6", 5 ¹ / ₂ ", 3 ⁵ / ₈ ", 2 ¹ / ₂ "	100
79903848375	BB4-23D	3 ⁵ / ₈ ", 2 ¹ / ₂ "	50
79903848376	BB4-4D	4", 3 ⁵ / ₈ ", 2 ¹ / ₂ "	50
79903848377	BB4-6D	6", 5 ¹ / ₂ ", 3 ⁵ / ₈ ", 2 ¹ / ₂ "	50

Read safety/installation instruction sheets in packages before use.
These products are designed for positioning only. No load rating.

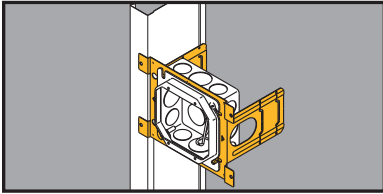

Double-Sided Box Support Bracket w/ Marty-Mouse™ Ears

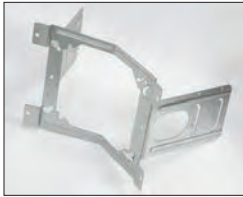

1. Bracket is shipped with ear tabs in the open position



2. Insert box screws into open slots

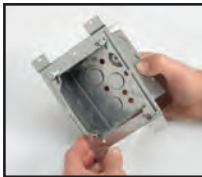

3. When plaster ring is installed, the ear tabs are bent down into the closed position



4. With the tabs closed, the box remains secured to the bracket when the plaster ring is removed

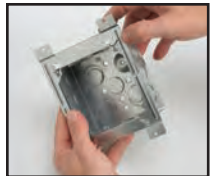

- Double-side box support, designed for Pre-Fab. Unit can be installed on either side of stud without repositioning box or devices.
- Patented Marty Mouse™ ears feature an innovative keyhole pattern to secure outlet box to bracket with or without the plaster ring.
- Wider box opening accommodates one or two gang adjustable plaster rings (B1AJ & B2AJ).
- Enhanced far-side support stands up during drywall installation and out out performs competitor brackets.
- See Ruff-IN™ brochure for pre-fab box assemblies.
- Finish: Pre-Galvanized

UPC/Part Number	Catalog Number	Stud Size	Box Qty.
78205138645	BB73	3 ⁵ / ₈ ", 2 ¹ / ₂ "	50
78205138717	BB74	4", 3 ⁵ / ₈ ", 2 ¹ / ₂ "	50
78205138759	BB76	6", 5 ¹ / ₂ ", 3 ⁵ / ₈ ", 2 ¹ / ₂ "	25

Patent # 5595362

Read safety/installation instruction sheets in packages before use.
These products are designed for positioning only. No load rating.

Wall Studs

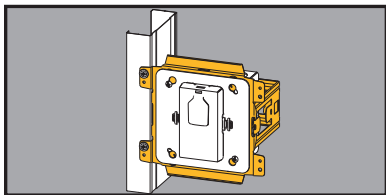

- Interlocking wrap-around design provides extra rigidity.
- Supports most standard 1-gang and 2-gang US and Canadian boxes and/or plaster rings 4" SQ., 4^{11/16}" SQ., and 5" SQ. on either side of the stud.

Box Support Brackets

Available August 2014

- Adjustable for varying stud depths (2^{1/2}" to 6").
- Compatible with 1-gang and 2-gang Rapid Ring™ and adjustable plaster rings.
- Integral mounting tabs for attaching plaster rings.
- Multiple brackets may be ganged together.
- Available factory assembled as part of the Ruff-IN™ pre-fab line with box, mud ring, and pre-wired devices.
- Finish: Pre Galvanized.
- Patent Pending



Wall Studs

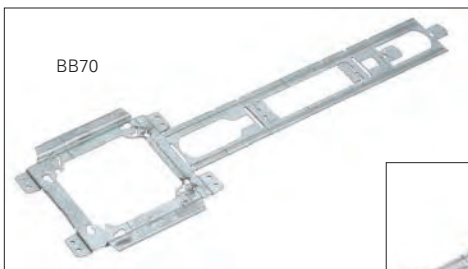

BB70

BB70E*
(Sold separately,
must be used
with BB70)

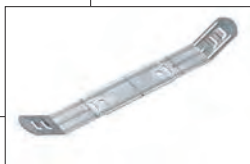

See following page for various product information.

UPC/Part Number	Catalog Number	Metal Stud Size	Box Qty.
79903856399	BB70	2 ^{1/2} " - 4"	50
79903856400	BB70E*	5 ^{1/2} " - 6"	50



Can be used with BBCC (containment clip) and BBFS-18 (floor stand) See pages 33 & 34.

Read safety/installation instruction sheets in packages before use. These products are designed for positioning only. No load rating.

Bent For Various Depths

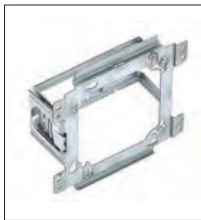

2 1/2"

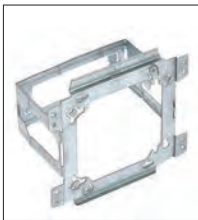

3 5/8"

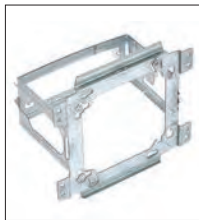

4"

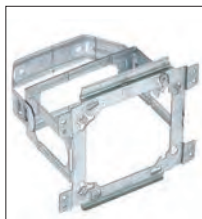

6"

For 5 1/2" depth, snap the BB70E into the next notch on the bracket side

Bending Bracket For 3 5/8" Depth

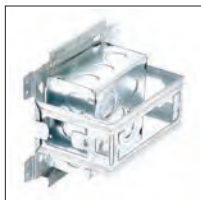
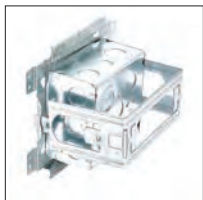
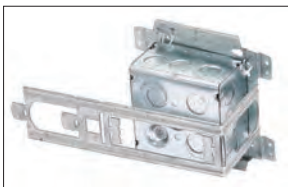
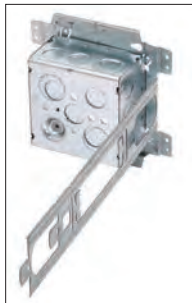
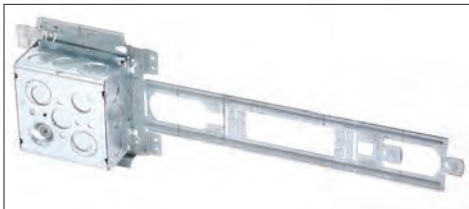

Read safety/installation instruction sheets in packages before use.
These products are designed for positioning only. No load rating.

Wall Studs

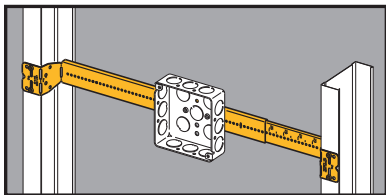

- Completely adjustable - fits a range of stud spacings and 1 1/2" or 2 1/8" deep boxes.
- Pre-punched screw holes provide for easy box installation.
- Bar is marked with scale for stud spacing.
- Finish: Pre-galvanized

Telescoping Box Mounting Bracket

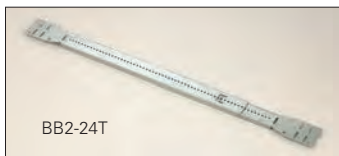

UPC/Part Number	Catalog Number	Metal Stud Spacing	Box Qty.
78101104256	BB2-16T	11" to 18"	50
78101101664	BB2-24T	15" to 26"	50

Licensed under Patent #5386959 • Patent #5209444

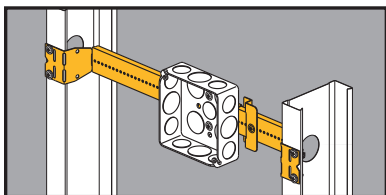

- Designed for pre-fab.
- Box can be attached to slider bracket before or after slider is installed on telescoping bracket.
- Box location can be field adjusted by moving slider along telescoping bracket.
- See Ruff-IN™ brochure for pre-fab box assemblies.
- Finish: Pre-galvanized

Telescoping Slider Bracket



BB2TS



UPC/Part Number	Catalog Number	Stud Spacing	Box Qty.
78205138614	BB216TS	11" to 18"	20
78205138628	BB224TS	15" to 26"	20
78205138613	BB2TS	Slider Bracket Only	50

Patent # 7,472,875

Read safety/installation instruction sheets in packages before use.
These products are designed for positioning only. No load rating.

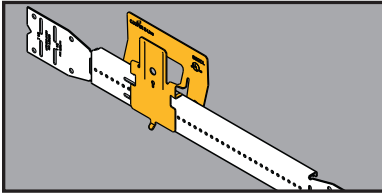

CROC-LOK™ Box Mounting Bracket



- Designed for pre-fab.
- Outlet boxes mount to the CROC-LOK with single screw.
- CROC-LOK box assemblies can be attached before or after the telescoping bar is mounted in the stud wall.
- The tool-less design enables CROC-LOK assemblies to be field installed in less than 4 seconds. Simply squeeze, secure and walk away.
- See Ruff-IN™ brochure for pre-fab box assemblies.

UPC/Part Number	Catalog Number	Description	Stud Spacing	Box Qty.
78205151291	BB2CL	CROC-LOK only	N/A	50
78205151292	BB216TCL	BB216T with CROC-LOK	11" - 16"	20
78205151293	BB224TCL	BB224T with CROC-LOK	15" - 24"	20

Note:

U.S. Patent # 8,403,277

Secures to B-Line BB2-16T and BB2-24T telescoping brackets only. For a standard 2¹/₈" deep box, the stud depth must be 3¹/₂" or greater. For a shallow 1¹/₂" deep box, the stud depth must be 2¹/₂" or greater.

Mounting Screws



UPC/Part Number	Catalog Number	Description	Box Qty.
78101101675	BWHS-9	#8 x 9/16" Sheet Metal Screw	1000
78101104925	BWHS-9D	#8 x 9/16" Self-Drilling Sheet Metal Screw	1000

Note: BWHS-9 & BWHS-9D can be used with all fasteners requiring attachment with sheet metal screws, except on BB2-16, BB2-16D, BB2-24 & BB2-24D which only BWHS-9 can be used.

*Read safety/installation instruction sheets in packages before use.
These products are designed for positioning only. No load rating.*

Wall Studs

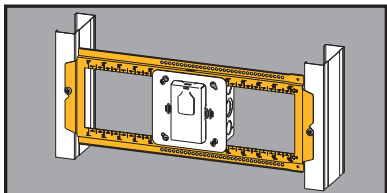

Open Box Mounting Bracket

Available August 2014



- Open box support allows for adjustability of box position between studs.
- Supports most US and Canadian boxes and/or plaster rings 4" SQ., 4¹¹/₁₆" SQ., 5" SQ., and multi-gang boxes.

- Fits up to 1¹/₂" wide studs 16" to 24" on center.
- Compatible with Rapid Ring™ & adjustable plaster rings.
- Field cut to adjust to non-standard stud spacings.
- Stamped markings at 1/4", 1/2", and 1" increments to allow the installer to easily locate the desired box position.
- Available factory assembled as part of the Ruff-IN™ pre-fab line with box(es), mud ring(s), and pre-wired devices.
- Finish: Pre-galvanized
- Patent Pending

Wall Studs

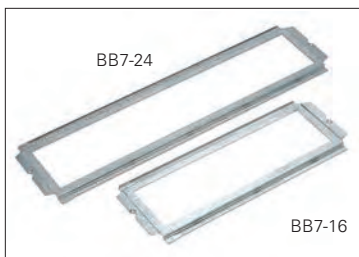

UPC/Part Number	Catalog Number	Description	Box Qty.
78205145325	BB7-16	16" Stud Spacing	25
78205145328	BB7-24	24" Stud Spacing	25

Can be cut on a mark to make shorter length brackets.

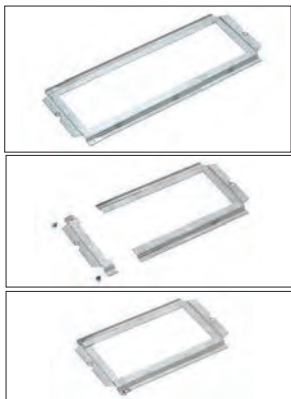

Can be used with BBFS-18 (floor stand)
See pages 33 & 34.



Read safety/installation instruction sheets in packages before use.
These products are designed for positioning only. No load rating.

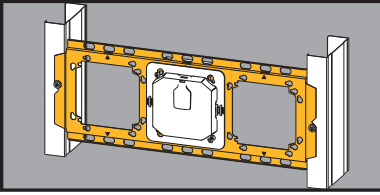

Box Mounting Bracket



- Increased strength and rigidity help withstand the stress of drywall installation.
- Supports most US & Canadian boxes and plaster rings 4" SQ. and 4^{11/16}" SQ.
- Compatible with 1-gang and 2-gang Rapid Ring™ and adjustable plaster rings.
- Available factory assembled as part of the Ruff-IN™ pre-fab line with box(es), mud ring(s), and pre-wired devices.
- Finish: Pre-galvanized
- Patent Pending

Wall Studs

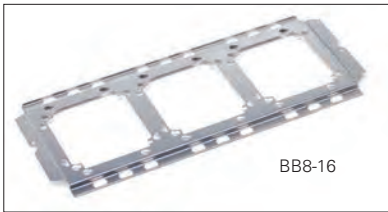

BB8-16

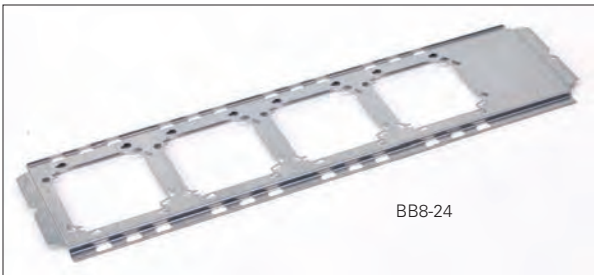

BB8-24

UPC/Part Number	Catalog Number	Description	Box Qty.
78101102898	BB8-16	16" Stud Spacing	25
78101102900	BB8-24	24" Stud Spacing	25

*Read safety/installation instruction sheets in packages before use.
These products are designed for positioning only. No load rating.*

Wall Studs

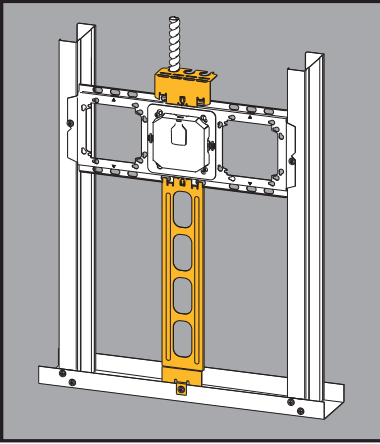

- Bracket accessories require no tools to install.
- BBCC cable containment clip provides first means of support for MC cable.
- BBFS-18 floor stand ensures consistent box height and eliminates need to measure for proper install height.
- Can be used with BB7 and BB8 brackets. See pages 27, 31, and 32.
- Pre-galvanized finish.

Box Mounting Bracket Accessories

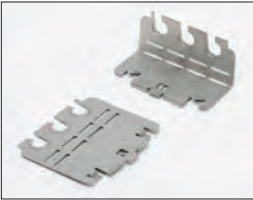

BBCC

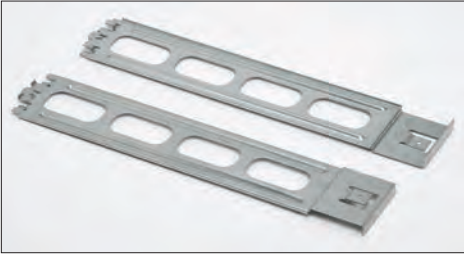

BBFS-18

UPC/Part Number	Catalog Number	Description	Box Qty.
79903851597	BBFS-18	Floor Stand	25
79903851598	BBCC	.439" - .750" OD MC Cable	50

*Read safety/installation instruction sheets in packages before use.
These products are designed for positioning only. No load rating.*

Box Mounting Bracket Accessories con't.



BB8-16 Installed



BBFS-18 & BBCC Installed (Can be used with BB7 or BB8 brackets)

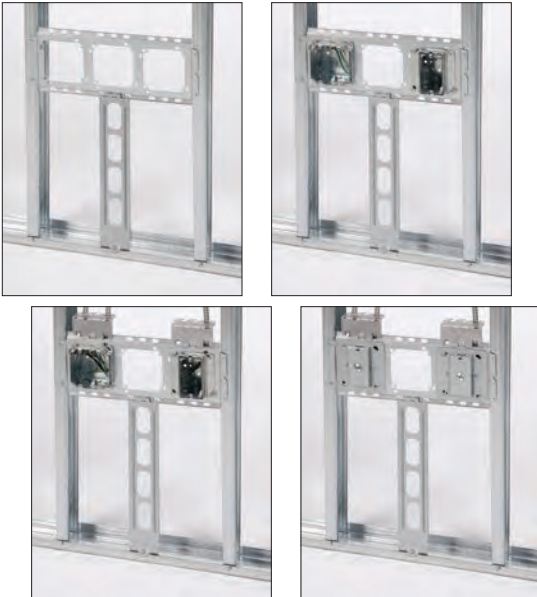

*Read safety/installation instruction sheets in packages before use.
These products are designed for positioning only. No load rating.*

Wall Studs

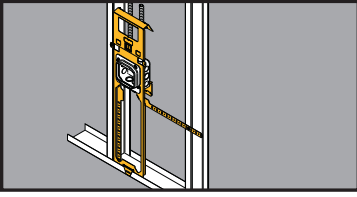

Floor-Mount Box Support



BBF15



BBFC



BBF18



BBF24



BBFxxC

- New BBF floorstand provides the most rigid support in the industry.
- Far-side support accommodates 6", 5 1/2", 3 5/8", and 2 1/2" stud depths.
- Fold-out tab built-in to attach floor stand to stud if desired.
- Integral "wings" provide rigid support when floorstand is mounted between studs.
- Optional cable containment clip securely attaches to floorstand without hardware.
- Patented Marty Mouse™ ears enable boxes to be secured in place with or without the plaster rings.
- Finish: Pre-galvanized.
- See Ruff-IN™ brochure for pre-fab box assemblies.

UPC/Part Number	Catalog Number	Box Center Height	Box Qty.
78205152944	BBF15	15" Floorstand	25
78205152945	BBF18	18" Floorstand	25
78205152946	BBF24	24" Floorstand	25
78205152947	BBFC	18" Floorstand	25
78205152948	BBF15C	15" Floorstand with Cable Clip	25
78205152949	BBF18C	18" Floorstand with Cable Clip	25
78205152950	BBF24C	24" Floorstand with Cable Clip	25

Patent #5595362
Patent #7956285 B2

*Read safety/installation instruction sheets in packages before use.
These products are designed for positioning only. No load rating.*

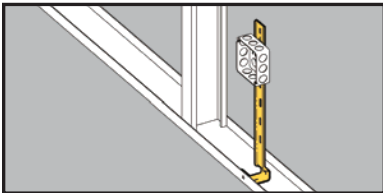

Floor Mounted Box Support



- See **BBF Series** for a better solution.
- Provides support for electrical box from floor track or concrete forms.
- 18" length with break-away feature for 12" or 16" box mounting.
- Finish: Pre-galvanized

UPC/Part Number	Catalog Number	Description	Box Qty.
78101103623	BB-18	Floor Mounted Box Support	50

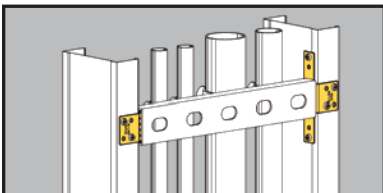

Strut Mounting Brackets



- Attaches 13/16" strut, 1 1/2" lathers channel, 1/2" EMT or 3/4" EMT to metal studs.
- Provides support for vertical runs of conduit.
- Finish: Pre-galvanized

UPC/Part Number	Catalog Number	Description	Box Qty.
78101101658	BMB1	Strut Mounting Bracket	25 pr.

Read safety/installation instruction sheets in packages before use. These products are designed for positioning only. No load rating.

Wall Studs

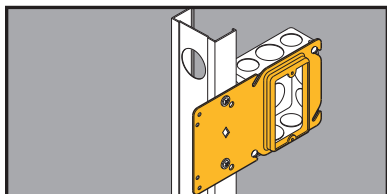

- Uni-Mount provides a secure support for 4" square boxes and features a built-in plaster ring.
- Rigid bracket design eliminates the need for far-side support.
- Enlarged viewing hole makes it easier to find mark lines on the stud.
- Gangable design accepts BB423 bracket to mount boxes on both sides of the stud.
- See Ruff-IN™ brochure for pre-fab box assemblies.
- Finish: Pre-galvanized

Uni-Mount™ Box Support/Cover Plate Mounting Bracket

Single Gang
BB40 Series



Double Gang
BB45 Series

UPC/Part Number	Catalog Number	Description	Box Qty.
78205122768	BB40-08	1/2" Raise	50
78205122771	BB40-10	5/8" Raise	50
78205122772	BB40-12	3/4" Raise	50
78205122773	BB45-08	1/2" Raise	50
78205122774	BB45-10	5/8" Raise	50
78205122775	BB45-12	3/4" Raise	50

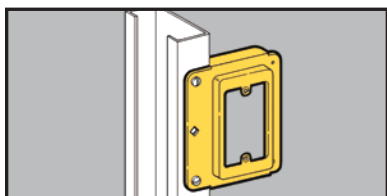

Cover Plate Mounting Bracket



- Provides attachment base for low voltage outlets.
- Replaces electrical box in Class 2 low voltage installations.
- Can be piggy-backed.
- For 1/2" and 5/8" drywall applications.
- Finish: Pre-galvanized

UPC/Part Number	Catalog Number	Description	Box Qty.
78101119873	BB15	Single Gang Stud Bracket	50

Read safety/installation instruction sheets in packages before use.
These products are designed for positioning only. No load rating.

Rapid Ring™ Self Adjusting Pre-Fab Ring

The Rapid Ring self-adjusting pre-fab plaster ring can help you win tight bids and beat the profit squeeze with its innovative 4-step installation. This revolutionary new pre-fab system installs in as little as 15 seconds per unit, compressing your project schedule, cutting operational costs and reducing onsite waste.

Because the Rapid Ring is a self-adjusting pre-fab ring, you'll never need to adjust a mud ring again. With a simple push of the Rapid Ring you're flush every time.



1. Remove protective plate.
2. Connect the wiring device.
3. Position the device assembly.
4. Push in the device assembly—and you're done!

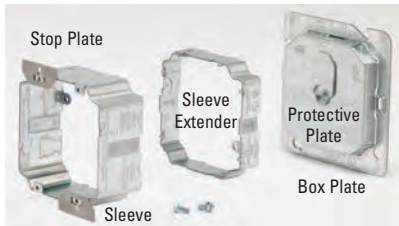

For Use With Wiring Device Qty.	Electrical Box ⁵	Box Plate ¹ Cat. No.	Sleeve ^{2,3} Cat. No.	Sleeve Extender ⁴ Cat. No.
1	4" sq.	B1RRP4C	B1RRR	B1RRE
1	4 ¹¹ / ₁₆ " sq.	B1RRP5C	B1RRR	B1RRE
2	4" sq.	B2RRP4C	B2RRR	B2RRE
2	4 ¹¹ / ₁₆ " sq.	B2RRP5C	B2RRR	B2RRE
3	3-gang ⁶	B3RRPC	B3RRR	B3RRE
4	4-gang ⁷	B4RRPC	B4RRR	B4RRE

1. Protective plate included with box plate.
2. Wall thickness range: 1/2" min. to 1 1/4" max.
3. Stop plates included with sleeve.
4. Sleeve extender is an optional accessory to extend max. wall thickness range to 2"
(order separately, mounting hardware included)
5. Minimum electrical box depth is 2 1/8"
6. Keyhole knockouts allow use on 2-gang electrical box.
7. Keyhole knockouts allow use on 3-gang electrical box.

Go to www.cooperbline.com/rapidring

*Read safety/installation instruction sheets in packages before use.
These products are designed for positioning only. No load rating.*

Wall Studs



- Supports horizontal runs of conduit, flexible conduit, MC or AC cable through metal studs.
- Attaches easily with a single sheet metal screw.
- Prevents conduit/cable rattling.

Conduit/Cable Supports

Wall Studs



BG-x-H7



BP-x-H7
(Not UL)



BX4-H7



BX4M-H7
(Not UL)



UPC/Part Number	Catalog Number	Conduit/Cable Size	Box Qty.
78101101228	BG-6-H7 *	3/8", MC, AC, or FMC	100
78101110238	BG-8-12-H7	1/2" or 3/4"	100
Patent #4958792			
78101101227	BP-8-H7	1/2" EMT	100
78101101226	BP-12-H7	3/4" EMT 1/2" IMC, Rigid	100
78101101200	BX4-H7	MC, AC, or FMC	100
78101101205	BX4M-H7	MC, AC, or FMC	100

* BG-6 will accept the following range $\varnothing.420 - \varnothing.675$:
14/2 thru 10/4 MC/AC cable and $5/16$ or $3/8$ flexible conduit

Read safety/installation instruction sheets in packages before use.
These products are designed for positioning only. No load rating.

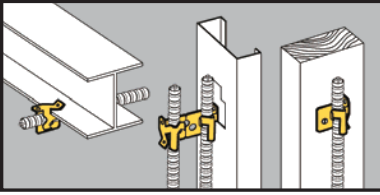

- Attaches MC, AC, sizes 14/2 through 10/3 or 3/8" FMC to studs or flanges up to 3/16" thick.
- Snaps into place on metal stud openings or may be screwed to metal or wood studs.
- BX4M may be snapped in half to make two BX4's.
- Allows cables to be positioned a minimum of 1 1/4" from face of stud as required by NEC Article 300.4(D).

Flexible Conduit/ Cable Fasteners



BX4M



BX4MD

UPC/Part Number	Catalog Number	Description	Box Qty.
78101101079	BX4	Single Runs	100
78101101080	BX4M	Double Runs	100
78101101224	BX4MD	Up to 4 Runs	100

*Read safety/installation instruction sheets in packages before use.
These products are designed for positioning only. No load rating.*

Wall Studs

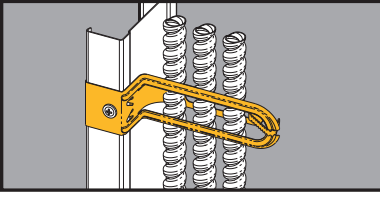

Cable Support



- Metal cable support can be used in plenum-rated areas.
- Longer locking tabs.
- Shipped pre-assembled.
- Hinge can be opened for greater cable capacity.
- Allows cables to be positioned a minimum of 1 1/4" from face of stud as required by NEC Article 300.4(D).

UPC/Part Number	Catalog Number	Description	Box Qty.
79903843761	BRC6M	Up to 3/4" FMC	100

Note: Canadian applications are limited to wood studs only.

Cable Size	Cable Type					
	Non-Metallic (NM)		Metal Clad (MC)		Armored Cable (AC)	
	Qty.	Dia.	Qty.	Dia.	Qty.	Dia.
14-2 w/ Grnd	8	.360	5	.439	5	.464
14-3 w/ Grnd	8	.307	5	.464	5	.483
14-4 w/ Grnd	8	.336	4	.494	4	.517
12-2 w/ Grnd	7	.410	5	.475	4	.498
12-3 w/ Grnd	8	.347	4	.505	4	.521
12-4 w/ Grnd	7	.381	4	.539	4	.557
10-2 w/ Grnd	6	.494	4	.542	4	.560
10-3 w/ Grnd	7	.422	4	.580	4	.588
10-4 w/ Grnd	NA	NA	3	.623	3	.632
8-2 w/ Grnd	4	.612	NA	NA	NA	NA
8-3 w/ Grnd	4	.565	NA	NA	NA	NA
6-2 w/ Grnd	4	.650	NA	NA	NA	NA
5/16 FMC			5 (.470 to .510 Dia.)			
3/8 FMC			4 (.560 to .610 Dia.)			
1/2 FMC			1 (.860 to .920 Dia.)			
3/4 FMC			1 (1.045 to 1.105 Dia.)			

The quantity of cables shown in the chart is the maximum. Fewer cables can be supported. Diameters are based on data from a leading cable manufacturer (may vary slightly). Diameters of some NM cables refer to the widest dimension of a flat cable. NA = Not applicable

Read safety/installation instruction sheets in packages before use. These products are designed for positioning only. No load rating.

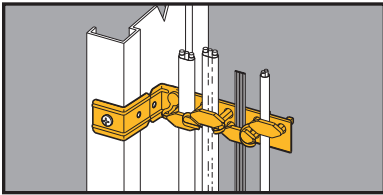

Staple-Lok™ Multi-Purpose Cable Support



- Individual plastic staples grip cable and reduce slipping.
- Secures up through #10 type NM cable.
- Supports AC, MC or FMC cable up to 1/2" O.D.
- Break-apart feature allows installation on studs and furring strips.
- Allows cables to be positioned a minimum of 1 1/4" from face of stud as required by NEC Article 300.4(D).

UPC/Part Number	Catalog Number	Cable Size	Box Qty.
78101103587	BRC4	Up to .500" O.D.	100

Patent #5587555

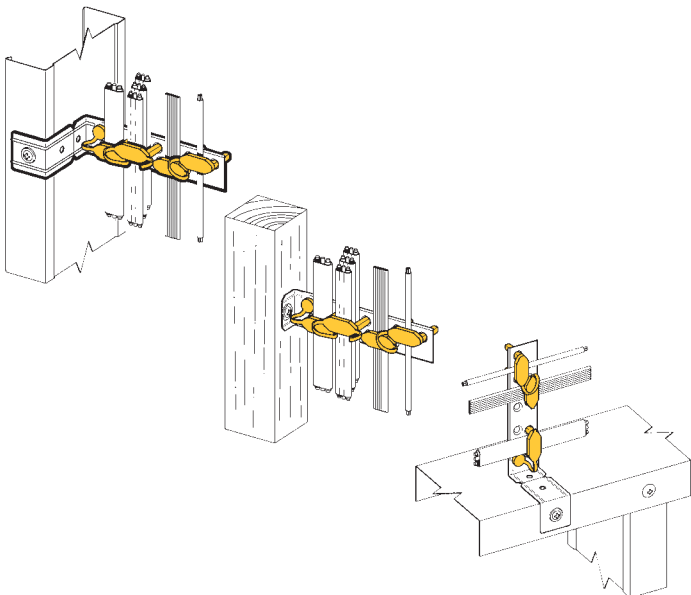

*Read safety/installation instruction sheets in packages before use.
These products are designed for positioning only. No load rating.*

Wall Studs

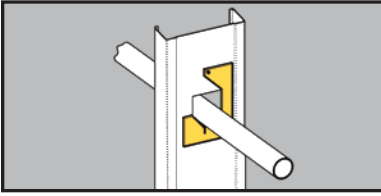

- Allows conduit, MC, AC, or FMC to be pulled through metal studs.
- Provides support for horizontal runs of conduit or cable through metal stud.
- Prevents rattling of conduit/cable.
- Finish: Pre-galvanized

Conduit/Cable Supports



UPC/Part Number	Catalog Number	Conduit/Cable Size	Box Qty.
78101101657	BX82	Up to 1"	100

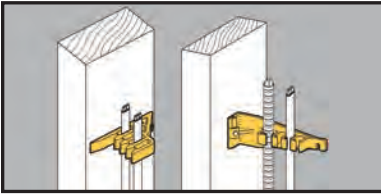

- Attaches Type NM cables to wood studs.
- Can be used to support computer, CATV, telephone, security and instrumentation cables.
- Provided with nail inserted.
- Allows cables to be positioned a minimum of 1 1/4" from face of stud as required by NEC Article 300.4(D).

Cable Fasteners



BRC1



BRC2

UPC/Part Number	Catalog Number	Description	Box Qty.
78101102941	BRC1	Wood Stud Cable Fastener	50
78101102941	BRC2	Furring Strip Cable Fastener	50

Read safety/installation instruction sheets in packages before use. These products are designed for positioning only. No load rating.

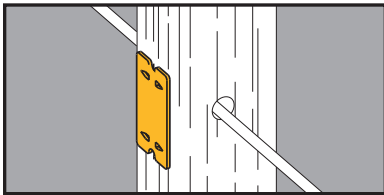

- Protects cable, plastic pipe and copper tubing from screw or nail penetration.
- Easily installed with a hammer.
- Complies with NEC Article 300-4.

Nail Plates For Wood Studs



UPC/Part Number	Catalog Number	Description	Box Qty.
78101104927	BM3	Nail Plate	100

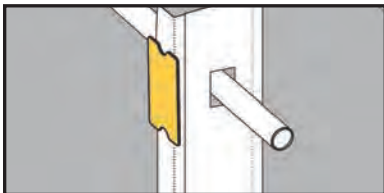

- Protects cable, plastic pipe and copper tubing from screw or nail penetration.
- Comes with industrial grade double stick tape on back for easy installation on stud.
- Complies with NEC Article 300-4.

Nail Plates For Metal Studs



Just Peel Tape and Stick To Stud

UPC/Part Number	Catalog Number	Description	Box Qty.
78101126251	BM3M	Nail Plate	100

Read safety/installation instruction sheets in packages before use. These products are designed for positioning only. No load rating.

Wall Studs

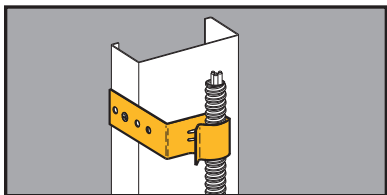

Conduit Support



BB38



BB38D

- Larger capacity: Redesigned BB38D attaches 1/2" to 1" EMT or flexible conduit to metal or wood studs.
- BB38 attaches MC/AC cable, 1/2" & 3/4" EMT to metal or wood studs.
- Eliminates the need for offset bending of conduit.
- Aligns conduit with standard box knockouts.

UPC/Part Number	Catalog Number	Box Depth	Box Qty.
78101104265	BB38	1 1/2"	100
78101195244	BB38D	2 1/8"	100

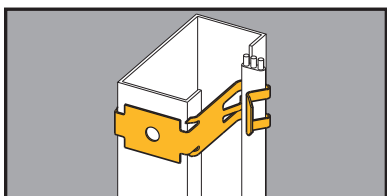

Flexible Conduit/Cable Fasteners



- Secures Romex^{®†} sizes 14/2 w/ground thru 12/3 w/ground, MC/AC sizes 14/2 thru 12/3 to metal or wood studs.
- Allows cables to be positioned a minimum of 1 1/4" from face of stud as required by NEC Article 300.4(D).

UPC/Part Number	Catalog Number	Description	Box Qty.
78101119755	BX5	Secures Flexible Conduit or Cable to Metal or Wood Studs	100

†Romex[®] is a registered trademark used by Southwire[®] Company, Carrollton, Georgia.

Read safety/installation instruction sheets in packages before use.
These products are designed for positioning only. No load rating.

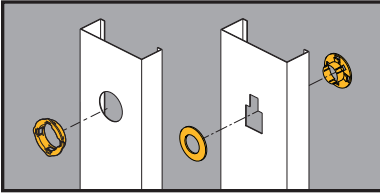

Metal Stud Grommet



- BM1 snaps into standard 1¹¹/₃₂" diameter holes in metal studs from 25 Ga. to 16 Ga.
- Redesigned BM2 is shipped as one piece and easily separated for installation.
- Universal BM2 provides 360° protection. Fits all factory punched metal stud holes.
- Protects wire insulation in accordance with NEC Article 300.4(B) (1).



BM1



BM2

UPC/Part Number	Catalog Number	Description	Box Qty.
78101119100	BM1	Plastic Grommet	100
78101119102	BM1M	Plastic Grommet (Bulk Quantity)	100
78101104926	BM2	Universal Plastic Grommet	100

Read safety/installation instruction sheets in packages before use. These products are designed for positioning only. No load rating.

Conduit & Cable



Conduit & Cable



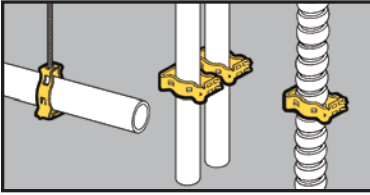

- Supports 3/8" to 2" conduit.
- Unique Guide-Rite Fastener provides for fast and easy installation with pliers.
- Now available in DURA-COPPER™ finish - add DCU to part number.
- Static Load Capacity:
100 Lbs. - Vertical
25 Lbs. - Horizontal

Guide-Rite™ Conduit Fasteners



Clearance Hole
For 1/4" Bolt

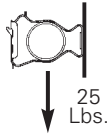

**Static
Load
Capacity**

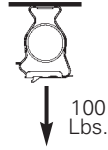

UPC/Part Number	Catalog Number	Conduit Size EMT/Rigid	Box Qty.
78101118350	BG-6*	3/8"	100
78101118355	BG-8-12	1/2", 3/4"	100
78101118360	BG-16	1"	100
78101118365	BG-20	1 1/4"	100
78101118360	BG-24	1 1/2"	100
78101118375	BG-32	2"	100



1/4"-20
Thread Impression



UPC/Part Number	Catalog Number	Conduit Size EMT/Rigid	Box Qty.
78101118380	BG-6-4T*	3/8"	100
78101118385	BG-8-12-4T	1/2", 3/4"	100
78101118390	BG-16-4T	1"	100
78101118395	BG-20-4T	1 1/4"	100
78101118400	BG-24-4T	1 1/2"	100
78101118405	BG-32-4T	2"	100

Patent #4958792

- * BG-6 and BG-6-4T will accept the following range $\varnothing.420 - \varnothing.675$:
1/2 thru 10/4 MC/AC cable and 5/16 or 3/8 flexible conduit

Read safety/installation instruction sheets in packages before use.

Conduit & Cable

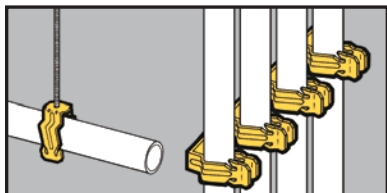

- Conduit easily snaps into push type fastener for secure support.
- Available with clearance hole for 1/4" bolt or 1/4"-20 thread impression.
- **Ultimate Static Load Capacity:**
25 Lbs. Vertical
15 Lbs. Horizontal

Push-Type Conduit Fasteners

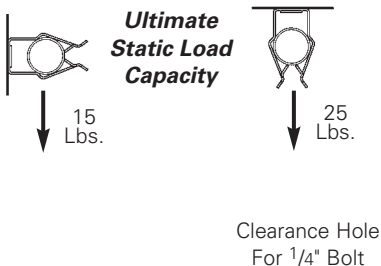

UPC/Part Number	Catalog Number	Conduit Size	Box Qty.
78101119200	BP-8	1/2" EMT	100
78101119205	BP-12	3/4" EMT 1/2" IMC, Rigid	100
78101119210	BP-16	1" EMT 3/4" IMC, Rigid	100

1/4"-20
Thread Impression



UPC/Part Number	Catalog Number	Conduit Size	Box Qty.
78101119215	BP-8-4T	1/2" EMT	100
78101119220	BP-12-4T	3/4" EMT 1/2" IMC, Rigid	100
78101119225	BP-16-4T	1" EMT 3/4" IMC, Rigid	100

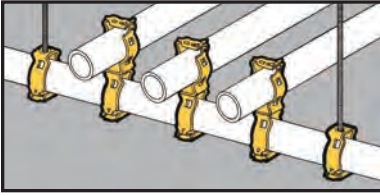

Guide-Rite™ Conduit Trapeze Fasteners



- For use with $\frac{3}{8}$ " to 2" conduit.
- Guide-Rite Fastener provides for fast and easy installation with pliers.



- Note: Total load of trapeze must not exceed 100 Lbs.

UPC/Part Number	Catalog Number	Conduit To 1" Trapeze	Box Qty.
78101118615	BG-16-G-6*	$\frac{3}{8}$ "	100
78101118620	BG-16-G-8-12	$\frac{1}{2}$ ", $\frac{3}{4}$ "	100
78101118595	BG-16-G-16	1"	100
78101118600	BG-16-G-20	$1\frac{1}{4}$ "	50
78101118605	BG-16-G-24	$1\frac{1}{2}$ "	50
78101118610	BG-16-G-32	2"	50

* BG-16-G-6 will accept the following range $\varnothing.420 - \varnothing.675$:
14/2 thru 10/4 MC/AC cable and $\frac{5}{16}$ or $\frac{3}{8}$ flexible conduit

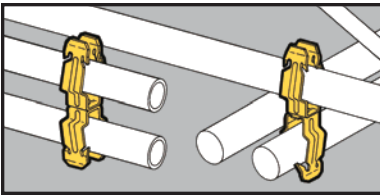

Push-Type Conduit To Conduit Fasteners

- An ideal spacer between conduits.
- No installation tools required.



- **Ultimate Static Load Capacity:** 25 Lbs.

UPC/Part Number	Catalog Number	Conduit Size	Box Qty.
78101118615	BP-8-P-8	$\frac{1}{2}$ " to $\frac{1}{2}$ "	100
78101118620	BP-8-P-12	$\frac{1}{2}$ " to $\frac{3}{4}$ "	100
78101118595	BP-8-P-16	$\frac{1}{2}$ " to 1"	100
78101118600	BP-12-P-12	$\frac{3}{4}$ " to $\frac{3}{4}$ "	100
78101118605	BP-12-P-16	$\frac{3}{4}$ " to 1"	100
78101118610	BP-16-P-16	1" to 1"	100

Note: For rigid conduit with BP series, use next size larger fastener ($\frac{1}{2}$ " Rigid use BP-12).

Read safety/installation instruction sheets in packages before use.

Conduit & Cable

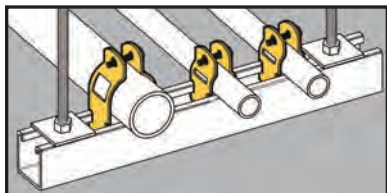

Break-Apart Conduit Clamps

- Patented Multi-Grip design fits Rigid, IMC or EMT conduit.
- Convenient break-apart clamp features retained bolt and $\frac{5}{16}$ " thread impression to eliminate handling of nuts and bolts.
- Finish: Pre-galvanized.
- Static Load Capacity: 200 lbs.



BPC-8 thru BPC-32

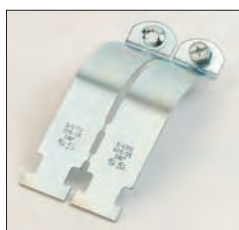

BPC-40 thru BPC-64



Static Load Capacity

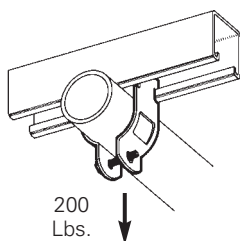

200
Lbs.

UPC/Part Number	Catalog Number	Rigid or EMT Conduit Size	Box Qty.
78101101676	BPC-8	1/2"	100
78101101677	BPC-12	3/4"	100
78101101680	BPC-16	1"	100
78101101679	BPC-20	1 1/4"	50
78101101678	BPC-24	1 1/2"	50
78101101681	BPC-32	2"	50
78101103977	BPC-40	2 1/2"	50
78101103978	BPC-48	3"	50
78101103979	BPC-56	3 1/2"	25
78101103981	BPC-64	4"	25

Patent #4044428

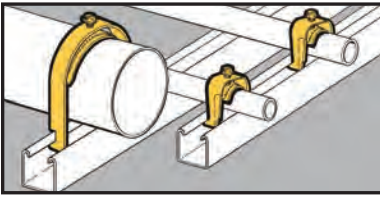

Conduit Strut Clamps



B1532S thru B1564S

B1506S
thru
B1524S



B1508
thru
B1520



- Attaches conduit, flexible conduit or cables to standard strut channels.
- B1506S designed to secure and support MC/AC cables.
- Unique one-piece design eliminates handling of hardware and allows easy installation and removal in side-by-side conduit runs.
- Anti-rock feature prevents clamp from disengaging during installation.
- Finish: Pre-galvanized

UPC/Part Number	Catalog Number	Conduit Size		OD Range Inches		Static Load Cap. Lbs.	Box Qty.
		EMT	Rigid	Min	Max		
78101163150	B1508	1/2"	–	–	–	200	100
78101163154	B1512	3/4"	1/2"	–	–	200	100
78101163157	B1516	1"	3/4"	–	–	300	100
78101163160	B1520	1 1/4"	1"	–	–	300	100
Note: Clamps without saddle are not recommended for flexible conduit or cable							
78205144495	B1506S*	3/8"*	–	.400	.630	200	100
78101163164	B1508S	1/2"	–	.250	.680	200	100
78101163168	B1512S	3/4"	1/2"	.500	.840	200	100
78101163171	B1516S	1"	3/4"	.750	1.050	300	100
78101163177	B1520S	1 1/4"	1"	1.125	1.315	300	100
78101163182	B1524S	1 1/2"	1 1/4"	1.375	1.660	400	50
78101163188	B1532S	2"	1 1/2"	1.875	2.200	400	50
78101163193	B1534S	–	2"	2.125	2.375	400	25
78101163199	B1540S	2 1/2"	2 1/2"	2.625	2.875	400	25
78101163205	B1548S	3"	3"	3.250	3.500	400	25
78101163211	B1556S	3 1/2"	3 1/2"	3.750	4.000	400	10
78101163215	B1564S	4"	4"	4.250	4.500	400	10

Patent #5022614

- * B1506S will accept the following
 AC Cable 14/2, 14/3, 14/4, 12/2, 12/3, 12/4, 10/2, 10/3, 10/4
 MC Cable 14/2, 14/3, 14/4, 12/2, 12/3, 12/4, 10/2, 10/3, 10/4

Read safety/installation instruction sheets in packages before use.

Conduit & Cable

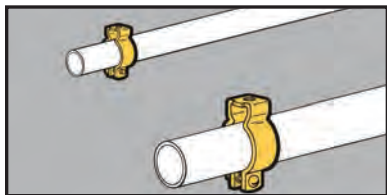

- For use with 1/2" thru 4" Conduit.
- Static Load Capacity: 400 lbs.
- Now available in DURA-COPPER™ finish - add DCU to part number.
- Finish: Zinc-Plated

Conduit Hangers



With Retained Bolt
And
Thread Impression



UPC/Part Number	Catalog Number	Trade Size	Conduit Size		Box Qty.
			EMT	Rigid	
78101119800	BL1400*	0	1/2"	1/2"	100
78101119801	BL1410*	1	3/4"	3/4"	100
78101119802	BL1420*	2	1"	1"	100



With Bolt And Nut



UPC/Part Number	Catalog Number	Trade Size	Conduit Size		Box Qty.
			EMT	Rigid	
78101119803	BL1425*	2.5	1 1/4"	--	100
78101119804	BL1430*	3	1 1/2"	1 1/4"	100
78101119805	BL1440†	4	--	1 1/2"	50
78101119806	BL1450†	5	2"	2"	50
78101119807	BL1460†	6	2 1/2"	2 1/2"	25
78101119808	BL1470†	7	3"	3"	25
78101119809	BL1480†	8	3 1/2"	3 1/2"	10
78101119810	BL1490†	9	4"	4"	10

* 9/32" mounting hole. † 11/32" mounting hole.

Read safety/installation instruction sheets in packages before use.

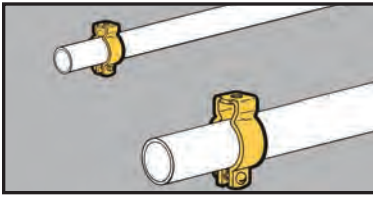

- For use with 1/2" thru 4" Conduit.
- Static Load Capacity: 400 lbs.
- Material: Type 304 Stainless Steel

Stainless Steel Conduit Hangers



With Bolt And Nut

UPC/Part Number	Catalog Number	Trade Size	Conduit Size		Box Qty.
			EMT	Rigid	
78101119800	BL1400-SS4*	0	1/2"	1/2"	100
78101119801	BL1410-SS4*	1	3/4"	3/4"	100
78101119802	BL1420-SS4*	2	1"	1"	100
78101119803	BL1425-SS4*	2.5	1 1/4"	–	100
78101119804	BL1430-SS4*	3	1 1/2"	1 1/4"	100
78101119805	BL1440-SS4†	4	–	1 1/2"	50
78101119806	BL1450-SS4†	5	2"	2"	50
78101119807	BL1460-SS4†	6	2 1/2"	2 1/2"	25
78101119808	BL1470-SS4†	7	3"	3"	25
78101119809	BL1480-SS4†	8	3 1/2"	3 1/2"	10
78101119810	BL1490-SS4†	9	4"	4"	10

* 9/32" mounting hole. † 1 1/32" mounting hole.

Read safety/installation instruction sheets in packages before use.

Conduit & Cable

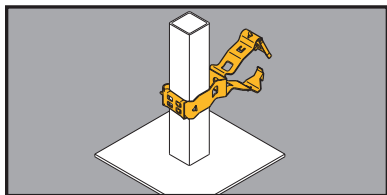

Guide-Rite™ Conduit To Pedestal Support

- Supports conduit from square computer floor pedestals.
- Unique Guide-Rite Fastener provides for fast and easy installation with pliers.
- Static Load Capacity: 25 lbs.



UPC/Part Number	Catalog Number	Conduit Size EMT/Rigid	Box Qty.
78205125589	BG-8-12-G6*	3/8"	100
78101188538	BG-8-12-G812	1/2" or 3/4"	100
78101118620	BG-16-G-8-12	1"	100
78205125594	BG-8-12-G20	1 1/4"	50
78205125595	BG-8-12-G24	1 1/2"	50
78205125597	BG-8-12-G32	2"	50

Patent #4958792

- * BG-8-12-G6 will accept the following range \varnothing .420 - \varnothing .675: 14/2 thru 10/4 MC/AC cable and 5/16 or 3/8 flexible conduit

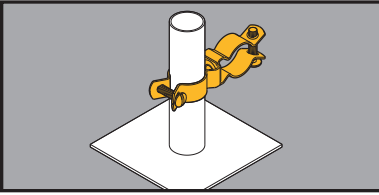

Conduit To Pedestal Support

- Supports conduit from 1" O.D. computer floor pedestals.
- Also available in Type 304 Stainless Steel. Contact factory for details.
- Static Load Capacity: 25 lbs.
- Finish: Zinc-Plated



UPC/Part Number	Catalog Number	Trade Size	Conduit Rigid	Size EMT	Box Qty.
78205125599	BL1410-L1400	0	1/2"	1/2"	50
78205125601	BL1410-L1410	1	3/4"	3/4"	50
78205125602	BL1410-L1420	2	1"	1"	50
78205125603	BL1410-L1425	2.5	–	1 1/4"	50
78205125607	BL1410-L1430	3	1 1/4"	1 1/2"	50
78205125612	BL1410-L1440	4	1 1/2"	–	25
78205125614	BL1410-L1450	5	2"	2"	25
78205125617	BL1410-L1460	6	2 1/2"	2 1/2"	10
78205125618	BL1410-L1470	7	3"	3"	10
78205125619	BL1410-L1480	8	3 1/2"	3 1/2"	5

Read safety/installation instruction sheets in packages before use.

Conduit & Cable

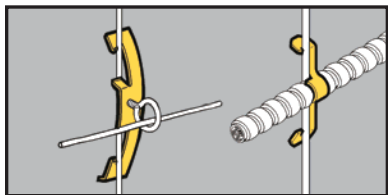

- BW2 and BW6 support #10-24 or 1/4"-20 threaded bridle rings and provide attachment for electrical boxes.
- BW2S & BW6S are provided with one each 1/4"-20 x 3/8" screw and hex nut.
- BW4 supports cables from #12 thru #8 wire.

Rod & Wire Fasteners



UPC/Part Number	Catalog Number	Drop Rod/ Wire Size	Flange Thickness	Box Qty.
78101119700	BW2	#12 wire thru 1/4" plain or threaded rod	1/8" - 3/8"	100
78205140156	BW2S	#12 wire thru 1/4" plain or threaded rod	1/8" - 3/8"	100
78101195516	BW6	3/8" plain or threaded rod	3/8" - 7/16"	100
78205140157	BW6S	3/8" plain or threaded rod	3/8" - 7/16"	100

Conduit & Cable

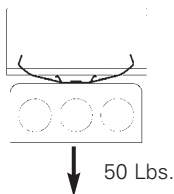

**Static Load
Capacity**



UPC/Part Number	Catalog Number	Description	Box Qty.
78101119705	BW4	Multi-size Wire Fastener	100



MC/AC Cable Size	#12 Wire	#10 Wire	#8 & #9 Wire
14/2 Cable	BW4	BW4	BW4
14/3 Cable	BW4	BW4	BW4
12/2 Cable	BW4	BW4	BW4
12/3 Cable	BW4	BW-8	BW-8

BW4 is designed for positioning only. No load rating.

Note: An independent means of support is required by NEC Article 300.11. Refer to pages 225-226 for additional support methods.

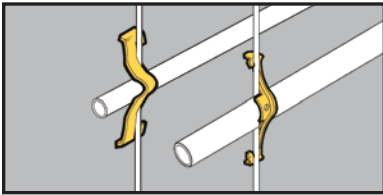

- See BX8 and BX18 for a better solution.
- Attaches conduit to wire rods or flanges.
- Can be used for flexible metallic tubing or armored cable.

Rod & Wire Fasteners



BW-8



BW-16



UPC/Part Number	Catalog Number	Box Qty.
78101119710	BW-8	100
78101119715	BW-12	100
78101119720	BW-16	100
78101119725	BW-20	100

Conduit Size	#10 & #12 Wire	#8 & #9 Wire	3/16" & 1/4" Rod	1/8" to 1/4" Flange	5/16" to 3/8" Flange	7/16" to 1/2" Flange
1/2" EMT	BW-8	BW-8	BW-8	BW-8	BW-12	BW-12
1/2" Rigid	BW-8	BW-12	BW-12	BW-12	BW-12	BW-16
3/4" EMT	BW-12	BW-12	BW-12	BW-12	BW-16	BW-16
3/4" Rigid	BW-12	BW-12	BW-16	BW-16	BW-20*	BW-20*
1" EMT	—	BW-16	BW-16	BW-16	BW-20*	BW-20*
1" Rigid	—	—	—	BW-20*	BW-20*	BW-20*
1 1/4" EMT	—	BW-20	BW-20	BW-20	—	—

*Note: For horizontal applications only.

Static Load Capacity

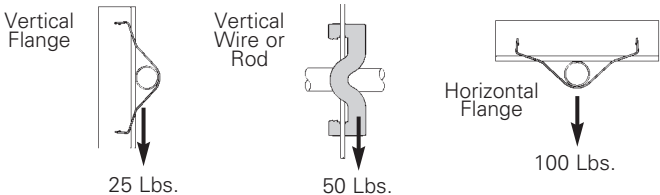

Note: An independent means of support is required by NEC Article 300.11. Refer to pages 225-226 for additional support methods.

Read safety/installation instruction sheets in packages before use.

Conduit & Cable

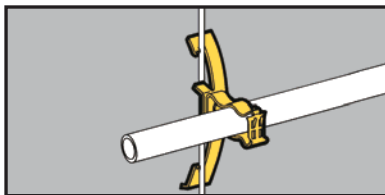

- Assemblies support 1/2", 3/4" and 1" conduit.
- W2 series attaches to 1/8" thru 3/8" flanges or #12 wire thru 1/4" plain or threaded rod.
- W6 series attaches to 3/8" thru 7/16" flanges or 3/8" plain or threaded rod.

Guide-Rite™ Conduit To Rod Fasteners



UPC/Part Number	Catalog Number	Conduit Size EMT/Rigid	Box Qty.
78101118540	BG-8-12-W2	1/2", 3/4"	100
78101118640	BG-16-W2	1"	100
78101195519	BG-8-12-W6	1/2", 3/4"	100
78101195520	BG-16-W6	1"	100

Patent #4958792

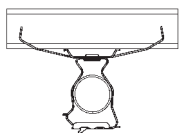

50 Lbs.

**Static Load
Capacity**

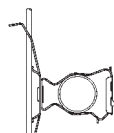

25 Lbs.

Note: An independent means of support is required by NEC Article 300.11. Refer to pages 225-226 for additional support methods.

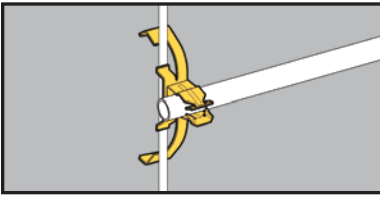

Push-Type Conduit To Rod Fasteners

- Assemblies support 1/2", 3/4" and 1" conduit.
- W2 series attaches to 1/8" thru 3/8" flanges or #12 wire thru 1/4" plain or threaded rod.
- W6 series attaches to 3/8" thru 7/16" flanges or 3/8" plain or threaded rod.



UPC/Part Number	Catalog Number	Conduit Size	Box Qty.
78101119325	BP-8-W2	1/2" EMT	100
78101119420	BP-12-W2	3/4" EMT or 1/2" IMC. Rigid	100
78101119505	BP-16-W2	1" EMT or 3/4" IMC, Rigid	100
78101195521	BP-8-W6	1/2" EMT	100
78101195522	BP-12-W6	3/4" EMT or 1/2" IMC. Rigid	100
78101195523	BP-16-W6	1" EMT or 3/4" IMC, Rigid	100

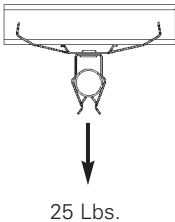

Ultimate Static Load Capacity

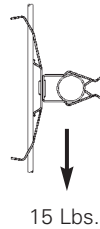

Note: An independent means of support is required by NEC Article 300.11. Refer to pages 225-226 for additional support methods.

Conduit & Cable

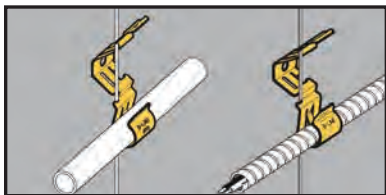

Flex-Rite™ Cable/Conduit To Wire Fasteners



- Can be used in place of batwings.
- Will not bend or deform hanger wire.
- Attaches to #12 - #8 wire and 1/4" plain rod.
- Accommodates MC, AC, 3/8" FMC or 1/2" EMT.
- Cable can be installed before or after attachment to wire.
- Static Load Capacity:
BX-8 - 20 Lbs.
BX-18 - 30 Lbs.

UPC/Part Number	Catalog Number	Cable/Conduit Size	Box Qty.
78101101402	BX-8	.375" to 706" O.D.	100
78101102943	BX-18	.706" to 1.380" O.D.	100
78101101685	BX-8B	Bulk Packed In Fiber Barrels	4000

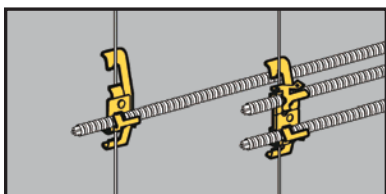

Cable To Rod Fasteners



BX4-W2



- Assemblies support MC, AC, sizes 14/2 through 10/3 or 3/8 FMC.
- W2 series attaches to 1/8" thru 3/8" flanges or #12 wire thru 1/4" plain or threaded rod.
- W6 series attaches to 3/8" thru 7/16" flanges or 3/8" plain or threaded rod.

BX4M-W2

UPC/Part Number	Catalog Number	Description	Box Qty.
78101101219	BX4-W2	Single Runs	100
78101101189	BX4M-W2	Double Runs	100
78101195517	BX4-W6	Single Runs	100
78101195518	BX4M-W6	Double Runs	100

Read safety/installation instruction sheets in packages before use.

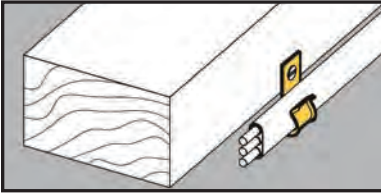

Cable Fasteners



- Attaches Type NM cable to most structures.
- Supports cable sizes 14/2 and 12/2 with ground wire.
- May be used with other B-Line fasteners for attachment to acoustical tees, beams, drop wires, etc.

UPC/Part Number	Catalog Number	Description	Box Qty.
78101103553	BRC3	Type NM Cable Fastener	100

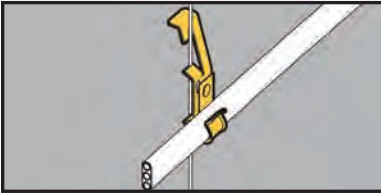

Cable Fasteners



- Supports cable sizes 14/2 and 12/2 with ground wire.
- W2 series supports cable from #12 wire thru 1/4" plain or threaded rod.
- W6 series supports cable from 3/8" plain or threaded rod.

UPC/Part Number	Catalog Number	Description	Box Qty.
78101103547	BRC3-W2	Type NM Cable To Wire Fastener	100
78101195524	BRC3-W6	Type NM Cable To Wire Fastener	100

Read safety/installation instruction sheets in packages before use.
These products are designed for positioning only. No load rating.

Conduit & Cable

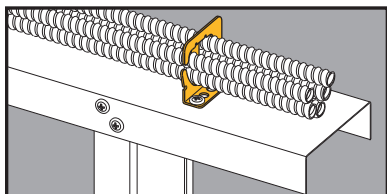

Multi-Run Cable Carrier for MC/AC Cable

- Secures and supports multiple runs of MC/AC cable as required by the NEC.
- Effectively organizes cables and eliminates derating issues.
- Retention tab is open for easy loading and unloading and contains cables when bent in place.
- Compatible with new BCH-HBA for multi tier assemblies.
- Load Capacity: 50 lbs.
- Finish: Zinc Plated



BRC5-1



BRC5-2



BRC5-3



UPC/Part Number	Catalog Number	Cable Diameter & Number Of Runs	Box Qty.
78205143593	BRC5-1	.430" to .560" Up To 4 Runs	50
78205143594	BRC5-2	.430" to .560" Up To 9 Runs	50
78205143595	BRC5-3	.560" to .690" Up To 7 Runs	50

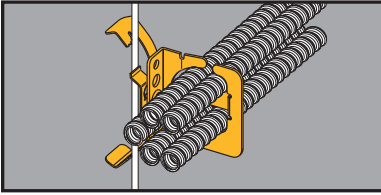

Multi-Run Cable Carrier for MC/AC Cable



- Secures and supports multiple runs of MC/AC cable as required by the NEC.
- W2 Series attaches to 1/8" thru 3/8" flanges or #12 thru 1/4" plain or threaded rod.
- W6 Series attaches to 3/8" thru 7/16" flanges or 3/8" plain or threaded rod.
- Load Capacity: 50 lbs.
- Finish: Zinc Plated



UPC/Part Number	Catalog Number	Cable Diameter & Number Of Runs	Box Qty.
78205144075	BRC51-W2	.430" to .560" Up To 4 Runs	25
78205144076	BRC52-W2	.430" to .560" Up To 9 Runs	25
78205144077	BRC53-W2	.560" to .690" Up To 7 Runs	25
78205144078	BRC51-W6	.430" to .560" Up To 4 Runs	25
78205144079	BRC52-W6	.430" to .560" Up To 9 Runs	25
78205144080	BRC53-W6	.560" to .690" Up To 7 Runs	25

Note: An independent means of support is required by NEC Article 300.11. Refer to pages 225-226 for additional support methods.

Read safety/installation instruction sheets in packages before use.
These products are designed for positioning only. No load rating.

Conduit & Cable

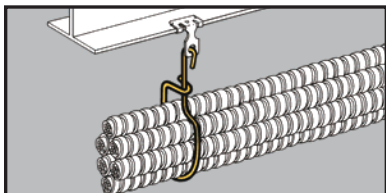

- Designed to support multiple runs of MC, AC, FMC or communication cable.
- Static Load Capacity:
BX2 - 50 lbs.
BX6 & BX24 - 75 Lbs.
- Finish: Zinc Plated

Flexible Cable Support

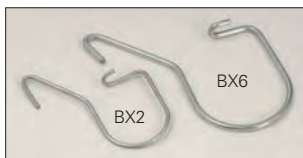

UPC/Part Number	Catalog Number	Description	Box Qty.
78205104934	BX2	Usable Area = 2 sq. in.	100
78205119765	BX6	Usable Area = 4 sq. in.	100
78205119766	BX24	Usable Area = 13 sq. in.	100

Conduit & Cable

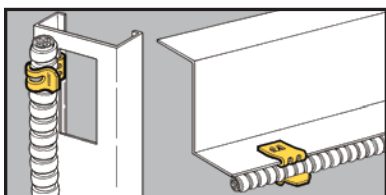

- Fastens flexible conduit and other small cables to beam flanges, bar joists or metal studs.
- Cable O.D. range of 0.42" to 0.70".
- Maximum flange thickness $5/32"$.

Flexible Conduit/Cable Fasteners



UPC/Part Number	Catalog Number	Description	Box Qty.
78101119770	BX9	Flexible Conduit Fastener	100

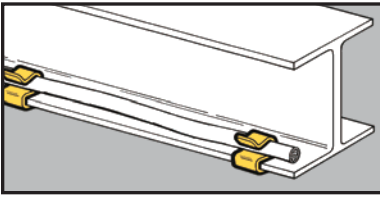

Flexible Conduit/ Cable Fasteners

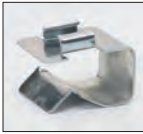

BFA Series
(For Use with
BXS Series
Only)



BXS
Series



BXL
Series

- Secures cable along flanges 1/16" to 3/4" thick.
- The BFA flange adapters attach BXS series to thicker flanges.
- BX_-67 accepts 14/2, 12/2 & 10/2 romex with ground.
- BX_-1011 accepts 14/2, 12/2 & 10/2 romex with ground.
- BX_-1214 accepts 10/3, romex with ground.
- Finish: Zinc Plated

UPC/Part Number	Catalog Number	Flange Thickness	Cable Diameter	Box Qty.
78101119973	BXS-67	1/16" - 5/32"	.218 to .281	100
78101119974	BXS-89	1/16" - 5/32"	.290 to .375	100
78101119975	BXS-1011	1/16" - 5/32"	.375 to .437	100
78101119976	BXS-1214	1/16" - 5/32"	.444 to .560	100
78101119977	BXS-1519	1/16" - 5/32"	.500 to .718	100
78101119978	BXS-2024	1/16" - 5/32"	.748 to .945	100
78101119979	BXS-2530	1/16" - 5/32"	.968 to 1.250	100
78101119980	BXM-67	5/32" - 9/32"	.218 to .281	100
78101119981	BXM-89	5/32" - 9/32"	.290 to .375	100
78101119982	BXM-1011	5/32" - 9/32"	.375 to .437	100
78101119983	BXM-1214	5/32" - 9/32"	.444 to .560	100
78101119984	BXM-1519	5/32" - 9/32"	.500 to .718	100
78101119985	BXM-2024	5/32" - 9/32"	.748 to .945	100
78101119986	BXM-2530	5/32" - 9/32"	.968 to 1.250	100
78101119987	BXL-67	5/16" - 1/2"	.218 to .281	100
78101119988	BXL-89	5/16" - 1/2"	.290 to .375	100
78101119989	BXL-1011	5/16" - 1/2"	.375 to .437	100
78101119990	BXL-1214	5/16" - 1/2"	.444 to .560	100
78101119991	BXL-1519	5/16" - 1/2"	.500 to .718	100
78101119992	BXL-2024	5/16" - 1/2"	.748 to .945	100
78101119993	BXL-2530	5/16" - 1/2"	.968 to 1.250	100
78101119955	BFA-1215	1/2" - 5/8"	-	100
78101119956	BFA-1520	5/8" - 3/4"	-	100

Read safety/installation instruction sheets in packages before use.
These products are designed for positioning only. No load rating.

Conduit & Cable

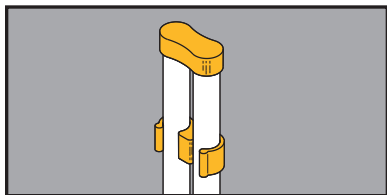

Conduit Quick Caps & Spacers



BCS & BES
8 & 8C thru 16 & 16C



BCS 18, 18C, 20, & 20C



BCS 12AS & 16AS

- Quick caps and spacers eliminate the time consuming method of duct taping conduit stubs.
- Quick spacers are designed to separate and secure conduit during concrete pours.
- Quick caps maintain spacing and keep conduit free from dirt and debris.
- Quick caps and spacers properly space conduit for any 4" square box.
- Available in EMT & Rigid conduit sizes.

UPC/Part Number	Catalog Number	Conduit Size	Box Qty.
Conduit Spacer			
78205122356	BCS-8	1/2" Rigid Conduit	50
78205140057	BES-8	1/2" EMT Conduit	50
78205122357	BCS-12	3/4" Rigid Conduit	50
78205140058	BES-12	3/4" EMT Conduit	50
78205122358	BCS-16	1" Rigid Conduit	50
78205140059	BES-16	1" EMT Conduit	50
79903855806	BCS-18	1 1/2" Rigid Conduit	25
79903855807	BCS-20	2" Rigid Conduit	25
Conduit Cap			
78205122359	BCS-8C	1/2" Rigid Conduit	50
78205140060	BES-8C	1/2" EMT Conduit	50
78205122361	BCS-12C	3/4" Rigid Conduit	50
78205140061	BES-12C	3/4" EMT Conduit	50
78205122362	BCS-16C	1" Rigid Conduit	50
78205140062	BES-16C	1" EMT Conduit	50
79903855803	BCS-18C	1 1/2" Rigid Conduit	25
79903855805	BCS-20C	2" Rigid Conduit	25
Conduit Spacer			
79903855808	BCS-12AS	3/4" Rigid Conduit	50
79903855809	BCS-16AS	1" Rigid Conduit	25

Patent #5896892

Read safety/installation instruction sheets in packages before use.
These products are designed for positioning only. No load rating.

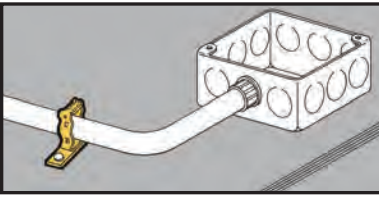

- Eliminates the need for offset bends when used with 1 1/2" deep boxes.
- Attaches conduit to concrete, steel or wood with nails.
- May be attached after conduit positioning.

Conduit Spacer Brackets



BG



BP

UPC/Part Number	Catalog Number	Conduit Size	Box Qty.
78101118495 Patent # 4958792	BG-8-12-D3	1/2" or 3/4"	100
78101119265	BP-8-D3	1/2" EMT	100
78101118365	BP-12-D3	3/4" EMT or 1/2" IMC, Rigid	100

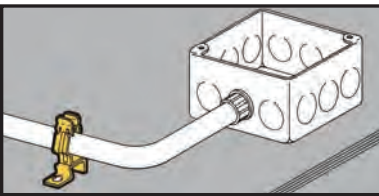

- Eliminates the need for offset bends when used with 2 1/8" deep boxes.
- Provides secure support between conduit and deck.
- D4 Series is easily installed with screw gun or powder actuated tools.
- Allows for complete conduit layout prior to anchoring.

Conduit Spacer Brackets



BG



BP

UPC/Part Number	Catalog Number	Conduit Size	Box Qty.
78101118500 Patent # 4958792	BG-8-12-D4	1/2" or 3/4"	100
78101119270	BP-8-D4	1/2" EMT	100
78101119370	BP-12-D4	3/4" EMT or 1/2" IMC, Rigid	100
78101119460	BP-16-D4	1" EMT or 3/4" IMC, Rigid	100

Read safety/installation instruction sheets in packages before use.

Conduit & Cable

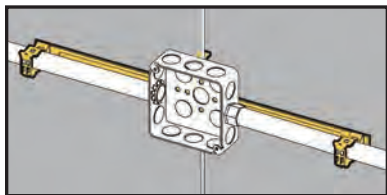

Guide-Rite™ Conduit & Box Support Fasteners



- See pages Ruff-IN™ brochure for pre-fab box assemblies.

- New BMC3 plate is available to support multiple conduit runs.
- Riveted assembly provides support for electrical boxes and conduit runs on either side of the box.
- Reduces drop wires by 66% when using W2/W6 assemblies.
- Assemblies using BMC3 plate include center conduit clip. Additional conduit clips may be purchased separately.

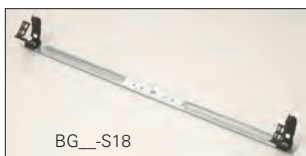

UPC/Part Number	Catalog Number	Conduit Size EMT & Rigid	Box Qty.
78101103575	BG6-S18 *	3/8"	25
78101103573	BG812-S18	1/2" or 3/4"	25
78101103574	BG16-S18	1"	25

With Multiple Conduit Plate

78205152812	BG6-S18-MC3 *	3/8"	25
78205152900	BG812-S18-MC3	1/2" or 3/4"	25
78205152901	BG16-S18-MC3	1"	25

Patent # 4958792

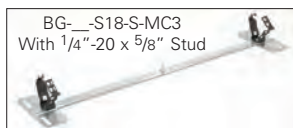
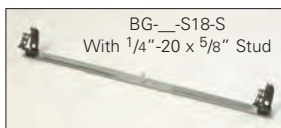

With Stud

78205152902	BG6-S18S *	3/8"	25
78110104979	BG812-S18S	1/2" or 3/4"	25
78205152903	BG16-S18S	1"	25

With Stud & Multiple Conduit Plate

78205152904	BG6-S18S-MC3 *	3/8"	25
78205152905	BG812-S18S-MC3	1/2" or 3/4"	25
78205152906	BG16-S18S-MC3	1"	25

Conduit & Cable



UPC/Part Number	Catalog Number	Conduit Size EMT & Rigid	Box Qty.
W2 Series for #12 thru 1/4" Rod **			
78101103578	BG6-S18-W2 *	3/8"	25
78101103577	BG812-S18-W2	1/2" or 3/4"	25
78101103577	BG16-S18-W2	1"	25
W2 Series for #12 thru 1/4" Rod & Multiple Conduit Plate **			
78205152855	BG6-S18-W2-MC3 *	3/8"	25
78205152739	BG812-S18-W2-MC3	1/2" or 3/4"	25
78205152862	BG16-S18-W2-MC3	1"	25
W6 Series for 3/8" Plain or Threaded Rod **			
78110199581	BG6-S18-W6 *	3/8"	25
78110199582	BG812-S18-W6	1/2" or 3/4"	25
78110199580	BG16-S18-W6	1"	25
W6 Series for 3/8" Plain or Threaded Rod & Multiple Conduit Plate **			
78205152856	BG6-S18-W6-MC3 *	3/8"	25
78205152860	BG812-S18-W6-MC3	1/2" or 3/4"	25
78205152864	BG16-S18-W6-MC3	1"	25

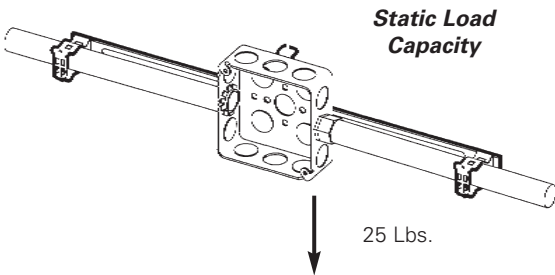

- * BG-6 will accept the following range $\varnothing.420 - \varnothing.675$:
14/2 thru 10/4 MC/AC cable and 5/16" or 3/8" flexible conduit
- ** Note: An independent means of support is required by NEC Article 300.11. Refer to pages 225-226 for additional support methods.

Read safety/installation instruction sheets in packages before use.

Conduit & Cable

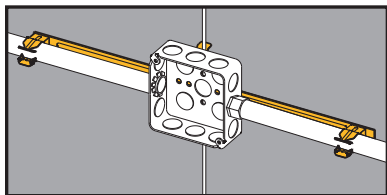

Push-Type Conduit & Box Support Fasteners

- See pages Ruff-IN™ brochure for pre-fab box assemblies.

- New BMC3 plate is available to support multiple conduit runs.
- Riveted assembly provides support for electrical boxes and conduit runs on either side of the box.
- Reduces drop wires by 66% when using W2/W6 assemblies.
- Assemblies using BMC3 plate include center conduit clip. Additional conduit clips may be purchased separately.



UPC/Part Number	Catalog Number	Conduit Size (EMT) R(Rigid)	Box Qty.
78205123604	BP8-S18	1/2" E	25
78205123605	BP12-S18	3/4" E or 1/2" R	25
78205123606	BP16-S18	1"E, 3/4" R	25

With Multiple Conduit Plate

78205152907	BP8-S18-MC3	1/2" E	25
78205152908	BP12-S18-MC3	3/4" E or 1/2" R	25
78205152909	BP16-S18-MC3	1"E, 3/4" R	25

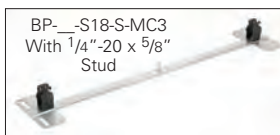
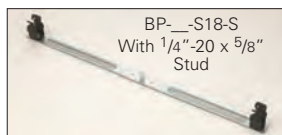

With Stud

78205123631	BP8-S18S	1/2" E	25
78205123633	BP12-S18S	3/4" E or 1/2" R	25
78205123634	BP16-S18S	1"E, 3/4" R	25

With Stud & Multiple Conduit Plate

78205152913	BP8-S18S-MC3	1/2" E	25
78205152914	BP12-S18S-MC3	3/4" E or 1/2" R	25
78205152915	BP16-S18S-MC3	1"E, 3/4" R	25

Conduit & Cable

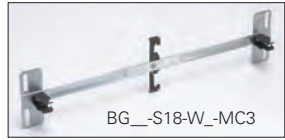

UPC/Part Number	Catalog Number	Conduit Size E(EMT) R(Rigid)	Box Qty.
W2 Series for #12 thru 1/4" Rod **			
78205123615	BP8-S18-W2	1/2" EMT	25
78205123619	BP12-S18-W2	3/4" E or 1/2" R	25
78205123627	BP16-S18-W2	1"E, 3/4" R	25
W2 Series for #12 thru 1/4" Rod & Multiple Conduit Plate **			
78205152847	BP8-S18-W2-MC3	1/2" EMT	25
78205152848	BP12-S18-W2-MC3	3/4" E or 1/2" R	25
78205152849	BP16-S18-W2-MC3	1"E, 3/4" R	25
W6 Series for 3/8" Plain or Threaded Rod **			
78205123628	BP8-S18-W6	1/2" EMT	25
78205123629	BP12-S18-W6	3/4" E or 1/2" R	25
78205123630	BP16-S18-W6	1"E, 3/4" R	25
W6 Series for 3/8" Plain or Threaded Rod & Multiple Conduit Plate **			
78205152850	BP8-S18-W6-MC3	1/2" EMT	25
78205152851	BP12-S18-W6-MC3	3/4" E or 1/2" R	25
78205152854	BP16-S18-W6-MC3	1"E, 3/4" R	25

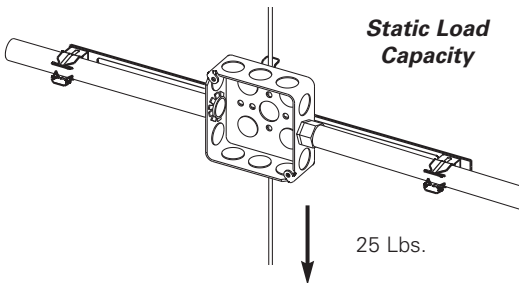

** Note: An independent means of support is required by NEC Article 300.11. Refer to pages 225-226 for additional support methods.

Read safety/installation instruction sheets in packages before use.

Conduit & Cable

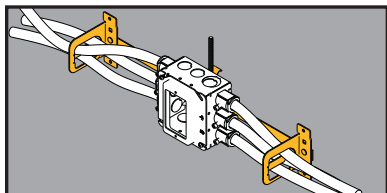

Multi-Run Cable Carrier & Box Support Fasteners



- Riveted assembly provides support for electrical boxes and cable runs on either side of the box.
- Reduces drop wires by 66% when using W2/W6 assemblies.
- Cable retention tab is open for easy loading and contains the cables when bent in place.
- See Ruff-IN™ brochure for pre-fab box assemblies.



Conduit & Cable

UPC/Part Number	Catalog Number	Conduit Size	Box Qty.
78205152916	BRC51-S18	Up to 4 runs .430" - .560"	25
78205152918	BRC53-S18	Up to 7 runs .560" - .690"	25

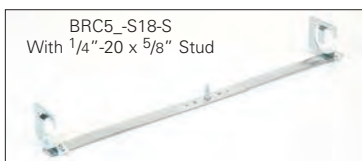

UPC/Part Number	Catalog Number	Conduit Size	Box Qty.
With Stud			
78205152919	BRC51-S18S	Up to 4 runs .430" - .560"	25
78205152921	BRC53-S18S	Up to 7 runs .560" - .690"	25

Read safety/installation instruction sheets in packages before use.

Conduit & Cable

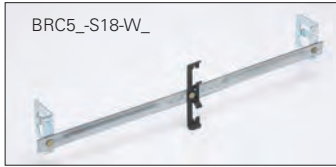

UPC/Part Number	Catalog Number	Conduit Size	Box Qty.
W2 Series for #12 thru 1/4" Rod **			
78205152865	BRC51-S18-W2	Up to 4 runs .430" - .560"	25
78205152869	BRC53-S18-W2	Up to 7 runs .560" - .690"	25

UPC/Part Number	Catalog Number	Conduit Size	Box Qty.
W6 Series for 3/8" Plain or Threaded Rod **			
78205152866	BRC51-S18-W6	Up to 4 runs .430" - .560"	25
78205152870	BRC53-S18-W6	Up to 7 runs .560" - .690"	25

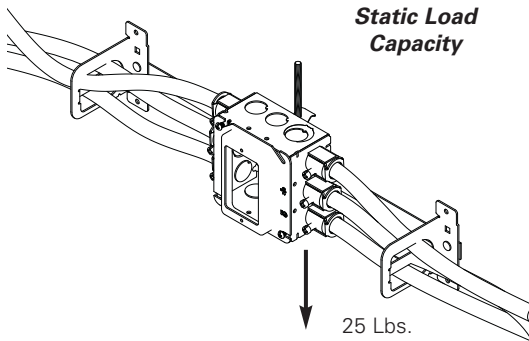

** Note: An independent means of support is required by NEC Article 300.11. Refer to pages 225-226 for additional support methods.

Read safety/installation instruction sheets in packages before use.

Acoustical Tee

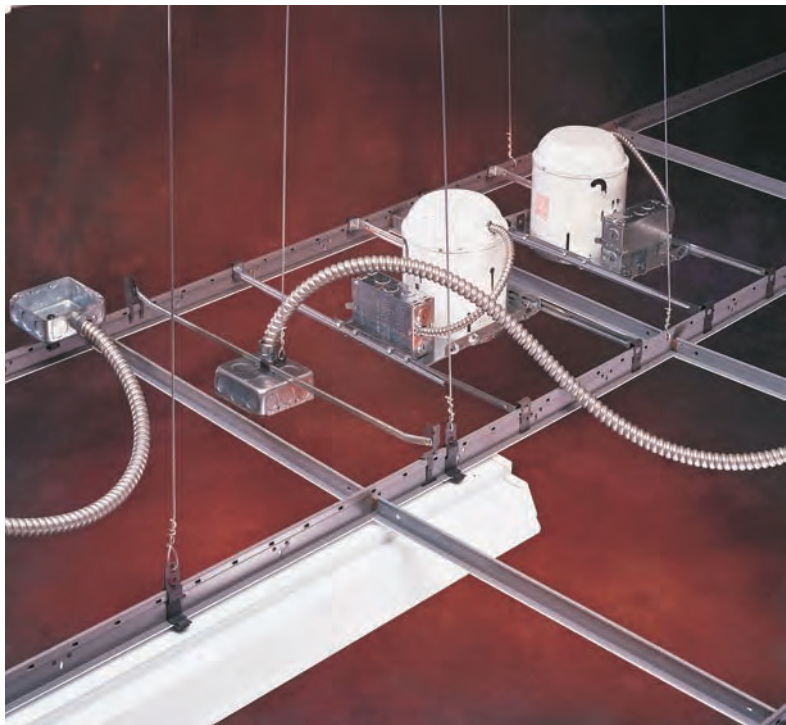

Acoustical Tee

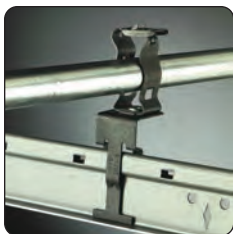

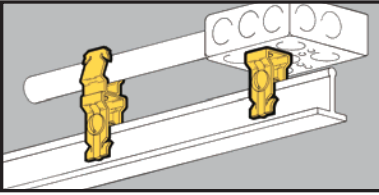

T-Bar Support Fasteners



- Attaches to top of acoustical T-Bar with 1/4"-20 screw.
- Has 1/4"-20 thread impression for attachment to box or conduit fastener.
- **Warning:** Do not use for hanging acoustical tee.

UPC/Part Number	Catalog Number	Description	Box Qty.
78101118090	BA14	T-Bar Support Clip	100

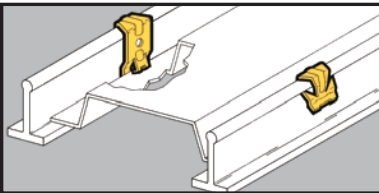

Troffer Fasteners



- Gives positive support for troffers and lay-in fixtures.
- Complies with NEC Article 410.16(C) for fixtures supported by suspended ceilings.
- Fits rectangular or round head T-Bars.
- Commonly known as "Hurricane Clip".

UPC/Part Number	Catalog Number	Description	Box Qty.
78101118095	BA15	For Straight Lip or Uprturned Lip Fixtures	100

Read safety/installation instruction sheets in packages before use.
These products are designed for positioning only. No load rating.

Acoustical Tee

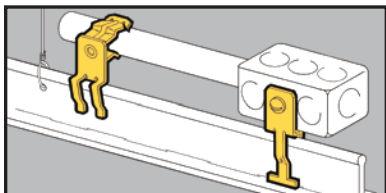

- A positive method for supporting vertical boxes, conduit or cable above T-Bar.
- Allows conduit to clear drop wires.
- **Warning:** Do not use for hanging acoustical tee.

Side Mount T-Bar Fasteners

BA5-4T



UPC/Part Number	Catalog Number	Description	Box Qty.
78101118095	BA5-4T	With 1/4"-20 Thread Impression	100

BG Series



BP Series



UPC/Part Number	Catalog Number	Conduit Size	Box Qty.
78101118410	BG-6-A5 *	3/8"	100
78101118465	BG-8-12-A5	1/2", 3/4"	100
78101118545	BG-16-A5	1"	100
Patent #4958792			
78101119235	BP-8-A5	1/2" EMT	100
78101119335	BP-12-A5	3/4" EMT	100
		1/2" IMC, Rigid	
78101118545	BP-16-A5	1" EMT	100
		3/4" IMC, Rigid	

- * BG-6 will accept the following range $\varnothing.420 - \varnothing.675$:
14/2 thru 10/4 MC/AC cable and 5/16" or 3/8" flexible conduit

Read safety/installation instruction sheets in packages before use.
These products are designed for positioning only. No load rating.

Acoustical Tee

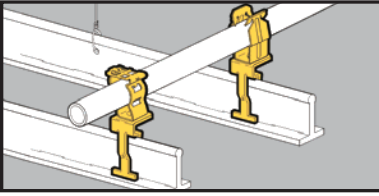

- A positive method for supporting horizontal boxes or conduit above T-Bar.
- Allows conduit to clear drop wires.
- **Warning:** Do not use for hanging acoustical tee.

Top Mount T-Bar Fasteners



UPC/Part Number	Catalog Number	Description	Box Qty.
78101118125	BA6-4T	With 1/4"-20 Thread Impression	100

BG Series



BP Series



UPC/Part Number	Catalog Number	Conduit Size	Box Qty.
78101188540	BG-6-A6 *	3/8"	100
78101118470	BG-8-12-A6	1/2", 3/4"	100
78101118550	BG-16-A6	1"	100
Patent #4958792			
78101119240	BP-8-A6	1/2" EMT	100
78101119340	BP-12-A6	3/4" EMT	100
		1/2" IMC, Rigid	
78101119435	BP-16-A6	1" EMT	100
		3/4" IMC, Rigid	

- * BG-6 will accept the following range $\varnothing.420 - \varnothing.675$:
 14/2 thru 10/4 MC/AC cable and 5/16" or 3/8" flexible conduit

Read safety/installation instruction sheets in packages before use.
 These products are designed for positioning only. No load rating.

Acoustical Tee

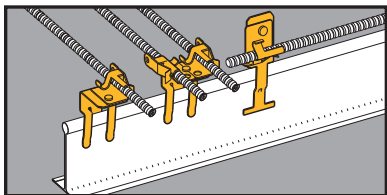

- A positive method for supporting cable or flexible conduit above T-Bar.
- Assemblies support MC, AC, sizes 14/2 through 10/3 or 3/8" FMC.

Top Mount T-Bar Fasteners

BX4-A6



BX4M-A6



UPC/Part Number	Catalog Number	Description	Box Qty.
78101101220	BX4-A6	Single Runs	100
78101101216	BX4M-A6	Double Runs	100

Note: Fasteners will rotate 360°.

BX4-A5



BX4M-A5



UPC/Part Number	Catalog Number	Description	Box Qty.
78101101187	BX4-A5	Single Runs	100
78101101211	BX4M-A5	Double Runs	100

Note: Fasteners will rotate 360°.

Read safety/installation instruction sheets in packages before use.
These products are designed for positioning only. No load rating.

Acoustical Tee

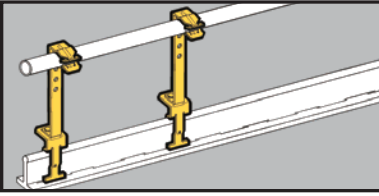

- Supports conduit and electrical boxes above T-Bar.
- Height adjusts from 4¹/₄" to 7¹/₄".
- Conduit fasteners can be attached at ³/₄" increments.
- BX4M-A28 supports cable or FMC above T-Bar.

Support Fasteners

BA28



BX4M-A28



UPC/Part Number	Catalog Number	Description	Box Qty.
78101118115	BA28	1/2" Holes Allow for Adjustment Between 4 ¹ / ₄ " and 7 ¹ / ₄ " at ³ / ₄ " Increments	50
78101101211	BX4M-A28	Double Runs MC, AC, or FMC	25

BP-12-A28



UPC/Part Number	Catalog Number	Conduit Size	Box Qty.
78101119230	BP-8-A28	1/2" EMT	100
78101119330	BP-12-A28	3/4" EMT 1/2" IMC, Rigid	100
78101119425	BP-16-A28	1" EMT 3/4" IMC, Rigid	100

Note: Adjustable BP Conduit Fastener is attached with screw in 7¹/₄" top hole position.

Read safety/installation instruction sheets in packages before use.
These products are designed for positioning only. No load rating.

Acoustical Tee

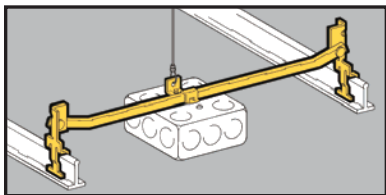

Electrical Box T-Bar Fasteners



- See BA50 for a stronger, more cost effective solution.
- Supports octagonal or square boxes.
- Allows for flush mounting or $\frac{3}{4}$ " offset for plaster ring.
- One BB27 box mounting clip with screw included with each hanger.
- Load Capacity: 20 lbs.
- For additional support, attach dropwire to BB27 box mounting clip.
- **Warning:** Do not use for hanging acoustical tee.

UPC/Part Number	Catalog Number	Description	Box Qty.
78101118080	BA12	Box Hanger 24" Span	50
78101118082	BA12-12	Box Hanger 12" Span	50
78101118085	BA120	Box Hanger 20" Span	50
78101118087	BA130	Box Hanger 30" Span	50



UPC/Part Number	Catalog Number	Description	Box Qty.
78101118170	BB27	Box Mounting Clip (with Screw)	100
78101101673	SRHMS$\frac{1}{4}$x$\frac{3}{8}$	$\frac{1}{4}$ "-20 x $\frac{3}{8}$ " Slotted Round Head Machine Screw	50

Read safety/installation instruction sheets in packages before use.

Acoustical Tee

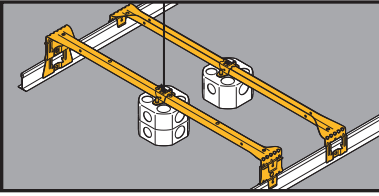

Heavy Duty Electrical Box Hanger



BA50 & BA50CAN

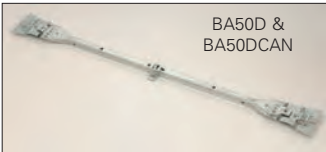

BA50D & BA50DCAN



BA50C3T & BA50C4T



BA50E

- Supports octagonal or square boxes on 24" span.
- Bendable ends mount 1 1/2" or 2 1/8" deep boxes without tools.
- Self-centering feature positions box on center.
- Includes BA50C4T Box Mounting Clip.
- Ultimate Static Load Capacity: 50 Lbs. (without dedicated dropwire)
- Static Load Capacity: 70 Lbs. (with dedicated dropwire) 35 Lbs. Canada
- Finish: Pre-galvanized
- See Ruff-IN™ brochure for pre-fab box assemblies.

UPC/Part Number	Catalog Number	Description	Box Qty.
78101196490	BA50	Box Hanger	25
78205135905	BA50CAN *	Box Hanger	25
78101196491	BA50D	Box Hanger for Box with 1 1/2" Extension	25
78205135906	BA50DCAN *	Box Hanger for Box with 1 1/2" Extension	25
78205136570	BA50C4T	Box Mounting Clip with Hardware	25
78205136571	BA50C3T *	Box Mounting Clip with Hardware	25
78101196489	BA50E	Extender Brackets with Hardware	10 pair

* Canada Only

Read safety/installation instruction sheets in packages before use.

Acoustical Tee

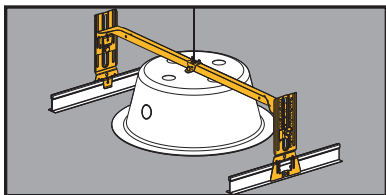

- Adjustable box support for suspended ceilings.
- Accommodates heights up to 8³/₄".
- Integral ruler enables height adjustments without measuring.

Adjustable Box Support



- Ideal for installation of speaker cases, emergency light fixtures, etc. in suspended ceilings.
- Static Load Capacity:
25 Lbs. without dedicated dropwire
70 Lbs. with dedicated dropwire
35 Lbs. (Canada) with dedicated dropwire
- See Ruff-IN™ brochure for pre-fab box assemblies.

UPC/Part Number	Catalog Number	Description	Box Qty.
78205118460	BA50A	Adjustable Box Hanger T-Bar	10

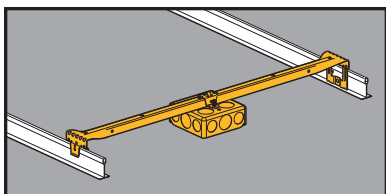

- Pre-assembled T-Bar fasteners speed installation.
- Boxes have 1/2" and 3/4" knockouts.
- Loading not to exceed 50 lbs. in U.S.A. without independent support.
35 Lbs. in Canada
- 24" span

Electrical Box T-Bar Fasteners



UPC/Part Number	Catalog Number	Description	Box Qty.
78205124855	BA50-OB-24	1 1/2" Deep Box to T-Bar Fastener	10
78205124856	BA50-OB-34	2 1/8" Deep Box to T-Bar Fastener	10
78205124857	BA50-SB-24	1 1/2" Deep Box to T-Bar Fastener	10
78205150954	BA50-SB-34	2 1/8" Deep Box to T-Bar Fastener	10

Read safety/installation instruction sheets in packages before use.

Acoustical Tee

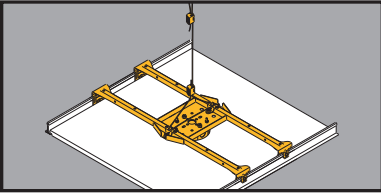

RediMount™ Fan Hanger

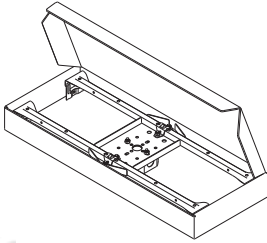

- Pre-assembled fan/ fixture hanger installs on T-Bar in less than 30 seconds.
- Positions and secures fans and fixtures in suspended ceilings.
- Includes Kwik-Wire™ cable and clamps which attach to mounting clips for easy installation.
- Recommended for use in seismic areas.
- UL Listed for fan support up to 70 lbs. or fixture support up to 90 lbs. 35 Lbs. Canada
- Finish: Pre-galvanized

UPC/Part Number	Catalog Number	Description	Box Qty.
78101196492	BA50F	Fan/Fixture Hanger Includes 4" x 11/2" Deep Octagon Box	1

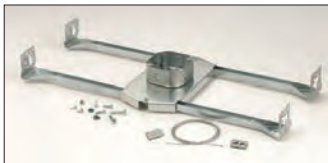
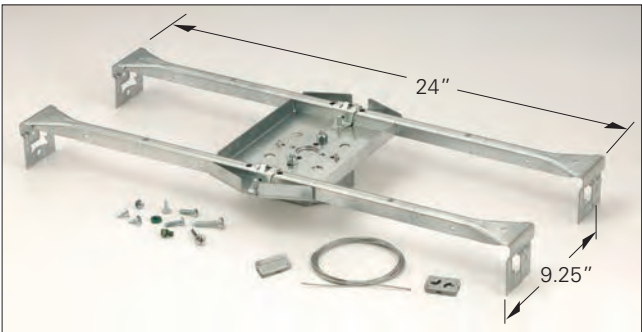

Acoustical Tee

Read safety/installation instruction sheets in packages before use.

Acoustical Tee

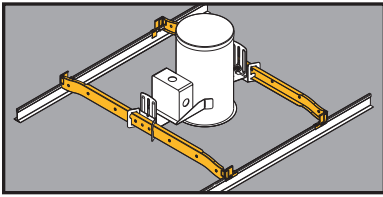

QuikFix™ Fastening System



- New QuikFix™ Fastening System mounts spec grade downlights 50% faster than “wire bound” installation methods.
- QuikFix™ System is pre-sized for 24" spacing.
- No tools required.
- Recommended for use in seismic areas.
- UL listed for fixture support up to 50 lbs.



UPC/Part Number	Catalog Number	Description	Box Qty.
78205199873	BA40	Fixture Bar	20 pair

Patent # 6286265

- Innovative design features offset bar hangers with integral locking tabs that secure downlights to T-Bar and prevent lifting or sliding.

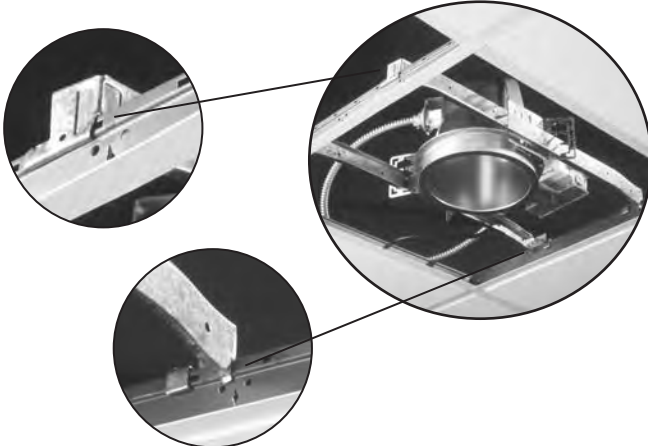

Read safety/installation instruction sheets in packages before use.

Acoustical Tee

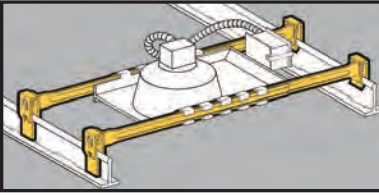

- Adjustable span from 20" to 30".
- Fits horizontal and vertical flanges.
- Fixture position is adjustable.
- No center clips or tools required.
- One set completes one fixture installation (four bars per set).

Light Fixture T-Bar Fasteners

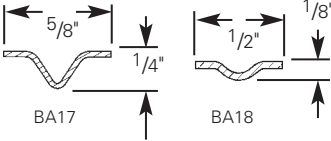

UPC/Part Number	Catalog Number	"High Hat" Fixtures	Box Qty.
78101118100	BA17 (Wide Bar)	CAPRI ¹ R-9X, R-10X CAPRI ¹ R-10X CAPRI ¹ PR-751CX HALO ² H7, HALO ² H17 JUNO ³ AP, APT JUNO ³ IC, ICT, J, SC, TC THOMAS ⁴ RI-C	10 sets
78101118105	BA18 (Narrow Bar)	CAPRI ¹ HSG LIGHTOLIER ⁵ 711	10 sets

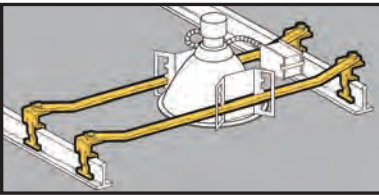

- Fixture position is adjustable within the span of the hanger.
- Fixed span of 24 inches for T-Bar applications.
- Requires only a screwdriver to install.
- One set completes one fixture installation (four bars per set).

Light Fixture T-Bar Fasteners



UPC/Part Number	Catalog Number	"High Hat" Fixtures	Box Qty.
78101118110	BA20 (Wide Bar)	Fits LIGHTOLIER ⁵ CALCULITE ⁵ Fixtures	10 sets

1. CAPRI is a mark used by Thomas Industries, Inc., Louisville, KY.
 2. HALO[®] is the registered trademark of Cooper Industries, Elk Grove, IL.
 3. JUNO[®] is the registered trademark of JUNO Lighting, Inc., Morton Grove, IL.
 4. THOMAS[®] is the registered trademark of Thomas Industries, Inc., Louisville, KY.
 5. LIGHTOLIER[®] and CALCULITE[®] are the registered trademarks of Lightolier, Inc., Secaucus, NJ.

Read safety/installation instruction sheets in packages before use.

Acoustical Tee



- Allows for independent suspension of fixtures.
- Fits most acoustical T-Bars.
- BA-4-WN wing nut included with all 1/4"-20 suspension hangers.
- Static Load Capacity: 65 Lbs.

Suspension Fasteners

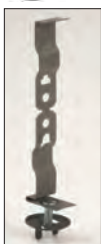

BA1



BA1-T



BA1-T-BN

UPC/Part Number	Catalog Number	T-Bar Size	Stud Size	Box Qty.
78101118065	BA1	15/16"	1/4"-20 x 5/8"	100
78101118070	BA1-24	15/16"	1/4"-20 x 1 1/2"	100
78101118075	BA1-32	15/16"	1/4"-20 x 2"	100
78101102891	BA1-T	15/16"	#8-32 x 5/8" with Pal Nut	100
78101102897	BA1-T-BN	15/16"	#8-32 x 5/8" with Brass Nut	100

Acoustical Tee

BA1-9



BA1-95



UPC/Part Number	Catalog Number	T-Bar Size	Stud Size	Box Qty.
78205125585	BA1-9	9/16"	1/4"-20 x 5/8"	100
78205125587	BA1-95	9/16" & 15/16"	1/4"-20 x 5/8"	100

Acoustical Tee

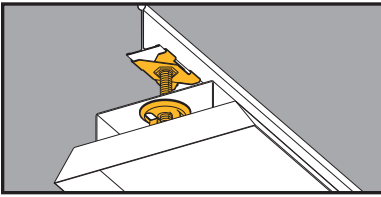

T-Bar Scissor Fasteners

- Supports electrical fixtures from standard $1\frac{5}{16}$ " T-Bars.
- BA-4-WN wing nut included.
- $\frac{1}{4}$ "-20 stud available in varying lengths.
- Static Load Capacity: 50 Lbs.



UPC/Part Number	Catalog Number	Stud Length	Box Qty.
78101104258	BAX-4-16	$\frac{5}{8}$ "	100
78101104262	BAX-4-16-24	$1\frac{1}{2}$ "	100
78101104263	BAX-4-16-32	2"	100
78101104264	BAX-4-16-48	3"	100

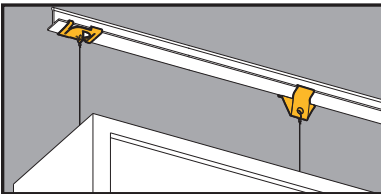

Sign Hangers

- BA-4-16-H supports signs from $1\frac{5}{16}$ " T-Bar.
- BA-4-16-H1 supports signs from $\frac{9}{16}$ " or $1\frac{5}{16}$ " T-Bar.
- Static Load Capacity: 40 Lbs.



BA-4-16-H



BA-4-16-H1

UPC/Part Number	Catalog Number	Stud Length	Box Qty.
78101118040	BA-4-16-H	Sign Hanger with White Finish	100
78101104449	BA-4-16-H1	Sign Hanger with Zinc Plated Finish	100

Read safety/installation instruction sheets in packages before use.

Acoustical Tee

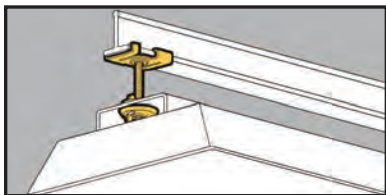

- Supports electrical fixtures from 15/16" T-Bar.
- 1/4"-20 stud available in varying lengths.
- Includes BA-4-WN wing nut with impression.
- Static Load Capacity:
BA4-16 Series = 50 lbs.
BA4-WN Series = 100 lbs.

15/16" Twist Fasteners



BA-4-WN

UPC/Part Number	Catalog Number	Finish	Stud Length	Box Qty.
78101118020	BA-4-16	Black	5/8"	100
78101118055	BA-4-16-W	White	5/8"	100
78101118025	BA-4-16-24	White	1 1/2"	100
78101118030	BA-4-16-32	White	2"	100
78101118035	BA-4-16-48	White	3"	100
78101118060	BA-4-WN	Black		100

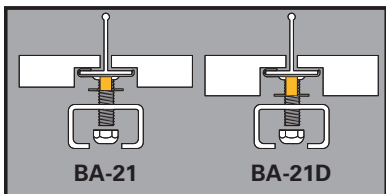

- T-Bar spacer provides flush mounting surface for tegular tile installations.
- Spacer must be used in combination with B-Line's BA-4-16 or BA-2-16 series fasteners.
- Finish: Zinc Plated

T-Bar Spacers



BA-21

BA-21D

UPC/Part Number	Catalog Number	Description	Box Qty.
78101195575	BA-21	1/4" Spacer	100
78101199567	BA-21D	3/8" Spacer	100

Acoustical Tee

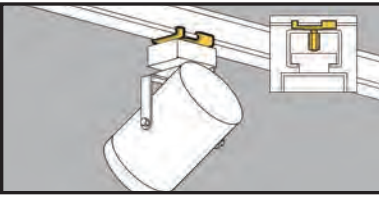

- Supports electrical fixtures from 15/16" T-Bar.
- #8-32 stud available in varying lengths.
- Static Load Capacity: 25 Lbs.

15/16" Twist Fasteners



UPC/Part Number	Catalog Number	Finish	Stud Length	Box Qty.
78101118000	BA-2-16	Black	5/8" with Pal Nut	100
78101104259	BA-2-16-7	Black	7/16" with Pal Nut	100
78101118010	BA-2-16-W	White	5/8" with Pal Nut	100
78101104261	BA-2-16-7-W	White	7/16" with Pal Nut	100



UPC/Part Number	Catalog Number	Finish	Stud Length	Box Qty.
78101118015	BA-2-16-BN	Black	5/8" with Brass Nut	100
78101104260	BA-2-16-7-BN	Black	7/16" with Brass Nut	100
78101118015	BA-2-16-WBN	White	5/8" with Brass Nut	100
78101199566	BA-2-16-7-WBN	White	7/16" with Brass Nut	100

Read safety/installation instruction sheets in packages before use.

Acoustical Tee

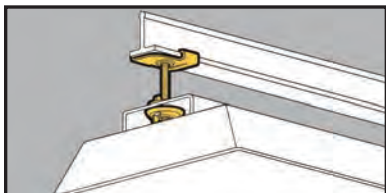

- Supports electrical fixtures from 9/16" T-Bar.
- Stud size: 1/4"-20 x 5/8".
- Static Load Capacity: 40 Lbs.

9/16" Twist Fasteners



UPC/Part Number	Catalog Number	Finish	Stud Length	Box Qty.
78101103458	BA-4-9	Black	5/8"	100
78101103461	BA-4-9-W	White	5/8"	100



- Supports electrical fixtures and track lighting from 9/16" T-Bar.
- Stud size: #8-32 x length.
- Static Load Capacity: 25 Lbs.

9/16" Twist Fasteners

BA-2-9 Series with Pal Nut



BA-2-9-BN Series with Brass Nut



UPC/Part Number	Catalog Number	Finish	Stud Length	Box Qty.
78101103467	BA-2-9	Black	5/8"	100
78101103466	BA-2-9-7	Black	7/16"	100
78101103459	BA-2-9-W	White	5/8"	100
78101103465	BA-2-9-BN	Black	5/8"	100
78101103464	BA-2-9-7-BN	Black	7/16"	100
78101103460	BA-2-9-WBN	White	5/8"	100

Read safety/installation instruction sheets in packages before use.

Acoustical Tee

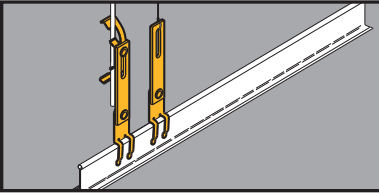

Drop Wire/Rod Securing Clip

- Secures independent support wires to ceiling grid as required by NEC Article 300.11.
- Slotted design permits adjustment when securing rods.
- Bright yellow color, Per NEC 300.11 (A), is easily identified by inspectors.



BA-311



BA-311-W2 Shown

UPC/Part Number	Catalog Number	Description	Box Qty.
78101199569	BA311	#12 thru #8 Wire	100
78101199570	BA311-W2	#12 thru 1/4" Plain or	100
78101199571	BA311-W6	3/8" Plain or Threaded Rod	100

Read safety/installation instruction sheets in packages before use.

Acoustical Tee



Seismic Fixture Clamps

- BA-SFC Series provides seismic restraint for light fixtures within a suspended ceiling.
- BA-SFC reduces labor by attaching light fixtures to the T-bar frame and eliminating extra drop wires or chains.
- Provides positive attachment of fixtures to ceiling grid members, in compliance with ICBO Acceptance Criteria 184 (AC 184).
- Satisfies NEC 410.16(C) which requires positive attachment for secure fastening of luminaires.
- Load rating: 200 lbs.

UPC/Part Number	Catalog Number	Description	Box Qty.
78205145911	BA-SFC	Seismic Fixture Clamp attaches one standard 2' x 4' light fixture to T-Bar ceiling	25 sets (4 clamps per set)
78205145912	BA-SFC-E*	For attachment of two standard 2' x 4' light fixtures end-to-end onto T-Bar ceiling	25 sets (4 clamps per set)
78205145913	BA-SFC-S*	For attachment of two standard 2' x 4' light fixtures side-by-side onto T-Bar ceiling	25 sets (4 clamps per set)
78205145914	BA-SFC-CF*	For attachment of standard 2' x 2' light fixtures onto T-Bar	50 sets (2 clamps per set)
78205145915	BA-SFC-CFS	Seismic Fixture Clamp for reinforcement of main runner connection points	50 sets (2 clamps per set)

* BASFC is required to complete installation.

Seismic Fixture Clamps cont.



BA-SFC

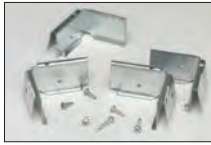

BA-SFC-E

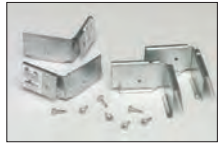

BA-SFC-S

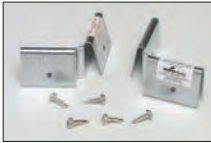

BA-SFC-CF



BA-SFC-CFS

Single Fixture
Installation



Parts Required:
1 pc. BA-SFC Installation Kit

Two Fixtures (Side by Side)

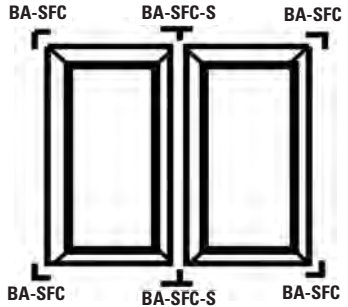

Parts Required:
1 pc. BA-SFC Installation Kit
1 pc. BA-SFC-S Installation Kit

Two Fixtures (End to End)

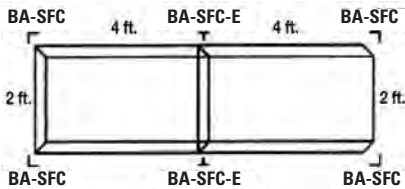

Parts Required:
1 pc. BA-SFC Installation Kit
1 pc. BA-SFC-E Installation Kit



Beams

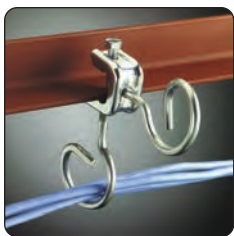

Beams

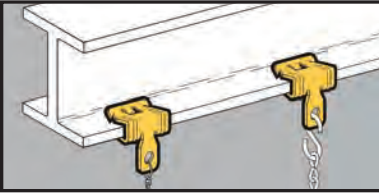

- Permits fast and easy installation on bulb tees and beams.
- Clearance hole for 1/4" bolt in tab.
- Simply installed with a hammer.

Flange Beam Fasteners



UPC/Part Number	Catalog Number	Flange Thickness	Static Load Cap.	Box Qty.
78101118290	BE-1-2	3/32" - 9/64"	160 lbs.	100



BE-2-4

UPC/Part Number	Catalog Number	Flange Thickness	Static Load Cap.	Box Qty.
78101118295	BE-2-4	1/8" - 1/4"	200 lbs.	100
78101118300	BE-5-8	5/16" - 1/2"	200 lbs.	100
78101118305	BE-9-12	9/16" - 3/4"	200 lbs.	100

Read safety/installation instruction sheets in packages before use.

Beams



- Quickly attaches conduit to beams.
- Fasteners will rotate 360°.
- Simply installed with a hammer.

Push-Type Conduit To Beam Fasteners



UPC/Part Number	Catalog Number	Conduit Size	Flange Thickness	Box Qty.
78101119275	BP-8-E-2-4	1/2" EMT	1/8" - 1/4"	100
78101119280	BP-8-E-5-8	1/2" EMT	5/16" - 1/2"	100
78101119285	BP-8-E-9-12	1/2" EMT	9/16" - 3/4"	100
78101119375	BP-12-E-2-4	1/2" EMT 1/2" IMC, Rigid	1/8" - 1/4"	100
78101119380	BP-12-E-5-8	1/2" EMT 1/2" IMC, Rigid	5/16" - 1/2"	100
78101119385	BP-12-E-9-12	1/2" EMT 1/2" IMC, Rigid	9/16" - 3/4"	100
78101119465	BP-16-E-2-4	1" EMT 3/4" IMC, Rigid	1/8" - 1/4"	100
78101119470	BP-16-E-5-8	1" EMT 3/4" IMC, Rigid	5/16" - 1/2"	100
78101119475	BP-16-E-9-12	1" EMT 3/4" IMC, Rigid	9/16" - 3/4"	100

**Ultimate
Static Load
Capacity**

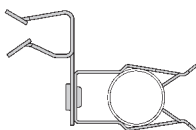

15 Lbs.



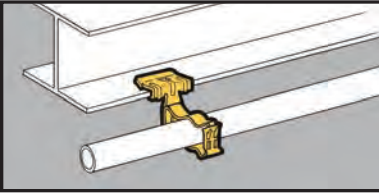

- Unique Guide-Rite Fastener provides for fast and easy installation.
- Fasteners will rotate 360°.
- Simply installed with a hammer and pliers.

Guide-Rite™ Conduit To Beam Fasteners



UPC/Part Number	Catalog Number	Conduit Size	Flange Thickness	Box Qty.
78101118430	BG-6-E-2-4	3/8"	1/8" - 1/4"	100
78101118435	BG-6-E-5-8	3/8"	5/16" - 1/2"	100
78101118440	BG-6-E-9-12	3/8"	9/16" - 3/4"	100
78101118505	BG-8-12-E-2-4	1/2", 3/4"	1/8" - 1/4"	100
78101118510	BG-8-12-E-5-8	1/2", 3/4"	5/16" - 1/2"	100
78101118515	BG-8-12-E-9-12	1/2", 3/4"	9/16" - 3/4"	100
78101118575	BG-16-E-2-4	1"	1/8" - 1/4"	100
78101118580	BG-16-E-5-8	1"	5/16" - 1/2"	100
78101118585	BG-16-E-9-12	1"	9/16" - 3/4"	100
78101118660	BG-20-E-2-4	1 1/4"	1/8" - 1/4"	100
78101118665	BG-20-E-5-8	1 1/4"	5/16" - 1/2"	100
78101118670	BG-20-E-9-12	1 1/4"	9/16" - 3/4"	100
78101118705	BG-24-E-2-4	1 1/2"	1/8" - 1/4"	50
78101118710	BG-24-E-5-8	1 1/2"	5/16" - 1/2"	50
78101118715	BG-24-E-9-12	1 1/2"	9/16" - 3/4"	50
78101118745	BG-32-E-2-4	2"	1/8" - 1/4"	50
78101118750	BG-32-E-5-8	2"	5/16" - 1/2"	50
78101118755	BG-32-E-9-12	2"	9/16" - 3/4"	50

Patent #4958792

- * BG-6 will accept the following range $\varnothing.420$ - $\varnothing.675$:
14/2 thru 10/4 MC/AC cable
and 5/16 or 3/8 flexible conduit

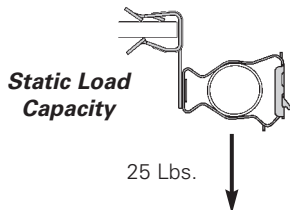

Read safety/installation instruction sheets in packages before use.

Beams

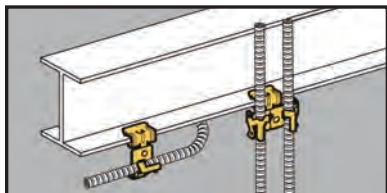

- Attaches MC, AC, sizes 14/2 through 10/3 or 3/8" FMC to beam flanges 1/8" to 3/4" thick.
- Fasteners will rotate 360°.
- Simply installed with a hammer.

Cable To Beam Fasteners



UPC/Part Number	Catalog Number	Types Of Runs	Flange Thickness	Box Qty.
78101101192	BX4-E-2-4	Single	1/8" - 1/4"	100
78101101193	BX4-E-5-8	Single	5/16" - 1/2"	100
78101101194	BX4-E-9-12	Single	9/16" - 3/4"	100



UPC/Part Number	Catalog Number	Types Of Runs	Flange Thickness	Box Qty.
78101101213	BX4M-E-2-4	Double	1/8" - 1/4"	100
78101101214	BX4M-E-5-8	Double	5/16" - 1/2"	100
78101101215	BX4M-E-9-12	Double	5/16" - 3/4"	100

Read safety/installation instruction sheets in packages before use.

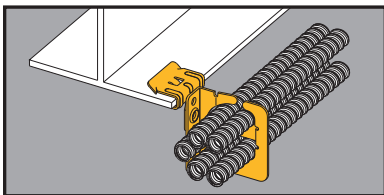

MC/AC Cable Carrier to Beam Fastener



BRC5-2-E24



- Secures and supports MC/AC cables as required by the NEC.
- Effectively organizes cables and eliminates derating issues.
- BRC5-1 secures up to four (4) runs of .430 to .560 diameter cable.
- BRC5-2 secures up to nine (9) runs of .430 to .560 diameter cable.
- BRC5-3 secures up to seven (7) runs of .560 to .690 diameter cable.
- Load Capacity: 50 lbs.

UPC/Part Number	Catalog Number	Flange Thickness	Box Qty.
78205144093	BRC51-E12	3/32" - 9/64"	25
78205144096	BRC51-E24	1/8" - 1/4"	25
78205144099	BRC51-E58	5/16" - 1/2"	25
78205144102	BRC51-E912	9/16" - 3/4"	25
78205144094	BRC52-E12	3/32" - 9/64"	25
78205144097	BRC52-E24	1/8" - 1/4"	25
78205144100	BRC52-E58	5/16" - 1/2"	25
78205144103	BRC52-E912	9/16" - 3/4"	25
78205144095	BRC53-E12	3/32" - 9/64"	25
78205144098	BRC53-E24	1/8" - 1/4"	25
78205144101	BRC53-E58	5/16" - 1/2"	25
78205144104	BRC53-E912	9/16" - 3/4"	25

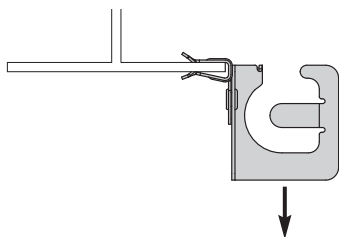

Static Load Capacity

50 Lbs.

Read safety/installation instruction sheets in packages before use.

Beams

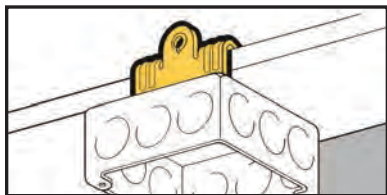

- Suspend boxes or fixtures from beam flanges 1/8" to 3/4" thick.
- Provided with 1/4"-20 thread impression for quick and secure attachment.
- Simply installed with a hammer.

Universal Beam Fasteners



UPC/Part Number	Catalog Number	Flange Thickness	Box Qty.
78101119600	BU-2-4	1/8" - 1/4"	100
78101119605	BU-5-8	5/16" - 1/2"	100
78101119610	BU-9-12	9/16" - 3/4"	100



1/4"-20 x 3/8"
Staked Stud

UPC/Part Number	Catalog Number	Flange Thickness	Box Qty.
78101119615	BU-2-4-S	1/8" - 1/4"	100
78101119620	BU-5-8-S	5/16" - 1/2"	100
78101119625	BU-9-12-S	9/16" - 3/4"	100

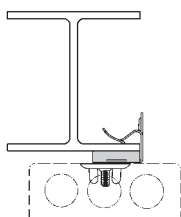
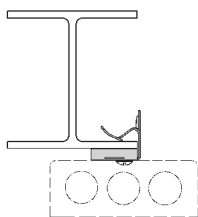

Static Load Capacity

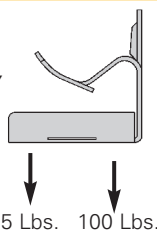

Note: Indicated loads are static load capacity and should not be combined.

Read safety/installation instruction sheets in packages before use.
These products are designed for positioning only. No load rating.

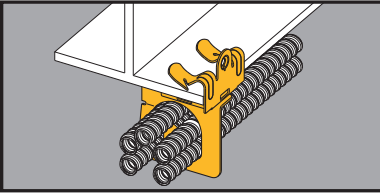

MC/AC Cable Carrier to Beam Fastener



- Secures and supports MC/AC cables as required by the NEC.
- Effectively organizes cables and eliminates derating issues.
- BRC5-1 secures up to four (4) runs of .430 to .560 diameter cable.
- BRC5-2 secures up to nine (9) runs of .430 to .560 diameter cable.
- BRC5-3 secures up to seven (7) runs of .560 to .690 diameter cable.
- Load Capacity: 50 lbs.

UPC/Part Number	Catalog Number	Flange Thickness	Box Qty.
78205144066	BRC51-U24	1/8" - 1/4"	25
78205144069	BRC51-U58	5/16" - 1/2"	25
78205144072	BRC51-U912	9/16" - 3/4"	25
78205144067	BRC52-U24	1/8" - 1/4"	25
78205144070	BRC52-U58	5/16" - 1/2"	25
78205144073	BRC52-U912	9/16" - 3/4"	25
78205144068	BRC53-U24	1/8" - 1/4"	25
78205144071	BRC53-U58	5/16" - 1/2"	25
78205144074	BRC53-U912	9/16" - 3/4"	25

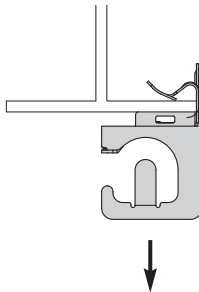

Static Load Capacity

75 Lbs.

Read safety/installation instruction sheets in packages before use.

Beams

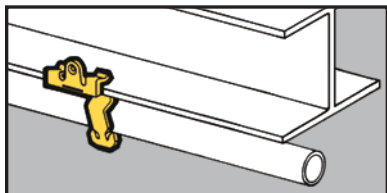

- Quickly attaches conduit to beams.
- Fasteners will rotate 360°.
- Simply installed with a hammer.

Push-Type Conduit To Beam Fasteners



UPC/Part Number	Catalog Number	Conduit Size	Flange Thickness	Box Qty.
78101119310	BP-8-U-2-4	1/2" EMT	1/8" - 1/4"	100
78101119315	BP-8-U-5-8	1/2" EMT	5/16" - 1/2"	100
78101119320	BP-8-U-9-12	1/2" EMT	9/16" - 3/4"	100
78101119405	BP-12-U-2-4	3/4" EMT 1/2" IMC, Rigid	1/8" - 1/4"	100
78101119410	BP-12-U-5-8	3/4" EMT 1/2" IMC, Rigid	5/16" - 1/2"	100
78101119415	BP-12-U-9-12	3/4" EMT 1/2" IMC, Rigid	9/16" - 3/4"	100
78101119490	BP-12-U-2-4	1" EMT 3/4" IMC, Rigid	1/8" - 1/4"	100
78101119495	BP-12-U-5-8	1" EMT 3/4" IMC, Rigid	5/16" - 1/2"	100
78101119500	BP-12-U-9-12	1" EMT 3/4" IMC, Rigid	9/16" - 3/4"	100

**Ultimate
Static Load
Capacity**

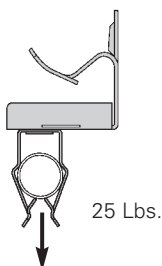

Read safety/installation instruction sheets in packages before use.
These products are designed for positioning only. No load rating.

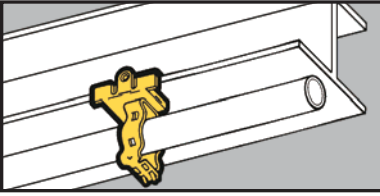

- Unique Guide-Rite Fastener provides for fast and easy installation.
- Fasteners will rotate 360°.
- Simply installed with a hammer and pliers.

Guide-Rite™ Conduit To Beam Fasteners



UPC/Part Number	Catalog Number	Conduit Size	Flange Thickness	Box Qty.
78101118450	BG-6-U-2-4	3/8"	1/8" - 1/4"	100
78101118455	BG-6-U-5-8	3/8"	5/16" - 1/2"	100
78101118460	BG-6-U-9-12	3/8"	9/16" - 3/4"	100
78101118525	BG-8-12-U-2-4	1/2", 3/4"	1/8" - 1/4"	100
78101118530	BG-8-12-U-5-8	1/2", 3/4"	5/16" - 1/2"	100
78101118535	BG-8-12-U-9-12	1/2", 3/4"	9/16" - 3/4"	100
78101118625	BG-16-U-2-4	1"	1/8" - 1/4"	100
78101118630	BG-16-U-5-8	1"	5/16" - 1/2"	100
78101118635	BG-16-U-9-12	1"	9/16" - 3/4"	100
78101118680	BG-20-U-2-4	1 1/4"	1/8" - 1/4"	100
78101118685	BG-20-U-5-8	1 1/4"	5/16" - 1/2"	100
78101118690	BG-20-U-9-12	1 1/4"	9/16" - 3/4"	100
78101118720	BG-24-U-2-4	1 1/2"	1/8" - 1/4"	50
78101118725	BG-24-U-5-8	1 1/2"	5/16" - 1/2"	50
78101118730	BG-24-U-9-12	1 1/2"	9/16" - 3/4"	50
78101118760	BG-32-U-2-4	2"	1/8" - 1/4"	50
78101118765	BG-32-U-5-8	2"	5/16" - 1/2"	50
78101118770	BG-32-U-9-12	2"	9/16" - 3/4"	50

Patent #4958792

- * BG-6 will accept the following range $\varnothing.420$ - $\varnothing.675$:
14/2 thru 10/4 MC/AC cable
and 5/16 or 3/8 flexible conduit

**Static Load
Capacity**

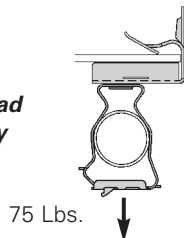

Beams

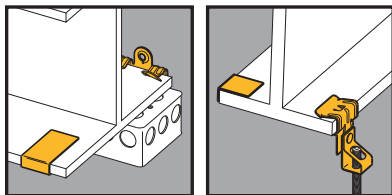

- Anchor strap provides secure attachment to beam flanges.
- Suspends threaded rod from beam flanges.
- 8" anchor straps are provided for 1/8" to 1/4" thick flanges.
- 13" anchor straps are provided for 5/16" to 3/4" thick flanges.

Beam Fasteners With Anchor Straps



Static Load Capacity

75 Lbs.



UPC/Part Number	Catalog Number	Stud Size	Flange Thickness	Box Qty.
78101104942	BU-2-4-S-AS	1/4"-20 x 3/8"	1/8" - 1/4"	50
78101104943	BU-5-8-S-AS	1/4"-20 x 3/8"	5/16" - 1/2"	50
78101104944	BU-9-12-S-AS	1/4"-20 x 3/8"	9/16" - 3/4"	50



Static Load Capacity

160 Lbs.



UPC/Part Number	Catalog Number	Threaded Rod Size	Flange Thickness	Box Qty.
78101104948	BH4-E-2-4-AS	1/4"-20	1/8" - 1/4"	50
78101104949	BH4-E-5-8-AS	1/4"-20	5/16" - 1/2"	50
78101104950	BH4-E-9-12-AS	1/4"-20	9/16" - 3/4"	50
78101104951	BH6-E-2-4-AS	3/8"-16	1/8" - 1/4"	50
78101104952	BH6-E-5-8-AS	3/8"-16	5/16" - 1/2"	50
78101104953	BH6-E-9-12-AS	3/8"-16	9/16" - 3/4"	50

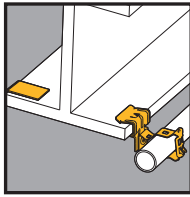
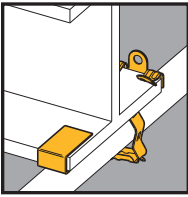

- Anchor strap provides secure attachment to beam flanges.
- Unique Guide-Rite™ Fastener provides for fast and easy installation.
- 8" anchor straps are provided for 1/8" to 1/4" thick flanges.
- 13" anchor straps are provided for 5/16" to 3/4" thick flanges.

Conduit To Beam Fasteners With Anchor Straps



Static Load Capacity

75 Lbs.

UPC/Part Number	Catalog Number	Conduit Size	Flange Thickness	Box Qty.
78101104966	BG-8-12-U-2-4-AS	1/2", 3/4"	1/8" - 1/4"	50
78101104967	BG-8-12-U-5-8-AS	1/2", 3/4"	5/16" - 1/2"	50
78101104968	BG-8-12-U-9-12-AS	1/2", 3/4"	9/16" - 3/4"	50
78101104969	BG-16-U-2-4-AS	1"	1/8" - 1/4"	50
78101104970	BG-16-U-5-8-AS	1"	5/16" - 1/2"	50
78101104971	BG-16-U-9-12-AS	1"	9/16" - 3/4"	50



Static Load Capacity

25 Lbs.



UPC/Part Number	Catalog Number	Conduit Size	Flange Thickness	Box Qty.
78101104972	BG-8-12-E-2-4-AS	1/2", 3/4"	1/8" - 1/4"	50
78101104973	BG-8-12-E-5-8-AS	1/2", 3/4"	5/16" - 1/2"	50
78101104974	BG-8-12-E-9-12-AS	1/2", 3/4"	9/16" - 3/4"	50
78101104975	BG-16-E-2-4-AS	1"	1/8" - 1/4"	50
78101104976	BG-16-E-5-8-AS	1"	5/16" - 1/2"	50
78101104977	BG-16-E-9-12-AS	1"	9/16" - 3/4"	50

Read safety/installation instruction sheets in packages before use.

Beams

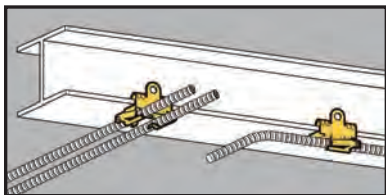

- Attaches MC, AC, sizes 14/2 through 10/3 or 3/8" FMC to flanges 1/8" to 3/4" thick.
- Fasteners will rotate 360°.

Cable To Beam Fasteners



UPC/Part Number	Catalog Number	Description	Flange Thickness	Box Qty.
78101101197	BX4-U-2-4	Single Runs	1/8" - 1/4"	100
78101101198	BX4-U-5-8	Single Runs	5/16" - 1/2"	100
78101101199	BX4-U-9-12	Single Runs	9/16" - 3/4"	100



UPC/Part Number	Catalog Number	Description	Flange Thickness	Box Qty.
78101101206	BX4M-U-2-4	Double Runs	1/8" - 1/4"	100
78101101207	BX4M-U-5-8	Double Runs	5/16" - 1/2"	100
78101101208	BX4M-U-9-12	Double Runs	9/16" - 3/4"	100

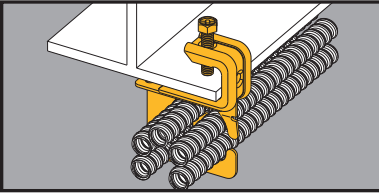

MC/AC Cable Carrier to Beam Fastener

- Secures and supports MC/AC cables as required by the NEC.
- Effectively organizes cables and eliminates derating issues.
- Fits beam flanges from 1/8" thru 5/8" thick.
- Load Capacity: 50 lbs.



BRC5-1-C442



UPC/Part Number	Catalog Number	Cable Diameter & Number of Runs	Box Qty.
78205144087	BRC51-C442	.430" to .560" Up to 4 Runs	25
78205144088	BRC52-C442	.430" to .560" Up to 9 Runs	25
78205144089	BRC53-C442	.560" to .690" Up to 7 Runs	25

Read safety/installation instruction sheets in packages before use.

Beams

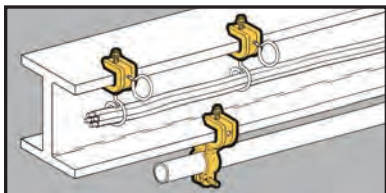

- BC442 fits beam flanges 1/8" to 5/8". BC442-6 fits beam flanges up to 3/4".
- Finish: Zinc Plated
- Static Load Capacity: BC442 = 100 Lbs. BC442-6 = 200 Lbs.

Beam Fasteners



UPC/Part Number	Catalog Number	Description	Box Qty.
78101118278	BC442	Accepts 1/4"-20 Threaded Rod or 1/4"-20 Threaded Bridle Rings	50
78101104283	BC442-6	Accepts 3/8"-16 Threaded Rod	25



UPC/Part Number	Catalog Number	Conduit Size		Box Qty.
		Rigid	EMT	
78101119850	BL1400-C442	1/2"	1/2"	50
78101119851	BL1410-C442	3/4"	3/4"	50
78101119852	BL1420-C442	1"	1"	50
78101119853	BL1425-C442	–	1 1/4"	50
78101119854	BL1430-C442	1 1/4"	1 1/2"	50
78101119855	BL1440-C442	1 1/2"	–	25
78101119856	BL1450-C442	2"	2"	25

Read safety/installation instruction sheets in packages before use. These products are designed for positioning only. No load rating.

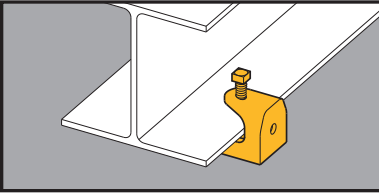

- Can be used with 1/4"-20 and 3/8"-16 threaded rod or bridle rings.
- Fits beam flanges through 1/2" thick.
- Safety Factor of 5.
- Finish: Zinc-Plated

Beam Fasteners



UPC/Part Number	Catalog Number	Rod Size	Static Load Cap.	Box Qty.
78101155333	B444-1/4	1/4"-20	150 lbs.	50
78101155333	B444-5/16	5/16"-18	150 lbs.	50
78101155333	B444-3/8	3/8"-16	150 lbs.	50

Read safety/installation instruction sheets in packages before use.

Beams

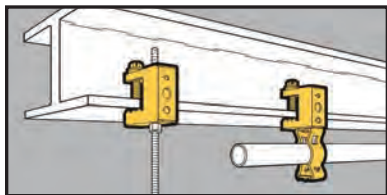

- Fits beam flanges thru 1/2" thick.
- Accepts "S" hooks, 1/4" and 3/8" threaded rod, 1/4"-20 or #10-24 threaded bridle rings.
- Supports conduit and electrical boxes.

Conduit To Beam Fasteners



UPC/Part Number	Catalog Number	Flange Thickness	Static Load Cap.	Box Qty.
78101118275	BC1	Thru 1/42	100 lbs.	100

Guide-Rite™
Fastener



UPC/Part Number	Catalog Number	Conduit Size EMT & Rigid	Static Load Cap.	Box Qty.
78101118490	BG-8-12-C2	1/2", 3/4"	100 lbs.	100
78101118570	BG-16-C2	1"	100 lbs.	100
78101118655	BG-20-C2	1 1/4"	100 lbs.	100
78101118700	BG-24-C2	1 1/2"	100 lbs.	100
78101118740	BG-32-C2	2"	100 lbs.	100

Conduit To Beam Fasteners



Guide-Rite™
Fastener



UPC/Part Number	Catalog Number	Conduit Size EMT & Rigid	Static Load Cap.	Box Qty.
78101118485	BG-8-12-C1	1/2", 3/4"	25 lbs.	100
78101118565	BG-16-C1	1"	25 lbs.	100
78101118650	BG-20-C1	1 1/4"	25 lbs.	100
78101118695	BG-24-C1	1 1/2"	25 lbs.	50
78101118735	BG-32-C1	2"	25 lbs.	50



Push-Type

UPC/Part Number	Catalog Number	Conduit Size	Ultimate Static Load Cap.	Box Qty.
78101119260	BP-8-C2	1/2" EMT	25 lbs.	100
78101119360	BP-12-C2	3/4" EMT 1/2" IMC, Rigid	25 lbs.	100
78101119455	BP-16-C2	1" EMT 3/4" IMC, Rigid	25 lbs.	100



Push-Type

UPC/Part Number	Catalog Number	Conduit Size	Ultimate Static Load Cap.	Box Qty.
78101119255	BP-8-C1	1/2" EMT	25 lbs.	100
78101119355	BP-12-C1	3/4" EMT 1/2" IMC, Rigid	25 lbs.	100
78101119450	BP-16-C1	1" EMT 3/4" IMC, Rigid	25 lbs.	100

Read safety/installation instruction sheets in packages before use.

Beams

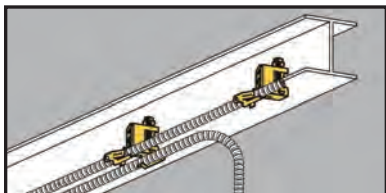

- Attaches MC, AC, sizes 14/2 through 10/3 or 3/8" FMC to beam flanges thru 1/2" thick.
- Fasteners will rotate 360°.
- Requires only a screwdriver to install.

Cable To Beam Fasteners



BX4-C2



BX4M-C2



UPC/Part Number	Catalog Number	Flange Thickness	Box Qty.
78101101190	BX4-C2	Single Runs	100
78101101210	BX4M-C2	Double Runs	100

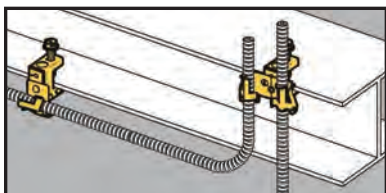

- Attaches MC, AC, sizes 14/2 through 10/3 or 3/8" FMC to beam flanges thru 1/2" thick.
- Fasteners will rotate 360°.
- Requires only a screwdriver to install.

Cable To Beam Fasteners



BX4-C1



BX4M-C1



UPC/Part Number	Catalog Number	Flange Thickness	Box Qty.
78101101191	BX4-C1	Single Runs	100
78101101209	BX4M-C1	Double Runs	100

Read safety/installation instruction sheets in packages before use. These products are designed for positioning only. No load rating.

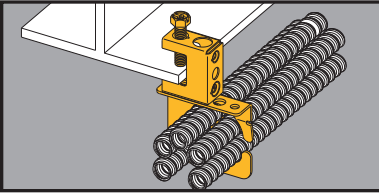

MC/AC Cable Carrier to Beam Fastener

- Secures and supports MC/AC cables as required by the NEC.
- Effectively organizes cables and eliminates derating issues.
- Fits beam flanges thru 1/2" thick.
- Load Capacity: 50 lbs.



BRC5-x-C2



UPC/Part Number	Catalog Number	Cable Diameter & Number of Runs	Box Qty.
78205144090	BRC51-C2	.430" to .560" Up to 4 Runs	25
78205144091	BRC52-C2	.430" to .560" Up to 9 Runs	25
78205144092	BRC53-C2	.560" to .690" Up to 7 Runs	25

Read safety/installation instruction sheets in packages before use.

Beams

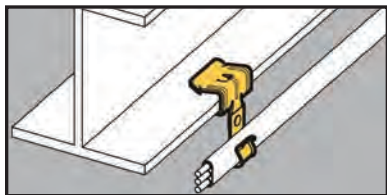

- Attaches Type NM cable to beam flanges $1/8''$ to $1/2''$ thick.
- Supports cable sizes $14/2$ and $12/2$ with ground wire.
- Simply installed with a hammer.

Cable To Beam Fasteners



UPC/Part Number	Catalog Number	Flange Thickness	Box Qty.
78101103550	BRC3-E-2-4	$1/8''$ to $1/4''$	100
78101103551	BRC3-E-5-8	$5/16''$ to $1/2''$	100
78101103552	BRC3-E-9-12	$9/16''$ to $3/4''$	100

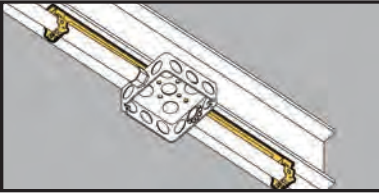

Guide-Rite™ Conduit & Box Support Fasteners



- See Ruff-IN™ brochure for pre-fab box assemblies.

- New BMC3 plate is available to support multiple conduit runs.
- Riveted assembly secures electrical boxes and conduit runs to beam flanges 1/8" to 1/2" thick.
- Provides support for conduit on either side of electrical box.
- Assemblies using BMC3 plate include center conduit clamp. Additional conduit clamps may be purchased separately.

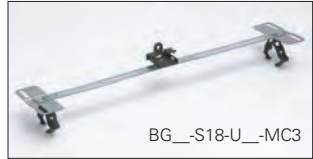
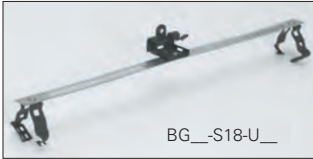

UPC/Part Number	Catalog Number	Conduit Size	Flange Thickness	Box Qty.
78101103583	BG6-S18-U24 *	3/8"	1/8" to 1/4"	25
78101103584	BG6-S18-U58 *	3/8"	5/16" to 1/2"	25
78101103579	BG812-S18-U24	1/2", 3/4"	1/8" to 1/4"	25
78101103580	BG812-S18-U58	1/2", 3/4"	5/16" to 1/2"	25
78101103581	BG16-S18-U24	1"	1/8" to 1/4"	25
78101103582	BG16-S18-U58	1"	5/16" to 1/2"	25

Patent #4958792

With Multiple Conduit Plate

78205152813	BG6-S18-U24-MC3 *	3/8"	1/8" to 1/4"	25
78205152814	BG6-S18-U58-MC3 *	3/8"	5/16" to 1/2"	25
78205152815	BG812-S18-U24-MC3	1/2", 3/4"	1/8" to 1/4"	25
78205152816	BG812-S18-U58-MC3	1/2", 3/4"	5/16" to 1/2"	25
78205152817	BG16-S18-U24-MC3	1"	1/8" to 1/4"	25
78205152823	BG16-S18-U58-MC3	1"	5/16" to 1/2"	25

- * BG-6 will accept the following range $\varnothing.420 - \varnothing.675$:
14/2 thru 10/4 MC/AC cable and 5/16 or 3/8 flexible conduit

Beams

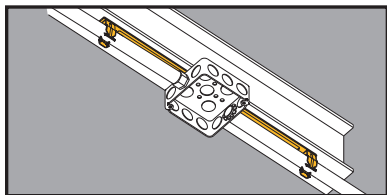

Push-Type Conduit & Box Support Fasteners

- See Ruff-IN™ brochure for pre-fab box assemblies.

- New BMC3 plate is available to support multiple conduit runs.
- Riveted assembly secures electrical boxes and conduit runs to beam flanges 1/8" to 1/2" thick.
- Provides support for conduit on either side of electrical box.
- Assemblies using BMC3 plate include center conduit clamp. Additional conduit clamps may be purchased separately.

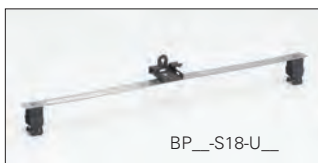

BP__-S18-U__

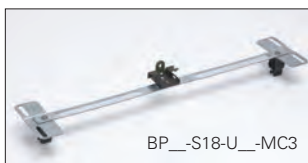

BP__-S18-U__-MC3

UPC/Part Number	Catalog Number	Conduit Size EMT, IMC, Rigid	Flange Thickness	Box Qty.
78205123635	BP8-S18-U24	3/8"	1/8" to 1/4"	25
78205123638	BP8-S18-U58	3/8"	5/16" to 1/2"	25
78205123636	BP12-S18-U24	1/2", 3/4"	1/8" to 1/4"	25
78205123639	BP12-S18-U58	1/2", 3/4"	5/16" to 1/2"	25
78205123637	BP16-S18-U24	1"	1/8" to 1/4"	25
78205123640	BP16-S18-U58	1"	5/16" to 1/2"	25

Patent #4958792

With Multiple Conduit Plate

78205152824	BP8-S18-U24-MC3	3/8"	1/8" to 1/4"	25
78205152825	BP8-S18-U58-MC3	3/8"	5/16" to 1/2"	25
78205152827	BP12-S18-U24-MC3	1/2", 3/4"	1/8" to 1/4"	25
78205152828	BP12-S18-U58-MC3	1/2", 3/4"	5/16" to 1/2"	25
78205152825	BP16-S18-U24-MC3	1"	1/8" to 1/4"	25
78205152964	BP16-S18-U58-MC3	1"	5/16" to 1/2"	25

Read safety/installation instruction sheets in packages before use.
These products are designed for positioning only. No load rating.

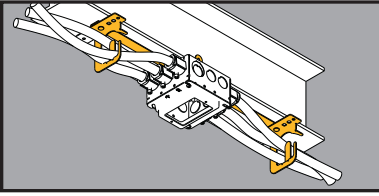

Multi-Run Cable Carrier & Box Support Fastener

- Riveted assembly provides support for electrical box and cable run on either side of box.
- Cable retention tab is open for easy loading and contains cable when bent in place.
- See Ruff-IN™ brochure for pre-fab box assemblies.



UPC/Part Number	Catalog Number	Conduit Size Number of Runs	Flange Thickness	Box Qty.
78205152829	BRC51-S18-U24	.430" - .560" Up to 4 Runs	1/8" to 1/4"	25
78205152830	BRC51-S18-U58	.560" - .690" Up to 7 Runs	5/16" to 1/2"	25
78205152834	BRC53-S18-U24	.430" - .560" Up to 4 Runs	1/8" to 1/4"	25
78205152835	BRC53-S18-U58	.560" - .690" Up to 7 Runs	5/16" to 1/2"	25

Read safety/installation instruction sheets in packages before use.

Hangers



Hangers

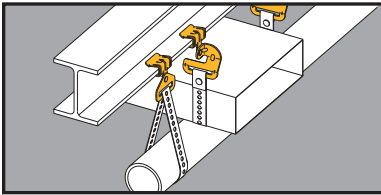

- Suspends straps thru 1 1/2" wide from beam flanges 1/8" to 3/4" thick.
- Suspends straps parallel or at right angles to beams.
- Simply installed with a hammer.
- Static Load Capacity: 200 Lbs.

Strap Hangers



Parallel



Right Angle

UPC/Part Number	Catalog Number	Description	Flange Thickness	Box Qty.
78101104930	BHE-1-2	Parallel	1/16" to 1/8"	100
78101118870	BH-2-4	Parallel	1/8" to 1/4"	100
78101118880	BH-5-8	Parallel	5/16" to 1/2"	100
78101118890	BH-9-12	Parallel	9/16" to 3/4"	100
78101104115	BH-1-2-R	Right Angle	1/16" to 1/8"	100
78101118875	BH-2-4-R	Right Angle	1/8" to 1/4"	100
78101118885	BH-5-8-R	Right Angle	5/16" to 1/2"	100
78101118895	BH-9-12-R	Right Angle	9/16" to 3/4"	100

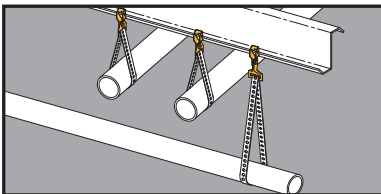

"Z" Purlin Hangers



BH-F12



BH-F12-R

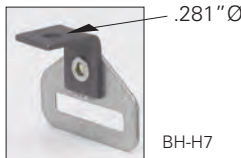

BH-H7

UPC/Part Number	Catalog Number	Description	Box Qty.
78101103385	BH-F12	Right Angle	100
78101103384	BH-F12-R	Parallel	100
78101119922	BH-H7	Parallel	100

Read safety/installation instruction sheets in packages before use.

Hangers

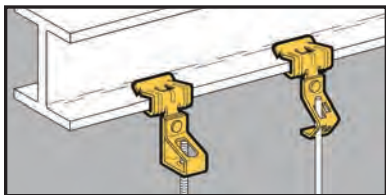

- Suspend wire or plain and threaded rod from beam flanges 1/8" to 3/4" thick.
- Simply installed with a hammer.
- Static Load Capacity: 160 Lbs.

Rod To Beam Hangers



UPC/Part Number	Catalog Number	Flange Thickness	Description	Box Qty.
78101118900	BH1-E-2-4	1/8" to 1/4"	#8 Wire or 1/4" Plain Rod	100
78101118905	BH1-E-5-8	5/16" - 1/2"	#8 Wire or 1/4" Plain Rod	100
78101118910	BH1-E-9-12	9/16" - 3/4"	#8 Wire or 1/4" Plain Rod	100

UPC/Part Number	Catalog Number	Flange Thickness	Plain Rod Size	Box Qty.
78101118940	BH2-E-2-4	1/8" to 1/4"	3/8"	100
78101118945	BH2-E-5-8	5/16" - 1/2"	3/8"	100
78101118950	BH2-E-9-12	9/16" - 3/4"	3/8"	100

Rod To Beam Hangers



With Thread Impression



UPC/Part Number	Catalog Number	Flange Thickness	Threaded Rod Size	Box Qty.
78101118980	BH4-E-2-4	1/8" to 1/4"	1/4"	100
78101118985	BH4-E-5-8	5/16" - 1/2"	1/4"	100
78101118990	BH4-E-9-12	9/16" - 3/4"	1/4"	100
78101119060	BH6-E-2-4	1/8" to 1/4"	3/8"	100
78101119065	BH6-E-5-8	5/16" - 1/2"	3/8"	100
78101119070	BH6-E-9-12	9/16" - 3/4"	3/8"	100

Note: BH4 and BH6 have thread impressions.

UPC/Part Number	Catalog Number	Flange Thickness	Threaded Rod Size	Box Qty.
78101119020	BH5-E-2-4 *	1/8" to 1/4"	1/4" to 3/8"	100
78101119025	BH5-E-5-8 *	5/16" - 1/2"	1/4" to 3/8"	100
78101119030	BH5-E-9-12 *	9/16" - 3/4"	1/4" to 3/8"	100

*Nuts Required.

Hangers

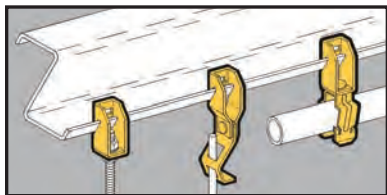

- Compensates for angle of purlin lip.
- Allows for parallel conduit runs or vertical support drops.
- Riveted fasteners will rotate 360°.
- Maximum Purlin thickness of $\frac{3}{32}$ ".

"Z" Purlin Hangers

BF13



BF12



UPC/Part Number	Catalog Number	Description	Static Load Cap. Lbs.	Box Qty.
78101118345	BF13	With $\frac{1}{4}$ " Hole	100	100
78101118340	BF12	For "S" Hooks	100	100



Guide-Rite™
Fastener
BG Series



Push-Type
BP Series

UPC/Part Number	Catalog Number	Conduit Size EMT & Rigid	Static Load Cap. Lbs.	Box Qty.
78101118445	BG-6-F13 *	$\frac{3}{8}$ "	100	100
78101118520	BG-8-12-F13	$\frac{1}{2}$ ", $\frac{3}{4}$ "	100	100
78101118590	BG-16-F13	1"	100	100
78101118675	BG-20-F13	$1\frac{1}{4}$ "	100	100
78101119290	BP-8-F13	$\frac{1}{2}$ " EMT	25	100
78101119390	BP-12-F13	$\frac{3}{4}$ " EMT $\frac{1}{2}$ " IMC, Rigid	25	100
78101119480	BP-16-F13	1" EMT $\frac{3}{4}$ " IMC, Rigid	25	50

* BG-6 will accept the following range $\varnothing.420 - \varnothing.675$:
 $1\frac{1}{2}$ thru $10\frac{1}{4}$ MC/AC cable and $\frac{5}{16}$ or $\frac{3}{8}$ flexible conduit

Read safety/installation instruction sheets in packages before use.

Universal Beam Fasteners



UPC/Part Number	Catalog Number	Description	Static Load Cap.	Box Qty.
78101118920	BH1-F12	#8 Wire or 1/4" Plain Rod	100 Lbs.	100
78101118960	BH2-F12	3/8" Plain Rod	100 Lbs.	100



UPC/Part Number	Catalog Number	Threaded Rod Size	Static Load Cap.	Box Qty.
78101119000	BH4-F12	1/4"	100 Lbs.	100
78101119080	BH6-F12	3/8"	100 Lbs.	100
78101119040	BH5-F12 *	1/4" & 3/8"	100 Lbs.	100

*Nuts Required.

Note: BH4 and BH6 have thread impressions.

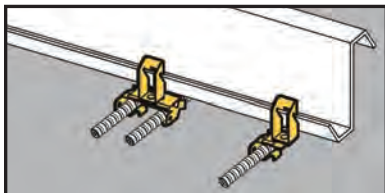

Cable To "Z" Purlin Flange Hangers

- Compensates for angle of purlin lip.
- Attaches MC, AC, sizes 14/2 through 10/3 or 3/8" FMC to "Z" Purlins up to 3/32" thick.
- Fastener will rotate 360°.
- Simply installed with a hammer.



BX4-F13



BX4M-F13



UPC/Part Number	Catalog Number	Description	Flange Thickness	Box Qty.
78101101188	BX4-F13	Single Runs	Thru 3/32"	100
78101101204	BX4M-F13	Double Runs	Thru 3/32"	100

Read safety/installation instruction sheets in packages before use.

Hangers

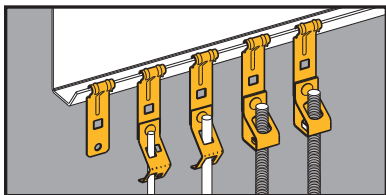

"Z" Purlin Flange Hangers

- Suspend wire, or plain and threaded rod from "Z" Purlins.
- Fits "Z" Purlins 1/16" to 1/4" thick.
- Simply installed with a hammer.
- Static Load Capacity: 160 Lbs.



UPC/Part Number	Catalog Number	Description	Box Qty.
78101104271	BF4	For "S" Hooks, Bolting Straps and Wrap Wire	100

"Z" Purlin Flange Hangers



UPC/Part Number	Catalog Number	Description	Box Qty.
78101104274	BH1-F4	#8 Wire or 1/4" Plain Rod	100
78101104276	BH2-F4	3/8" Plain Rod	100



UPC/Part Number	Catalog Number	Threaded Rod Size	Box Qty.
78101104286	BH4-F4	1/4"	100
78101104280	BH6-F4	3/8"	100
78101104278	BH5-F4 *	1/4" - 3/8"	100

* Nuts required.

Note: BH4 & BH6 have thread impressions.

Hangers

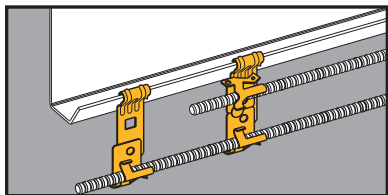

- Attaches MC, AC, sizes 14/2 thru 10/3 or 3/8" FMC to "Z" Purlins.
- Fits "Z" Purlin flanges 1/16" to 1/4" thick.
- Fastener will rotate 360°.

Cable To "Z" Purlin Flange Hangers



UPC/Part Number	Catalog Number	Description	Box Qty.
78101104931	BX4-F4	Single Runs	100

These products are designed for positioning only. No load rating.



UPC/Part Number	Catalog Number	Description	Box Qty.
78101104932	BX4M-F4	Double Runs	100

These products are designed for positioning only. No load rating.

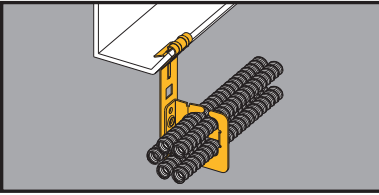

MC/AC Cable Carrier to 'Z' Purlin Flange Hanger

- Secures and supports multiple runs of MC/AC cable to 'Z' purlins.
- Effectively organizes cables and eliminates derating issues.
- Retention tab is open for easy loading and unloading and contains cables when bent in place.
- Load Capacity: 50 lbs.



UPC/Part Number	Catalog Number	Cable Diameter & Number of Runs	Box Qty.
78205144084	BRC51-F4	.430" to .560" Up to 4 Runs	25
78205144085	BRC52-F4	.430" to .560" Up to 9 Runs	25
78205144086	BRC53-F4	.560" to .690" Up to 7 Runs	25

Read safety/installation instruction sheets in packages before use.

Hangers

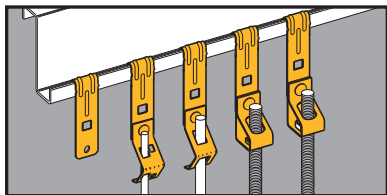

- Suspend wire, or plain and threaded rod from vertical flanges.
- Fits vertical flanges 1/16" to 1/4" thick.
- Static Load Capacity: 160 Lbs.

Vertical Flange Hangers



UPC/Part Number	Catalog Number	Description	Box Qty.
78101104270	BF3	For "S" Hooks, Bolting Straps and Wrap Wire	100

Vertical Flange Hangers



UPC/Part Number	Catalog Number	Description	Box Qty.
78101104273	BH1-F3	#8 Wire or 1/4" Plain Rod	100
78101104275	BH2-F3	3/8" Plain Rod	100



4 1/4"
Overall Height

UPC/Part Number	Catalog Number	Threaded Rod Size	Box Qty.
78101104285	BH4-F3	1/4"	100
78101104279	BH6-F3	3/8"	100
78101104933	BH5-F3 *	1/4", 3/8"	100

* Nuts required.

Read safety/installation instruction sheets in packages before use.

Hangers

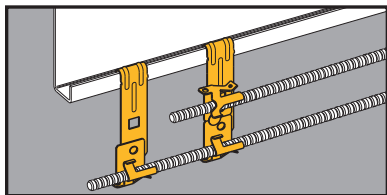

Cable To Vertical Flange Hangers

- Attaches MC, AC, sizes 14/2 through 10/3 or 3/8" flexible conduit FMC to vertical flanges 1/16" to 1/4" thick.
- Fastener will rotate 360°.
- Simply installed with a hammer.



UPC/Part Number	Catalog Number	Description	Box Qty.
78101104281	BX4-F3	Single Runs	100

This product is designed for positioning only. No load rating.



UPC/Part Number	Catalog Number	Description	Box Qty.
78101104282	BX4M-F3	Double Runs	100

This product is designed for positioning only. No load rating.

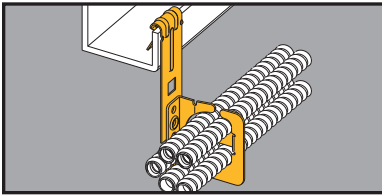

MC/AC Cable Carrier To Vertical Flange Hanger

- Secures and supports multiple runs of MC/AC cable to vertical flanges.
- Effectively organizes cables and eliminates derating issues.
- Retention tab is open for easy loading and unloading and contains cables when bent in place.
- Load Capacity: 50 lbs.



UPC/Part Number	Catalog Number	Cable Diameter & Number of Runs	Box Qty.
78205144081	BRC51-F3	.430" to .560" Up to 4 Runs	25
78205144084	BRC52-F3	.430" to .560" Up to 9 Runs	25
78205144083	BRC53-F3	.560" to .690" Up to 7 Runs	25

Read safety/installation instruction sheets in packages before use.

Hangers

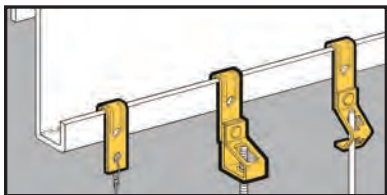

- Suspend wire, or plain or threaded rod from vertical flanges.
- Fits vertical flanges 1/16" to 1/4" thick.
- Static Load Capacity: 160 Lbs.

Vertical Flange Hangers



UPC/Part Number	Catalog Number	Flange Thickness	Description	Box Qty.
78101118310	BF1	1/16" - 5/32"	For "S" Hooks, Bolting Straps and Wrap Wire	100
78101118315	BF2	5/32" - 1/4"	For "S" Hooks, Bolting Straps and Wrap Wire	100



UPC/Part Number	Catalog Number	Flange Thickness	Description	Box Qty.
78101118915	BH1-F1	1/16" - 5/32"	#8 Wire or 1/4" Plain Rod	100
78101118925	BH1-F2	5/32" - 1/4"	#8 Wire or 1/4" Plain Rod	100

Vertical Flange Hangers



UPC/Part Number	Catalog Number	Flange Thickness	Plain Rod Size	Box Qty.
78101118955	BH2-F1	1/16" - 5/32"	3/8"	100
78101118965	BH2-F2	5/32" - 1/4"	3/8"	100



UPC/Part Number	Catalog Number	Flange Thickness	Threaded Rod Size	Box Qty.
With Thread Impression				
78101118995	BH4-F1	1/16" - 5/32"	1/4"	100
78101119075	BH6-F1	1/16" - 5/32"	3/8"	100
78101119005	BH4-F2	5/32" - 1/4"	1/4"	100
78101119085	BH6-F2	5/32" - 1/4"	3/8"	100

With Clearance Hole

78101118995	BH5-F1 *	1/16" - 5/32"	1/4", 3/8"	100
78101119075	BH5-F2 *	5/32" - 1/4"	1/4", 3/8"	100

* Nuts required.

Hangers

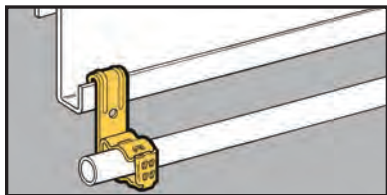

Conduit To Vertical Flange Hangers



- Supports $\frac{3}{8}$ " to 1" conduit from vertical flanges $\frac{1}{16}$ " to $\frac{1}{4}$ " thick.
- Patented Guide-Rite™ feature ensures fastener will close and lock every time.
- Simply installed with a hammer and pliers.
- Static Load Capacity: 25 Lbs.

Guide-Rite™
Fastener



UPC/Part Number	Catalog Number	Conduit Size	Flange Thickness	Box Qty.
78101119957	BG-6-F1 *	$\frac{3}{8}$ "	$\frac{1}{16}$ " - $\frac{5}{32}$ "	100
78101119960	BG-6-F2 *	$\frac{3}{8}$ "	$\frac{5}{32}$ " - $\frac{1}{4}$ "	100
78101119958	BG-8-12-F1	$\frac{1}{2}$ " & $\frac{3}{8}$ "	$\frac{1}{16}$ " - $\frac{5}{32}$ "	100
78101119961	BG-8-12-F2	$\frac{1}{2}$ " & $\frac{3}{8}$ "	$\frac{5}{32}$ " - $\frac{1}{4}$ "	100
78101119958	BG-16-F1	1"	$\frac{1}{16}$ " - $\frac{5}{32}$ "	100
78101119961	BG-16-F2	1"	$\frac{5}{32}$ " - $\frac{1}{4}$ "	100

Patent #4958792

* BG-6 will accept the following range $\varnothing.420$ - $\varnothing.675$:
14/2 thru 10/4 MC/AC cable and $\frac{5}{16}$ or $\frac{3}{8}$ flexible conduit



UPC/Part Number	Catalog Number	Wire Size	Flange Thickness	Box Qty.
78101103556	BRC3-F1	14/2 & 12/2 With Ground	$\frac{1}{16}$ " - $\frac{5}{32}$ "	100
78101103557	BRC3-F2	14/2 & 12/2 With Ground	$\frac{5}{32}$ " - $\frac{1}{4}$ "	100

Note: These products are designed for positioning only. No load rating.

Hangers

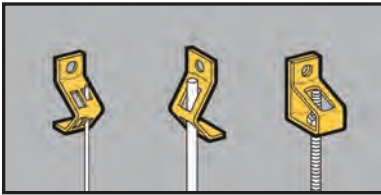

- BH1, BH2: Supports wire or plain rod.
- BH7, BH8: For wire or chain drop from concrete or wood.
- BH4, BH5, BH6 supports 1/4" or 3/8" threaded rod.
- Static Load Capacity: 160 Lbs.

Components

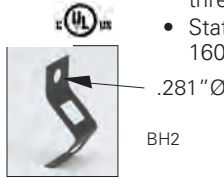

UPC/Part Number	Catalog Number	Description	Box Qty.
78101118800	BH1	#8 Wire or 1/4" Plain Rod	100
78101118805	BH2	For 3/8" Plain Rod	100

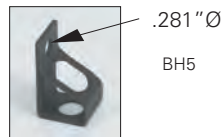
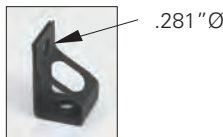
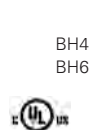

UPC/Part Number	Catalog Number	Description	Box Qty.
78101118815	BH4	For 1/4" Threaded Rod	100
78101118825	BH6	For 3/8" Threaded Rod	100
78101118820	BH5 *	For 1/4" & 3/8" Threaded Rod	100

* Nuts required.

Note: BH4 & BH6 have thread impressions.



BH8

UPC/Part Number	Catalog Number	Description	Box Qty.
78101118830	BH7	Angle Bracket With .281"Ø Holes	100
78101118835	BH7-6	Angle Bracket With .281"Ø & .406"Ø Holes	100
78101118840	BH8	Offset Bracket With .281"Ø Holes	100
78101118845	BH8-6	Offset Bracket With .281"Ø & .406"Ø Holes	100

Read safety/installation instruction sheets in packages before use.

Hangers

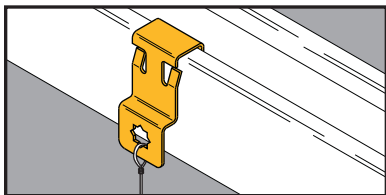

- The BSC4 Series provides a simple, snap-on attachment to strut, eliminating the need for tools and/or drilling during installation.

Strut Fasteners



- Ideal for retrofit and add-on applications.
- BSC4 provides a 1/4" mounting hole along the side of a standard strut member.
- Riveted assemblies allow for easy attachment of conduit, cable and rod.

UPC/Part Number	Catalog Number	Description	Load Capacity	Box Qty.
78205146573	BSC4	Strut Clip	60 lbs.	100



UPC/Part Number	Catalog Number	Rod Size	Load Capacity	Box Qty.
78205146581	BH4-SC4	1/4"-20	60 lbs.	100
78205146582	BH6-SC4	3/8"-16	60 lbs.	100

Hangers



BG-SC4



BP-SC4



BL14-SC4

UPC/Part Number	Catalog Number	Conduit Size	Load Capacity	Box Qty.
78205146577	BG6-SC4	MC/AC & 3/8"	25 lbs.	100
78205146578	BG812-SC4	1/2" & 3/4"	25 lbs.	100
78205146579	BP8-SC4	1/2"	15 lbs.	100
78205146580	BP12-SC4	3/4"	15 lbs.	100
78205146588	BL1400-SC4	1/2"	60 lbs.	100
78205146589	BL1410-SC4	3/4"	60 lbs.	100
78205146590	BL1420-SC4	1"	60 lbs.	100



BX4M-SC4



BRC5-SC4

UPC/Part Number	Catalog Number	Cable Size Runs	Load Capacity	Box Qty.
78205146584	BX4M-SC4	14/2 - 10/3 up to 2 runs	-	100
78205146585	BRC51-SC4	.430" to .560" up to 4 runs	50 lbs.	100
78205146586	BRC52-SC4	.430" to .560" up to 9 runs	50 lbs.	100
78205146587	BRC53-SC4	.560" to .690" up to 7 runs	50 lbs.	100

Read safety/installation instruction sheets in packages before use.

Hangers

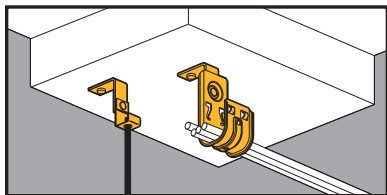

Drive Pin Fasteners



BPNA



BCH21-PNA
BCH32-PNA



BH-PNA



BH1-PNA
BH2-PNA

- Special support bracket allows clearance for powder actuated tools.
- Exclusive 1¹/₄" drive pin now pre-installed.
- Pins rated for concrete up to 4000 psi.
- Static Load Capacity: 30 Lbs. unless specified. Limited by fastener assembly. Pin rating must be considered before installation.

UPC/Part Number	Catalog Number	Description	Box Qty.
78205125583	BPNA	Angle Bracket	100
78205128090	BCH12-PNA	3/4" Cable Hook	100
78205125584	BCH21-PNA	1 ⁵ / ₁₆ " Cable Hook	50
78205125586	BCH32-PNA	2" Cable Hook	50
78205125588	BCH64-PNA	4" Cable Hook	25
78205125611	BH-PNA	Strap Hanger	100
78205125593	BH1-PNA	#8 Wire or 1/4" Plain Rod	100
78205125596	BH2-PNA	3/8" Plain Rod	100

Read safety/installation instruction sheets in packages before use.

Drive Pin Fasteners



BH_PNA



BG_PNA



BP_PNA



BL14_PNA



BX4_PNA



BX4M_PNA

UPC/Part Number	Catalog Number	Description	Box Qty.
78205125604	BH4-PNA *	1/4" Threaded Rod	100
78205125606	BH6-PNA *	3/8" Threaded Rod Cable Hook	100
78205125605	BH5-PNA **	1/4" or 3/8" Threaded Rod	100
78205125613	BG6-PNA ***	3/8" Conduit	100
78205125615	BG8-12-PNA	1/2" & 3/4" Conduit	100
78205125616	BG16-PNA	1" Conduit	100
78205125623	BP8-PNA	1/2" EMT	100
78205125624	BP12-PNA	3/4" EMT	100
78205125630	BP16-PNA	1" EMT	100
78205125620	BL1400-PNA	1/2" Conduit	100
78205125621	BL1410-PNA	3/4" Conduit	100
78205125622	BL1420-PNA	1" Conduit	100
78205125590	BX4-PNA	Single Run MC, AC or FMC	100
78205125591	BX4M-PNA	Double Run MC, AC or FMC	100

* With threaded impressions. ** Nuts required.

*** BG-6 will accept the following range Ø.420 - Ø.675:

14/2 thru 10/4 MC/AC cable and 5/16 or 3/8 flexible conduit

Hangers

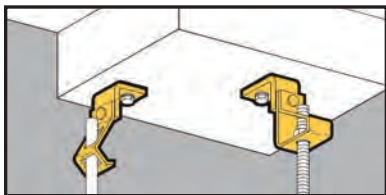

Angle Bracket Fasteners

- Suspend plain or threaded rod and drop wire from ceilings, walls, concrete beams, joists and laminated wood beams.
- Clearance hole for 1/4" bolt provided.
- Static Load Capacity: 160 Lbs.



UPC/Part Number	Catalog Number	Description	Box Qty.
78101118930	BH1-H7	#8 Wire or 1/4" Plain Rod	100
78101118975	BH2-H7	For 3/8" Plain Rod	100



UPC/Part Number	Catalog Number	Threaded Rod Size	Box Qty.
78101119010	BH4-H7	1/4"-20	100
78101119090	BH6-H7	3/8"-16	100
78101119050	BH5-H7 *	1/4"-20 or 3/8"-16	100

* Nuts required.

Note: BH4 & BH6 have thread impressions.

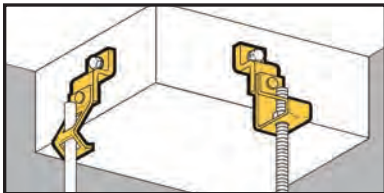

- Suspend plain or threaded rod and drop wire from ceilings, walls, beams, and joists.
- Clearance hole for 1/4" bolt provided.
- Static Load Capacity: 160 Lbs.

Offset Bracket Fasteners



UPC/Part Number	Catalog Number	Description	Box Qty.
78101118935	BH1-H8	#8 Wire or 1/4" Plain Rod	100
78101118975	BH2-H8	3/8" Plain Rod	100



UPC/Part Number	Catalog Number	Threaded Rod Size	Box Qty.
78101119015	BH4-H8	1/4"-20	100
78101119095	BH6-H8	3/8"-16	100
78101119055	BH5-H8 *	1/4"-20 or 3/8"-16	100

* Nuts required.

Note: BH4 & BH6 have thread impressions.

Hangers

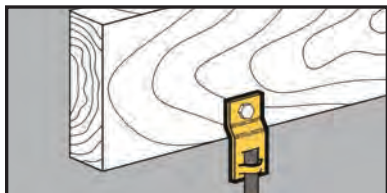

- Suspend 3/8" threaded rod from ceilings, walls, beams, and joists.
- Finish: Zinc Plated
- Static Load Capacity: 610 Lbs.

Threaded Rod Hangers

.406" Ø



UPC/Part Number	Catalog Number	Description	Box Qty.
78101101661	B3223-3/8	Offset Eye Socket	100

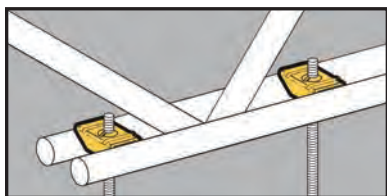

- Allows centering on all open web joists with round bottom chords.
- Static Load Capacity:
BH11 = 200 Lbs.
BH12 = 100 Lbs.

Wedge Hangers



BH11



BH12



UPC/Part Number	Catalog Number	Description	Box Qty.
78101118860	BH11	With 3/8" Clearance Hole	100
78101118865	BH12	With 1/4"-20 Thread Impression	100

Hangers

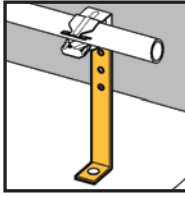
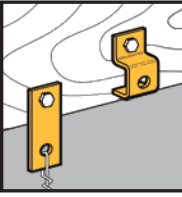

- Brackets are easily attached with screws or drive pins to wood, concrete or steel structures.
- Brackets are adaptable for use with a wide variety of fasteners, wires, "S" hooks and hangers.



BD2



BD4



BA28B

UPC/Part Number	Catalog Number	Description	Box Qty.
78101101686	BD2	Flat Bracket	100
78101118280	BD4	Offset Bracket	100
78101101449	BA28B	Angle Bracket	100

Read safety/installation instruction sheets in packages before use.

Lathers Channel

Lathers Channel

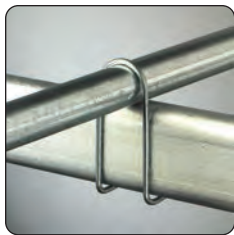

Lathers Channel

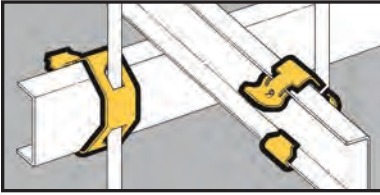

Rod & Wire Fasteners

- For fastening standard lathers channels to wires and plain rods.
- Fits 1/2" through 5/8" channel flange widths.
- Accepted for use by the City of New York Department of Buildings. MEA 383-91-M.
- Static Load Capacity: 160 Lbs.



BL-24-2



Side Mounts

BL-24-4

UPC/Part Number	Catalog Number	Channel Size	Rod/Wire Size	Box Qty.
78101119882	BL-24-2	1 1/2"	#8 Wire	100
78101119883	BL-24-4	1 1/2"	1/4"	100
78101119885	BL-32-4	2"	1/4"	100



Center Mount



UPC/Part Number	Catalog Number	Channel Size	Rod/Wire Size	Box Qty.
78101119884	BL-24-4C	1 1/2"	1/4" Rod	100

Read safety/installation instruction sheets in packages before use.

Lathers Channel

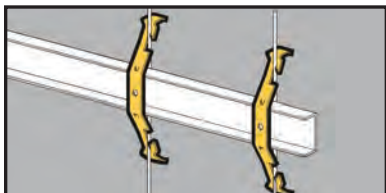

- For fastening standard 1 1/2" lathers channel to wires and plain rods.
- Wire size: #8 and #9.
- Rod size: 3/16" and 1/4".
- Fits 9/16" thru 5/8" channel flange widths.
- Static Load Capacity: 100 Lbs.

Rod & Wire Fasteners



UPC/Part Number	Catalog Number	Description	Box Qty.
78101119880	BL1	Channel to Rod & Wire	100

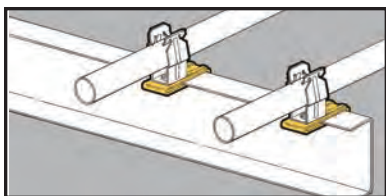

- Serves as a mounting base for conduit fasteners or electrical boxes.
- Attaches to either flange of lathers channel with 1/4"-20 screw (furnished).
- Fits channel flange widths up to 5/8".

Flange Fasteners



UPC/Part Number	Catalog Number	Description	Box Qty.
78101119881	BL2	Flange Fastener with Screw	100

Note: This product is designed for positioning only. No load rating.

Lathers Channel

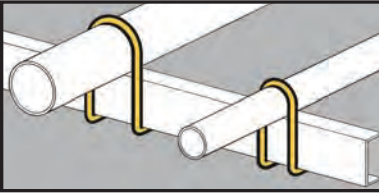

- Fastens EMT to 1 1/2" lathers channel.
- Static Load Capacity: 50 Lbs.
- Finish: Zinc Plated

Conduit Fasteners

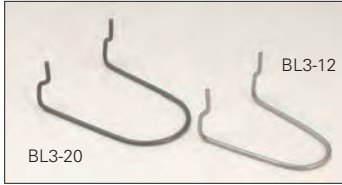

UPC/Part Number	Catalog Number	EMT Conduit Size	Box Qty.
78101119902	BL3-8	1/2"	100
78101119903	BL3-12	3/4"	100
78101119904	BL3-16	1"	100
78101119905	BL3-20	1 1/4"	100

Lathers Channel

Read safety/installation instruction sheets in packages before use.

Communication & Low Voltage

Communication & Low Voltage

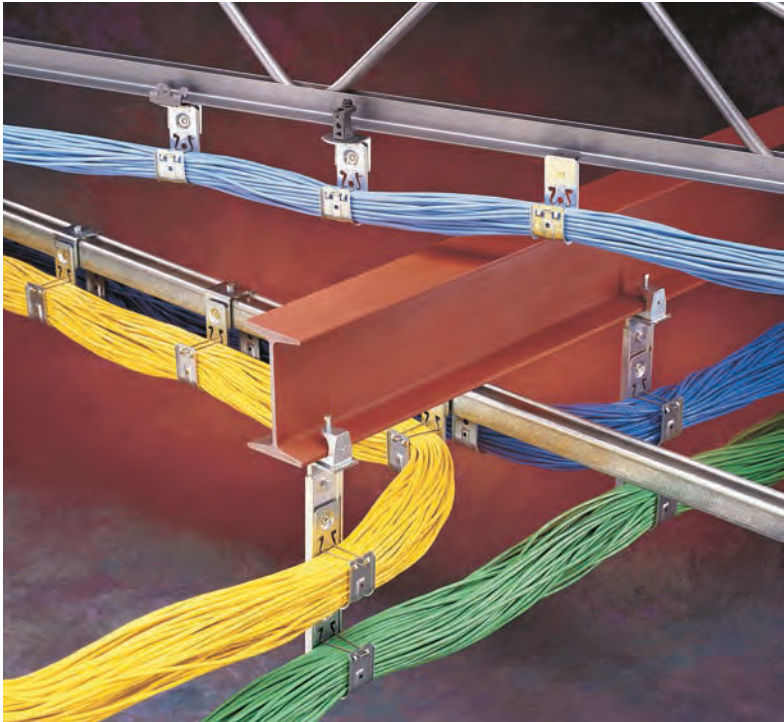

Communication & Low Voltage

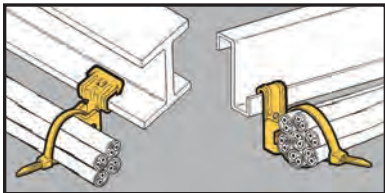

- Supports cable ties up to $\frac{9}{32}$ " wide from flanges $\frac{1}{16}$ " to $\frac{3}{4}$ " thick.
- 8" cable tie included.
- Simply installed with a hammer.

Cable Fasteners



UPC/Part Number	Catalog Number	Description	Box Qty.
78101119970	BE-2-4-CT2	$\frac{1}{8}$ " to $\frac{1}{4}$ "	100
78101119971	BE-5-8-CT2	$\frac{5}{16}$ " to $\frac{1}{2}$ "	100
78101119972	BE-9-12-CT2	$\frac{9}{16}$ " to $\frac{3}{4}$ "	100
78101119968	BF1-CT2	$\frac{1}{16}$ " to $\frac{5}{32}$ "	100
78101119969	BF2-CT2	$\frac{5}{32}$ " to $\frac{1}{4}$ "	100

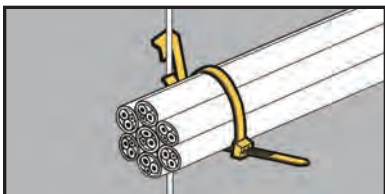

- Supports cable ties up to $\frac{9}{32}$ " wide from drop wires.
- 8" cable tie included.

Cable Fasteners



UPC/Part Number	Catalog Number	Description	Box Qty.
78101102866	BW2-CT2	#12 wire thru $\frac{1}{4}$ " plain or threaded rod	100
78101195603	BW6-CT2	$\frac{3}{8}$ " plain or threaded rod	100

Read safety/installation instruction sheets in packages before use.
These products are designed for positioning only. No load rating.

Communication & Low Voltage

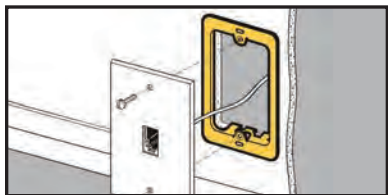

- Replaces electrical box in Class 2 low voltage installations.
- Provides attachment base for low voltage outlets.
- Accepts Decora®* style cover plates.
- Maximum 1 1/4" drywall thickness.
- Finish: Pre-galvanized

Cover Plate Mounting Brackets



BB10



BB10-2



BB10-3



BB10-4



BB20

UPC/Part Number	Catalog Number	Description	Box Qty.
78101118150	BB10	Single Gang Bracket	50
78101118152	BB10-2	Mounts Two (2) Single Plates	10
78101119878	BB10-3	Mounts Three (3) Single Plates	10
78101119879	BB10-4	Mounts Four (4) Single Plates	10
78101118130	BB20	Double Gang Bracket	10

Patent # Re.33305

* Decora® is a registered trademark of Leviton Corporation.

Read safety/installation instruction sheets in packages before use.
These products are designed for positioning only. No load rating.

Communication & Low Voltage

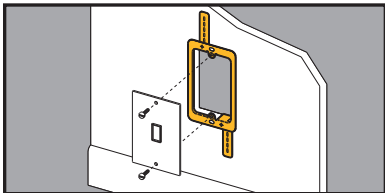

- Replaces electrical box in Class 2 low voltage installations.
- Provides attachment base for low voltage outlets.
- Maximum 1 1/4" drywall thickness.
- Finish: Pre-galvanized

Cover Plate Mounting Bracket



BB10L



BB20L

UPC/Part Number	Catalog Number	Description	Box Qty.
78101190895	BB10L	Single Gang Bracket	50
78101190896	BB20L	Double Gang Bracket	50

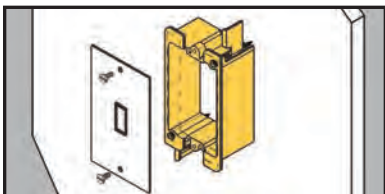

- Provides attachment base for low voltage outlets.
- Replaces electrical box in Class 2 low voltage installations.
- Design eliminates sharp edges from bracket.
- Maximum wall thickness: 3/4"

Plastic Cover Plate Mounting Bracket



UPC/Part Number	Catalog Number	Description	Box Qty.
78205139235	BB10P	Single Gang Bracket	50

Read safety/installation instruction sheets in packages before use.
These products are designed for positioning only. No load rating.

Communication & Low Voltage

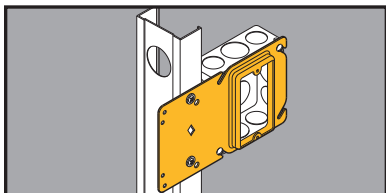

- Uni-Mount offers a secure box support for 4" square boxes and features a built-in plaster ring.
- Rigid bracket design eliminates the need for far-side support.
- Replaces electrical boxes in Class 2 low voltage installations.
- Guide tabs ensure consistent alignment on studs.
- Finish: Pre-galvanized

Uni-Mount Box Support/Cover Plate Mounting Brackets



Single Gang

UPC/Part Number	Catalog Number	Description	Box Qty.
78205122768	BB40-08	1/2" Raise	50
78205122771	BB40-10	5/8" Raise	50
78205122772	BB40-12	3/4" Raise	50



Double Gang

UPC/Part Number	Catalog Number	Description	Box Qty.
78205122773	BB45-08	1/2" Raise	50
78205122774	BB45-10	5/8" Raise	50
78205122775	BB45-12	3/4" Raise	50

Read safety/installation instruction sheets in packages before use. These products are designed for positioning only. No load rating.

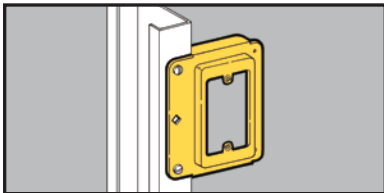

Cover Plate Mounting Bracket



- Locates communication outlets before drywall is installed.
- Replaces electrical box in Class 2 low voltage installations.
- For 1/2" and 5/8" drywall applications.
- Finish: Pre-galvanized

UPC/Part Number	Catalog Number	Description	Box Qty.
78101119873	BB15	Single Gang Stud Bracket	25

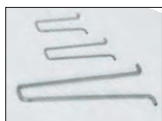
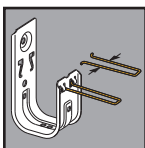

Replacement Cable Retainer Clips

- Cable retainer clips are included with all cable hook purchases.
- Provides secure containment of cables and offers quick open/close feature to add or remove cables.
- Finish: Pre-galvanized



Retainer in open position

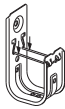

Push retainer down to lock

UPC/Part Number	Catalog Number	Cable Retainer For Hook Size	Box Qty.
78101104847	BCHR21	1/2" Raise	50
78101104848	BCHR32	5/8" Raise	50
78101104849	BCHR64	3/4" Raise	50

Patent #5961081

Read safety/installation instruction sheets in packages before use. These products are designed for positioning only. No load rating.

Communication & Low Voltage

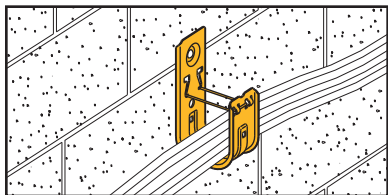

- Supports Cat. 5/5e/6/6A fiber optic, innerduct and low voltage cabling requirements.
- Cable retainer clips are included with hooks.
- Static Load Capacity: 30 Lbs.
- Finish: Pre-Galvanized

Cable Hooks

Communication & Low Voltage

BCH12



Open



Closed



BCH21



BCH32



BCH64



UPC/Part Number	Catalog Number	Hook Size	Capacity Up To	Box Qty.
78205128060	BCH12	3/4"	16 4-Pair UTP Cat 5e or 2-Strand Fiber Optic Cable or 10 CAT6	50
78101104713	BCH21	1 ⁵ / ₁₆ "	50 4-Pair UTP Cat 5e or 2-Strand Fiber Optic Cable or 32 CAT6 or 18 CAT6A	50
78101104713	BCH32	2"	50 4-Pair UTP Cat 5e or 2-Strand Fiber Optic Cable or 50 CAT6 or 25 CAT6A	50
78101104713	BCH64	4"	50 4-Pair UTP Cat 5e or 2-Strand Fiber Optic Cable or 185 CAT6 or 98 CAT6A	25

Patent #5961081

For special finish colors see page 156

(See pages 239-240 for technical data.)



Painted Cable Hooks

- Powder coated cable hooks are available in a range of colors to help meet your cable identification requirements.
- Standard riveted assemblies are available with painted cable hooks.
- Part numbers can be made by adding the paint color suffix after the cable hook part number.
- Minimum order quantity 500 pieces.
- Standard lead time is 5-10 working days.

Bright White - BW
Brown - BR
Computer White - CW
Equipment Blue - BL
Flat Black - FB

Green - GR
Orange - OR
Regal Red - RR
Safety Yellow - YL
Telcom Gray - TG

Part # Example:

Painted Cable Hook Part Number - BCH32BW

Painted Cable Hook Assembly - BCH32BW-U24



J-Hook Color ID Clip

- Color-coded clips allow for content designation without inventorying various colored hardware.
- Easy to designate pathways to prevent crossover.
- Order separately and field install.
- Can be snapped on J-Hook after it has been installed.
- Manufactured from Underwriters Laboratories (UL) Listed material for plenum spaces.
- Suitable for 3/4", 1⁵/₁₆", 2", and 4" J-Hook sizes.
- Available in six (6) colors:
Blue (BL), White (WH), Gray (GY), Orange (OR), Red (RD), and Yellow (YW).

Part # Example:

Blue Colored ID Clip Part Number

BCHID-BL12 - blue clip for BCH12 J-Hook

Read safety/installation instruction sheets in packages before use.

Communication & Low Voltage

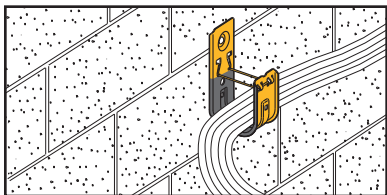

- Xylan® coating provides smooth frictionless surface for cable pulling.
- Great for use in corners, drop-outs or direction change.
- X-Hook has lower coefficient of friction than Teflon®.
- Cable retainer clips are included with hooks.
- Static Load Capacity: 30 Lbs.

X-Hook Low Friction Cable Hooks



BCH64X

New Xylan® coating reduces cable friction. Ideal for pulling cable.



Cable rollers are too expensive and require installation and removal.

UPC/Part Number	Catalog Number	Hook Size	Capacity	Box Qty.
78205129940	BCH21X	1 ⁵ / ₁₆ "	50 4-Pair UTP Cat 5e or 2-Strand Fiber Optic Cable or 32 CAT6 or 18 CAT6A	50
78205129941	BCH32X	2"	80 4-Pair UTP Cat 5e or 2-Strand Fiber Optic Cable or 50 CAT6 or 25 CAT6A	50
78205129942	BCH64X	4"	300 4-Pair UTP Cat 5e or 2-Strand Fiber Optic Cable or 185 CAT6 or 98 CAT6A	25

Note: For cable hook assemblies with X-Hooks add an X to the part number.

Example: BCH32X-U-2-4

(See pages 239-240 for technical data.)

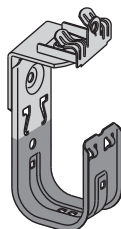

Xylan® is a registered trademark used by Whitford Corporation
Teflon® is a registered trademark used by DuPont®

Communication & Low Voltage

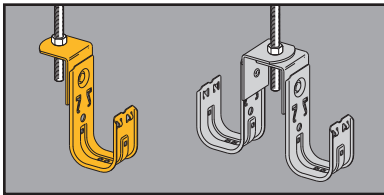

Cable To ATR Fasteners



- .505" diameter hole designed to support cable from 3/8" or 1/2" threaded rod.
- Allows back-to-back and multi-tier installations.
- Cable retainer clips are included with hooks.
- Static Load Capacity: 30 Lbs.
- Finish: Pre-galvanized

UPC/Part Number	Catalog Number	Hook Size	Hole Size	Box Qty.
78101104725	BCH21-AB	15/16"	.505" Diameter	50
78101104729	BCH32-AB	2"	.505" Diameter	50
78101104732	BCH64-AB	4"	.505" Diameter	25

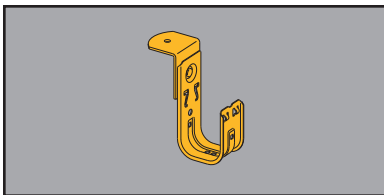

Angle Bracket Cable Fasteners



- Designed for direct attachment to structures.
- Supports cable from 1/4" threaded rod.
- .265" diameter hole accepts anchors, screws or common nails.
- Cable retainer clips are included with hooks.
- Static Load Capacity: 30 Lbs.
- Finish: Pre-galvanized

UPC/Part Number	Catalog Number	Hook Size	Hole Size	Box Qty.
78205128089	BCH12-RB	3/4"	.265" Diameter	50
78101104735	BCH21-RB	15/16"	.265" Diameter	50
78101104738	BCH32-RB	2"	.265" Diameter	50
78101104742	BCH64-RB	4"	.265" Diameter	25

(See pages 239-240 for technical data.)

Read safety/installation instruction sheets in packages before use.

Communication & Low Voltage

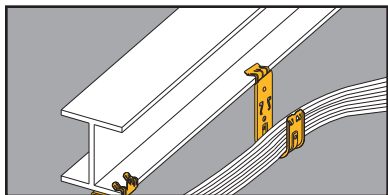

- Permits fast and easy installation on beam flanges.
- Cable retainer clips are included with hooks.
- Static Load Capacity: 30 Lbs.
- Finish: Pre-galvanized

Cable To Beam Fasteners



UPC/Part Number	Catalog Number	Hook Size	Flange Thickness	Box Qty.
78205128067	BCH12-E-2-4	3/4"	1/8" to 1/4"	50
78205128072	BCH12-E-5-8	3/4"	5/16" to 1/2"	50
78205128073	BCH12-E-9-12	3/4"	9/16" to 3/4"	50
78101104803	BCH21-E-2-4	1 5/16"	1/8" to 1/4"	50
78101104805	BCH21-E-5-8	1 5/16"	5/16" to 1/2"	50
78101104807	BCH21-E-9-12	1 5/16"	9/16" to 3/4"	50
78101104825	BCH32-E-2-4	2"	1/8" to 1/4"	50
78101104827	BCH32-E-5-8	2"	5/16" to 1/2"	50
78101104829	BCH32-E-9-12	2"	9/16" to 3/4"	50

(See pages 239-240 for technical data.)

Communication & Low Voltage

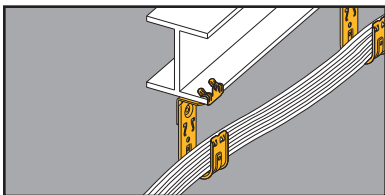

Cable To Beam Fasteners

- Permits fast and easy installation on beam flanges.
- Cable retainer clips are included with hooks.
- Static Load Capacity: 30 Lbs.
- Finish: Pre-galvanized



Allows
360°
Rotation



UPC/Part Number	Catalog Number	Hook Size	Flange Thickness	Box Qty.
78205128062	BCH12-U-2-4	3/4"	1/8" to 1/4"	50
78205128064	BCH12-U-5-8	3/4"	5/16" to 1/2"	50
78205128066	BCH12-U-9-12	3/4"	9/16" to 3/4"	50
78101104809	BCH21-U-2-4	1 5/16"	1/8" to 1/4"	50
78101104811	BCH21-U-5-8	1 5/16"	5/16" to 1/2"	50
78101104813	BCH21-U-9-12	1 5/16"	9/16" to 3/4"	50
78101104831	BCH32-U-2-4	2"	1/8" to 1/4"	50
78101104833	BCH32-U-5-8	2"	5/16" to 1/2"	50
78101104835	BCH32-U-9-12	2"	9/16" to 3/4"	50
78101104864	BCH64-U-2-4	4"	1/8" to 1/4"	25
78101104865	BCH64-U-5-8	4"	5/16" to 1/2"	25
78101104866	BCH64-U-9-12	4"	9/16" to 3/4"	25

(See pages 239-240 for technical data.)

Read safety/installation instruction sheets in packages before use.

Communication & Low Voltage

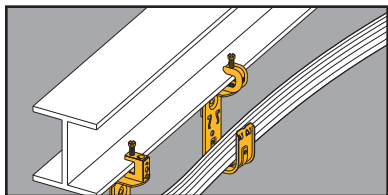

Cable To Beam Fasteners



- 360° rotation allows cable to run in any direction.
- Cable retainer clips are included with hooks.
- Static Load Capacity: 30 Lbs.
- Finish: Pre-galvanized

UPC/Part Number	Catalog Number	Hook Size	Flange Thickness	Box Qty.
78205128077	BCH12-C442	3/4"	1/8" to 5/8"	50
78101104823	BCH21-C442	1 5/16"	1/8" to 5/8"	50
78101104845	BCH32-C442	2"	1/8" to 5/8"	50
78101104868	BCH64-C442	4"	1/8" to 5/8"	25

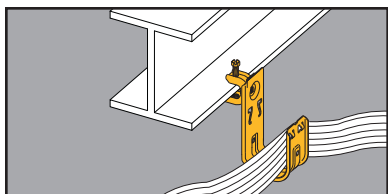

Cable To Beam Fasteners



- 360° rotation allows cable to run in any direction.
- Cable retainer clips are included with hooks.
- Static Load Capacity: 30 Lbs.
- Finish: Pre-galvanized

UPC/Part Number	Catalog Number	Hook Size	Flange Thickness	Box Qty.
78205141850	BCH12-C442A	3/4"	1/8" to 5/8"	50
78205141851	BCH21-C442A	1 5/16"	1/8" to 5/8"	50
78205141852	BCH32-C442A	2"	1/8" to 5/8"	50
78205141853	BCH64-C442A	4"	1/8" to 5/8"	25

(See pages 239-240 for technical data.)

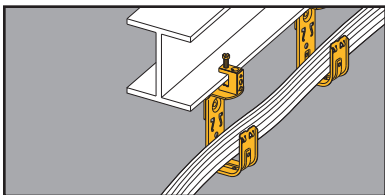

Cable To Beam Fasteners



- 360° rotation allows cable to run in any direction.
- Cable retainer clips are included with hooks.
- Static Load Capacity: 30 Lbs.
- Finish: Pre-galvanized

UPC/Part Number	Catalog Number	Hook Size	Flange Thickness	Box Qty.
78205128074	BCH12-C2	3/4"	thru 1/2"	50
78101104821	BCH21-C2	15/16"	thru 1/2"	50
78101104843	BCH32-C2	2"	thru 1/2"	50
78101104867	BCH64-C2	4"	thru 1/2"	25

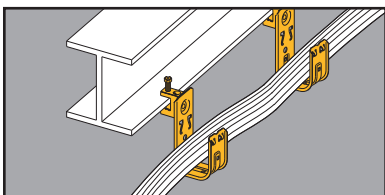

Cable To Beam Fasteners



- Cable retainer clips are included with hooks.
- Static Load Capacity: 30 Lbs.
- Finish: Pre-galvanized

UPC/Part Number	Catalog Number	Hook Size	Flange Thickness	Box Qty.
78205141303	BCH12-C1	3/4"	thru 1/2"	50
78101195578	BCH21-C1	15/16"	thru 1/2"	50
78101195560	BCH32-C1	2"	thru 1/2"	50
78205141304	BCH64-C1	4"	thru 1/2"	25

(See pages 239-240 for technical data.)

Read safety/installation instruction sheets in packages before use.

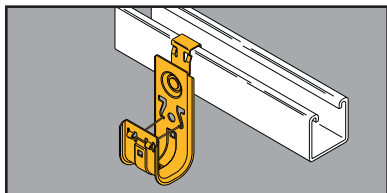

Cable Hook To Strut Attachment

- BSC4 provides a simple snap-on attachment to strut, eliminating the need for tools or drilling.
- Cable retainer clips are included with hooks.
- Great for retrofit applications.
- Load Capacity: 30 Lbs.
- Finish: Pre-galvanized



UPC/Part Number	Catalog Number	Cable Hook Size	Box Qty.
78205146574	BCH12-SC4	3/4"	50
78205146575	BCH21-SC4	15/16"	50
78205146576	BCH32-SC4	2"	50
78205146583	BCH64-SC4	4"	50

(See pages 239-240 for technical data.)

Communication & Low Voltage

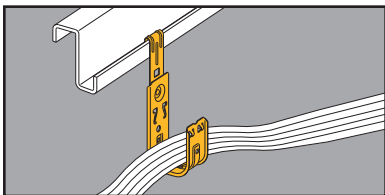

- Supports cable from vertical flanges.
- Cable retainer clips are included with hooks.
- Static Load Capacity: 30 Lbs.
- Finish: Pre-galvanized

Cable To Flange Fasteners



UPC/Part Number	Catalog Number	Hook Size	Flange Thickness	Box Qty.
78205128078	BCH12-F3	3/4"	1/16" to 1/4"	50
78101104815	BCH21-F3	15/16"	1/16" to 1/4"	50
78101104837	BCH32-F3	2"	1/16" to 1/4"	50
78101104869	BCH64-F3	4"	1/16" to 1/4"	25

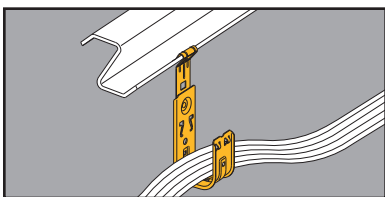

- Supports cable from angled flanges.
- Cable retainer clips are included with hooks.
- Static Load Capacity: 30 Lbs.
- Finish: Pre-galvanized

Cable To Flange Fasteners



UPC/Part Number	Catalog Number	Hook Size	Flange Thickness	Box Qty.
78205128079	BCH12-F4	3/4"	1/16" to 1/4"	50
78101104817	BCH21-F4	15/16"	1/16" to 1/4"	50
78101104839	BCH32-F4	2"	1/16" to 1/4"	50
78101104870	BCH64-F4	4"	1/16" to 1/4"	25

(See pages 239-240 for technical data.)

Read safety/installation instruction sheets in packages before use.

Communication & Low Voltage

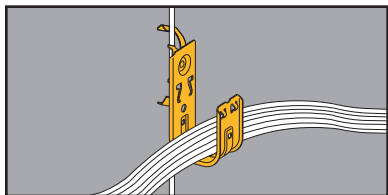

Cable To Wire and Rod Fasteners

Communication & Low Voltage



- Supports cable from #12 wire thru $\frac{3}{8}$ " threaded rod.
- Cable retainer clips are included with hooks.
- W2 series attaches to #12 wire thru $\frac{1}{4}$ " plain or threaded rod.
- W6 series attaches to $\frac{3}{8}$ " plain or threaded rod.
- Static Load Capacity: 25 Lbs.
- Finish: Pre-galvanized

UPC/Part Number	Catalog Number	Description	Box Qty.
78205146573	BCH12-W2	$\frac{3}{4}$ "	50
78101104819	BCH21-W2	$\frac{15}{16}$ "	50
78101104841	BCH32-W2	2"	50
78205128082	BCH12-W6	$\frac{3}{4}$ "	50
78101195567	BCH21-W6	$\frac{15}{16}$ "	50
78101195569	BCH32-W6	2"	50

(See pages 239-240 for technical data.)

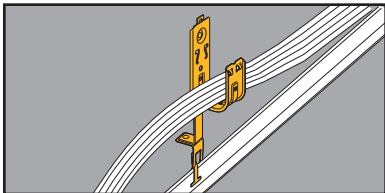

Cable To T-Bar Fasteners

- Supports cable above ceiling grid and allows 360° rotation.
- Provides compliance with the EIA/TIA requirements.
- Permits dropwire attachment if required.
- Cable retainer clips are included with hooks.
- Static Load Capacity: 30 Lbs.
- Finish: Pre-galvanized



UPC/Part Number	Catalog Number	Description	Box Qty.
78205128083	BCH12-A28	3/4"	50
78101104857	BCH21-A28	15/16"	50
78101104858	BCH32-A28	2"	50

(See pages 239-240 for technical data.)

Read safety/installation instruction sheets in packages before use.

Communication & Low Voltage

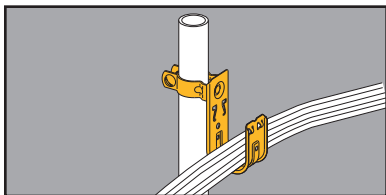

Cable To Floor Support Fasteners



- Supports cable from computer floor post.
- Organizes cable off the floor for a neat installation.
- Cable retainer clips are included with hooks.
- Static Load Capacity: 30 Lbs.
- Finish: Pre-galvanized

UPC/Part Number	Catalog Number	Hook Size	Floor Post Size	Box Qty.
78205128085	BCH12-L1410	3/4"	1" O.D.	50
78101104851	BCH21-L1410	15/16"	1" O.D.	50
78101104855	BCH32-L1410	2"	1" O.D.	50
78101104871	BCH64-L1410	4"	1" O.D.	25

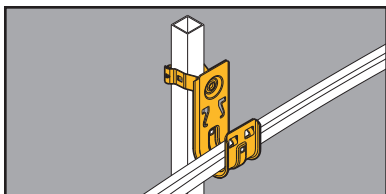

Cable To Floor Support Fasteners



- Supports cable from computer floor post.
- Organizes cable off the floor for a neat installation.
- Cable retainer clips are included with hooks.
- Static Load Capacity: 30 Lbs.
- Finish: Pre-galvanized

UPC/Part Number	Catalog Number	Hook Size	Floor Post Size	Box Qty.
78205128086	BCH12-G-8-12	3/4"	1" Square	50
78101172487	BCH21-G-8-12	15/16"	1" Square	50
78101172489	BCH32-G-8-12	2"	1" Square	50
78101172491	BCH64-G-8-12	4"	1" Square	25

(See pages 239-240 for technical data.)

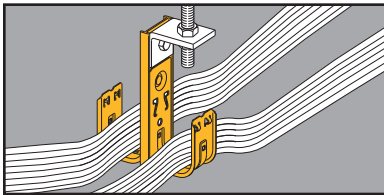

Double-Sided Multi-Tier Cable Fasteners

- Factory assembled multi-tier fasteners speed up installation.
- Unique design prevents hook and assembly rotation when pulling cable.
- All support bars furnished in 6063-T6 aluminum.
- Shown with optional BCHK2 kit.
- Cable retainer clips are included with hooks.
- Static Load Capacity: (per hook) 30 Lbs.
- Finish: Pre-galvanized



1D



2D

UPC/Part Number	Catalog Number	Hook Size	Description	Box Qty.
78101104758	BCH21-1D	1 ⁵ / ₁₆ "	1 Tier, 2-Sided, 5 ¹ / ₂ " High	20
78101104762	BCH32-1D	2"	1 Tier, 2-Sided, 6 ³ / ₁₆ " High	25
78101104874	BCH64-1D	4"	1 Tier, 2-Sided, 9" High	10
78101104766	BCH21-2D	1 ⁵ / ₁₆ "	1 Tier, 2-Sided, 9 ¹ / ₄ " High	10
78101104770	BCH32-2D	2"	1 Tier, 2-Sided, 11" High	10
78101104875	BCH64-2D	4"	1 Tier, 2-Sided, 18 ¹ / ₄ " High	10

Patent #5961081

(See pages 239-240 for technical data.)

Read safety/installation instruction sheets in packages before use.

Communication & Low Voltage

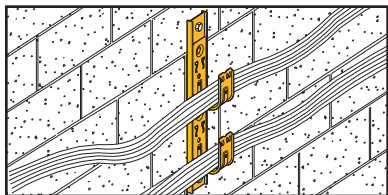

Single-Sided Multi-Tier Cable Fasteners

- Factory assembled multi-tier fasteners speed up installation.
- Available in two-six tier assemblies.
- Unique design prevents hook and assembly rotation when pulling cable.
- Cable retainer clips are included with hooks.
- All support bars furnished in 6063-T6 aluminum.
- Static Load Capacity: 30 Lbs. (per hook)



2S



3S



UPC/Part Number	Catalog Number	Hook Size	Description	Box Qty.
78101104773	BCH21-2S	1 ⁵ / ₁₆ "	2 Tier, 1-Sided, 11" Overall Height	20
78101104776	BCH32-2S	2"	2 Tier, 1-Sided, 12 ³ / ₄ " Overall Height	25
78101195300	BCH64-2S	4"	2 Tier, 1-Sided, 19 ⁵ / ₁₆ " Overall Height	10
78101104779	BCH21-3S	1 ⁵ / ₁₆ "	3 Tier, 1-Sided, 14 ³ / ₄ " Overall Height	10
78101104782	BCH32-3S	2"	3 Tier, 1-Sided, 17 ¹ / ₂ " Overall Height	10
78101195303	BCH64-3S	4"	3 Tier, 1-Sided, 28 ¹ / ₁₆ " Overall Height	10

Patent #5961081

(See pages 239-240 for technical data.)

Communication & Low Voltage



4S



5S



6S



Communication & Low Voltage

UPC/Part Number	Catalog Number	Hook Size	Description	Box Qty.
78101104785	BCH21-4S	1 ⁵ / ₁₆ "	4 Tier, 1-Sided, 18 ¹ / ₂ " Overall Height	10
78101104788	BCH32-4S	2"	4 Tier, 1-Sided, 21 ³ / ₄ " Overall Height	10
78101197872	BCH64-4S	4"	4 Tier, 1-Sided, 36 ¹³ / ₁₆ " Overall Height	10
78101104791	BCH21-5S	1 ⁵ / ₁₆ "	5 Tier, 1-Sided, 21 ³ / ₄ " Overall Height	10
78101104794	BCH32-5S	2"	5 Tier, 1-Sided, 27" Overall Height	10
78101104797	BCH21-6S	1 ⁵ / ₁₆ "	6 Tier, 1-Sided, 26" Overall Height	10
78101104800	BCH32-6S	2"	6 Tier, 1-Sided, 31 ³ / ₄ " Overall Height	10

Patent #5961081

(See pages 239-240 for technical data.)

Read safety/installation instruction sheets in packages before use.

Communication & Low Voltage



Shown with
BRC5
Brackets



Shown with
Cable
Hooks

- The BCH-HBA combines a tiered support bar and angle bracket into one piece.
- More flexibility! The BCH-HBA can be supported from $\frac{3}{16}$ " , $\frac{1}{4}$ " , $\frac{5}{16}$ " or $\frac{3}{8}$ " rod.
- Mounts up to three BCH21 or BCH32 cable hooks or two BCH64 cable hooks per side.
- Mounts up to three BRC5 MC/AC cable support brackets per side.
- Load Capacity: 180 lbs.

Multi-Tier Support Bar



UPC/Part Number	Catalog Number	Description	Box Qty.
78205143819	BCH-HBA	Multi-Tier Support Bar	40

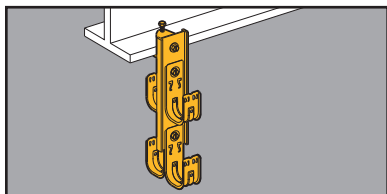

- Support bars furnished in 6063-T6 aluminum.



Multi-Tier Cable Hook Kits



UPC/Part Number	Catalog Number	Description	Box Qty.
78101199572	BCH-HB21	Support Bar for BCH21 and BCH32 $8\frac{1}{4}$ " long with $.281\varnothing$ holes	20
78101199574	BCH-HB64	Support Bar for BCH64 $13\frac{5}{16}$ " long with $.281\varnothing$ holes	20

(See pages 239-240 for technical data.)

Multi-Tier Attachment Kits

- BCHK1 includes:
Beam clamp (B444-1/4)
and 1/4"-20 x 1/2"
hex head cap screw



BCHK1

- BCHK2 includes:
Angle bracket (.320"Ø
and .390"Ø holes) and
1/4"-20 x 1/2"
hex head cap screw



BCHK2

- BCHK3 includes:
1 each BCHK1 Kit and
BCHK2 Kit



BCHK3

UPC/Part Number	Catalog Number	Kit Description	Flange Thickness	Box Qty.
78101104872	BCHK1	Beam Clamp	Thru 1/2"	10
78101104860	BCHK2	Angle Bracket	--	10
78101104873	BCHK3	Beam Clamp with Angle Bracket (swivels 360°)	Thru 1/2"	10

Read safety/installation instruction sheets in packages before use.

Communication & Low Voltage

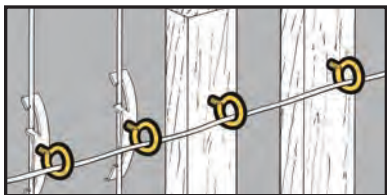

- Supports low voltage communication cables from beams or rods when used with other fasteners.
- *Ultimate Static Load Capacity:* 50 Lbs.
- Finish: Zinc Plated

Threaded Bridle Rings



UPC/Part Number	Catalog Number	Ring Size	Thread Size x Thread Length	Box Qty.
78101119550	BR-8-T	1/2"	#10-24 x 9/16"	100
78101119555	BR-12-T	3/4"	#10-24 x 9/16"	100
78101119560	BR-20-T	1 1/4"	#10-24 x 9/16"	100
78101119570	BR-32-T	2"	#10-24 x 9/16"	100
78101119565	BR-20-4T	1 1/4"	1/4"-20 x 9/16"	100
78101119575	BR-32-4T	2"	1/4"-20 x 9/16"	100
78101119889	BR-64-4T	4"	1/4"-20 x 9/16"	50



Lag Screw
for Wood
Beams

UPC/Part Number	Catalog Number	Ring Size	Thread Size x Thread Length	Box Qty.
78101119875	BR-16-3W	1"	#10 x 9/16"	100
78101119886	BR-24-4W	1 1/2"	1/4" x 27/32"	100
78101119876	BR-32-4W	2"	1/4" x 7/8"	100

Communication & Low Voltage

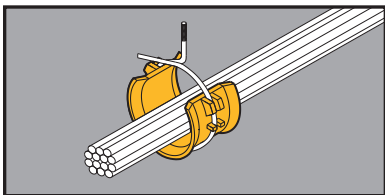

- The convenience of a bridle ring with the cable-bearing surface of a hook.
- 2" saddle is available separately. Can be easily attached before or after cable installation.

Bridle Ring Saddles



BRS-32A



BRS-64A

BRS-32

UPC/Part Number	Catalog Number	Thread Size x Thread Length/Description	Box Qty.
78205122761	BRS-32A	1/4"-20 x 7/8" 2" Ring Assembly	50
78205122762	BRS-64A	1/4"-20 x 1" 4" Ring Assembly	25
78205122759	BRS-32	2" Saddle Only	50

Also available for use with the following B-Line Fasteners.

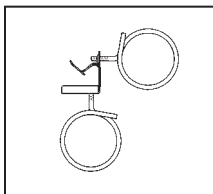

BU-9-12

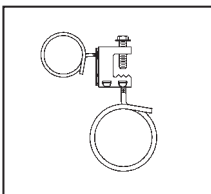

BC1

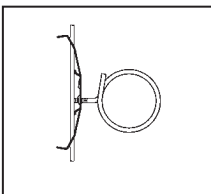

BW2

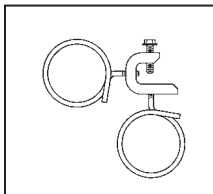

BC442

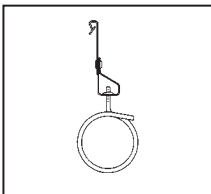

BH4-F3

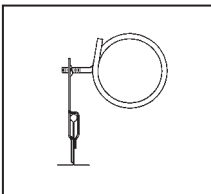

BA5-4T

Read safety/installation instruction sheets in packages before use.

Communication & Low Voltage

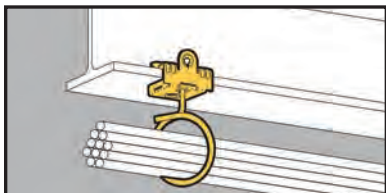

Bridle Ring/Beam Fastener Assy.



- Supports low voltage communication cables from beam flanges 1/8" to 3/4" thick.
- Pre-assembled with 2" bridle ring.
- Reduces installation time.
- Static Load Capacity : 15 lbs.

UPC/Part Number	Catalog Number	Description	Box Qty.
78101102921	BR-32-4T-U-2-4	1/8" to 1/4"	50
78101102923	BR-32-4T-U-5-8	5/16" to 1/2"	50
78101102924	BR-32-4T-U-9-12	9/16" to 3/4"	50

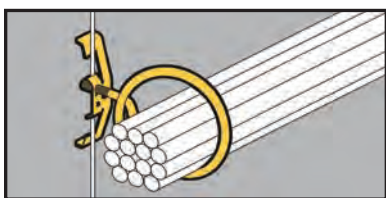

Bridle Ring/Rod & Wire Fastener Assy.



- Supports low voltage communication cables from drop wire.
- Pre-assembled with 2" bridle ring.
- Reduces installation time.
- Static Load Capacity : 15 lbs.

UPC/Part Number	Catalog Number	Description	Box Qty.
78101102929	BR-32-4T-W2	#12 Wire Thru 1/4" Plain or Threaded Rod	50

Communication & Low Voltage

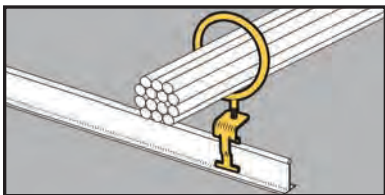

Bridle Ring/T-Bar Fastener Assembly

- Supports low voltage communication cables above the T-Bar.
- Pre-assembled with 2" bridle ring.
- Reduces installation time.
- For positioning only - No Load Rating



UPC/Part Number	Catalog Number	Description	Box Qty.
78101102934	BR-32-4T-A6	2" Ring Size	50

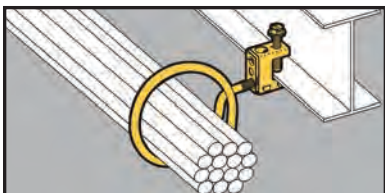

Bridle Ring/Beam Fastener Assembly

- Supports low voltage communication cables from beam flanges thru 1/2" thick.
- Pre-assembled with 2" bridle ring.
- Reduces installation time.
- Static Load Capacity: 15 lbs.



UPC/Part Number	Catalog Number	Description	Box Qty.
78101102937	BR-32-4T-C1	2" Ring Size	50

Read safety/installation instruction sheets in packages before use.

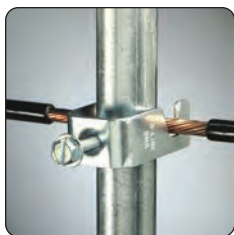

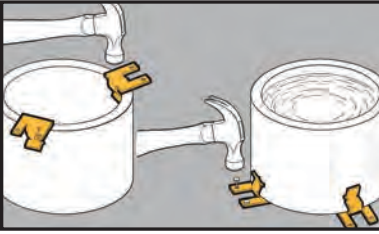

Pipe Sleeve Fasteners



- Allows for rigid attachment of pipe sleeves to wall and floor forms for concrete pouring.
- Accommodates Schedule 40, Schedule 80, or 5/16" and smaller wall thickness.

UPC/Part Number	Catalog Number	Sleeve Diameter	Wall Thickness	Box Qty.
78101118285	BD40	All Dia.	5/16" & Under	100
78101118285	BD40	2" to 6"	Schedule 40 Pipe	100

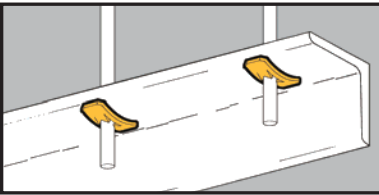

Accessory Nuts



BN-2, BN-4,
BN-6
Push Nuts



BN1
"U" Nuts With
Thread Impression

- Push Nuts designed for use with plain rod.
- "U" Nuts provide 1/4"-20 thread impression for unthreaded hole.
- No installation tools required.

UPC/Part Number	Catalog Number	Rod/Wire Size	Static Load Capacity	Box Qty.
78101110115	BN-2	#8 Wire	100 lbs. thru 3/8" hole	100
78101119120	BN-4	1/4" Plain Rod	100 lbs. thru 3/8" hole	100
78101119125	BN-6	3/8" Plain Rod	200 lbs. thru 1/2" hole	100
78101119110	BN1	1/4" Threaded Rod	50 lbs. on 9/32" hole	100

Read safety/installation instruction sheets in packages before use.

Accessories

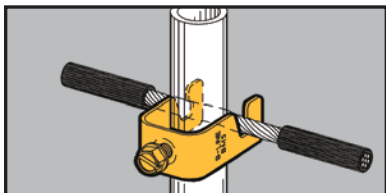

- Attaches signal reference grid wire to computer floor posts.
- Fits #8 thru #4 stranded wire. (.146" O.D. thru .232" O.D.).
- Fits 3/4" to 1" round or square posts.

Reference Wire Fasteners



UPC/Part Number	Catalog Number	Description	Box Qty.
78101101659	BM5	Single Reference Grid Wire Fastener	100

Accessories

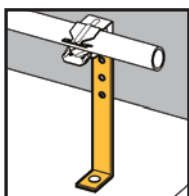
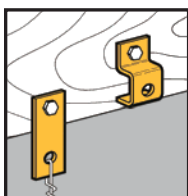

- Brackets are easily attached with screws or drive pins to wood, concrete or steel structures.
- Brackets are adaptable for use with a wide variety of fasteners, wires, "S" hooks and hangers.



BD2



BD4



BA28B

UPC/Part Number	Catalog Number	Description	Box Qty.
78101101686	BD2	Flat Bracket	100
78101118280	BD4	Offset Bracket	100
78101101449	BA28B	Angle Bracket	50

Accessories

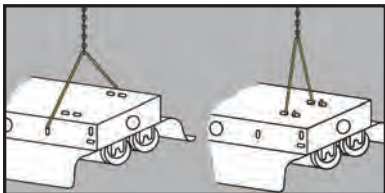

- For hanging industrial class fluorescent lighting fixtures.
- Use with Jack Chain and "S" Hooks.
- Static Load Capacity: 29 Lbs.
- Finish: Zinc Plated

Light Fixture Hangers



BH15



BH16

UPC/Part Number	Catalog Number	Description	Box Qty.
78101101236	BH15	Side Mount Fluorescent Light Fixture Hanger	100
78101101237	BH16	Top Mount Fluorescent Light Fixture Hanger	100

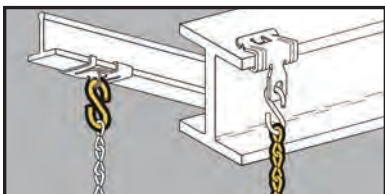

- For support of light fixtures and signs.
- Static Load Capacity: 29 Lbs.
- Finish: Zinc Plated

Jack Chain & "S" Hooks



BH10

BH9
BH9-10



UPC/Part Number	Catalog Number	Description	Box Qty.
78101118850	BH9	#12 Single Jack Chain	100 ft.
78101102901	BH9-10	#10 Single Jack Chain	100 ft.
78101118855	BH10	#11 "S" Hook	50

Read safety/installation instruction sheets in packages before use.

Accessories



KwikWire™ Clamps

- KwikWire™ system replaces jack chain or ATR to support lighting, ductwork, cable tray, etc.
- Can be quickly installed around beams - No drilling required.
- Ideal for sloped ceilings - can hang objects at up to 60° angles.
- Simple height adjustments are made by releasing locking tab, no tools required.
- Spools of wire can be cut to length in field, reducing waste and up front planning.



Accessories

UPC/Part Number	Catalog Number	For Use With Wire Rope Diameters	Box Qty.
78205140719	BKC100	1/16" & 3/32"	100
78205140723	BKC200	1/8" & 3/16"	50

KwikWire Clamp Working Loads*

Clamp Part No.	Wire Rope Dia.	Lbs. Safety Factor 5
BKC100	1/16"	0-75
	3/32"	25-150
BKC200	3/32"	25-150
	1/8"	25-250
	3/16"	50-640

* Working loads shown are for hanging vertically.
 For suspending at 15°, 30°, 45° or 60° angles from vertical use the following percentage of the working loads from the chart:
 15° = 96%, 30° = 86%,
 45° = 70%, 60° = 50%

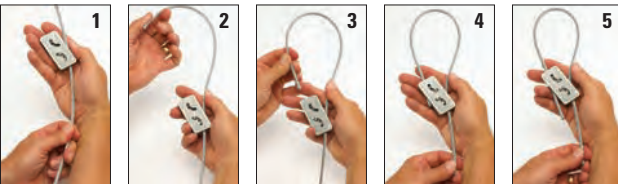

1. Pass the wire through the KwikWire Clamp
2. Loop wire through/around support
3. Pass wire back through KwikWire Clamp
4. Push wire through clamp leaving 2" to 3" tail, then apply tension on wire
5. To adjust, remove tension and pull wire slightly to disengage teeth, slide adjustment pin in direction shown by arrow to release wire.



7 x 7



7 x 19

KwikWire™ Wire Rope

UPC/Part Number	Catalog Number	Wire Diameter	Working Load - Lbs.	Spool Qty.
78205140725	BKW063 (1)	1/16"	96	500 ft.
78205140727	BKW094 (1)	3/32"	184	500 ft.
78205140733	BKW125 (1)	1/8"	340	500 ft.
78205140734	BKW188 (2)	3/16"	840	250 ft.

(1) Wire rope construction Type 7 x 7

(2) Wire rope construction Type 7 x 19

Uncoated Galvanized Wire



- KwikPak™ includes a supply of kwik-clamps and a spool of wire rope.
- KwikPak are shipped in a specially designed dispenser box to ease field cutting of wire.

KwikPak™



UPC/Part Number	Catalog Number	Kit Includes	Box Qty.
78205140749	BKP10063	BKC100 (100 pcs.) 1/16" Ø Wire Rope (500 ft.)	1
78205140751	BKP10094	BKC100 (100 pcs.) 3/32" Ø Wire Rope (500 ft.)	1
78205140761	BKP20125	BKC200 (50 pcs.) 1/8" Ø Wire Rope (500 ft.)	1
78205140763	BKP20188	BKC200 (50 pcs.) 3/16" Ø Wire Rope (250 ft.)	1

Read safety/installation instruction sheets in packages before use.

Accessories



- KwikWire™ hanger combines the versatility of a bolt with an adjustable wire rope solution.
- Can be quickly installed in existing anchors or metal brackets with a nut.
- Ideal for supporting light fixtures, wire basket cable tray, HVAC ducts, and sign/banner supports.
- See page 182 for wire rope spools.

KwikWire™ Hanger

UPC/Part Number	Catalog Number	Thread Size	Wire Rope Diameter	Load SF5	Box Qty.
78205158764	BKF100-4	1/4"-20	1/16" 3/32"	45 lbs. 90 lbs.	100
78205158765	BKF100-6	3/8"-16	1/16" 3/32"	45 lbs. 90 lbs.	100



1. Screw KwikWire Hanger into installed hanger support
2. Push wire up through the bottom of KwikWire Hanger
3. Continue pushing through until 1/4" minimum is extending out the side of the KwikWire Hanger
4. To adjust up - pull or push more wire through KwikWire Hanger
5. To adjust down - push up on bottom of KwikWire Hanger and allow wire to feed down
6. When hanging the wire is complete, cut off any excess cable wire if desired

KwikWire™ Accessories



BKL Series

Loop Termination

- Available as a wire rope with loop termination only or as a ready-to-use kit with a BKC100 clamp.
- Available in lengths of 40", 80", 120", 180", 240", and 360".



BKH Series

Single & "Y" Style Hook Termination

- Hook designed to accept up to 3/8" diameter wire.
- Available as a wire rope with hook termination only or as a ready-to-use kit with a BKC100 clamp.
- Available in lengths of 40", 80", 120", 180", 240", and 360".
- Available in single, double (Y), and triple (3) leg styles



BKYH Series



BKT Series

Single & "Y" Style Toggle Termination

- Available as a wire rope with toggle termination only or as a ready-to-use kit with a BKC100 clamp.
- Available in lengths of 40", 80", 120", 180", 240", and 360".
- Available in single, double (Y), and triple (3) leg styles
- All triple (3) leg styles are non-stock, consult B-Line for lead times



BKYT Series



BKB Series

Bolt Loop Termination

- Ideal for use with ARS, ARC, ADI, ACPW, or ACPD anchors.
- Available as a wire rope with bolt termination only or as a ready-to-use kit with a BKC100 clamp.
- Available in lengths of 40", 80", 120", 180", 240", and 360".
- Available in single, double (Y), and triple (3) styles
- All double (Y) and triple (3) styles are non-stock, consult B-Line for lead times



BKA Series

Angle Bracket Termination

- Available as a wire rope with angle bracket termination only or as a ready-to-use kit with a BKC100 clamp.
- Available in lengths of 40", 80", 120", 180", 240", and 360".

For additional options, refer to KwikWire Brochure (KWHS)

Read safety/installation instruction sheets in packages before use.

Accessories



BKCP



B601-62



BKCC

KwikWire™ Accessories

UPC/Part Number	Catalog Number	Description	Box Qty.
78205140766	BKCP	Air Duct Corner Protector	100
78101156059	B601-62	Air Duct Support	50
78205140297	BKCC *	Wire Rope Cutter	1

Danger: Never use cutters on energized circuits, wire, or cable.

Note: Additional accessories include BE Series (pg. 96), BF Series (pgs. 125 & 129), and BPNA Series (pg. 139)

** Not for use of cutting 3/16" diameter cable.*

KwikWire™ System Recommendations:

- Do not exceed the safe working load of the products shown in their charts
- All characteristics of KwikWire must be used with wire supplied by B-Line
- Do not use for overhead lifting or hoisting
- Do not use if cable or components are visibly distorted or worn, remove damaged cable end prior to inserting in KwikWire™ Clamp
- Do not paint cable near working area of KwikWire Clamp connector
- Do not apply lubricant
- Keep product clean and free of dirt
- Do not use on coated wire rope
- Do not use in chlorinated or caustic atmospheres
- For use in dry locations
- Cooper's BKCC tool is recommended for cutting wire rope to prevent fraying
- For use on vertical applications only

Application Photos



Accessories



UPC/Part Number	Catalog Number	Description	Box Qty.
78101101687	SHHMS 1/4x1/2	1/4"-20 x 1/2" Slotted Hex Head Machine Screw	100



UPC/Part Number	Catalog Number	Description	Box Qty.
78101142103	MSQN 1/4	1/4"-20 Machine Square Nut	100



UPC/Part Number	Catalog Number	Description	Box Qty.
78101110675	BWHS-9	Sheet Metal Screw #8 x 9/16"	1000

Note: BWHS-9 can be used with all fasteners requiring attachments with sheet metal screws.



UPC/Part Number	Catalog Number	Description	Box Qty.
78101104925	BWHS-9D	#8 x 1/2" Self-Drilling Sheet Metal Screw	1000

Note: BWHS-9D can be used with all fasteners requiring attachment with sheet metal screws except BB2-16, BB2-16D, BB2-24 & BB2-24D.

Read safety/installation instruction sheets in packages before use.

Anchors



Anchors



Glossary

Prefix - Description	Screw Dia.	Length	Suffix
ACB - Concrete Anchor Bolt	4 - #4	75 - 3/4"	AN - Acorn Nut
ACPD - Bang-IT	6 - #6	81 - 13/16"	CH - Combo Head
ACPW - Wood-Knocker	8 - #8	87 - 7/8"	F - Flat
ACS - Concrete Screw	10 - #10	100 - 1"	FL - Flanged
ADA - Drive Anchor	12 - 1/8"	118 - 13/18"	H - Hex
ADE - Double Expansion Anchor	18 - 3/16"	125 - 1 1/4"	HN - Hex Nut
ADH - Hollow-Base Drop-IN	25 - 1/4"	150 - 1 1/2"	HS - Hole Saw
ADI - Drop-In	31 - 5/16"	175 - 1 3/4"	K - Kit
ADM - Mini Drop-In	37 - 3/8"	187 - 1 7/8"	M - Mushroom
ADN - Drive Nail	50 - 1/2"	200 - 2"	OH - Oval Head
AMS - Machine Screw	62 - 5/8"	225 - 2 1/4"	PH - Pan Head
APC - Conical Anchor	75 - 3/4"	250 - 2 1/2"	RH - Rod Hanger
APD - Plastic Driller	87 - 7/8"	275 - 2 3/4"	RS - Slotted Round Head
APDM - Plastic Driller - Mini		300 - 3"	
APH - Plastic Hollow Wall Anchor		325 - 3 1/4"	SS4 - 304 Stainless Steel
APS - Plastic Screw Anchor		350 - 3 1/2"	
ARC - Rapid Rod™ Concrete		375 - 3 3/4"	T - Tool
ARS - Rapid Rod™ Steel		400 - 4"	WH - Wire Hanger
ARW - Rapid Rod™ Wood		425 - 4 1/4"	
ASA - Sleeve Anchor		450 - 4 1/2"	
ASE - Single Expansion Anchor		500 - 5"	
ATB - Toggle Bolt		525 - 5 1/4"	
ATM - Self-Tapping Machine Screw Anchor		550 - 5 1/2"	
		600 - 6"	
		700 - 7"	
AWA - Wedge Anchor			
AWSD - Seismic Wedge Anchor			
AWS - Wall Screw			
AZD - Zinc Driller			
AZDM - Zinc Driller-Mini			

Rapid Rod™ Hangers

- One-piece, all steel threaded fastener system for suspending steel threaded rod.
- Suitable for overhead installations such as suspending cable tray, pipe hangers, strut and conduit.
- Side Mount (SW) available for side mounting applications.
- Lower in-place cost, when compared to beam clamps, lag bolts and drop-ins.
- Steel rapid rods can be installed with a screw gun or hammer drill.
- UL & FM approved.
- Made of Zinc Plated carbon steel.

Rapid Rod Hangers Steel

Steel Rapid Rod - Data

Point Style	#3	#5
Self-Drilling Range (in.)	20 ga. - 3/16	3/16 - 1/2
Screw Size (UNC) *	1/4"-20	1/4"-20
Thread Length (in.) *	1 3/16	3 1/32

* Dimensions for self-drilling (embedded) portion of anchor.

Steel Rapid Rod - Load Data

Rod/ Anchor Size	Minimum Steel Gauge Thickness						
	20 (.036")	18 (.048")	16 (.060")	14 (.075")	12 (.105")	3/16"	1/4"
1/4	100	155	245	290	390	800	1260
1/4 w/nut	390	390	440	440	510	960	510
3/8	100	155	245	290	390	490	490
3/8 w/nut	365	365	365	365	365	365	365
1/2	120	175	230	390	510	820	1260

Loads shown for ASTM A36 steel beams and ASTM A572 steel purlins include a safety factor of 4.

For UL & FM listings, steel rapid rod must be installed with a retaining nut. UL & FM load rating for 3/8" rapid rod is 365 lbs. and can support up to a maximum 4" pipe.

UL & FM load rating for 1/2" rapid rod is 900 lbs. and can support up to a maximum 6" pipe.

Rapid Rod™ Hangers

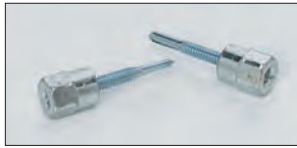

UPC/Part Number	Catalog Number	Rod Size	Shank Size & Length	Box Qty.
Steel Rod Hanger - Point Style #3 For Purlins				
78205153317	ARS-25-100	1/4"	1/4" x 1"	100
78205153318	ARS-37-200	3/8"	1/4" x 2"	100
78205153320	ARS-37-100HN**	3/8"	1/4" x 1" w/nuts	100
78205153321	ARS-37-150	3/8"	1/4" x 1 1/2"	100
78205153322	ARS-37-150HN**	3/8"	1/4" x 1 1/2" w/nuts	100
Steel Rod Hanger - Side Mount - Point Style #3 For Purlins				
78205153323	ARS-25-100SW	1/4"	1/4" x 1"	100
78205153324	ARS-37-100SW	3/8"	1/4" x 1" w/nuts	100
Steel Rod Hanger - Point Style #5 For Purlins				
78205153325	ARS-25-150HD	1/4"	#12-24 x 1 1/2"	100
78205153326	ARS-37-150HDHN**	3/8"	#12-24 x 1 1/2" w/nuts	100
78205153327	ARS-50-150HDHN**	1/2"	#12-24 x 1 1/2" w/nuts	100

** For UL & FM listings, steel rapid rod should be installed with a retaining nut.

UPC/Part Number	Catalog Number	Tool Description	Box Qty.
Tool			
78205153287	7187	Universal Steel & Wood Socket	1

Read safety/installation instruction sheets in packages before use.

Rapid Rod™ Hangers

- One-piece, all steel threaded fastener system for suspending steel threaded rod.
- Suitable for overhead installations such as suspending cable tray, pipe hangers, strut and conduit.
- Side Mount (SW) available for side mounting applications.
- Lower in-place cost, when compared to beam clamps, lag bolts and drop-ins.
- Wood rapid rods can be installed with a screw gun or hammer drill.
- Concrete Rapid Rod hangers can be installed with an adjustable torque, battery powered screw gun or hammer drill.
- UL & FM approved.
- Made of Zinc Plated carbon steel.

Rapid Rod Hangers - Concrete

Concrete Rapid Rod - Data	1/4"	3/8"	1/2"
ANSI Drill Bit (in.)	1/4	1/4	3/8
Thread Length (in.)	1 1/8	1 3/8	2 1/2
Min. Embedment Depth (in.)	1 1/4	1 1/2	2 3/4
Load Capacity Tension (lbs.) *	485	650	1510
Load Capacity Shear (lbs.) *	610	660	1580

* Based on concrete compression strength of 4000 psi using applied safety factor of 4.0. For additional loading information contact factory.

FM approved load capacity for 3/8" anchor is 365 lbs., maximum 4" pipe size. FM approved load capacity for 1/2" anchor is 950 lbs., maximum 8" pipe size.

Rapid Rod Hangers - Wood

Wood Rapid Rod - Data	1/4" Thread Forming	3/8" Thread Forming
Pre-Drill Diameter (in.)	1/8	1/8
Point Style	Type 17	Type 17

Wood Rapid Rod - Embedment & Load Data

Rod/Anchor Size	Embedment Depth	Fir	Pine	Spruce
1/4	1"	170	160	160
3/8	2"	375	375	375
1/2	2 1/2"	665	775	775

Minimum load ratings are based on a safety factor of 4.

UL approved load capacity for 3/8" rod sizes and 1/4" screw size is 260 lbs., maximum 3" pipe. UL approved load capacity for 3/8" rod sizes and 3/8" screw size is 375 lbs., maximum 4" pipe. FM approval only applies to 3/8" x 2 1/2" screw size. Approved for 365 lbs., up to 4" pipe.

Rapid Rod™ Hangers



UPC/Part Number	Catalog Number	Rod Size	Shank Size & Length	Box Qty.
-----------------	----------------	----------	---------------------	----------

Concrete Rod Hanger - ANSI Wedge-Bolt OT Thread Shank Style

78205153328	ARC-25-125	1/4"	1/4" x 1"	100
78205153329	ARC-37-150	3/8"	1/4" x 1 1/2"	100
78205153330	ARC-50-275	1/2"	3/8" x 2 3/4"	50

For side mount concrete applications use ARW-25-100SW or ARW-37-200SW with 1/4" drill bit.

Wood Rod Hanger - Point Style Type 17

78205153331	ARW-25-200	1/4"	1/4" x 2"	100
78205153332	ARW-37-100	3/8"	1/4" x 1"	100
78205153333	ARW-37-200	3/8"	1/4" x 2"	100
78205153334	ARW-37-250	3/8"	3/8" x 2 1/2"	100
78205153335	ARW-50-250	1/2"	1/2" x 2 1/2"	100

Wood Rod Hanger - Side Mount - Point Style Type 17

78205153336	ARW-25-100SW	1/4"	1/4" x 1"	100
78205153337	ARW-37-200SW	3/8"	1/4" x 2"	100

UPC/Part Number	Catalog Number	Tool Description	Box Qty.
-----------------	----------------	------------------	----------

Tools

78205153287	7187	Universal Steel & Wood Socket	1
78205153288	7195	1/4" Concrete Socket	1
78205153289	7197	3/8" Concrete Socket	1
78205153290	7198	1/2" Concrete Socket	1
78205153360	5874	Concrete Tapper Sleeve Assy.	1
78205153361	5866	1/4" X 6" Hex Shank SDS Drill Bit	1

Read safety/installation instruction sheets in packages before use.

Anchors

Drop-in Anchors

- Designed for use in solid concrete.
- Can be used for overhead applications such as suspending cable tray, strut, pipe supports and lighting.
- Flanged (lipped) version installs flush for easy inspection and standardizes rod heights.
- Smooth wall drop-in can be installed flush mounted or below the base material surface.
- UL & FM approved.
- Available in Zinc Plated finish or Stainless Steel.



Drop-In Anchors - Data	1/4"	3/8"	1/2"	5/8"	3/4"
ANSI Drill Bit Size (in.)	3/8	1/2	5/8	7/8	1
Max. Tightening Torque (ft-lbs)	5	10	20	40	80
Thread Size (UNC)	1/4"-20	3/8"-16	1/2"-13	5/8"-11	3/4"-10
Min. Embedment Depth (in.)	1	19/16	2	2 1/2	3 3/16
Load Capacity Tension (lbs) *	495	1045	1440	1860	3600
Load Capacity Shear (lbs) *	530	1145	1600	3095	3920

* Based on concrete compression strength of 4000 psi using applied safety factor of 4.0. For additional loading information contact factory.

UPC/Part Number	Catalog Number	Rod Size	Anchor Length	Thread Depth	Box Qty.
-----------------	----------------	----------	---------------	--------------	----------

Drop-In Anchor - Smooth Wall - Steel

78101103218	ADI-25	1/4"	1"	7/16"	100
78101103219	ADI-37	3/8"	1 9/16"	5/8"	50
78101103220	ADI-50	1/2"	2"	1 3/16"	50
78101103221	ADI-62	5/8"	2 1/2"	1 13/16"	25
78101103222	ADI-75	3/4"	3 3/16"	1 3/8"	10

Drop-In Anchor - Smooth Wall - StainlessSteel

78101103223	ADI-25SS4	1/4"	1"	7/16"	100
78101103224	ADI-37SS4	3/8"	1 9/16"	5/8"	50
78101103226	ADI-50SS4	1/2"	2"	1 3/16"	50
78101103227	ADI-62SS4	5/8"	2 1/2"	1 13/16"	25
78101103228	ADI-75SS4	3/4"	3 3/16"	1 3/8"	10

Drop-In Hanger - Flanged - Steel

78205153297	ADI-25FL	1/4"	1"	7/16"	100
78205153298	ADI-37FL	3/8"	1 9/16"	5/8"	50
78205153299	ADI-50FL	1/2"	2"	1 3/16"	50

UPC/Part Number	Catalog Number	Rod Size	Pin Length	Box Qty.
-----------------	----------------	----------	------------	----------

Setting Tools

78101103229	6305	1/4"	39/64"	1
78101103231	6307	3/8"	61/64"	1
78101103232	6309	1/4"	1 3/16"	1
78101103233	6311	1/4"	1 5/15"	1
78101103234	6313	1/4"	1 61/64"	1

Read safety/installation instruction sheets in packages before use.

Mini Drop-in Anchors

- Carbon steel machine bolt anchor for use in shallow embedment applications.
- Can be used in solid concrete and precast hollow core plank, in addition to post-tensioned concrete slabs and concrete pours over metal deck.
- Can be used for overhead applications such as suspending cable tray, strut, pipe supports and lighting.
- Flanged (lipped) version installs flush for easy inspection and standardizes rod heights.
- Setting tool scores flange when set to verify proper expansion
- Available in zinc plated finish.



Anchor

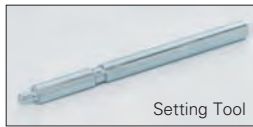

Setting Tool

Mini Drop-In Anchors - Data	1/4"	3/8"	1/2"
ANSI Drill Bit Size (in.)	3/8	1/2	5/8
Max. Tightening Torque (ft-lbs)	3	5	10
Thread Size (UNC)	1/4"-20	3/8"-16	1/2"-13
Min. Embedment Depth (in.)	5/8	3/4	1
Load Capacity Tension (lbs) *	350	530	840
Load Capacity Shear (lbs) *	415	1055	1220

* Based on concrete compression strength of 4000 psi using applied safety factor of 4.0. For additional loading information contact factory.

UPC/Part Number	Catalog Number	Rod Size	Thread Depth	Box Qty.
Mini Drop-In Anchor - Steel				
78205153300	ADM-25	1/4"	3/8"	100
78205153302	ADM-37	3/8"	13/32"	50
78205153302	ADM-50	1/2"	5/8"	50
Setting Tools				
78205153301	6336	1/4"	–	1
78205153303	6323	3/8"	–	1
78205153305	6338	3/8"	–	1

Read safety/installation instruction sheets in packages before use.

Hollow Base Drop-in Anchors

- For use in hollow base materials such as hollow concrete block, brick with weep holes, and precast hollow core plank.
- Can also be used in solid base materials.
- Smooth wall drop-in can be installed flush mounted or below the base material surface.
- Available in Zinc Plated finish.



Hollow Base Drop-In - Data	1/4"	3/8"	1/2"
ANSI Drill Bit Size (in.)	3/8	5/8	3/4
Max. Tightening Torque (ft-lbs)	5	10	20
Thread Size (UNC)	1/4"-20	3/8"-16	1/2"-13
Thread Length In Cone (in.)	3/8	5/8	3/4
Min. Embedment Depth (in.)	3/4	1	1 1/2
Load Capacity Tension (lbs) *	285	520	1005
Load Capacity Shear (lbs) *	300	640	1005

* Based on concrete compression strength of 4000 psi using applied safety factor of 4.0. For additional loading information contact factory.

UPC/Part Number	Catalog Number	Rod Size	Overall Length	Sleeve Length	Box Qty.
Hollow Base Drop-In					
78205153291	ADH-25	1/4"	7/8"	5/8"	100
78205153293	ADH-37	3/8"	15/16"	15/16"	50
78205153294	ADH-50	1/2"	1 3/4"	1 1/4"	50
Setting Tools					
78205153292	9323	1/4"	-	-	1
78205153294	9343	3/8"	-	-	1
78205153296	9353	1/2"	-	-	1

Concrete Screw Bolts

- For use in racking, shelving, material handling, structural anchorage, masonry and food & beverage facilities.
- One piece heavy-duty anchor with a finished hex-head.
- Fits standard fixture hole dimensions in fabricated steel.
- Fast installation and immediate loading reduces downtime.
- For proper performance, screw anchors must be installed with the corresponding bits. The bits have a matched tolerance range designed to provide optimum performance.



Concrete Screw Bolts - Data	1/4"	3/8"
ACB Drill Bit Size (in.)	1/4	3/8
Concrete Screw Tolerance Range (in.)	0.255 - 0.259	0.385 - 0.389
Min. Embedment Depth (in.)	1	1 1/2
Load Capacity Tension (lbs) *	335	630
Load Capacity Shear (lbs) *	520	1170

* Based on concrete compression strength of 4000 psi in uncracked concrete using applied safety factor of 4.0. For additional loading information contact factory.

For ultimate strength design data in cracked and uncracked concrete, see ICC-ES ESR-2526.

UPC/Part Number	Catalog Number	Anchor Length	Thread Length	Box Qty.
Screw Type Anchor - Steel				
78205153247	ACB-25-175	1/4" x 1 3/4"	1 5/8"	100
78205153248	ACB-25-225	1/4" x 2 1/4"	2"	100
78205153249	ACB-25-300	1/4" x 3"	2 3/4"	100
78205153250	ACB-37-175	3/8" x 1 3/4"	1 1/2"	50
78205153251	ACB-37-250	3/8" x 2 1/2"	2 1/4"	50
78205153252	ACB-37-300	3/8" x 3"	2 3/4"	50
78205153253	ACB-37-400	3/8" x 4"	3 3/4"	50

UPC/Part Number	Catalog Number	Drill Size	Usable Length	Overall Length	Box Qty.
Drill Bits - Straight Shank Type					
78205153254	1372	1/4"	4"	6"	1
78205153256	1380	3/8"	4"	6"	1
Drill Bits - SDS Type					
78205153255	1314	1/4"	4"	6"	1
78205153257	1316	3/8"	4"	6"	1

Note: Matched tolerance bits must be used for installation.

Read safety/installation instruction sheets in packages before use.

Anchors

Concrete Screws

- Light to medium duty anchor for use in concrete, masonry block and brick base materials.
- Concrete screws are engineered with matched tolerance bits and installation tools to optimize performance.
- High low thread design for greater stability and grip.
- No hole spotting required.
- One drill bit is packaged in each box of concrete screws.
- Blue fluorocarbon coating for corrosion resistance.



Straight Shank Drill Bit



SDS Hex Drill Bit



Hex Head

Hex Head - Data	3/16"	1/4"
ANSI Drill Bit Size (in.)	5/32	3/16
Fixture Clearance Hole (in.)	1/4	5/16
Head Height (in.)	7/64	9/64
Head Width (in.)	1/4	5/16
Washer O.D. (in.)	11/32	13/32
Washer Thickness (in.)	1/32	1/32
Hex Driver (in.)	1/4	5/16



Flat Head

Flat Head - Data	3/16"	1/4"
ANSI Drill Bit Size (in.)	5/32	3/16
Fixture Clearance Hole (in.)	1/4	5/16
Phillips Head O.D. (in.)	3/8	1/2
Phillips Head Height (in.)	9/64	3/16
Phillips Bit Size	2	3

Embedment Depth	Nominal Anchor Dia. / Loading*			
	3/16" Tension	3/16" Shear	1/4" Tension	1/4" Shear
1"	90	175	265	205
1 1/4"	175	230	335	355
1 3/8"	215	230	370	385
1 1/2"	255	230	405	355
1 3/4"	375	235	435	370

* Based on concrete compression strength of 4000 psi using applied safety factor of 4.0. For additional loading information contact factory.

Concrete Screws

UPC/Part Number	Catalog Number	Size	Box Qty.
-----------------	----------------	------	----------

Hex Head Concrete Screws

78101103342	ACS-18-125H	3/16" x 1 1/4"	100
78101103343	ACS-18-175H	3/16" x 1 3/4"	100
78101103344	ACS-18-225H	3/16" x 2 1/4"	100
78101103346	ACS-18-275H	3/16" x 2 3/4"	100
78101103347	ACS-18-325H	3/16" x 3 1/4"	100
78101103348	ACS-18-375H	3/16" x 3 3/4"	100
78101103349	ACS-18-400H	3/16" x 4"	100
78101103342	ACS-25-125H	1/4" x 1 1/4"	100
78101103343	ACS-25-175H	1/4" x 1 3/4"	100
78101103344	ACS-25-225H	1/4" x 2 1/4"	100
78101103346	ACS-25-275H	1/4" x 2 3/4"	100
78101103347	ACS-25-325H	1/4" x 3 1/4"	100
78101103348	ACS-25-375H	1/4" x 3 3/4"	100
78101103349	ACS-25-400H	1/4" x 4"	100

Flat Head Concrete Screws

78205153259	ACS-18-125F	3/16" x 1 1/4"	100
78205153260	ACS-18-175F	3/16" x 1 3/4"	100
78205153261	ACS-18-225F	3/16" x 2 1/4"	100
78205153262	ACS-18-275F	3/16" x 2 3/4"	100
78205153263	ACS-25-125F	1/4" x 1 1/4"	100
78205153264	ACS-25-175F	1/4" x 1 3/4"	100
78205153265	ACS-25-225F	1/4" x 2 1/4"	100
78205153266	ACS-25-275F	1/4" x 2 3/4"	100

UPC/Part Number	Catalog Number	Bit Size	Usable Length	Box Qty.
-----------------	----------------	----------	---------------	----------

Straight Shank Drill Bits

78205153267	2782	5/32" x 4 1/2"	3"	1
78205153269	2786	3/16" x 4 1/2"	3"	1

SDS Hex Drill Bits

78205153268	2793	5/32" x 5"	3"	1
78205153270	2796	3/16" x 5"	3"	1

UPC/Part Number	Catalog Number	Description	Box Qty.
-----------------	----------------	-------------	----------

Setting Tool

78101103453	2791	ConcreteScrew Tool Kit	100
-------------	-------------	------------------------	-----

Read safety/installation instruction sheets in packages before use.

Anchors

Wedge Expansion Anchors

- Heavy and medium duty all purpose anchor.
- For use in solid concrete and grout filled block.
- Anchors can be installed through the fixture, no need for hole spotting.
- Interlocking clip wedges prevent anchor spinning during installation.
- Wire hanger hole size $\frac{9}{32}$ " diameter, head height $\frac{3}{4}$ ".
- UL & FM approved.
- Available in Zinc Plated Carbon Steel or Type 304 Stainless Steel.



Wedge Expansion Anchor - Data	1/4"	3/8"	1/2"	5/8"
ANSI Drill Bit Size (in.)	1/4	3/8	1/2	5/8
Fixture Clearance Hole (in.)	5/16	7/16	9/16	11/16
Thread Size (UNC)	1/4"-20	3/8"-16	1/2"-13	5/8"-11
Washer O.D. (in.)	5/8	13/16	1 1/16	1 3/4
Wrench Size	7/16	9/16	3/4	15/16
Max. Tightening Torque (ft-lbs)	8	28	60	90
Min. Embedment Depth (in.)	1 1/8	1 5/8	2 1/4	2 3/4
Load Capacity Tension (lbs) *	360	760	1390	2075
Load Capacity Shear (lbs) *	405	940	1700	2975

* Based on concrete compression strength of 4000 psi using applied safety factor of 4.0. For additional loading contact factory.

Wire Hanger Wedge Anchor - Data	1/4"
ANSI Drill Bit Size (in.)	1/4
Min. Embedment Depth (in.)	1 1/8
Head Height (in.)	3/4
Load Capacity Tension (lbs) *	360
Load Capacity Shear (lbs) *	405

* Based on concrete compression strength of 4000 psi using applied safety factor of 4.0. For additional loading information contact factory.

UPC/Part Number	Catalog Number	Size	Hole Size	Box Qty.
Wire Hanger				
78101103106	AWA-25-200WH	1/4" x 2"	9/32"	100

Wedge Expansion Anchors

UPC/Part Number	Catalog Number	Size	Thread Length	Box Qty.
Wedge Anchor				
78101103068	AWA-25-175	1/4" x 1 3/4"	3/4"	100
78101103069	AWA-25-225	1/4" x 2 1/4"	1 1/4"	100
78101103070	AWA-25-325	1/4" x 3 1/4"	2 1/4"	100
78101103071	AWA-37-225	3/8" x 2 1/4"	1 1/4"	50
78101103072	AWA-37-275	3/8" x 2 3/4"	1 5/8"	50
78101103073	AWA-37-300	3/8" x 3"	1 7/8"	50
78205153364	AWA-37-350	3/8" x 3 1/2"	2 3/8"	50
78101103074	AWA-37-375	3/8" x 3 3/4"	2 5/8"	50
78101103075	AWA-37-500	3/8" x 5"	3 7/8"	50
78205153366	AWA-50-275	1/2" x 2 3/4"	1 3/8"	50
78101103077	AWA-50-375	1/2" x 3 3/4"	2 3/8"	50
78205145636	AWA-50-450	1/2" x 4 1/2"	3 1/8"	50
78101103079	AWA-50-550	1/2" x 5 1/2"	4 1/8"	50
78101103080	AWA-50-700	1/2" x 7"	5 5/8"	25
78101103081	AWA-62-275	5/8" x 3 1/2"	2"	25
78101103082	AWA-62-375	5/8" x 4 1/2"	3"	25
78101103083	AWA-62-450	5/8" x 5"	3 1/2"	25
78101103084	AWA-62-550	5/8" x 6"	4 1/2"	25
78101103085	AWA-62-700	5/8" x 7"	5 1/2"	25
Wedge Anchor - Stainless Steel				
78101103146	AWA-25-175SS4	1/4" x 1 3/4"	3/4"	100
78101103147	AWA-25-225SS4	1/4" x 2 1/4"	1 1/4"	100
78101103148	AWA-25-325SS4	1/4" x 3 1/4"	2 1/4"	100
78101103149	AWA-37-225SS4	3/8" x 2 1/4"	1 1/4"	50
78101103150	AWA-37-275SS4	3/8" x 2 3/4"	1 5/8"	50
7810110151	AWA-37-300SS4	3/8" x 3"	1 7/8"	50
78205153365	AWA-37-350SS4	3/8" x 3 1/2"	2 3/8"	50
78101103152	AWA-37-375SS4	3/8" x 3 3/4"	2 5/8"	50
78101103153	AWA-37-500SS4	3/8" x 5"	3 7/8"	50
78101103154	AWA-50-275SS4	1/2" x 2 3/4"	1 3/8"	50
78101103155	AWA-50-375SS4	1/2" x 3 3/4"	2 3/8"	50
78205153367	AWA-50-450SS4	1/2" x 4 1/2"	3 1/8"	50
78101103157	AWA-50-550SS4	1/2" x 5 1/2"	4 1/8"	50
78205153368	AWA-50-700SS4	1/2" x 7"	5 5/8"	25
78205153369	AWA-62-275SS4	5/8" x 3 1/2"	2"	25
78205153370	AWA-62-375SS4	5/8" x 4 1/2"	3"	25
78205153779	AWA-62-450SS4	5/8" x 5"	3 1/2"	25
78205153371	AWA-62-550SS4	5/8" x 6"	4 1/2"	25
78205143044	AWA-62-700SS4	5/8" x 7"	5 1/2"	25

Read safety/installation instruction sheets in packages before use.

Seismic Wedge Anchors

- Fully threaded, torque-controlled, wedge anchor which is designed for consistent performance in cracked and uncracked concrete.
- For use in concrete, structural sand lightweight concrete, and concrete over metal deck.
- Nominal drill bit size is the same as the anchor diameter.
- ICC-ES listed, ESR-2502, Category 1
- Zinc plated carbon steel body with stainless steel expansion clip from premium performance.
- Qualified for seismic and wind loading.



Seismic Wedge Anchor - Data	3/8"	1/2"	5/8"	3/4"
ANSI Drill Bit Size (in.)	3/8	1/2	5/8	3/4
Fixture Clearance Hole (in.)	7/16	9/16	11/16	13/16
Minimum Hole Depth (in.)	2 ⁵ / ₈	2 ³ / ₄	4 ¹ / ₄	5
Minimum Concrete Thickness (in.)	4	4 ¹ / ₂	5 ³ / ₄	7
Max. Tightening Torque (ft-lbs)	20	40	60	110
Min. Embedment Depth (in.)	2 ³ / ₈	2 ¹ / ₂	3 ⁷ / ₈	4 ¹ / ₂

For loading information, see ICC-ES ESR-2502.

Seismic Wedge Anchors

UPC/Part Number	Catalog Number	Size	Thread Length	Box Qty.
Seismic Wedge Anchor				
78205153398	AWSD-37-300	3/8" X 3"	1 3/4"	50
78205153399	AWSD-37-350	3/8" X 3 1/2"	2 1/4"	50
78205153400	AWSD-37-375	3/8" X 3 3/4"	2 1/2"	50
78205153401	AWSD-37-500	3/8" X 5"	3 3/4"	50
78205153402	AWSD-50-375	1/2" X 3 3/4"	2 1/8"	50
78205153403	AWSD-50-450	1/2" X 4 1/2"	2 7/8"	50
78205153404	AWSD-50-550	1/2" X 5 1/2"	3 7/8"	50
78205153405	AWSD-50-700	1/2" X 7"	5 3/8"	50
78205153406	AWSD-62-475	5/8" X 4 3/4"	2 7/8"	25
78205153407	AWSD-62-500	5/8" X 5"	3 1/8"	25
78205153408	AWSD-62-600	5/8" X 6"	4 1/8"	25
78205153409	AWSD-62-700	5/8" X 7"	5 1/8"	25
78205153410	AWSD-75-550	3/4" X 5 1/2"	3 1/4"	20
78205153411	AWSD-75-625	3/4" X 6 1/4"	4"	20
78205153425	AWSD-75-700	3/4" X 7"	4 3/4"	20

Read safety/installation instruction sheets in packages before use.

Anchors

Drive Anchor

- One-piece, tamper-proof vibration resistant anchor for use in concrete.
- Anchor is formed with an 's' shaped configuration at the working end of the anchor to create an expansion mechanism.
- Anchor is pre-expanded so no secondary tightening operation is required.
- FM approved.
- Made of Zinc Plated carbon steel.



Mushroom Head - Data	3/16"	1/4"
ANSI Drill Bit Size (in.)	3/16	1/4
Fixture Clearance Hole (in.)	1/4	5/16
Head Height (in.)	7/64	7/64
Head Size O.D. (in.)	7/16	1/2
Min. Embedment Depth (in.)	7/8	7/8
Load Capacity Tension (lbs.) *	215	235
Load Capacity Shear (lbs.) *	330	470

Rod Hanger - Data	1/4"	3/8"
ANSI Drill Bit Size (in.)	3/16	1/4
UNC Thread Size	1/4"-20	3/8"-16
Head Height (in.)	1/2	5/8
Head Size O.D. (in.)	13/32	35/64
Min. Embedment Depth (in.)	1 1/4	1 3/4
Load Capacity Tension (lbs.) *	315	500
Load Capacity Shear (lbs.) *	245	525



Wire Hanger - Data	3/16"	1/4"
ANSI Drill Bit Size (in.)	3/16	1/4
Tie-Wire Hole (in.)	3/16	9/32
Head Height (in.)	37/64	41/64
Head Width (in.)	9/64 x 7/16	3/16 x 9/16
Min. Embedment Depth (in.)	1 1/8	1 1/8
Load Capacity Tension (lbs.)*	265	290
Load Capacity Shear (lbs.)*	240	330



* Based on concrete compression strength of 4000 psi using applied safety factor of 4.0. For additional loading information contact factory.

Read safety/installation instruction sheets in packages before use.

Drive Anchors

UPC/Part Number	Catalog Number	Size	Box Qty.
Mushroom Head			
78205153271	ADA-18-100	3/16" x 1"	100
78205153272	ADA-18-125	3/16" x 1 1/4"	100
78205153273	ADA-18-150	3/16" x 1 1/2"	100
78205153274	ADA-18-200	3/16" x 2"	100
78205153275	ADA-18-250	3/16" x 2 1/2"	100
78205153276	ADA-18-300	3/16" x 3"	100
78205153278	ADA-25-100	1/4" x 1"	100
78205153279	ADA-25-125	1/4" x 1 1/4"	100
78205153280	ADA-25-150	1/4" x 1 1/2"	100
78205153281	ADA-25-200	1/4" x 2"	100
78205153282	ADA-25-250	1/4" x 2 1/2"	100
78205153283	ADA-25-300	1/4" x 3"	100

UPC/Part Number	Catalog Number	Head Size	Box Qty.
Rod Hanger			
78205153284	ADA-25RH	1/4"	100
78205153286	ADA-37RH	3/8"	100
Wire Hanger			
78205153277	ADA-18WH	3/16"	100
78205153285	ADA-25WH	1/4"	100

Read safety/installation instruction sheets in packages before use.

Anchors

Sleeve Type Expansion Anchors

- For use in concrete and masonry substrates.
- Suitable for solid and hollow core materials.
- Fits standard fixture holes - no need to undersize anchors for proper fit.
- Sleeve has 360° contact area and reduces concrete stress.
- UL & FM approved.
- Available in Zinc Plated Steel or Type 304 Stainless Steel.



Hex Nut (HN)
Style



Acorn Nut (AN)
Style



Slotted Round
Head (RS) Style

Sleeve Type Expansion - Data	1/4"	3/8"	1/2"	5/8"	3/4"
ANSI Drill Bit Size (in.)	1/4	3/8	1/2	5/8	3/4
Fixture Clearance Hole (in.)	5/16	7/16	9/16	11/16	15/16
Plow Bolt Size (UNC)	#10-24	5/16"-18	3/8"-16	1/2"-13	5/8"-11
Min. Embedment Depth (in.)	5/8	15/8	2 1/4	2 1/4	2 1/4
Load Capacity Tension (lbs) *	155	670	1255	1465	2105
Load Capacity Shear (lbs) *	300	610	1055	1800	2900

* Based on concrete compression strength of 4000 psi using applied safety factor of 4.0. For additional loading contact factory.



Rod Hanger
(RH) Style



Wire Hanger
(WH) Style

Sleeve Type Expansion - Data	Hanger Rod			Wire Hanger
	1/4"	3/8"	1/2"	5/16"
ANSI Drill Bit Size (in.)	1/4	3/8	1/2	5/16
Fixture Clearance Hole (in.)	NA	NA	NA	1/4
Plow Bolt Size (UNC)	#10-24	5/16"-18	3/8"-16	1/4"-20
Coupling Height (in.)	7/8	1	1 1/4	NA
Min. Embedment Depth (in.)	5/8	15/8	2 1/4	1 1/2
Load Capacity Tension (lbs) *	155	670	1255	520
Load Capacity Shear (lbs) *	300	610	1055	380

* Based on concrete compression strength of 4000 psi using applied safety factor of 4.0. For additional loading go to www.cooperblineline.com.

Sleeve Type Expansion Anchors

UPC/Part Number	Catalog Number	Size	Thread Length	Box Qty.
Hex Nut Style				
78101102995	ASA-37-187HN	3/8" x 1 7/8"	1 5/8"	50
78101102996	ASA-37-300HN	3/8" x 3"	1 5/8"	50
78205153400	ASA-37-400HN	3/8" x 4"	1 5/8"	50
78101102997	ASA-50-225HN	1/2" x 2 1/4"	2 1/8"	25
78101102998	ASA-50-300HN	1/2" x 3"	2 1/4"	25
78101102999	ASA-50-400HN	1/2" x 4"	2 1/4"	25
78205153351	ASA-50-525HN	1/2" x 5 1/4"	2 1/4"	25
78101103002	ASA-50-600HN	1/2" x 6"	2 1/4"	10
78101103003	ASA-62-225HN	5/8" x 2 1/4"	2 1/8"	25
78101103004	ASA-62-300HN	5/8" x 3"	2 3/4"	25
78101103005	ASA-62-425HN	5/8" x 4 1/4"	2 3/4"	10
78101103006	ASA-62-600HN	5/8" x 6"	2 3/4"	10
78101103007	ASA-75-250HN	3/4" x 2 1/2"	2 1/8"	10
78101103008	ASA-75-425HN	3/4" x 4 1/4"	3 3/8"	10
78101103009	ASA-75-625HN	3/4" x 6 1/4"	3 3/8"	10

Hex Nut Style - Stainless Steel

78205153343	ASA-37-187HNSS4	3/8" x 1 7/8"	1 5/8"	50
78205153345	ASA-37-300HNSS4	3/8" x 3"	1 5/8"	50
78205153347	ASA-50-225HNSS4	1/2" x 2 1/4"	2 1/8"	25
78205153349	ASA-50-300HNSS4	1/2" x 3"	2 1/4"	25
78205153350	ASA-50-400HNSS4	1/2" x 4"	2 1/4"	25
78205153352	ASA-62-425HNSS4	5/8" x 4 1/4"	2 3/4"	10
78205153353	ASA-75-400HNSS4	3/4" x 4"	3 3/8"	10

Acorn Nut Style

78205153341	ASA-25-62AN	1/4" x 5/8"	1/2"	100
78101102991	ASA-25-137AN	1/4" x 1 3/8"	1 1/8"	100
78101102992	ASA-25-225AN	1/4" x 2 1/4"	1 1/8"	100

Slotted Round Head Style

78205153338	ASA-25-112RS	1/4" x 1 1/8"	1"	100
78205153340	ASA-25-200RS	1/4" x 2"	1 1/8"	100

UPC/Part Number	Catalog Number	Size	Drill Diameter	Box Qty.
Rod Hanger				
78205153339	ASA-25-150RH	1/4" x 1 1/2"	5/16"	50
78205153344	ASA-37-187RH	3/8" x 1 7/8"	3/8"	50
78205153348	ASA-50-225RH	1/2" x 2 1/4"	1/2"	25
Wire Hanger				
78205153342	ASA-31-150WH	5/16" x 1 1/2"	5/16"	100

Read safety/installation instruction sheets in packages before use.

Anchors

Double Expansion Anchors

- For use in concrete, block, brick or stone.
- Double expansion anchor is particularly suited for base materials of questionable strength (job site tests are recommended).
- Internally threaded anchor for easy removability and service work.
- Made of Zamac Alloy material.



Double Expansion - Data	1/4"	3/8"	1/2"	5/8"
ANSI Drill Bit Size (in.)	1/2	3/4	7/8	1
Max. Tightening Torque (ft-lbs)	5	10	20	30
Thread Size (UNC)	1/4"-20	3/8"-16	1/2"-13	5/8"-11
Thread Length In Cone (in.)	1/2	5/8	3/4	7/8
Min. Embedment Depth (in.)	1 1/4	1 3/4	2 1/4	2 1/2
Load Capacity Tension (lbs) *	415	875	1625	1750
Load Capacity Shear (lbs) *	405	1000	1540	2855

* Based on concrete compression strength of 4000 psi using applied safety factor of 4.0. For additional loading information contact factory.

UPC/Part Number	Catalog Number	Rod Size	Anchor Length	Box Qty.
78101103251	ADE-25	1/4"	1 3/8"	50
78101103253	ADE-37	3/8"	2"	50
78101103254	ADE-50	1/2"	2 1/2"	25
78101103256	ADE-62	5/8"	2 3/4"	25

Single Expansion Anchors

- For use in concrete, block, brick or stone.
- Recommended for floor and wall attachments.
- Not recommended for overhead applications.
- Internally threaded anchor for easy removability and service work.
- Made of Zamac Alloy material.



Single Expansion - Data	1/4"	3/8"	1/2"	5/8"
ANSI Drill Bit Size (in.)	1/2	3/4	7/8	1
Max. Tightening Torque (ft-lbs)	5	10	20	30
Thread Size (UNC)	1/4"-20	3/8"-16	1/2"-13	5/8"-11
Thread Length In Cone (in.)	5/16	5/16	7/16	5/8
Min. Embedment Depth (in.)	1 3/8	1 5/8	2 1/2	2 3/4
Load Capacity Tension (lbs) *	500	725	1225	2050
Load Capacity Shear (lbs) *	405	950	1540	2855

* Based on concrete compression strength of 4000 psi using applied safety factor of 4.0. For additional loading information contact factory.

UPC/Part Number	Catalog Number	Rod Size	Anchor Length	Box Qty.
Single Expansion Anchor				
78101103245	ASE-25	1/4"	1 5/16"	50
78101103247	ASE-37	3/8"	1 1/2"	50
78101103248	ASE-50	1/2"	2 1/16"	25
78101103249	ASE-62	5/8"	2 5/8"	25

Read safety/installation instruction sheets in packages before use.

Anchors

Wood Knocker™† Anchors

- Wood-Knocker™ concrete inserts are installed onto wooden forms used to support newly poured concrete floor slabs, roof slabs or walls.
- When the forms are stripped, the color-coded flange is visibly embedded in the concrete surface.
- The unique, six sided impact plate offers resistance to rotation within the concrete as threaded rod is being installed.
- Suitable for overhead installations such as suspending cable tray, pipe hangers, strut and conduit.
- Color coded by size for all trades.
- UL and FM approved.
- Lowest in-place cost.



Wood Knocker™ - Data	1/4"	3/8"	1/2"	5/8"	3/4"
Insert Thread Length (in.)	3/8	5/8	11/16	15/16	1 1/8
Plastic Flange Diameter (in.)	1 3/8	1 3/8	1 3/8	1 5/8	1 5/8
Thread Size (UNC)	1/4"-20	3/8"-16	1/2"-13	5/8"-11	3/4"-10
Overall Length (in.)	1 7/8	1 7/8	1 7/8	1 7/8	1 7/8
Min. Insert Spacing (in.)	9	9	9	12	12
Min. End Distance (in.)	6	6	6	9	9
Load Capacity Tension (lbs) *	930	1200	1200	1160	1160
Load Capacity Shear (lbs) *	370	1330	1840	2800	2800

* Based on normal weight concrete with minimum compression strength of 3000 psi. Allowable load capacities are calculated using applied safety factor of 4.0. For additional loading information contact factory. Minimum embedment depth is 2".

UPC/Part Number	Catalog Number	Rod Diameter	Color	Box Qty.
Wood Knocker				
78205131147	ACPW-25	1/4"	Brown	100
78205131149	ACPW-38	3/8"	Green	100
78205131151	ACPW-50	1/2"	Yellow	100
78205131152	ACPW-62	5/8"	Red	50
78205131153	ACPW-75	3/4"	Purple	50

† Wood Knocker™ is a registered trademark used by Power® Fasteners, Inc.

Bang-It™† Anchors

- Bang-It™ concrete inserts are designed for installation in and through metal composite deck used to support newly poured concrete floors or roof slabs.
- After installation, the protective sleeve of the insert protrudes below the surface of the deck, allowing overhead attachment of threaded rod.
- The unique, six sided impact plate offers resistance to rotation within the concrete as threaded rod is being installed.
- Suitable for overhead installations such as suspending cable tray, pipe hangers, strut and conduit.
- Color coded by size for all trades.
- UL and FM approved.
- Lowest in-place cost.



Bang-It™ - Data	1/4"	3/8"	1/2"	5/8"	3/4"	7/8"
Metal Hole Saw Diameter (in.)	13/16	13/16	13/16	13/16	13/16	13/16
Drilling Speed (rpm)	700-900	700-900	700-900	500-700	500-700	500-700
Insert Thread Length (in.)	3/8	5/8	11/16	15/16	1 1/8	1 5/16
Length of Sleeve (in.)	3 3/8	3 3/8	3 3/8	3 3/8	3 3/8	3 3/8
Thread Size (UNC)	1/4"-20	3/8"-16	1/2"-13	5/8"-11	3/4"-10	7/8"-9
Embedment Depth (in.)	2	2	2	2	2	2
Upper Deck Tension Load (lbs) *	835	1435	1775	2200	2200	2200
Lower Deck Tension Load (lbs) *	835	1115	1115	1115	1115	1115
Upper Deck Shear Load (lbs) *	620	620	620	740	740	740
Lower Deck Shear Load (lbs) *	625	840	840	840	840	840

* Based on normal weight concrete with minimum compression strength of 3000 psi. Allowable load capacities are calculated using applied safety factor of 4.0. For additional loading information contact factory. Minimum insert spacing of 12", minimum end spacing 12".

UPC/Part Number	Catalog Number	Rod Diameter	Color	Box Qty.
Bang-It™				
78205131154	ACPD-25	1/4"	Brown	100
78205131156	ACPD-38	3/8"	Green	100
78205131157	ACPD-50	1/2"	Yellow	100
78205131158	ACPD-62	5/8"	Red	50
78205131166	ACPD-75	3/4"	Purple	50
78205153258	ACPD-87	7/8"	Black	50

Bang-It™ Hole Saws

78205131169	ACPD-HS813	13/16" Carbide Hole Saw for 1/4", 3/8", 1/2"	1
78205131171	ACPD-HS1188	13/16" Carbide Hole Saw for 5/8", 3/4", 7/8"	1

† Bang-It™ is a registered trademark used by Power® Fasteners, Inc.

Read safety/installation instruction sheets in packages before use.

Anchors

Machine Screw Anchors

- For use in concrete, block, brick or stone.
- Not recommended for use in overhead applications.
- Readily accepts machine bolts.
- Internally threaded anchor for easy removability and service work.
- Anchor installation requires shallow embedment.
- Made of Zamac Alloy material.

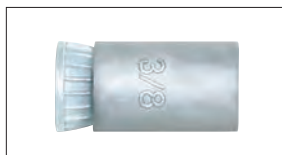

Machine Screw Anchor - Data	1/4"	3/8"	1/2"
ANSI Drill Bit Size (in.)	1/2	3/4	7/8
Max. Tightening Torque (ft-lbs)	5	10	15
Thread Size (UNC)	1/4"-20	3/8"-16	1/2"-13
Min. Embedment Depth (in.)	7/8	1 1/4	1 1/2
Load Capacity Tension (lbs) *	585	775	1095
Load Capacity Shear (lbs) *	355	825	1135

* Based on concrete compression strength of 4000 psi using applied safety factor of 4.0. For additional loading information contact factory.

UPC/Part Number	Catalog Number	Rod Diameter	Box Qty.
Machine Screw Anchor			
78101103239	AMS-25	1/4"	100
78101103242	AMS-37	3/8"	50
78101103243	AMS-50	1/2"	50
Setting Tool			
78205109765	9221	1/4"	1
78205109767	9231	3/8"	1
78205109768	9241	1/2"	1

Self-Tapping Machine Screw Anchors

- For use in normal-weight concrete, structural sand lightweight concrete and concrete over metal deck.
- Anchor design allows for shallow embedment and mechanically interlocks with base material.
- Internally threaded anchor for easy adjustment and removability of threaded rod or bolt.
- Fast anchor installation with a powered impact wrench.
- Suitable for overhead applications such as suspending cable tray, strut, pipe hangers and conduit.
- FM Approved.
- ICC-ES listed, ESR-2272
- Made of Zinc Plated carbon steel.
- Setting tool included.



Self-Tapping Machine Screw - Data	3/8"
ANSI Drill Bit Size (in.)	1/2
Min. Concrete Thickness (in.)	4
Max. Tightening Torque (ft-lbs)	8
Min. Embedment Depth (in.)	1 ⁵ / ₈
Load Capacity Tension (lbs) *	540
Load Capacity Shear (lbs) *	825

* Based on concrete compression strength of 4000 psi in uncracked concrete using applied safety factor of 4.0. For additional loading information contact factory.
For ultimate strength design data in cracked and uncracked concrete, see ICC-ES ESR-2526.

UPC/Part Number	Catalog Number	Size	Thread Depth	Box Qty.
Self-Tapping Machine Screw Anchor				
78205153362	ATM-37	3/8"	11/16"	50
Tool				
78205153363	6407 SD	3/8"	--	1

Read safety/installation instruction sheets in packages before use.

Anchors

Drive Nail Anchors

- For use in concrete, block or brick.
- Anchor is recommended for light duty, tamper-proof applications.
- Not recommended for overhead applications.
- Made of Zamac Alloy material.



Drive Nail - Data	3/16"	1/4"
ANSI Drill Bit Size (in.)	3/16	1/4
Fixture Clearance Hole (in.)	1/4	5/16
Head Height (in.)	7/64	9/64
Head Size, O.D. (in.)	13/32	35/64
Min. Embedment Depth (in.)	3/4	5/8
Load Capacity Tension (lbs) *	125	150
Load Capacity Shear (lbs) *	175	205

* Based on concrete compression strength of 4000 psi using applied safety factor of 4.0. For additional loading information contact factory.

UPC/Part Number	Catalog Number	Size	Box Qty.
Drive Nail Anchor			
78101102964	ADN-18-87	3/16" x 7/8"	100
78101102965	ADN-25-75	1/4" x 3/4"	100
78101102966	ADN-25-100	1/4" x 1"	100
78101102967	ADN-25-125	1/4" x 1 1/4"	100
78101102968	ADN-25-150	1/4" x 1 1/2"	100
78101102969	ADN-25-200	1/4" x 2"	100
78205153306	ADN-25-300	1/4" x 3"	100

Read safety/installation instruction sheets in packages before use.

Toggle Bolts

- The toggle bolt is a spring wing type hollow wall anchor designed for use in block, wallboard and other hollow base materials.
- Anchor is a two-part assembly consisting of a machine screw and a spring wing toggle.
- Adjustable to accommodate various wall thicknesses up to 2¹/₂".
- Combo round head bolt is provided.
- Made of zinc plated carbon steel.



Toggle Bolt - Data	3/16"		1/4"		3/8"	
	Tension (lbs.)	Shear (lbs.)	Tension (lbs.)	Shear (lbs.)	Tension (lbs.)	Shear (lbs.)
3/8" Wallboard	35	35	55	55	60	65
1/2" Wallboard	45	50	60	60	65	75
5/8" Wallboard	60	60	65	65	75	80
3/4" Wallboard	75	70	80	75	85	90
Hollow Concrete Masonry *	70	70	70	120	195	140

Allowable load capacities are calculated using applied safety factor of 4.0. For additional loading information contact factory.

* Based on hollow wall concrete masonry with minimum compression strength of 1500 psi.

UPC/Part Number	Catalog Number	Drill Diameter	Size	Box Qty.
Toggle Bolt				
78205153354	ATB-18-300	1/2"	3/16" x 3"	50
78205153355	ATB-18-400	1/2"	3/16" x 4"	50
78205153356	ATB-25-300	5/8"	1/4" x 3"	50
78205153357	ATB-25-400	5/8"	1/4" x 4"	50
78205153358	ATB-37-300	7/8"	3/8" x 3"	25
78205153359	ATB-37-400	7/8"	3/8" x 4"	25

Read safety/installation instruction sheets in packages before use.

Anchors

Wall Screws

- One-piece, all steel anchor with high-profile threads for easy fastening into wallboard and other masonry base materials.
- Deep cutting, corkscrew-like threads provide for smooth entry and a strong hold.
- No pre-drilling is required when fastening into wallboard or wood.
- Fastening into concrete, hollow or grout filled block, brick and plaster requires a pre-drilled $\frac{3}{16}$ " ANSI hole.
- Installed with a No. 8 drill bit or No. 2 Phillips driver.
- Made of case hardened carbon steel with chrome finish.



Wall Screw - Data	Minimum Embedment Depth	Load Cap. Tension (lbs.) *	Load Cap. Shear (lbs.) *
Concrete *	$\frac{3}{4}$ "	90	260
$\frac{1}{2}$ " Wallboard	NA	20	60
$\frac{5}{8}$ " Wallboard	NA	35	90
$\frac{3}{4}$ " Plywood	NA	65	150
Grout-Filled Concrete Masonry	1"	55	165
Hollow Concrete Masonry	1"	60	165
Brick Masonry	$\frac{3}{4}$ "	70	120

* Based on concrete compression strength of 4000 psi. Allowable load capacities are calculated using an applied safety factor of 4.0. For additional loading contact factory.

UPC/Part Number	Catalog Number	Size	Head Type	Box Qty.
Wall Screw				
78205153372	AWS-CH	$\frac{3}{16}$ " x $1\frac{1}{4}$ "	Combo	100
78205153373	AWS-OH	$\frac{3}{16}$ " x $1\frac{1}{4}$ "	Oval	100
78205153374	AWS-PH	$\frac{3}{16}$ " x $1\frac{1}{4}$ "	Pan	100

Read safety/installation instruction sheets in packages before use.

Plastic Screw Anchors

- One-piece anchor designed for light duty applications in wallboard, concrete and masonry.
- Works in hollow or solid base materials.
- Suitable for screws with various thread sizes and styles - screws may be installed with a screw gun.



Plastic Screw Anchor - Data	APS-4	APS-6	APS-8
Drill Diameter (in.)	3/16	1/4	5/16
Screw Size Range	#4-#10	#6-#12	#8-#14
Min. Thread Length (in.)	1 3/16	1 3/8	1 13/16
Min. Hole Diameter (in.)	1 3/8	1 9/16	2
Min. Wall Thickness (in.)	1/4	3/8	1/2
Min. Embedded Thread Length (in.)	1 7/8	2	2 9/16
Load Capacity Tension (lbs) *	18	20	22
Load Capacity Shear (lbs) *	32	40	45

* Allowable load capacities are calculated using an applied safety factor of 4.0. For additional loading information contact factory.

UPC/Part Number	Catalog Number	Screw Size	Box Qty.
Plastic Screw Anchors			
78205153315	APS-4	#4 - #10	100
78205153316	APS-6	#6 - #12	100
78205153319	APS-8	#8 - #14	100

Read safety/installation instruction sheets in packages before use.

Anchors

Plastic Hollow Wall Anchors

- Heavy duty hollow wall anchor designed for use in plaster, wallboard, concrete block, or hollow tile.
- Pre-assembled anchor consisting of a carbon steel wing and a locking cap/ratchet leg assembly molded from engineered plastic.
- When compared to traditional toggles, this anchor can be installed in a smaller hole and does not require a fixture or screw to set it.
- Adjustable to accommodate various wall thickness up to 2 1/2".



Plastic Hollow Wall - Data	3/16"	1/4"	3/8"	1/2"
Thread Size (UNC)	3/16"-24	1/4"-20	3/8"-16	1/2"-13
Max. Tightening Torque (ft-lbs)	5	5	5	5
Minimum Clearance (in.)	1 7/8"	1 7/8"	1 7/8"	1 7/8"

Plastic Hollow Wall - Data	3/16"		1/4"		3/8"		1/2"	
	Tension (lbs.)	Shear (lbs.)	Tension (lbs.)	Shear (lbs.)	Tension (lbs.)	Shear (lbs.)	Tension (lbs.)	Shear (lbs.)
3/8" Wallboard	30	60	35	70	35	70	35	75
1/2" Wallboard	35	70	35	75	40	75	40	90
5/8" Wallboard	50	95	55	105	55	105	55	110
3/4" Wallboard	50	110	55	120	60	120	60	120
Hollow Concrete Masonry *	215	150	270	285	285	465	345	595

Allowable load capacities are calculated using an applied safety factor of 4.0. For additional loading information contact factory.

* Based on hollow wall concrete masonry with minimum compression strength of 1500 psi.

UPC/Part Number	Catalog Number	Anchor Size	Drill Dia.	Wall Thickness	Box Qty.
78205153311	APH-18	3/16" x 4"	1/2"	3/8" - 2 1/2"	50
78205153312	APH-25	1/4" x 4"	1/2"	3/8" - 2 1/2"	50
78205153313	APH-37	3/8" x 4"	3/4"	3/8" - 2 1/2"	25
78205153314	APH-50	1/2" x 4"	3/4"	3/8" - 2 1/2"	25

Self-Drilling Wallboard Anchors

- One-piece self drilling anchor designed for use in hollow wallboard for light to medium duty loads.
- Ideal for mounting electrical fixtures, phone systems, and miscellaneous hardware.
- APD/AZD designed for use in $\frac{3}{8}$ " to 1" wallboard.
- APDM/AZDM designed for use in $\frac{3}{8}$ " to $\frac{5}{8}$ " wallboard.
- Kit includes 50 anchors, 50 screws and #2 Phillips Drive Bit.
- Available in engineered Nylon and Zamac Alloy.



Self-Drilling Wallboard Anchor - Data	APD/AZD	APDM/AZDM
Anchor Length (in.)	1 ¹¹ / ₁₆	1 ⁵ / ₁₆
Min. Screw Engagement (in.)	$\frac{3}{4}$	$\frac{3}{4}$

Self-Drilling Wallboard Anchor - Data	APD/AZD		APDM/AZDM	
	Tension (lbs.)	Shear (lbs.)	Tension (lbs.)	Shear (lbs.)
$\frac{3}{8}$ " Wallboard	15	15	10	15
$\frac{1}{2}$ " Wallboard	15	20	15	15
$\frac{5}{8}$ " Wallboard	20	25	20	20
$\frac{3}{4}$ " Wallboard	20	25	20	20

Allowable load capacities are calculated using an applied safety factor of 4.0. For additional loading information contact factory.

UPC/Part Number	Catalog Number	Screw Size	Box Qty.
Self-Drilling Wallboard Anchor			
78101103314	APD-8K	#8 x 1"	50
78101103318	AZD-8K	#8 x 1"	50
78205153310	APDM-6K	#6 x 1"	50
78205153375	AZDM-6K	#6 x 1"	50

Read safety/installation instruction sheets in packages before use.

Anchors

Plastic Conical Anchors

- Designed for use with lightweight fixtures.
- Recommended for use in concrete, block and brick.
- Recommended for light duty static applications where holding power is not critical.
- Not recommended for overhead use.
- Kit includes 100 anchors, 100 screws and one drill bit.
- Made of engineered plastic.



Plastic Conical Anchor - Data	#8		#10 - #12	
	Tension (lbs.)	Shear (lbs.)	Tension (lbs.)	Shear (lbs.)
Nominal Weight Concrete *	110	70	140	90
Hollow Concrete Masonry **	60	45	70	55
Clay Brick Masonry ***	30	50	55	65
Minimum Embedment Depth	7/8"	7/8"	1"	1"

* Based on concrete compression strength of 4000 psi.

** Based on hollow concrete masonry with minimum compression strength of 1500 psi.

*** Based on clay brick masonry with minimum compression strength of 1500 psi.

Loads contain an applied safety factor of 4.0. For additional loading information contact factory.

UPC/Part Number	Catalog Number	Screw Size	Box Qty.
78205153307	APC-8K	#8 x 1"	100
78205153308	APC-10K	#10 x 1"	100
78205153309	APC-12K	#12 x 1"	100

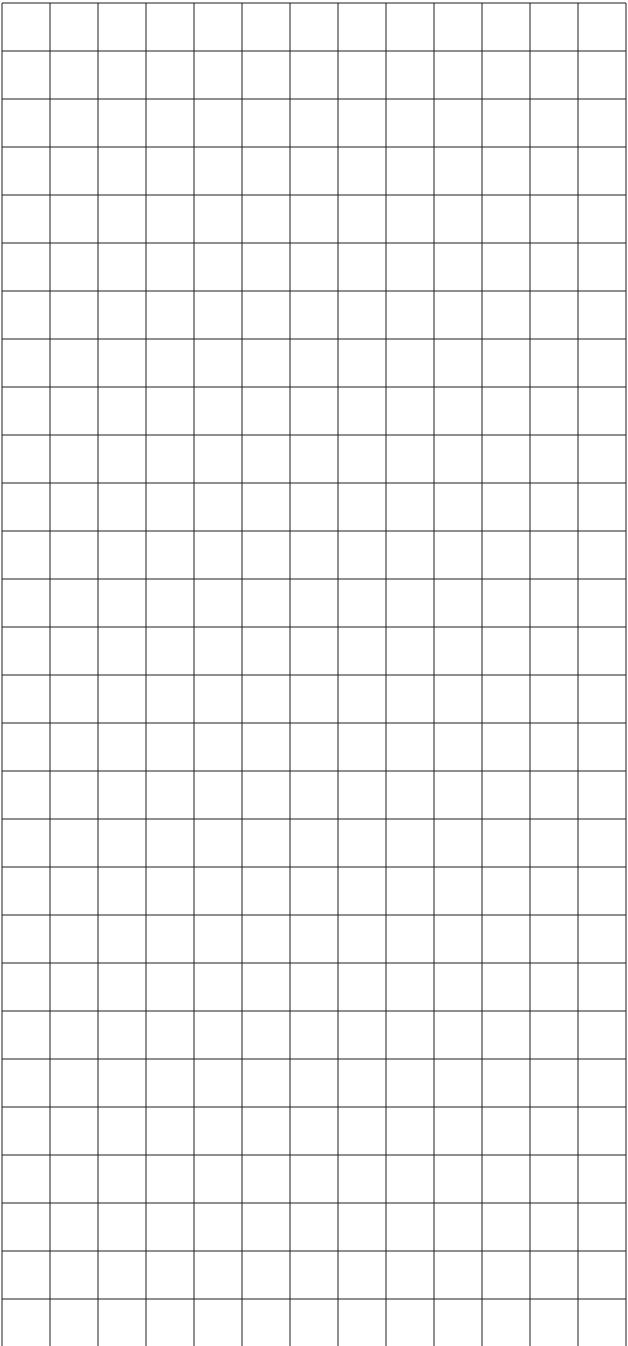

Code Compliance for Spring Steel Fasteners Based on the 2005 NEC®

Eaton's B-Line Business has recognized the need for a reference source, detailing the National Electrical Code requirements for Spring Steel Fasteners. The following pages are reprinted portions of the 2005 NEC. These sections address nearly every aspect of fastener installations and offer design solutions for the electrical industry. If a topic has not been covered sufficiently to answer a specific question or if additional information is desired, contact our engineering department.

The following information has been carefully checked for accuracy and is believed to be correct and current. No warranty, either expressed or implied, is made as to either its applicability to, or its compatibility with, specific requirements, of this information, nor for damages consequent to its use. All design characteristics, specifications, tolerances and similar information are subject to change without notice.

To obtain a copy of the NEC® contact:
National Fire Protection Association
1 Batterymarch Park
P.O. Box 9101
Quincy, Massachusetts 02269-9101
1-800-344-3555

National Electrical Code® and *NEC®*
are registered trademarks of the
National Fire Protection Association, Inc.
Quincy, MA 02269.

Reprinted with permission from NFPA 70-2005, the *National Electrical Code®*, Copyright® 2005, National Fire Protection Association, Quincy, MA 02269.

This reprinted material is not the complete and official position of the National Fire Protection Association, on the referenced subject which is represented only by the standard in its entirety.

90.4 Enforcement. This *Code* is intended to be suitable for mandatory application by governmental bodies that exercise legal jurisdiction over electrical installations, including signaling and communications systems, and for use by insurance inspectors. The authority having jurisdiction for enforcement of the *Code* has the responsibility for making interpretations of the rules, for deciding upon the approval of equipment and materials, and for granting the special permission contemplated in a number of the rules.

By special permission, the authority having jurisdiction may waive specific requirements in this *Code* or permit alternate methods where it is assured that equivalent objectives can be achieved by establishing and maintaining effective safety. *

This *Code* may require new products, constructions, or materials that may not yet be available at the time the *Code* is adopted. In such event, the authority having jurisdiction may permit the use of the products, constructions, or materials that comply with the most recent previous edition of this *Code* adopted by the jurisdiction.

Article 100 - Definitions

Listed. Equipment, materials, or services included in a list published by an organization that is acceptable to the authority having jurisdiction and concerned with evaluation of products or services, that maintains periodic inspection of production of listed equipment or materials or periodic evaluation of services, and whose listing states that the equipment, material, or services either meets appropriate designated standards or has been tested and found suitable for a specific purpose.

FPN: The means for identifying listed equipment may vary for each organization concerned with product evaluation, some of which do not recognize equipment as listed unless it is labeled. Use of the system employed by the listing organization allows the authority having jurisdiction to identify a listed product.

***Note:** Local codes may override certain requirements of the National Electrical Code®. Consult your local inspector for further details.

Reprinted with permission from NFPA 70-2005, the *National Electrical Code*®, Copyright® 2005, National Fire Protection Association, Quincy, MA 02269.

This reprinted material is not the complete and official position of the National Fire Protection Association, on the referenced subject which is represented only by the standard in its entirety.

300.4 Protection Against Physical Damage.

Where subject to physical damage, conductors shall be adequately protected.

(A) Cables and Raceways through Wood Members.

- (1) **Bored Holes.** . . . , holes shall be bored so that the edge of the hole is not less than 32mm (1¹/₄ in.) from the nearest edge of the wood member. Where this distance cannot be maintained, the cable or raceway shall be protected from penetration by screws or nails by a steel plate or bushing, at least 1.6 mm (1/16 in.) thick, and of appropriate length and width installed to cover the area of the wiring. (See Figure 1)

Exception No. 1: Steel plates shall not be required to protect RMC, IMC, RNC, or EMT.

*Exception No. 2: A **listed** and marked steel plate less than 1.6 mm (1/16 in.) thick that provides equal or better protection against nail or screw penetration shall be permitted.*

- (2) **Notches in Wood.** . . . , cables or raceways shall be permitted to be laid in notches in wood studs, joists, rafters, or other wood members where the cable or raceway at those points is protected against nails or screws by a steel plate at least 1.6 mm (1/16 in.) thick, and of appropriate length and width, installed to cover the area of the wiring. The steel plate shall be installed before the building finish is applied. (See Figure 1)

Exception: See Exceptions 1 & 2 from (1) Bored Holes

(B) Nonmetallic-Sheathed Cables and Electrical Nonmetallic Tubing through Metal Framing Members.

- (1) **Nonmetallic-Sheathed Cable.** . . . where nonmetallic-sheathed cables pass through either factory or field punched, cut or drilled slots or holes in metal members, the cable shall be protected by listed bushings or listed grommets covering all metal edges that are securely fastened in the opening prior to installation of the cable. (See Figure 2)

- (2) **Nonmetallic-Sheathed Cable and Electrical Nonmetallic Tubing.** Where nails or screws are likely to penetrate nonmetallic-sheathed cable or electrical nonmetallic tubing, a steel sleeve, steel plate, or steel clip not less than 1.6 mm (1/16 in.) in thickness shall be used to protect the cable or tubing. (See Figure 1)

Exception: See Exception 2 from (A)(1) Bored Holes

(D) Cables and Raceways Parallel to Framing Members and Furring Strips.

... , the cable or race way shall be installed and supported so that the nearest outside surface of the cable or raceway is not less than 32 mm (1¹/₄ in.) from the nearest edge of the framing member or furring strips where nails or screws are likely to penetrate. Where this distance cannot be maintained, the cable or raceway shall be protected from penetration by nails or screws by a steel plate, sleeve, or equivalent at least 1.6 mm (1¹/₁₆ in.) thick

(See Figures 1, 3, 4)

Exception 1: See Exception 1 from (A)(1) Bored Holes

Exception No. 2: For concealed work in finished buildings, or finished panels for prefabricated buildings where such supporting is impracticable, it shall be permissible to fish the cables between access points.

Exception 3: See Exception 2 from (A)(1) Bored Holes

(E) Cables and Raceways Installed in Shallow Grooves.

... , shall be protected by 1.6 mm (1¹/₁₆ in.) thick steel plate, sleeve, or equivalent or by not less than 32 mm (1¹/₄ in.) free space for the full length of the groove in which the cable or raceway is installed.

(See Figure 1)

Exception: See Exceptions 1 & 2 from (A)(1) Bored Holes

Figure 1 - BM3 & BM3M

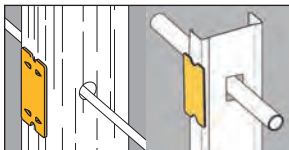

Figure 2 - BM1/BM2

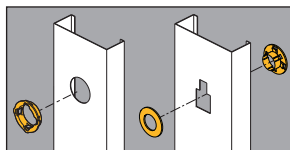
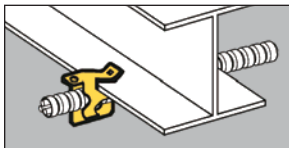

Figure 3 - BRC4 & BRC6M



Figure 4 - BX4



Reprinted with permission from NFPA 70-2005, the *National Electrical Code*®, Copyright® 2005, National Fire Protection Association, Quincy, MA 02269.

This reprinted material is not the complete and official position of the National Fire Protection Association, on the referenced subject which is represented only by the standard in its entirety.

300.11 Securing and Supporting.

(A) Secured in Place. Raceways, cable assemblies, boxes, cabinets, and fittings shall be securely fastened in place. Support wires that do not provide secure support shall not be permitted as the sole support. Support wires and associated fittings that provide secure support and that are installed in addition to the ceiling grid support wires shall be permitted as the sole support. Where independent support wires are used, they shall be secured at both ends. Cables and race ways shall not be supported by ceiling grids.

(1) Fire Rated Assemblies. Wiring located within the cavity of a fire-rated floor-ceiling or roof-ceiling assembly shall not be secured to, or supported by, the ceiling assembly, including the ceiling support wires. An independent means of secure support shall be provided and shall be permitted to be attached to the assembly. Where independent support wires are used, they shall be distinguishable by color, tagging, or other effective means from those that are part of the fire-rated design.

Exception: *The ceiling support system shall be permitted to support wiring and equipment that have been tested as part of the fire-rated assembly.*

(2) Non-Fire-Rated Assemblies. Wiring located within the cavity of a non-fire-rated floor-ceiling or roof-ceiling assembly shall not be secured to, or supported by, the ceiling assembly, including the ceiling support wires. An independent means of secure support shall be provided.

Exception: *The ceiling support system shall be permitted to support branch-circuit wiring and associated equipment where installed in accordance with the ceiling system manufacturer's instructions.*

Note: A previously acceptable practice, namely supporting cable and raceways by the ceiling grid, is no longer allowed. The intent of Article 300.11 is simple: an independent means of secure support must be provided for cable assemblies, raceways, boxes, etc. (See Figures 5 - 8)

Typical Drop Wire / Rod Applications

Additional drop wires, which are installed specifically for cable support, must be secured at both ends. When independent wires are used in fire-rated assemblies, they must be distinguishable from those wires that are part of the fire-rated assembly. B-Line's BA-311 series can be used to secure support wire to the ceiling grid. Its bright yellow color allows it to be easily recognized by inspectors. (See Figure 8)

Upper Attachments

Figure 5 - BE Series

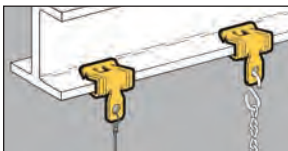

Figure 6 - BF3 Series & BF4 Series

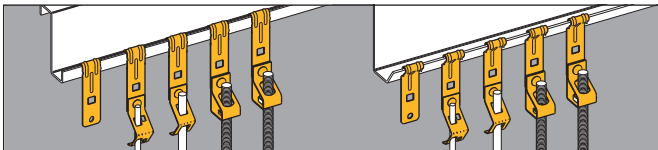

Figure 7 - BG-8-12-S18-W2

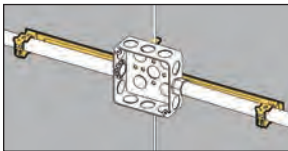
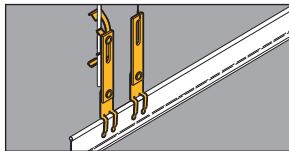

Figure 8 - BA311



Reprinted with permission from NFPA 70-2005, the *National Electrical Code*®, Copyright® 2005, National Fire Protection Association, Quincy, MA 02269.

This reprinted material is not the complete and official position of the National Fire Protection Association, on the referenced subject which is represented only by the standard in its entirety.

310.15 Ampacities For Conductors Rated 0-2000 Volts.

(B) Tables

(2) Adjustment Factors.

- (a) More Than Three Current-Carrying Conductors in a Raceway or Cable. Where the number of current-carrying conductors in a raceway or cable exceeds three, or where single conductors or multiconductor cables are stacked or bundled longer than 600 mm (24 in.) without maintaining spacing and are not installed in raceways, the allowable ampacity of each conductor shall be reduced as shown in Table 310.15(B)(2)(a). Each current-carrying conductor of a paralleled set of conductors shall be counted as a current-carrying conductor.

FPN No. 1: See Annex B, Table B.310.11, for adjustment factors for more than three current-carrying conductors in a raceway or cable with load diversity.

FPN No. 2: See 366.23(A), for correction factors for conductors in sheet metal auxiliary gutters and 376.22 for correction factors for conductors in metal raceways.

Exception No. 1: Where conductors of different systems, as provided in 300.3, are installed in a common raceway or cable, the derating factors shown in Table 310.15(B)(2)(a) shall apply only to the number of power and lighting conductors (Articles 210, 215, 220, and 230).

Exception No. 2: For conductors installed in cable trays, the provisions of 392.11 shall apply.

Exception No. 3: Derating factors shall not apply to conductors in nipples having a length not exceeding 600 mm (24 in.).

Exception No. 4: Derating factors shall not apply to underground conductors entering or leaving an outdoor trench if those conductors have physical protection in the form of rigid metal conduit, intermediate metal conduit, or rigid nonmetallic conduit having a length not exceeding 3.05 m (10 ft) and if the number of conductors does not exceed four.

Reprinted with permission from NFPA 70-2005, the *National Electrical Code*®, Copyright® 2005, National Fire Protection Association, Quincy, MA 02269.

This reprinted material is not the complete and official position of the National Fire Protection Association, on the referenced subject which is represented only by the standard in its entirety.

Exception No. 5: Adjustment factors shall not apply to Type AC cable or to Type MC cable without an overall outer jacket under the following conditions:

- (1) Each cable has not more than three current-carrying conductors.
- (2) The conductors are 12 AWG copper.
- (3) Not more than 20 current-carrying conductors are bundled, stacked, or supported on "bridle rings".
(See Figure 9)

A 60 percent adjustment factor shall be applied where current-carrying conductors in these cables that are stacked or bundled longer than 600 mm (24 in.) without maintaining spacing exceeds 20.

- (b) More Than One Conduit, Tube, or Raceway Spacing between conduits, tubing, or raceways shall be maintained.

Figure 9 - Bridle Rings

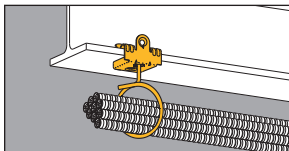
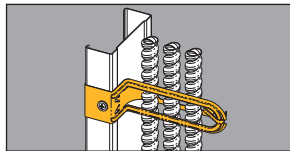

Figure 10 - BRC6M



Reprinted with permission from NFPA 70-2005, the *National Electrical Code*®, Copyright® 2005, National Fire Protection Association, Quincy, MA 02269.

This reprinted material is not the complete and official position of the National Fire Protection Association, on the referenced subject which is represented only by the standard in its entirety.

NEC Requirements

314.23 Supports. Enclosures within the scope of this article shall be supported in accordance with one or more of the provisions in 314.23 (A) through (H).

(C) Mounting in Finished Surfaces. An enclosure mounted in a finished surface shall be rigidly secured thereto by clamps, anchors, or fittings identified for the application. *(See Figures 11 & 12)*

(D) Suspended Ceilings. An enclosure mounted to structural or supporting elements of a suspended ceiling shall be not more than 1650 cm³ (100 in.³) in size and shall be securely fastened in place in accordance with either (D)(1) or (D)(2).

(1) Framing Members. An enclosure shall be fastened to the framing members by mechanical means such as bolts, screws, or rivets, or by the use of clips or other securing means identified for use with the type of ceiling framing member(s) and enclosure(s) employed. . . . *(See Figure 13)*

(2) Support Wires. The installation shall comply with the provisions of 300.11(A). The enclosure shall be secured, using methods identified for the purpose to ceiling support wire(s), including any additional support wire(s) installed for that purpose. Support wire(s) used for enclosure support shall be fastened at each end so as to be taut within the ceiling cavity. *(See Figure 14)*

(E) Raceway Supported Enclosures, Without Devices, Luminaries (Fixtures), or Lampholders.

. . . It shall be supported by two or more conduits threaded wrenchtight into the enclosure or hubs. Each conduit shall be secured within 900 mm (3 ft) of the enclosure, or within 450 mm (18 in.) of the enclosure if all conduit entries are on the same side. *(See Figure 15)*

(F) Raceway Supported Enclosures, With Devices, Luminaries (Fixtures), or Lampholders. . . . It

shall be supported by two or more conduits threaded wrenchtight into the enclosure or hubs. Each conduit shall be secured within 450 mm (18 in.) of the enclosure. *(See Figure 15)*

314.27 Outlet Boxes

(B) Maximum Luminaire (Fixture) Weight. Outlet boxes or fitting installed as required by 314.23 shall be permitted to support luminaries (lighting fixtures) weighing 23 kg (50 lbs.) or less. A luminaire (lighting fixture) that weighs more than 23 kg (50 lbs.) shall be supported independently of the outlet box unless the outlet box is listed for the weight to be supported. *(See Figure 13)*

Reprinted with permission from NFPA 70-2005, the *National Electrical Code*®, Copyright® 2005, National Fire Protection Association, Quincy, MA 02269.

This reprinted material is not the complete and official position of the National Fire Protection Association, on the referenced subject which is represented only by the standard in its entirety.

(D) Boxes at Ceiling-Suspended (Paddle) Fan Outlets.

Outlet boxes or outlet box systems used as the sole support of a ceiling-suspended (paddle) fan shall be listed, shall be marked by their manufacturer as suitable for this purpose, and shall not support ceiling-suspended (paddle) fans that weigh more than 32 kg (70 lb). For outlet boxes or outlet box systems designed to support of a ceiling-suspended (paddle) fans that weigh more than 16 kg (35 lb), the required marking shall include the maximum weight to be supported.

(See Figure 16)

Figure 11 - BB4-23

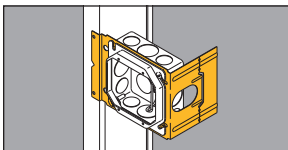

Figure 12 - BB9 & BB12



Figure 13 - BA50

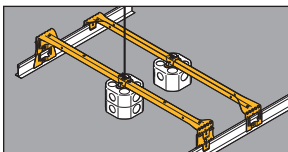

Figure 14 - BG-8-12-S18-W2

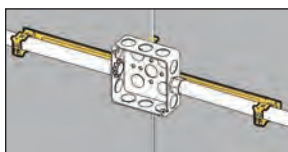

Figure 15 - BG-8-12-S18-U-2-4

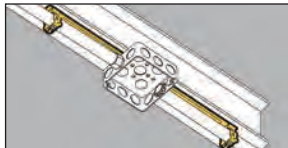
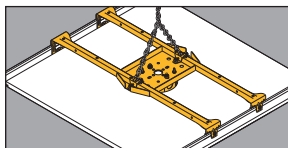

Figure 16 - BA50F



Reprinted with permission from NFPA 70-2005, the *National Electrical Code*®, Copyright® 2005, National Fire Protection Association, Quincy, MA 02269.

This reprinted material is not the complete and official position of the National Fire Protection Association, on the referenced subject which is represented only by the standard in its entirety.

NEC Requirements

Article 320 Armored Cable : Type AC

320.17 Through or Parallel to Framing Members.

Type AC cable shall be protected in accordance with 300.4 (A), (C), and (D) where installed through or parallel to framing members. (See Figures 17 & 18)

320.30 Securing and Supporting.

- (A) **General.** Type AC shall be supported and secured by staples, cable ties, straps, hangers, or similar fittings, designed and installed so as not to damage the cable.
- (B) **Securing.** Unless otherwise provided, Type AC cable shall be secured within 300 mm (12 in.) of every out let box, junction box, cabinet, or fitting and at intervals not exceeding 1.4 m (4¹/₂ ft) where installed on or across framing members. (See Figures 19 -22)
- (C) **Supporting.** Unless otherwise provided, Type AC cable shall be supported at intervals not exceeding 1.4 m (4¹/₂ ft). Horizontal runs of Type AC cable installed in wooden or metal framing members or similar supporting means shall be considered supported where such support does not exceed 1.4 m (4¹/₂ ft) intervals.

Article 330 Metal-Clad Cable : Type MC

330.17 Through or Parallel to Framing Members.

Type MC cable shall be protected in accordance with 300.4 (A), (C), and (D) where installed through or parallel to framing members. (See Figures 17 & 18)

330.30 Securing and Supporting.

- (A) **General.** Type MC shall be supported and secured by staples, cable ties, straps, hangers, or similar fittings or other approved means designed and installed so as not to damage the cable.
- (B) **Securing.** Unless otherwise provided, cables shall be secured at intervals not exceeding 1.8 m (6 ft). Cables containing four or fewer conductors sized no larger than 10 AWG shall be secured within 300 mm (12 in.) of every box, cabinet, fitting or other cable termination. (See Figure 19 - 22)
- (C) **Supporting.** Unless otherwise provided, cables shall be supported at intervals not exceeding 1.8 m (6ft). Horizontal runs of Type MC cable installed in wooden or metal framing members or similar supporting means shall be considered supported and secured where such support does not exceed 1.8 m (6 ft) intervals.

Article 334 Nonmetallic Sheathed Cables

334.17 Through or Parallel to Framing Members.

Type NM, NMC, or NMS cable shall be protected in accordance with 300.4 where installed through or

Reprinted with permission from NFPA 70-2005, the *National Electrical Code*®, Copyright® 2005, National Fire Protection Association, Quincy, MA 02269.

This reprinted material is not the complete and official position of the National Fire Protection Association, on the referenced subject which is represented only by the standard in its entirety.

parallel to framing members. Grommets used as required in 300.4(B)(1) shall remain in place and be **listed** for the purpose of cable protection.

(See Figures 17 & 18)

334.30 Securing and Supporting. Nonmetallic-sheathed cable shall be supported and secured by staples, cable ties, straps, hangers, or similar fittings designed and installed so as not to damage the cable, at intervals not exceeding 1.4 m (4¹/₂ ft) and within 300 mm (12 in.) of every outlet box, junction box, cabinet, or fitting. Flat cables shall not be stapled on edge. Sections of cable protected from physical damage by raceway shall not be required to be secured within the raceway.

(See Figures 19 - 22)

(A) Horizontal Runs Through Holes and Notches.

In other than vertical runs, cables installed in accordance with 300.4 shall be considered to be supported and secured where such support does not exceed 1.4 m (4¹/₂ ft) intervals and the nonmetallic-sheathed cable is securely fastened in place by an approved means within 300 mm (12 in.) of each box, cabinet, conduit body, or other nonmetallic-sheathed cable termination.

FPN: See 314.17(C) for support where nonmetallic boxes are used.

Figure 17 - BM1/BM2

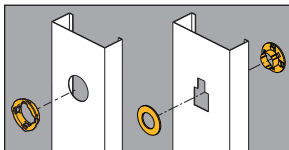

Figure 18 - BM3 & BM3M

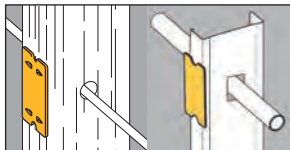

Figure 19 - BG-8-12-H7

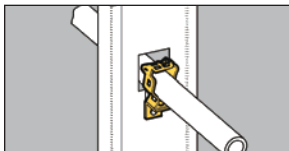

Figure 20 - BRC4 & BRC6M

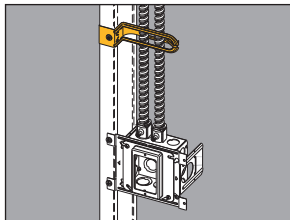

Figure 21 - BX5

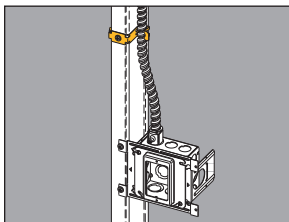
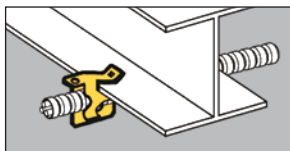

Figure 22 - BX4



Reprinted with permission from NFPA 70-2005, the *National Electrical Code*®, Copyright® 2005, National Fire Protection Association, Quincy, MA 02269.

This reprinted material is not the complete and official position of the National Fire Protection Association, on the referenced subject which is represented only by the standard in its entirety.

NEC Requirements

Article 344 Rigid Metal Conduit : Type RMC

344.30 Securing and Supporting.

(A) Securely Fastened. RMC shall be securely fastened within 900 mm (3 ft) of each outlet box, junction box, device box, cabinet, conduit body, or other conduit termination. Fastening shall be permitted to be increased to a distance of 1.5 m (5 ft) where structural members do not readily permit fastening within 900 mm (3 ft). Where approved, conduit shall not be required to be securely fastened within 900 mm (3 ft) of the service head for above-the-roof termination of a mast.

(See Figures 23 - 25)

(B) Supports. RMC shall be supported in accordance with one of the following:

- (1) Conduit shall be supported at intervals not exceeding 3 m (10 ft).
- (2) The distance between supports for straight runs of conduit shall be permitted in accordance with Table 344.30(B)(2),
- (3) Exposed vertical risers from industrial machinery or fixed equipment shall be permitted to be supported at intervals not exceeding 6 m (20 ft)
- (4) Horizontal runs of RMC supported by openings through framing members at intervals not exceeding 3 m (10 ft) and securely fastened within 900 mm (3 ft) of termination points shall be permitted. *(See Figure 26)*

Article 348 Flexible Metal Conduit: Type FMC

348.30 Securing and Supporting.

(A) Securely Fastened. FMC shall be securely fastened in place by an approved means within 300 mm (12 in.) of each box, cabinet, conduit body, or other conduit termination and shall be supported and secured at intervals not to exceed 1.4 m (4¹/₂ ft).

(See Figures 23 - 25)

(B) Supports. Horizontal runs of FMC supported by openings through framing members at intervals not greater than 1.4 m (4¹/₂ ft) and securely fastened within 300 mm (12 in) of termination points shall be permitted. *(See Figure 26)*

* *See NFPA 70-2005 for exceptions.*

Article 358 Electrical Metallic Tubing - Type EMT

358.30 Securing and Supporting.

(A) Securely Fastened. EMT shall be securely fastened in place at least every 3 m (10 ft). In addition, each EMT run between termination points shall be securely fastened within 900 mm (3 ft) of each outlet box, junction box,

Reprinted with permission from NFPA 70-2005, the *National Electrical Code*®, Copyright® 2005, National Fire Protection Association, Quincy, MA 02269.

This reprinted material is not the complete and official position of the National Fire Protection Association, on the referenced subject which is represented only by the standard in its entirety.

device box, cabinet, conduit body, or other tubing termination. (See Figures 23 - 25)

Exception No. 1: Fastening of unbroken lengths shall be permitted to be increased to a distance of 1.5 m (5 ft) where structural members do not readily permit fastening within 900 mm (3 ft).

Exception No. 2: For concealed work in finished buildings or prefinished wall panels where such securing is impracticable, unbroken lengths (with out coupling) of EMT shall be permitted to be fished.

- (B) Supports.** Horizontal runs of EMT supported by openings through framing members at intervals not greater than 3 m (10 ft) and securely fastened within 900 mm (3 ft) of termination points shall be permitted. (See Figure 26)

Article 362

Electrical Nonmetallic Tubing - Type ENT

362.30 Securing and Supporting.

- (A) Securely Fastened.** ENT shall be securely fastened at intervals not exceeding 900 mm (3 ft). In addition, ENT shall be securely fastened in place within 900 mm (3 ft) of each outlet box, device box, junction box, cabinet, or fitting where it terminates. (See Figures 23 - 25)

Exception No. 1: Lengths not exceeding a distance of 1.8 m (6 ft) from a luminaire (fixture) terminal connection for tap connection to lighting luminaires (fixtures) shall be permitted without being secured.

Exception No. 2: Lengths not exceeding 1.8 m (6 ft) from the last point where the raceway is securely fastened for connection within an accessible ceiling to luminaire(s) [lighting fixture(s)] or other equipment.

- (B) Supports.** Horizontal runs of ENT supported by openings in framing members at intervals not exceeding 900 mm (3 ft) of termination points shall be permitted. (See Figure 26)

Figure 23 - BG-8-12-S18-U-2-4

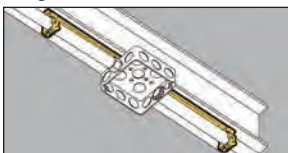

Figure 25 - BG-8-12-B1

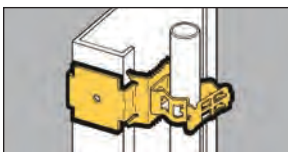

Figure 24 - BB38

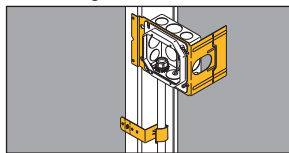
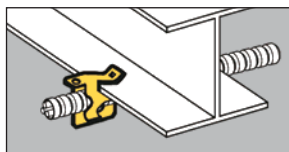

Figure 26 - BX4



Reprinted with permission from NFPA 70-2005, the *National Electrical Code*®, Copyright® 2005, National Fire Protection Association, Quincy, MA 02269.

This reprinted material is not the complete and official position of the National Fire Protection Association, on the referenced subject which is represented only by the standard in its entirety.

NEC Requirements

Article 410 Luminaries (Lighting Fixtures), Lampholders, and Lamps

410.16 Means of Support.

(A) Outlet Boxes. Outlet boxes or fittings installed as required by 314.23 and complying with the provisions of 314.27(A) and 314.27(B) shall be permitted to support luminaries (fixtures).

(C) Suspended Ceilings. Framing members of suspended ceiling systems used to support luminaries (fixtures) shall be securely fastened to each other and shall be securely attached to the building structure at appropriate intervals. Luminaries (fixtures) shall be securely fastened to the ceiling framing member by mechanical means such as bolts, screws, or rivets.

Listed clips identified for use with the type of ceiling framing member(s) and luminaire(s) [fixture(s)] shall also be permitted. *(See Figures 27 - 31)*

410.104 Fastening. Lighting track shall be securely mounted so that each fastening is suitable for supporting the maximum weight of luminaries (fixtures) that can be installed. Unless identified for supports at greater intervals, a single section 1.2 m (4 ft.) or shorter in length shall have two supports, and, where installed in a continuous row, each individual section of not more than 1.2 m (4 ft.) in length shall have one additional support. *(See Figure 30)*

422.18 Support of Ceiling-Suspended (Paddle) Fans

Ceiling-suspended (paddle) fans shall be supported independently of an outlet box or by **listed** outlet box or outlet box systems identified for the use and installed in accordance with 314.27(D). *(See Figure 32)*

Article 800 Communication Circuits

800.24 Mechanical Execution of Work.

Communications circuits and equipment shall be installed in a neat and workmanlike manner. Cables installed exposed on the surface of ceilings and sidewalls shall be supported by the building structure in such a manner that the cable will not be damaged by normal building use. Such cables shall be secured by straps, staples, hangers, or similar fittings designed and installed so as not to damage the cable. The installation shall also conform with 300.4(D) and 300.11.

FPN: Accepted industry practices are described in ANSI/NECA/BICSI 568-2001, Standard for Installing Commercial Building Telecommunications Cabling, and other ANSI-approved installation standards.

Reprinted with permission from NFPA 70-2005, the *National Electrical Code*®, Copyright® 2005, National Fire Protection Association, Quincy, MA 02269.

This reprinted material is not the complete and official position of the National Fire Protection Association, on the referenced subject which is represented only by the standard in its entirety.

Figure 27 - BA15

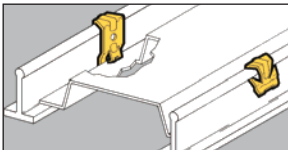

Figure 28 - BA1

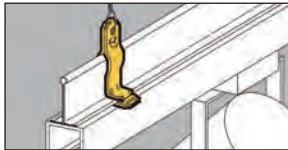

Figure 29 - BA40

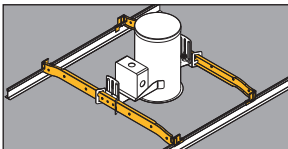

Figure 30 - BA 4-16 Series

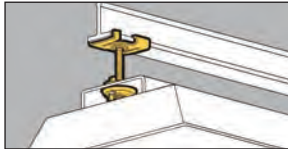

Figure 31 - BAX Series

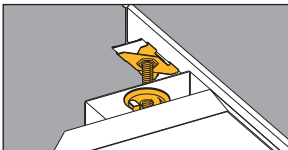
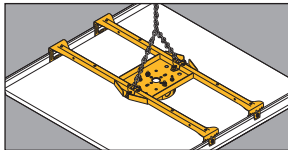

Figure 32 - BA50F



Reprinted with permission from NFPA 70-2005, the *National Electrical Code*®, Copyright® 2005, National Fire Protection Association, Quincy, MA 02269.

This reprinted material is not the complete and official position of the National Fire Protection Association, on the referenced subject which is represented only by the standard in its entirety.

ANSI/TIA/EIA-569-A

4. Horizontal pathways and related spaces

4.6 Ceiling pathway

4.6.2 Design guidelines

4.6.2.1 Planning. The design shall provide a suitable means for supporting cable from the telecommunications closet to the work areas to be served. Cable shall not be laid directly on the ceiling tile or rails.

4.6.2.2 Clearance. A minimum of 75 mm (3 in.) clear vertical space shall be available above the ceiling tiles for the horizontal cabling and pathway. (See Figure 33)

4.6.5 Cable support

4.6.5.1 Where zone conduit or cable tray is not available in a suspended ceiling space and where telecommunications cables are allowed to be placed in the ceiling, adequate open-top cable supports, located on 1220-1525 mm (48-60 inch) centers, shall be provided. Where larger quantities of cables (50-75 cables) bunched together in the ceiling at a congested area, such as close to the telecommunications closet, special supports shall be designed and installed to carry the additional weight. (See Figures 33 & 34)

4.6.5.2 A suspended ceiling support rod or wire may be used to mount appropriate cable fasteners loaded with multiple cables up to the total weight for which the fastener is approved. The T-bar rail of a suspended ceiling may be used to mount appropriate cable fasteners loaded with cable up to a total weight of 0.7 kg/m (0.45 lb/ft). The fastener design shall not interfere with the inserting or removing of the ceiling tile. (See Figures 33 & 34)

NOTES

- 1) A weight of 1.0 kg (2.2 lbs.) or 0.7 kg/m with spacing of support wire/rod at 1.5 m (5 ft.) is equivalent to a bundle of sixteen 4-pair 24 AWG UTP cables, including fasteners.
- 2) If any side pull is exerted on the support wire, like a turn in direction of the cables, the level of the ceiling tee rail could be affected.

Reprinted with permission from NFPA 70-2005, the *National Electrical Code*®, Copyright® 2005, National Fire Protection Association, Quincy, MA 02269.

This reprinted material is not the complete and official position of the National Fire Protection Association, on the referenced subject which is represented only by the standard in its entirety.

Figure 33 - BCHxx-A28

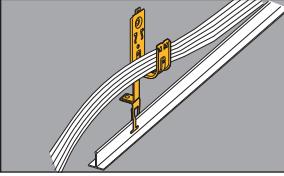
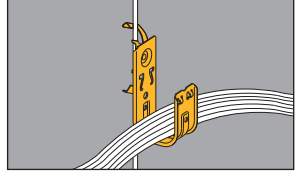

Figure 34 - BCHxx-W2



Reprinted with permission from NFPA 70-2005, the *National Electrical Code*®, Copyright® 2005, National Fire Protection Association, Quincy, MA 02269.

This reprinted material is not the complete and official position of the National Fire Protection Association, on the referenced subject which is represented only by the standard in its entirety.

Reference Data

Cable Hook Technical Data

Single-Sided Single-Tier Cable Fasteners

Hook Size	'A'	'B'	'C'	'D'	'E'	'F'	'G'	'H'
In.	In.	In.	In.	In.	In.	In.	In.	In.
3/4	.88	3.18	2.68	1.00	.75	1.69	.94	–
1 ⁵ / ₁₆	1.62	3.62	2.81	1.69	1.31	2.00	1.37	.20
2	1.62	4.31	3.50	2.38	2.00	2.69	2.06	.20
4	2.00	6.81	5.56	4.55	4.00	4.84	4.06	.31

BCH12

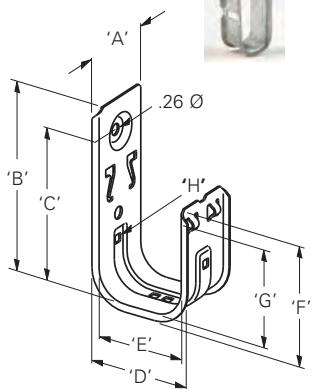

Load Capacity

Cable Hook Size	Static Load Capacity (S.F. 3)	
	Galvanized & Stainless Steel	Lbs.
In.		
3/4	30	
1 ⁵ / ₁₆	30	
2	30	
4	30	

Stated loads are per hook and should not be exceeded. The load capacity of a fastener having more than one component is equal to the load capacity of the lowest rated component.

Double-Sided Single-Tier Cable Fasteners

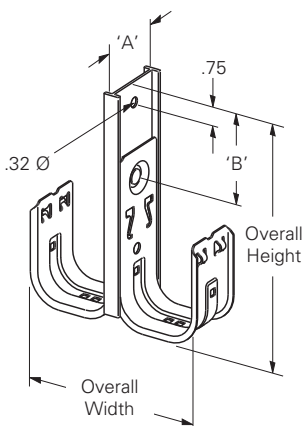

Hook Size	'A'	'B'	Overall Height	Overall Width
In.	In.	In.	In.	In.
1 ⁵ / ₁₆	1.90	2.50	5.50	3.47
2	1.90	2.50	6.19	4.85
4	2.38	2.94	9.00	9.19

Cable Hook Technical Data

Double-Sided Double-Tier Cable Fasteners

Hook Size In.	'A' In.	'B' In.	Spacing In.	Clearance In.	Overall Height In.	Overall Width In.
15/16	1.90	2.50	3.75	1.94	9.25	3.47
2	1.90	2.50	4.75	2.25	10.94	4.85
4	2.38	2.94	9.38	4.50	18.20	9.19

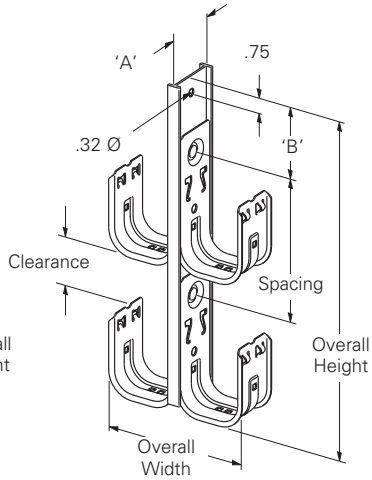
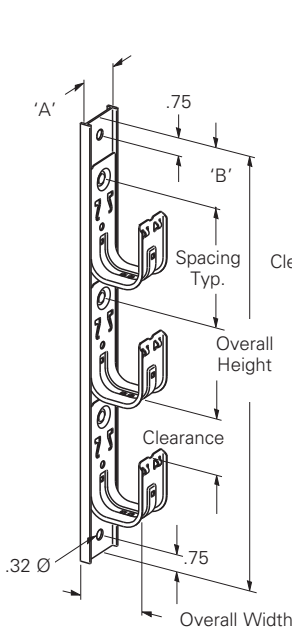

Single-Sided Multi-Tier Cable Fasteners (2 thru 6 Tier)

Hook Size In.	No. Tiers	'A' In.	'B' In.	Spacing In.	Clearance In.	Overall Height In.	Overall Width In.
15/16	2	1.90	2.50	3.75	1.94	11.00	1.96
	3	1.90	2.50	3.75	1.94	14.75	1.96
	4	1.90	2.50	3.75	1.94	18.50	1.96
	5	1.90	2.50	3.75	1.94	22.25	1.96
	6	1.90	2.50	3.75	1.94	26.00	1.96
2	2	1.90	2.50	4.75	2.25	12.75	2.66
	3	1.90	2.50	4.75	2.25	17.50	2.66
	4	1.90	2.50	4.75	2.25	22.25	2.66
	5	1.90	2.50	4.75	2.25	27.00	2.66
	6	1.90	2.50	4.75	2.25	31.75	2.66
4	2	2.38	2.94	8.75	3.19	19.33	4.82
	3	2.38	2.94	8.75	3.19	28.08	4.82

Reference Data

Rigid Steel Conduit (Heavy Wall Conduit)

Nominal Conduit Size	Outside Diameter	Nominal Inside Diameter	Minimum Weight Per 100 Ft. With Couplings Attached	Weight of Conduit and Conductors Per 100 Ft.*
In.	In.	In.	Lbs.	Lbs.
3/8	0.675	0.493	51.5	65.1
1/2	0.840	0.632	79.0	101.1
3/4	1.050	0.836	105.0	145.8
1	1.315	1.063	153.0	219.3
1 1/4	1.660	1.394	201.0	318.3
1 1/2	1.900	1.624	249.0	408.8
2	2.375	2.083	332.0	593.8
2 1/2	2.875	2.489	527.0	901.0
3	3.500	3.090	682.0	1259.0
3 1/2	4.000	3.570	831.0	1604.0
4	4.500	4.050	972.0	1967.0

Intermediate Metal Conduit (IMC)

Nominal Conduit Size	Outside Diameter	Nominal Inside Diameter	Minimum Weight Per 100 Ft. With Couplings Attached	Weight of Conduit and Conductors Per 100 Ft.*
In.	In.	In.	Lbs.	Lbs.
1/2	0.815	0.745	60.0	82.1
3/4	1.029	0.954	82.0	122.8
1	1.290	1.205	116.0	182.3
1 1/4	1.638	1.553	150.0	267.3
1 1/2	1.883	1.793	182.0	341.8
2	2.360	2.266	242.0	503.8
2 1/2	2.857	2.727	401.0	775.0
3	3.476	3.346	493.0	1069.0
3 1/2	3.971	3.841	573.0	1346.0
4	4.466	4.336	638.0	1632.0

Dimensions taken from ANSI C80.3 - 1977.

* Conduit plus weight of heaviest conductor combination as specified by the National Electrical Code.

Electrical Metallic Tubing (EMT) - Thinwall Conduit

Nominal Conduit Size	Outside Diameter	Nominal Inside Diameter	Minimum Weight Per 100 Ft. With Couplings Attached	Weight of Conduit and Conductors Per 100 Ft.*
In.	In.	In.	Lbs.	Lbs.
3/8	0.577	0.493	23.0	36.6
1/2	0.706	0.622	28.5	50.6
3/4	0.922	0.824	43.5	84.3
1	1.163	1.049	64.0	130.3
1 1/4	1.510	1.380	95.0	212.3
1 1/2	1.740	1.610	110.0	269.8
2	2.197	2.067	140.0	401.8
2 1/2	2.875	2.731	205.0	579.0
3	3.500	3.356	250.0	826.3
3 1/2	4.000	3.834	325.0	1098.0
4	4.500	4.334	370.0	1364.0

Rigid Aluminum Conduit

Nominal Conduit Size	Outside Diameter	Nominal Inside Diameter	Minimum Weight Per 100 Ft. With Couplings Attached	Weight of Conduit and Conductors Per 100 Ft.*
In.	In.	In.	Lbs.	Lbs.
1/2	0.840	0.632	27.4	49.5
3/4	1.050	0.836	36.4	77.2
1	1.315	1.063	53.0	119.3
1 1/4	1.660	1.394	69.6	186.9
1 1/2	1.900	1.624	82.2	242.0
2	2.375	2.083	115.7	377.5
2 1/2	2.875	2.489	182.5	556.5
3	3.500	3.090	238.9	815.2
3 1/2	4.000	3.570	287.7	1061.0
4	4.500	4.050	340.0	1334.0
5	5.563	5.073	465.4	2028.0
6	6.625	6.093	612.5	2870.0

Dimensions taken from ANSI C80.3 - 1977.

* Conduit plus weight of heaviest conductor combination as specified by the National Electrical Code.

Reference Data

Schedule 40 PVC Plastic Pipe

Nominal Pipe Size	Outside Diameter	Wall Thickness	Weight of Pipe	Weight of Water
In.	In.	In.	Lbs. Per Ft.	Lbs. Per Ft.
1/8	0.405	0.068	0.04	0.02
1/4	0.540	0.088	0.07	0.04
3/8	0.675	0.091	0.10	0.08
1/2	0.840	0.109	0.15	0.10
3/4	1.050	0.113	0.20	0.20
1	1.315	0.133	0.30	0.40
1 1/4	1.660	0.140	0.40	0.60
1 1/2	1.900	0.145	0.50	0.90
2	2.375	0.155	0.60	1.40
2 1/2	2.875	0.203	1.00	2.10
3	3.500	0.216	1.30	3.20
3 1/2	4.000	0.226	1.60	4.30
4	4.500	0.237	1.90	5.50

Electrical Non-Metallic Tubing (ENT)

Nominal Size	Outside Diameter	Nominal Inside Diameter	Minimum Weight of Conduit	Weight of Conduit and Conductors
In.	In.	In.	Lbs. Per 100 Ft.	Lbs. Per 100 Ft.
1/2	0.840	0.560	11.0	33.1
3/4	1.050	0.760	14.0	54.8
1	1.315	1.000	20.0	86.3
1 1/4	1.660	1.402	19.0	136.3
1 1/2	1.990	1.554	27.0	186.8
2	2.375	2.030	32.0	261.8

All Threaded Rod (ATR)

Thread Size	Root Area	Design Load (SF=5)
1/4"-20	0.027 in. ²	240 lbs.
5/16"-18	0.045 in. ²	400 lbs.
3/8"-16	0.068 in. ²	610 lbs.

Tabulated loads are based on an allowable tensile stress of 12000 psi reduced by 25% resulting in 9000 psi. From ANSI/MSS SP-58, Table 3.

Dimensions taken from ANSI B1.1 1982 Unified Inch Screw Threads. All threads are UNCR series.

MC -- Metal Clad Cable Specifications

Trade Size	Grounding Conductor AWG	Armor O.D. In.	Approximate Wt. Per 100 Ft. Lbs.
14-2 Solid	14	0.470	17.5
14-3 Solid	14	0.480	20.5
14-4 Solid	14	0.510	23.0
12-2 Solid	12	0.495	21.5
12-3 Solid	12	0.530	25.5
12-4 Solid	12	0.565	29.5
10-2 Solid	10	0.560	28.5
10-3 Solid	10	0.600	34.0
10-4 Solid	10	0.645	39.5
8-2 Stranded	10	0.710	45.0
8-3 Stranded	10	0.770	54.5
8-4 Stranded	10	0.835	64.5
6-2 Stranded	8	0.795	59.0
6-3 Stranded	8	0.865	72.0
6-4 Stranded	8	0.945	86.0
4-2 Stranded	8	0.945	78.5
4-3 Stranded	8	1.035	98.5
4-4 Stranded	8	1.135	119.5
3-3 Stranded	6	1.025	107.0
3-4 Stranded	6	1.120	126.0
2-2 Stranded	6	1.075	104.5
2-3 Stranded	6	1.180	134.0
2-4 Stranded	6	1.295	164.0

Category 5 Cable

Pair Count	AWG Size	O.D. In.	Weight Lbs. Per 100 Ft.
2	24	0.16	1.3
3	24	0.18	1.7
4	24	0.20	2.1
6	24	0.27	3.5
8	24	0.30	4.2
25	24	0.50	13.0

Reference Data

Type NM -- Non-Metallic Sheathed Cable

Size AWG	Number of Strands	Ground Wire Size	Approximate O.D. In.	Approximate Weight Lbs. Per 100 Ft.
<u>Without Ground Wire</u>				
14-2	Solid	–	.17 x .37	5.3
12-2	Solid	–	.19 x .40	7.0
10-2	Solid	–	.22 x .45	10.1
14-3	Solid	–	0.295	8.2
12-3	Solid	–	0.332	10.9
10-3	Solid	–	0.396	15.7
8-3	7	–	0.538	27.8
6-3	7	–	0.611	42.2
<u>With Ground Wire</u>				
14-2	Solid	14	.17 x .37	6.4
12-2	Solid	12	.19 x .41	9.0
10-2	Solid	10	.22 x .49	13.3
8-2	7	10	.28 x .61	21.5
6-2	7	10	.32 x .73	31.3
14-3	Solid	14	.322	9.3
12-3	Solid	12	.363	12.9
10-3	Solid	10	.436	18.7
14-4	Solid	14	.450	11.6
12-4	Solid	12	.490	16.1
10-4	Solid	10	.550	23.3
8-3	7	10	.552	30.5
6-3	7	10	.611	45.0
4-3	7	8	.821	66.4
2-3	7	8	.946	93.0

Type THHN -- Insulated Single Conductor Building Wire

Trade Size	Approximate O.D. In.	Approximate Weight Lbs. Per 100 Ft.
14 AWG	0.11	1.7
12 AWG	0.13	2.5
10 AWG	0.16	4.0
8 AWG	0.22	6.5
6 AWG	0.25	9.7
4 AWG	0.32	15.5
3 AWG	0.35	19.1
2 AWG	0.38	23.6
1 AWG	0.45	30.4
1/0 AWG	0.49	37.5

AC -- Armored Cable Specifications

Trade Size	Armor O.D. In.	Approximate Weight Lbs. Per 100 Ft.
14-2 Solid	0.433	18.0
14-3 Solid	0.453	20.0
14-4 Solid	0.486	25.0
12-2 Solid	0.467	21.0
12-3 Solid	0.489	24.5
12-4 Solid	0.520	29.0
10-2 Solid	0.476	25.0
10-3 Solid	0.500	29.5
10-4 Solid	0.541	38.0
8-2 Solid	0.570	34.5
8-3 Solid	0.601	41.5
8-4 Solid	0.654	48.0
8-2 Stranded	0.604	34.5
8-3 Stranded	0.637	42.0
8-4 Stranded	0.695	51.5
6-2 Stranded	0.700	44.5
6-3 Stranded	0.739	56.0
6-4 Stranded	0.807	68.5
4-2 Stranded	0.836	62.0
4-3 Stranded	0.885	80.0
4-4 Stranded	0.971	99.5
3-3 Stranded	0.990	94.0
3-4 Stranded	1.085	118.0
2-2 Stranded	0.956	81.5
2-3 Stranded	1.014	109.5
2-4 Stranded	1.115	138.0

Index

<u>Catalog No.</u>	<u>Page</u>	<u>Catalog No.</u>	<u>Page</u>
1314	196	B2RRE	38
1316	196	B2RRP4C	38
1372	196	B2RRP5C	38
1380	196	B2RRR	38
5860	192	B3RRE	38
5874	192	B3RRPC	38
6305	193	B3RRR	38
6307	193	B4RRE	38
6309	193	B4RRPC	38
6311	193	B4RRR	38
6313	193	B444- ¹ / ₄	110
6323	194	B444- ⁵ / ₁₆	110
6336	194	B444- ³ / ₈	110
6338	194	B601-62	185
6407SD	212	B1506S	52
7187	190, 192	B1508	52
7195	192	B1508S	52
7197	192	B1512	52
7198	192	B1512S	52
9221	211	B1516	52
9231	211	B1516S	52
9241	211	B1520	52
9323	195	B1520S	52
9343	195	B1524S	52
9353	195	B1532S	52
		B1534S	52
		B1540S	52
		B1548S	52
		B1556S	52
		B1564S	52
		B3223- ³ / ₈	143

A

ACB Series	196
ACPD Series	210
ACPW Series	209
ACS Series	197-198
ADA Series	203-204
ADI Series	193
ADE Series	207
ADH Series	195
ADM Series	194
ADN Series	213
AMS Series	211
APC Series	219
APD Series	218
APH Series	217
APS Series	216
ARC Series	191-192
ARS Series	189-190
ARW Series	192
ASA Series	205-206
ASE Series	208
ATB Series	214
ATM Series	212
AWA Series	199-200
AWS Series	215
AWSD Series	201-202
AZD Series	218

B

B1RRE	38
B1RRP4C	38
B1RRP5C	38
B1RRR	38

BA

BA1	87
BA1-9	87
BA1-24	87
BA1-32	87
BA1-95	87
BA1-T	87
BA1-T-BN	87
BA-2-9	91
BA-2-9-BN	91
BA-2-9-W	91
BA-2-9-WBN	91
BA-2-9-7	91
BA-2-9-7-BN	91
BA-2-16	90
BA-2-16-BN	90
BA-2-16-W	90
BA-2-16-WBN	90
BA-2-16-7	90
BA-2-16-7-BN	90
BA-2-16-7-W	90
BA-2-16-7-WBN	90
BA-4-9	91
BA-4-9-W	91
BA-4-16	89
BA-4-16-24	89
BA-4-16-32	89
BA-4-16-48	89

<u>Catalog No.</u>	<u>Page</u>	<u>Catalog No.</u>	<u>Page</u>
BA cont.			
BA-4-16-H	88	BB7-24	31
BA-4-16-H1	88	BB8-16	32
BA-4-16-W	89	BB8-24	32
BA-4-WN	89	BB9	21
BA-5-4T	77	BB10	151
BA-6-4T	78	BB10-2	151
BA12	81	BB10-3	151
BA12-12	81	BB10-4	151
BA12-20	81	BB10L	152
BA12-30	81	BB10P	152
BA14	76	BB12	21
BA15	76	BB12-6	21
BA17	86	BB15	37, 154
BA18	86	BB-18	36
BA20	86	BB20	151
BA-21	89	BB20L	152
BA-21D	89	BB27	81
BA28	80	BB32	24
BA28B	144, 179	BB33	24
BA40	85	BB33L	24
BA50	82	BB38	45
BA50A	83	BB38D	45
BA50CAN	82	BB40-08	37, 153
BA50C3T	82	BB40-10	37, 153
BA50C4T	82	BB40-12	37, 153
BA50D	82	BB45-08	37, 153
BA50DCAN	82	BB45-10	37, 153
BA50E	82	BB45-12	37, 153
BA50F	84	BB70	27
BA50-OB-24	83	BB70E	27
BA50-OB-34	83	BB73	26
BA50-SB-24	83	BB74	26
BA50-SB-34	83	BB76	26
BA311	92	BB216TCL	30
BA311-W2	92	BB216TS	29
BA311-W6	92	BB224TCL	30
BA-SFC	93	BB224TS	29
BA-SFC-CF	93	BBCC	33
BA-SFC-CFS	93	BBF15	35
BA-SFC-E	93	BBF15FC	35
BA-SFC-S	93	BBF18	35
BAX-4-16	88	BBF18FC	35
BAX-4-16-24	88	BBF24	35
BAX-4-16-32	88	BBF24FC	35
BAX-4-16-48	88	BBFC	35
		BBFS-18	33
BB			
BB1	20	BC	
BB2-16T	29	BC1	111
BB2-24T	29	BC442	100
BB2CL	30	BC442-6	100
BB2TS	29	BCH12	155-156
BB4-4	25	BCH12-A28	166
BB4-4D	25	BCH12-C1	162
BB4-6	25	BCH12-C2	162
BB4-6D	25	BCH12-C442	161
BB4-23	25	BCH12-C442A	161
BB4-23D	25	BCH12-E-2-4	159
BB7-16	31	BCH12-E-5-8	159

Index

<u>Catalog No.</u>	<u>Page</u>	<u>Catalog No.</u>	<u>Page</u>
BC cont.			
BCH12-E-9-12	159	BCH32-E-9-12	159
BCH12-F3	164	BCH32-F3	164
BCH12-F4	164	BCH32-F4	164
BCH12-G-8-12	167	BCH32-G-8-12	167
BCH12-L1410	167	BCH32-L1410	167
BCH12-PNA	139	BCH32-PNA	139
BCH12-RB	158	BCH32-RB	158
BCH12-SC4	163	BCH32-SC4	163
BCH12-U-2-4	160	BCH32-U-2-4	160
BCH12-U-5-8	160	BCH32-U-5-8	160
BCH12-U-9-12	160	BCH32-U-9-12	160
BCH12-W2	165	BCH32-W2	165
BCH12-W6	165	BCH32-W6	165
BCH21	155-156	BCH32X	157
BCH21-1D	168	BCH64	155-156
BCH21-2D	168	BCH64-1D	168
BCH21-2S	169	BCH64-2D	168
BCH21-3S	169	BCH64-2S	169
BCH21-4S	170	BCH64-3S	169
BCH21-5S	170	BCH64-4S	170
BCH21-6S	170	BCH64-AB	158
BCH21-A28	166	BCH64-C1	162
BCH21-AB	158	BCH64-C2	162
BCH21-C1	162	BCH64-C442	161
BCH21-C2	162	BCH64-C442A	161
BCH21-C442	161	BCH64-F3	164
BCH21-C442A	161	BCH64-F4	164
BCH21-E-2-4	159	BCH64-G-8-12	167
BCH21-E-5-8	159	BCH64-L1410	167
BCH21-E-9-12	159	BCH64-PNA	139
BCH21-F3	164	BCH64-RB	158
BCH21-F4	164	BCH64-SC4	163
BCH21-G-8-12	167	BCH64-U-2-4	160
BCH21-L1410	167	BCH64-U-5-8	160
BCH21-PNA	139	BCH64-U-9-12	150
BCH21-RB	158	BCH64X	157
BCH21-SC4	163	BCH-HBA	171
BCH21-U-2-4	160	BCH-HB21	171
BCH21-U-5-8	160	BCH-HB64	171
BCH21-U-9-12	160	BCHID-__12	156
BCH21-W2	165	BCHID-__21	156
BCH21-W6	165	BCHID-__32	156
BCH21X	157	BCHID-__64	156
BCH32	155-156	BCHK1	172
BCH32-1D	168	BCHK2	172
BCH32-2D	168	BCHK3	172
BCH32-2S	169	BCHR21	154
BCH32-3S	169	BCHR32	154
BCH32-4S	170	BCHR64	154
BCH32-5S	170	BCS-8	67
BCH32-6S	170	BCS-8C	67
BCH32-A28	166	BCS-12	67
BCH32-AB	158	BCS-12AS	67
BCH32-C1	162	BCS-12C	67
BCH32-C2	162	BCS-16	67
BCH32-C442	161	BCS-16AS	67
BCH32-C442A	161	BCS-16C	67
BCH32-E-2-4	159	BCS-18	67
BCH32-E-5-8	159	BCS-18C	67
		BCS-20	67
		BCS-20C	67

<u>Catalog No.</u>	<u>Page</u>	<u>Catalog No.</u>	<u>Page</u>
BD			
BD2	144, 179	BG6-S18-W2	70
BD4	144, 179	BG6-S18-W2-MC3	70
BD40	178	BG6-S18-W6	70
BE			
BE-1-2	96	BG6-S18-W6-MC3	70
BE-2-4	96	BG6-SC4	138
BE-2-4-CT2	150	BG-6-U-2-4	104
BE-5-8	96	BG-6-U-5-8	104
BE-5-8-CT2	150	BG-6-U-9-12	104
BE-9-12	96	BG-8-12	48
BE-9-12-CT2	150	BG-8-12-4T	48
BES-8	67	BG-8-12-A5	77
BES-8C	67	BG-8-12-A6	78
BES-12	67	BG-8-12-B1	20
BES-12C	67	BG-8-12-B5	23
BES-16	67	BG-8-12-C1	112
BES-16C	67	BG-8-12-C2	111
BF			
BF1	133	BG-8-12-C2	111
BF1-40	22	BG-8-12-D3	68
BF1-56	22	BG-8-12-D4	68
BF1-64	22	BG-8-12-E-2-4	98
BF1-96	22	BG-8-12-E-2-4-AS	106
BF1-CT2	150	BG-8-12-E-5-8	98
BF2	133	BG-8-12-E-5-8-AS	106
BF2-CT2	150	BG-8-12-E-9-12	98
BF3	129	BG-8-12-E-9-12-AS	106
BF4	125	BG-8-12-F1	135
BF12	123	BG-8-12-F2	135
BF13	123	BG-8-12-F13	123
BFA-1215	66	BG-8-12-G6	55
BFA-1520	66	BG-8-12-G20	55
BG			
BG-6	48	BG-8-12-G24	55
BG-6-4T	48	BG-8-12-G32	55
BG-6-A5	77	BG-8-12-G812	55
BG-6-A6	78	BG-8-12-H7	39
BG-6-B1	20	BG-8-12-PNA	140
BG-6-B5	23	BG812-S18	69
BG-6-E-2-4	98	BG812-S18-MC3	69
BG-6-E-5-8	98	BG812-S18S	69
BG-6-E-9-12	98	BG812-S18-S-MC3	69
BG-6-F1	135	BG812-S18-U24	116
BG-6-F2	135	BG812-S18-U24-MC3	116
BG-6-F13	123	BG812-S18-U58	116
BG-6-H7	39	BG812-S18-U58-MC3	116
BG-6-PNA	140	BG812-S18-W2	70
BG6-S18	69	BG812-S18-W2-MC3	70
BG6-S18-MC3	69	BG812-S18-W6	70
BG6-S18-S	69	BG812-S18-W6-MC3	70
BG6-S18-S-MC3	69	BG812-SC4	138
BG6-S18-U24	116	BG-8-12-U-2-4	104
BG6-S18-U24-MC3	116	BG-8-12-U-2-4-AS	106
BG6-S18-U58	116	BG-8-12-U-5-8	104
BG6-S18-U58-MC3	116	BG-8-12-U-5-8-AS	106
		BG-8-12-U-9-12	104
		BG-8-12-U-9-12-AS	106
		BG-8-12-W2	59
		BG-8-12-W6	59
		BG-16	48
		BG-16-4T	48
		BG-16-A5	77
		BG-16-A6	78
		BG-16-B1	20

Index

<u>Catalog No.</u>	<u>Page</u>	<u>Catalog No.</u>	<u>Page</u>
BG cont.		BG-24-U-5-8	104
BG-16-B5	23	BG-24-U-9-12	104
BG-16-C1	112	BG-32	48
BG-16-C2	111	BG-32-4T	48
BG-16-E-2-4	98	BG-32-C1	112
BG-16-E-2-4-AS	106	BG-32-C2	111
BG-16-E-5-8	98	BG-32-E-2-4	98
BG-16-E-5-8-AS	106	BG-32-E-5-8	98
BG-16-E-9-12	98	BG-32-E-9-12	98
BG-16-E-9-12-AS	106	BG-32-U-2-4	104
BG-16-F1	135	BG-32-U-5-8	104
BG-16-F2	135	BG-32-U-9-12	104
BG-16-F13	123		
BG-16-G-6	50	BH	
BG-16-G-8-12	50, 55	BH1	136
BG-16-G-16	50	BH1-E-2-4	121
BG-16-G-20	50	BH1-E-5-8	121
BG-16-G-24	50	BH1-E-9-12	121
BG-16-G-32	50	BH1-F1	133
BG-16-PNA	140	BH1-F2	133
BG-16-S18	69	BH1-F3	130
BG16-S18-MC3	69	BH1-F4	126
BG16-S18-S	69	BH1-F12	124
BG16-S18-S-MC3	69	BH1-H7	141
BG16-S18-U24	116	BH1-H8	142
BG16-S18-U24-MC3	116	BH1-PNA	139
BG16-S18-U58	116	BH-1-2-R	120
BG16-S18-U58-MC3	116	BH2	136
BG16-S18-W2	70	BH2-E-2-4	121
BG16-S18-W2-MC3	70	BH2-E-5-8	121
BG16-S18-W6	70	BH2-E-9-12	121
BG16-S18-W6-MC3	70	BH2-F1	134
BG-16-U-2-4	104	BH2-F2	134
BG-16-U-2-4-AS	106	BH2-F3	130
BG-16-U-5-8	104	BH2-F4	126
BG-16-U-5-8-AS	106	BH2-F12	124
BG-16-U-9-12	104	BH2-H7	141
BG-16-U-9-12-AS	106	BH2-H8	142
BG-16-W2	59	BH2-PNA	139
BG-16-W6	59	BH-2-4	120
BG-20	48	BH-2-4-R	120
BG-20-4T	48	BH4	136
BG-20-B5	23	BH4-E-2-4	122
BG-20-C1	112	BH4-E-2-4-AS	105
BG-20-C2	111	BH4-E-5-8	122
BG-20-E-2-4	98	BH4-E-5-8-AS	105
BG-20-E-5-8	98	BH4-E-9-12	122
BG-20-E-9-12	98	BH4-E-9-12-AS	105
BG-20-F13	123	BH4-F1	134
BG-20-U-2-4	104	BH4-F2	134
BG-20-U-5-8	104	BH4-F3	130
BG-20-U-9-12	104	BH4-F4	126
BG-24	48	BH4-F12	124
BG-24-4T	48	BH4-H7	141
BG-24-C1	112	BH4-H8	142
BG-24-C2	111	BH4-PNA	140
BG-24-E-2-4	98	BH4-SC4	137
BG-24-E-5-8	98	BH5	136
BG-24-E-9-12	98	BH5-E-2-4	122
BG-24-U-2-4	104	BH5-E-5-8	122

<u>Catalog No.</u>	<u>Page</u>	<u>Catalog No.</u>	<u>Page</u>
BH cont.			
BH5-E-9-12	122	BKP10094	182
BH5-F1	134	BKP20125	182
BH5-F2	134	BKP20188	182
BH5-F3	130	BKT Series	184
BH5-F4	126	BKW063	182
BH5-F12	124	BKW094	182
BH5-H7	141	BKW125	182
BH5-H8	142	BKW188	182
BH5-PNA	140	BKYH Series	184
BH-5-8	120	BKYT Series	184
BH-5-8-R	120		
BH6	136	BL	
BH6-E-2-4	122	BL1	147
BH6-E-2-4-AS	105	BL2	147
BH6-E-5-8	122	BL3-8	148
BH6-E-5-8-AS	105	BL3-12	148
BH6-E-9-12	122	BL3-16	148
BH6-E-9-12-AS	105	BL3-20	148
BH6-F1	134	BL-24-2	146
BH6-F2	134	BL-24-4	146
BH6-F3	130	BL-24-4C	146
BH6-F4	126	BL-32-4	146
BH6-F12	124	BL1400	53, 54
BH6-H7	141	BL1400-C442	109
BH6-H8	142	BL1400-PNA	140
BH6-PNA	140	BL1400-SC4	140
BH6-SC4	137	BL1410	53, 54
BH7	136	BL1410-C442	109
BH7-6	136	BL1410-L1400	56
BH8	136	BL1410-L1410	56
BH8-6	136	BL1410-L1420	56
BH9	180	BL1410-L1425	56
BH9-10	180	BL1410-L1430	56
BH-9-12	120	BL1410-L1440	56
BH-9-12-R	120	BL1410-L1450	56
BH10	180	BL1410-L1460	56
BH11	143	BL1410-L1470	56
BH12	143	BL1410-L1480	56
BH15	180	BL1410-PNA	140
BH16	180	BL1410-SC4	138
BHE-1-2	120	BL1420	53, 54
BH-F12	120	BL1420-C442	109
BH-F12-R	120	BL1420-PNA	140
BH-H7	120	BL1420-SC4	138
BH-PNA	139	BL1425	53, 54
		BL1425-C442	109
BK			
BKA Series	184	BL1430	53, 54
BKB Series	184	BL1430-C442	109
BKC100	181	BL1440	53, 54
BKC200	181	BL1440-C442	109
BKCC	185	BL1450	53, 54
BKCP	185	BL1450-C442	109
BKF100-4	183	BL1460	53, 54
BKF100-6	183	BL1470	53, 54
BKH Series	184	BL1480	53, 54
BKL Series	184	BL1490	53, 54
BKP10063	182		

Index

<u>Catalog No.</u>	<u>Page</u>	<u>Catalog No.</u>	<u>Page</u>
BM			
BM1	46	BP-12-A6	78
BM1M	46	BP-12-B1	20
BM2	46	BP-12-B5	23
BM3	44	BP-12-C1	112
BM3M	44	BP-12-C2	112
BM5	179	BP-12-D3	68
BMB1	36	BP-12-D4	68
BN		BP-12-E-2-4	97
BN1	178	BP-12-E-5-8	97
BN-2	178	BP-12-E-9-12	97
BN-4	178	BP-12-F13	123
BN-6	178	BP-12-H7	39
BP		BP-12-P-12	50
BP-8	49	BP-12-P-16	50
BP-8-4T	49	BP-12-PNA	140
BP-8-A28	80	BP12-S18	71
BP-8-A5	77	BP12-S18-MC3	71
BP-8-A6	78	BP12-S18S	71
BP-8-B1	20	BP12-S18-S-MC3	71
BP-8-B5	23	BP12-S18-U24	117
BP-8-C1	112	BP12-S18-U24-MC3	117
BP-8-C2	112	BP12-S18-U58	117
BP-8-D3	68	BP12-S18-U58-MC3	117
BP-8-D4	68	BP12-S18-W2	72
BP-8-E-2-4	97	BP12-S18-W2-MC3	72
BP-8-E-5-8	97	BP12-S18-W6	72
BP-8-E-9-12	97	BP12-S18-W6-MC3	72
BP-8-F13	123	BP12-SC4	138
BP-8-H7	39	BP-12-U-2-4	103
BP-8-P-8	50	BP-12-U-5-8	103
BP-8-P-12	50	BP-12-U-9-12	103
BP-8-P-16	50	BP-12-W2	60
BP-8-PNA	140	BP-12-W6	60
BP8-S18	71	BP-16	49
BP8-S18-MC3	71	BP-16-4T	49
BP8-S18S	71	BP-16-A28	80
BP8-S18-S-MC3	71	BP-16-A5	77
BP8-S18-U24	117	BP-16-A6	78
BP8-S18-U24-MC3	117	BP-16-B1	20
BP8-S18-U58	117	BP-16-B5	23
BP8-S18-U58-MC3	117	BP-16-C1	112
BP8-S18-W2	72	BP-16-C2	112
BP8-S18-W2-MC3	72	BP-16-D4	68
BP8-S18-W6	72	BP-16-E-2-4	97
BP8-S18-W6-MC3	72	BP-16-E-5-8	97
BP8-SC4	138	BP-16-E-9-12	97
BP-8-U-2-4	103	BP-16-F13	123
BP-8-U-5-8	103	BP-16-P-16	50
BP-8-U-9-12	103	BP-16-PNA	140
BP-8-W2	60	BP-16-S18	71
BP-8-W6	60	BP16-S18-MC3	71
BP-12	49	BP16-S18S	71
BP-12-4T	49	BP16-S18-S-MC3	71
BP-12-A28	80	BP16-S18-U24	117
BP-12-A5	77	BP16-S18-U24-MC3	117
		BP16-S18-U58	117
		BP16-S18-U58-MC3	117
		BP16-S18-W2	72
		BP16-S18-W2-MC3	72
		BP16-S18-W6	72
		BP16-S18-W6-MC3	72

<u>Catalog No.</u>	<u>Page</u>	<u>Catalog No.</u>	<u>Page</u>
BP cont.			
BP-16-U-2-4	103	BRC51-S18-W2	74
BP-16-U-5-8	103	BRC51-S18-W6	74
BP-16-U-9-12	103	BRC51-SC4	138
BP-16-W2	60	BRC5-1-U24	102
BP-16-W6	60	BRC5-1-U58	102
BPC-8	51	BRC5-1-U912	102
BPC-12	51	BRC5-1-W2	64
BPC-16	51	BRC5-1-W6	64
BPC-20	51	BRC5-2	63
BPC-24	51	BRC5-2-C2	114
BPC-32	51	BRC5-2-C442	108
BPC-40	51	BRC5-2-E12	100
BPC-48	51	BRC5-2-E24	100
BPC-56	51	BRC5-2-E58	100
BPC-64	51	BRC5-2-E912	100
BPNA	139	BRC5-2-F3	132
BR			
BR-8-T	173	BRC5-2-F4	128
BR-12-T	173	BRC52-SC4	138
BR-16-3W	173	BRC5-2-U24	102
BR-20-4T	173	BRC5-2-U58	102
BR-20-T	173	BRC5-2-U912	102
BR-24-4W	173	BRC5-2-W2	64
BR-32-4T	173	BRC5-2-W6	64
BR-32-4T-A6	176	BRC5-3	63
BR-32-4T-C1	176	BRC5-3-C2	114
BR-32-4T-U-2-4	175	BRC5-3-C442	108
BR-32-4T-U-5-8	175	BRC5-3-E12	100
BR-32-4T-U-9-12	175	BRC5-3-E24	100
BR-32-4T-W2	175	BRC5-3-E58	100
BR-32-4W	173	BRC5-3-E912	100
BR-32-T	173	BRC5-3-F3	132
BR-64-4T	173	BRC5-3-F4	128
BRC1	43	BRC6M	41
BRC2	43	BRC53-S18	73
BRC3	62	BRC53-S18-S	73
BRC3-E-2-4	115	BRC53-S18-U24	118
BRC3-E-5-8	115	BRC53-S18-U58	118
BRC3-E-9-12	115	BRC53-S18-W2	74
BRC3-F1	135	BRC53-S18-W6	74
BRC3-F2	135	BRC53-SC4	138
BRC3-W2	62	BRC5-3-U24	102
BRC3-W6	62	BRC5-3-U58	102
BRC4	42	BRC5-3-U912	102
BRC5-1	63	BRC5-3-W2	64
BRC5-1-C2	114	BRC5-3-W6	64
BRC5-1-C442	108	BRS-32	174
BRC5-1-E12	100	BRS-32A	174
BRC5-1-E24	100	BRS-64A	174
BRC5-1-E58	100	BS	
BRC5-1-E912	100	BSC4	137
BRC5-1-F3	132		
BRC5-1-F4	128		
BRC51-S18	73		
BRC51-S18-S	73		
BRC51-S18-U24	118		
BRC51-S18-U58	118		

Index

<u>Catalog No.</u>	<u>Page</u>	<u>Catalog No.</u>	<u>Page</u>
BU		BX4M-F13	124
BU-2-4	101	BX4M-H7	39
BU-2-4-S	101	BX4M-PNA	140
BU-2-4-S-AS	105	BX4M-SC4	138
BU-5-8	101	BX4M-U-2-4	107
BU-5-8-S	101	BX4M-U-5-8	107
BU-5-8-S-AS	105	BX4M-U-9-12	107
BU-9-12	101	BX4M-W2	61
BU-9-12-S	101	BX4M-W6	61
BU-9-12-S-AS	105	BX5	45
BW		BX6	65
BW2	57	BX-8	61
BW2-CT2	150	BX-8B	61
BW2S	57	BX9	65
BW4	57	BX-18	61
BW6	57	BX24	65
BW6-CT2	150	BX82	42
BW6S	57	BXL-67	66
BW-8	58	BXL-89	66
BW-12	58	BXL-1011	66
BW-16	58	BXL-1214	66
BW-20	58	BXL-1519	66
BWHS-9	30, 186	BXL-2024	66
BWHS-9D	30, 186	BXL-2530	66
BX		BXM-67	66
BX2	65	BXM-89	66
BX4	40	BXM-1011	66
BX4-A5	79	BXM-1214	66
BX4-A6	79	BXM-1519	66
BX4-C1	113	BXM-2024	66
BX4-C2	113	BXM-2530	66
BX4-E-2-4	99	BXS-67	66
BX4-E-5-8	99	BXS-89	66
BX4-E-9-12	99	BXS-1011	66
BX4-F3	131	BXS-1214	66
BX4-F4	127	BXS-1519	66
BX4-F13	124	BXS-2024	66
BX4-H7	39	BXS-2530	66
BX4-PNA	140	M	
BX4-U-2-4	107	MSQN 1/4	186
BX4-U-5-8	107	S	
BX4-U-9-12	107	SHHMS 1/4 x 1/2	186
BX4-W2	61	SRHMS 1/4 x 3/8	81
BX4-W6	61		
BX4M	40		
BX4M-A5	79		
BX4M-A6	79		
BX4M-A28	80		
BX4M-C1	113		
BX4M-C2	113		
BX4MD	40		
BX4M-E-2-4	99		
BX4M-E-5-8	99		
BX4M-E-9-12	99		
BX4M-F3	131		
BX4M-F4	127		

U.S. Customer Service Center is staffed Monday through Friday from 7 a.m. to 5:00 p.m. Central Standard Time. For more information, visit www.cooperbline.com/fasteners.

**Eaton's B-Line Business
United States**
509 West Monroe Street
Highland, IL 62249
United States
Phone: (800) 851-7415
www.cooperbline.com/contactus

**Eaton's B-Line Business
United Kingdom**
Walrow Industrial Estate
Somerset, TA9 4AQ
United Kingdom
Phone: (44) 1278 772600
www.cooperbline.com/contactuk

**Eaton's B-Line Business
Canada**
5925 McLaughlin Road
Mississauga, ON L5R 1B8
Canada
Phone: (800) 569-3660
www.cooperbline.com/contactca

**Eaton's B-Line Business
Middle East**
PO Box 70160 - Al Khobar - 31952
Kingdom of Saudi Arabia
Phone: 00966 3 812 2236
www.cooperbline.com/contactme

Eaton
1000 Eaton Boulevard
Cleveland, OH 44122
United States
Eaton.com

Eaton's B-Line Business
509 West Monroe Street
Highland, IL 62249
Phone: 800-851-7415
Fax: 618-654-1917
www.bline.com

© 2014 Eaton
All Rights Reserved
Printed in USA
Publication No. PH-13
July 2014 50M



Powering Business Worldwide

Eaton is a registered trademark
All other trademarks are property
of their respective owners

Fasteners

BLF-14

Spring steel fasteners

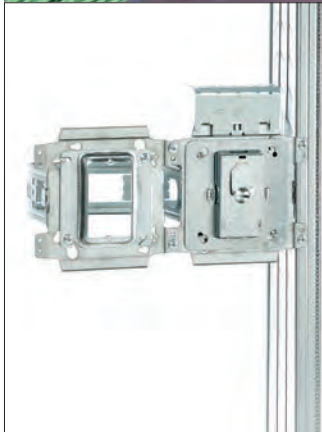

B-Line
by **EATON**



Energizing a world that demands more.

Discover today's Eaton.

Powering business worldwide

As a global power management company, we help customers worldwide manage the power needed for buildings, aircraft, trucks, cars, machinery and businesses.

Eaton's innovative technologies help customers manage electrical, hydraulic and mechanical power more reliably, efficiently, safely and sustainably.



EATON

Powering Business Worldwide



We deliver:

- **Electrical solutions** that use less energy, improve power reliability and make the places we live and work safer and more comfortable
- **Hydraulic and electrical solutions** that enable machines to deliver more productivity without wasting power
- **Aerospace solutions** that make aircraft lighter, safer and less costly to operate, and help airports operate more efficiently
- **Vehicle drivetrain and powertrain solutions** that deliver more power to cars, trucks and buses, while reducing fuel consumption and emissions

We provide integrated solutions that help make energy, in all its forms, more practical and accessible.

With 2013 sales of \$22 billion, Eaton has approximately 100,000 employees around the world and sells products in more than 175 countries.



Eaton's electrical business

Eaton is a global leader with expertise in:

- Power distribution and circuit protection
- Backup power protection
- Solutions for harsh and hazardous environments
- Lighting and security
- Structural solutions and wiring devices
- Control and automation
- Engineering services

Eaton is positioned through its global solutions to answer today's most critical electrical power management challenges. With 100 years of electrical experience behind us, we're energized by the challenge of powering up a world that demands twice as much energy as today. We're anticipating needs, engineering products and creating solutions to energize our markets today and in the future.

We are dedicated to ensuring that reliable, efficient and safe power is available when it's needed most.

Eaton.com

Introduction

The support you rely on.

Improving efficiency during installation with maximum return on investment.

An application is only as strong as its support systems. It's not only important to have reliable power, but determining how that power is distributed – whether in commercial, industrial or data center applications – is critical for efficiency. B-Line continues to be the brand for systems that effectively protect, connect and enclose engineered facility subsystems, keeping your processes running and costs down. From cable tray systems and strut systems to spring steel fastener solutions, the B-Line business is focused on innovative solutions.















Within this Spring Steel Fastener catalog, you will find several innovative, time-saving solutions that help drive your bottom line. Below are just a few of our most recent innovative additions.

- J-Hook color ID system that help verify cables are running in their correct, designated pathways. For more information, visit www.cooperbline.com/color-id.
- BB8 Series box mounting bracket with integrated cable containment for lower installed costs. For more information, visit www.cooperbline.com/BB816.
- Ruff-IN™ pre-fab systems that can save up to 75% during installation. For more information, visit www.cooperbline.com/ruff-in.
- Rapid Ring™ self-adjusting pre-fab ring that installs in as little as 15 seconds. For more information, visit www.cooperbline.com/rapidring.
- KwikWire™ hanging system and accessories that help save time during installation. For more information, visit www.cooperbline.com/kwikwire.
- To view more, visit www.cooperbline.com/laborsavings.

Eaton's B-Line Business
United States
509 West Monroe Street
Highland, IL 62249
United States
Phone: (800) 851-7415
www.cooperbline.com/contactus

Eaton's B-Line Business
Canada
5925 McLaughlin Road
Mississauga, ON L5R 1B8
Canada
Phone: (800) 569-3660
www.cooperbline.com/contactca

Table Of Contents

Ruff-IN™ Pre-Fab	3-8	
Pictorial Index	9-15	
Numbering Guide	16	
Technical Data	17-18	
Wall Studs	19-46	
Conduit & Cable	47-74	
Acoustical Tee	75-94	
Beams	95-118	
Hangers	119-144	
Lathers Channel	145-148	
Communication & Low Voltage	149-176	
Accessories	177-186	
Anchors	187-220	
NEC Requirements	221-236	
TIA/EIA Requirements	237-238	
Reference Data	239-246	
Alphanumeric Index	247-255	

Website: www.bline.com

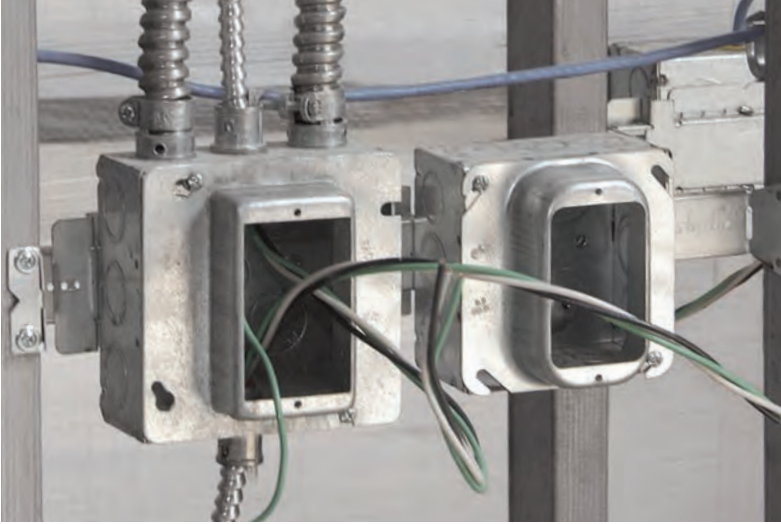

**B-Line's Ruff-IN product offering continues to expand with product and assembly options.
For the latest additions, visit www.cooperblineline.com/ruff-in.**



Complete Pre-Fab Offering

Choose the pre-fab offering below that best fits your needs:

Basic Ruff-IN

Offering Contents: Bracket, Box, Mud Ring, Ground Wire

- Ideal solution for a contractor sampling pre-fab for the first time that wants to keep the control of his or her project.
- Published lead times of 3-5 days ARO, and NEXT DAY SHIPPING ON (16) QUICK-SHIP ASSEMBLIES. (See pages 5 & 6)

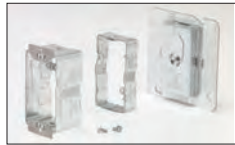

Ruff-IN with Wiring Devices and/or MC Cable Whips

Offering Contents: Basic Ruff-IN with Wiring Device, Protective Cover Plates, and MC Cable whip with connector(s)

- Assemblies are pre-wired for quick plug and-play installation using Wago™[†] or wire nut connectors.
- Wiring Device's ArrowLink™ connector offers additional labor savings with its plug in feature. (See page 4 for more details)
- Pre-wired Ruff-IN assemblies with devices and a pre-cut MC cable whip attached.
- Whip lengths available in 5-foot increments.
- Includes option to order MC cable whips only.



Total Ruff-IN™

Perfect for a contractor that desires take-off services and B-Line engineering support

- Perfect for a contractor interested in trying pre-fab for the first time that needs the engineering and assembly expertise of B-Line.
- Industry leading, published lead times for Total Ruff-IN quotation responses and order assembly.



[†] Wago™ is a trademark used by WAGO® Kontakttechnik GmbH & Co. KG

Ruff-IN™ Pre-Fab

Distributor Quick Ship Program

Next Day Shipping Available on

12 Ruff-In Assemblies & 4 Rapid Ring™ Assemblies

- No need to request a lead time, order today and we'll ship out of stock tomorrow!
- Ask your B-Line Sales Representative for more information on stock-able Ruff-IN assemblies.

Ruff-IN Quick Ship Pre-Fab Assemblies

Part #	UPC #	Max. Order Qty.
BBF Series Floor-mount		
BBF18-1104DA	78205154072	50
18" BBF floor-mount, 1-gang 5/8" plaster ring, TP403 box, stranded ground wire		
BBF18-1104D	78205154065	50
18" BBF floor-mount, 1-gang 5/8" plaster ring, TP403 box, solid ground wire		
BBF18-1124DA	78205155199	25
18" BBF floor-mount, 1-gang 3/4" plaster ring, TP403 box, stranded ground wire		
BBF18-1124D	78205154176	25
18" BBF floor-mount, 1-gang 3/4" plaster ring, TP403 box, solid ground wire		
Double-Sided Box Support		
BB76-1104DA	78205155200	100
6" Double-sided box support 1-gang 5/8" plaster ring, TP403 box, stranded ground wire		
BB76-1104D	78205138768	25
6" Double-sided box support 1-gang 5/8" plaster ring, TP403 box, solid ground wire		
BB76-1124DA	78205154049	50
6" Double-sided box support 1-gang 3/4" plaster ring, TP403 box, stranded ground wire		
BB76-1124D	78205138771	25
6" Double-sided box support 1-gang 3/4" plaster ring, TP403 box, solid ground wire		
Telescoping Slider Bracket		
BB216TS-1104DA	78205139289	25
16" Telescoping Slider Brkt, 1-gang 5/8" plaster ring, TP403 box, stranded ground wire		
BB216TS-1104D	78205138619	25
16" Telescoping Slider Brkt, 1-gang 5/8" plaster ring, TP403 box, solid ground wire		
BB216TS-1124DA	78205139292	25
16" Telescoping Slider Brkt, 1-gang 3/4" plaster ring, TP403 box, stranded ground wire		
BB216TS-1124D	78205138621	25
16" Telescoping Slider Brkt, 1-gang 3/4" plaster ring, TP403 box, solid ground wire		



BBF18-1104DA



BB216TS-1104D



BB76-1104D

Rapid Ring™ Quick Ship Pre-Fab Assemblies

Part #	UPC #	Max. Order Qty.
BB216TS-1RR4DA 16" Telescoping Slider Brkt, 1-gang Rapid Ring, TP403 box, stranded ground wire	78205176294	50
BB216TS-1RR4D 16" Telescoping Slider Brkt, 1-gang Rapid Ring, TP403 box, solid ground wire	78205176295	50
BB216TS-2RR4DA 16" Telescoping Slider Brkt, 2-gang Rapid Ring, TP403 box, stranded ground wire	78205176296	50
BB216TS-2RR4D 16" Telescoping Slider Brkt, 2-gang Rapid Ring, TP403 box, solid ground wire	78205176297	50



**Telescoping
Slider Bracket
with Rapid Ring**

Ruff-IN™ Pre-Fab

Ruff-IN™ Pre-Fab



B-Line's Ruff-IN Configurator program helps simplify the planning process for pre-fab construction. The program will walk you through a component selection process, build customized pre-fab assemblies, and create a project BOM to accelerate the quotation process.

Configurator Features

- Build an assembly to your own specification by choosing from brackets, boxes, plaster rings, wiring devices, and other accessories.
- Check the assembly for accuracy by reviewing a 3D, rotatable image that is created in real time.
- Configure multiple assemblies and save them as a project.
- Divide the project into rooms and specify the types and quantities of assemblies that go in each location.
- Print a customized project submittal package with the push of a button.
- Submit the entire project with your specific job and assembly information to B-Line for a quote with one click.

All of these features translate into fewer mistakes and less time spent during the take-off process. Let the B-Line Ruff-IN Configurator go to work for you. Build your next project using B-Line's Ruff-IN pre-fabricated wiring assemblies today!

For more information, visit www.cooperbline.com/ruff-in.

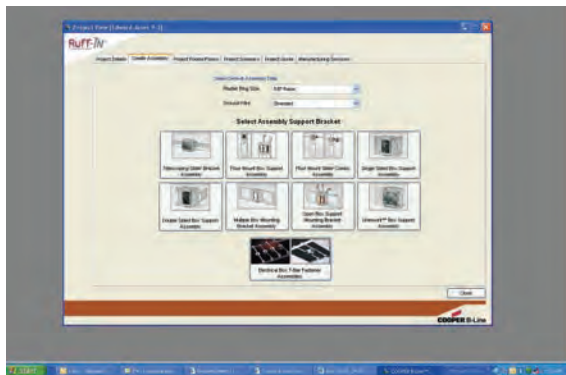
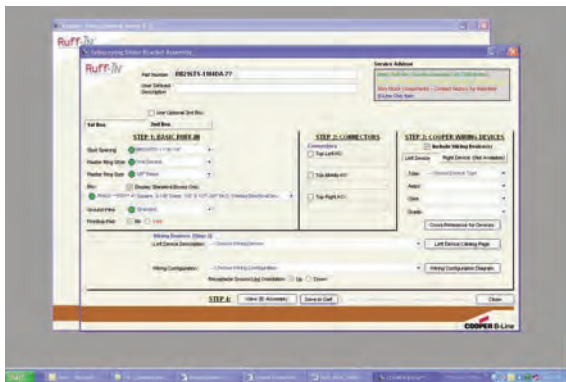

See Ruff-IN Pre-Fab Systems brochure for product information and part numbers.

Pictorial Index

Wall Studs

Pictorial Index

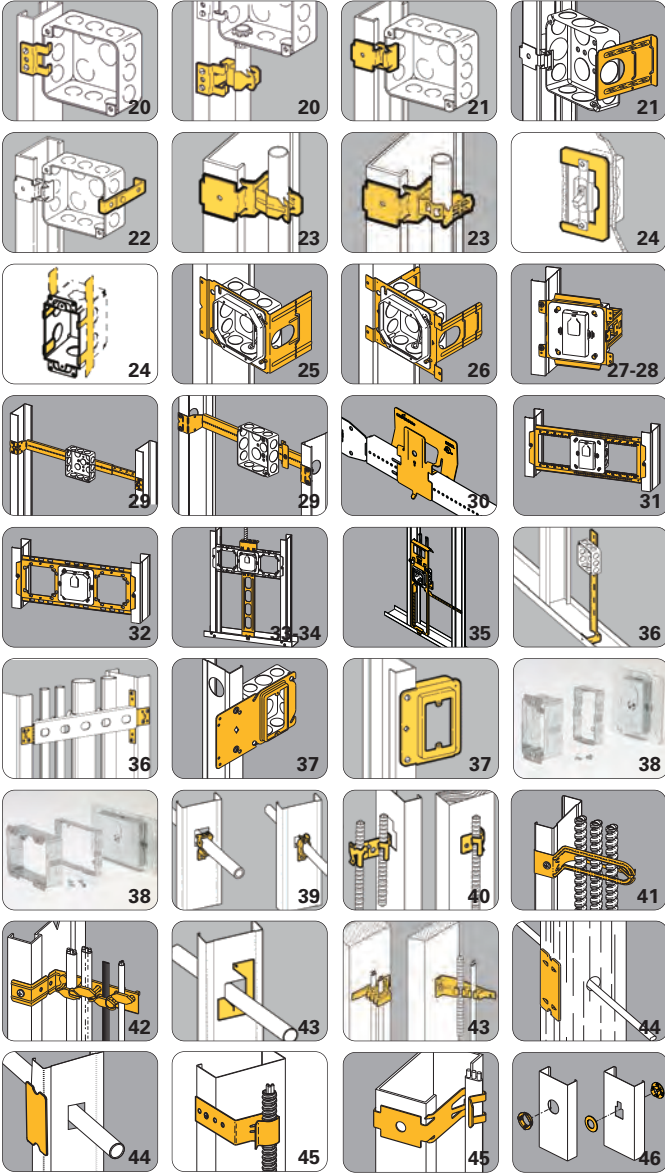

Conduit & Cable

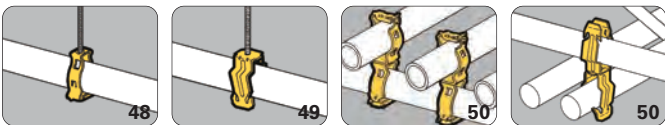

Pictorial Index

Conduit & Cable

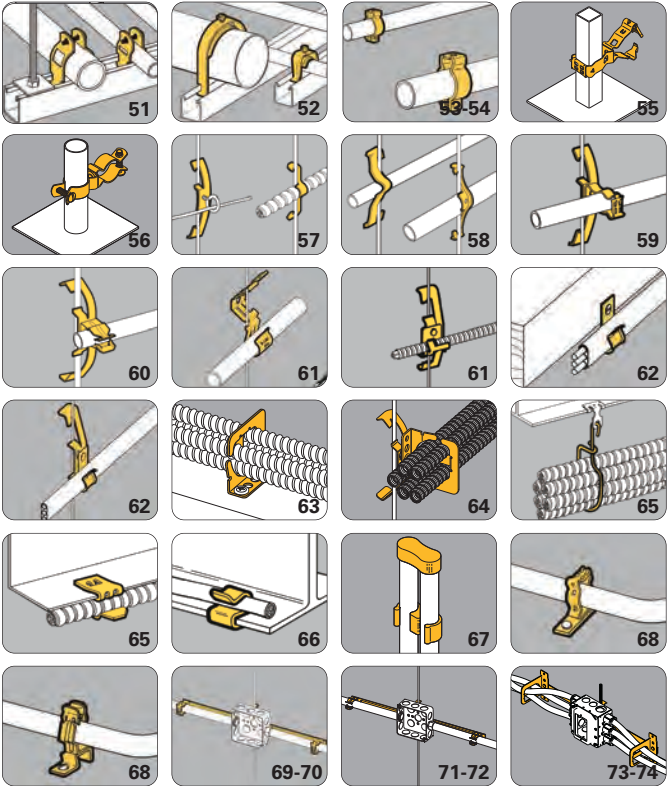

Pictorial Index

Acoustical Tee

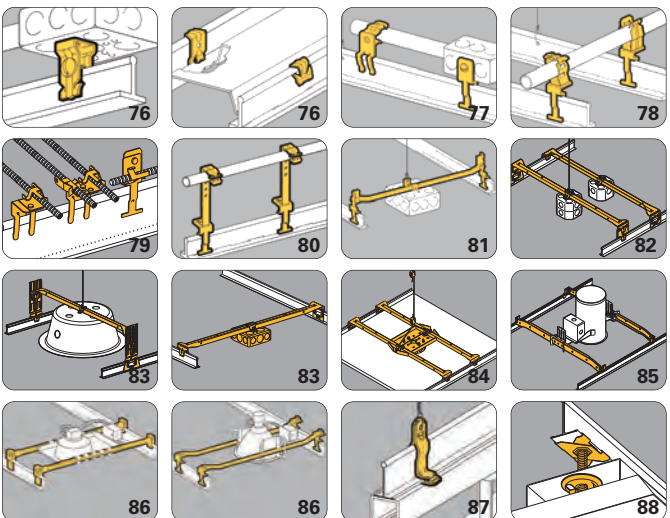

Pictorial Index

Acoustical Tee

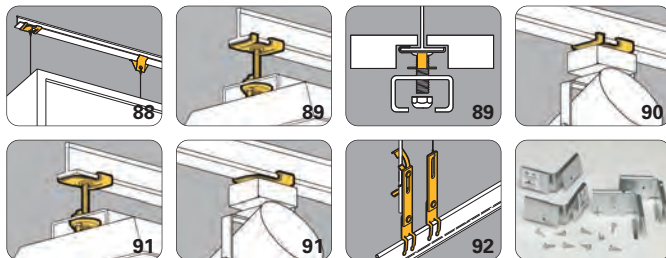

Beams

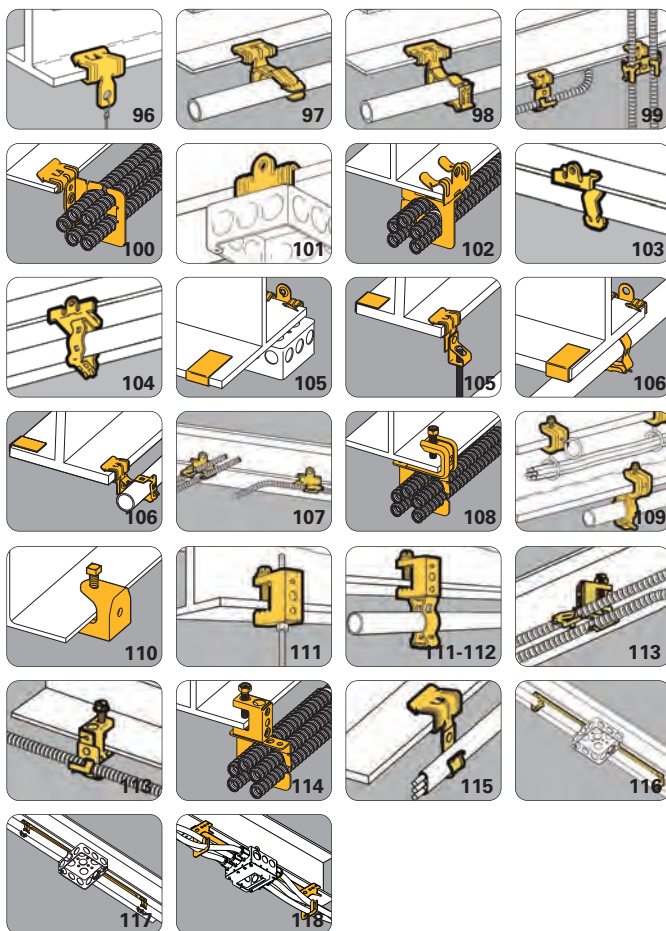

Pictorial Index

Hangers

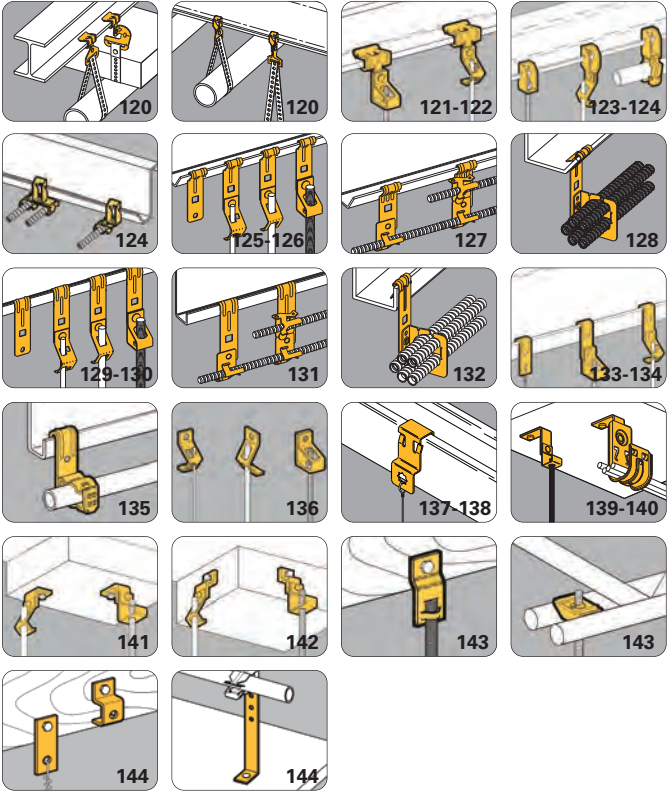

Pictorial Index

Lathers Channel



Pictorial Index

Communication & Low Voltage

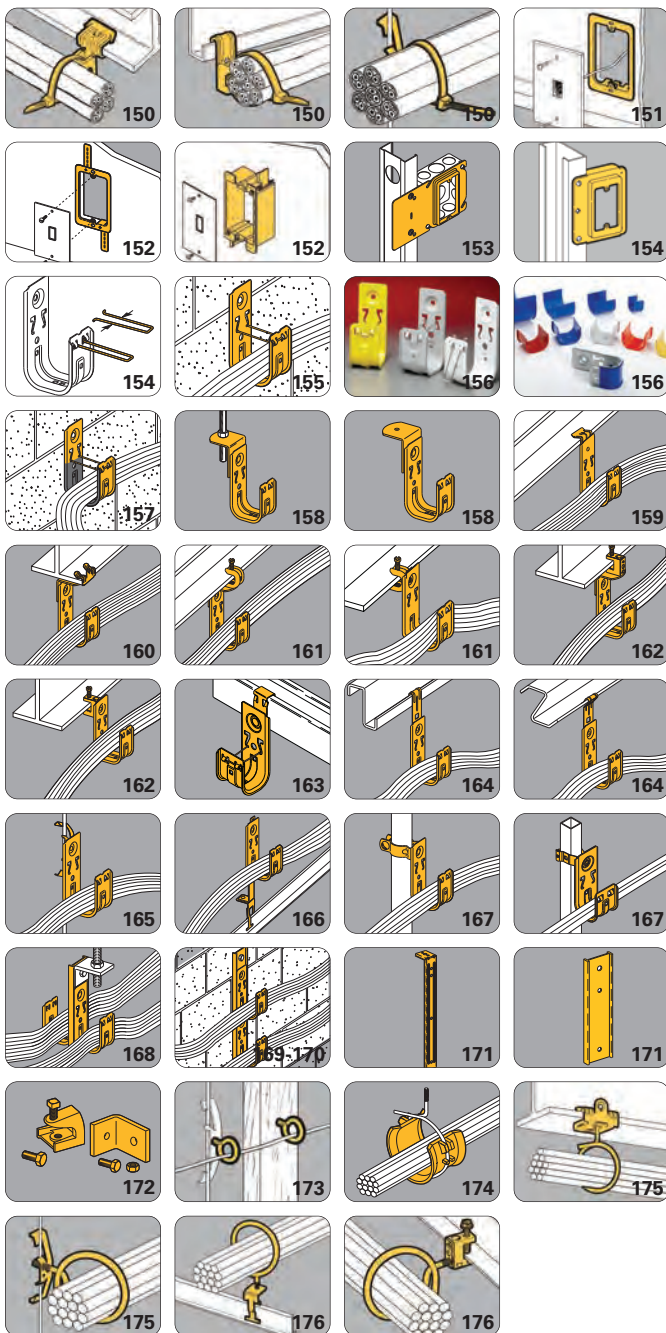

Accessories

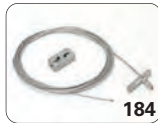
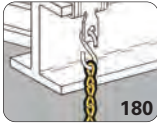
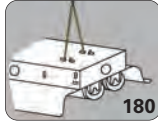
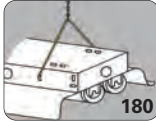
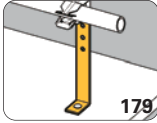
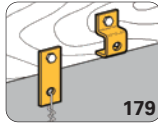
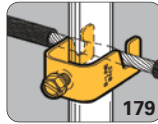
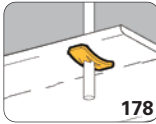

Pictorial Index

Pictorial Index

Anchors



189-190



191-192



191-192



193



194



195



196



197-198



199-200



201-202



203-204



205-206



207



208

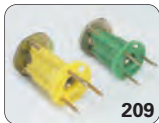

209



210



211



212



213



214

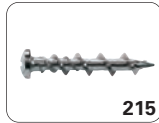

215



216



217



218



219

Part Numbering Guide

This part numbering guide can be used to quickly translate our part numbers into meaningful data.

BG - 8-12 - 4T		
Family	Size	Suffix
A Series - Anchors	Based on 16th	AS - Anchor Strap
* B Series - Pipe Strap	of an inch	BL - Equipment Blue
BA - Acoustical Tee Component	1 - 1/16"	BN - Brass Nut
BB - Box Attachment	2 - 1/8"	BR - Brown
BC - Beam Clamp	4 - 1/4"	BW - Bright White
* BCH - Cable Hook	5 - 5/16"	CW - Computer White
* BCS/BES - Conduit Spacer	6 - 3/8"	D - Deep Box
BD - Deck Attachment	8 - 1/2"	FB - Flat Black
* BE - Edge Attachment	9 - 9/16"	GR - Green
BF - Flange Attachment	12 - 3/4"	H - Hanger
* BG - Guide-Rite™ Fastener	16 - 1"	LH - Less Hardware
BH - Hanger Attachment	20 - 1 1/4"	LN - Less Nut
BK - KwikWire	24 - 1 1/2"	LS - Less Stud
BL - Conduit Hangers (mini's)	32 - 2"	OR - Orange
BM - Miscellaneous	64 - 4"	R - Right Angle
BN - Push Nuts		RR - Regal Red
* BP - Push Type Fasteners		S - Stud
* BPC - Break Apart Straps		T - Threaded
* BR - Bridle Rings		TG - Telco Gray
BRC - Cable Fastener		W - White
* BRS - Bridle Ring Saddle		WBN - White /Brass Nut
BT - Installation Tools		WN - Wing Nut
* BU - Universal Beam Attachment		YL - Safety Yellow
BW - Bat Wing Fastener		4T - 1/4" Thread Imp.
BX - FMC Support		

* The data in the size column only applies to these product families.

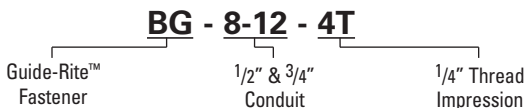

Materials

Steel	Specification
High Carbon Cold Rolled	ASTM A684, AISI 1055
Electrolytic Zinc Coated	ASTM A591
Pre-Galvanized	ASTM A653

Steel

B-Line spring steel fasteners are manufactured from spheroidized annealed high carbon cold rolled steel (ASTM A684, AISI 1055). Mild steel fasteners are manufactured from electrolytic zinc coated steel (ASTM A591) or pre-galvanized steel (ASTM A563).

Electrolytic zinc coated and pre-galvanized steel is produced by coating coils of sheet steel with zinc at the mills. These coils are then slit to size and fabricated into B-Line products.

Heat Treatment

B-Line spring steel fasteners are heat treated to make the steel hard and give the parts their spring quality and strength. The hardness for a given fastener depends on the required load carrying capacity and the application.

Load Data

The design load ratings for B-Line fasteners are specified in this catalog as static load capacity or ultimate static load capacity. By definition, the listed static load capacity has a safety factor of three (3.0), the listed ultimate static load capacity has no safety factor. In either case, these stated loads are not to be exceeded, and loads should be applied only as depicted in the catalog and/or instruction sheets. The load capacity of a fastener having more than one component is equal to the load capacity of the lowest rated component.

Fasteners having no load ratings are designed for proper placement of boxes, conduit, etc., and not for supporting loads.

B-Line fasteners are designed for use with support members (e.g.: angle iron, bar joists, beams, columns, flanges, purlins, wire, rod) that comply with the applicable AISI standards and threaded rod that complies with the applicable AISI standards.

Quality Assurance

B-Line has an established Q.C. program in which raw material and finished products are sampled, inspected and tested by certified inspectors to assure that all applicable standards are met. B-Line's fasteners are manufactured in controlled lots and each part is identified by a lot number stamped into the part. This number allows B-Line to track each step of the manufacturing process including raw material, die set-up, heat treating, and finishing. Samples are tested to verify correct hardness, corrosion resistance and load carrying capacity.

Part Numbering Guide

Finish	Specification
Zinc-Phosphate	MIL-P-16232 Type Z
Electro-galvanized Zinc	ASTM B633
Pre-Galvanized Zinc	ASTM A653, G90
Gloss White Paint	Acrylic Enamel

Zinc Phosphate

B-Line spring steel fasteners receive a coating* of sealant impregnated zinc phosphate. This type of coating was commercially developed by industry to inhibit oxidation of ferrous metals for up to 72 hours in a specified salt fog atmosphere. As applied to its fasteners, B-Line rates this coating for 30 hours when salt fog tested per ASTM B-117.

Although rust resistant, B-Line fasteners should be used only indoors and in non-corrosive environments.

Unless otherwise noted, the standard finish for B-Line's spring steel fasteners is Zinc Phosphate.

*At least 1000 milligrams of zinc phosphate per square foot.

Paint

Some standard fasteners have a gloss white acrylic enamel applied over the zinc phosphate finish for an enhanced appearance that compliments white ceiling grids.

Electro-galvanized Zinc

Electro-galvanized zinc (also known as zinc plated or electroplated) is the process by which a coating of zinc is deposited on the steel by electrolysis from a bath of zinc salts.

The coating is pure zinc and is mechanically bonded to the steel. A maximum of .5 mils of zinc can be applied by this method.

When exposed to air and moisture, zinc forms a tough, adherent, protective film consisting of a mixture of zinc oxides, hydroxides, and carbonates. This film is in itself a barrier coating which slows subsequent corrosive attack of the zinc.

This coating is usually recommended for indoor use in relatively dry areas.

Pre-Galvanized Zinc

Pre-galvanized steel is produced by coating coils of sheet steel with zinc by continuously rolling the material through molten zinc at the mills. This is also known as mill galvanized or hot-dip mill galvanized. These coils are then slit to size and fabricated into B-Line products.

The G90 specification calls for a coating of .90 ounces of zinc per square foot on each side of the sheet.

During fabrication, cut edges and welded areas are not normally zinc coated; however, the zinc near the uncoated metal becomes a sacrificial anode to protect the bare areas after a short period of time.

Pre-galvanized steel is recommended for indoor use in dry areas.

CAUTION: Do not use B-Line Fasteners outdoors or in corrosive environments. Proper application of each fastener is shown in this catalog and on the installation sheet inside each carton. Failure due to improper installation may cause harm to personnel and/or property. Allowable loads shown apply to the fastener only and do not account for the structure, which supports the fastener. Flanges, wires and rods used with these fasteners must meet A.I.S.I. standards. To improve personal safety on the jobsite, always observe all federal and local safety regulations: wear gloves, safety glasses and a hard hat.

Wall Studs

Wall Studs

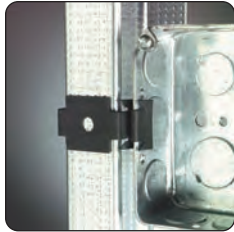

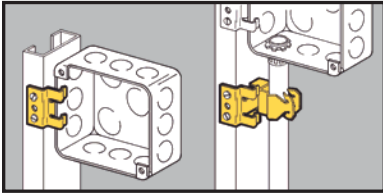

- Attaches with screws to metal studs.
- BB1 supports electrical box.
- BG series features Guide-Rite design.
- BP series features push-type design.

Box To Stud Fastener



UPC/Part Number	Catalog Number	Description	Box Qty.
78101118145	BB1	Electrical Box Support Clip	100

Guide-Rite™ Conduit To Stud Fastener



UPC/Part Number	Catalog Number	Conduit Size EMT & Rigid	Box Qty.
78101118420	BG-6-B1 *	3/8"	100
781011 18475	BG-8-12-B1	1/2", 3/4"	100
781011 18555	BG-16-B1	1"	100

Patent #4958792

- * BG-6 will accept the following range \varnothing .420 - \varnothing .675:
14/2 thru 10/4 MC/AC cable and 5/16 or 3/8 flexible conduit

Push Type Conduit To Stud Fastener



UPC/Part Number	Catalog Number	Conduit Size	Box Qty.
781011 19245	BP-8-B1	1/2" EMT	100
781011 19345	BP-12-B1	3/4" EMT, 1/2" IMC, Rigid	100
781011 19440	BP-16-B1	1" EMT, 3/4" IMC, Rigid	100

Read safety/installation instruction sheets in packages before use.
These products are designed for positioning only. No load rating.

Wall Studs

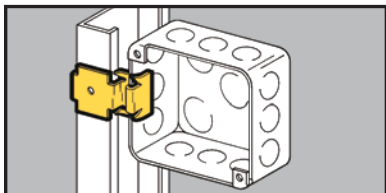

- Attaches electrical boxes (requiring plaster rings) to most metal studs.
- Box mounts flush to back of drywall.
- Simply installed with a hammer.

Box To Stud Fastener



Wall Studs

UPC/Part Number	Catalog Number	Description	Box Qty.
78101118270	BB9	Electrical Box Support	100

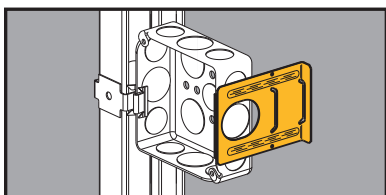

- Provides far-side support for electrical boxes in 2¹/₂" thru 6" studs.
- Cut outs facilitate bending to provide precise installation with greater stability.
- Easily snaps onto box side and is secured in place by plaster ring.

Adjustable Box Stabilizers



BB12



BB12-6



UPC/Part Number	Catalog Number	Metal Stud Size	Box Qty.
78101192876	BB12	2 ¹ / ₂ " thru 4"	100
78101192879	BB12-6	6"	100

Read safety/installation instruction sheets in packages before use. These products are designed for positioning only. No load rating.

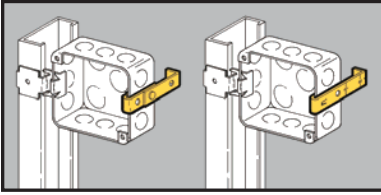

- Provides far-side support for electrical boxes.
- See BB12 Series for a better solution.

Box Stabilizer



BF1-96



BF1-64



BF1-56



BF1-40



UPC/Part Number	Catalog Number	Metal Stud Size	Box Qty.
78101118320	BF1-40	2 ¹ / ₂ "	100
78101118325	BF1-56	3 ¹ / ₂ "	100
78101118330	BF1-64	4"	100
78101118335	BF1-96	6"	100

*Read safety/installation instruction sheets in packages before use.
These products are designed for positioning only. No load rating.*

Wall Studs

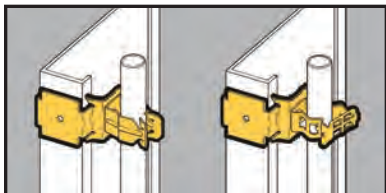

- Attaches conduit to most metal studs.
- BG Series features Guide-Rite design.
- BP Series feature push-type design.

Guide-Rite™ Conduit To Stud Fastener



UPC/Part Number	Catalog Number	Conduit Size EMT & Rigid	Box Qty.
78101118425	BG-6-B5 *	3/8" or BX	100
78101118480	BG-8-12-B5	1/2", 3/4"	100
78101118560	BG-16-B5	1"	100
78101118645	BG-20-B5	1 1/4"	50

Patent #4958792

* BG-6 will accept the following range Ø.420 - Ø.675:
14/2 thru 10/4 MC/AC cable and 5/16 or 3/8 flexible conduit

Push Type Conduit To Stud Fastener



UPC/Part Number	Catalog Number	Conduit Size	Box Qty.
78101119250	BP-8-B5	1/2" EMT	100
78101119350	BP-12-B5	3/4" EMT, 1/2" IMC, Rigid	100
78101119445	BP-16-B5	1" EMT, 3/4" IMC, Rigid	100

Read safety/installation instruction sheets in packages before use.
These products are designed for positioning only. No load rating.

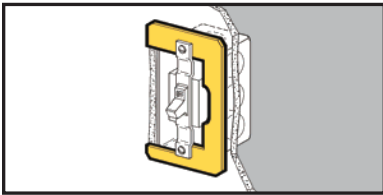

Retainer Leveler

- BB32 adds rigidity to devices in oversize wall openings.
- Holds wiring device firmly in drywall.
- Can be used with switches, receptacles, GFCIs and decorator devices.
- Ideal for positioning devices in pre-fab installations.
- Finish: Pre-Galvanized



UPC/Part Number	Catalog Number	Description	Box Qty.
78101118215	BB32	Adds Rigidity to Oversize Wall Openings	100

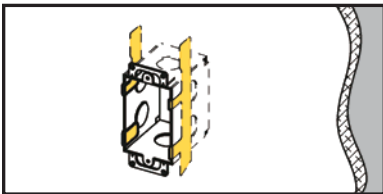

Box Support

- Attaches electrical boxes to finished drywall.
- Box is completely supported by drywall.
- Prevents box from pulling out of wall.
- Finish: Pre-Galvanized

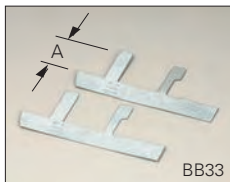

BB33

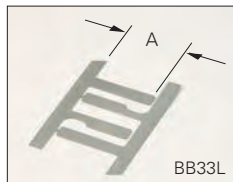

BB33L

UPC/Part Number	Catalog Number	Description	Length A	Box Qty.
78101101138	BB33	Box Support	1 ¹ / ₂ "	100 pr.
78101104936	BB33L	Long Leg Box Support	2 ¹ / ₂ "	100

Read safety/installation instruction sheets in packages before use.
These products are designed for positioning only. No load rating.

Wall Studs

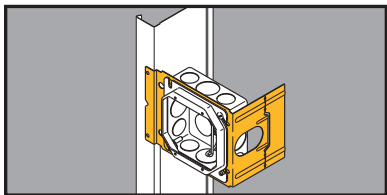

Box Support Brackets



- Improved far-side support stands up during drywall installation and outperforms competitor brackets.
- Supports 4" or 4¹¹/₁₆", square boxes.
- Brackets may be piggy-backed in series.
- Finish: Pre Galvanized.
- See Ruff-IN™ brochure for pre-fab box assemblies.

Wall Studs



BB4-23

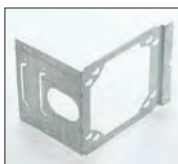

BB4-4



BB4-6

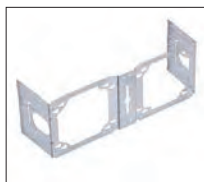

BB4-23D

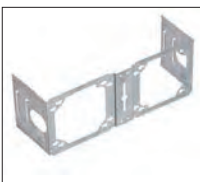

BB4-4D

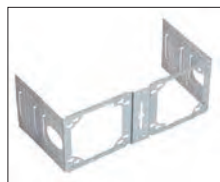

BB4-6D

UPC/Part Number	Catalog Number	Metal Stud Size	Box Qty.
78101118190	BB4-23	3 ⁵ / ₈ ", 2 ¹ / ₂ "	100
78101118200	BB4-4	4", 3 ⁵ / ₈ ", 2 ¹ / ₂ "	100
78101118202	BB4-6	6", 5 ¹ / ₂ ", 3 ⁵ / ₈ ", 2 ¹ / ₂ "	100
79903848375	BB4-23D	3 ⁵ / ₈ ", 2 ¹ / ₂ "	50
79903848376	BB4-4D	4", 3 ⁵ / ₈ ", 2 ¹ / ₂ "	50
79903848377	BB4-6D	6", 5 ¹ / ₂ ", 3 ⁵ / ₈ ", 2 ¹ / ₂ "	50

Read safety/installation instruction sheets in packages before use.
These products are designed for positioning only. No load rating.

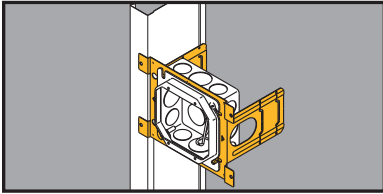

Double-Sided Box Support Bracket w/ Marty-Mouse™ Ears

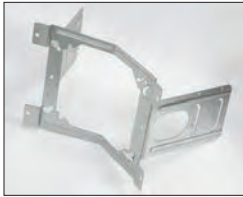

1. Bracket is shipped with ear tabs in the open position



2. Insert box screws into open slots

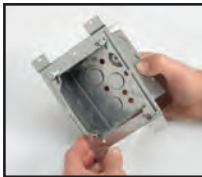

3. When plaster ring is installed, the ear tabs are bent down into the closed position



4. With the tabs closed, the box remains secured to the bracket when the plaster ring is removed

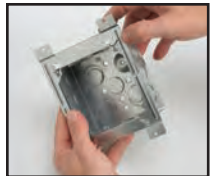

- Double-side box support, designed for Pre-Fab. Unit can be installed on either side of stud without repositioning box or devices.
- Patented Marty Mouse™ ears feature an innovative keyhole pattern to secure outlet box to bracket with or without the plaster ring.
- Wider box opening accommodates one or two gang adjustable plaster rings (B1AJ & B2AJ).
- Enhanced far-side support stands up during drywall installation and out out performs competitor brackets.
- See Ruff-IN™ brochure for pre-fab box assemblies.
- Finish: Pre-Galvanized

UPC/Part Number	Catalog Number	Stud Size	Box Qty.
78205138645	BB73	3 ⁵ / ₈ ", 2 ¹ / ₂ "	50
78205138717	BB74	4", 3 ⁵ / ₈ ", 2 ¹ / ₂ "	50
78205138759	BB76	6", 5 ¹ / ₂ ", 3 ⁵ / ₈ ", 2 ¹ / ₂ "	25

Patent # 5595362

Read safety/installation instruction sheets in packages before use.
These products are designed for positioning only. No load rating.

Wall Studs

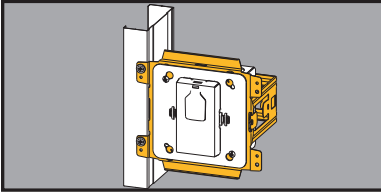

- Interlocking wrap-around design provides extra rigidity.
- Supports most standard 1-gang and 2-gang US and Canadian boxes and/or plaster rings 4" SQ., 4^{11/16}" SQ., and 5" SQ. on either side of the stud.

Box Support Brackets

Available August 2014

- Adjustable for varying stud depths (2^{1/2}" to 6").
- Compatible with 1-gang and 2-gang Rapid Ring™ and adjustable plaster rings.
- Integral mounting tabs for attaching plaster rings.
- Multiple brackets may be ganged together.
- Available factory assembled as part of the Ruff-IN™ pre-fab line with box, mud ring, and pre-wired devices.
- Finish: Pre Galvanized.
- Patent Pending



Wall Studs

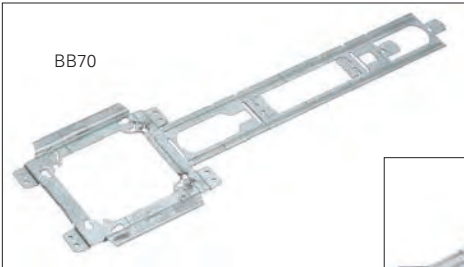

BB70

BB70E*
(Sold separately, must be used with BB70)



See following page for various product information.

UPC/Part Number	Catalog Number	Metal Stud Size	Box Qty.
79903856399	BB70	2 ^{1/2} " - 4"	50
79903856400	BB70E*	5 ^{1/2} " - 6"	50

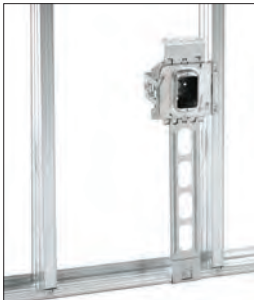

Can be used with BBCC (containment clip) and BBFS-18 (floor stand) See pages 33 & 34.

Read safety/installation instruction sheets in packages before use. These products are designed for positioning only. No load rating.

Bent For Various Depths

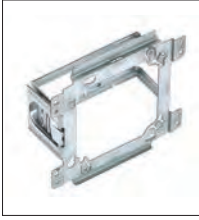

2 1/2"

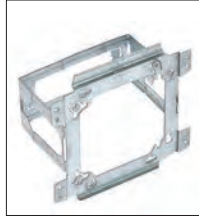

3 5/8"

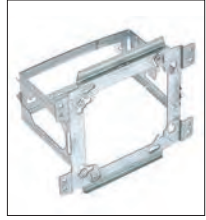

4"

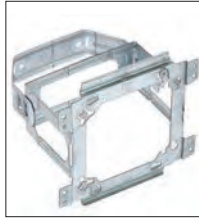

6"

For 5 1/2" depth, snap the BB70E into the next notch on the bracket side

Bending Bracket For 3 5/8" Depth

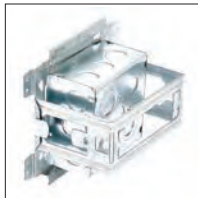
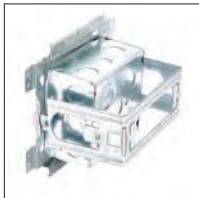
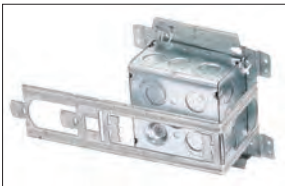
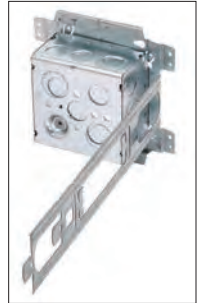
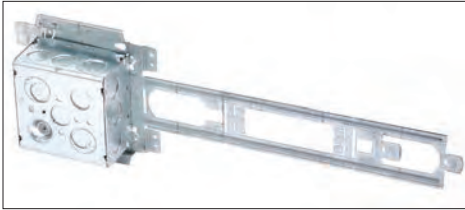

*Read safety/installation instruction sheets in packages before use.
These products are designed for positioning only. No load rating.*

Wall Studs

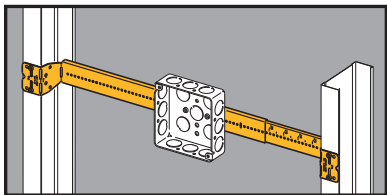

- Completely adjustable - fits a range of stud spacings and 1 1/2" or 2 1/8" deep boxes.
- Pre-punched screw holes provide for easy box installation.
- Bar is marked with scale for stud spacing.
- Finish: Pre-galvanized

Telescoping Box Mounting Bracket

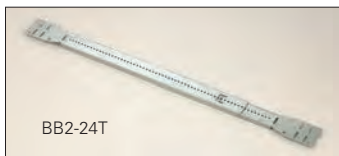

BB2-24T

UPC/Part Number	Catalog Number	Metal Stud Spacing	Box Qty.
78101104256	BB2-16T	11" to 18"	50
78101101664	BB2-24T	15" to 26"	50

Licensed under Patent #5386959 • Patent #5209444

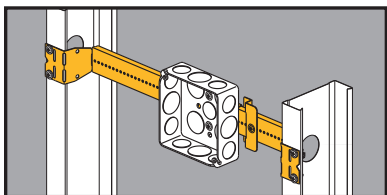

- Designed for pre-fab.
- Box can be attached to slider bracket before or after slider is installed on telescoping bracket.
- Box location can be field adjusted by moving slider along telescoping bracket.
- See Ruff-IN™ brochure for pre-fab box assemblies.
- Finish: Pre-galvanized

Telescoping Slider Bracket



BB216TS

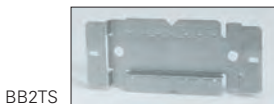

BB2TS

UPC/Part Number	Catalog Number	Stud Spacing	Box Qty.
78205138614	BB216TS	11" to 18"	20
78205138628	BB224TS	15" to 26"	20
78205138613	BB2TS	Slider Bracket Only	50

Patent # 7,472,875

Read safety/installation instruction sheets in packages before use.
These products are designed for positioning only. No load rating.

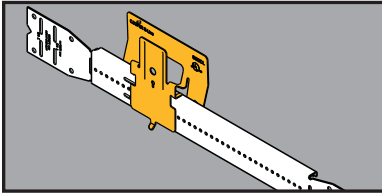

CROC-LOK™ Box Mounting Bracket



- Designed for pre-fab.
- Outlet boxes mount to the CROC-LOK with single screw.
- CROC-LOK box assemblies can be attached before or after the telescoping bar is mounted in the stud wall.
- The tool-less design enables CROC-LOK assemblies to be field installed in less than 4 seconds. Simply squeeze, secure and walk away.
- See Ruff-IN™ brochure for pre-fab box assemblies.

UPC/Part Number	Catalog Number	Description	Stud Spacing	Box Qty.
78205151291	BB2CL	CROC-LOK only	N/A	50
78205151292	BB216TCL	BB216T with CROC-LOK	11" - 16"	20
78205151293	BB224TCL	BB224T with CROC-LOK	15" - 24"	20

Note:

U.S. Patent # 8,403,277

Secures to B-Line BB2-16T and BB2-24T telescoping brackets only. For a standard 2¹/₈" deep box, the stud depth must be 3¹/₂" or greater. For a shallow 1¹/₂" deep box, the stud depth must be 2¹/₂" or greater.

Mounting Screws



UPC/Part Number	Catalog Number	Description	Box Qty.
78101101675	BWHS-9	#8 x 9/16" Sheet Metal Screw	1000
78101104925	BWHS-9D	#8 x 9/16" Self-Drilling Sheet Metal Screw	1000

Note: BWHS-9 & BWHS-9D can be used with all fasteners requiring attachment with sheet metal screws, except on BB2-16, BB2-16D, BB2-24 & BB2-24D which only BWHS-9 can be used.

*Read safety/installation instruction sheets in packages before use.
These products are designed for positioning only. No load rating.*

Wall Studs

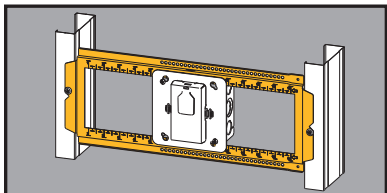

Open Box Mounting Bracket

Available August 2014



- Open box support allows for adjustability of box position between studs.
- Supports most US and Canadian boxes and/or plaster rings 4" SQ., 4¹¹/₁₆" SQ., 5" SQ., and multi-gang boxes.

- Fits up to 1¹/₂" wide studs 16" to 24" on center.
- Compatible with Rapid Ring™ & adjustable plaster rings.
- Field cut to adjust to non-standard stud spacings.
- Stamped markings at 1/4", 1/2", and 1" increments to allow the installer to easily locate the desired box position.
- Available factory assembled as part of the Ruff-IN™ pre-fab line with box(es), mud ring(s), and pre-wired devices.
- Finish: Pre-galvanized
- Patent Pending

Wall Studs

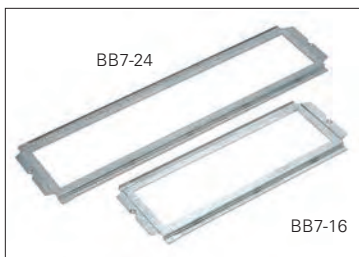

UPC/Part Number	Catalog Number	Description	Box Qty.
78205145325	BB7-16	16" Stud Spacing	25
78205145328	BB7-24	24" Stud Spacing	25

Can be cut on a mark to make shorter length brackets.

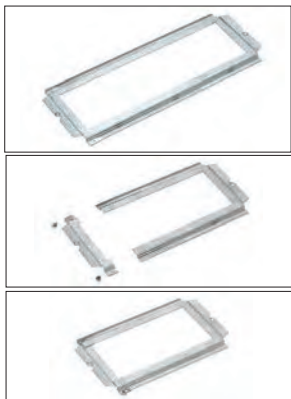

Can be used with BBFS-18 (floor stand)
See pages 33 & 34.



Read safety/installation instruction sheets in packages before use.
These products are designed for positioning only. No load rating.

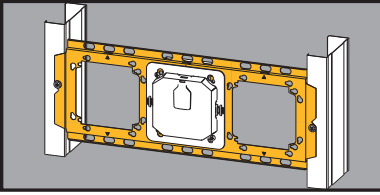

Box Mounting Bracket



- Increased strength and rigidity help withstand the stress of drywall installation.
- Supports most US & Canadian boxes and plaster rings 4" SQ. and 4^{11/16}" SQ.
- Compatible with 1-gang and 2-gang Rapid Ring™ and adjustable plaster rings.
- Available factory assembled as part of the Ruff-IN™ pre-fab line with box(es), mud ring(s), and pre-wired devices.
- Finish: Pre-galvanized
- Patent Pending

Wall Studs

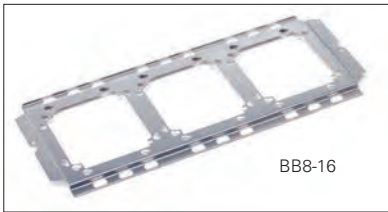

BB8-16

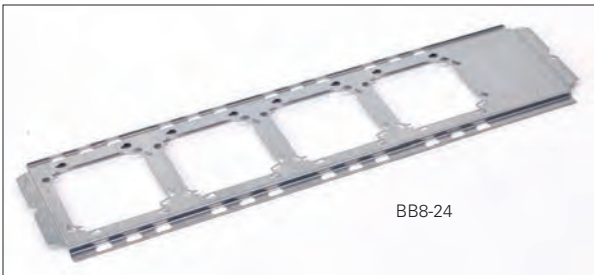

BB8-24

UPC/Part Number	Catalog Number	Description	Box Qty.
78101102898	BB8-16	16" Stud Spacing	25
78101102900	BB8-24	24" Stud Spacing	25

*Read safety/installation instruction sheets in packages before use.
These products are designed for positioning only. No load rating.*

Wall Studs

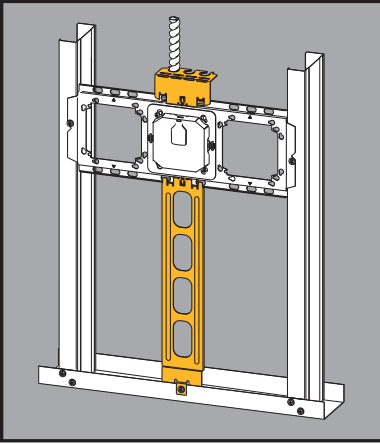

- Bracket accessories require no tools to install.
- BBCC cable containment clip provides first means of support for MC cable.
- BBFS-18 floor stand ensures consistent box height and eliminates need to measure for proper install height.
- Can be used with BB7 and BB8 brackets. See pages 27, 31, and 32.
- Pre-galvanized finish.

Wall Studs

Box Mounting Bracket Accessories

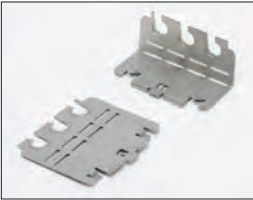

BBCC

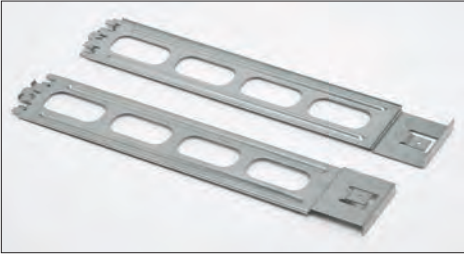

BBFS-18

UPC/Part Number	Catalog Number	Description	Box Qty.
79903851597	BBFS-18	Floor Stand	25
79903851598	BBCC	.439" - .750" OD MC Cable	50

*Read safety/installation instruction sheets in packages before use.
These products are designed for positioning only. No load rating.*

Box Mounting Bracket Accessories con't.



BB8-16 Installed



BBFS-18 & BBCC Installed (Can be used with BB7 or BB8 brackets)

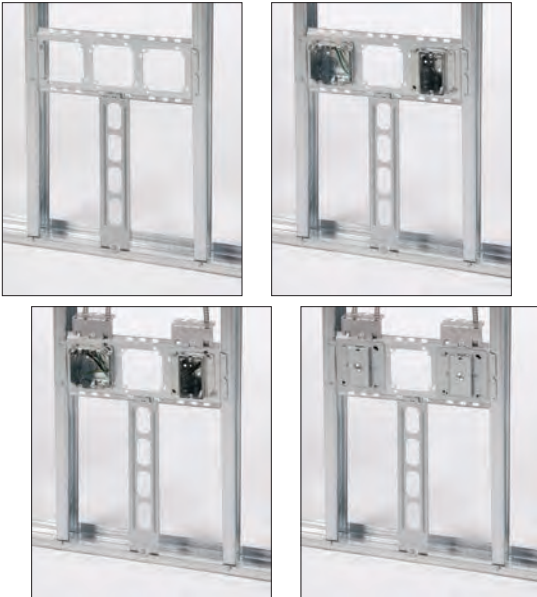

*Read safety/installation instruction sheets in packages before use.
These products are designed for positioning only. No load rating.*

Wall Studs

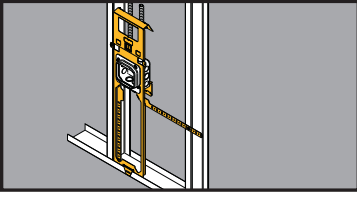

Floor-Mount Box Support



BBFC



BBF15

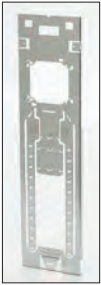

BBF18



BBF24



BBFxxC

- New BBF floorstand provides the most rigid support in the industry.
- Far-side support accommodates 6", 5 1/2", 3 5/8", and 2 1/2" stud depths.
- Fold-out tab built-in to attach floor stand to stud if desired.
- Integral "wings" provide rigid support when floorstand is mounted between studs.
- Optional cable containment clip securely attaches to floorstand without hardware.
- Patented Marty Mouse™ ears enable boxes to be secured in place with or without the plaster rings.
- Finish: Pre-galvanized.
- See Ruff-IN™ brochure for pre-fab box assemblies.

UPC/Part Number	Catalog Number	Box Center Height	Box Qty.
78205152944	BBF15	15" Floorstand	25
78205152945	BBF18	18" Floorstand	25
78205152946	BBF24	24" Floorstand	25
78205152947	BBFC	18" Floorstand	25
78205152948	BBF15C	15" Floorstand with Cable Clip	25
78205152949	BBF18C	18" Floorstand with Cable Clip	25
78205152950	BBF24C	24" Floorstand with Cable Clip	25

Patent #5595362
Patent #7956285 B2

*Read safety/installation instruction sheets in packages before use.
These products are designed for positioning only. No load rating.*

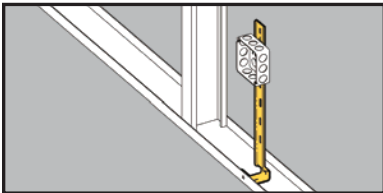

Floor Mounted Box Support



- See **BBF Series** for a better solution.
- Provides support for electrical box from floor track or concrete forms.
- 18" length with break-away feature for 12" or 16" box mounting.
- Finish: Pre-galvanized

UPC/Part Number	Catalog Number	Description	Box Qty.
78101103623	BB-18	Floor Mounted Box Support	50

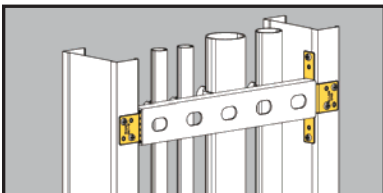

Strut Mounting Brackets



- Attaches 13/16" strut, 1 1/2" lathers channel, 1/2" EMT or 3/4" EMT to metal studs.
- Provides support for vertical runs of conduit.
- Finish: Pre-galvanized

UPC/Part Number	Catalog Number	Description	Box Qty.
78101101658	BMB1	Strut Mounting Bracket	25 pr.

Read safety/installation instruction sheets in packages before use. These products are designed for positioning only. No load rating.

Wall Studs

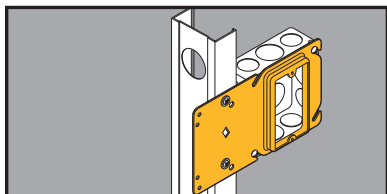

- Uni-Mount provides a secure support for 4" square boxes and features a built-in plaster ring.
- Rigid bracket design eliminates the need for far-side support.
- Enlarged viewing hole makes it easier to find mark lines on the stud.
- Gangable design accepts BB423 bracket to mount boxes on both sides of the stud.
- See Ruff-IN™ brochure for pre-fab box assemblies.
- Finish: Pre-galvanized

Uni-Mount™ Box Support/Cover Plate Mounting Bracket

Single Gang
BB40 Series



Double Gang
BB45 Series

UPC/Part Number	Catalog Number	Description	Box Qty.
78205122768	BB40-08	1/2" Raise	50
78205122771	BB40-10	5/8" Raise	50
78205122772	BB40-12	3/4" Raise	50
78205122773	BB45-08	1/2" Raise	50
78205122774	BB45-10	5/8" Raise	50
78205122775	BB45-12	3/4" Raise	50

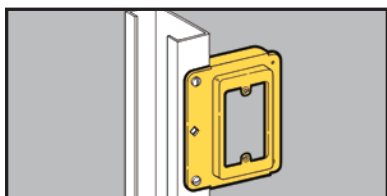

Cover Plate Mounting Bracket



- Provides attachment base for low voltage outlets.
- Replaces electrical box in Class 2 low voltage installations.
- Can be piggy-backed.
- For 1/2" and 5/8" drywall applications.
- Finish: Pre-galvanized

UPC/Part Number	Catalog Number	Description	Box Qty.
78101119873	BB15	Single Gang Stud Bracket	50

Read safety/installation instruction sheets in packages before use.
These products are designed for positioning only. No load rating.

Rapid Ring™ Self Adjusting Pre-Fab Ring

The Rapid Ring self-adjusting pre-fab plaster ring can help you win tight bids and beat the profit squeeze with its innovative 4-step installation. This revolutionary new pre-fab system installs in as little as 15 seconds per unit, compressing your project schedule, cutting operational costs and reducing onsite waste.

Because the Rapid Ring is a self-adjusting pre-fab ring, you'll never need to adjust a mud ring again. With a simple push of the Rapid Ring you're flush every time.



1. Remove protective plate.
2. Connect the wiring device.
3. Position the device assembly.
4. Push in the device assembly—and you're done!

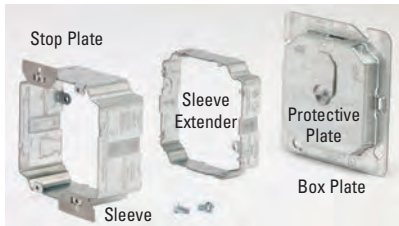

For Use With Wiring Device Qty.	Electrical Box ⁵	Box Plate ¹ Cat. No.	Sleeve ^{2,3} Cat. No.	Sleeve Extender ⁴ Cat. No.
1	4" sq.	B1RRP4C	B1RRR	B1RRE
1	4 ¹¹ / ₁₆ " sq.	B1RRP5C	B1RRR	B1RRE
2	4" sq.	B2RRP4C	B2RRR	B2RRE
2	4 ¹¹ / ₁₆ " sq.	B2RRP5C	B2RRR	B2RRE
3	3-gang ⁶	B3RRPC	B3RRR	B3RRE
4	4-gang ⁷	B4RRPC	B4RRR	B4RRE

1. Protective plate included with box plate.
2. Wall thickness range: 1/2" min. to 1 1/4" max.
3. Stop plates included with sleeve.
4. Sleeve extender is an optional accessory to extend max. wall thickness range to 2"
(order separately, mounting hardware included)
5. Minimum electrical box depth is 2 1/8"
6. Keyhole knockouts allow use on 2-gang electrical box.
7. Keyhole knockouts allow use on 3-gang electrical box.

Go to www.cooperbline.com/rapidring

*Read safety/installation instruction sheets in packages before use.
These products are designed for positioning only. No load rating.*

Wall Studs



- Supports horizontal runs of conduit, flexible conduit, MC or AC cable through metal studs.
- Attaches easily with a single sheet metal screw.
- Prevents conduit/cable rattling.

Conduit/Cable Supports

Wall Studs



BG-x-H7



BP-x-H7
(Not UL)



BX4-H7



BX4M-H7
(Not UL)



UPC/Part Number	Catalog Number	Conduit/Cable Size	Box Qty.
78101101228	BG-6-H7 *	3/8", MC, AC, or FMC	100
78101110238	BG-8-12-H7	1/2" or 3/4"	100
Patent #4958792			
78101101227	BP-8-H7	1/2" EMT	100
78101101226	BP-12-H7	3/4" EMT 1/2" IMC, Rigid	100
78101101200	BX4-H7	MC, AC, or FMC	100
78101101205	BX4M-H7	MC, AC, or FMC	100

* BG-6 will accept the following range $\varnothing.420 - \varnothing.675$:
14/2 thru 10/4 MC/AC cable and $5/16$ or $3/8$ flexible conduit

*Read safety/installation instruction sheets in packages before use.
These products are designed for positioning only. No load rating.*

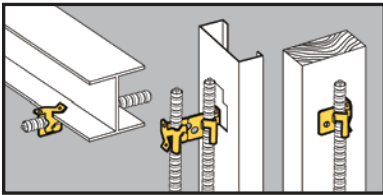

Flexible Conduit/ Cable Fasteners



BX4



BX4M



BX4MD



- Attaches MC, AC, sizes 14/2 through 10/3 or 3/8" FMC to studs or flanges up to 3/16" thick.
- Snaps into place on metal stud openings or may be screwed to metal or wood studs.
- BX4M may be snapped in half to make two BX4's.
- Allows cables to be positioned a minimum of 1 1/4" from face of stud as required by NEC Article 300.4(D).

UPC/Part Number	Catalog Number	Description	Box Qty.
78101101079	BX4	Single Runs	100
78101101080	BX4M	Double Runs	100
78101101224	BX4MD	Up to 4 Runs	100

*Read safety/installation instruction sheets in packages before use.
These products are designed for positioning only. No load rating.*

Wall Studs

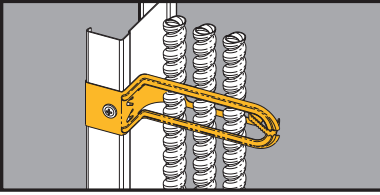

Cable Support



- Metal cable support can be used in plenum-rated areas.
- Longer locking tabs.
- Shipped pre-assembled.
- Hinge can be opened for greater cable capacity.
- Allows cables to be positioned a minimum of 1 1/4" from face of stud as required by NEC Article 300.4(D).

UPC/Part Number	Catalog Number	Description	Box Qty.
79903843761	BRC6M	Up to 3/4" FMC	100

Note: Canadian applications are limited to wood studs only.

Cable Size	Cable Type					
	Non-Metallic (NM)		Metal Clad (MC)		Armored Cable (AC)	
	Qty.	Dia.	Qty.	Dia.	Qty.	Dia.
14-2 w/ Grnd	8	.360	5	.439	5	.464
14-3 w/ Grnd	8	.307	5	.464	5	.483
14-4 w/ Grnd	8	.336	4	.494	4	.517
12-2 w/ Grnd	7	.410	5	.475	4	.498
12-3 w/ Grnd	8	.347	4	.505	4	.521
12-4 w/ Grnd	7	.381	4	.539	4	.557
10-2 w/ Grnd	6	.494	4	.542	4	.560
10-3 w/ Grnd	7	.422	4	.580	4	.588
10-4 w/ Grnd	NA	NA	3	.623	3	.632
8-2 w/ Grnd	4	.612	NA	NA	NA	NA
8-3 w/ Grnd	4	.565	NA	NA	NA	NA
6-2 w/ Grnd	4	.650	NA	NA	NA	NA
5/16 FMC			5 (.470 to .510 Dia.)			
3/8 FMC			4 (.560 to .610 Dia.)			
1/2 FMC			1 (.860 to .920 Dia.)			
3/4 FMC			1 (1.045 to 1.105 Dia.)			

The quantity of cables shown in the chart is the maximum. Fewer cables can be supported. Diameters are based on data from a leading cable manufacturer (may vary slightly). Diameters of some NM cables refer to the widest dimension of a flat cable. NA = Not applicable

Read safety/installation instruction sheets in packages before use. These products are designed for positioning only. No load rating.

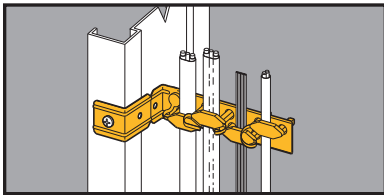

Staple-Lok™ Multi-Purpose Cable Support



- Individual plastic staples grip cable and reduce slipping.
- Secures up through #10 type NM cable.
- Supports AC, MC or FMC cable up to 1/2" O.D.
- Break-apart feature allows installation on studs and furring strips.
- Allows cables to be positioned a minimum of 1 1/4" from face of stud as required by NEC Article 300.4(D).

UPC/Part Number	Catalog Number	Cable Size	Box Qty.
78101103587	BRC4	Up to .500" O.D.	100

Patent #5587555

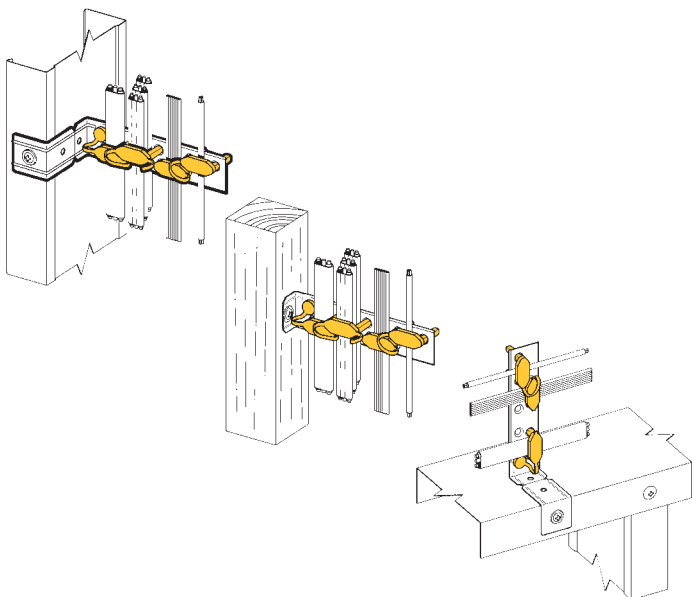

*Read safety/installation instruction sheets in packages before use.
These products are designed for positioning only. No load rating.*

Wall Studs

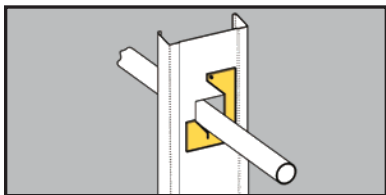

- Allows conduit, MC, AC, or FMC to be pulled through metal studs.
- Provides support for horizontal runs of conduit or cable through metal stud.
- Prevents rattling of conduit/cable.
- Finish: Pre-galvanized

Conduit/Cable Supports



UPC/Part Number	Catalog Number	Conduit/Cable Size	Box Qty.
78101101657	BX82	Up to 1"	100

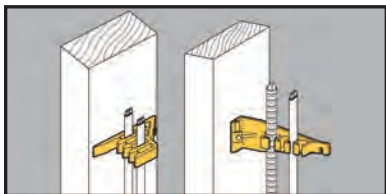

- Attaches Type NM cables to wood studs.
- Can be used to support computer, CATV, telephone, security and instrumentation cables.
- Provided with nail inserted.
- Allows cables to be positioned a minimum of 1¹/₄" from face of stud as required by NEC Article 300.4(D).

Cable Fasteners



BRC1



BRC2

UPC/Part Number	Catalog Number	Description	Box Qty.
78101102941	BRC1	Wood Stud Cable Fastener	50
78101102941	BRC2	Furring Strip Cable Fastener	50

Read safety/installation instruction sheets in packages before use. These products are designed for positioning only. No load rating.

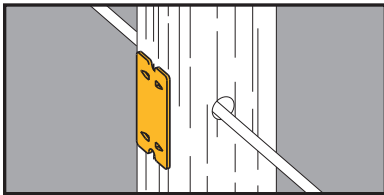

- Protects cable, plastic pipe and copper tubing from screw or nail penetration.
- Easily installed with a hammer.
- Complies with NEC Article 300-4.

Nail Plates For Wood Studs



UPC/Part Number	Catalog Number	Description	Box Qty.
78101104927	BM3	Nail Plate	100

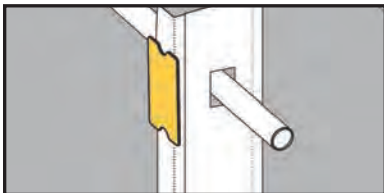

- Protects cable, plastic pipe and copper tubing from screw or nail penetration.
- Comes with industrial grade double stick tape on back for easy installation on stud.
- Complies with NEC Article 300-4.

Nail Plates For Metal Studs



Just Peel Tape and Stick To Stud

UPC/Part Number	Catalog Number	Description	Box Qty.
78101126251	BM3M	Nail Plate	100

Read safety/installation instruction sheets in packages before use. These products are designed for positioning only. No load rating.

Wall Studs

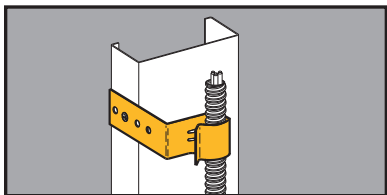

Conduit Support



BB38



BB38D

- Larger capacity: Redesigned BB38D attaches 1/2" to 1" EMT or flexible conduit to metal or wood studs.
- BB38 attaches MC/AC cable, 1/2" & 3/4" EMT to metal or wood studs.
- Eliminates the need for offset bending of conduit.
- Aligns conduit with standard box knockouts.

UPC/Part Number	Catalog Number	Box Depth	Box Qty.
78101104265	BB38	1 1/2"	100
78101195244	BB38D	2 1/8"	100

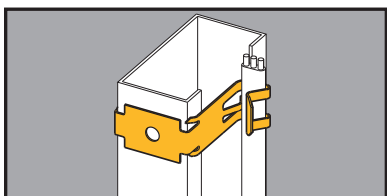

Flexible Conduit/Cable Fasteners



- Secures Romex^{®†} sizes 14/2 w/ground thru 12/3 w/ground, MC/AC sizes 14/2 thru 12/3 to metal or wood studs.
- Allows cables to be positioned a minimum of 1 1/4" from face of stud as required by NEC Article 300.4(D).

UPC/Part Number	Catalog Number	Description	Box Qty.
78101119755	BX5	Secures Flexible Conduit or Cable to Metal or Wood Studs	100

†Romex[®] is a registered trademark used by Southwire[®] Company, Carrollton, Georgia.

Read safety/installation instruction sheets in packages before use.
These products are designed for positioning only. No load rating.

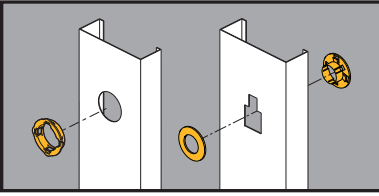

Metal Stud Grommet



- BM1 snaps into standard 1¹¹/₃₂" diameter holes in metal studs from 25 Ga. to 16 Ga.
- Redesigned BM2 is shipped as one piece and easily separated for installation.
- Universal BM2 provides 360° protection. Fits all factory punched metal stud holes.
- Protects wire insulation in accordance with NEC Article 300.4(B) (1).



BM1



BM2

UPC/Part Number	Catalog Number	Description	Box Qty.
78101119100	BM1	Plastic Grommet	100
78101119102	BM1M	Plastic Grommet (Bulk Quantity)	100
78101104926	BM2	Universal Plastic Grommet	100

Read safety/installation instruction sheets in packages before use. These products are designed for positioning only. No load rating.

Conduit & Cable

Conduit & Cable



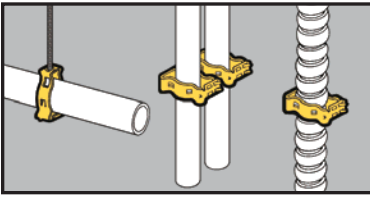

Guide-Rite™ Conduit Fasteners



Clearance Hole
For 1/4" Bolt

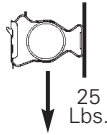

**Static
Load
Capacity**

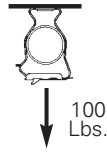

- Supports 3/8" to 2" conduit.
- Unique Guide-Rite Fastener provides for fast and easy installation with pliers.
- Now available in DURA-COPPER™ finish - add DCU to part number.
- Static Load Capacity:
100 Lbs. - Vertical
25 Lbs. - Horizontal

UPC/Part Number	Catalog Number	Conduit Size EMT/Rigid	Box Qty.
78101118350	BG-6*	3/8"	100
78101118355	BG-8-12	1/2", 3/4"	100
78101118360	BG-16	1"	100
78101118365	BG-20	1 1/4"	100
78101118360	BG-24	1 1/2"	100
78101118375	BG-32	2"	100



1/4"-20
Thread Impression



UPC/Part Number	Catalog Number	Conduit Size EMT/Rigid	Box Qty.
78101118380	BG-6-4T*	3/8"	100
78101118385	BG-8-12-4T	1/2", 3/4"	100
78101118390	BG-16-4T	1"	100
78101118395	BG-20-4T	1 1/4"	100
78101118400	BG-24-4T	1 1/2"	100
78101118405	BG-32-4T	2"	100

Patent #4958792

- * BG-6 and BG-6-4T will accept the following range $\varnothing.420 - \varnothing.675$:
1/2 thru 10/4 MC/AC cable and 5/16 or 3/8 flexible conduit

Read safety/installation instruction sheets in packages before use.

Conduit & Cable

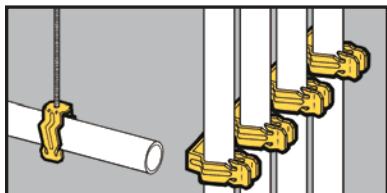

- Conduit easily snaps into push type fastener for secure support.
- Available with clearance hole for 1/4" bolt or 1/4"-20 thread impression.
- **Ultimate Static Load Capacity:**
25 Lbs. Vertical
15 Lbs. Horizontal

Push-Type Conduit Fasteners

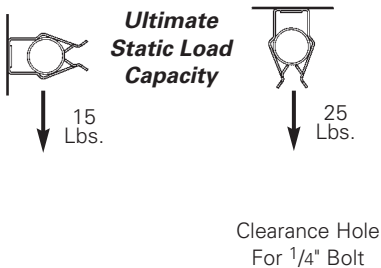

UPC/Part Number	Catalog Number	Conduit Size	Box Qty.
78101119200	BP-8	1/2" EMT	100
78101119205	BP-12	3/4" EMT 1/2" IMC, Rigid	100
78101119210	BP-16	1" EMT 3/4" IMC, Rigid	100

1/4"-20
Thread Impression



UPC/Part Number	Catalog Number	Conduit Size	Box Qty.
78101119215	BP-8-4T	1/2" EMT	100
78101119220	BP-12-4T	3/4" EMT 1/2" IMC, Rigid	100
78101119225	BP-16-4T	1" EMT 3/4" IMC, Rigid	100

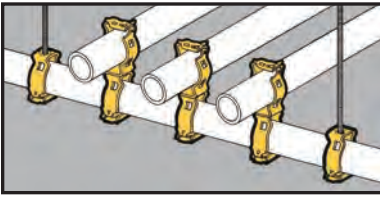

Guide-Rite™ Conduit Trapeze Fasteners



- For use with 3/8" to 2" conduit.
- Guide-Rite Fastener provides for fast and easy installation with pliers.



- Note: Total load of trapeze must not exceed 100 Lbs.

UPC/Part Number	Catalog Number	Conduit To 1" Trapeze	Box Qty.
78101118615	BG-16-G-6*	3/8"	100
78101118620	BG-16-G-8-12	1/2", 3/4"	100
78101118595	BG-16-G-16	1"	100
78101118600	BG-16-G-20	1 1/4"	50
78101118605	BG-16-G-24	1 1/2"	50
78101118610	BG-16-G-32	2"	50

* BG-16-G-6 will accept the following range \varnothing .420 - \varnothing .675: 14/2 thru 10/4 MC/AC cable and 5/16 or 3/8 flexible conduit

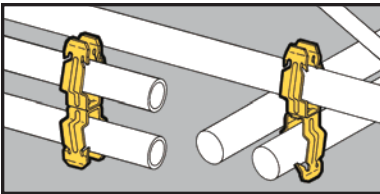

Push-Type Conduit To Conduit Fasteners

- An ideal spacer between conduits.
- No installation tools required.



- **Ultimate Static Load Capacity:** 25 Lbs.

UPC/Part Number	Catalog Number	Conduit Size	Box Qty.
78101118615	BP-8-P-8	1/2" to 1/2"	100
78101118620	BP-8-P-12	1/2" to 3/4"	100
78101118595	BP-8-P-16	1/2" to 1"	100
78101118600	BP-12-P-12	3/4" to 3/4"	100
78101118605	BP-12-P-16	3/4" to 1"	100
78101118610	BP-16-P-16	1" to 1"	100

Note: For rigid conduit with BP series, use next size larger fastener (1/2" Rigid use BP-12).

Read safety/installation instruction sheets in packages before use.

Conduit & Cable

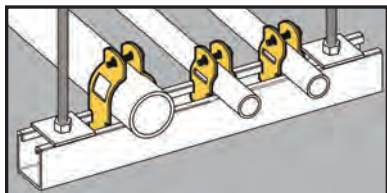

Break-Apart Conduit Clamps

- Patented Multi-Grip design fits Rigid, IMC or EMT conduit.
- Convenient break-apart clamp features retained bolt and $\frac{5}{16}$ " thread impression to eliminate handling of nuts and bolts.
- Finish: Pre-galvanized.
- Static Load Capacity: 200 lbs.



BPC-8 thru BPC-32

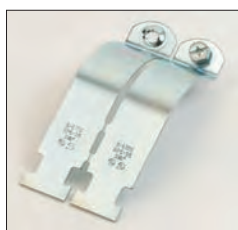

BPC-40 thru BPC-64



Static Load Capacity

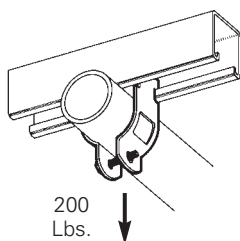

UPC/Part Number	Catalog Number	Rigid or EMT Conduit Size	Box Qty.
78101101676	BPC-8	1/2"	100
78101101677	BPC-12	3/4"	100
78101101680	BPC-16	1"	100
78101101679	BPC-20	1 1/4"	50
78101101678	BPC-24	1 1/2"	50
78101101681	BPC-32	2"	50
78101103977	BPC-40	2 1/2"	50
78101103978	BPC-48	3"	50
78101103979	BPC-56	3 1/2"	25
78101103981	BPC-64	4"	25

Patent #4044428

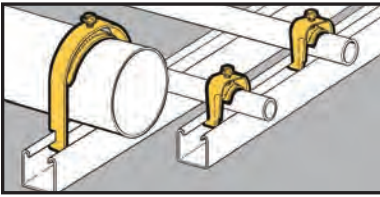

Conduit Strut Clamps



B1532S thru B1564S

B1506S
thru
B1524S



B1508
thru
B1520



- Attaches conduit, flexible conduit or cables to standard strut channels.
- B1506S designed to secure and support MC/AC cables.
- Unique one-piece design eliminates handling of hardware and allows easy installation and removal in side-by-side conduit runs.
- Anti-rock feature prevents clamp from disengaging during installation.
- Finish: Pre-galvanized

UPC/Part Number	Catalog Number	Conduit Size		OD Range Inches		Static Load Cap. Lbs.	Box Qty.
		EMT	Rigid	Min	Max		
78101163150	B1508	1/2"	--	--	--	200	100
78101163154	B1512	3/4"	1/2"	--	--	200	100
78101163157	B1516	1"	3/4"	--	--	300	100
78101163160	B1520	1 1/4"	1"	--	--	300	100
Note: Clamps without saddle are not recommended for flexible conduit or cable							
78205144495	B1506S*	3/8"*	--	.400	.630	200	100
78101163164	B1508S	1/2"	--	.250	.680	200	100
78101163168	B1512S	3/4"	1/2"	.500	.840	200	100
78101163171	B1516S	1"	3/4"	.750	1.050	300	100
78101163177	B1520S	1 1/4"	1"	1.125	1.315	300	100
78101163182	B1524S	1 1/2"	1 1/4"	1.375	1.660	400	50
78101163188	B1532S	2"	1 1/2"	1.875	2.200	400	50
78101163193	B1534S	--	2"	2.125	2.375	400	25
78101163199	B1540S	2 1/2"	2 1/2"	2.625	2.875	400	25
78101163205	B1548S	3"	3"	3.250	3.500	400	25
78101163211	B1556S	3 1/2"	3 1/2"	3.750	4.000	400	10
78101163215	B1564S	4"	4"	4.250	4.500	400	10

Patent #5022614

- * B1506S will accept the following
 AC Cable 14/2, 14/3, 14/4, 12/2, 12/3, 12/4, 10/2, 10/3, 10/4
 MC Cable 14/2, 14/3, 14/4, 12/2, 12/3, 12/4, 10/2, 10/3, 10/4

Read safety/installation instruction sheets in packages before use.

Conduit & Cable

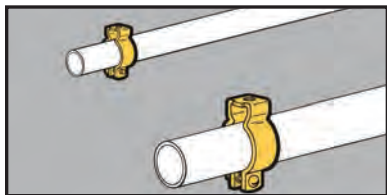

- For use with 1/2" thru 4" Conduit.
- Static Load Capacity: 400 lbs.
- Now available in DURA-COPPER™ finish - add DCU to part number.
- Finish: Zinc-Plated

Conduit Hangers



With Retained Bolt
And
Thread Impression



UPC/Part Number	Catalog Number	Trade Size	Conduit Size		Box Qty.
			EMT	Rigid	
78101119800	BL1400*	0	1/2"	1/2"	100
78101119801	BL1410*	1	3/4"	3/4"	100
78101119802	BL1420*	2	1"	1"	100



With Bolt And Nut



UPC/Part Number	Catalog Number	Trade Size	Conduit Size		Box Qty.
			EMT	Rigid	
78101119803	BL1425*	2.5	1 1/4"	--	100
78101119804	BL1430*	3	1 1/2"	1 1/4"	100
78101119805	BL1440†	4	--	1 1/2"	50
78101119806	BL1450†	5	2"	2"	50
78101119807	BL1460†	6	2 1/2"	2 1/2"	25
78101119808	BL1470†	7	3"	3"	25
78101119809	BL1480†	8	3 1/2"	3 1/2"	10
78101119810	BL1490†	9	4"	4"	10

* 9/32" mounting hole. † 11/32" mounting hole.

Read safety/installation instruction sheets in packages before use.

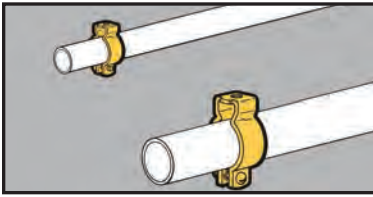

- For use with 1/2" thru 4" Conduit.
- Static Load Capacity: 400 lbs.
- Material: Type 304 Stainless Steel

Stainless Steel Conduit Hangers



With Bolt And Nut

UPC/Part Number	Catalog Number	Trade Size	Conduit Size		Box Qty.
			EMT	Rigid	
78101119800	BL1400-SS4*	0	1/2"	1/2"	100
78101119801	BL1410-SS4*	1	3/4"	3/4"	100
78101119802	BL1420-SS4*	2	1"	1"	100
78101119803	BL1425-SS4*	2.5	1 1/4"	–	100
78101119804	BL1430-SS4*	3	1 1/2"	1 1/4"	100
78101119805	BL1440-SS4†	4	–	1 1/2"	50
78101119806	BL1450-SS4†	5	2"	2"	50
78101119807	BL1460-SS4†	6	2 1/2"	2 1/2"	25
78101119808	BL1470-SS4†	7	3"	3"	25
78101119809	BL1480-SS4†	8	3 1/2"	3 1/2"	10
78101119810	BL1490-SS4†	9	4"	4"	10

* 9/32" mounting hole. † 1 1/32" mounting hole.

Read safety/installation instruction sheets in packages before use.

Conduit & Cable

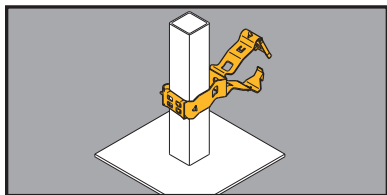

Guide-Rite™ Conduit To Pedestal Support

- Supports conduit from square computer floor pedestals.
- Unique Guide-Rite Fastener provides for fast and easy installation with pliers.
- Static Load Capacity: 25 lbs.



UPC/Part Number	Catalog Number	Conduit Size EMT/Rigid	Box Qty.
78205125589	BG-8-12-G6*	3/8"	100
78101188538	BG-8-12-G812	1/2" or 3/4"	100
78101118620	BG-16-G-8-12	1"	100
78205125594	BG-8-12-G20	1 1/4"	50
78205125595	BG-8-12-G24	1 1/2"	50
78205125597	BG-8-12-G32	2"	50

Patent #4958792

- * BG-8-12-G6 will accept the following range \varnothing .420 - \varnothing .675: 14/2 thru 10/4 MC/AC cable and 5/16 or 3/8 flexible conduit

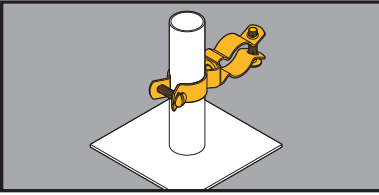

Conduit To Pedestal Support

- Supports conduit from 1" O.D. computer floor pedestals.
- Also available in Type 304 Stainless Steel. Contact factory for details.
- Static Load Capacity: 25 lbs.
- Finish: Zinc-Plated



UPC/Part Number	Catalog Number	Trade Size	Conduit Rigid	Conduit Size EMT	Box Qty.
78205125599	BL1410-L1400	0	1/2"	1/2"	50
78205125601	BL1410-L1410	1	3/4"	3/4"	50
78205125602	BL1410-L1420	2	1"	1"	50
78205125603	BL1410-L1425	2.5	–	1 1/4"	50
78205125607	BL1410-L1430	3	1 1/4"	1 1/2"	50
78205125612	BL1410-L1440	4	1 1/2"	–	25
78205125614	BL1410-L1450	5	2"	2"	25
78205125617	BL1410-L1460	6	2 1/2"	2 1/2"	10
78205125618	BL1410-L1470	7	3"	3"	10
78205125619	BL1410-L1480	8	3 1/2"	3 1/2"	5

Read safety/installation instruction sheets in packages before use.

Conduit & Cable

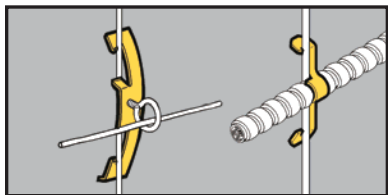

- BW2 and BW6 support #10-24 or 1/4"-20 threaded bridle rings and provide attachment for electrical boxes.
- BW2S & BW6S are provided with one each 1/4"-20 x 3/8" screw and hex nut.
- BW4 supports cables from #12 thru #8 wire.

Rod & Wire Fasteners



UPC/Part Number	Catalog Number	Drop Rod/ Wire Size	Flange Thickness	Box Qty.
78101119700	BW2	#12 wire thru 1/4" plain or threaded rod	1/8" - 3/8"	100
78205140156	BW2S	#12 wire thru 1/4" plain or threaded rod	1/8" - 3/8"	100
78101195516	BW6	3/8" plain or threaded rod	3/8" - 7/16"	100
78205140157	BW6S	3/8" plain or threaded rod	3/8" - 7/16"	100

Conduit & Cable

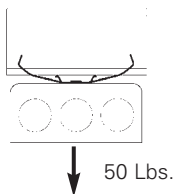

**Static Load
Capacity**



UPC/Part Number	Catalog Number	Description	Box Qty.
78101119705	BW4	Multi-size Wire Fastener	100



MC/AC Cable Size	#12 Wire	#10 Wire	#8 & #9 Wire
14/2 Cable	BW4	BW4	BW4
14/3 Cable	BW4	BW4	BW4
12/2 Cable	BW4	BW4	BW4
12/3 Cable	BW4	BW-8	BW-8

BW4 is designed for positioning only. No load rating.

Note: An independent means of support is required by NEC Article 300.11. Refer to pages 225-226 for additional support methods.

Conduit & Cable

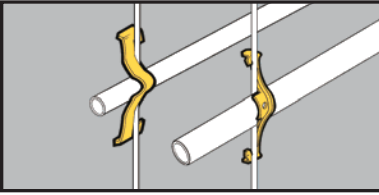

- See BX8 and BX18 for a better solution.
- Attaches conduit to wire rods or flanges.
- Can be used for flexible metallic tubing or armored cable.

Rod & Wire Fasteners



BW-8



BW-16



UPC/Part Number	Catalog Number	Box Qty.
78101119710	BW-8	100
78101119715	BW-12	100
78101119720	BW-16	100
78101119725	BW-20	100

Conduit Size	#10 & #12 Wire	#8 & #9 Wire	3/16" & 1/4" Rod	1/8" to 1/4" Flange	5/16" to 3/8" Flange	7/16" to 1/2" Flange
1/2" EMT	BW-8	BW-8	BW-8	BW-8	BW-12	BW-12
1/2" Rigid	BW-8	BW-12	BW-12	BW-12	BW-12	BW-16
3/4" EMT	BW-12	BW-12	BW-12	BW-12	BW-16	BW-16
3/4" Rigid	BW-12	BW-12	BW-16	BW-16	BW-20*	BW-20*
1" EMT	—	BW-16	BW-16	BW-16	BW-20*	BW-20*
1" Rigid	—	—	—	BW-20*	BW-20*	BW-20*
1 1/4" EMT	—	BW-20	BW-20	BW-20	—	—

*Note: For horizontal applications only.

Static Load Capacity

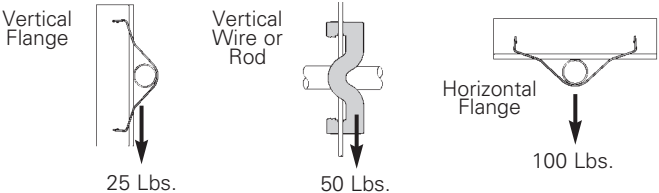

Note: An independent means of support is required by NEC Article 300.11. Refer to pages 225-226 for additional support methods.

Read safety/installation instruction sheets in packages before use.

Conduit & Cable

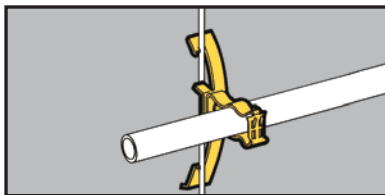

- Assemblies support 1/2", 3/4" and 1" conduit.
- W2 series attaches to 1/8" thru 3/8" flanges or #12 wire thru 1/4" plain or threaded rod.
- W6 series attaches to 3/8" thru 7/16" flanges or 3/8" plain or threaded rod.

Guide-Rite™ Conduit To Rod Fasteners



UPC/Part Number	Catalog Number	Conduit Size EMT/Rigid	Box Qty.
78101118540	BG-8-12-W2	1/2", 3/4"	100
78101118640	BG-16-W2	1"	100
78101195519	BG-8-12-W6	1/2", 3/4"	100
78101195520	BG-16-W6	1"	100

Patent #4958792

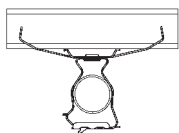

50 Lbs.

**Static Load
Capacity**

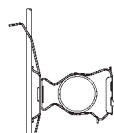

25 Lbs.

Note: An independent means of support is required by NEC Article 300.11. Refer to pages 225-226 for additional support methods.

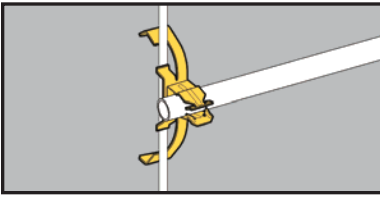

Push-Type Conduit To Rod Fasteners

- Assemblies support 1/2", 3/4" and 1" conduit.
- W2 series attaches to 1/8" thru 3/8" flanges or #12 wire thru 1/4" plain or threaded rod.
- W6 series attaches to 3/8" thru 7/16" flanges or 3/8" plain or threaded rod.



UPC/Part Number	Catalog Number	Conduit Size	Box Qty.
78101119325	BP-8-W2	1/2" EMT	100
78101119420	BP-12-W2	3/4" EMT or 1/2" IMC. Rigid	100
78101119505	BP-16-W2	1" EMT or 3/4" IMC, Rigid	100
78101195521	BP-8-W6	1/2" EMT	100
78101195522	BP-12-W6	3/4" EMT or 1/2" IMC. Rigid	100
78101195523	BP-16-W6	1" EMT or 3/4" IMC, Rigid	100

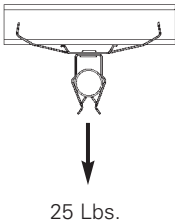

25 Lbs.

Ultimate Static Load Capacity

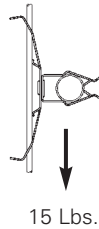

15 Lbs.

Note: An independent means of support is required by NEC Article 300.11. Refer to pages 225-226 for additional support methods.

Conduit & Cable

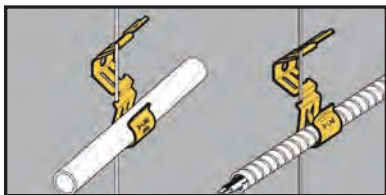

Flex-Rite™ Cable/Conduit To Wire Fasteners



- Can be used in place of batwings.
- Will not bend or deform hanger wire.
- Attaches to #12 - #8 wire and 1/4" plain rod.
- Accommodates MC, AC, 3/8" FMC or 1/2" EMT.
- Cable can be installed before or after attachment to wire.
- Static Load Capacity:
BX-8 - 20 Lbs.
BX-18 - 30 Lbs.

UPC/Part Number	Catalog Number	Cable/Conduit Size	Box Qty.
78101101402	BX-8	.375" to 706" O.D.	100
78101102943	BX-18	.706" to 1.380" O.D.	100
78101101685	BX-8B	Bulk Packed In Fiber Barrels	4000

Conduit & Cable

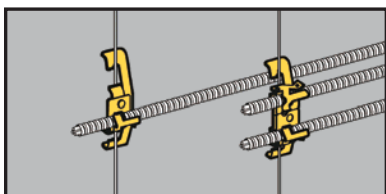

Cable To Rod Fasteners



BX4-W2



- Assemblies support MC, AC, sizes 14/2 through 10/3 or 3/8 FMC.
- W2 series attaches to 1/8" thru 3/8" flanges or #12 wire thru 1/4" plain or threaded rod.
- W6 series attaches to 3/8" thru 7/16" flanges or 3/8" plain or threaded rod.

BX4M-W2

UPC/Part Number	Catalog Number	Description	Box Qty.
78101101219	BX4-W2	Single Runs	100
78101101189	BX4M-W2	Double Runs	100
78101195517	BX4-W6	Single Runs	100
78101195518	BX4M-W6	Double Runs	100

Read safety/installation instruction sheets in packages before use.

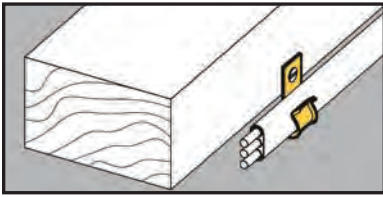

- Attaches Type NM cable to most structures.
- Supports cable sizes 14/2 and 12/2 with ground wire.
- May be used with other B-Line fasteners for attachment to acoustical tees, beams, drop wires, etc.

Cable Fasteners



UPC/Part Number	Catalog Number	Description	Box Qty.
78101103553	BRC3	Type NM Cable Fastener	100

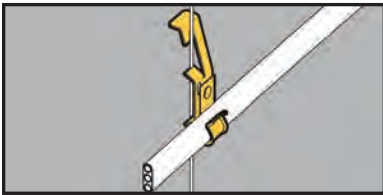

- Supports cable sizes 14/2 and 12/2 with ground wire.
- W2 series supports cable from #12 wire thru 1/4" plain or threaded rod.
- W6 series supports cable from 3/8" plain or threaded rod.

Cable Fasteners



UPC/Part Number	Catalog Number	Description	Box Qty.
78101103547	BRC3-W2	Type NM Cable To Wire Fastener	100
78101195524	BRC3-W6	Type NM Cable To Wire Fastener	100

Read safety/installation instruction sheets in packages before use.
These products are designed for positioning only. No load rating.

Conduit & Cable

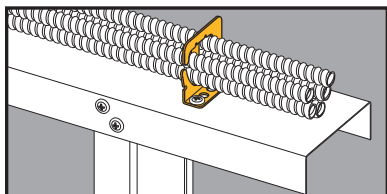

Multi-Run Cable Carrier for MC/AC Cable

- Secures and supports multiple runs of MC/AC cable as required by the NEC.
- Effectively organizes cables and eliminates derating issues.
- Retention tab is open for easy loading and unloading and contains cables when bent in place.
- Compatible with new BCH-HBA for multi tier assemblies.
- Load Capacity: 50 lbs.
- Finish: Zinc Plated



BRC5-1



BRC5-2



BRC5-3



UPC/Part Number	Catalog Number	Cable Diameter & Number Of Runs	Box Qty.
78205143593	BRC5-1	.430" to .560" Up To 4 Runs	50
78205143594	BRC5-2	.430" to .560" Up To 9 Runs	50
78205143595	BRC5-3	.560" to .690" Up To 7 Runs	50

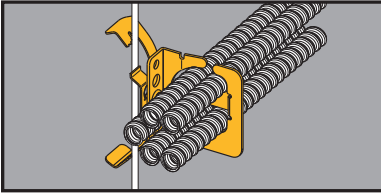

Multi-Run Cable Carrier for MC/AC Cable



- Secures and supports multiple runs of MC/AC cable as required by the NEC.
- W2 Series attaches to 1/8" thru 3/8" flanges or #12 thru 1/4" plain or threaded rod.
- W6 Series attaches to 3/8" thru 7/16" flanges or 3/8" plain or threaded rod.
- Load Capacity: 50 lbs.
- Finish: Zinc Plated



UPC/Part Number	Catalog Number	Cable Diameter & Number Of Runs	Box Qty.
78205144075	BRC51-W2	.430" to .560" Up To 4 Runs	25
78205144076	BRC52-W2	.430" to .560" Up To 9 Runs	25
78205144077	BRC53-W2	.560" to .690" Up To 7 Runs	25
78205144078	BRC51-W6	.430" to .560" Up To 4 Runs	25
78205144079	BRC52-W6	.430" to .560" Up To 9 Runs	25
78205144080	BRC53-W6	.560" to .690" Up To 7 Runs	25

Note: An independent means of support is required by NEC Article 300.11. Refer to pages 225-226 for additional support methods.

Read safety/installation instruction sheets in packages before use.
These products are designed for positioning only. No load rating.

Conduit & Cable

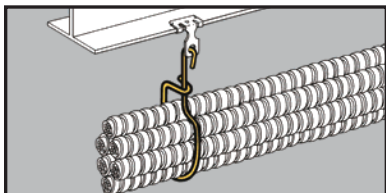

- Designed to support multiple runs of MC, AC, FMC or communication cable.
- Static Load Capacity:
BX2 - 50 lbs.
BX6 & BX24 - 75 Lbs.
- Finish: Zinc Plated

Flexible Cable Support

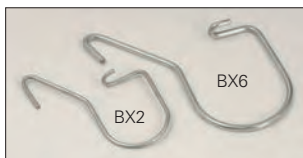

UPC/Part Number	Catalog Number	Description	Box Qty.
78205104934	BX2	Usable Area = 2 sq. in.	100
78205119765	BX6	Usable Area = 4 sq. in.	100
78205119766	BX24	Usable Area = 13 sq. in.	100

Conduit & Cable

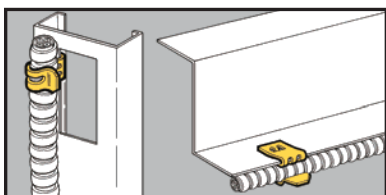

- Fastens flexible conduit and other small cables to beam flanges, bar joists or metal studs.
- Cable O.D. range of 0.42" to 0.70".
- Maximum flange thickness $5/32"$.

Flexible Conduit/Cable Fasteners



UPC/Part Number	Catalog Number	Description	Box Qty.
78101119770	BX9	Flexible Conduit Fastener	100

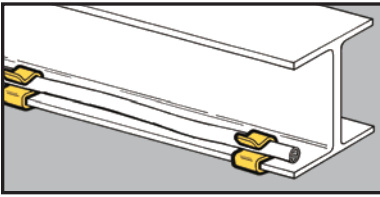

- Secures cable along flanges 1/16" to 3/4" thick.
- The BFA flange adapters attach BXS series to thicker flanges.
- BX_-67 accepts 14/2, 12/2 & 10/2 romex with ground.
- BX_-1011 accepts 14/2, 12/2 & 10/2 romex with ground.
- BX_-1214 accepts 10/3, romex with ground.
- Finish: Zinc Plated

Flexible Conduit/ Cable Fasteners

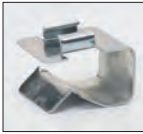

BFA Series
(For Use with
BXS Series
Only)



BXS
Series



BXL
Series

UPC/Part Number	Catalog Number	Flange Thickness	Cable Diameter	Box Qty.
78101119973	BXS-67	1/16" - 5/32"	.218 to .281	100
78101119974	BXS-89	1/16" - 5/32"	.290 to .375	100
78101119975	BXS-1011	1/16" - 5/32"	.375 to .437	100
78101119976	BXS-1214	1/16" - 5/32"	.444 to .560	100
78101119977	BXS-1519	1/16" - 5/32"	.500 to .718	100
78101119978	BXS-2024	1/16" - 5/32"	.748 to .945	100
78101119979	BXS-2530	1/16" - 5/32"	.968 to 1.250	100
78101119980	BXM-67	5/32" - 9/32"	.218 to .281	100
78101119981	BXM-89	5/32" - 9/32"	.290 to .375	100
78101119982	BXM-1011	5/32" - 9/32"	.375 to .437	100
78101119983	BXM-1214	5/32" - 9/32"	.444 to .560	100
78101119984	BXM-1519	5/32" - 9/32"	.500 to .718	100
78101119985	BXM-2024	5/32" - 9/32"	.748 to .945	100
78101119986	BXM-2530	5/32" - 9/32"	.968 to 1.250	100
78101119987	BXL-67	5/16" - 1/2"	.218 to .281	100
78101119988	BXL-89	5/16" - 1/2"	.290 to .375	100
78101119989	BXL-1011	5/16" - 1/2"	.375 to .437	100
78101119990	BXL-1214	5/16" - 1/2"	.444 to .560	100
78101119991	BXL-1519	5/16" - 1/2"	.500 to .718	100
78101119992	BXL-2024	5/16" - 1/2"	.748 to .945	100
78101119993	BXL-2530	5/16" - 1/2"	.968 to 1.250	100
78101119955	BFA-1215	1/2" - 5/8"	-	100
78101119956	BFA-1520	5/8" - 3/4"	-	100

Read safety/installation instruction sheets in packages before use.
These products are designed for positioning only. No load rating.

Conduit & Cable

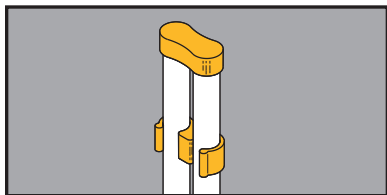

Conduit Quick Caps & Spacers



BCS & BES
8 & 8C thru 16 & 16C



BCS 18, 18C, 20, & 20C



BCS 12AS & 16AS

- Quick caps and spacers eliminate the time consuming method of duct taping conduit stubs.
- Quick spacers are designed to separate and secure conduit during concrete pours.
- Quick caps maintain spacing and keep conduit free from dirt and debris.
- Quick caps and spacers properly space conduit for any 4" square box.
- Available in EMT & Rigid conduit sizes.

UPC/Part Number	Catalog Number	Conduit Size	Box Qty.
Conduit Spacer			
78205122356	BCS-8	1/2" Rigid Conduit	50
78205140057	BES-8	1/2" EMT Conduit	50
78205122357	BCS-12	3/4" Rigid Conduit	50
78205140058	BES-12	3/4" EMT Conduit	50
78205122358	BCS-16	1" Rigid Conduit	50
78205140059	BES-16	1" EMT Conduit	50
79903855806	BCS-18	1 1/2" Rigid Conduit	25
79903855807	BCS-20	2" Rigid Conduit	25
Conduit Cap			
78205122359	BCS-8C	1/2" Rigid Conduit	50
78205140060	BES-8C	1/2" EMT Conduit	50
78205122361	BCS-12C	3/4" Rigid Conduit	50
78205140061	BES-12C	3/4" EMT Conduit	50
78205122362	BCS-16C	1" Rigid Conduit	50
78205140062	BES-16C	1" EMT Conduit	50
79903855803	BCS-18C	1 1/2" Rigid Conduit	25
79903855805	BCS-20C	2" Rigid Conduit	25
Conduit Spacer			
79903855808	BCS-12AS	3/4" Rigid Conduit	50
79903855809	BCS-16AS	1" Rigid Conduit	25

Patent #5896892

Read safety/installation instruction sheets in packages before use.
These products are designed for positioning only. No load rating.

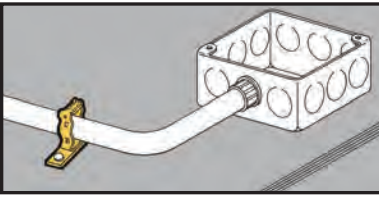

- Eliminates the need for offset bends when used with 1 1/2" deep boxes.
- Attaches conduit to concrete, steel or wood with nails.
- May be attached after conduit positioning.

Conduit Spacer Brackets



BP

UPC/Part Number	Catalog Number	Conduit Size	Box Qty.
78101118495 Patent # 4958792	BG-8-12-D3	1/2" or 3/4"	100
78101119265	BP-8-D3	1/2" EMT	100
78101118365	BP-12-D3	3/4" EMT or 1/2" IMC, Rigid	100

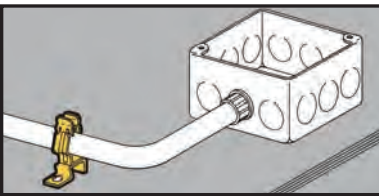

- Eliminates the need for offset bends when used with 2 1/8" deep boxes.
- Provides secure support between conduit and deck.
- D4 Series is easily installed with screw gun or powder actuated tools.
- Allows for complete conduit layout prior to anchoring.

Conduit Spacer Brackets



BP

UPC/Part Number	Catalog Number	Conduit Size	Box Qty.
78101118500 Patent # 4958792	BG-8-12-D4	1/2" or 3/4"	100
78101119270	BP-8-D4	1/2" EMT	100
78101119370	BP-12-D4	3/4" EMT or 1/2" IMC, Rigid	100
78101119460	BP-16-D4	1" EMT or 3/4" IMC, Rigid	100

Read safety/installation instruction sheets in packages before use.

Conduit & Cable

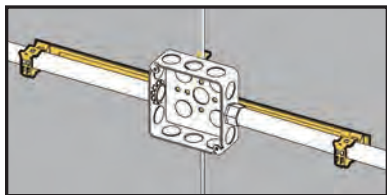

Guide-Rite™ Conduit & Box Support Fasteners



- See pages Ruff-IN™ brochure for pre-fab box assemblies.

- New BMC3 plate is available to support multiple conduit runs.
- Riveted assembly provides support for electrical boxes and conduit runs on either side of the box.
- Reduces drop wires by 66% when using W2/W6 assemblies.
- Assemblies using BMC3 plate include center conduit clip. Additional conduit clips may be purchased separately.

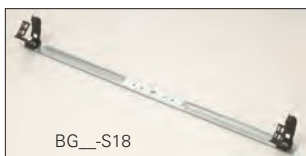

UPC/Part Number	Catalog Number	Conduit Size EMT & Rigid	Box Qty.
78101103575	BG6-S18 *	3/8"	25
78101103573	BG812-S18	1/2" or 3/4"	25
78101103574	BG16-S18	1"	25

With Multiple Conduit Plate

78205152812	BG6-S18-MC3 *	3/8"	25
78205152900	BG812-S18-MC3	1/2" or 3/4"	25
78205152901	BG16-S18-MC3	1"	25

Patent # 4958792

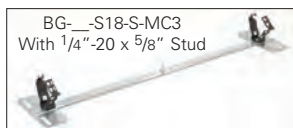
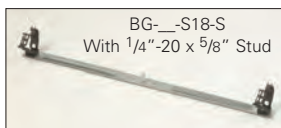

With Stud

78205152902	BG6-S18S *	3/8"	25
78110104979	BG812-S18S	1/2" or 3/4"	25
78205152903	BG16-S18S	1"	25

With Stud & Multiple Conduit Plate

78205152904	BG6-S18S-MC3 *	3/8"	25
78205152905	BG812-S18S-MC3	1/2" or 3/4"	25
78205152906	BG16-S18S-MC3	1"	25

Conduit & Cable



UPC/Part Number	Catalog Number	Conduit Size EMT & Rigid	Box Qty.
W2 Series for #12 thru 1/4" Rod **			
78101103578	BG6-S18-W2 *	3/8"	25
78101103577	BG812-S18-W2	1/2" or 3/4"	25
78101103577	BG16-S18-W2	1"	25
W2 Series for #12 thru 1/4" Rod & Multiple Conduit Plate **			
78205152855	BG6-S18-W2-MC3 *	3/8"	25
78205152739	BG812-S18-W2-MC3	1/2" or 3/4"	25
78205152862	BG16-S18-W2-MC3	1"	25
W6 Series for 3/8" Plain or Threaded Rod **			
78110199581	BG6-S18-W6 *	3/8"	25
78110199582	BG812-S18-W6	1/2" or 3/4"	25
78110199580	BG16-S18-W6	1"	25
W6 Series for 3/8" Plain or Threaded Rod & Multiple Conduit Plate **			
78205152856	BG6-S18-W6-MC3 *	3/8"	25
78205152860	BG812-S18-W6-MC3	1/2" or 3/4"	25
78205152864	BG16-S18-W6-MC3	1"	25

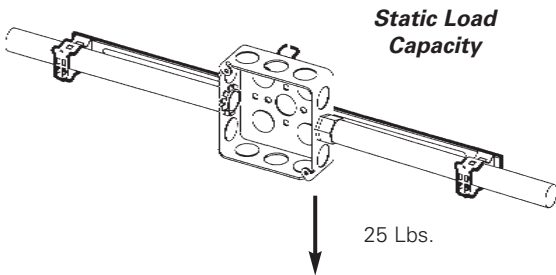

- * BG-6 will accept the following range $\varnothing.420 - \varnothing.675$:
14/2 thru 10/4 MC/AC cable and 5/16" or 3/8" flexible conduit
- ** Note: An independent means of support is required by NEC Article 300.11. Refer to pages 225-226 for additional support methods.

Read safety/installation instruction sheets in packages before use.

Conduit & Cable

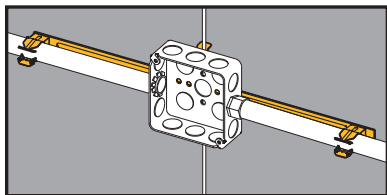

Push-Type Conduit & Box Support Fasteners

- See pages Ruff-IN™ brochure for pre-fab box assemblies.

- New BMC3 plate is available to support multiple conduit runs.
- Riveted assembly provides support for electrical boxes and conduit runs on either side of the box.
- Reduces drop wires by 66% when using W2/W6 assemblies.
- Assemblies using BMC3 plate include center conduit clip. Additional conduit clips may be purchased separately.



UPC/Part Number	Catalog Number	Conduit Size (EMT) R(Rigid)	Box Qty.
78205123604	BP8-S18	1/2" E	25
78205123605	BP12-S18	3/4" E or 1/2" R	25
78205123606	BP16-S18	1"E, 3/4" R	25

With Multiple Conduit Plate

78205152907	BP8-S18-MC3	1/2" E	25
78205152908	BP12-S18-MC3	3/4" E or 1/2" R	25
78205152909	BP16-S18-MC3	1"E, 3/4" R	25

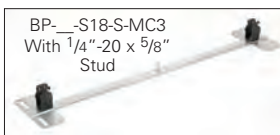
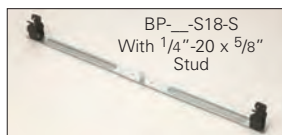

With Stud

78205123631	BP8-S18S	1/2" E	25
78205123633	BP12-S18S	3/4" E or 1/2" R	25
78205123634	BP16-S18S	1"E, 3/4" R	25

With Stud & Multiple Conduit Plate

78205152913	BP8-S18S-MC3	1/2" E	25
78205152914	BP12-S18S-MC3	3/4" E or 1/2" R	25
78205152915	BP16-S18S-MC3	1"E, 3/4" R	25

Conduit & Cable

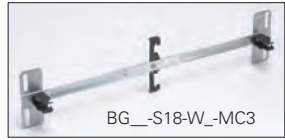

UPC/Part Number	Catalog Number	Conduit Size E(EMT) R(Rigid)	Box Qty.
W2 Series for #12 thru 1/4" Rod **			
78205123615	BP8-S18-W2	1/2" EMT	25
78205123619	BP12-S18-W2	3/4" E or 1/2" R	25
78205123627	BP16-S18-W2	1"E, 3/4" R	25
W2 Series for #12 thru 1/4" Rod & Multiple Conduit Plate **			
78205152847	BP8-S18-W2-MC3	1/2" EMT	25
78205152848	BP12-S18-W2-MC3	3/4" E or 1/2" R	25
78205152849	BP16-S18-W2-MC3	1"E, 3/4" R	25
W6 Series for 3/8" Plain or Threaded Rod **			
78205123628	BP8-S18-W6	1/2" EMT	25
78205123629	BP12-S18-W6	3/4" E or 1/2" R	25
78205123630	BP16-S18-W6	1"E, 3/4" R	25
W6 Series for 3/8" Plain or Threaded Rod & Multiple Conduit Plate **			
78205152850	BP8-S18-W6-MC3	1/2" EMT	25
78205152851	BP12-S18-W6-MC3	3/4" E or 1/2" R	25
78205152854	BP16-S18-W6-MC3	1"E, 3/4" R	25

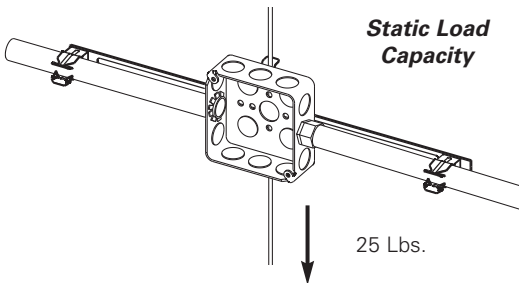

** Note: An independent means of support is required by NEC Article 300.11. Refer to pages 225-226 for additional support methods.

Conduit & Cable

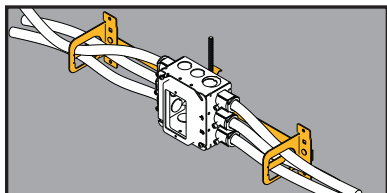

- Riveted assembly provides support for electrical boxes and cable runs on either side of the box.
- Reduces drop wires by 66% when using W2/W6 assemblies.
- Cable retention tab is open for easy loading and contains the cables when bent in place.
- See Ruff-IN™ brochure for pre-fab box assemblies.

Multi-Run Cable Carrier & Box Support Fasteners



UPC/Part Number	Catalog Number	Conduit Size	Box Qty.
78205152916	BRC51-S18	Up to 4 runs .430" - .560"	25
78205152918	BRC53-S18	Up to 7 runs .560" - .690"	25

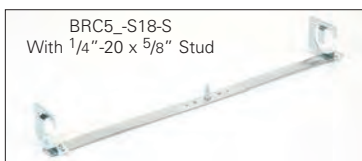

UPC/Part Number	Catalog Number	Conduit Size	Box Qty.
With Stud			
78205152919	BRC51-S18S	Up to 4 runs .430" - .560"	25
78205152921	BRC53-S18S	Up to 7 runs .560" - .690"	25

Conduit & Cable

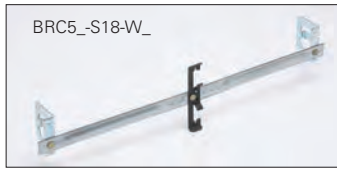

UPC/Part Number	Catalog Number	Conduit Size	Box Qty.
W2 Series for #12 thru 1/4" Rod **			
78205152865	BRC51-S18-W2	Up to 4 runs .430" - .560"	25
78205152869	BRC53-S18-W2	Up to 7 runs .560" - .690"	25

UPC/Part Number	Catalog Number	Conduit Size	Box Qty.
W6 Series for 3/8" Plain or Threaded Rod **			
78205152866	BRC51-S18-W6	Up to 4 runs .430" - .560"	25
78205152870	BRC53-S18-W6	Up to 7 runs .560" - .690"	25

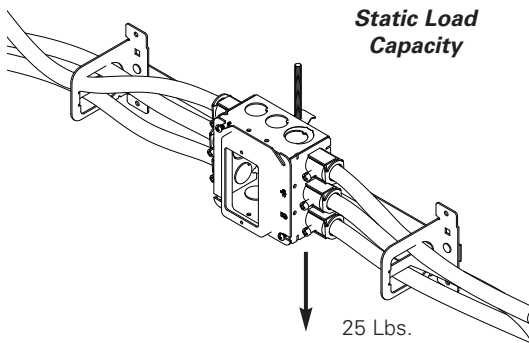

** Note: An independent means of support is required by NEC Article 300.11. Refer to pages 225-226 for additional support methods.

Read safety/installation instruction sheets in packages before use.

Acoustical Tee

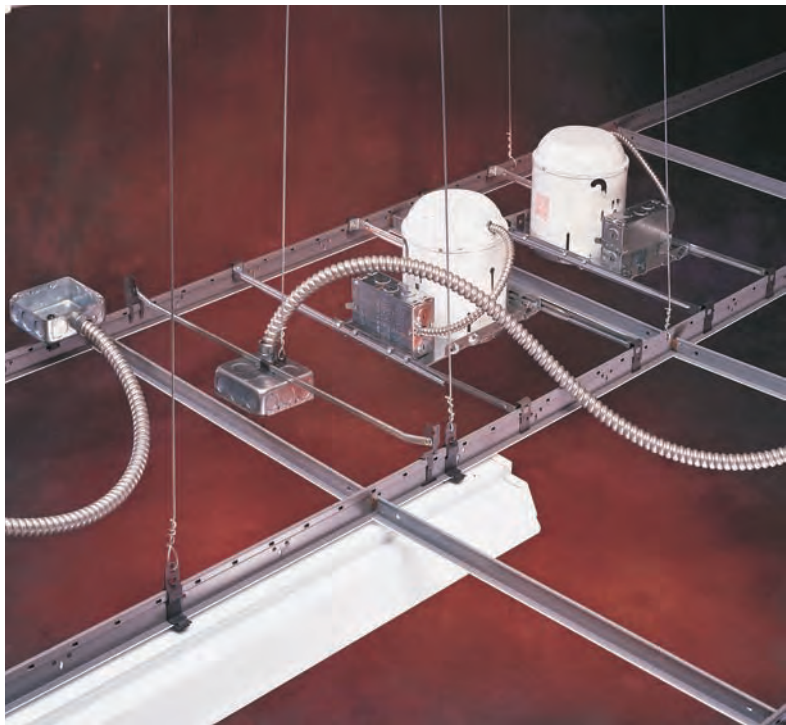

Acoustical Tee



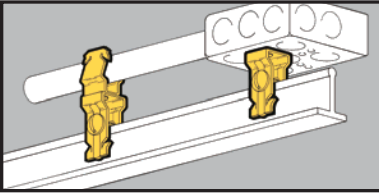

T-Bar Support Fasteners

- Attaches to top of acoustical T-Bar with 1/4"-20 screw.
- Has 1/4"-20 thread impression for attachment to box or conduit fastener.
- **Warning:** Do not use for hanging acoustical tee.



UPC/Part Number	Catalog Number	Description	Box Qty.
78101118090	BA14	T-Bar Support Clip	100

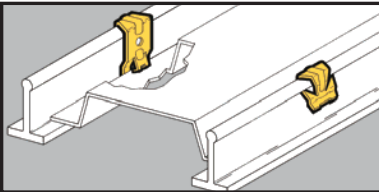

Troffer Fasteners

- Gives positive support for troffers and lay-in fixtures.
- Complies with NEC Article 410.16(C) for fixtures supported by suspended ceilings.
- Fits rectangular or round head T-Bars.
- Commonly known as "Hurricane Clip".



UPC/Part Number	Catalog Number	Description	Box Qty.
78101118095	BA15	For Straight Lip or Uprturned Lip Fixtures	100

Read safety/installation instruction sheets in packages before use.
These products are designed for positioning only. No load rating.

Acoustical Tee

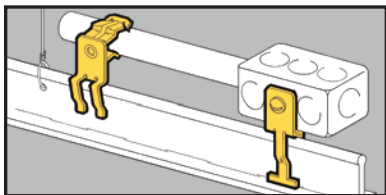

- A positive method for supporting vertical boxes, conduit or cable above T-Bar.
- Allows conduit to clear drop wires.
- **Warning:** Do not use for hanging acoustical tee.

Side Mount T-Bar Fasteners

BA5-4T



UPC/Part Number	Catalog Number	Description	Box Qty.
78101118095	BA5-4T	With 1/4"-20 Thread Impression	100

BG Series



BP Series



UPC/Part Number	Catalog Number	Conduit Size	Box Qty.
78101118410	BG-6-A5 *	3/8"	100
78101118465	BG-8-12-A5	1/2", 3/4"	100
78101118545	BG-16-A5	1"	100
Patent #4958792			
78101119235	BP-8-A5	1/2" EMT	100
78101119335	BP-12-A5	3/4" EMT	100
		1/2" IMC, Rigid	
78101118545	BP-16-A5	1" EMT	100
		3/4" IMC, Rigid	

- * BG-6 will accept the following range $\varnothing.420 - \varnothing.675$:
14/2 thru 10/4 MC/AC cable and 5/16" or 3/8" flexible conduit

Read safety/installation instruction sheets in packages before use.
These products are designed for positioning only. No load rating.

Acoustical Tee

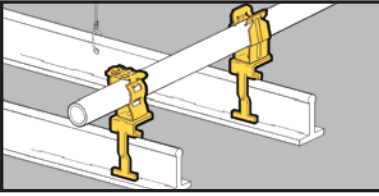

- A positive method for supporting horizontal boxes or conduit above T-Bar.
- Allows conduit to clear drop wires.
- **Warning:** Do not use for hanging acoustical tee.

Top Mount T-Bar Fasteners



UPC/Part Number	Catalog Number	Description	Box Qty.
78101118125	BA6-4T	With 1/4"-20 Thread Impression	100

BG Series



BP Series



UPC/Part Number	Catalog Number	Conduit Size	Box Qty.
78101188540	BG-6-A6 *	3/8"	100
78101118470	BG-8-12-A6	1/2", 3/4"	100
78101118550	BG-16-A6	1"	100
Patent #4958792			
78101119240	BP-8-A6	1/2" EMT	100
78101119340	BP-12-A6	3/4" EMT	100
		1/2" IMC, Rigid	
78101119435	BP-16-A6	1" EMT	100
		3/4" IMC, Rigid	

- * BG-6 will accept the following range $\varnothing.420 - \varnothing.675$:
 14/2 thru 10/4 MC/AC cable and 5/16" or 3/8" flexible conduit

Read safety/installation instruction sheets in packages before use.
 These products are designed for positioning only. No load rating.

Acoustical Tee

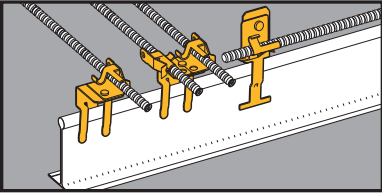

- A positive method for supporting cable or flexible conduit above T-Bar.
- Assemblies support MC, AC, sizes 14/2 through 10/3 or 3/8" FMC.

Top Mount T-Bar Fasteners

BX4-A6



BX4M-A6



UPC/Part Number	Catalog Number	Description	Box Qty.
78101101220	BX4-A6	Single Runs	100
78101101216	BX4M-A6	Double Runs	100

Note: Fasteners will rotate 360°.

BX4-A5



BX4M-A5



UPC/Part Number	Catalog Number	Description	Box Qty.
78101101187	BX4-A5	Single Runs	100
78101101211	BX4M-A5	Double Runs	100

Note: Fasteners will rotate 360°.

Read safety/installation instruction sheets in packages before use.
These products are designed for positioning only. No load rating.

Acoustical Tee

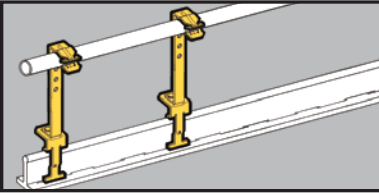

- Supports conduit and electrical boxes above T-Bar.
- Height adjusts from 4¹/₄" to 7¹/₄".
- Conduit fasteners can be attached at ³/₄" increments.
- BX4M-A28 supports cable or FMC above T-Bar.

Support Fasteners

BA28



BX4M-A28



UPC/Part Number	Catalog Number	Description	Box Qty.
78101118115	BA28	1/2" Holes Allow for Adjustment Between 4 ¹ / ₄ " and 7 ¹ / ₄ " at ³ / ₄ " Increments	50
78101101211	BX4M-A28	Double Runs MC, AC, or FMC	25

BP-12-A28



UPC/Part Number	Catalog Number	Conduit Size	Box Qty.
78101119230	BP-8-A28	1/2" EMT	100
78101119330	BP-12-A28	3/4" EMT 1/2" IMC, Rigid	100
78101119425	BP-16-A28	1" EMT 3/4" IMC, Rigid	100

Note: Adjustable BP Conduit Fastener is attached with screw in 7¹/₄" top hole position.

Read safety/installation instruction sheets in packages before use.
These products are designed for positioning only. No load rating.

Acoustical Tee

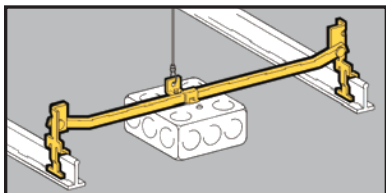

Electrical Box T-Bar Fasteners



- See BA50 for a stronger, more cost effective solution.
- Supports octagonal or square boxes.
- Allows for flush mounting or $\frac{3}{4}$ " offset for plaster ring.
- One BB27 box mounting clip with screw included with each hanger.
- Load Capacity: 20 lbs.
- For additional support, attach dropwire to BB27 box mounting clip.
- **Warning:** Do not use for hanging acoustical tee.

UPC/Part Number	Catalog Number	Description	Box Qty.
78101118080	BA12	Box Hanger 24" Span	50
78101118082	BA12-12	Box Hanger 12" Span	50
78101118085	BA120	Box Hanger 20" Span	50
78101118087	BA130	Box Hanger 30" Span	50



UPC/Part Number	Catalog Number	Description	Box Qty.
78101118170	BB27	Box Mounting Clip (with Screw)	100
78101101673	SRHMS$\frac{1}{4}$x$\frac{3}{8}$	$\frac{1}{4}$ "-20 x $\frac{3}{8}$ " Slotted Round Head Machine Screw	50

Read safety/installation instruction sheets in packages before use.

Acoustical Tee

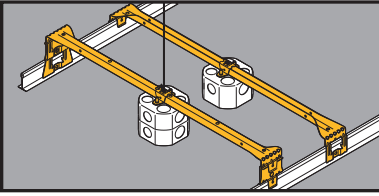

Heavy Duty Electrical Box Hanger

- Supports octagonal or square boxes on 24" span.
- Bendable ends mount 1 1/2" or 2 1/8" deep boxes without tools.
- Self-centering feature positions box on center.
- Includes BA50C4T Box Mounting Clip.
- Ultimate Static Load Capacity: 50 Lbs. (without dedicated dropwire)
- Static Load Capacity: 70 Lbs. (with dedicated dropwire) 35 Lbs. Canada
- Finish: Pre-galvanized
- See Ruff-IN™ brochure for pre-fab box assemblies.



BA50 & BA50CAN

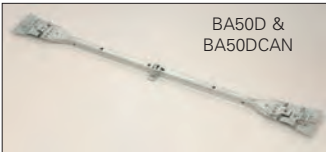

BA50D & BA50DCAN

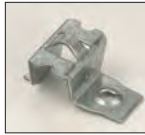

BA50C3T & BA50C4T



BA50E

UPC/Part Number	Catalog Number	Description	Box Qty.
78101196490	BA50	Box Hanger	25
78205135905	BA50CAN *	Box Hanger	25
78101196491	BA50D	Box Hanger for Box with 1 1/2" Extension	25
78205135906	BA50DCAN *	Box Hanger Box with 1 1/2" Extension	25
78205136570	BA50C4T	Box Mounting Clip with Hardware	25
78205136571	BA50C3T *	Box Mounting Clip with Hardware	25
78101196489	BA50E	Extender Brackets with Hardware	10 pair

* Canada Only

Read safety/installation instruction sheets in packages before use.

Acoustical Tee

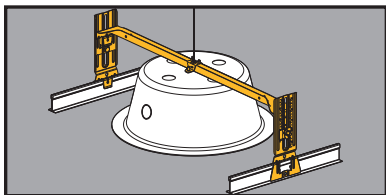

- Adjustable box support for suspended ceilings.
- Accommodates heights up to 8³/₄".
- Integral ruler enables height adjustments without measuring.

Adjustable Box Support



- Ideal for installation of speaker cases, emergency light fixtures, etc. in suspended ceilings.
- Static Load Capacity:
25 Lbs. without dedicated dropwire
70 Lbs. with dedicated dropwire
35 Lbs. (Canada) with dedicated dropwire
- See Ruff-IN™ brochure for pre-fab box assemblies.

UPC/Part Number	Catalog Number	Description	Box Qty.
78205118460	BA50A	Adjustable Box Hanger T-Bar	10

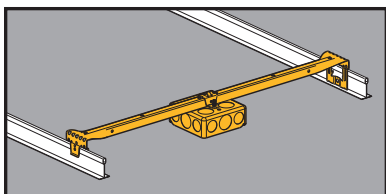

- Pre-assembled T-Bar fasteners speed installation.
- Boxes have 1/2" and 3/4" knockouts.
- Loading not to exceed 50 lbs. in U.S.A. without independent support.
35 Lbs. in Canada
- 24" span

Electrical Box T-Bar Fasteners



UPC/Part Number	Catalog Number	Description	Box Qty.
78205124855	BA50-OB-24	1 ¹ / ₂ " Deep Box to T-Bar Fastener	10
78205124856	BA50-OB-34	2 ¹ / ₈ " Deep Box to T-Bar Fastener	10
78205124857	BA50-SB-24	1 ¹ / ₂ " Deep Box to T-Bar Fastener	10
78205150954	BA50-SB-34	2 ¹ / ₈ " Deep Box to T-Bar Fastener	10

Read safety/installation instruction sheets in packages before use.

Acoustical Tee

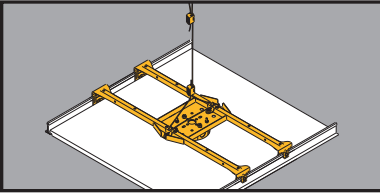

RediMount™ Fan Hanger

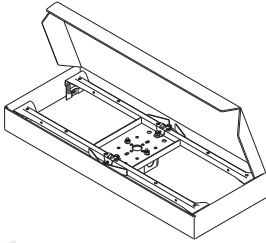

- Pre-assembled fan/ fixture hanger installs on T-Bar in less than 30 seconds.
- Positions and secures fans and fixtures in suspended ceilings.
- Includes Kwik-Wire™ cable and clamps which attach to mounting clips for easy installation.
- Recommended for use in seismic areas.
- UL Listed for fan support up to 70 lbs. or fixture support up to 90 lbs. 35 Lbs. Canada
- Finish: Pre-galvanized

UPC/Part Number	Catalog Number	Description	Box Qty.
78101196492	BA50F	Fan/Fixture Hanger Includes 4" x 11/2" Deep Octagon Box	1

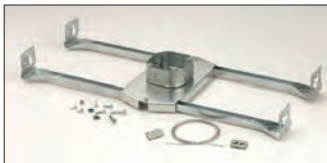
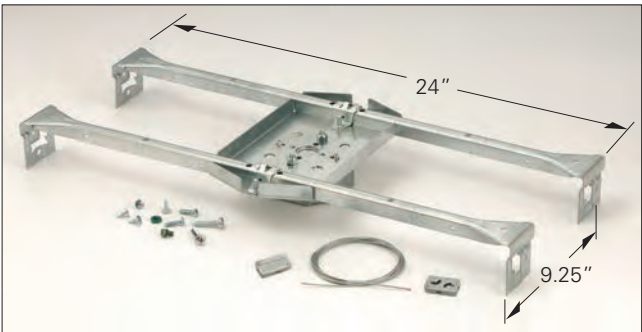

Acoustical Tee

Read safety/installation instruction sheets in packages before use.

Acoustical Tee

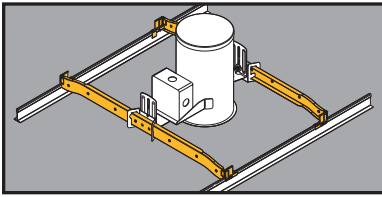

QuikFix™ Fastening System



- New QuikFix™ Fastening System mounts spec grade downlights 50% faster than “wire bound” installation methods.
- QuikFix™ System is pre-sized for 24" spacing.
- No tools required.
- Recommended for use in seismic areas.
- UL listed for fixture support up to 50 lbs.



UPC/Part Number	Catalog Number	Description	Box Qty.
78205199873	BA40	Fixture Bar	20 pair

Patent # 6286265

- Innovative design features offset bar hangers with integral locking tabs that secure downlights to T-Bar and prevent lifting or sliding.

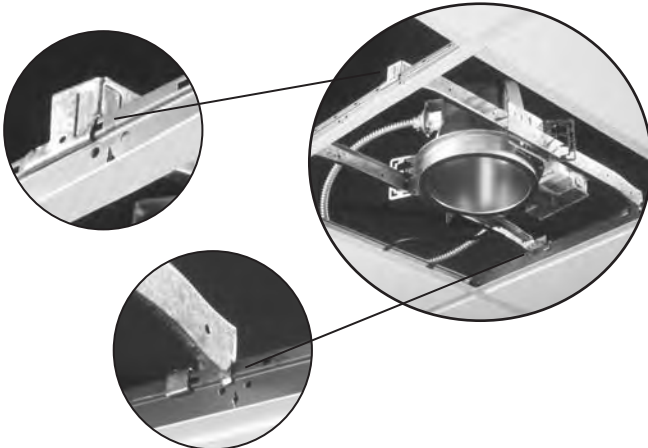

Read safety/installation instruction sheets in packages before use.

Acoustical Tee

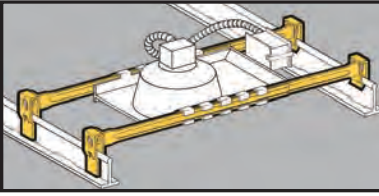

- Adjustable span from 20" to 30".
- Fits horizontal and vertical flanges.
- Fixture position is adjustable.
- No center clips or tools required.
- One set completes one fixture installation (four bars per set).

Light Fixture T-Bar Fasteners

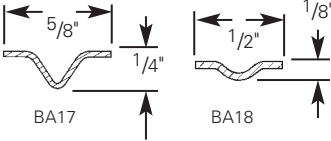

UPC/Part Number	Catalog Number	"High Hat" Fixtures	Box Qty.
78101118100	BA17 (Wide Bar)	CAPRI ¹ R-9X, R-10X CAPRI ¹ R-10X CAPRI ¹ PR-751CX HALO ² H7, HALO ² H17 JUNO ³ AP, APT JUNO ³ IC, ICT, J, SC, TC THOMAS ⁴ RI-C	10 sets
78101118105	BA18 (Narrow Bar)	CAPRI ¹ HSG LIGHTOLIER ⁵ 711	10 sets

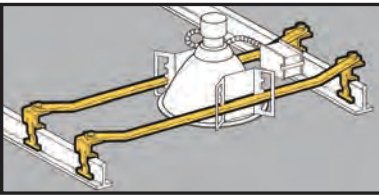

- Fixture position is adjustable within the span of the hanger.
- Fixed span of 24 inches for T-Bar applications.
- Requires only a screwdriver to install.
- One set completes one fixture installation (four bars per set).

Light Fixture T-Bar Fasteners



UPC/Part Number	Catalog Number	"High Hat" Fixtures	Box Qty.
78101118110	BA20 (Wide Bar)	Fits LIGHTOLIER ⁵ CALCULITE ⁵ Fixtures	10 sets

1. CAPRI is a mark used by Thomas Industries, Inc., Louisville, KY.
 2. HALO[®] is the registered trademark of Cooper Industries, Elk Grove, IL.
 3. JUNO[®] is the registered trademark of JUNO Lighting, Inc., Morton Grove, IL.
 4. THOMAS[®] is the registered trademark of Thomas Industries, Inc., Louisville, KY.
 5. LIGHTOLIER[®] and CALCULITE[®] are the registered trademarks of Lightolier, Inc., Secaucus, NJ.

Read safety/installation instruction sheets in packages before use.

Acoustical Tee



- Allows for independent suspension of fixtures.
- Fits most acoustical T-Bars.
- BA-4-WN wing nut included with all 1/4"-20 suspension hangers.
- Static Load Capacity: 65 Lbs.

Suspension Fasteners

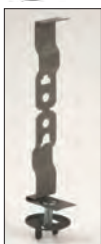

BA1



BA1-T



BA1-T-BN

UPC/Part Number	Catalog Number	T-Bar Size	Stud Size	Box Qty.
78101118065	BA1	15/16"	1/4"-20 x 5/8"	100
78101118070	BA1-24	15/16"	1/4"-20 x 1 1/2"	100
78101118075	BA1-32	15/16"	1/4"-20 x 2"	100
78101102891	BA1-T	15/16"	#8-32 x 5/8" with Pal Nut	100
78101102897	BA1-T-BN	15/16"	#8-32 x 5/8" with Brass Nut	100

BA1-9



BA1-95



UPC/Part Number	Catalog Number	T-Bar Size	Stud Size	Box Qty.
78205125585	BA1-9	9/16"	1/4"-20 x 5/8"	100
78205125587	BA1-95	9/16" & 15/16"	1/4"-20 x 5/8"	100

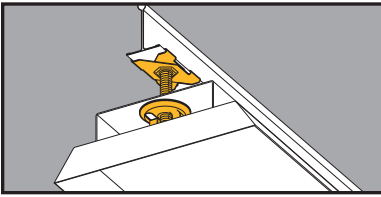

T-Bar Scissor Fasteners

- Supports electrical fixtures from standard $1\frac{5}{16}$ " T-Bars.
- BA-4-WN wing nut included.
- $\frac{1}{4}$ "-20 stud available in varying lengths.
- Static Load Capacity: 50 Lbs.



UPC/Part Number	Catalog Number	Stud Length	Box Qty.
78101104258	BAX-4-16	$\frac{5}{8}$ "	100
78101104262	BAX-4-16-24	$1\frac{1}{2}$ "	100
78101104263	BAX-4-16-32	2"	100
78101104264	BAX-4-16-48	3"	100

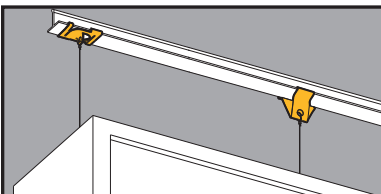

Sign Hangers

- BA-4-16-H supports signs from $1\frac{5}{16}$ " T-Bar.
- BA-4-16-H1 supports signs from $\frac{9}{16}$ " or $1\frac{5}{16}$ " T-Bar.
- Static Load Capacity: 40 Lbs.



BA-4-16-H



BA-4-16-H1

UPC/Part Number	Catalog Number	Stud Length	Box Qty.
78101118040	BA-4-16-H	Sign Hanger with White Finish	100
78101104449	BA-4-16-H1	Sign Hanger with Zinc Plated Finish	100

Read safety/installation instruction sheets in packages before use.

Acoustical Tee

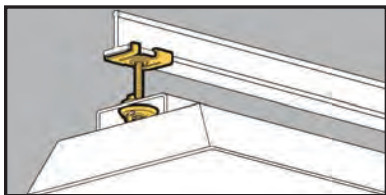

- Supports electrical fixtures from 15/16" T-Bar.
- 1/4"-20 stud available in varying lengths.
- Includes BA-4-WN wing nut with impression.
- Static Load Capacity:
BA4-16 Series = 50 lbs.
BA4-WN Series = 100 lbs.

15/16" Twist Fasteners



BA-4-WN

UPC/Part Number	Catalog Number	Finish	Stud Length	Box Qty.
78101118020	BA-4-16	Black	5/8"	100
78101118055	BA-4-16-W	White	5/8"	100
78101118025	BA-4-16-24	White	1 1/2"	100
78101118030	BA-4-16-32	White	2"	100
78101118035	BA-4-16-48	White	3"	100
78101118060	BA-4-WN	Black		100

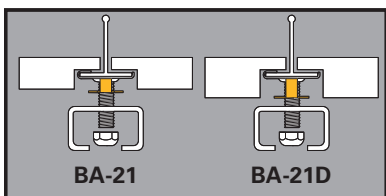

- T-Bar spacer provides flush mounting surface for tegular tile installations.
- Spacer must be used in combination with B-Line's BA-4-16 or BA-2-16 series fasteners.
- Finish: Zinc Plated

T-Bar Spacers



BA-21

BA-21D

UPC/Part Number	Catalog Number	Description	Box Qty.
78101195575	BA-21	1/4" Spacer	100
78101199567	BA-21D	3/8" Spacer	100

Acoustical Tee

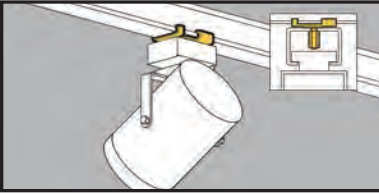

- Supports electrical fixtures from 15/16" T-Bar.
- #8-32 stud available in varying lengths.
- Static Load Capacity: 25 Lbs.

15/16" Twist Fasteners



UPC/Part Number	Catalog Number	Finish	Stud Length	Box Qty.
78101118000	BA-2-16	Black	5/8" with Pal Nut	100
78101104259	BA-2-16-7	Black	7/16" with Pal Nut	100
78101118010	BA-2-16-W	White	5/8" with Pal Nut	100
78101104261	BA-2-16-7-W	White	7/16" with Pal Nut	100



UPC/Part Number	Catalog Number	Finish	Stud Length	Box Qty.
78101118015	BA-2-16-BN	Black	5/8" with Brass Nut	100
78101104260	BA-2-16-7-BN	Black	7/16" with Brass Nut	100
78101118015	BA-2-16-WBN	White	5/8" with Brass Nut	100
78101199566	BA-2-16-7-WBN	White	7/16" with Brass Nut	100

Read safety/installation instruction sheets in packages before use.

Acoustical Tee

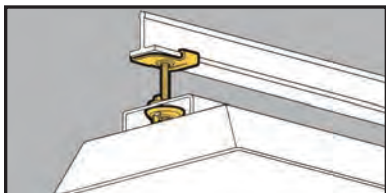

- Supports electrical fixtures from 9/16" T-Bar.
- Stud size: 1/4"-20 x 5/8".
- Static Load Capacity: 40 Lbs.

9/16" Twist Fasteners



UPC/Part Number	Catalog Number	Finish	Stud Length	Box Qty.
78101103458	BA-4-9	Black	5/8"	100
78101103461	BA-4-9-W	White	5/8"	100



- Supports electrical fixtures and track lighting from 9/16" T-Bar.
- Stud size: #8-32 x length.
- Static Load Capacity: 25 Lbs.

9/16" Twist Fasteners

BA-2-9 Series with Pal Nut



BA-2-9-BN Series with Brass Nut



UPC/Part Number	Catalog Number	Finish	Stud Length	Box Qty.
78101103467	BA-2-9	Black	5/8"	100
78101103466	BA-2-9-7	Black	7/16"	100
78101103459	BA-2-9-W	White	5/8"	100
78101103465	BA-2-9-BN	Black	5/8"	100
78101103464	BA-2-9-7-BN	Black	7/16"	100
78101103460	BA-2-9-WBN	White	5/8"	100

Read safety/installation instruction sheets in packages before use.

Acoustical Tee

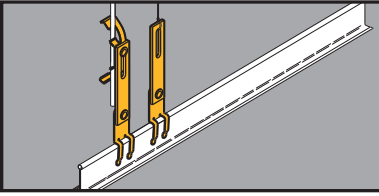

Drop Wire/Rod Securing Clip

- Secures independent support wires to ceiling grid as required by NEC Article 300.11.
- Slotted design permits adjustment when securing rods.
- Bright yellow color, Per NEC 300.11 (A), is easily identified by inspectors.



BA-311



BA-311-W2 Shown

UPC/Part Number	Catalog Number	Description	Box Qty.
78101199569	BA311	#12 thru #8 Wire	100
78101199570	BA311-W2	#12 thru 1/4" Plain or	100
78101199571	BA311-W6	3/8" Plain or Threaded Rod	100

Read safety/installation instruction sheets in packages before use.

Acoustical Tee



Seismic Fixture Clamps

- BA-SFC Series provides seismic restraint for light fixtures within a suspended ceiling.
- BA-SFC reduces labor by attaching light fixtures to the T-bar frame and eliminating extra drop wires or chains.
- Provides positive attachment of fixtures to ceiling grid members, in compliance with ICBO Acceptance Criteria 184 (AC 184).
- Satisfies NEC 410.16(C) which requires positive attachment for secure fastening of luminaires.
- Load rating: 200 lbs.

UPC/Part Number	Catalog Number	Description	Box Qty.
78205145911	BA-SFC	Seismic Fixture Clamp attaches one standard 2' x 4' light fixture to T-Bar ceiling	25 sets (4 clamps per set)
78205145912	BA-SFC-E*	For attachment of two standard 2' x 4' light fixtures end-to-end onto T-Bar ceiling	25 sets (4 clamps per set)
78205145913	BA-SFC-S*	For attachment of two standard 2' x 4' light fixtures side-by-side onto T-Bar ceiling	25 sets (4 clamps per set)
78205145914	BA-SFC-CF*	For attachment of standard 2' x 2' light fixtures onto T-Bar	50 sets (2 clamps per set)
78205145915	BA-SFC-CFS	Seismic Fixture Clamp for reinforcement of main runner connection points	50 sets (2 clamps per set)

* BASFC is required to complete installation.

Seismic Fixture Clamps cont.



BA-SFC

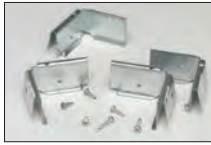

BA-SFC-E

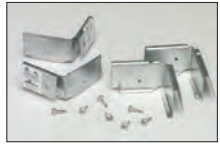

BA-SFC-S

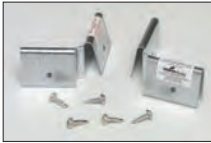

BA-SFC-CF

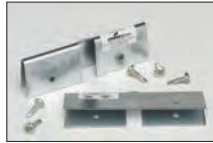

BA-SFC-CFS

Single Fixture
Installation

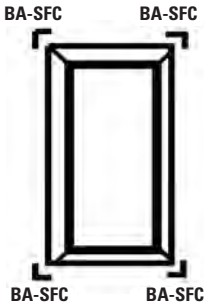

Parts Required:
1 pc. BA-SFC Installation Kit

Two Fixtures (Side by Side)

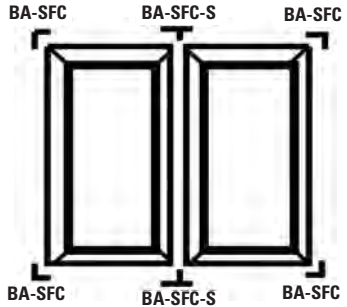

Parts Required:
1 pc. BA-SFC Installation Kit
1 pc. BA-SFC-S Installation Kit

Two Fixtures (End to End)

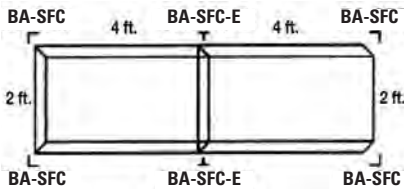

Parts Required:
1 pc. BA-SFC Installation Kit
1 pc. BA-SFC-E Installation Kit



Beams

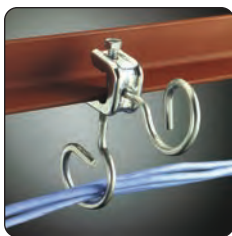
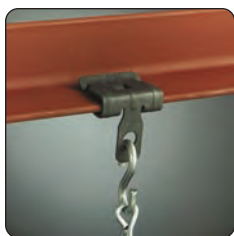

Beams

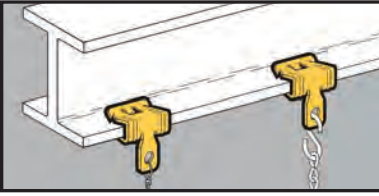

- Permits fast and easy installation on bulb tees and beams.
- Clearance hole for 1/4" bolt in tab.
- Simply installed with a hammer.

Flange Beam Fasteners



UPC/Part Number	Catalog Number	Flange Thickness	Static Load Cap.	Box Qty.
78101118290	BE-1-2	3/32" - 9/64"	160 lbs.	100



BE-2-4

UPC/Part Number	Catalog Number	Flange Thickness	Static Load Cap.	Box Qty.
78101118295	BE-2-4	1/8" - 1/4"	200 lbs.	100
78101118300	BE-5-8	5/16" - 1/2"	200 lbs.	100
78101118305	BE-9-12	9/16" - 3/4"	200 lbs.	100

Read safety/installation instruction sheets in packages before use.

Beams



- Quickly attaches conduit to beams.
- Fasteners will rotate 360°.
- Simply installed with a hammer.

Push-Type Conduit To Beam Fasteners



UPC/Part Number	Catalog Number	Conduit Size	Flange Thickness	Box Qty.
78101119275	BP-8-E-2-4	1/2" EMT	1/8" - 1/4"	100
78101119280	BP-8-E-5-8	1/2" EMT	5/16" - 1/2"	100
78101119285	BP-8-E-9-12	1/2" EMT	9/16" - 3/4"	100
78101119375	BP-12-E-2-4	1/2" EMT 1/2" IMC, Rigid	1/8" - 1/4"	100
78101119380	BP-12-E-5-8	1/2" EMT 1/2" IMC, Rigid	5/16" - 1/2"	100
78101119385	BP-12-E-9-12	1/2" EMT 1/2" IMC, Rigid	9/16" - 3/4"	100
78101119465	BP-16-E-2-4	1" EMT 3/4" IMC, Rigid	1/8" - 1/4"	100
78101119470	BP-16-E-5-8	1" EMT 3/4" IMC, Rigid	5/16" - 1/2"	100
78101119475	BP-16-E-9-12	1" EMT 3/4" IMC, Rigid	9/16" - 3/4"	100

**Ultimate
Static Load
Capacity**

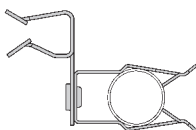

15 Lbs.



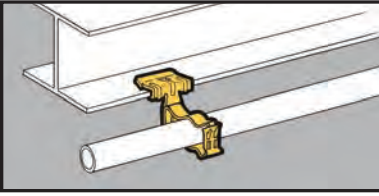

- Unique Guide-Rite Fastener provides for fast and easy installation.
- Fasteners will rotate 360°.
- Simply installed with a hammer and pliers.

Guide-Rite™ Conduit To Beam Fasteners



UPC/Part Number	Catalog Number	Conduit Size	Flange Thickness	Box Qty.
78101118430	BG-6-E-2-4	3/8"	1/8" - 1/4"	100
78101118435	BG-6-E-5-8	3/8"	5/16" - 1/2"	100
78101118440	BG-6-E-9-12	3/8"	9/16" - 3/4"	100
78101118505	BG-8-12-E-2-4	1/2", 3/4"	1/8" - 1/4"	100
78101118510	BG-8-12-E-5-8	1/2", 3/4"	5/16" - 1/2"	100
78101118515	BG-8-12-E-9-12	1/2", 3/4"	9/16" - 3/4"	100
78101118575	BG-16-E-2-4	1"	1/8" - 1/4"	100
78101118580	BG-16-E-5-8	1"	5/16" - 1/2"	100
78101118585	BG-16-E-9-12	1"	9/16" - 3/4"	100
78101118660	BG-20-E-2-4	1 1/4"	1/8" - 1/4"	100
78101118665	BG-20-E-5-8	1 1/4"	5/16" - 1/2"	100
78101118670	BG-20-E-9-12	1 1/4"	9/16" - 3/4"	100
78101118705	BG-24-E-2-4	1 1/2"	1/8" - 1/4"	50
78101118710	BG-24-E-5-8	1 1/2"	5/16" - 1/2"	50
78101118715	BG-24-E-9-12	1 1/2"	9/16" - 3/4"	50
78101118745	BG-32-E-2-4	2"	1/8" - 1/4"	50
78101118750	BG-32-E-5-8	2"	5/16" - 1/2"	50
78101118755	BG-32-E-9-12	2"	9/16" - 3/4"	50

Patent #4958792

- * BG-6 will accept the following range $\varnothing.420$ - $\varnothing.675$:
14/2 thru 10/4 MC/AC cable
and 5/16 or 3/8 flexible conduit

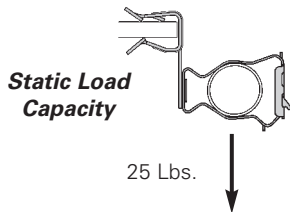

Read safety/installation instruction sheets in packages before use.

Beams

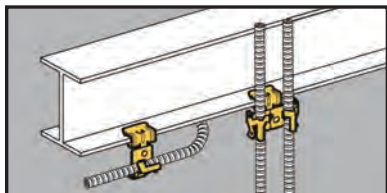

- Attaches MC, AC, sizes 14/2 through 10/3 or 3/8" FMC to beam flanges 1/8" to 3/4" thick.
- Fasteners will rotate 360°.
- Simply installed with a hammer.

Cable To Beam Fasteners



UPC/Part Number	Catalog Number	Types Of Runs	Flange Thickness	Box Qty.
78101101192	BX4-E-2-4	Single	1/8" - 1/4"	100
78101101193	BX4-E-5-8	Single	5/16" - 1/2"	100
78101101194	BX4-E-9-12	Single	9/16" - 3/4"	100



UPC/Part Number	Catalog Number	Types Of Runs	Flange Thickness	Box Qty.
78101101213	BX4M-E-2-4	Double	1/8" - 1/4"	100
78101101214	BX4M-E-5-8	Double	5/16" - 1/2"	100
78101101215	BX4M-E-9-12	Double	5/16" - 3/4"	100

Read safety/installation instruction sheets in packages before use.

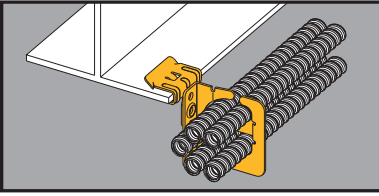

MC/AC Cable Carrier to Beam Fastener



BRC5-2-E24



- Secures and supports MC/AC cables as required by the NEC.
- Effectively organizes cables and eliminates derating issues.
- BRC5-1 secures up to four (4) runs of .430 to .560 diameter cable.
- BRC5-2 secures up to nine (9) runs of .430 to .560 diameter cable.
- BRC5-3 secures up to seven (7) runs of .560 to .690 diameter cable.
- Load Capacity: 50 lbs.

UPC/Part Number	Catalog Number	Flange Thickness	Box Qty.
78205144093	BRC51-E12	3/32" - 9/64"	25
78205144096	BRC51-E24	1/8" - 1/4"	25
78205144099	BRC51-E58	5/16" - 1/2"	25
78205144102	BRC51-E912	9/16" - 3/4"	25
78205144094	BRC52-E12	3/32" - 9/64"	25
78205144097	BRC52-E24	1/8" - 1/4"	25
78205144100	BRC52-E58	5/16" - 1/2"	25
78205144103	BRC52-E912	9/16" - 3/4"	25
78205144095	BRC53-E12	3/32" - 9/64"	25
78205144098	BRC53-E24	1/8" - 1/4"	25
78205144101	BRC53-E58	5/16" - 1/2"	25
78205144104	BRC53-E912	9/16" - 3/4"	25

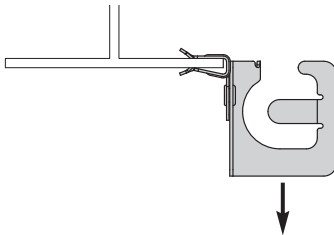

Static Load Capacity

50 Lbs.

Read safety/installation instruction sheets in packages before use.

Beams

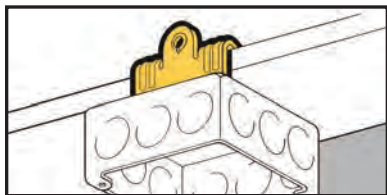

- Suspend boxes or fixtures from beam flanges 1/8" to 3/4" thick.
- Provided with 1/4"-20 thread impression for quick and secure attachment.
- Simply installed with a hammer.

Universal Beam Fasteners



UPC/Part Number	Catalog Number	Flange Thickness	Box Qty.
78101119600	BU-2-4	1/8" - 1/4"	100
78101119605	BU-5-8	5/16" - 1/2"	100
78101119610	BU-9-12	9/16" - 3/4"	100



1/4"-20 x 3/8"
Staked Stud

UPC/Part Number	Catalog Number	Flange Thickness	Box Qty.
78101119615	BU-2-4-S	1/8" - 1/4"	100
78101119620	BU-5-8-S	5/16" - 1/2"	100
78101119625	BU-9-12-S	9/16" - 3/4"	100

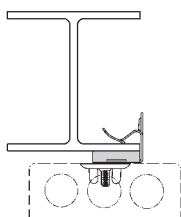
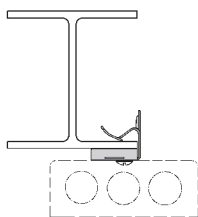

Static Load Capacity

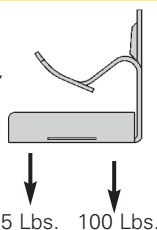

Note: Indicated loads are static load capacity and should not be combined.

Read safety/installation instruction sheets in packages before use.
These products are designed for positioning only. No load rating.

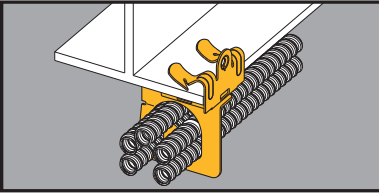

MC/AC Cable Carrier to Beam Fastener



- Secures and supports MC/AC cables as required by the NEC.
- Effectively organizes cables and eliminates derating issues.
- BRC5-1 secures up to four (4) runs of .430 to .560 diameter cable.
- BRC5-2 secures up to nine (9) runs of .430 to .560 diameter cable.
- BRC5-3 secures up to seven (7) runs of .560 to .690 diameter cable.
- Load Capacity: 50 lbs.

UPC/Part Number	Catalog Number	Flange Thickness	Box Qty.
78205144066	BRC51-U24	1/8" - 1/4"	25
78205144069	BRC51-U58	5/16" - 1/2"	25
78205144072	BRC51-U912	9/16" - 3/4"	25
78205144067	BRC52-U24	1/8" - 1/4"	25
78205144070	BRC52-U58	5/16" - 1/2"	25
78205144073	BRC52-U912	9/16" - 3/4"	25
78205144068	BRC53-U24	1/8" - 1/4"	25
78205144071	BRC53-U58	5/16" - 1/2"	25
78205144074	BRC53-U912	9/16" - 3/4"	25

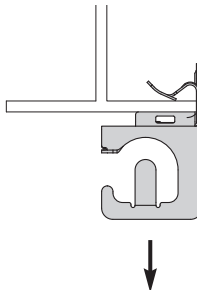

Static Load Capacity

75 Lbs.

Read safety/installation instruction sheets in packages before use.

Beams

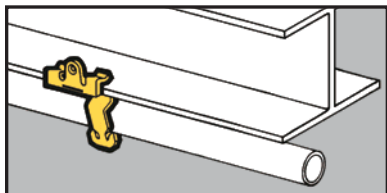

- Quickly attaches conduit to beams.
- Fasteners will rotate 360°.
- Simply installed with a hammer.

Push-Type Conduit To Beam Fasteners



UPC/Part Number	Catalog Number	Conduit Size	Flange Thickness	Box Qty.
78101119310	BP-8-U-2-4	1/2" EMT	1/8" - 1/4"	100
78101119315	BP-8-U-5-8	1/2" EMT	5/16" - 1/2"	100
78101119320	BP-8-U-9-12	1/2" EMT	9/16" - 3/4"	100
78101119405	BP-12-U-2-4	3/4" EMT 1/2" IMC, Rigid	1/8" - 1/4"	100
78101119410	BP-12-U-5-8	3/4" EMT 1/2" IMC, Rigid	5/16" - 1/2"	100
78101119415	BP-12-U-9-12	3/4" EMT 1/2" IMC, Rigid	9/16" - 3/4"	100
78101119490	BP-12-U-2-4	1" EMT 3/4" IMC, Rigid	1/8" - 1/4"	100
78101119495	BP-12-U-5-8	1" EMT 3/4" IMC, Rigid	5/16" - 1/2"	100
78101119500	BP-12-U-9-12	1" EMT 3/4" IMC, Rigid	9/16" - 3/4"	100

**Ultimate
Static Load
Capacity**

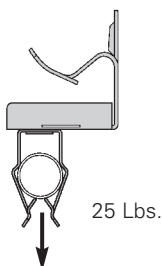

Read safety/installation instruction sheets in packages before use.
These products are designed for positioning only. No load rating.



- Unique Guide-Rite Fastener provides for fast and easy installation.
- Fasteners will rotate 360°.
- Simply installed with a hammer and pliers.

Guide-Rite™ Conduit To Beam Fasteners



UPC/Part Number	Catalog Number	Conduit Size	Flange Thickness	Box Qty.
78101118450	BG-6-U-2-4	3/8"	1/8" - 1/4"	100
78101118455	BG-6-U-5-8	3/8"	5/16" - 1/2"	100
78101118460	BG-6-U-9-12	3/8"	9/16" - 3/4"	100
78101118525	BG-8-12-U-2-4	1/2", 3/4"	1/8" - 1/4"	100
78101118530	BG-8-12-U-5-8	1/2", 3/4"	5/16" - 1/2"	100
78101118535	BG-8-12-U-9-12	1/2", 3/4"	9/16" - 3/4"	100
78101118625	BG-16-U-2-4	1"	1/8" - 1/4"	100
78101118630	BG-16-U-5-8	1"	5/16" - 1/2"	100
78101118635	BG-16-U-9-12	1"	9/16" - 3/4"	100
78101118680	BG-20-U-2-4	1 1/4"	1/8" - 1/4"	100
78101118685	BG-20-U-5-8	1 1/4"	5/16" - 1/2"	100
78101118690	BG-20-U-9-12	1 1/4"	9/16" - 3/4"	100
78101118720	BG-24-U-2-4	1 1/2"	1/8" - 1/4"	50
78101118725	BG-24-U-5-8	1 1/2"	5/16" - 1/2"	50
78101118730	BG-24-U-9-12	1 1/2"	9/16" - 3/4"	50
78101118760	BG-32-U-2-4	2"	1/8" - 1/4"	50
78101118765	BG-32-U-5-8	2"	5/16" - 1/2"	50
78101118770	BG-32-U-9-12	2"	9/16" - 3/4"	50

Patent #4958792

- * BG-6 will accept the following range $\varnothing.420$ - $\varnothing.675$:
14/2 thru 10/4 MC/AC cable
and 5/16 or 3/8 flexible conduit

**Static Load
Capacity**

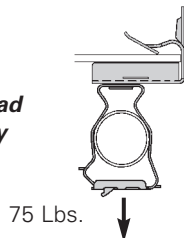

Beams

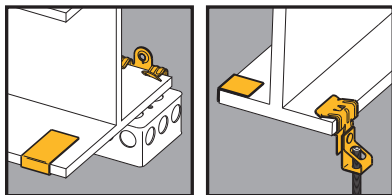

- Anchor strap provides secure attachment to beam flanges.
- Suspends threaded rod from beam flanges.
- 8" anchor straps are provided for 1/8" to 1/4" thick flanges.
- 13" anchor straps are provided for 5/16" to 3/4" thick flanges.

Beam Fasteners With Anchor Straps



Static Load Capacity

75 Lbs.



UPC/Part Number	Catalog Number	Stud Size	Flange Thickness	Box Qty.
78101104942	BU-2-4-S-AS	1/4"-20 x 3/8"	1/8" - 1/4"	50
78101104943	BU-5-8-S-AS	1/4"-20 x 3/8"	5/16" - 1/2"	50
78101104944	BU-9-12-S-AS	1/4"-20 x 3/8"	9/16" - 3/4"	50



Static Load Capacity

160 Lbs.



UPC/Part Number	Catalog Number	Threaded Rod Size	Flange Thickness	Box Qty.
78101104948	BH4-E-2-4-AS	1/4"-20	1/8" - 1/4"	50
78101104949	BH4-E-5-8-AS	1/4"-20	5/16" - 1/2"	50
78101104950	BH4-E-9-12-AS	1/4"-20	9/16" - 3/4"	50
78101104951	BH6-E-2-4-AS	3/8"-16	1/8" - 1/4"	50
78101104952	BH6-E-5-8-AS	3/8"-16	5/16" - 1/2"	50
78101104953	BH6-E-9-12-AS	3/8"-16	9/16" - 3/4"	50

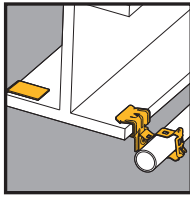
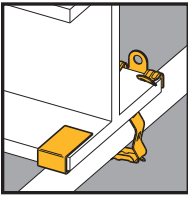

- Anchor strap provides secure attachment to beam flanges.
- Unique Guide-Rite™ Fastener provides for fast and easy installation.
- 8" anchor straps are provided for 1/8" to 1/4" thick flanges.
- 13" anchor straps are provided for 5/16" to 3/4" thick flanges.

Conduit To Beam Fasteners With Anchor Straps



Static Load Capacity

75 Lbs.

UPC/Part Number	Catalog Number	Conduit Size	Flange Thickness	Box Qty.
78101104966	BG-8-12-U-2-4-AS	1/2", 3/4"	1/8" - 1/4"	50
78101104967	BG-8-12-U-5-8-AS	1/2", 3/4"	5/16" - 1/2"	50
78101104968	BG-8-12-U-9-12-AS	1/2", 3/4"	9/16" - 3/4"	50
78101104969	BG-16-U-2-4-AS	1"	1/8" - 1/4"	50
78101104970	BG-16-U-5-8-AS	1"	5/16" - 1/2"	50
78101104971	BG-16-U-9-12-AS	1"	9/16" - 3/4"	50



Static Load Capacity

25 Lbs.



UPC/Part Number	Catalog Number	Conduit Size	Flange Thickness	Box Qty.
78101104972	BG-8-12-E-2-4-AS	1/2", 3/4"	1/8" - 1/4"	50
78101104973	BG-8-12-E-5-8-AS	1/2", 3/4"	5/16" - 1/2"	50
78101104974	BG-8-12-E-9-12-AS	1/2", 3/4"	9/16" - 3/4"	50
78101104975	BG-16-E-2-4-AS	1"	1/8" - 1/4"	50
78101104976	BG-16-E-5-8-AS	1"	5/16" - 1/2"	50
78101104977	BG-16-E-9-12-AS	1"	9/16" - 3/4"	50

Read safety/installation instruction sheets in packages before use.

Beams



- Attaches MC, AC, sizes 14/2 through 10/3 or 3/8" FMC to flanges 1/8" to 3/4" thick.
- Fasteners will rotate 360°.

Cable To Beam Fasteners



UPC/Part Number	Catalog Number	Description	Flange Thickness	Box Qty.
78101101197	BX4-U-2-4	Single Runs	1/8" - 1/4"	100
78101101198	BX4-U-5-8	Single Runs	5/16" - 1/2"	100
78101101199	BX4-U-9-12	Single Runs	9/16" - 3/4"	100



UPC/Part Number	Catalog Number	Description	Flange Thickness	Box Qty.
78101101206	BX4M-U-2-4	Double Runs	1/8" - 1/4"	100
78101101207	BX4M-U-5-8	Double Runs	5/16" - 1/2"	100
78101101208	BX4M-U-9-12	Double Runs	9/16" - 3/4"	100

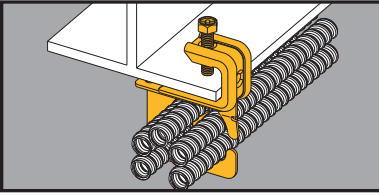

MC/AC Cable Carrier to Beam Fastener

- Secures and supports MC/AC cables as required by the NEC.
- Effectively organizes cables and eliminates derating issues.
- Fits beam flanges from 1/8" thru 5/8" thick.
- Load Capacity: 50 lbs.



BRC5-1-C442



UPC/Part Number	Catalog Number	Cable Diameter & Number of Runs	Box Qty.
78205144087	BRC51-C442	.430" to .560" Up to 4 Runs	25
78205144088	BRC52-C442	.430" to .560" Up to 9 Runs	25
78205144089	BRC53-C442	.560" to .690" Up to 7 Runs	25

Read safety/installation instruction sheets in packages before use.

Beams

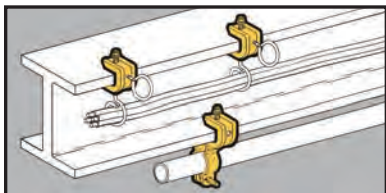

- BC442 fits beam flanges 1/8" to 5/8". BC442-6 fits beam flanges up to 3/4".
- Finish: Zinc Plated
- Static Load Capacity: BC442 = 100 Lbs. BC442-6 = 200 Lbs.

Beam Fasteners



UPC/Part Number	Catalog Number	Description	Box Qty.
78101118278	BC442	Accepts 1/4"-20 Threaded Rod or 1/4"-20 Threaded Bridle Rings	50
78101104283	BC442-6	Accepts 3/8"-16 Threaded Rod	25



UPC/Part Number	Catalog Number	Conduit Size		Box Qty.
		Rigid	EMT	
78101119850	BL1400-C442	1/2"	1/2"	50
78101119851	BL1410-C442	3/4"	3/4"	50
78101119852	BL1420-C442	1"	1"	50
78101119853	BL1425-C442	–	1 1/4"	50
78101119854	BL1430-C442	1 1/4"	1 1/2"	50
78101119855	BL1440-C442	1 1/2"	–	25
78101119856	BL1450-C442	2"	2"	25

Read safety/installation instruction sheets in packages before use. These products are designed for positioning only. No load rating.

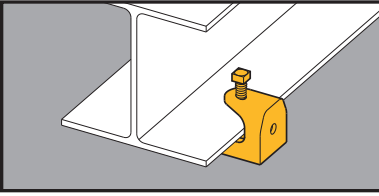

- Can be used with 1/4"-20 and 3/8"-16 threaded rod or bridle rings.
- Fits beam flanges through 1/2" thick.
- Safety Factor of 5.
- Finish: Zinc-Plated

Beam Fasteners



UPC/Part Number	Catalog Number	Rod Size	Static Load Cap.	Box Qty.
78101155333	B444-1/4	1/4"-20	150 lbs.	50
78101155333	B444-5/16	5/16"-18	150 lbs.	50
78101155333	B444-3/8	3/8"-16	150 lbs.	50

Read safety/installation instruction sheets in packages before use.

Beams

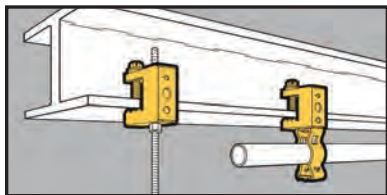

- Fits beam flanges thru 1/2" thick.
- Accepts "S" hooks, 1/4" and 3/8" threaded rod, 1/4"-20 or #10-24 threaded bridle rings.
- Supports conduit and electrical boxes.

Conduit To Beam Fasteners



UPC/Part Number	Catalog Number	Flange Thickness	Static Load Cap.	Box Qty.
78101118275	BC1	Thru 1/42	100 lbs.	100

Guide-Rite™
Fastener



UPC/Part Number	Catalog Number	Conduit Size EMT & Rigid	Static Load Cap.	Box Qty.
78101118490	BG-8-12-C2	1/2", 3/4"	100 lbs.	100
78101118570	BG-16-C2	1"	100 lbs.	100
78101118655	BG-20-C2	1 1/4"	100 lbs.	100
78101118700	BG-24-C2	1 1/2"	100 lbs.	100
78101118740	BG-32-C2	2"	100 lbs.	100

Read safety/installation instruction sheets in packages before use.

Conduit To Beam Fasteners



Guide-Rite™
Fastener



UPC/Part Number	Catalog Number	Conduit Size EMT & Rigid	Static Load Cap.	Box Qty.
78101118485	BG-8-12-C1	1/2", 3/4"	25 lbs.	100
78101118565	BG-16-C1	1"	25 lbs.	100
78101118650	BG-20-C1	1 1/4"	25 lbs.	100
78101118695	BG-24-C1	1 1/2"	25 lbs.	50
78101118735	BG-32-C1	2"	25 lbs.	50



Push-Type

UPC/Part Number	Catalog Number	Conduit Size	Ultimate Static Load Cap.	Box Qty.
78101119260	BP-8-C2	1/2" EMT	25 lbs.	100
78101119360	BP-12-C2	3/4" EMT 1/2" IMC, Rigid	25 lbs.	100
78101119455	BP-16-C2	1" EMT 3/4" IMC, Rigid	25 lbs.	100



Push-Type

UPC/Part Number	Catalog Number	Conduit Size	Ultimate Static Load Cap.	Box Qty.
78101119255	BP-8-C1	1/2" EMT	25 lbs.	100
78101119355	BP-12-C1	3/4" EMT 1/2" IMC, Rigid	25 lbs.	100
78101119450	BP-16-C1	1" EMT 3/4" IMC, Rigid	25 lbs.	100

Read safety/installation instruction sheets in packages before use.

Beams

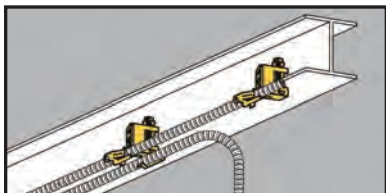

- Attaches MC, AC, sizes 14/2 through 10/3 or 3/8" FMC to beam flanges thru 1/2" thick.
- Fasteners will rotate 360°.
- Requires only a screwdriver to install.

Cable To Beam Fasteners



BX4-C2



BX4M-C2



UPC/Part Number	Catalog Number	Flange Thickness	Box Qty.
78101101190	BX4-C2	Single Runs	100
78101101210	BX4M-C2	Double Runs	100

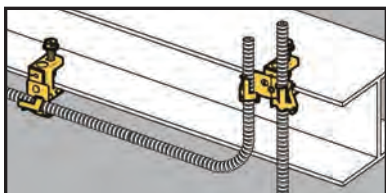

- Attaches MC, AC, sizes 14/2 through 10/3 or 3/8" FMC to beam flanges thru 1/2" thick.
- Fasteners will rotate 360°.
- Requires only a screwdriver to install.

Cable To Beam Fasteners



BX4-C1



BX4M-C1



UPC/Part Number	Catalog Number	Flange Thickness	Box Qty.
78101101191	BX4-C1	Single Runs	100
78101101209	BX4M-C1	Double Runs	100

Read safety/installation instruction sheets in packages before use. These products are designed for positioning only. No load rating.

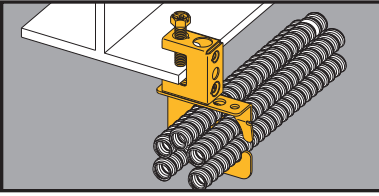

MC/AC Cable Carrier to Beam Fastener

- Secures and supports MC/AC cables as required by the NEC.
- Effectively organizes cables and eliminates derating issues.
- Fits beam flanges thru 1/2" thick.
- Load Capacity: 50 lbs.



BRC5-x-C2



UPC/Part Number	Catalog Number	Cable Diameter & Number of Runs	Box Qty.
78205144090	BRC51-C2	.430" to .560" Up to 4 Runs	25
78205144091	BRC52-C2	.430" to .560" Up to 9 Runs	25
78205144092	BRC53-C2	.560" to .690" Up to 7 Runs	25

Read safety/installation instruction sheets in packages before use.

Beams

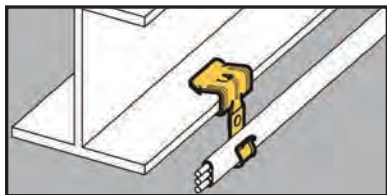

- Attaches Type NM cable to beam flanges 1/8" to 1/2" thick.
- Supports cable sizes 14/2 and 12/2 with ground wire.
- Simply installed with a hammer.

Cable To Beam Fasteners



UPC/Part Number	Catalog Number	Flange Thickness	Box Qty.
78101103550	BRC3-E-2-4	1/8" to 1/4"	100
78101103551	BRC3-E-5-8	5/16" to 1/2"	100
78101103552	BRC3-E-9-12	9/16" to 3/4"	100

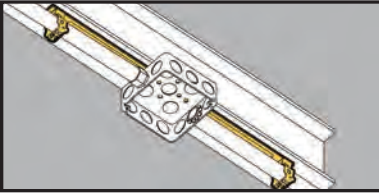

Guide-Rite™ Conduit & Box Support Fasteners



- See Ruff-IN™ brochure for pre-fab box assemblies.

- New BMC3 plate is available to support multiple conduit runs.
- Riveted assembly secures electrical boxes and conduit runs to beam flanges 1/8" to 1/2" thick.
- Provides support for conduit on either side of electrical box.
- Assemblies using BMC3 plate include center conduit clamp. Additional conduit clamps may be purchased separately.

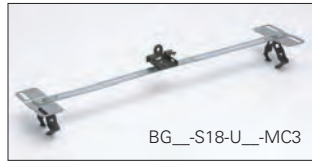

UPC/Part Number	Catalog Number	Conduit Size	Flange Thickness	Box Qty.
78101103583	BG6-S18-U24 *	3/8"	1/8" to 1/4"	25
78101103584	BG6-S18-U58 *	3/8"	5/16" to 1/2"	25
78101103579	BG812-S18-U24	1/2", 3/4"	1/8" to 1/4"	25
78101103580	BG812-S18-U58	1/2", 3/4"	5/16" to 1/2"	25
78101103581	BG16-S18-U24	1"	1/8" to 1/4"	25
78101103582	BG16-S18-U58	1"	5/16" to 1/2"	25

Patent #4958792

With Multiple Conduit Plate

78205152813	BG6-S18-U24-MC3 *	3/8"	1/8" to 1/4"	25
78205152814	BG6-S18-U58-MC3 *	3/8"	5/16" to 1/2"	25
78205152815	BG812-S18-U24-MC3	1/2", 3/4"	1/8" to 1/4"	25
78205152816	BG812-S18-U58-MC3	1/2", 3/4"	5/16" to 1/2"	25
78205152817	BG16-S18-U24-MC3	1"	1/8" to 1/4"	25
78205152823	BG16-S18-U58-MC3	1"	5/16" to 1/2"	25

- * BG-6 will accept the following range $\varnothing.420 - \varnothing.675$:
14/2 thru 10/4 MC/AC cable and 5/16 or 3/8 flexible conduit

Beams

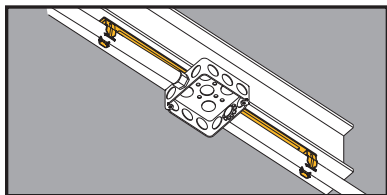

Push-Type Conduit & Box Support Fasteners

- See Ruff-IN™ brochure for pre-fab box assemblies.

- New BMC3 plate is available to support multiple conduit runs.
- Riveted assembly secures electrical boxes and conduit runs to beam flanges 1/8" to 1/2" thick.
- Provides support for conduit on either side of electrical box.
- Assemblies using BMC3 plate include center conduit clamp. Additional conduit clamps may be purchased separately.

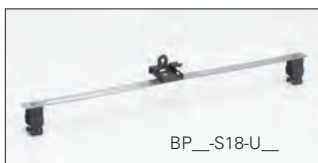

BP__S18-U__

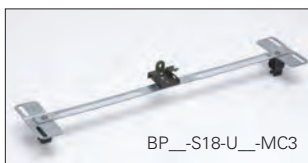

BP__S18-U__-MC3

UPC/Part Number	Catalog Number	Conduit Size EMT, IMC, Rigid	Flange Thickness	Box Qty.
78205123635	BP8-S18-U24	3/8"	1/8" to 1/4"	25
78205123638	BP8-S18-U58	3/8"	5/16" to 1/2"	25
78205123636	BP12-S18-U24	1/2", 3/4"	1/8" to 1/4"	25
78205123639	BP12-S18-U58	1/2", 3/4"	5/16" to 1/2"	25
78205123637	BP16-S18-U24	1"	1/8" to 1/4"	25
78205123640	BP16-S18-U58	1"	5/16" to 1/2"	25

Patent #4958792

With Multiple Conduit Plate

78205152824	BP8-S18-U24-MC3	3/8"	1/8" to 1/4"	25
78205152825	BP8-S18-U58-MC3	3/8"	5/16" to 1/2"	25
78205152827	BP12-S18-U24-MC3	1/2", 3/4"	1/8" to 1/4"	25
78205152828	BP12-S18-U58-MC3	1/2", 3/4"	5/16" to 1/2"	25
78205152825	BP16-S18-U24-MC3	1"	1/8" to 1/4"	25
78205152964	BP16-S18-U58-MC3	1"	5/16" to 1/2"	25

Read safety/installation instruction sheets in packages before use.
These products are designed for positioning only. No load rating.

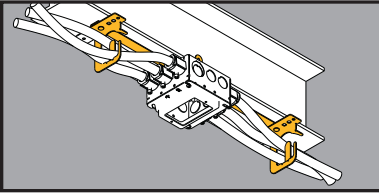

Multi-Run Cable Carrier & Box Support Fastener

- Riveted assembly provides support for electrical box and cable run on either side of box.
- Cable retention tab is open for easy loading and contains cable when bent in place.
- See Ruff-IN™ brochure for pre-fab box assemblies.



BRC5_S18-U__

UPC/Part Number	Catalog Number	Conduit Size Number of Runs	Flange Thickness	Box Qty.
78205152829	BRC51-S18-U24	.430" - .560" Up to 4 Runs	1/8" to 1/4"	25
78205152830	BRC51-S18-U58	.560" - .690" Up to 7 Runs	5/16" to 1/2"	25
78205152834	BRC53-S18-U24	.430" - .560" Up to 4 Runs	1/8" to 1/4"	25
78205152835	BRC53-S18-U58	.560" - .690" Up to 7 Runs	5/16" to 1/2"	25

Read safety/installation instruction sheets in packages before use.

Hangers



Hangers

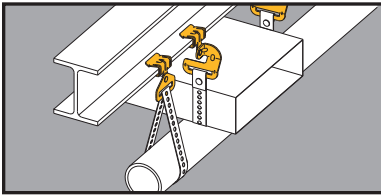

- Suspends straps thru 1 1/2" wide from beam flanges 1/8" to 3/4" thick.
- Suspends straps parallel or at right angles to beams.
- Simply installed with a hammer.
- Static Load Capacity: 200 Lbs.

Strap Hangers



Parallel



Right Angle

UPC/Part Number	Catalog Number	Description	Flange Thickness	Box Qty.
78101104930	BHE-1-2	Parallel	1/16" to 1/8"	100
78101118870	BH-2-4	Parallel	1/8" to 1/4"	100
78101118880	BH-5-8	Parallel	5/16" to 1/2"	100
78101118890	BH-9-12	Parallel	9/16" to 3/4"	100
78101104115	BH-1-2-R	Right Angle	1/16" to 1/8"	100
78101118875	BH-2-4-R	Right Angle	1/8" to 1/4"	100
78101118885	BH-5-8-R	Right Angle	5/16" to 1/2"	100
78101118895	BH-9-12-R	Right Angle	9/16" to 3/4"	100

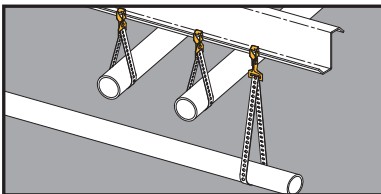

"Z" Purlin Hangers



BH-F12



BH-F12-R

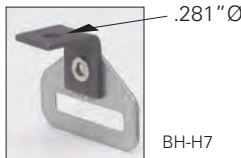

BH-H7



UPC/Part Number	Catalog Number	Description	Box Qty.
78101103385	BH-F12	Right Angle	100
78101103384	BH-F12-R	Parallel	100
78101119922	BH-H7	Parallel	100

Read safety/installation instruction sheets in packages before use.

Hangers

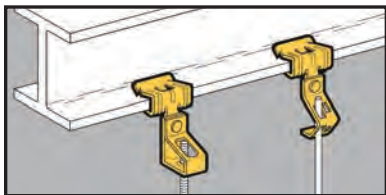

- Suspend wire or plain and threaded rod from beam flanges 1/8" to 3/4" thick.
- Simply installed with a hammer.
- Static Load Capacity: 160 Lbs.

Rod To Beam Hangers



UPC/Part Number	Catalog Number	Flange Thickness	Description	Box Qty.
78101118900	BH1-E-2-4	1/8" to 1/4"	#8 Wire or 1/4" Plain Rod	100
78101118905	BH1-E-5-8	5/16" - 1/2"	#8 Wire or 1/4" Plain Rod	100
78101118910	BH1-E-9-12	9/16" - 3/4"	#8 Wire or 1/4" Plain Rod	100

UPC/Part Number	Catalog Number	Flange Thickness	Plain Rod Size	Box Qty.
78101118940	BH2-E-2-4	1/8" to 1/4"	3/8"	100
78101118945	BH2-E-5-8	5/16" - 1/2"	3/8"	100
78101118950	BH2-E-9-12	9/16" - 3/4"	3/8"	100

Rod To Beam Hangers



With Thread Impression



UPC/Part Number	Catalog Number	Flange Thickness	Threaded Rod Size	Box Qty.
78101118980	BH4-E-2-4	1/8" to 1/4"	1/4"	100
78101118985	BH4-E-5-8	5/16" - 1/2"	1/4"	100
78101118990	BH4-E-9-12	9/16" - 3/4"	1/4"	100
78101119060	BH6-E-2-4	1/8" to 1/4"	3/8"	100
78101119065	BH6-E-5-8	5/16" - 1/2"	3/8"	100
78101119070	BH6-E-9-12	9/16" - 3/4"	3/8"	100

Note: BH4 and BH6 have thread impressions.

UPC/Part Number	Catalog Number	Flange Thickness	Threaded Rod Size	Box Qty.
78101119020	BH5-E-2-4 *	1/8" to 1/4"	1/4" to 3/8"	100
78101119025	BH5-E-5-8 *	5/16" - 1/2"	1/4" to 3/8"	100
78101119030	BH5-E-9-12 *	9/16" - 3/4"	1/4" to 3/8"	100

*Nuts Required.

Hangers

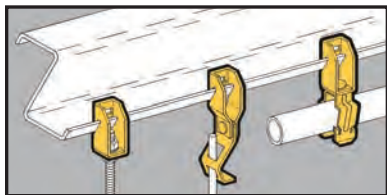

"Z" Purlin Hangers

- Compensates for angle of purlin lip.
- Allows for parallel conduit runs or vertical support drops.
- Riveted fasteners will rotate 360°.
- Maximum Purlin thickness of $\frac{3}{32}$ ".

BF13



BF12



UPC/Part Number	Catalog Number	Description	Static Load Cap. Lbs.	Box Qty.
78101118345	BF13	With $\frac{1}{4}$ " Hole	100	100
78101118340	BF12	For "S" Hooks	100	100



Guide-Rite™
Fastener
BG Series



Push-Type
BP Series

UPC/Part Number	Catalog Number	Conduit Size EMT & Rigid	Static Load Cap. Lbs.	Box Qty.
78101118445	BG-6-F13 *	$\frac{3}{8}$ "	100	100
78101118520	BG-8-12-F13	$\frac{1}{2}$ ", $\frac{3}{4}$ "	100	100
78101118590	BG-16-F13	1"	100	100
78101118675	BG-20-F13	$1\frac{1}{4}$ "	100	100
78101119290	BP-8-F13	$\frac{1}{2}$ " EMT	25	100
78101119390	BP-12-F13	$\frac{3}{4}$ " EMT $\frac{1}{2}$ " IMC, Rigid	25	100
78101119480	BP-16-F13	1" EMT $\frac{3}{4}$ " IMC, Rigid	25	50

* BG-6 will accept the following range $\varnothing.420 - \varnothing.675$:
 $1\frac{1}{2}$ thru $10\frac{1}{4}$ MC/AC cable and $\frac{5}{16}$ or $\frac{3}{8}$ flexible conduit

Read safety/installation instruction sheets in packages before use.

Universal Beam Fasteners



UPC/Part Number	Catalog Number	Description	Static Load Cap.	Box Qty.
78101118920	BH1-F12	#8 Wire or 1/4" Plain Rod	100 Lbs.	100
78101118960	BH2-F12	3/8" Plain Rod	100 Lbs.	100



UPC/Part Number	Catalog Number	Threaded Rod Size	Static Load Cap.	Box Qty.
78101119000	BH4-F12	1/4"	100 Lbs.	100
78101119080	BH6-F12	3/8"	100 Lbs.	100
78101119040	BH5-F12 *	1/4" & 3/8"	100 Lbs.	100

*Nuts Required.

Note: BH4 and BH6 have thread impressions.

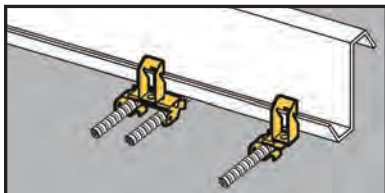

Cable To "Z" Purlin Flange Hangers

- Compensates for angle of purlin lip.
- Attaches MC, AC, sizes 14/2 through 10/3 or 3/8" FMC to "Z" Purlins up to 3/32" thick.
- Fastener will rotate 360°.
- Simply installed with a hammer.



BX4-F13



BX4M-F13



UPC/Part Number	Catalog Number	Description	Flange Thickness	Box Qty.
78101101188	BX4-F13	Single Runs	Thru 3/32"	100
78101101204	BX4M-F13	Double Runs	Thru 3/32"	100

Read safety/installation instruction sheets in packages before use.

Hangers

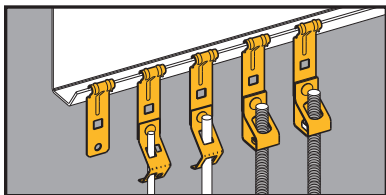

"Z" Purlin Flange Hangers

- Suspend wire, or plain and threaded rod from "Z" Purlins.
- Fits "Z" Purlins 1/16" to 1/4" thick.
- Simply installed with a hammer.
- Static Load Capacity: 160 Lbs.



UPC/Part Number	Catalog Number	Description	Box Qty.
78101104271	BF4	For "S" Hooks, Bolting Straps and Wrap Wire	100

"Z" Purlin Flange Hangers



UPC/Part Number	Catalog Number	Description	Box Qty.
78101104274	BH1-F4	#8 Wire or 1/4" Plain Rod	100
78101104276	BH2-F4	3/8" Plain Rod	100



UPC/Part Number	Catalog Number	Threaded Rod Size	Box Qty.
78101104286	BH4-F4	1/4"	100
78101104280	BH6-F4	3/8"	100
78101104278	BH5-F4 *	1/4" - 3/8"	100

* Nuts required.

Note: BH4 & BH6 have thread impressions.

Hangers

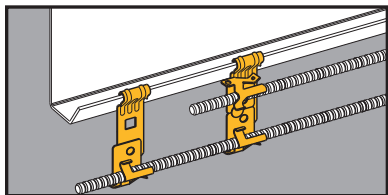

- Attaches MC, AC, sizes 14/2 thru 10/3 or 3/8" FMC to "Z" Purlins.
- Fits "Z" Purlin flanges 1/16" to 1/4" thick.
- Fastener will rotate 360°.

Cable To "Z" Purlin Flange Hangers



UPC/Part Number	Catalog Number	Description	Box Qty.
78101104931	BX4-F4	Single Runs	100

These products are designed for positioning only. No load rating.



UPC/Part Number	Catalog Number	Description	Box Qty.
78101104932	BX4M-F4	Double Runs	100

These products are designed for positioning only. No load rating.

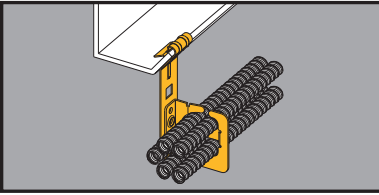

MC/AC Cable Carrier to 'Z' Purlin Flange Hanger

- Secures and supports multiple runs of MC/AC cable to 'Z' purlins.
- Effectively organizes cables and eliminates derating issues.
- Retention tab is open for easy loading and unloading and contains cables when bent in place.
- Load Capacity: 50 lbs.



UPC/Part Number	Catalog Number	Cable Diameter & Number of Runs	Box Qty.
78205144084	BRC51-F4	.430" to .560" Up to 4 Runs	25
78205144085	BRC52-F4	.430" to .560" Up to 9 Runs	25
78205144086	BRC53-F4	.560" to .690" Up to 7 Runs	25

Read safety/installation instruction sheets in packages before use.

Hangers

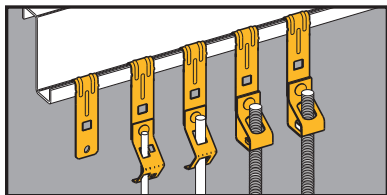

- Suspend wire, or plain and threaded rod from vertical flanges.
- Fits vertical flanges 1/16" to 1/4" thick.
- Static Load Capacity: 160 Lbs.

Vertical Flange Hangers



UPC/Part Number	Catalog Number	Description	Box Qty.
78101104270	BF3	For "S" Hooks, Bolting Straps and Wrap Wire	100

Vertical Flange Hangers



UPC/Part Number	Catalog Number	Description	Box Qty.
78101104273	BH1-F3	#8 Wire or 1/4" Plain Rod	100
78101104275	BH2-F3	3/8" Plain Rod	100



4 1/4"
Overall Height

UPC/Part Number	Catalog Number	Threaded Rod Size	Box Qty.
78101104285	BH4-F3	1/4"	100
78101104279	BH6-F3	3/8"	100
78101104933	BH5-F3 *	1/4", 3/8"	100

* Nuts required.

Read safety/installation instruction sheets in packages before use.

Hangers

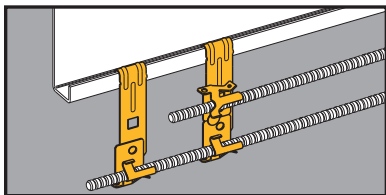

Cable To Vertical Flange Hangers

- Attaches MC, AC, sizes 14/2 through 10/3 or 3/8" flexible conduit FMC to vertical flanges 1/16" to 1/4" thick.
- Fastener will rotate 360°.
- Simply installed with a hammer.



UPC/Part Number	Catalog Number	Description	Box Qty.
78101104281	BX4-F3	Single Runs	100

This product is designed for positioning only. No load rating.



UPC/Part Number	Catalog Number	Description	Box Qty.
78101104282	BX4M-F3	Double Runs	100

This product is designed for positioning only. No load rating.

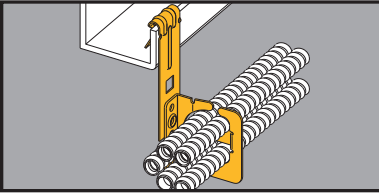

MC/AC Cable Carrier To Vertical Flange Hanger

- Secures and supports multiple runs of MC/AC cable to vertical flanges.
- Effectively organizes cables and eliminates derating issues.
- Retention tab is open for easy loading and unloading and contains cables when bent in place.
- Load Capacity: 50 lbs.



UPC/Part Number	Catalog Number	Cable Diameter & Number of Runs	Box Qty.
78205144081	BRC51-F3	.430" to .560" Up to 4 Runs	25
78205144084	BRC52-F3	.430" to .560" Up to 9 Runs	25
78205144083	BRC53-F3	.560" to .690" Up to 7 Runs	25

Hangers

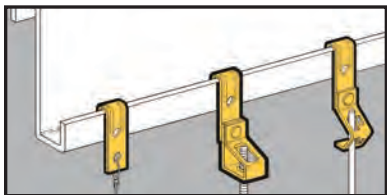

- Suspend wire, or plain or threaded rod from vertical flanges.
- Fits vertical flanges 1/16" to 1/4" thick.
- Static Load Capacity: 160 Lbs.

Vertical Flange Hangers



UPC/Part Number	Catalog Number	Flange Thickness	Description	Box Qty.
78101118310	BF1	1/16" - 5/32"	For "S" Hooks, Bolting Straps and Wrap Wire	100
78101118315	BF2	5/32" - 1/4"	For "S" Hooks, Bolting Straps and Wrap Wire	100



UPC/Part Number	Catalog Number	Flange Thickness	Description	Box Qty.
78101118915	BH1-F1	1/16" - 5/32"	#8 Wire or 1/4" Plain Rod	100
78101118925	BH1-F2	5/32" - 1/4"	#8 Wire or 1/4" Plain Rod	100

Vertical Flange Hangers



UPC/Part Number	Catalog Number	Flange Thickness	Plain Rod Size	Box Qty.
78101118955	BH2-F1	1/16" - 5/32"	3/8"	100
78101118965	BH2-F2	5/32" - 1/4"	3/8"	100



UPC/Part Number	Catalog Number	Flange Thickness	Threaded Rod Size	Box Qty.
With Thread Impression				
78101118995	BH4-F1	1/16" - 5/32"	1/4"	100
78101119075	BH6-F1	1/16" - 5/32"	3/8"	100
78101119005	BH4-F2	5/32" - 1/4"	1/4"	100
78101119085	BH6-F2	5/32" - 1/4"	3/8"	100

With Clearance Hole

78101118995	BH5-F1 *	1/16" - 5/32"	1/4", 3/8"	100
78101119075	BH5-F2 *	5/32" - 1/4"	1/4", 3/8"	100

* Nuts required.

Hangers

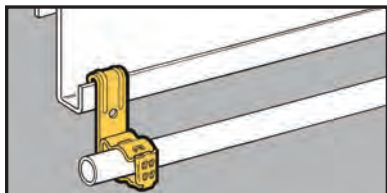

- Supports 3/8" to 1" conduit from vertical flanges 1/16" to 1/4" thick.
- Patented Guide-Rite™ feature ensures fastener will close and lock every time.
- Simply installed with a hammer and pliers.
- Static Load Capacity: 25 Lbs.

Conduit To Vertical Flange Hangers



Guide-Rite™
Fastener



UPC/Part Number	Catalog Number	Conduit Size	Flange Thickness	Box Qty.
78101119957	BG-6-F1 *	3/8"	1/16" - 5/32"	100
78101119960	BG-6-F2 *	3/8"	5/32" - 1/4"	100
78101119958	BG-8-12-F1	1/2" & 3/8"	1/16" - 5/32"	100
78101119961	BG-8-12-F2	1/2" & 3/8"	5/32" - 1/4"	100
78101119958	BG-16-F1	1"	1/16" - 5/32"	100
78101119961	BG-16-F2	1"	5/32" - 1/4"	100

Patent #4958792

* BG-6 will accept the following range $\varnothing.420 - \varnothing.675$:
14/2 thru 10/4 MC/AC cable and 5/16 or 3/8 flexible conduit



UPC/Part Number	Catalog Number	Wire Size	Flange Thickness	Box Qty.
78101103556	BRC3-F1	14/2 & 12/2 With Ground	1/16" - 5/32"	100
78101103557	BRC3-F2	14/2 & 12/2 With Ground	5/32" - 1/4"	100

Note: These products are designed for positioning only. No load rating.

Hangers

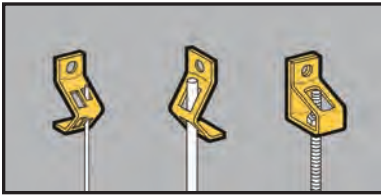

- BH1, BH2: Supports wire or plain rod.
- BH7, BH8: For wire or chain drop from concrete or wood.
- BH4, BH5, BH6 supports 1/4" or 3/8" threaded rod.
- Static Load Capacity: 160 Lbs.

Components

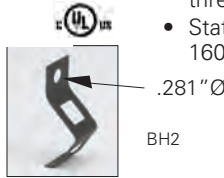

UPC/Part Number	Catalog Number	Description	Box Qty.
78101118800	BH1	#8 Wire or 1/4" Plain Rod	100
78101118805	BH2	For 3/8" Plain Rod	100

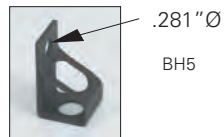
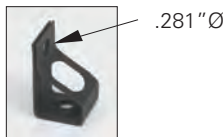
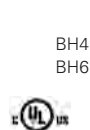

UPC/Part Number	Catalog Number	Description	Box Qty.
78101118815	BH4	For 1/4" Threaded Rod	100
78101118825	BH6	For 3/8" Threaded Rod	100
78101118820	BH5 *	For 1/4" & 3/8" Threaded Rod	100

* Nuts required.

Note: BH4 & BH6 have thread impressions.



BH8

UPC/Part Number	Catalog Number	Description	Box Qty.
78101118830	BH7	Angle Bracket With .281"Ø Holes	100
78101118835	BH7-6	Angle Bracket With .281"Ø & .406"Ø Holes	100
78101118840	BH8	Offset Bracket With .281"Ø Holes	100
78101118845	BH8-6	Offset Bracket With .281"Ø & .406"Ø Holes	100

Read safety/installation instruction sheets in packages before use.

Hangers

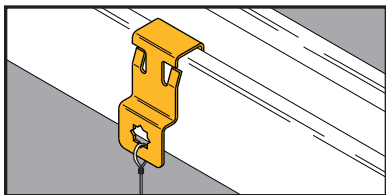

- The BSC4 Series provides a simple, snap-on attachment to strut, eliminating the need for tools and/or drilling during installation.

Strut Fasteners



- Ideal for retrofit and add-on applications.
- BSC4 provides a 1/4" mounting hole along the side of a standard strut member.
- Riveted assemblies allow for easy attachment of conduit, cable and rod.

UPC/Part Number	Catalog Number	Description	Load Capacity	Box Qty.
78205146573	BSC4	Strut Clip	60 lbs.	100



UPC/Part Number	Catalog Number	Rod Size	Load Capacity	Box Qty.
78205146581	BH4-SC4	1/4"-20	60 lbs.	100
78205146582	BH6-SC4	3/8"-16	60 lbs.	100

Hangers



BG-SC4



BP-SC4



BL14-SC4

UPC/Part Number	Catalog Number	Conduit Size	Load Capacity	Box Qty.
78205146577	BG6-SC4	MC/AC & 3/8"	25 lbs.	100
78205146578	BG812-SC4	1/2" & 3/4"	25 lbs.	100
78205146579	BP8-SC4	1/2"	15 lbs.	100
78205146580	BP12-SC4	3/4"	15 lbs.	100
78205146588	BL1400-SC4	1/2"	60 lbs.	100
78205146589	BL1410-SC4	3/4"	60 lbs.	100
78205146590	BL1420-SC4	1"	60 lbs.	100



BX4M-SC4



BRC5-SC4

UPC/Part Number	Catalog Number	Cable Size Runs	Load Capacity	Box Qty.
78205146584	BX4M-SC4	14/2 - 10/3 up to 2 runs	–	100
78205146585	BRC51-SC4	.430" to .560" up to 4 runs	50 lbs.	100
78205146586	BRC52-SC4	.430" to .560" up to 9 runs	50 lbs.	100
78205146587	BRC53-SC4	.560" to .690" up to 7 runs	50 lbs.	100

Read safety/installation instruction sheets in packages before use.

Hangers

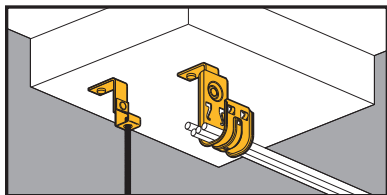

Drive Pin Fasteners



BPNA



BCH21-PNA
BCH32-PNA



BH-PNA



BH1-PNA
BH2-PNA

- Special support bracket allows clearance for powder actuated tools.
- Exclusive 1¹/₄" drive pin now pre-installed.
- Pins rated for concrete up to 4000 psi.
- Static Load Capacity: 30 Lbs. unless specified. Limited by fastener assembly. Pin rating must be considered before installation.

UPC/Part Number	Catalog Number	Description	Box Qty.
78205125583	BPNA	Angle Bracket	100
78205128090	BCH12-PNA	3/4" Cable Hook	100
78205125584	BCH21-PNA	1 ⁵ / ₁₆ " Cable Hook	50
78205125586	BCH32-PNA	2" Cable Hook	50
78205125588	BCH64-PNA	4" Cable Hook	25
78205125611	BH-PNA	Strap Hanger	100
78205125593	BH1-PNA	#8 Wire or 1/4" Plain Rod	100
78205125596	BH2-PNA	3/8" Plain Rod	100

Read safety/installation instruction sheets in packages before use.

Drive Pin Fasteners



BH_PNA



BG_PNA



BP_PNA



BL14_PNA



BX4_PNA



BX4M_PNA

UPC/Part Number	Catalog Number	Description	Box Qty.
78205125604	BH4-PNA *	1/4" Threaded Rod	100
78205125606	BH6-PNA *	3/8" Threaded Rod Cable Hook	100
78205125605	BH5-PNA **	1/4" or 3/8" Threaded Rod	100
78205125613	BG6-PNA ***	3/8" Conduit	100
78205125615	BG8-12-PNA	1/2" & 3/4" Conduit	100
78205125616	BG16-PNA	1" Conduit	100
78205125623	BP8-PNA	1/2" EMT	100
78205125624	BP12-PNA	3/4" EMT	100
78205125630	BP16-PNA	1" EMT	100
78205125620	BL1400-PNA	1/2" Conduit	100
78205125621	BL1410-PNA	3/4" Conduit	100
78205125622	BL1420-PNA	1" Conduit	100
78205125590	BX4-PNA	Single Run MC, AC or FMC	100
78205125591	BX4M-PNA	Double Run MC, AC or FMC	100

* With threaded impressions. ** Nuts required.

*** BG-6 will accept the following range $\varnothing.420 - \varnothing.675$:

14/2 thru 10/4 MC/AC cable and $5/16$ or $3/8$ flexible conduit

Hangers

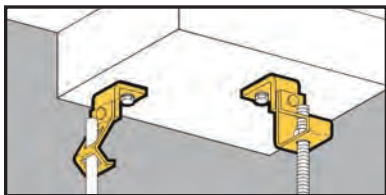

Angle Bracket Fasteners

- Suspend plain or threaded rod and drop wire from ceilings, walls, concrete beams, joists and laminated wood beams.
- Clearance hole for 1/4" bolt provided.
- Static Load Capacity: 160 Lbs.



UPC/Part Number	Catalog Number	Description	Box Qty.
78101118930	BH1-H7	#8 Wire or 1/4" Plain Rod	100
78101118975	BH2-H7	For 3/8" Plain Rod	100



UPC/Part Number	Catalog Number	Threaded Rod Size	Box Qty.
78101119010	BH4-H7	1/4"-20	100
78101119090	BH6-H7	3/8"-16	100
78101119050	BH5-H7 *	1/4"-20 or 3/8"-16	100

* Nuts required.

Note: BH4 & BH6 have thread impressions.

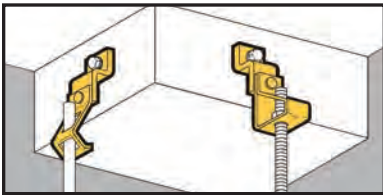

- Suspend plain or threaded rod and drop wire from ceilings, walls, beams, and joists.
- Clearance hole for 1/4" bolt provided.
- Static Load Capacity: 160 Lbs.

Offset Bracket Fasteners



UPC/Part Number	Catalog Number	Description	Box Qty.
78101118935	BH1-H8	#8 Wire or 1/4" Plain Rod	100
78101118975	BH2-H8	3/8" Plain Rod	100



UPC/Part Number	Catalog Number	Threaded Rod Size	Box Qty.
78101119015	BH4-H8	1/4"-20	100
78101119095	BH6-H8	3/8"-16	100
78101119055	BH5-H8 *	1/4"-20 or 3/8"-16	100

* Nuts required.

Note: BH4 & BH6 have thread impressions.

Hangers

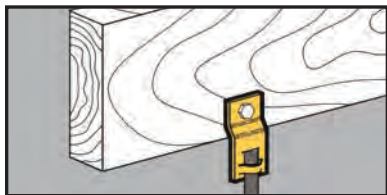

- Suspend 3/8" threaded rod from ceilings, walls, beams, and joists.
- Finish: Zinc Plated
- Static Load Capacity: 610 Lbs.

Threaded Rod Hangers

.406" Ø



UPC/Part Number	Catalog Number	Description	Box Qty.
78101101661	B3223-3/8	Offset Eye Socket	100

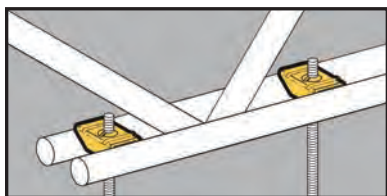

- Allows centering on all open web joists with round bottom chords.
- Static Load Capacity:
BH11 = 200 Lbs.
BH12 = 100 Lbs.

Wedge Hangers



BH11



BH12



UPC/Part Number	Catalog Number	Description	Box Qty.
78101118860	BH11	With 3/8" Clearance Hole	100
78101118865	BH12	With 1/4"-20 Thread Impression	100

Hangers

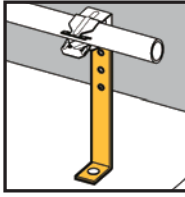
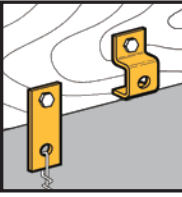

- Brackets are easily attached with screws or drive pins to wood, concrete or steel structures.
- Brackets are adaptable for use with a wide variety of fasteners, wires, "S" hooks and hangers.



BD2



BD4



BA28B

UPC/Part Number	Catalog Number	Description	Box Qty.
78101101686	BD2	Flat Bracket	100
78101118280	BD4	Offset Bracket	100
78101101449	BA28B	Angle Bracket	100

Read safety/installation instruction sheets in packages before use.

Lathers Channel

Lathers Channel

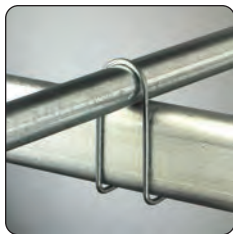

Lathers Channel

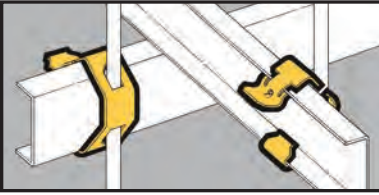

Rod & Wire Fasteners

- For fastening standard lathers channels to wires and plain rods.
- Fits 1/2" through 5/8" channel flange widths.
- Accepted for use by the City of New York Department of Buildings. MEA 383-91-M.
- Static Load Capacity: 160 Lbs.



BL-24-2



Side Mounts

BL-24-4

UPC/Part Number	Catalog Number	Channel Size	Rod/Wire Size	Box Qty.
78101119882	BL-24-2	1 1/2"	#8 Wire	100
78101119883	BL-24-4	1 1/2"	1/4"	100
78101119885	BL-32-4	2"	1/4"	100



Center Mount



UPC/Part Number	Catalog Number	Channel Size	Rod/Wire Size	Box Qty.
78101119884	BL-24-4C	1 1/2"	1/4" Rod	100

Read safety/installation instruction sheets in packages before use.

Lathers Channel

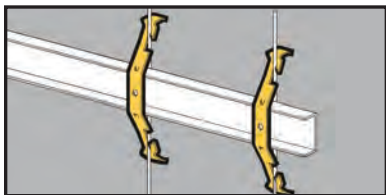

- For fastening standard 1 1/2" lathers channel to wires and plain rods.
- Wire size: #8 and #9.
- Rod size: 3/16" and 1/4".
- Fits 9/16" thru 5/8" channel flange widths.
- Static Load Capacity: 100 Lbs.

Rod & Wire Fasteners



UPC/Part Number	Catalog Number	Description	Box Qty.
78101119880	BL1	Channel to Rod & Wire	100

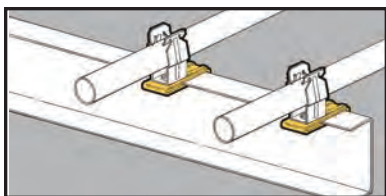

- Serves as a mounting base for conduit fasteners or electrical boxes.
- Attaches to either flange of lathers channel with 1/4"-20 screw (furnished).
- Fits channel flange widths up to 5/8".

Flange Fasteners



UPC/Part Number	Catalog Number	Description	Box Qty.
78101119881	BL2	Flange Fastener with Screw	100

Note: This product is designed for positioning only. No load rating.

Lathers Channel

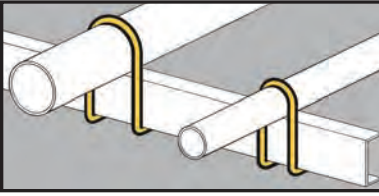

- Fastens EMT to 1 1/2" lathers channel.
- Static Load Capacity: 50 Lbs.
- Finish: Zinc Plated

Conduit Fasteners

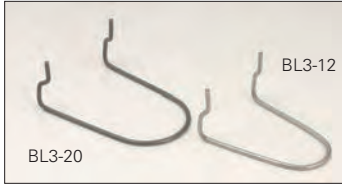

UPC/Part Number	Catalog Number	EMT Conduit Size	Box Qty.
78101119902	BL3-8	1/2"	100
78101119903	BL3-12	3/4"	100
78101119904	BL3-16	1"	100
78101119905	BL3-20	1 1/4"	100

Lathers Channel

Read safety/installation instruction sheets in packages before use.

Communication & Low Voltage

Communication & Low Voltage

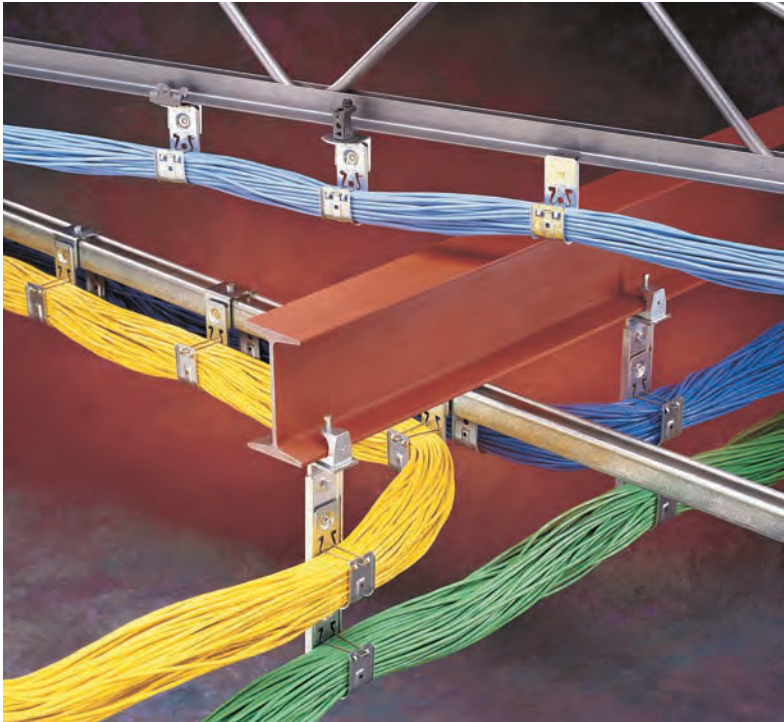

Communication & Low Voltage

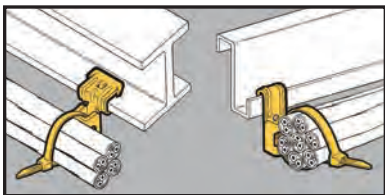

- Supports cable ties up to $\frac{9}{32}$ " wide from flanges $\frac{1}{16}$ " to $\frac{3}{4}$ " thick.
- 8" cable tie included.
- Simply installed with a hammer.

Cable Fasteners



UPC/Part Number	Catalog Number	Description	Box Qty.
78101119970	BE-2-4-CT2	$\frac{1}{8}$ " to $\frac{1}{4}$ "	100
78101119971	BE-5-8-CT2	$\frac{5}{16}$ " to $\frac{1}{2}$ "	100
78101119972	BE-9-12-CT2	$\frac{9}{16}$ " to $\frac{3}{4}$ "	100
78101119968	BF1-CT2	$\frac{1}{16}$ " to $\frac{5}{32}$ "	100
78101119969	BF2-CT2	$\frac{5}{32}$ " to $\frac{1}{4}$ "	100

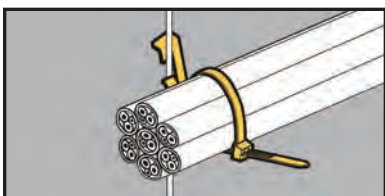

- Supports cable ties up to $\frac{9}{32}$ " wide from drop wires.
- 8" cable tie included.

Cable Fasteners



UPC/Part Number	Catalog Number	Description	Box Qty.
78101102866	BW2-CT2	#12 wire thru $\frac{1}{4}$ " plain or threaded rod	100
78101195603	BW6-CT2	$\frac{3}{8}$ " plain or threaded rod	100

Read safety/installation instruction sheets in packages before use. These products are designed for positioning only. No load rating.

Communication & Low Voltage

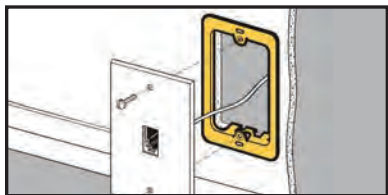

- Replaces electrical box in Class 2 low voltage installations.
- Provides attachment base for low voltage outlets.
- Accepts Decora®* style cover plates.
- Maximum 1 1/4" drywall thickness.
- Finish: Pre-galvanized

Cover Plate Mounting Brackets



BB10



BB10-2

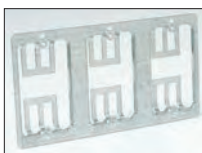

BB10-3



BB10-4



BB20

UPC/Part Number	Catalog Number	Description	Box Qty.
78101118150	BB10	Single Gang Bracket	50
78101118152	BB10-2	Mounts Two (2) Single Plates	10
78101119878	BB10-3	Mounts Three (3) Single Plates	10
78101119879	BB10-4	Mounts Four (4) Single Plates	10
78101118130	BB20	Double Gang Bracket	10

Patent # Re.33305

* Decora® is a registered trademark of Leviton Corporation.

Read safety/installation instruction sheets in packages before use.
These products are designed for positioning only. No load rating.

Communication & Low Voltage

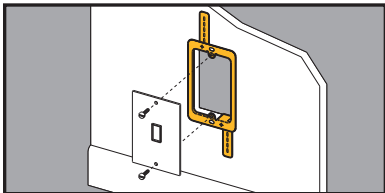

- Replaces electrical box in Class 2 low voltage installations.
- Provides attachment base for low voltage outlets.
- Maximum 1 1/4" drywall thickness.
- Finish: Pre-galvanized

Cover Plate Mounting Bracket



BB10L



BB20L

UPC/Part Number	Catalog Number	Description	Box Qty.
78101190895	BB10L	Single Gang Bracket	50
78101190896	BB20L	Double Gang Bracket	50

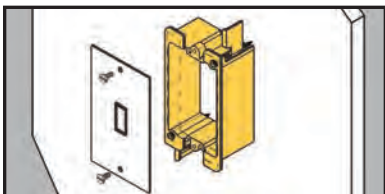

- Provides attachment base for low voltage outlets.
- Replaces electrical box in Class 2 low voltage installations.
- Design eliminates sharp edges from bracket.
- Maximum wall thickness: 3/4"

Plastic Cover Plate Mounting Bracket



UPC/Part Number	Catalog Number	Description	Box Qty.
78205139235	BB10P	Single Gang Bracket	50

Read safety/installation instruction sheets in packages before use.
These products are designed for positioning only. No load rating.

Communication & Low Voltage

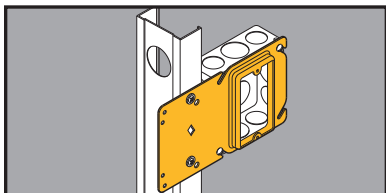

- Uni-Mount offers a secure box support for 4" square boxes and features a built-in plaster ring.
- Rigid bracket design eliminates the need for far-side support.
- Replaces electrical boxes in Class 2 low voltage installations.
- Guide tabs ensure consistent alignment on studs.
- Finish: Pre-galvanized

Uni-Mount Box Support/Cover Plate Mounting Brackets



Single Gang

UPC/Part Number	Catalog Number	Description	Box Qty.
78205122768	BB40-08	1/2" Raise	50
78205122771	BB40-10	5/8" Raise	50
78205122772	BB40-12	3/4" Raise	50



Double Gang

UPC/Part Number	Catalog Number	Description	Box Qty.
78205122773	BB45-08	1/2" Raise	50
78205122774	BB45-10	5/8" Raise	50
78205122775	BB45-12	3/4" Raise	50

Read safety/installation instruction sheets in packages before use. These products are designed for positioning only. No load rating.

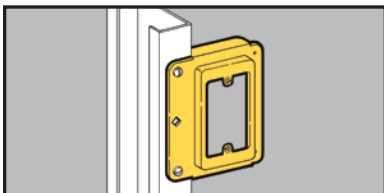

Cover Plate Mounting Bracket



- Locates communication outlets before drywall is installed.
- Replaces electrical box in Class 2 low voltage installations.
- For 1/2" and 5/8" drywall applications.
- Finish: Pre-galvanized

UPC/Part Number	Catalog Number	Description	Box Qty.
78101119873	BB15	Single Gang Stud Bracket	25

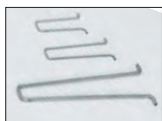
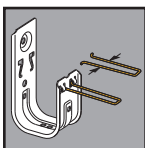

Replacement Cable Retainer Clips

- Cable retainer clips are included with all cable hook purchases.
- Provides secure containment of cables and offers quick open/close feature to add or remove cables.
- Finish: Pre-galvanized

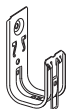

Retainer in open position



Push retainer down to lock

UPC/Part Number	Catalog Number	Cable Retainer For Hook Size	Box Qty.
78101104847	BCHR21	1/2" Raise	50
78101104848	BCHR32	5/8" Raise	50
78101104849	BCHR64	3/4" Raise	50

Patent #5961081

Read safety/installation instruction sheets in packages before use. These products are designed for positioning only. No load rating.

Communication & Low Voltage

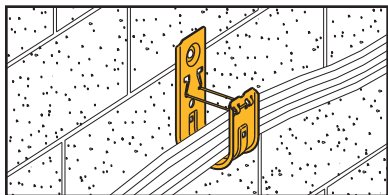

- Supports Cat. 5/5e/6/6A fiber optic, innerduct and low voltage cabling requirements.
- Cable retainer clips are included with hooks.
- Static Load Capacity: 30 Lbs.
- Finish: Pre-Galvanized

Cable Hooks

Communication & Low Voltage

BCH12



Open



Closed



BCH21



BCH32



BCH64



UPC/Part Number	Catalog Number	Hook Size	Capacity Up To	Box Qty.
78205128060	BCH12	3/4"	16 4-Pair UTP Cat 5e or 2-Strand Fiber Optic Cable or 10 CAT6	50
78101104713	BCH21	1 ⁵ / ₁₆ "	50 4-Pair UTP Cat 5e or 2-Strand Fiber Optic Cable or 32 CAT6 or 18 CAT6A	50
78101104713	BCH32	2"	50 4-Pair UTP Cat 5e or 2-Strand Fiber Optic Cable or 50 CAT6 or 25 CAT6A	50
78101104713	BCH64	4"	50 4-Pair UTP Cat 5e or 2-Strand Fiber Optic Cable or 185 CAT6 or 98 CAT6A	25

Patent #5961081

For special finish colors see page 156

(See pages 239-240 for technical data.)



Painted Cable Hooks

- Powder coated cable hooks are available in a range of colors to help meet your cable identification requirements.
- Standard riveted assemblies are available with painted cable hooks.
- Part numbers can be made by adding the paint color suffix after the cable hook part number.
- Minimum order quantity 500 pieces.
- Standard lead time is 5-10 working days.

Bright White - BW
Brown - BR
Computer White - CW
Equipment Blue - BL
Flat Black - FB

Green - GR
Orange - OR
Regal Red - RR
Safety Yellow - YL
Telcom Gray - TG

Part # Example:

Painted Cable Hook Part Number - BCH32BW

Painted Cable Hook Assembly - BCH32BW-U24



J-Hook Color ID Clip

- Color-coded clips allow for content designation without inventorying various colored hardware.
- Easy to designate pathways to prevent crossover.
- Order separately and field install.
- Can be snapped on J-Hook after it has been installed.
- Manufactured from Underwriters Laboratories (UL) Listed material for plenum spaces.
- Suitable for 3/4", 1⁵/₁₆", 2", and 4" J-Hook sizes.
- Available in six (6) colors:
Blue (BL), White (WH), Gray (GY), Orange (OR), Red (RD), and Yellow (YW).

Part # Example:

Blue Colored ID Clip Part Number

BCHID-BL12 - blue clip for BCH12 J-Hook

Read safety/installation instruction sheets in packages before use.

Communication & Low Voltage

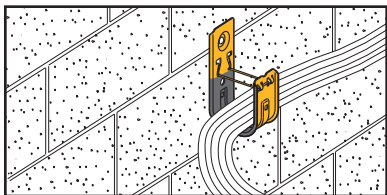

- Xylan® coating provides smooth frictionless surface for cable pulling.
- Great for use in corners, drop-outs or direction change.
- X-Hook has lower coefficient of friction than Teflon®.
- Cable retainer clips are included with hooks.
- Static Load Capacity: 30 Lbs.

X-Hook Low Friction Cable Hooks



BCH64X

New Xylan® coating reduces cable friction. Ideal for pulling cable.



Cable rollers are too expensive and require installation and removal.

UPC/Part Number	Catalog Number	Hook Size	Capacity	Box Qty.
78205129940	BCH21X	1 ⁵ / ₁₆ "	50 4-Pair UTP Cat 5e or 2-Strand Fiber Optic Cable or 32 CAT6 or 18 CAT6A	50
78205129941	BCH32X	2"	80 4-Pair UTP Cat 5e or 2-Strand Fiber Optic Cable or 50 CAT6 or 25 CAT6A	50
78205129942	BCH64X	4"	300 4-Pair UTP Cat 5e or 2-Strand Fiber Optic Cable or 185 CAT6 or 98 CAT6A	25

Note: For cable hook assemblies with X-Hooks add an X to the part number.

Example: BCH32X-U-2-4

(See pages 239-240 for technical data.)

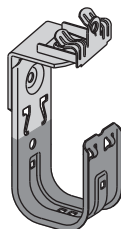

Xylan® is a registered trademark used by Whitford Corporation
Teflon® is a registered trademark used by DuPont®

Communication & Low Voltage

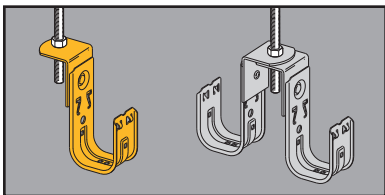

Cable To ATR Fasteners



- .505" diameter hole designed to support cable from 3/8" or 1/2" threaded rod.
- Allows back-to-back and multi-tier installations.
- Cable retainer clips are included with hooks.
- Static Load Capacity: 30 Lbs.
- Finish: Pre-galvanized

UPC/Part Number	Catalog Number	Hook Size	Hole Size	Box Qty.
78101104725	BCH21-AB	15/16"	.505" Diameter	50
78101104729	BCH32-AB	2"	.505" Diameter	50
78101104732	BCH64-AB	4"	.505" Diameter	25

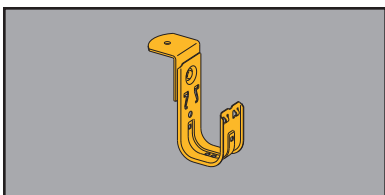

Angle Bracket Cable Fasteners



- Designed for direct attachment to structures.
- Supports cable from 1/4" threaded rod.
- .265" diameter hole accepts anchors, screws or common nails.
- Cable retainer clips are included with hooks.
- Static Load Capacity: 30 Lbs.
- Finish: Pre-galvanized

UPC/Part Number	Catalog Number	Hook Size	Hole Size	Box Qty.
78205128089	BCH12-RB	3/4"	.265" Diameter	50
78101104735	BCH21-RB	15/16"	.265" Diameter	50
78101104738	BCH32-RB	2"	.265" Diameter	50
78101104742	BCH64-RB	4"	.265" Diameter	25

(See pages 239-240 for technical data.)

Read safety/installation instruction sheets in packages before use.

Communication & Low Voltage

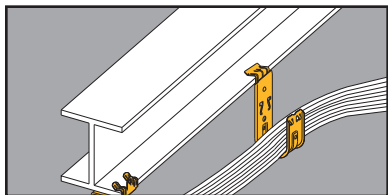

- Permits fast and easy installation on beam flanges.
- Cable retainer clips are included with hooks.
- Static Load Capacity: 30 Lbs.
- Finish: Pre-galvanized

Cable To Beam Fasteners



UPC/Part Number	Catalog Number	Hook Size	Flange Thickness	Box Qty.
78205128067	BCH12-E-2-4	3/4"	1/8" to 1/4"	50
78205128072	BCH12-E-5-8	3/4"	5/16" to 1/2"	50
78205128073	BCH12-E-9-12	3/4"	9/16" to 3/4"	50
78101104803	BCH21-E-2-4	1 5/16"	1/8" to 1/4"	50
78101104805	BCH21-E-5-8	1 5/16"	5/16" to 1/2"	50
78101104807	BCH21-E-9-12	1 5/16"	9/16" to 3/4"	50
78101104825	BCH32-E-2-4	2"	1/8" to 1/4"	50
78101104827	BCH32-E-5-8	2"	5/16" to 1/2"	50
78101104829	BCH32-E-9-12	2"	9/16" to 3/4"	50

(See pages 239-240 for technical data.)

Communication & Low Voltage

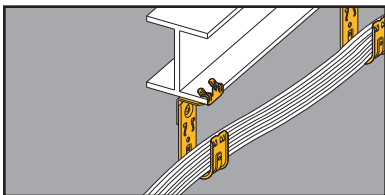

Cable To Beam Fasteners

- Permits fast and easy installation on beam flanges.
- Cable retainer clips are included with hooks.
- Static Load Capacity: 30 Lbs.
- Finish: Pre-galvanized



Allows
360°
Rotation



UPC/Part Number	Catalog Number	Hook Size	Flange Thickness	Box Qty.
78205128062	BCH12-U-2-4	3/4"	1/8" to 1/4"	50
78205128064	BCH12-U-5-8	3/4"	5/16" to 1/2"	50
78205128066	BCH12-U-9-12	3/4"	9/16" to 3/4"	50
78101104809	BCH21-U-2-4	1 5/16"	1/8" to 1/4"	50
78101104811	BCH21-U-5-8	1 5/16"	5/16" to 1/2"	50
78101104813	BCH21-U-9-12	1 5/16"	9/16" to 3/4"	50
78101104831	BCH32-U-2-4	2"	1/8" to 1/4"	50
78101104833	BCH32-U-5-8	2"	5/16" to 1/2"	50
78101104835	BCH32-U-9-12	2"	9/16" to 3/4"	50
78101104864	BCH64-U-2-4	4"	1/8" to 1/4"	25
78101104865	BCH64-U-5-8	4"	5/16" to 1/2"	25
78101104866	BCH64-U-9-12	4"	9/16" to 3/4"	25

(See pages 239-240 for technical data.)

Read safety/installation instruction sheets in packages before use.

Communication & Low Voltage

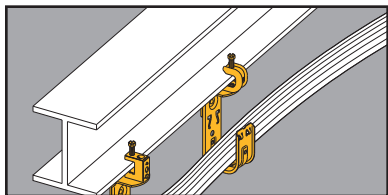

Cable To Beam Fasteners



- 360° rotation allows cable to run in any direction.
- Cable retainer clips are included with hooks.
- Static Load Capacity: 30 Lbs.
- Finish: Pre-galvanized

UPC/Part Number	Catalog Number	Hook Size	Flange Thickness	Box Qty.
78205128077	BCH12-C442	3/4"	1/8" to 5/8"	50
78101104823	BCH21-C442	1 5/16"	1/8" to 5/8"	50
78101104845	BCH32-C442	2"	1/8" to 5/8"	50
78101104868	BCH64-C442	4"	1/8" to 5/8"	25

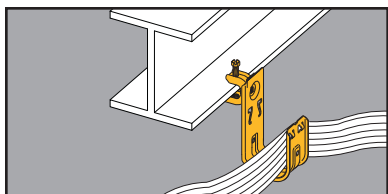

Cable To Beam Fasteners



- 360° rotation allows cable to run in any direction.
- Cable retainer clips are included with hooks.
- Static Load Capacity: 30 Lbs.
- Finish: Pre-galvanized

UPC/Part Number	Catalog Number	Hook Size	Flange Thickness	Box Qty.
78205141850	BCH12-C442A	3/4"	1/8" to 5/8"	50
78205141851	BCH21-C442A	1 5/16"	1/8" to 5/8"	50
78205141852	BCH32-C442A	2"	1/8" to 5/8"	50
78205141853	BCH64-C442A	4"	1/8" to 5/8"	25

(See pages 239-240 for technical data.)

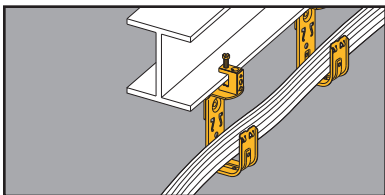

Cable To Beam Fasteners



- 360° rotation allows cable to run in any direction.
- Cable retainer clips are included with hooks.
- Static Load Capacity: 30 Lbs.
- Finish: Pre-galvanized

UPC/Part Number	Catalog Number	Hook Size	Flange Thickness	Box Qty.
78205128074	BCH12-C2	3/4"	thru 1/2"	50
78101104821	BCH21-C2	15/16"	thru 1/2"	50
78101104843	BCH32-C2	2"	thru 1/2"	50
78101104867	BCH64-C2	4"	thru 1/2"	25

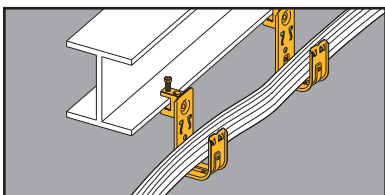

Cable To Beam Fasteners



- Cable retainer clips are included with hooks.
- Static Load Capacity: 30 Lbs.
- Finish: Pre-galvanized

UPC/Part Number	Catalog Number	Hook Size	Flange Thickness	Box Qty.
78205141303	BCH12-C1	3/4"	thru 1/2"	50
78101195578	BCH21-C1	15/16"	thru 1/2"	50
78101195560	BCH32-C1	2"	thru 1/2"	50
78205141304	BCH64-C1	4"	thru 1/2"	25

(See pages 239-240 for technical data.)

Read safety/installation instruction sheets in packages before use.

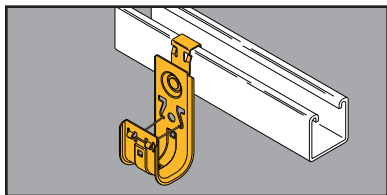

Cable Hook To Strut Attachment

- BSC4 provides a simple snap-on attachment to strut, eliminating the need for tools or drilling.
- Cable retainer clips are included with hooks.
- Great for retrofit applications.
- Load Capacity: 30 Lbs.
- Finish: Pre-galvanized



UPC/Part Number	Catalog Number	Cable Hook Size	Box Qty.
78205146574	BCH12-SC4	3/4"	50
78205146575	BCH21-SC4	15/16"	50
78205146576	BCH32-SC4	2"	50
78205146583	BCH64-SC4	4"	50

(See pages 239-240 for technical data.)

Communication & Low Voltage

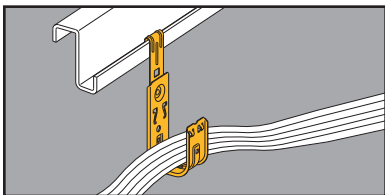

- Supports cable from vertical flanges.
- Cable retainer clips are included with hooks.
- Static Load Capacity: 30 Lbs.
- Finish: Pre-galvanized

Cable To Flange Fasteners



UPC/Part Number	Catalog Number	Hook Size	Flange Thickness	Box Qty.
78205128078	BCH12-F3	3/4"	1/16" to 1/4"	50
78101104815	BCH21-F3	15/16"	1/16" to 1/4"	50
78101104837	BCH32-F3	2"	1/16" to 1/4"	50
78101104869	BCH64-F3	4"	1/16" to 1/4"	25

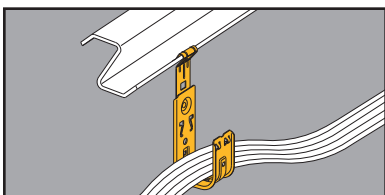

- Supports cable from angled flanges.
- Cable retainer clips are included with hooks.
- Static Load Capacity: 30 Lbs.
- Finish: Pre-galvanized

Cable To Flange Fasteners



UPC/Part Number	Catalog Number	Hook Size	Flange Thickness	Box Qty.
78205128079	BCH12-F4	3/4"	1/16" to 1/4"	50
78101104817	BCH21-F4	15/16"	1/16" to 1/4"	50
78101104839	BCH32-F4	2"	1/16" to 1/4"	50
78101104870	BCH64-F4	4"	1/16" to 1/4"	25

(See pages 239-240 for technical data.)

Read safety/installation instruction sheets in packages before use.

Communication & Low Voltage

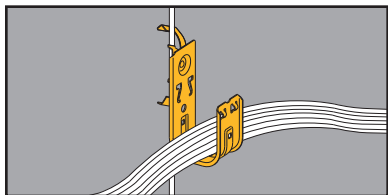

Cable To Wire and Rod Fasteners

Communication & Low Voltage



- Supports cable from #12 wire thru $\frac{3}{8}$ " threaded rod.
- Cable retainer clips are included with hooks.
- W2 series attaches to #12 wire thru $\frac{1}{4}$ " plain or threaded rod.
- W6 series attaches to $\frac{3}{8}$ " plain or threaded rod.
- Static Load Capacity: 25 Lbs.
- Finish: Pre-galvanized

UPC/Part Number	Catalog Number	Description	Box Qty.
78205146573	BCH12-W2	$\frac{3}{4}$ "	50
78101104819	BCH21-W2	$\frac{15}{16}$ "	50
78101104841	BCH32-W2	2"	50
78205128082	BCH12-W6	$\frac{3}{4}$ "	50
78101195567	BCH21-W6	$\frac{15}{16}$ "	50
78101195569	BCH32-W6	2"	50

(See pages 239-240 for technical data.)

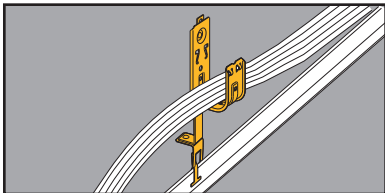

Cable To T-Bar Fasteners

- Supports cable above ceiling grid and allows 360° rotation.
- Provides compliance with the EIA/TIA requirements.
- Permits dropwire attachment if required.
- Cable retainer clips are included with hooks.
- Static Load Capacity: 30 Lbs.
- Finish: Pre-galvanized



UPC/Part Number	Catalog Number	Description	Box Qty.
78205128083	BCH12-A28	3/4"	50
78101104857	BCH21-A28	15/16"	50
78101104858	BCH32-A28	2"	50

(See pages 239-240 for technical data.)

Read safety/installation instruction sheets in packages before use.

Communication & Low Voltage

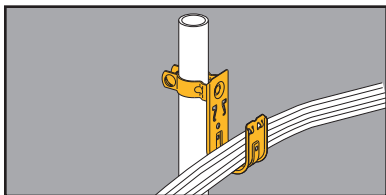

Cable To Floor Support Fasteners



- Supports cable from computer floor post.
- Organizes cable off the floor for a neat installation.
- Cable retainer clips are included with hooks.
- Static Load Capacity: 30 Lbs.
- Finish: Pre-galvanized

UPC/Part Number	Catalog Number	Hook Size	Floor Post Size	Box Qty.
78205128085	BCH12-L1410	3/4"	1" O.D.	50
78101104851	BCH21-L1410	15/16"	1" O.D.	50
78101104855	BCH32-L1410	2"	1" O.D.	50
78101104871	BCH64-L1410	4"	1" O.D.	25

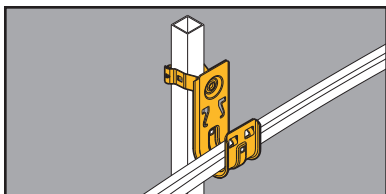

Cable To Floor Support Fasteners



- Supports cable from computer floor post.
- Organizes cable off the floor for a neat installation.
- Cable retainer clips are included with hooks.
- Static Load Capacity: 30 Lbs.
- Finish: Pre-galvanized

UPC/Part Number	Catalog Number	Hook Size	Floor Post Size	Box Qty.
78205128086	BCH12-G-8-12	3/4"	1" Square	50
78101172487	BCH21-G-8-12	15/16"	1" Square	50
78101172489	BCH32-G-8-12	2"	1" Square	50
78101172491	BCH64-G-8-12	4"	1" Square	25

(See pages 239-240 for technical data.)

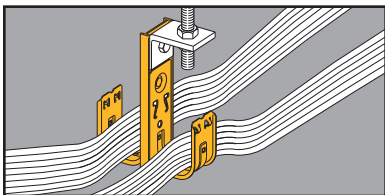

Double-Sided Multi-Tier Cable Fasteners



1D



2D

- Factory assembled multi-tier fasteners speed up installation.
- Unique design prevents hook and assembly rotation when pulling cable.
- All support bars furnished in 6063-T6 aluminum.
- Shown with optional BCHK2 kit.
- Cable retainer clips are included with hooks.
- Static Load Capacity: (per hook) 30 Lbs.
- Finish: Pre-galvanized

UPC/Part Number	Catalog Number	Hook Size	Description	Box Qty.
78101104758	BCH21-1D	1 ⁵ / ₁₆ "	1 Tier, 2-Sided, 5 ¹ / ₂ " High	20
78101104762	BCH32-1D	2"	1 Tier, 2-Sided, 6 ³ / ₁₆ " High	25
78101104874	BCH64-1D	4"	1 Tier, 2-Sided, 9" High	10
78101104766	BCH21-2D	1 ⁵ / ₁₆ "	1 Tier, 2-Sided, 9 ¹ / ₄ " High	10
78101104770	BCH32-2D	2"	1 Tier, 2-Sided, 11" High	10
78101104875	BCH64-2D	4"	1 Tier, 2-Sided, 18 ¹ / ₄ " High	10

Patent #5961081

(See pages 239-240 for technical data.)

Read safety/installation instruction sheets in packages before use.

Communication & Low Voltage

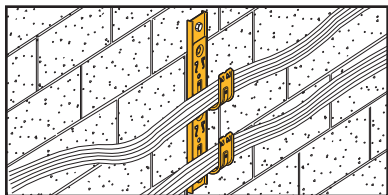

Single-Sided Multi-Tier Cable Fasteners

- Factory assembled multi-tier fasteners speed up installation.
- Available in two-six tier assemblies.
- Unique design prevents hook and assembly rotation when pulling cable.
- Cable retainer clips are included with hooks.
- All support bars furnished in 6063-T6 aluminum.
- Static Load Capacity: 30 Lbs. (per hook)



2S



3S



UPC/Part Number	Catalog Number	Hook Size	Description	Box Qty.
78101104773	BCH21-2S	1 ⁵ / ₁₆ "	2 Tier, 1-Sided, 11" Overall Height	20
78101104776	BCH32-2S	2"	2 Tier, 1-Sided, 12 ³ / ₄ " Overall Height	25
78101195300	BCH64-2S	4"	2 Tier, 1-Sided, 19 ⁵ / ₁₆ " Overall Height	10
78101104779	BCH21-3S	1 ⁵ / ₁₆ "	3 Tier, 1-Sided, 14 ³ / ₄ " Overall Height	10
78101104782	BCH32-3S	2"	3 Tier, 1-Sided, 17 ¹ / ₂ " Overall Height	10
78101195303	BCH64-3S	4"	3 Tier, 1-Sided, 28 ¹ / ₁₆ " Overall Height	10

Patent #5961081

(See pages 239-240 for technical data.)

Communication & Low Voltage



4S



5S



6S



Communication & Low Voltage

UPC/Part Number	Catalog Number	Hook Size	Description	Box Qty.
78101104785	BCH21-4S	1 ⁵ / ₁₆ "	4 Tier, 1-Sided, 18 ¹ / ₂ " Overall Height	10
78101104788	BCH32-4S	2"	4 Tier, 1-Sided, 21 ³ / ₄ " Overall Height	10
78101197872	BCH64-4S	4"	4 Tier, 1-Sided, 36 ¹³ / ₁₆ " Overall Height	10
78101104791	BCH21-5S	1 ⁵ / ₁₆ "	5 Tier, 1-Sided, 21 ³ / ₄ " Overall Height	10
78101104794	BCH32-5S	2"	5 Tier, 1-Sided, 27" Overall Height	10
78101104797	BCH21-6S	1 ⁵ / ₁₆ "	6 Tier, 1-Sided, 26" Overall Height	10
78101104800	BCH32-6S	2"	6 Tier, 1-Sided, 31 ³ / ₄ " Overall Height	10

Patent #5961081

(See pages 239-240 for technical data.)

Read safety/installation instruction sheets in packages before use.

Communication & Low Voltage



Shown with
BRC5
Brackets



Shown with
Cable
Hooks

- The BCH-HBA combines a tiered support bar and angle bracket into one piece.
- More flexibility! The BCH-HBA can be supported from $\frac{3}{16}$ " , $\frac{1}{4}$ " , $\frac{5}{16}$ " or $\frac{3}{8}$ " rod.
- Mounts up to three BCH21 or BCH32 cable hooks or two BCH64 cable hooks per side.
- Mounts up to three BRC5 MC/AC cable support brackets per side.
- Load Capacity: 180 lbs.

Multi-Tier Support Bar



UPC/Part Number	Catalog Number	Description	Box Qty.
78205143819	BCH-HBA	Multi-Tier Support Bar	40

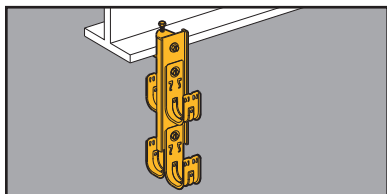

- Support bars furnished in 6063-T6 aluminum.



Multi-Tier Cable Hook Kits



UPC/Part Number	Catalog Number	Description	Box Qty.
78101199572	BCH-HB21	Support Bar for BCH21 and BCH32 $8\frac{1}{4}$ " long with $.281\varnothing$ holes	20
78101199574	BCH-HB64	Support Bar for BCH64 $13\frac{5}{16}$ " long with $.281\varnothing$ holes	20

(See pages 239-240 for technical data.)

Multi-Tier Attachment Kits

- BCHK1 includes:
Beam clamp (B444-1/4)
and 1/4"-20 x 1/2"
hex head cap screw



BCHK1

- BCHK2 includes:
Angle bracket (.320"Ø
and .390"Ø holes) and
1/4"-20 x 1/2"
hex head cap screw



BCHK2

- BCHK3 includes:
1 each BCHK1 Kit and
BCHK2 Kit



BCHK3

UPC/Part Number	Catalog Number	Kit Description	Flange Thickness	Box Qty.
78101104872	BCHK1	Beam Clamp	Thru 1/2"	10
78101104860	BCHK2	Angle Bracket	--	10
78101104873	BCHK3	Beam Clamp with Angle Bracket (swivels 360°)	Thru 1/2"	10

Read safety/installation instruction sheets in packages before use.

Communication & Low Voltage

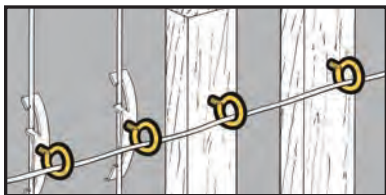

- Supports low voltage communication cables from beams or rods when used with other fasteners.
- *Ultimate Static Load Capacity:* 50 Lbs.
- Finish: Zinc Plated

Threaded Bridle Rings



UPC/Part Number	Catalog Number	Ring Size	Thread Size x Thread Length	Box Qty.
78101119550	BR-8-T	1/2"	#10-24 x 9/16"	100
78101119555	BR-12-T	3/4"	#10-24 x 9/16"	100
78101119560	BR-20-T	1 1/4"	#10-24 x 9/16"	100
78101119570	BR-32-T	2"	#10-24 x 9/16"	100
78101119565	BR-20-4T	1 1/4"	1/4"-20 x 9/16"	100
78101119575	BR-32-4T	2"	1/4"-20 x 9/16"	100
78101119889	BR-64-4T	4"	1/4"-20 x 9/16"	50



Lag Screw
for Wood
Beams

UPC/Part Number	Catalog Number	Ring Size	Thread Size x Thread Length	Box Qty.
78101119875	BR-16-3W	1"	#10 x 9/16"	100
78101119886	BR-24-4W	1 1/2"	1/4" x 27/32"	100
78101119876	BR-32-4W	2"	1/4" x 7/8"	100

Communication & Low Voltage

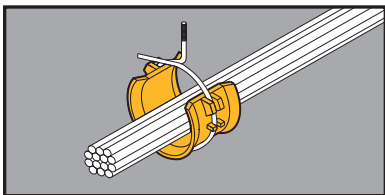

- The convenience of a bridle ring with the cable-bearing surface of a hook.
- 2" saddle is available separately. Can be easily attached before or after cable installation.

Bridle Ring Saddles



BRS-32A



BRS-64A

BRS-32

UPC/Part Number	Catalog Number	Thread Size x Thread Length/Description	Box Qty.
78205122761	BRS-32A	1/4"-20 x 7/8" 2" Ring Assembly	50
78205122762	BRS-64A	1/4"-20 x 1" 4" Ring Assembly	25
78205122759	BRS-32	2" Saddle Only	50

Also available for use with the following B-Line Fasteners.

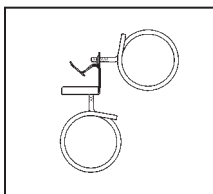

BU-9-12

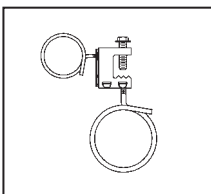

BC1

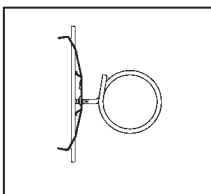

BW2

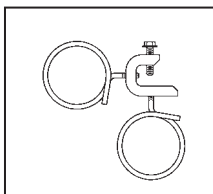

BC442

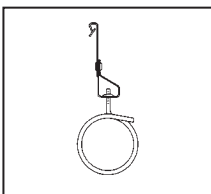

BH4-F3

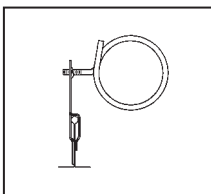

BA5-4T

Read safety/installation instruction sheets in packages before use.

Communication & Low Voltage

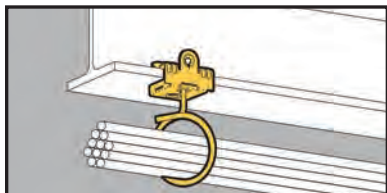

- Supports low voltage communication cables from beam flanges 1/8" to 3/4" thick.
- Pre-assembled with 2" bridle ring.
- Reduces installation time.
- Static Load Capacity : 15 lbs.

Bridle Ring/Beam Fastener Assy.



UPC/Part Number	Catalog Number	Description	Box Qty.
78101102921	BR-32-4T-U-2-4	1/8" to 1/4"	50
78101102923	BR-32-4T-U-5-8	5/16" to 1/2"	50
78101102924	BR-32-4T-U-9-12	9/16" to 3/4"	50

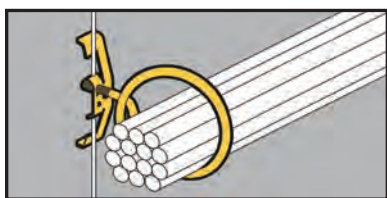

- Supports low voltage communication cables from drop wire.
- Pre-assembled with 2" bridle ring.
- Reduces installation time.
- Static Load Capacity : 15 lbs.

Bridle Ring/Rod & Wire Fastener Assy.



UPC/Part Number	Catalog Number	Description	Box Qty.
78101102929	BR-32-4T-W2	#12 Wire Thru 1/4" Plain or Threaded Rod	50

Communication & Low Voltage

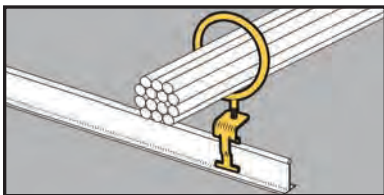

Bridle Ring/T-Bar Fastener Assembly

- Supports low voltage communication cables above the T-Bar.
- Pre-assembled with 2" bridle ring.
- Reduces installation time.
- For positioning only - No Load Rating



UPC/Part Number	Catalog Number	Description	Box Qty.
78101102934	BR-32-4T-A6	2" Ring Size	50

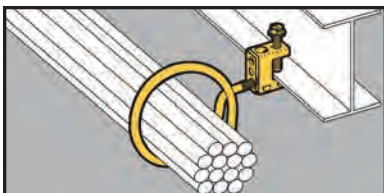

Bridle Ring/Beam Fastener Assembly

- Supports low voltage communication cables from beam flanges thru 1/2" thick.
- Pre-assembled with 2" bridle ring.
- Reduces installation time.
- Static Load Capacity: 15 lbs.



UPC/Part Number	Catalog Number	Description	Box Qty.
78101102937	BR-32-4T-C1	2" Ring Size	50

Read safety/installation instruction sheets in packages before use.

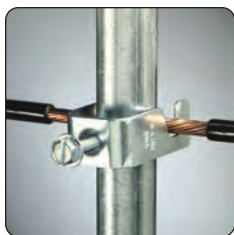

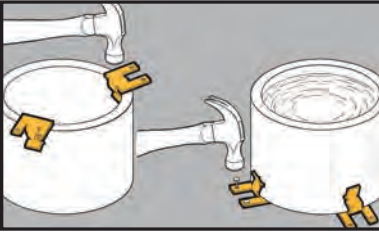

Pipe Sleeve Fasteners



- Allows for rigid attachment of pipe sleeves to wall and floor forms for concrete pouring.
- Accommodates Schedule 40, Schedule 80, or 5/16" and smaller wall thickness.

UPC/Part Number	Catalog Number	Sleeve Diameter	Wall Thickness	Box Qty.
78101118285	BD40	All Dia.	5/16" & Under	100
78101118285	BD40	2" to 6"	Schedule 40 Pipe	100

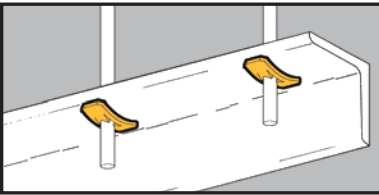

Accessory Nuts



BN-2, BN-4,
BN-6
Push Nuts



BN1
"U" Nuts With
Thread Impression

- Push Nuts designed for use with plain rod.
- "U" Nuts provide 1/4"-20 thread impression for unthreaded hole.
- No installation tools required.

UPC/Part Number	Catalog Number	Rod/Wire Size	Static Load Capacity	Box Qty.
78101110115	BN-2	#8 Wire	100 lbs. thru 3/8" hole	100
78101119120	BN-4	1/4" Plain Rod	100 lbs. thru 3/8" hole	100
78101119125	BN-6	3/8" Plain Rod	200 lbs. thru 1/2" hole	100
78101119110	BN1	1/4" Threaded Rod	50 lbs. on 9/32" hole	100

Read safety/installation instruction sheets in packages before use.

Accessories

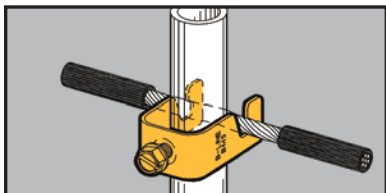

- Attaches signal reference grid wire to computer floor posts.
- Fits #8 thru #4 stranded wire. (.146" O.D. thru .232" O.D.).
- Fits 3/4" to 1" round or square posts.

Reference Wire Fasteners



UPC/Part Number	Catalog Number	Description	Box Qty.
78101101659	BM5	Single Reference Grid Wire Fastener	100

Accessories

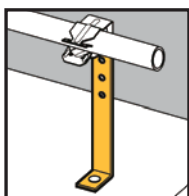
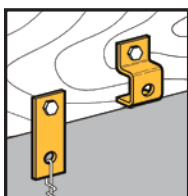

- Brackets are easily attached with screws or drive pins to wood, concrete or steel structures.
- Brackets are adaptable for use with a wide variety of fasteners, wires, "S" hooks and hangers.



BD2



BD4



BA28B

UPC/Part Number	Catalog Number	Description	Box Qty.
78101101686	BD2	Flat Bracket	100
78101118280	BD4	Offset Bracket	100
78101101449	BA28B	Angle Bracket	50

Accessories

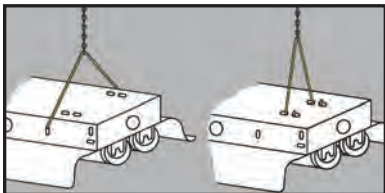

- For hanging industrial class fluorescent lighting fixtures.
- Use with Jack Chain and "S" Hooks.
- Static Load Capacity: 29 Lbs.
- Finish: Zinc Plated

Light Fixture Hangers



BH15



BH16

UPC/Part Number	Catalog Number	Description	Box Qty.
78101101236	BH15	Side Mount Fluorescent Light Fixture Hanger	100
78101101237	BH16	Top Mount Fluorescent Light Fixture Hanger	100

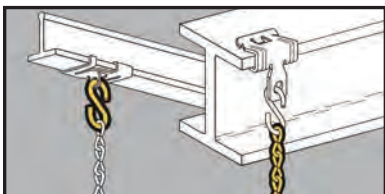

- For support of light fixtures and signs.
- Static Load Capacity: 29 Lbs.
- Finish: Zinc Plated

Jack Chain & "S" Hooks



BH10

BH9
BH9-10



UPC/Part Number	Catalog Number	Description	Box Qty.
78101118850	BH9	#12 Single Jack Chain	100 ft.
78101102901	BH9-10	#10 Single Jack Chain	100 ft.
78101118855	BH10	#11 "S" Hook	50

Read safety/installation instruction sheets in packages before use.

Accessories



KwikWire™ Clamps

- KwikWire™ system replaces jack chain or ATR to support lighting, ductwork, cable tray, etc.
- Can be quickly installed around beams - No drilling required.
- Ideal for sloped ceilings - can hang objects at up to 60° angles.
- Simple height adjustments are made by releasing locking tab, no tools required.
- Spools of wire can be cut to length in field, reducing waste and up front planning.



Accessories

UPC/Part Number	Catalog Number	For Use With Wire Rope Diameters	Box Qty.
78205140719	BKC100	1/16" & 3/32"	100
78205140723	BKC200	1/8" & 3/16"	50

KwikWire Clamp Working Loads*

Clamp Part No.	Wire Rope Dia.	Lbs. Safety Factor 5
BKC100	1/16"	0-75
	3/32"	25-150
BKC200	3/32"	25-150
	1/8"	25-250
	3/16"	50-640

* Working loads shown are for hanging vertically.
 For suspending at 15°, 30°, 45° or 60° angles from vertical use the following percentage of the working loads from the chart:
 15° = 96%, 30° = 86%,
 45° = 70%, 60° = 50%

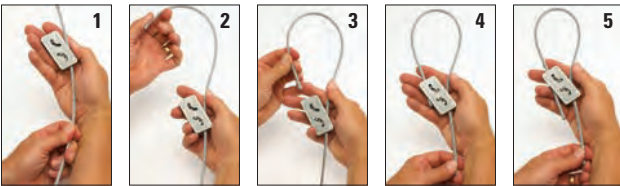

1. Pass the wire through the KwikWire Clamp
2. Loop wire through/around support
3. Pass wire back through KwikWire Clamp
4. Push wire through clamp leaving 2" to 3" tail, then apply tension on wire
5. To adjust, remove tension and pull wire slightly to disengage teeth, slide adjustment pin in direction shown by arrow to release wire.



7 x 7



7 x 19

KwikWire™ Wire Rope

UPC/Part Number	Catalog Number	Wire Diameter	Working Load - Lbs.	Spool Qty.
78205140725	BKW063 (1)	1/16"	96	500 ft.
78205140727	BKW094 (1)	3/32"	184	500 ft.
78205140733	BKW125 (1)	1/8"	340	500 ft.
78205140734	BKW188 (2)	3/16"	840	250 ft.

(1) Wire rope construction Type 7 x 7

(2) Wire rope construction Type 7 x 19

Uncoated Galvanized Wire



- KwikPak™ includes a supply of kwik-clamps and a spool of wire rope.
- KwikPak are shipped in a specially designed dispenser box to ease field cutting of wire.

KwikPak™



UPC/Part Number	Catalog Number	Kit Includes	Box Qty.
78205140749	BKP10063	BKC100 (100 pcs.) 1/16" Ø Wire Rope (500 ft.)	1
78205140751	BKP10094	BKC100 (100 pcs.) 3/32" Ø Wire Rope (500 ft.)	1
78205140761	BKP20125	BKC200 (50 pcs.) 1/8" Ø Wire Rope (500 ft.)	1
78205140763	BKP20188	BKC200 (50 pcs.) 3/16" Ø Wire Rope (250 ft.)	1

Read safety/installation instruction sheets in packages before use.

Accessories



- KwikWire™ hanger combines the versatility of a bolt with an adjustable wire rope solution.
- Can be quickly installed in existing anchors or metal brackets with a nut.
- Ideal for supporting light fixtures, wire basket cable tray, HVAC ducts, and sign/banner supports.
- See page 182 for wire rope spools.

KwikWire™ Hanger

UPC/Part Number	Catalog Number	Thread Size	Wire Rope Diameter	Load SF5	Box Qty.
78205158764	BKF100-4	1/4"-20	1/16" 3/32"	45 lbs. 90 lbs.	100
78205158765	BKF100-6	3/8"-16	1/16" 3/32"	45 lbs. 90 lbs.	100

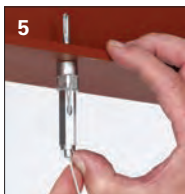

1. Screw KwikWire Hanger into installed hanger support
2. Push wire up through the bottom of KwikWire Hanger
3. Continue pushing through until 1/4" minimum is extending out the side of the KwikWire Hanger
4. To adjust up - pull or push more wire through KwikWire Hanger
5. To adjust down - push up on bottom of KwikWire Hanger and allow wire to feed down
6. When hanging the wire is complete, cut off any excess cable wire if desired

KwikWire™ Accessories



BKL Series

Loop Termination

- Available as a wire rope with loop termination only or as a ready-to-use kit with a BKC100 clamp.
- Available in lengths of 40", 80", 120", 180", 240", and 360".



BKH Series



BKYH Series

Single & "Y" Style Hook Termination

- Hook designed to accept up to 3/8" diameter wire.
- Available as a wire rope with hook termination only or as a ready-to-use kit with a BKC100 clamp.
- Available in lengths of 40", 80", 120", 180", 240", and 360".
- Available in single, double (Y), and triple (3) leg styles



BKT Series



BKYT Series

Single & "Y" Style Toggle Termination

- Available as a wire rope with toggle termination only or as a ready-to-use kit with a BKC100 clamp.
- Available in lengths of 40", 80", 120", 180", 240", and 360".
- Available in single, double (Y), and triple (3) leg styles
- All triple (3) leg styles are non-stock, consult B-Line for lead times



BKB Series

Bolt Loop Termination

- Ideal for use with ARS, ARC, ADI, ACPW, or ACPD anchors.
- Available as a wire rope with bolt termination only or as a ready-to-use kit with a BKC100 clamp.
- Available in lengths of 40", 80", 120", 180", 240", and 360".
- Available in single, double (Y), and triple (3) styles
- All double (Y) and triple (3) styles are non-stock, consult B-Line for lead times



BKA Series

Angle Bracket Termination

- Available as a wire rope with angle bracket termination only or as a ready-to-use kit with a BKC100 clamp.
- Available in lengths of 40", 80", 120", 180", 240", and 360".

For additional options, refer to KwikWire Brochure (KWHS)

Read safety/installation instruction sheets in packages before use.

Accessories



BKCP



B601-62



BKCC

KwikWire™ Accessories

UPC/Part Number	Catalog Number	Description	Box Qty.
78205140766	BKCP	Air Duct Corner Protector	100
78101156059	B601-62	Air Duct Support	50
78205140297	BKCC *	Wire Rope Cutter	1

Danger: Never use cutters on energized circuits, wire, or cable.

Note: Additional accessories include BE Series (pg. 96), BF Series (pgs. 125 & 129), and BPNA Series (pg. 139)

** Not for use of cutting 3/16" diameter cable.*

KwikWire™ System Recommendations:

- Do not exceed the safe working load of the products shown in their charts
- All characteristics of KwikWire must be used with wire supplied by B-Line
- Do not use for overhead lifting or hoisting
- Do not use if cable or components are visibly distorted or worn, remove damaged cable end prior to inserting in KwikWire™ Clamp
- Do not paint cable near working area of KwikWire Clamp connector
- Do not apply lubricant
- Keep product clean and free of dirt
- Do not use on coated wire rope
- Do not use in chlorinated or caustic atmospheres
- For use in dry locations
- Cooper's BKCC tool is recommended for cutting wire rope to prevent fraying
- For use on vertical applications only

Application Photos



Accessories



UPC/Part Number	Catalog Number	Description	Box Qty.
78101101687	SHHMS 1/4x1/2	1/4"-20 x 1/2" Slotted Hex Head Machine Screw	100



UPC/Part Number	Catalog Number	Description	Box Qty.
78101142103	MSQN1/4	1/4"-20 Machine Square Nut	100



UPC/Part Number	Catalog Number	Description	Box Qty.
78101110675	BWHS-9	Sheet Metal Screw #8 x 9/16"	1000

Note: BWHS-9 can be used with all fasteners requiring attachments with sheet metal screws.



UPC/Part Number	Catalog Number	Description	Box Qty.
78101104925	BWHS-9D	#8 x 1/2" Self-Drilling Sheet Metal Screw	1000

Note: BWHS-9D can be used with all fasteners requiring attachment with sheet metal screws except BB2-16, BB2-16D, BB2-24 & BB2-24D.

Read safety/installation instruction sheets in packages before use.

Anchors



Anchors



Glossary

Prefix - Description	Screw Dia.	Length	Suffix
ACB - Concrete Anchor Bolt	4 - #4	75 - 3/4"	AN - Acorn Nut
ACPD - Bang-IT	6 - #6	81 - 13/16"	CH - Combo Head
ACPW - Wood-Knocker	8 - #8	87 - 7/8"	F - Flat
ACS - Concrete Screw	10 - #10	100 - 1"	FL - Flanged
ADA - Drive Anchor	12 - 1/8"	118 - 13/18"	H - Hex
ADE - Double Expansion Anchor	18 - 3/16"	125 - 1 1/4"	HN - Hex Nut
ADH - Hollow-Base Drop-IN	25 - 1/4"	150 - 1 1/2"	HS - Hole Saw
ADI - Drop-In	31 - 5/16"	175 - 1 3/4"	K - Kit
ADM - Mini Drop-In	37 - 3/8"	187 - 1 7/8"	M - Mushroom
ADN - Drive Nail	50 - 1/2"	200 - 2"	OH - Oval Head
AMS - Machine Screw	62 - 5/8"	225 - 2 1/4"	PH - Pan Head
APC - Conical Anchor	75 - 3/4"	250 - 2 1/2"	RH - Rod Hanger
APD - Plastic Driller	87 - 7/8"	275 - 2 3/4"	RS - Slotted Round Head
APDM - Plastic Driller - Mini		300 - 3"	
APH - Plastic Hollow Wall Anchor		325 - 3 1/4"	SS4 - 304 Stainless Steel
APS - Plastic Screw Anchor		350 - 3 1/2"	
ARC - Rapid Rod™ Concrete		375 - 3 3/4"	T - Tool
ARS - Rapid Rod™ Steel		400 - 4"	WH - Wire Hanger
ARW - Rapid Rod™ Wood		425 - 4 1/4"	
ASA - Sleeve Anchor		450 - 4 1/2"	
ASE - Single Expansion Anchor		500 - 5"	
ATB - Toggle Bolt		525 - 5 1/4"	
ATM - Self-Tapping Machine Screw Anchor		550 - 5 1/2"	
		600 - 6"	
AWA - Wedge Anchor		700 - 7"	
AWSD - Seismic Wedge Anchor			
AWS - Wall Screw			
AZD - Zinc Driller			
AZDM - Zinc Driller-Mini			

Rapid Rod™ Hangers

- One-piece, all steel threaded fastener system for suspending steel threaded rod.
- Suitable for overhead installations such as suspending cable tray, pipe hangers, strut and conduit.
- Side Mount (SW) available for side mounting applications.
- Lower in-place cost, when compared to beam clamps, lag bolts and drop-ins.
- Steel rapid rods can be installed with a screw gun or hammer drill.
- UL & FM approved.
- Made of Zinc Plated carbon steel.

Rapid Rod Hangers Steel

Steel Rapid Rod - Data

Point Style	#3	#5
Self-Drilling Range (in.)	20 ga. - 3/16	3/16 - 1/2
Screw Size (UNC) *	1/4"-20	1/4"-20
Thread Length (in.) *	1 3/16	3 1/32

* Dimensions for self-drilling (embedded) portion of anchor.

Steel Rapid Rod - Load Data

Rod/ Anchor Size	Minimum Steel Gauge Thickness						
	20 (.036")	18 (.048")	16 (.060")	14 (.075")	12 (.105")	3/16"	1/4"
1/4	100	155	245	290	390	800	1260
1/4 w/nut	390	390	440	440	510	960	510
3/8	100	155	245	290	390	490	490
3/8 w/nut	365	365	365	365	365	365	365
1/2	120	175	230	390	510	820	1260

Loads shown for ASTM A36 steel beams and ASTM A572 steel purlins include a safety factor of 4.

For UL & FM listings, steel rapid rod must be installed with a retaining nut. UL & FM load rating for 3/8" rapid rod is 365 lbs. and can support up to a maximum 4" pipe.

UL & FM load rating for 1/2" rapid rod is 900 lbs. and can support up to a maximum 6" pipe.

Rapid Rod™ Hangers



UPC/Part Number	Catalog Number	Rod Size	Shank Size & Length	Box Qty.
Steel Rod Hanger - Point Style #3 For Purlins				
78205153317	ARS-25-100	1/4"	1/4" x 1"	100
78205153318	ARS-37-200	3/8"	1/4" x 2"	100
78205153320	ARS-37-100HN**	3/8"	1/4" x 1" w/nuts	100
78205153321	ARS-37-150	3/8"	1/4" x 1 1/2"	100
78205153322	ARS-37-150HN**	3/8"	1/4" x 1 1/2" w/nuts	100
Steel Rod Hanger - Side Mount - Point Style #3 For Purlins				
78205153323	ARS-25-100SW	1/4"	1/4" x 1"	100
78205153324	ARS-37-100SW	3/8"	1/4" x 1" w/nuts	100
Steel Rod Hanger - Point Style #5 For Purlins				
78205153325	ARS-25-150HD	1/4"	#12-24 x 1 1/2"	100
78205153326	ARS-37-150HDHN**	3/8"	#12-24 x 1 1/2" w/nuts	100
78205153327	ARS-50-150HDHN**	1/2"	#12-24 x 1 1/2" w/nuts	100

** For UL & FM listings, steel rapid rod should be installed with a retaining nut.

UPC/Part Number	Catalog Number	Tool Description	Box Qty.
Tool			
78205153287	7187	Universal Steel & Wood Socket	1

Rapid Rod™ Hangers

- One-piece, all steel threaded fastener system for suspending steel threaded rod.
- Suitable for overhead installations such as suspending cable tray, pipe hangers, strut and conduit.
- Side Mount (SW) available for side mounting applications.
- Lower in-place cost, when compared to beam clamps, lag bolts and drop-ins.
- Wood rapid rods can be installed with a screw gun or hammer drill.
- Concrete Rapid Rod hangers can be installed with an adjustable torque, battery powered screw gun or hammer drill.
- UL & FM approved.
- Made of Zinc Plated carbon steel.

Rapid Rod Hangers - Concrete

Concrete Rapid Rod - Data	1/4"	3/8"	1/2"
ANSI Drill Bit (in.)	1/4	1/4	3/8
Thread Length (in.)	1 1/8	1 3/8	2 1/2
Min. Embedment Depth (in.)	1 1/4	1 1/2	2 3/4
Load Capacity Tension (lbs.) *	485	650	1510
Load Capacity Shear (lbs.) *	610	660	1580

* Based on concrete compression strength of 4000 psi using applied safety factor of 4.0. For additional loading information contact factory.

FM approved load capacity for 3/8" anchor is 365 lbs., maximum 4" pipe size. FM approved load capacity for 1/2" anchor is 950 lbs., maximum 8" pipe size.

Rapid Rod Hangers - Wood

Wood Rapid Rod - Data	1/4" Thread Forming	3/8" Thread Forming
Pre-Drill Diameter (in.)	1/8	1/8
Point Style	Type 17	Type 17

Wood Rapid Rod - Embedment & Load Data

Rod/Anchor Size	Embedment Depth	Fir	Pine	Spruce
1/4	1"	170	160	160
3/8	2"	375	375	375
1/2	2 1/2"	665	775	775

Minimum load ratings are based on a safety factor of 4.

UL approved load capacity for 3/8" rod sizes and 1/4" screw size is 260 lbs., maximum 3" pipe. UL approved load capacity for 3/8" rod sizes and 3/8" screw size is 375 lbs., maximum 4" pipe. FM approval only applies to 3/8" x 2 1/2" screw size. Approved for 365 lbs., up to 4" pipe.

Rapid Rod™ Hangers

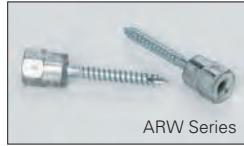

UPC/Part Number	Catalog Number	Rod Size	Shank Size & Length	Box Qty.
-----------------	----------------	----------	---------------------	----------

Concrete Rod Hanger - ANSI Wedge-Bolt OT Thread Shank Style

78205153328	ARC-25-125	1/4"	1/4" x 1"	100
78205153329	ARC-37-150	3/8"	1/4" x 1 1/2"	100
78205153330	ARC-50-275	1/2"	3/8" x 2 3/4"	50

For side mount concrete applications use ARW-25-100SW or ARW-37-200SW with 1/4" drill bit.

Wood Rod Hanger - Point Style Type 17

78205153331	ARW-25-200	1/4"	1/4" x 2"	100
78205153332	ARW-37-100	3/8"	1/4" x 1"	100
78205153333	ARW-37-200	3/8"	1/4" x 2"	100
78205153334	ARW-37-250	3/8"	3/8" x 2 1/2"	100
78205153335	ARW-50-250	1/2"	1/2" x 2 1/2"	100

Wood Rod Hanger - Side Mount - Point Style Type 17

78205153336	ARW-25-100SW	1/4"	1/4" x 1"	100
78205153337	ARW-37-200SW	3/8"	1/4" x 2"	100

UPC/Part Number	Catalog Number	Tool Description	Box Qty.
-----------------	----------------	------------------	----------

Tools

78205153287	7187	Universal Steel & Wood Socket	1
78205153288	7195	1/4" Concrete Socket	1
78205153289	7197	3/8" Concrete Socket	1
78205153290	7198	1/2" Concrete Socket	1
78205153360	5874	Concrete Tapper Sleeve Assy.	1
78205153361	5866	1/4" X 6" Hex Shank SDS Drill Bit	1

Read safety/installation instruction sheets in packages before use.

Anchors

Drop-in Anchors

- Designed for use in solid concrete.
- Can be used for overhead applications such as suspending cable tray, strut, pipe supports and lighting.
- Flanged (lipped) version installs flush for easy inspection and standardizes rod heights.
- Smooth wall drop-in can be installed flush mounted or below the base material surface.
- UL & FM approved.
- Available in Zinc Plated finish or Stainless Steel.



Drop-In Anchors - Data	1/4"	3/8"	1/2"	5/8"	3/4"
ANSI Drill Bit Size (in.)	3/8	1/2	5/8	7/8	1
Max. Tightening Torque (ft-lbs)	5	10	20	40	80
Thread Size (UNC)	1/4"-20	3/8"-16	1/2"-13	5/8"-11	3/4"-10
Min. Embedment Depth (in.)	1	19/16	2	2 1/2	3 3/16
Load Capacity Tension (lbs) *	495	1045	1440	1860	3600
Load Capacity Shear (lbs) *	530	1145	1600	3095	3920

* Based on concrete compression strength of 4000 psi using applied safety factor of 4.0. For additional loading information contact factory.

UPC/Part Number	Catalog Number	Rod Size	Anchor Length	Thread Depth	Box Qty.
-----------------	----------------	----------	---------------	--------------	----------

Drop-In Anchor - Smooth Wall - Steel

78101103218	ADI-25	1/4"	1"	7/16"	100
78101103219	ADI-37	3/8"	1 9/16"	5/8"	50
78101103220	ADI-50	1/2"	2"	1 3/16"	50
78101103221	ADI-62	5/8"	2 1/2"	1 13/16"	25
78101103222	ADI-75	3/4"	3 3/16"	1 3/8"	10

Drop-In Anchor - Smooth Wall - StainlessSteel

78101103223	ADI-25SS4	1/4"	1"	7/16"	100
78101103224	ADI-37SS4	3/8"	1 9/16"	5/8"	50
78101103226	ADI-50SS4	1/2"	2"	1 3/16"	50
78101103227	ADI-62SS4	5/8"	2 1/2"	1 13/16"	25
78101103228	ADI-75SS4	3/4"	3 3/16"	1 3/8"	10

Drop-In Hanger - Flanged - Steel

78205153297	ADI-25FL	1/4"	1"	7/16"	100
78205153298	ADI-37FL	3/8"	1 9/16"	5/8"	50
78205153299	ADI-50FL	1/2"	2"	1 3/16"	50

UPC/Part Number	Catalog Number	Rod Size	Pin Length	Box Qty.
-----------------	----------------	----------	------------	----------

Setting Tools

78101103229	6305	1/4"	39/64"	1
78101103231	6307	3/8"	61/64"	1
78101103232	6309	1/4"	1 3/16"	1
78101103233	6311	1/4"	1 5/15"	1
78101103234	6313	1/4"	1 61/64"	1

Read safety/installation instruction sheets in packages before use.

Mini Drop-in Anchors

- Carbon steel machine bolt anchor for use in shallow embedment applications.
- Can be used in solid concrete and precast hollow core plank, in addition to post-tensioned concrete slabs and concrete pours over metal deck.
- Can be used for overhead applications such as suspending cable tray, strut, pipe supports and lighting.
- Flanged (lipped) version installs flush for easy inspection and standardizes rod heights.
- Setting tool scores flange when set to verify proper expansion
- Available in zinc plated finish.



Anchor

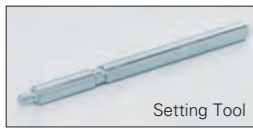

Setting Tool

Mini Drop-In Anchors - Data	1/4"	3/8"	1/2"
ANSI Drill Bit Size (in.)	3/8	1/2	5/8
Max. Tightening Torque (ft-lbs)	3	5	10
Thread Size (UNC)	1/4"-20	3/8"-16	1/2"-13
Min. Embedment Depth (in.)	5/8	3/4	1
Load Capacity Tension (lbs) *	350	530	840
Load Capacity Shear (lbs) *	415	1055	1220

* Based on concrete compression strength of 4000 psi using applied safety factor of 4.0. For additional loading information contact factory.

UPC/Part Number	Catalog Number	Rod Size	Thread Depth	Box Qty.
Mini Drop-In Anchor - Steel				
78205153300	ADM-25	1/4"	3/8"	100
78205153302	ADM-37	3/8"	13/32"	50
78205153302	ADM-50	1/2"	5/8"	50
Setting Tools				
78205153301	6336	1/4"	—	1
78205153303	6323	3/8"	—	1
78205153305	6338	3/8"	—	1

Read safety/installation instruction sheets in packages before use.

Hollow Base Drop-in Anchors

- For use in hollow base materials such as hollow concrete block, brick with weep holes, and precast hollow core plank.
- Can also be used in solid base materials.
- Smooth wall drop-in can be installed flush mounted or below the base material surface.
- Available in Zinc Plated finish.



Hollow Base Drop-In - Data	1/4"	3/8"	1/2"
ANSI Drill Bit Size (in.)	3/8	5/8	3/4
Max. Tightening Torque (ft-lbs)	5	10	20
Thread Size (UNC)	1/4"-20	3/8"-16	1/2"-13
Thread Length In Cone (in.)	3/8	5/8	3/4
Min. Embedment Depth (in.)	3/4	1	1 1/2
Load Capacity Tension (lbs) *	285	520	1005
Load Capacity Shear (lbs) *	300	640	1005

* Based on concrete compression strength of 4000 psi using applied safety factor of 4.0. For additional loading information contact factory.

UPC/Part Number	Catalog Number	Rod Size	Overall Length	Sleeve Length	Box Qty.
Hollow Base Drop-In					
78205153291	ADH-25	1/4"	7/8"	5/8"	100
78205153293	ADH-37	3/8"	1 5/16"	1 5/16"	50
78205153294	ADH-50	1/2"	1 3/4"	1 1/4"	50
Setting Tools					
78205153292	9323	1/4"	-	-	1
78205153294	9343	3/8"	-	-	1
78205153296	9353	1/2"	-	-	1

Concrete Screw Bolts

- For use in racking, shelving, material handling, structural anchorage, masonry and food & beverage facilities.
- One piece heavy-duty anchor with a finished hex-head.
- Fits standard fixture hole dimensions in fabricated steel.
- Fast installation and immediate loading reduces downtime.
- For proper performance, screw anchors must be installed with the corresponding bits. The bits have a matched tolerance range designed to provide optimum performance.



Concrete Screw Bolts - Data	1/4"	3/8"
ACB Drill Bit Size (in.)	1/4	3/8
Concrete Screw Tolerance Range (in.)	0.255 - 0.259	0.385 - 0.389
Min. Embedment Depth (in.)	1	1 1/2
Load Capacity Tension (lbs) *	335	630
Load Capacity Shear (lbs) *	520	1170

* Based on concrete compression strength of 4000 psi in uncracked concrete using applied safety factor of 4.0. For additional loading information contact factory.

For ultimate strength design data in cracked and uncracked concrete, see ICC-ES ESR-2526.

UPC/Part Number	Catalog Number	Anchor Length	Thread Length	Box Qty.
Screw Type Anchor - Steel				
78205153247	ACB-25-175	1/4" x 1 3/4"	1 5/8"	100
78205153248	ACB-25-225	1/4" x 2 1/4"	2"	100
78205153249	ACB-25-300	1/4" x 3"	2 3/4"	100
78205153250	ACB-37-175	3/8" x 1 3/4"	1 1/2"	50
78205153251	ACB-37-250	3/8" x 2 1/2"	2 1/4"	50
78205153252	ACB-37-300	3/8" x 3"	2 3/4"	50
78205153253	ACB-37-400	3/8" x 4"	3 3/4"	50

UPC/Part Number	Catalog Number	Drill Size	Usable Length	Overall Length	Box Qty.
Drill Bits - Straight Shank Type					
78205153254	1372	1/4"	4"	6"	1
78205153256	1380	3/8"	4"	6"	1
Drill Bits - SDS Type					
78205153255	1314	1/4"	4"	6"	1
78205153257	1316	3/8"	4"	6"	1

Note: Matched tolerance bits must be used for installation.

Read safety/installation instruction sheets in packages before use.

Anchors

Concrete Screws

- Light to medium duty anchor for use in concrete, masonry block and brick base materials.
- Concrete screws are engineered with matched tolerance bits and installation tools to optimize performance.
- High low thread design for greater stability and grip.
- No hole spotting required.
- One drill bit is packaged in each box of concrete screws.
- Blue fluorocarbon coating for corrosion resistance.



Straight Shank Drill Bit



SDS Hex Drill Bit



Hex Head

Hex Head - Data	3/16"	1/4"
ANSI Drill Bit Size (in.)	5/32	3/16
Fixture Clearance Hole (in.)	1/4	5/16
Head Height (in.)	7/64	9/64
Head Width (in.)	1/4	5/16
Washer O.D. (in.)	11/32	13/32
Washer Thickness (in.)	1/32	1/32
Hex Driver (in.)	1/4	5/16



Flat Head

Flat Head - Data	3/16"	1/4"
ANSI Drill Bit Size (in.)	5/32	3/16
Fixture Clearance Hole (in.)	1/4	5/16
Phillips Head O.D. (in.)	3/8	1/2
Phillips Head Height (in.)	9/64	3/16
Phillips Bit Size	2	3

Embedment Depth	Nominal Anchor Dia. / Loading*			
	3/16" Tension	3/16" Shear	1/4" Tension	1/4" Shear
1"	90	175	265	205
1 1/4"	175	230	335	355
1 3/8"	215	230	370	385
1 1/2"	255	230	405	355
1 3/4"	375	235	435	370

* Based on concrete compression strength of 4000 psi using applied safety factor of 4.0. For additional loading information contact factory.

Concrete Screws

UPC/Part Number	Catalog Number	Size	Box Qty.
-----------------	----------------	------	----------

Hex Head Concrete Screws

78101103342	ACS-18-125H	3/16" x 1 1/4"	100
78101103343	ACS-18-175H	3/16" x 1 3/4"	100
78101103344	ACS-18-225H	3/16" x 2 1/4"	100
78101103346	ACS-18-275H	3/16" x 2 3/4"	100
78101103347	ACS-18-325H	3/16" x 3 1/4"	100
78101103348	ACS-18-375H	3/16" x 3 3/4"	100
78101103349	ACS-18-400H	3/16" x 4"	100
78101103342	ACS-25-125H	1/4" x 1 1/4"	100
78101103343	ACS-25-175H	1/4" x 1 3/4"	100
78101103344	ACS-25-225H	1/4" x 2 1/4"	100
78101103346	ACS-25-275H	1/4" x 2 3/4"	100
78101103347	ACS-25-325H	1/4" x 3 1/4"	100
78101103348	ACS-25-375H	1/4" x 3 3/4"	100
78101103349	ACS-25-400H	1/4" x 4"	100

Flat Head Concrete Screws

78205153259	ACS-18-125F	3/16" x 1 1/4"	100
78205153260	ACS-18-175F	3/16" x 1 3/4"	100
78205153261	ACS-18-225F	3/16" x 2 1/4"	100
78205153262	ACS-18-275F	3/16" x 2 3/4"	100
78205153263	ACS-25-125F	1/4" x 1 1/4"	100
78205153264	ACS-25-175F	1/4" x 1 3/4"	100
78205153265	ACS-25-225F	1/4" x 2 1/4"	100
78205153266	ACS-25-275F	1/4" x 2 3/4"	100

UPC/Part Number	Catalog Number	Bit Size	Usable Length	Box Qty.
-----------------	----------------	----------	---------------	----------

Straight Shank Drill Bits

78205153267	2782	5/32" x 4 1/2"	3"	1
78205153269	2786	3/16" x 4 1/2"	3"	1

SDS Hex Drill Bits

78205153268	2793	5/32" x 5"	3"	1
78205153270	2796	3/16" x 5"	3"	1

UPC/Part Number	Catalog Number	Description	Box Qty.
-----------------	----------------	-------------	----------

Setting Tool

78101103453	2791	ConcreteScrew Tool Kit	100
-------------	-------------	------------------------	-----

Read safety/installation instruction sheets in packages before use.

Anchors

Wedge Expansion Anchors

- Heavy and medium duty all purpose anchor.
- For use in solid concrete and grout filled block.
- Anchors can be installed through the fixture, no need for hole spotting.
- Interlocking clip wedges prevent anchor spinning during installation.
- Wire hanger hole size $\frac{9}{32}$ " diameter, head height $\frac{3}{4}$ ".
- UL & FM approved.
- Available in Zinc Plated Carbon Steel or Type 304 Stainless Steel.



Wedge Expansion Anchor - Data	1/4"	3/8"	1/2"	5/8"
ANSI Drill Bit Size (in.)	1/4	3/8	1/2	5/8
Fixture Clearance Hole (in.)	5/16	7/16	9/16	11/16
Thread Size (UNC)	1/4"-20	3/8"-16	1/2"-13	5/8"-11
Washer O.D. (in.)	5/8	13/16	1 1/16	1 3/4
Wrench Size	7/16	9/16	3/4	15/16
Max. Tightening Torque (ft-lbs)	8	28	60	90
Min. Embedment Depth (in.)	1 1/8	1 5/8	2 1/4	2 3/4
Load Capacity Tension (lbs) *	360	760	1390	2075
Load Capacity Shear (lbs) *	405	940	1700	2975

* Based on concrete compression strength of 4000 psi using applied safety factor of 4.0. For additional loading contact factory.

Wire Hanger Wedge Anchor - Data	1/4"
ANSI Drill Bit Size (in.)	1/4
Min. Embedment Depth (in.)	1 1/8
Head Height (in.)	3/4
Load Capacity Tension (lbs) *	360
Load Capacity Shear (lbs) *	405

* Based on concrete compression strength of 4000 psi using applied safety factor of 4.0. For additional loading information contact factory.

UPC/Part Number	Catalog Number	Size	Hole Size	Box Qty.
Wire Hanger 78101103106	AWA-25-200WH	1/4" x 2"	9/32"	100

Wedge Expansion Anchors

UPC/Part Number	Catalog Number	Size	Thread Length	Box Qty.
Wedge Anchor				
78101103068	AWA-25-175	1/4" x 1 3/4"	3/4"	100
78101103069	AWA-25-225	1/4" x 2 1/4"	1 1/4"	100
78101103070	AWA-25-325	1/4" x 3 1/4"	2 1/4"	100
78101103071	AWA-37-225	3/8" x 2 1/4"	1 1/4"	50
78101103072	AWA-37-275	3/8" x 2 3/4"	1 5/8"	50
78101103073	AWA-37-300	3/8" x 3"	1 7/8"	50
78205153364	AWA-37-350	3/8" x 3 1/2"	2 3/8"	50
78101103074	AWA-37-375	3/8" x 3 3/4"	2 5/8"	50
78101103075	AWA-37-500	3/8" x 5"	3 7/8"	50
78205153366	AWA-50-275	1/2" x 2 3/4"	1 3/8"	50
78101103077	AWA-50-375	1/2" x 3 3/4"	2 3/8"	50
78205145636	AWA-50-450	1/2" x 4 1/2"	3 1/8"	50
78101103079	AWA-50-550	1/2" x 5 1/2"	4 1/8"	50
78101103080	AWA-50-700	1/2" x 7"	5 5/8"	25
78101103081	AWA-62-275	5/8" x 3 1/2"	2"	25
78101103082	AWA-62-375	5/8" x 4 1/2"	3"	25
78101103083	AWA-62-450	5/8" x 5"	3 1/2"	25
78101103084	AWA-62-550	5/8" x 6"	4 1/2"	25
78101103085	AWA-62-700	5/8" x 7"	5 1/2"	25
Wedge Anchor - Stainless Steel				
78101103146	AWA-25-175SS4	1/4" x 1 3/4"	3/4"	100
78101103147	AWA-25-225SS4	1/4" x 2 1/4"	1 1/4"	100
78101103148	AWA-25-325SS4	1/4" x 3 1/4"	2 1/4"	100
78101103149	AWA-37-225SS4	3/8" x 2 1/4"	1 1/4"	50
78101103150	AWA-37-275SS4	3/8" x 2 3/4"	1 5/8"	50
7810110151	AWA-37-300SS4	3/8" x 3"	1 7/8"	50
78205153365	AWA-37-350SS4	3/8" x 3 1/2"	2 3/8"	50
78101103152	AWA-37-375SS4	3/8" x 3 3/4"	2 5/8"	50
78101103153	AWA-37-500SS4	3/8" x 5"	3 7/8"	50
78101103154	AWA-50-275SS4	1/2" x 2 3/4"	1 3/8"	50
78101103155	AWA-50-375SS4	1/2" x 3 3/4"	2 3/8"	50
78205153367	AWA-50-450SS4	1/2" x 4 1/2"	3 1/8"	50
78101103157	AWA-50-550SS4	1/2" x 5 1/2"	4 1/8"	50
78205153368	AWA-50-700SS4	1/2" x 7"	5 5/8"	25
78205153369	AWA-62-275SS4	5/8" x 3 1/2"	2"	25
78205153370	AWA-62-375SS4	5/8" x 4 1/2"	3"	25
78205153779	AWA-62-450SS4	5/8" x 5"	3 1/2"	25
78205153371	AWA-62-550SS4	5/8" x 6"	4 1/2"	25
78205143044	AWA-62-700SS4	5/8" x 7"	5 1/2"	25

Read safety/installation instruction sheets in packages before use.

Seismic Wedge Anchors

- Fully threaded, torque-controlled, wedge anchor which is designed for consistent performance in cracked and uncracked concrete.
- For use in concrete, structural sand lightweight concrete, and concrete over metal deck.
- Nominal drill bit size is the same as the anchor diameter.
- ICC-ES listed, ESR-2502, Category 1
- Zinc plated carbon steel body with stainless steel expansion clip from premium performance.
- Qualified for seismic and wind loading.



Seismic Wedge Anchor - Data	3/8"	1/2"	5/8"	3/4"
ANSI Drill Bit Size (in.)	3/8	1/2	5/8	3/4
Fixture Clearance Hole (in.)	7/16	9/16	11/16	13/16
Minimum Hole Depth (in.)	2 ⁵ / ₈	2 ³ / ₄	4 ¹ / ₄	5
Minimum Concrete Thickness (in.)	4	4 ¹ / ₂	5 ³ / ₄	7
Max. Tightening Torque (ft-lbs)	20	40	60	110
Min. Embedment Depth (in.)	2 ³ / ₈	2 ¹ / ₂	3 ⁷ / ₈	4 ¹ / ₂

For loading information, see ICC-ES ESR-2502.

Seismic Wedge Anchors

UPC/Part Number	Catalog Number	Size	Thread Length	Box Qty.
Seismic Wedge Anchor				
78205153398	AWSD-37-300	3/8" X 3"	1 3/4"	50
78205153399	AWSD-37-350	3/8" X 3 1/2"	2 1/4"	50
78205153400	AWSD-37-375	3/8" X 3 3/4"	2 1/2"	50
78205153401	AWSD-37-500	3/8" X 5"	3 3/4"	50
78205153402	AWSD-50-375	1/2" X 3 3/4"	2 1/8"	50
78205153403	AWSD-50-450	1/2" X 4 1/2"	2 7/8"	50
78205153404	AWSD-50-550	1/2" X 5 1/2"	3 7/8"	50
78205153405	AWSD-50-700	1/2" X 7"	5 3/8"	50
78205153406	AWSD-62-475	5/8" X 4 3/4"	2 7/8"	25
78205153407	AWSD-62-500	5/8" X 5"	3 1/8"	25
78205153408	AWSD-62-600	5/8" X 6"	4 1/8"	25
78205153409	AWSD-62-700	5/8" X 7"	5 1/8"	25
78205153410	AWSD-75-550	3/4" X 5 1/2"	3 1/4"	20
78205153411	AWSD-75-625	3/4" X 6 1/4"	4"	20
78205153425	AWSD-75-700	3/4" X 7"	4 3/4"	20

Read safety/installation instruction sheets in packages before use.

Anchors

Drive Anchor

- One-piece, tamper-proof vibration resistant anchor for use in concrete.
- Anchor is formed with an 's' shaped configuration at the working end of the anchor to create an expansion mechanism.
- Anchor is pre-expanded so no secondary tightening operation is required.
- FM approved.
- Made of Zinc Plated carbon steel.



Mushroom Head - Data	3/16"	1/4"
ANSI Drill Bit Size (in.)	3/16	1/4
Fixture Clearance Hole (in.)	1/4	5/16
Head Height (in.)	7/64	7/64
Head Size O.D. (in.)	7/16	1/2
Min. Embedment Depth (in.)	7/8	7/8
Load Capacity Tension (lbs.) *	215	235
Load Capacity Shear (lbs.) *	330	470

Rod Hanger - Data	1/4"	3/8"
ANSI Drill Bit Size (in.)	3/16	1/4
UNC Thread Size	1/4"-20	3/8"-16
Head Height (in.)	1/2	5/8
Head Size O.D. (in.)	13/32	35/64
Min. Embedment Depth (in.)	1 1/4	1 3/4
Load Capacity Tension (lbs.) *	315	500
Load Capacity Shear (lbs.) *	245	525



Wire Hanger - Data	3/16"	1/4"
ANSI Drill Bit Size (in.)	3/16	1/4
Tie-Wire Hole (in.)	3/16	9/32
Head Height (in.)	37/64	41/64
Head Width (in.)	9/64 x 7/16	3/16 x 9/16
Min. Embedment Depth (in.)	1 1/8	1 1/8
Load Capacity Tension (lbs.)*	265	290
Load Capacity Shear (lbs.)*	240	330



* Based on concrete compression strength of 4000 psi using applied safety factor of 4.0. For additional loading information contact factory.

Read safety/installation instruction sheets in packages before use.

Drive Anchors

UPC/Part Number	Catalog Number	Size	Box Qty.
Mushroom Head			
78205153271	ADA-18-100	3/16" x 1"	100
78205153272	ADA-18-125	3/16" x 1 1/4"	100
78205153273	ADA-18-150	3/16" x 1 1/2"	100
78205153274	ADA-18-200	3/16" x 2"	100
78205153275	ADA-18-250	3/16" x 2 1/2"	100
78205153276	ADA-18-300	3/16" x 3"	100
78205153278	ADA-25-100	1/4" x 1"	100
78205153279	ADA-25-125	1/4" x 1 1/4"	100
78205153280	ADA-25-150	1/4" x 1 1/2"	100
78205153281	ADA-25-200	1/4" x 2"	100
78205153282	ADA-25-250	1/4" x 2 1/2"	100
78205153283	ADA-25-300	1/4" x 3"	100

UPC/Part Number	Catalog Number	Head Size	Box Qty.
Rod Hanger			
78205153284	ADA-25RH	1/4"	100
78205153286	ADA-37RH	3/8"	100
Wire Hanger			
78205153277	ADA-18WH	3/16"	100
78205153285	ADA-25WH	1/4"	100

Read safety/installation instruction sheets in packages before use.

Anchors

Sleeve Type Expansion Anchors

- For use in concrete and masonry substrates.
- Suitable for solid and hollow core materials.
- Fits standard fixture holes - no need to undersize anchors for proper fit.
- Sleeve has 360° contact area and reduces concrete stress.
- UL & FM approved.
- Available in Zinc Plated Steel or Type 304 Stainless Steel.



Hex Nut (HN)
Style



Acorn Nut (AN)
Style



Slotted Round
Head (RS) Style

Sleeve Type Expansion - Data	1/4"	3/8"	1/2"	5/8"	3/4"
ANSI Drill Bit Size (in.)	1/4	3/8	1/2	5/8	3/4
Fixture Clearance Hole (in.)	5/16	7/16	9/16	11/16	15/16
Plow Bolt Size (UNC)	#10-24	5/16"-18	3/8"-16	1/2"-13	5/8"-11
Min. Embedment Depth (in.)	5/8	15/8	2 1/4	2 1/4	2 1/4
Load Capacity Tension (lbs) *	155	670	1255	1465	2105
Load Capacity Shear (lbs) *	300	610	1055	1800	2900

* Based on concrete compression strength of 4000 psi using applied safety factor of 4.0. For additional loading contact factory.



Rod Hanger
(RH) Style



Wire Hanger
(WH) Style

Sleeve Type Expansion - Data	Hanger Rod			Wire Hanger
	1/4"	3/8"	1/2"	5/16"
ANSI Drill Bit Size (in.)	1/4	3/8	1/2	5/16
Fixture Clearance Hole (in.)	NA	NA	NA	1/4
Plow Bolt Size (UNC)	#10-24	5/16"-18	3/8"-16	1/4"-20
Coupling Height (in.)	7/8	1	1 1/4	NA
Min. Embedment Depth (in.)	5/8	15/8	2 1/4	1 1/2
Load Capacity Tension (lbs) *	155	670	1255	520
Load Capacity Shear (lbs) *	300	610	1055	380

* Based on concrete compression strength of 4000 psi using applied safety factor of 4.0. For additional loading go to www.cooperblineline.com.

Sleeve Type Expansion Anchors

UPC/Part Number	Catalog Number	Size	Thread Length	Box Qty.
Hex Nut Style				
78101102995	ASA-37-187HN	3/8" x 1 7/8"	1 5/8"	50
78101102996	ASA-37-300HN	3/8" x 3"	1 5/8"	50
78205153400	ASA-37-400HN	3/8" x 4"	1 5/8"	50
78101102997	ASA-50-225HN	1/2" x 2 1/4"	2 1/8"	25
78101102998	ASA-50-300HN	1/2" x 3"	2 1/4"	25
78101102999	ASA-50-400HN	1/2" x 4"	2 1/4"	25
78205153351	ASA-50-525HN	1/2" x 5 1/4"	2 1/4"	25
78101103002	ASA-50-600HN	1/2" x 6"	2 1/4"	10
78101103003	ASA-62-225HN	5/8" x 2 1/4"	2 1/8"	25
78101103004	ASA-62-300HN	5/8" x 3"	2 3/4"	25
78101103005	ASA-62-425HN	5/8" x 4 1/4"	2 3/4"	10
78101103006	ASA-62-600HN	5/8" x 6"	2 3/4"	10
78101103007	ASA-75-250HN	3/4" x 2 1/2"	2 1/8"	10
78101103008	ASA-75-425HN	3/4" x 4 1/4"	3 3/8"	10
78101103009	ASA-75-625HN	3/4" x 6 1/4"	3 3/8"	10

Hex Nut Style - Stainless Steel

78205153343	ASA-37-187HNSS4	3/8" x 1 7/8"	1 5/8"	50
78205153345	ASA-37-300HNSS4	3/8" x 3"	1 5/8"	50
78205153347	ASA-50-225HNSS4	1/2" x 2 1/4"	2 1/8"	25
78205153349	ASA-50-300HNSS4	1/2" x 3"	2 1/4"	25
78205153350	ASA-50-400HNSS4	1/2" x 4"	2 1/4"	25
78205153352	ASA-62-425HNSS4	5/8" x 4 1/4"	2 3/4"	10
78205153353	ASA-75-400HNSS4	3/4" x 4"	3 3/8"	10

Acorn Nut Style

78205153341	ASA-25-62AN	1/4" x 5/8"	1/2"	100
78101102991	ASA-25-137AN	1/4" x 1 3/8"	1 1/8"	100
78101102992	ASA-25-225AN	1/4" x 2 1/4"	1 1/8"	100

Slotted Round Head Style

78205153338	ASA-25-112RS	1/4" x 1 1/8"	1"	100
78205153340	ASA-25-200RS	1/4" x 2"	1 1/8"	100

UPC/Part Number	Catalog Number	Size	Drill Diameter	Box Qty.
Rod Hanger				
78205153339	ASA-25-150RH	1/4" x 1 1/2"	5/16"	50
78205153344	ASA-37-187RH	3/8" x 1 7/8"	3/8"	50
78205153348	ASA-50-225RH	1/2" x 2 1/4"	1/2"	25
Wire Hanger				
78205153342	ASA-31-150WH	5/16" x 1 1/2"	5/16"	100

Read safety/installation instruction sheets in packages before use.

Anchors

Double Expansion Anchors

- For use in concrete, block, brick or stone.
- Double expansion anchor is particularly suited for base materials of questionable strength (job site tests are recommended).
- Internally threaded anchor for easy removability and service work.
- Made of Zamac Alloy material.



Double Expansion - Data	1/4"	3/8"	1/2"	5/8"
ANSI Drill Bit Size (in.)	1/2	3/4	7/8	1
Max. Tightening Torque (ft-lbs)	5	10	20	30
Thread Size (UNC)	1/4"-20	3/8"-16	1/2"-13	5/8"-11
Thread Length In Cone (in.)	1/2	5/8	3/4	7/8
Min. Embedment Depth (in.)	1 1/4	1 3/4	2 1/4	2 1/2
Load Capacity Tension (lbs) *	415	875	1625	1750
Load Capacity Shear (lbs) *	405	1000	1540	2855

* Based on concrete compression strength of 4000 psi using applied safety factor of 4.0. For additional loading information contact factory.

UPC/Part Number	Catalog Number	Rod Size	Anchor Length	Box Qty.
Double Expansion Anchor				
78101103251	ADE-25	1/4"	1 3/8"	50
78101103253	ADE-37	3/8"	2"	50
78101103254	ADE-50	1/2"	2 1/2"	25
78101103256	ADE-62	5/8"	2 3/4"	25

Single Expansion Anchors

- For use in concrete, block, brick or stone.
- Recommended for floor and wall attachments.
- Not recommended for overhead applications.
- Internally threaded anchor for easy removability and service work.
- Made of Zamac Alloy material.



Single Expansion - Data	1/4"	3/8"	1/2"	5/8"
ANSI Drill Bit Size (in.)	1/2	3/4	7/8	1
Max. Tightening Torque (ft-lbs)	5	10	20	30
Thread Size (UNC)	1/4"-20	3/8"-16	1/2"-13	5/8"-11
Thread Length In Cone (in.)	5/16	5/16	7/16	5/8
Min. Embedment Depth (in.)	1 3/8	1 5/8	2 1/2	2 3/4
Load Capacity Tension (lbs) *	500	725	1225	2050
Load Capacity Shear (lbs) *	405	950	1540	2855

* Based on concrete compression strength of 4000 psi using applied safety factor of 4.0. For additional loading information contact factory.

UPC/Part Number	Catalog Number	Rod Size	Anchor Length	Box Qty.
Single Expansion Anchor				
78101103245	ASE-25	1/4"	1 5/16"	50
78101103247	ASE-37	3/8"	1 1/2"	50
78101103248	ASE-50	1/2"	2 1/16"	25
78101103249	ASE-62	5/8"	2 5/8"	25

Read safety/installation instruction sheets in packages before use.

Anchors

Wood Knocker™† Anchors

- Wood-Knocker™ concrete inserts are installed onto wooden forms used to support newly poured concrete floor slabs, roof slabs or walls.
- When the forms are stripped, the color-coded flange is visibly embedded in the concrete surface.
- The unique, six sided impact plate offers resistance to rotation within the concrete as threaded rod is being installed.
- Suitable for overhead installations such as suspending cable tray, pipe hangers, strut and conduit.
- Color coded by size for all trades.
- UL and FM approved.
- Lowest in-place cost.



Wood Knocker™ - Data	1/4"	3/8"	1/2"	5/8"	3/4"
Insert Thread Length (in.)	3/8	5/8	11/16	15/16	1 1/8
Plastic Flange Diameter (in.)	1 3/8	1 3/8	1 3/8	1 5/8	1 5/8
Thread Size (UNC)	1/4"-20	3/8"-16	1/2"-13	5/8"-11	3/4"-10
Overall Length (in.)	1 7/8	1 7/8	1 7/8	1 7/8	1 7/8
Min. Insert Spacing (in.)	9	9	9	12	12
Min. End Distance (in.)	6	6	6	9	9
Load Capacity Tension (lbs) *	930	1200	1200	1160	1160
Load Capacity Shear (lbs) *	370	1330	1840	2800	2800

* Based on normal weight concrete with minimum compression strength of 3000 psi. Allowable load capacities are calculated using applied safety factor of 4.0. For additional loading information contact factory. Minimum embedment depth is 2".

UPC/Part Number	Catalog Number	Rod Diameter	Color	Box Qty.
Wood Knocker				
78205131147	ACPW-25	1/4"	Brown	100
78205131149	ACPW-38	3/8"	Green	100
78205131151	ACPW-50	1/2"	Yellow	100
78205131152	ACPW-62	5/8"	Red	50
78205131153	ACPW-75	3/4"	Purple	50

† Wood Knocker™ is a registered trademark used by Power® Fasteners, Inc.

Bang-It™† Anchors

- Bang-It™ concrete inserts are designed for installation in and through metal composite deck used to support newly poured concrete floors or roof slabs.
- After installation, the protective sleeve of the insert protrudes below the surface of the deck, allowing overhead attachment of threaded rod.
- The unique, six sided impact plate offers resistance to rotation within the concrete as threaded rod is being installed.
- Suitable for overhead installations such as suspending cable tray, pipe hangers, strut and conduit.
- Color coded by size for all trades.
- UL and FM approved.
- Lowest in-place cost.



Bang-It™ - Data	1/4"	3/8"	1/2"	5/8"	3/4"	7/8"
Metal Hole Saw Diameter (in.)	13/16	13/16	13/16	13/16	13/16	13/16
Drilling Speed (rpm)	700-900	700-900	700-900	500-700	500-700	500-700
Insert Thread Length (in.)	3/8	5/8	11/16	15/16	1 1/8	1 5/16
Length of Sleeve (in.)	3 3/8	3 3/8	3 3/8	3 3/8	3 3/8	3 3/8
Thread Size (UNC)	1/4"-20	3/8"-16	1/2"-13	5/8"-11	3/4"-10	7/8"-9
Embedment Depth (in.)	2	2	2	2	2	2
Upper Deck Tension Load (lbs) *	835	1435	1775	2200	2200	2200
Lower Deck Tension Load (lbs) *	835	1115	1115	1115	1115	1115
Upper Deck Shear Load (lbs) *	620	620	620	740	740	740
Lower Deck Shear Load (lbs) *	625	840	840	840	840	840

* Based on normal weight concrete with minimum compression strength of 3000 psi. Allowable load capacities are calculated using applied safety factor of 4.0. For additional loading information contact factory. Minimum insert spacing of 12", minimum end spacing 12".

UPC/Part Number	Catalog Number	Rod Diameter	Color	Box Qty.
Bang-It™				
78205131154	ACPD-25	1/4"	Brown	100
78205131156	ACPD-38	3/8"	Green	100
78205131157	ACPD-50	1/2"	Yellow	100
78205131158	ACPD-62	5/8"	Red	50
78205131166	ACPD-75	3/4"	Purple	50
78205153258	ACPD-87	7/8"	Black	50

Bang-It™ Hole Saws

78205131169	ACPD-HS813	13/16" Carbide Hole Saw for 1/4", 3/8", 1/2"	1
78205131171	ACPD-HS1188	13/16" Carbide Hole Saw for 5/8", 3/4", 7/8"	1

† Bang-It™ is a registered trademark used by Power® Fasteners, Inc.

Read safety/installation instruction sheets in packages before use.

Anchors

Machine Screw Anchors

- For use in concrete, block, brick or stone.
- Not recommended for use in overhead applications.
- Readily accepts machine bolts.
- Internally threaded anchor for easy removability and service work.
- Anchor installation requires shallow embedment.
- Made of Zamac Alloy material.



Machine Screw Anchor - Data	1/4"	3/8"	1/2"
ANSI Drill Bit Size (in.)	1/2	3/4	7/8
Max. Tightening Torque (ft-lbs)	5	10	15
Thread Size (UNC)	1/4"-20	3/8"-16	1/2"-13
Min. Embedment Depth (in.)	7/8	1 1/4	1 1/2
Load Capacity Tension (lbs) *	585	775	1095
Load Capacity Shear (lbs) *	355	825	1135

* Based on concrete compression strength of 4000 psi using applied safety factor of 4.0. For additional loading information contact factory.

UPC/Part Number	Catalog Number	Rod Diameter	Box Qty.
Machine Screw Anchor			
78101103239	AMS-25	1/4"	100
78101103242	AMS-37	3/8"	50
78101103243	AMS-50	1/2"	50
Setting Tool			
78205109765	9221	1/4"	1
78205109767	9231	3/8"	1
78205109768	9241	1/2"	1

Read safety/installation instruction sheets in packages before use.

Self-Tapping Machine Screw Anchors

- For use in normal-weight concrete, structural sand lightweight concrete and concrete over metal deck.
- Anchor design allows for shallow embedment and mechanically interlocks with base material.
- Internally threaded anchor for easy adjustment and removability of threaded rod or bolt.
- Fast anchor installation with a powered impact wrench.
- Suitable for overhead applications such as suspending cable tray, strut, pipe hangers and conduit.
- FM Approved.
- ICC-ES listed, ESR-2272
- Made of Zinc Plated carbon steel.
- Setting tool included.



Self-Tapping Machine Screw - Data	3/8"
ANSI Drill Bit Size (in.)	1/2
Min. Concrete Thickness (in.)	4
Max. Tightening Torque (ft-lbs)	8
Min. Embedment Depth (in.)	1 ⁵ / ₈
Load Capacity Tension (lbs) *	540
Load Capacity Shear (lbs) *	825

* Based on concrete compression strength of 4000 psi in uncracked concrete using applied safety factor of 4.0. For additional loading information contact factory.
For ultimate strength design data in cracked and uncracked concrete, see ICC-ES ESR-2526.

UPC/Part Number	Catalog Number	Size	Thread Depth	Box Qty.
Self-Tapping Machine Screw Anchor				
78205153362	ATM-37	3/8"	11/16"	50
Tool				
78205153363	6407 SD	3/8"	--	1

Read safety/installation instruction sheets in packages before use.

Anchors

Drive Nail Anchors

- For use in concrete, block or brick.
- Anchor is recommended for light duty, tamper-proof applications.
- Not recommended for overhead applications.
- Made of Zamac Alloy material.



Drive Nail - Data	3/16"	1/4"
ANSI Drill Bit Size (in.)	3/16	1/4
Fixture Clearance Hole (in.)	1/4	5/16
Head Height (in.)	7/64	9/64
Head Size, O.D. (in.)	13/32	35/64
Min. Embedment Depth (in.)	3/4	5/8
Load Capacity Tension (lbs) *	125	150
Load Capacity Shear (lbs) *	175	205

* Based on concrete compression strength of 4000 psi using applied safety factor of 4.0. For additional loading information contact factory.

UPC/Part Number	Catalog Number	Size	Box Qty.
Drive Nail Anchor			
78101102964	ADN-18-87	3/16" x 7/8"	100
78101102965	ADN-25-75	1/4" x 3/4"	100
78101102966	ADN-25-100	1/4" x 1"	100
78101102967	ADN-25-125	1/4" x 1 1/4"	100
78101102968	ADN-25-150	1/4" x 1 1/2"	100
78101102969	ADN-25-200	1/4" x 2"	100
78205153306	ADN-25-300	1/4" x 3"	100

Toggle Bolts

- The toggle bolt is a spring wing type hollow wall anchor designed for use in block, wallboard and other hollow base materials.
- Anchor is a two-part assembly consisting of a machine screw and a spring wing toggle.
- Adjustable to accommodate various wall thicknesses up to 2¹/₂".
- Combo round head bolt is provided.
- Made of zinc plated carbon steel.



Toggle Bolt - Data	3/16"		1/4"		3/8"	
	Tension (lbs.)	Shear (lbs.)	Tension (lbs.)	Shear (lbs.)	Tension (lbs.)	Shear (lbs.)
3/8" Wallboard	35	35	55	55	60	65
1/2" Wallboard	45	50	60	60	65	75
5/8" Wallboard	60	60	65	65	75	80
3/4" Wallboard	75	70	80	75	85	90
Hollow Concrete Masonry *	70	70	70	120	195	140

Allowable load capacities are calculated using applied safety factor of 4.0. For additional loading information contact factory.

* Based on hollow wall concrete masonry with minimum compression strength of 1500 psi.

UPC/Part Number	Catalog Number	Drill Diameter	Size	Box Qty.
Toggle Bolt				
78205153354	ATB-18-300	1/2"	3/16" x 3"	50
78205153355	ATB-18-400	1/2"	3/16" x 4"	50
78205153356	ATB-25-300	5/8"	1/4" x 3"	50
78205153357	ATB-25-400	5/8"	1/4" x 4"	50
78205153358	ATB-37-300	7/8"	3/8" x 3"	25
78205153359	ATB-37-400	7/8"	3/8" x 4"	25

Read safety/installation instruction sheets in packages before use.

Anchors

Wall Screws

- One-piece, all steel anchor with high-profile threads for easy fastening into wallboard and other masonry base materials.
- Deep cutting, corkscrew-like threads provide for smooth entry and a strong hold.
- No pre-drilling is required when fastening into wallboard or wood.
- Fastening into concrete, hollow or grout filled block, brick and plaster requires a pre-drilled $\frac{3}{16}$ " ANSI hole.
- Installed with a No. 8 drill bit or No. 2 Phillips driver.
- Made of case hardened carbon steel with chrome finish.



Wall Screw - Data	Minimum Embedment Depth	Load Cap. Tension (lbs.) *	Load Cap. Shear (lbs.) *
Concrete *	$\frac{3}{4}$ "	90	260
$\frac{1}{2}$ " Wallboard	NA	20	60
$\frac{5}{8}$ " Wallboard	NA	35	90
$\frac{3}{4}$ " Plywood	NA	65	150
Grout-Filled Concrete Masonry	1"	55	165
Hollow Concrete Masonry	1"	60	165
Brick Masonry	$\frac{3}{4}$ "	70	120

* Based on concrete compression strength of 4000 psi. Allowable load capacities are calculated using an applied safety factor of 4.0. For additional loading contact factory.

UPC/Part Number	Catalog Number	Size	Head Type	Box Qty.
Wall Screw				
78205153372	AWS-CH	$\frac{3}{16}$ " x $1\frac{1}{4}$ "	Combo	100
78205153373	AWS-OH	$\frac{3}{16}$ " x $1\frac{1}{4}$ "	Oval	100
78205153374	AWS-PH	$\frac{3}{16}$ " x $1\frac{1}{4}$ "	Pan	100

Plastic Screw Anchors

- One-piece anchor designed for light duty applications in wallboard, concrete and masonry.
- Works in hollow or solid base materials.
- Suitable for screws with various thread sizes and styles - screws may be installed with a screw gun.



Plastic Screw Anchor - Data	APS-4	APS-6	APS-8
Drill Diameter (in.)	3/16	1/4	5/16
Screw Size Range	#4-#10	#6-#12	#8-#14
Min. Thread Length (in.)	1 ³ / ₁₆	1 ³ / ₈	1 ¹³ / ₁₆
Min. Hole Diameter (in.)	1 ³ / ₈	1 ⁹ / ₁₆	2
Min. Wall Thickness (in.)	1/4	3/8	1/2
Min. Embedded Thread Length (in.)	1 ⁷ / ₈	2	2 ⁹ / ₁₆
Load Capacity Tension (lbs) *	18	20	22
Load Capacity Shear (lbs) *	32	40	45

* Allowable load capacities are calculated using an applied safety factor of 4.0. For additional loading information contact factory.

UPC/Part Number	Catalog Number	Screw Size	Box Qty.
Plastic Screw Anchors			
78205153315	APS-4	#4 - #10	100
78205153316	APS-6	#6 - #12	100
78205153319	APS-8	#8 - #14	100

Read safety/installation instruction sheets in packages before use.

Anchors

Plastic Hollow Wall Anchors

- Heavy duty hollow wall anchor designed for use in plaster, wallboard, concrete block, or hollow tile.
- Pre-assembled anchor consisting of a carbon steel wing and a locking cap/ratchet leg assembly molded from engineered plastic.
- When compared to traditional toggles, this anchor can be installed in a smaller hole and does not require a fixture or screw to set it.
- Adjustable to accommodate various wall thickness up to 2 1/2".



Plastic Hollow Wall - Data	3/16"	1/4"	3/8"	1/2"
Thread Size (UNC)	3/16"-24	1/4"-20	3/8"-16	1/2"-13
Max. Tightening Torque (ft-lbs)	5	5	5	5
Minimum Clearance (in.)	1 7/8"	1 7/8"	1 7/8"	1 7/8"

Plastic Hollow Wall - Data	3/16"		1/4"		3/8"		1/2"	
	Tension (lbs.)	Shear (lbs.)	Tension (lbs.)	Shear (lbs.)	Tension (lbs.)	Shear (lbs.)	Tension (lbs.)	Shear (lbs.)
3/8" Wallboard	30	60	35	70	35	70	35	75
1/2" Wallboard	35	70	35	75	40	75	40	90
5/8" Wallboard	50	95	55	105	55	105	55	110
3/4" Wallboard	50	110	55	120	60	120	60	120
Hollow Concrete Masonry *	215	150	270	285	285	465	345	595

Allowable load capacities are calculated using an applied safety factor of 4.0. For additional loading information contact factory.

* Based on hollow wall concrete masonry with minimum compression strength of 1500 psi.

UPC/Part Number	Catalog Number	Anchor Size	Drill Dia.	Wall Thickness	Box Qty.
78205153311	APH-18	3/16" x 4"	1/2"	3/8" - 2 1/2"	50
78205153312	APH-25	1/4" x 4"	1/2"	3/8" - 2 1/2"	50
78205153313	APH-37	3/8" x 4"	3/4"	3/8" - 2 1/2"	25
78205153314	APH-50	1/2" x 4"	3/4"	3/8" - 2 1/2"	25

Self-Drilling Wallboard Anchors

- One-piece self drilling anchor designed for use in hollow wallboard for light to medium duty loads.
- Ideal for mounting electrical fixtures, phone systems, and miscellaneous hardware.
- APD/AZD designed for use in $\frac{3}{8}$ " to 1" wallboard.
- APDM/AZDM designed for use in $\frac{3}{8}$ " to $\frac{5}{8}$ " wallboard.
- Kit includes 50 anchors, 50 screws and #2 Phillips Drive Bit.
- Available in engineered Nylon and Zamac Alloy.



Self-Drilling Wallboard Anchor - Data	APD/AZD	APDM/AZDM
Anchor Length (in.)	1 ¹¹ / ₁₆	1 ⁵ / ₁₆
Min. Screw Engagement (in.)	$\frac{3}{4}$	$\frac{3}{4}$

Self-Drilling Wallboard Anchor - Data	APD/AZD		APDM/AZDM	
	Tension (lbs.)	Shear (lbs.)	Tension (lbs.)	Shear (lbs.)
$\frac{3}{8}$ " Wallboard	15	15	10	15
$\frac{1}{2}$ " Wallboard	15	20	15	15
$\frac{5}{8}$ " Wallboard	20	25	20	20
$\frac{3}{4}$ " Wallboard	20	25	20	20

Allowable load capacities are calculated using an applied safety factor of 4.0. For additional loading information contact factory.

UPC/Part Number	Catalog Number	Screw Size	Box Qty.
Self-Drilling Wallboard Anchor			
78101103314	APD-8K	#8 x 1"	50
78101103318	AZD-8K	#8 x 1"	50
78205153310	APDM-6K	#6 x 1"	50
78205153375	AZDM-6K	#6 x 1"	50

Read safety/installation instruction sheets in packages before use.

Anchors

Plastic Conical Anchors

- Designed for use with lightweight fixtures.
- Recommended for use in concrete, block and brick.
- Recommended for light duty static applications where holding power is not critical.
- Not recommended for overhead use.
- Kit includes 100 anchors, 100 screws and one drill bit.
- Made of engineered plastic.



Plastic Conical Anchor - Data	#8		#10 - #12	
	Tension (lbs.)	Shear (lbs.)	Tension (lbs.)	Shear (lbs.)
Nominal Weight Concrete *	110	70	140	90
Hollow Concrete Masonry **	60	45	70	55
Clay Brick Masonry ***	30	50	55	65
Minimum Embedment Depth	7/8"	7/8"	1"	1"

* Based on concrete compression strength of 4000 psi.

** Based on hollow concrete masonry with minimum compression strength of 1500 psi.

*** Based on clay brick masonry with minimum compression strength of 1500 psi.

Loads contain an applied safety factor of 4.0. For additional loading information contact factory.

UPC/Part Number	Catalog Number	Screw Size	Box Qty.
78205153307	APC-8K	#8 x 1"	100
78205153308	APC-10K	#10 x 1"	100
78205153309	APC-12K	#12 x 1"	100

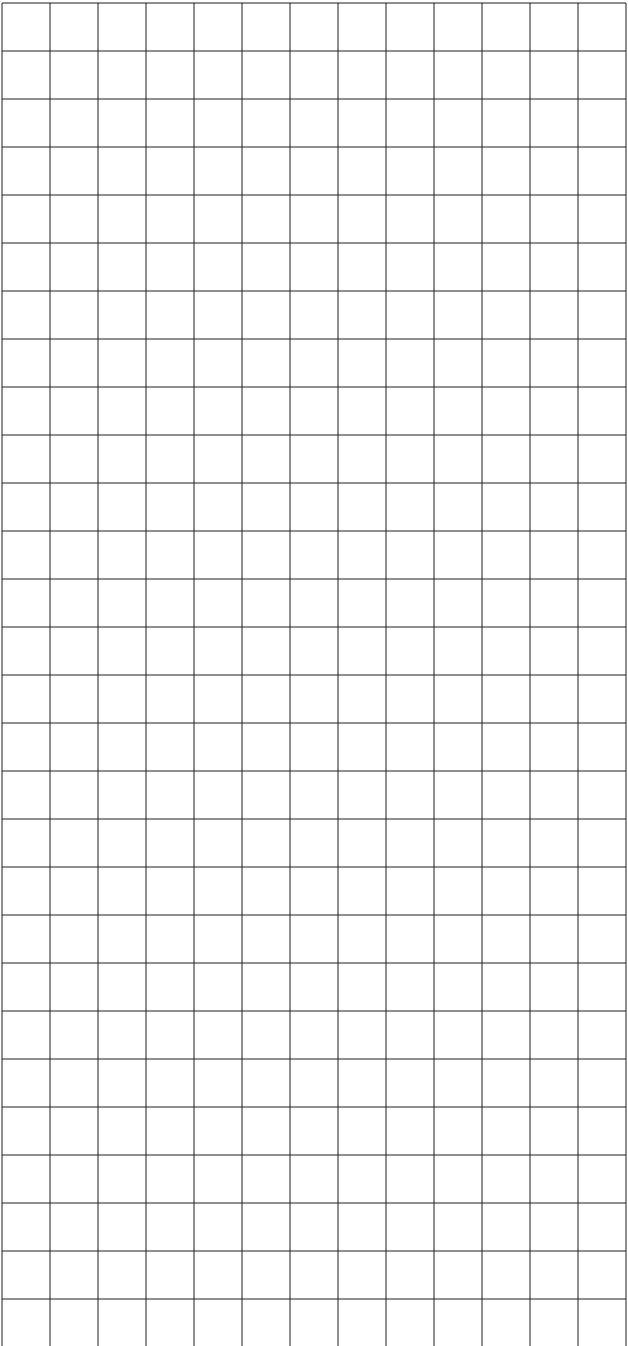

Code Compliance for Spring Steel Fasteners Based on the 2005 NEC®

Eaton's B-Line Business has recognized the need for a reference source, detailing the National Electrical Code requirements for Spring Steel Fasteners. The following pages are reprinted portions of the 2005 NEC. These sections address nearly every aspect of fastener installations and offer design solutions for the electrical industry. If a topic has not been covered sufficiently to answer a specific question or if additional information is desired, contact our engineering department.

The following information has been carefully checked for accuracy and is believed to be correct and current. No warranty, either expressed or implied, is made as to either its applicability to, or its compatibility with, specific requirements, of this information, nor for damages consequent to its use. All design characteristics, specifications, tolerances and similar information are subject to change without notice.

To obtain a copy of the NEC® contact:
National Fire Protection Association
1 Batterymarch Park
P.O. Box 9101
Quincy, Massachusetts 02269-9101
1-800-344-3555

National Electrical Code® and *NEC®*
are registered trademarks of the
National Fire Protection Association, Inc.
Quincy, MA 02269.

Reprinted with permission from NFPA 70-2005, the *National Electrical Code®*, Copyright® 2005, National Fire Protection Association, Quincy, MA 02269.

This reprinted material is not the complete and official position of the National Fire Protection Association, on the referenced subject which is represented only by the standard in its entirety.

90.4 Enforcement. This *Code* is intended to be suitable for mandatory application by governmental bodies that exercise legal jurisdiction over electrical installations, including signaling and communications systems, and for use by insurance inspectors. The authority having jurisdiction for enforcement of the *Code* has the responsibility for making interpretations of the rules, for deciding upon the approval of equipment and materials, and for granting the special permission contemplated in a number of the rules.

By special permission, the authority having jurisdiction may waive specific requirements in this *Code* or permit alternate methods where it is assured that equivalent objectives can be achieved by establishing and maintaining effective safety. *

This *Code* may require new products, constructions, or materials that may not yet be available at the time the *Code* is adopted. In such event, the authority having jurisdiction may permit the use of the products, constructions, or materials that comply with the most recent previous edition of this *Code* adopted by the jurisdiction.

Article 100 - Definitions

Listed. Equipment, materials, or services included in a list published by an organization that is acceptable to the authority having jurisdiction and concerned with evaluation of products or services, that maintains periodic inspection of production of listed equipment or materials or periodic evaluation of services, and whose listing states that the equipment, material, or services either meets appropriate designated standards or has been tested and found suitable for a specific purpose.

FPN: The means for identifying listed equipment may vary for each organization concerned with product evaluation, some of which do not recognize equipment as listed unless it is labeled. Use of the system employed by the listing organization allows the authority having jurisdiction to identify a listed product.

***Note:** Local codes may override certain requirements of the National Electrical Code®. Consult your local inspector for further details.

Reprinted with permission from NFPA 70-2005, the *National Electrical Code*®, Copyright® 2005, National Fire Protection Association, Quincy, MA 02269.

This reprinted material is not the complete and official position of the National Fire Protection Association, on the referenced subject which is represented only by the standard in its entirety.

300.4 Protection Against Physical Damage.

Where subject to physical damage, conductors shall be adequately protected.

(A) Cables and Raceways through Wood Members.

- (1) **Bored Holes.** . . . , holes shall be bored so that the edge of the hole is not less than 32mm (1¹/₄ in.) from the nearest edge of the wood member. Where this distance cannot be maintained, the cable or raceway shall be protected from penetration by screws or nails by a steel plate or bushing, at least 1.6 mm (1/16 in.) thick, and of appropriate length and width installed to cover the area of the wiring. (See Figure 1)

Exception No. 1: Steel plates shall not be required to protect RMC, IMC, RNC, or EMT.

*Exception No. 2: A **listed** and marked steel plate less than 1.6 mm (1/16 in.) thick that provides equal or better protection against nail or screw penetration shall be permitted.*

- (2) **Notches in Wood.** . . . , cables or raceways shall be permitted to be laid in notches in wood studs, joists, rafters, or other wood members where the cable or raceway at those points is protected against nails or screws by a steel plate at least 1.6 mm (1/16 in.) thick, and of appropriate length and width, installed to cover the area of the wiring. The steel plate shall be installed before the building finish is applied. (See Figure 1)

Exception: See Exceptions 1 & 2 from (1) Bored Holes

(B) Nonmetallic-Sheathed Cables and Electrical Nonmetallic Tubing through Metal Framing Members.

- (1) **Nonmetallic-Sheathed Cable.** . . . where nonmetallic-sheathed cables pass through either factory or field punched, cut or drilled slots or holes in metal members, the cable shall be protected by listed bushings or listed grommets covering all metal edges that are securely fastened in the opening prior to installation of the cable. (See Figure 2)

- (2) **Nonmetallic-Sheathed Cable and Electrical Nonmetallic Tubing.** Where nails or screws are likely to penetrate nonmetallic-sheathed cable or electrical nonmetallic tubing, a steel sleeve, steel plate, or steel clip not less than 1.6 mm (1/16 in.) in thickness shall be used to protect the cable or tubing. (See Figure 1)

Exception: See Exception 2 from (A)(1) Bored Holes

(D) Cables and Raceways Parallel to Framing Members and Furring Strips.

... , the cable or race way shall be installed and supported so that the nearest outside surface of the cable or raceway is not less than 32 mm (1¹/₄ in.) from the nearest edge of the framing member or furring strips where nails or screws are likely to penetrate. Where this distance cannot be maintained, the cable or raceway shall be protected from penetration by nails or screws by a steel plate, sleeve, or equivalent at least 1.6 mm (1¹/₁₆ in.) thick

(See Figures 1, 3, 4)

Exception 1: See Exception 1 from (A)(1) Bored Holes

Exception No. 2: For concealed work in finished buildings, or finished panels for prefabricated buildings where such supporting is impracticable, it shall be permissible to fish the cables between access points.

Exception 3: See Exception 2 from (A)(1) Bored Holes

(E) Cables and Raceways Installed in Shallow Grooves.

... , shall be protected by 1.6 mm (1¹/₁₆ in.) thick steel plate, sleeve, or equivalent or by not less than 32 mm (1¹/₄ in.) free space for the full length of the groove in which the cable or raceway is installed.

(See Figure 1)

Exception: See Exceptions 1 & 2 from (A)(1) Bored Holes

Figure 1 - BM3 & BM3M

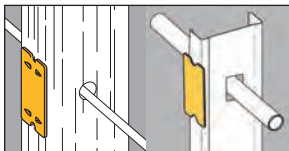

Figure 2 - BM1/BM2

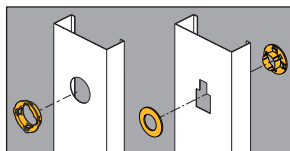
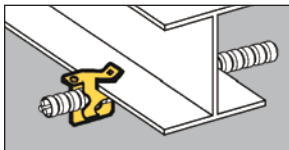

Figure 3 - BRC4 & BRC6M



Figure 4 - BX4



Reprinted with permission from NFPA 70-2005, the *National Electrical Code*®, Copyright® 2005, National Fire Protection Association, Quincy, MA 02269.

This reprinted material is not the complete and official position of the National Fire Protection Association, on the referenced subject which is represented only by the standard in its entirety.

300.11 Securing and Supporting.

(A) Secured in Place. Raceways, cable assemblies, boxes, cabinets, and fittings shall be securely fastened in place. Support wires that do not provide secure support shall not be permitted as the sole support. Support wires and associated fittings that provide secure support and that are installed in addition to the ceiling grid support wires shall be permitted as the sole support. Where independent support wires are used, they shall be secured at both ends. Cables and race ways shall not be supported by ceiling grids.

(1) Fire Rated Assemblies. Wiring located within the cavity of a fire-rated floor-ceiling or roof-ceiling assembly shall not be secured to, or supported by, the ceiling assembly, including the ceiling support wires. An independent means of secure support shall be provided and shall be permitted to be attached to the assembly. Where independent support wires are used, they shall be distinguishable by color, tagging, or other effective means from those that are part of the fire-rated design.

Exception: *The ceiling support system shall be permitted to support wiring and equipment that have been tested as part of the fire-rated assembly.*

(2) Non-Fire-Rated Assemblies. Wiring located within the cavity of a non-fire-rated floor-ceiling or roof-ceiling assembly shall not be secured to, or supported by, the ceiling assembly, including the ceiling support wires. An independent means of secure support shall be provided.

Exception: *The ceiling support system shall be permitted to support branch-circuit wiring and associated equipment where installed in accordance with the ceiling system manufacturer's instructions.*

Note: A previously acceptable practice, namely supporting cable and raceways by the ceiling grid, is no longer allowed. The intent of Article 300.11 is simple: an independent means of secure support must be provided for cable assemblies, raceways, boxes, etc. (See Figures 5 - 8)

Typical Drop Wire / Rod Applications

Additional drop wires, which are installed specifically for cable support, must be secured at both ends. When independent wires are used in fire-rated assemblies, they must be distinguishable from those wires that are part of the fire-rated assembly. B-Line's BA-311 series can be used to secure support wire to the ceiling grid. Its bright yellow color allows it to be easily recognized by inspectors. (See Figure 8)

Upper Attachments

Figure 5 - BE Series

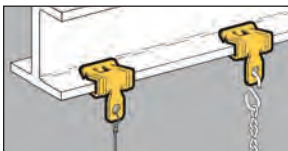

Figure 6 - BF3 Series & BF4 Series

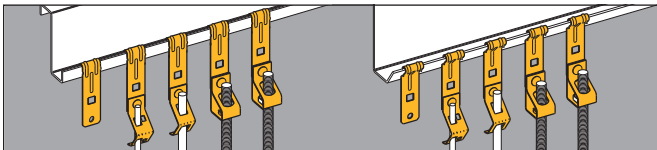

Figure 7 - BG-8-12-S18-W2

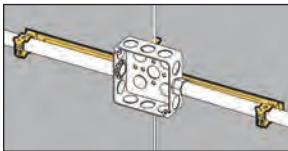
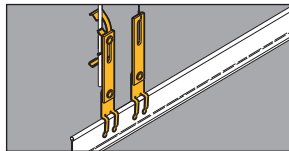

Figure 8 - BA311



Reprinted with permission from NFPA 70-2005, the *National Electrical Code*®, Copyright® 2005, National Fire Protection Association, Quincy, MA 02269.

This reprinted material is not the complete and official position of the National Fire Protection Association, on the referenced subject which is represented only by the standard in its entirety.

310.15 Ampacities For Conductors Rated 0-2000 Volts.

(B) Tables

(2) Adjustment Factors.

- (a) More Than Three Current-Carrying Conductors in a Raceway or Cable. Where the number of current-carrying conductors in a raceway or cable exceeds three, or where single conductors or multiconductor cables are stacked or bundled longer than 600 mm (24 in.) without maintaining spacing and are not installed in raceways, the allowable ampacity of each conductor shall be reduced as shown in Table 310.15(B)(2)(a). Each current-carrying conductor of a paralleled set of conductors shall be counted as a current-carrying conductor.

FPN No. 1: See Annex B, Table B.310.11, for adjustment factors for more than three current-carrying conductors in a raceway or cable with load diversity.

FPN No. 2: See 366.23(A), for correction factors for conductors in sheet metal auxiliary gutters and 376.22 for correction factors for conductors in metal raceways.

Exception No. 1: Where conductors of different systems, as provided in 300.3, are installed in a common raceway or cable, the derating factors shown in Table 310.15(B)(2)(a) shall apply only to the number of power and lighting conductors (Articles 210, 215, 220, and 230).

Exception No. 2: For conductors installed in cable trays, the provisions of 392.11 shall apply.

Exception No. 3: Derating factors shall not apply to conductors in nipples having a length not exceeding 600 mm (24 in.).

Exception No. 4: Derating factors shall not apply to underground conductors entering or leaving an outdoor trench if those conductors have physical protection in the form of rigid metal conduit, intermediate metal conduit, or rigid nonmetallic conduit having a length not exceeding 3.05 m (10 ft) and if the number of conductors does not exceed four.

Reprinted with permission from NFPA 70-2005, the *National Electrical Code*®, Copyright® 2005, National Fire Protection Association, Quincy, MA 02269.

This reprinted material is not the complete and official position of the National Fire Protection Association, on the referenced subject which is represented only by the standard in its entirety.

Exception No. 5: Adjustment factors shall not apply to Type AC cable or to Type MC cable without an overall outer jacket under the following conditions:

- (1) Each cable has not more than three current-carrying conductors.
- (2) The conductors are 12 AWG copper.
- (3) Not more than 20 current-carrying conductors are bundled, stacked, or supported on "bridle rings".
(See Figure 9)

A 60 percent adjustment factor shall be applied where current-carrying conductors in these cables that are stacked or bundled longer than 600 mm (24 in.) without maintaining spacing exceeds 20.

- (b) More Than One Conduit, Tube, or Raceway Spacing between conduits, tubing, or raceways shall be maintained.

Figure 9 - Bridle Rings

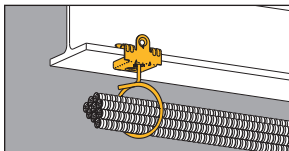
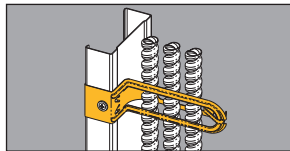

Figure 10 - BRC6M



Reprinted with permission from NFPA 70-2005, the *National Electrical Code*®, Copyright® 2005, National Fire Protection Association, Quincy, MA 02269.

This reprinted material is not the complete and official position of the National Fire Protection Association, on the referenced subject which is represented only by the standard in its entirety.

NEC Requirements

314.23 Supports. Enclosures within the scope of this article shall be supported in accordance with one or more of the provisions in 314.23 (A) through (H).

(C) Mounting in Finished Surfaces. An enclosure mounted in a finished surface shall be rigidly secured thereto by clamps, anchors, or fittings identified for the application. *(See Figures 11 & 12)*

(D) Suspended Ceilings. An enclosure mounted to structural or supporting elements of a suspended ceiling shall be not more than 1650 cm³ (100 in.³) in size and shall be securely fastened in place in accordance with either (D)(1) or (D)(2).

(1) Framing Members. An enclosure shall be fastened to the framing members by mechanical means such as bolts, screws, or rivets, or by the use of clips or other securing means identified for use with the type of ceiling framing member(s) and enclosure(s) employed. . . . *(See Figure 13)*

(2) Support Wires. The installation shall comply with the provisions of 300.11(A). The enclosure shall be secured, using methods identified for the purpose to ceiling support wire(s), including any additional support wire(s) installed for that purpose. Support wire(s) used for enclosure support shall be fastened at each end so as to be taut within the ceiling cavity. *(See Figure 14)*

(E) Raceway Supported Enclosures, Without Devices, Luminaries (Fixtures), or Lampholders.

. . . It shall be supported by two or more conduits threaded wrenchtight into the enclosure or hubs. Each conduit shall be secured within 900 mm (3 ft) of the enclosure, or within 450 mm (18 in.) of the enclosure if all conduit entries are on the same side. *(See Figure 15)*

(F) Raceway Supported Enclosures, With Devices, Luminaries (Fixtures), or Lampholders. . . . It

shall be supported by two or more conduits threaded wrenchtight into the enclosure or hubs. Each conduit shall be secured within 450 mm (18 in.) of the enclosure. *(See Figure 15)*

314.27 Outlet Boxes

(B) Maximum Luminaire (Fixture) Weight. Outlet boxes or fitting installed as required by 314.23 shall be permitted to support luminaries (lighting fixtures) weighing 23 kg (50 lbs.) or less. A luminaire (lighting fixture) that weighs more than 23 kg (50 lbs.) shall be supported independently of the outlet box unless the outlet box is listed for the weight to be supported. *(See Figure 13)*

Reprinted with permission from NFPA 70-2005, the *National Electrical Code*®, Copyright® 2005, National Fire Protection Association, Quincy, MA 02269.

This reprinted material is not the complete and official position of the National Fire Protection Association, on the referenced subject which is represented only by the standard in its entirety.

(D) Boxes at Ceiling-Suspended (Paddle) Fan Outlets.

Outlet boxes or outlet box systems used as the sole support of a ceiling-suspended (paddle) fan shall be listed, shall be marked by their manufacturer as suitable for this purpose, and shall not support ceiling-suspended (paddle) fans that weigh more than 32 kg (70 lb). For outlet boxes or outlet box systems designed to support of a ceiling-suspended (paddle) fans that weigh more than 16 kg (35 lb), the required marking shall include the maximum weight to be supported.

(See Figure 16)

Figure 11 - BB4-23

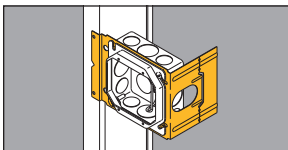

Figure 12 - BB9 & BB12



Figure 13 - BA50

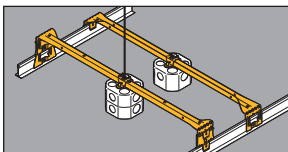

Figure 14 - BG-8-12-S18-W2

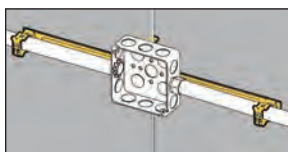

Figure 15 - BG-8-12-S18-U-2-4

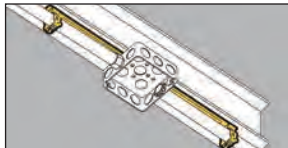
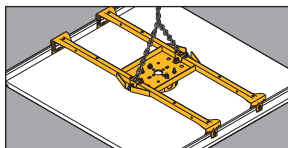

Figure 16 - BA50F



Reprinted with permission from NFPA 70-2005, the *National Electrical Code*®, Copyright® 2005, National Fire Protection Association, Quincy, MA 02269.

This reprinted material is not the complete and official position of the National Fire Protection Association, on the referenced subject which is represented only by the standard in its entirety.

NEC Requirements

Article 320 Armored Cable : Type AC

320.17 Through or Parallel to Framing Members.

Type AC cable shall be protected in accordance with 300.4 (A), (C), and (D) where installed through or parallel to framing members. (See Figures 17 & 18)

320.30 Securing and Supporting.

- (A) **General.** Type AC shall be supported and secured by staples, cable ties, straps, hangers, or similar fittings, designed and installed so as not to damage the cable.
- (B) **Securing.** Unless otherwise provided, Type AC cable shall be secured within 300 mm (12 in.) of every out let box, junction box, cabinet, or fitting and at intervals not exceeding 1.4 m (4¹/₂ ft) where installed on or across framing members. (See Figures 19 -22)
- (C) **Supporting.** Unless otherwise provided, Type AC cable shall be supported at intervals not exceeding 1.4 m (4¹/₂ ft). Horizontal runs of Type AC cable installed in wooden or metal framing members or similar supporting means shall be considered supported where such support does not exceed 1.4 m (4¹/₂ ft) intervals.

Article 330 Metal-Clad Cable : Type MC

330.17 Through or Parallel to Framing Members.

Type MC cable shall be protected in accordance with 300.4 (A), (C), and (D) where installed through or parallel to framing members. (See Figures 17 & 18)

330.30 Securing and Supporting.

- (A) **General.** Type MC shall be supported and secured by staples, cable ties, straps, hangers, or similar fittings or other approved means designed and installed so as not to damage the cable.
- (B) **Securing.** Unless otherwise provided, cables shall be secured at intervals not exceeding 1.8 m (6 ft). Cables containing four or fewer conductors sized no larger than 10 AWG shall be secured within 300 mm (12 in.) of every box, cabinet, fitting or other cable termination. (See Figure 19 - 22)
- (C) **Supporting.** Unless otherwise provided, cables shall be supported at intervals not exceeding 1.8 m (6ft). Horizontal runs of Type MC cable installed in wooden or metal framing members or similar supporting means shall be considered supported and secured where such support does not exceed 1.8 m (6 ft) intervals.

Article 334 Nonmetallic Sheathed Cables

334.17 Through or Parallel to Framing Members.

Type NM, NMC, or NMS cable shall be protected in accordance with 300.4 where installed through or

Reprinted with permission from NFPA 70-2005, the *National Electrical Code*®, Copyright® 2005, National Fire Protection Association, Quincy, MA 02269.

This reprinted material is not the complete and official position of the National Fire Protection Association, on the referenced subject which is represented only by the standard in its entirety.

parallel to framing members. Grommets used as required in 300.4(B)(1) shall remain in place and be **listed** for the purpose of cable protection.

(See Figures 17 & 18)

334.30 Securing and Supporting. Nonmetallic-sheathed cable shall be supported and secured by staples, cable ties, straps, hangers, or similar fittings designed and installed so as not to damage the cable, at intervals not exceeding 1.4 m (4¹/₂ ft) and within 300 mm (12 in.) of every outlet box, junction box, cabinet, or fitting. Flat cables shall not be stapled on edge. Sections of cable protected from physical damage by raceway shall not be required to be secured within the raceway.

(See Figures 19 - 22)

(A) Horizontal Runs Through Holes and Notches.

In other than vertical runs, cables installed in accordance with 300.4 shall be considered to be supported and secured where such support does not exceed 1.4 m (4¹/₂ ft) intervals and the nonmetallic-sheathed cable is securely fastened in place by an approved means within 300 mm (12 in.) of each box, cabinet, conduit body, or other nonmetallic-sheathed cable termination.

FPN: See 314.17(C) for support where nonmetallic boxes are used.

Figure 17 - BM1/BM2

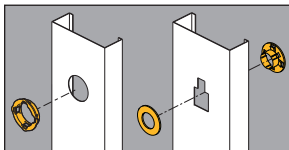

Figure 18 - BM3 & BM3M

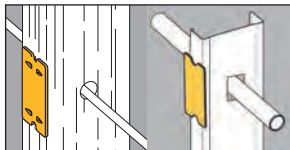

Figure 19 - BG-8-12-H7

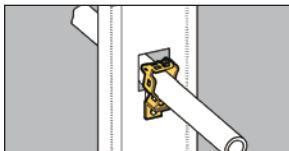

Figure 20 - BRC4 & BRC6M

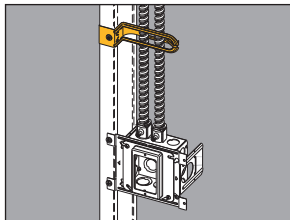

Figure 21 - BX5

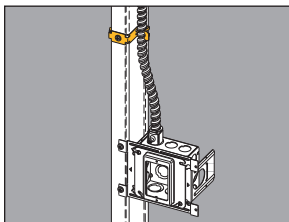
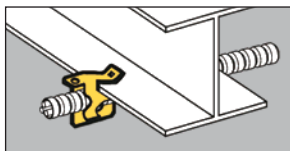

Figure 22 - BX4



Reprinted with permission from NFPA 70-2005, the *National Electrical Code*®, Copyright® 2005, National Fire Protection Association, Quincy, MA 02269.

This reprinted material is not the complete and official position of the National Fire Protection Association, on the referenced subject which is represented only by the standard in its entirety.

NEC Requirements

Article 344 Rigid Metal Conduit : Type RMC

344.30 Securing and Supporting.

(A) Securely Fastened. RMC shall be securely fastened within 900 mm (3 ft) of each outlet box, junction box, device box, cabinet, conduit body, or other conduit termination. Fastening shall be permitted to be increased to a distance of 1.5 m (5 ft) where structural members do not readily permit fastening within 900 mm (3 ft). Where approved, conduit shall not be required to be securely fastened within 900 mm (3 ft) of the service head for above-the-roof termination of a mast.

(See Figures 23 - 25)

(B) Supports. RMC shall be supported in accordance with one of the following:

- (1) Conduit shall be supported at intervals not exceeding 3 m (10 ft).
- (2) The distance between supports for straight runs of conduit shall be permitted in accordance with Table 344.30(B)(2),
- (3) Exposed vertical risers from industrial machinery or fixed equipment shall be permitted to be supported at intervals not exceeding 6 m (20 ft)
- (4) Horizontal runs of RMC supported by openings through framing members at intervals not exceeding 3 m (10 ft) and securely fastened within 900 mm (3 ft) of termination points shall be permitted. *(See Figure 26)*

Article 348 Flexible Metal Conduit: Type FMC

348.30 Securing and Supporting.

(A) Securely Fastened. FMC shall be securely fastened in place by an approved means within 300 mm (12 in.) of each box, cabinet, conduit body, or other conduit termination and shall be supported and secured at intervals not to exceed 1.4 m (4¹/₂ ft).

(See Figures 23 - 25)

(B) Supports. Horizontal runs of FMC supported by openings through framing members at intervals not greater than 1.4 m (4¹/₂ ft) and securely fastened within 300 mm (12 in) of termination points shall be permitted. *(See Figure 26)*

* *See NFPA 70-2005 for exceptions.*

Article 358 Electrical Metallic Tubing - Type EMT

358.30 Securing and Supporting.

(A) Securely Fastened. EMT shall be securely fastened in place at least every 3 m (10 ft). In addition, each EMT run between termination points shall be securely fastened within 900 mm (3 ft) of each outlet box, junction box,

Reprinted with permission from NFPA 70-2005, the *National Electrical Code*®, Copyright© 2005, National Fire Protection Association, Quincy, MA 02269.

This reprinted material is not the complete and official position of the National Fire Protection Association, on the referenced subject which is represented only by the standard in its entirety.

device box, cabinet, conduit body, or other tubing termination. (See Figures 23 - 25)

Exception No. 1: Fastening of unbroken lengths shall be permitted to be increased to a distance of 1.5 m (5 ft) where structural members do not readily permit fastening within 900 mm (3 ft).

Exception No. 2: For concealed work in finished buildings or prefinished wall panels where such securing is impracticable, unbroken lengths (with out coupling) of EMT shall be permitted to be fished.

- (B) Supports.** Horizontal runs of EMT supported by openings through framing members at intervals not greater than 3 m (10 ft) and securely fastened within 900 mm (3 ft) of termination points shall be permitted. (See Figure 26)

Article 362

Electrical Nonmetallic Tubing - Type ENT

362.30 Securing and Supporting.

- (A) Securely Fastened.** ENT shall be securely fastened at intervals not exceeding 900 mm (3 ft). In addition, ENT shall be securely fastened in place within 900 mm (3 ft) of each outlet box, device box, junction box, cabinet, or fitting where it terminates. (See Figures 23 - 25)

Exception No. 1: Lengths not exceeding a distance of 1.8 m (6 ft) from a luminaire (fixture) terminal connection for tap connection to lighting luminaires (fixtures) shall be permitted without being secured.

Exception No. 2: Lengths not exceeding 1.8 m (6 ft) from the last point where the raceway is securely fastened for connection within an accessible ceiling to luminaire(s) [lighting fixture(s)] or other equipment.

- (B) Supports.** Horizontal runs of ENT supported by openings in framing members at intervals not exceeding 900 mm (3 ft) of termination points shall be permitted. (See Figure 26)

Figure 23 - BG-8-12-S18-U-2-4

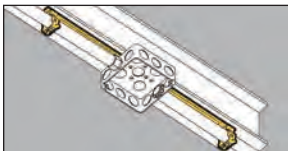

Figure 25 - BG-8-12-B1

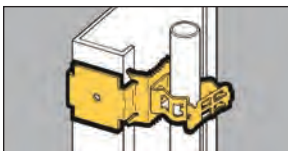

Figure 24 - BB38

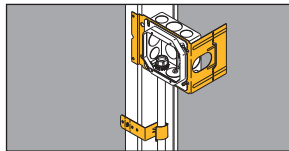
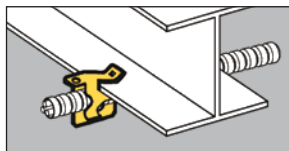

Figure 26 - BX4



Reprinted with permission from NFPA 70-2005, the *National Electrical Code*®, Copyright® 2005, National Fire Protection Association, Quincy, MA 02269.

This reprinted material is not the complete and official position of the National Fire Protection Association, on the referenced subject which is represented only by the standard in its entirety.

NEC Requirements

Article 410 Luminaries (Lighting Fixtures), Lampholders, and Lamps

410.16 Means of Support.

(A) Outlet Boxes. Outlet boxes or fittings installed as required by 314.23 and complying with the provisions of 314.27(A) and 314.27(B) shall be permitted to support luminaries (fixtures).

(C) Suspended Ceilings. Framing members of suspended ceiling systems used to support luminaries (fixtures) shall be securely fastened to each other and shall be securely attached to the building structure at appropriate intervals. Luminaries (fixtures) shall be securely fastened to the ceiling framing member by mechanical means such as bolts, screws, or rivets.

Listed clips identified for use with the type of ceiling framing member(s) and luminaire(s) [fixture(s)] shall also be permitted. *(See Figures 27 - 31)*

410.104 Fastening. Lighting track shall be securely mounted so that each fastening is suitable for supporting the maximum weight of luminaries (fixtures) that can be installed. Unless identified for supports at greater intervals, a single section 1.2 m (4 ft.) or shorter in length shall have two supports, and, where installed in a continuous row, each individual section of not more than 1.2 m (4 ft.) in length shall have one additional support. *(See Figure 30)*

422.18 Support of Ceiling-Suspended (Paddle) Fans

Ceiling-suspended (paddle) fans shall be supported independently of an outlet box or by **listed** outlet box or outlet box systems identified for the use and installed in accordance with 314.27(D). *(See Figure 32)*

Article 800 Communication Circuits

800.24 Mechanical Execution of Work.

Communications circuits and equipment shall be installed in a neat and workmanlike manner. Cables installed exposed on the surface of ceilings and sidewalls shall be supported by the building structure in such a manner that the cable will not be damaged by normal building use. Such cables shall be secured by straps, staples, hangers, or similar fittings designed and installed so as not to damage the cable. The installation shall also conform with 300.4(D) and 300.11.

FPN: Accepted industry practices are described in ANSI/NECA/BICSI 568-2001, Standard for Installing Commercial Building Telecommunications Cabling, and other ANSI-approved installation standards.

Reprinted with permission from NFPA 70-2005, the *National Electrical Code*®, Copyright® 2005, National Fire Protection Association, Quincy, MA 02269.

This reprinted material is not the complete and official position of the National Fire Protection Association, on the referenced subject which is represented only by the standard in its entirety.

Figure 27 - BA15

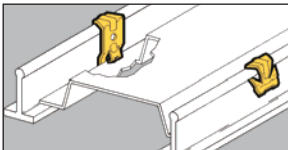

Figure 28 - BA1



Figure 29 - BA40

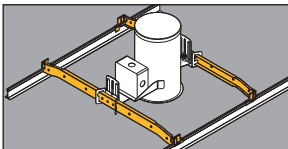

Figure 30 - BA 4-16 Series

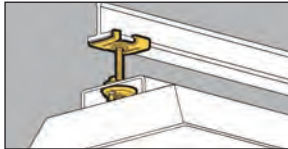

Figure 31 - BAX Series

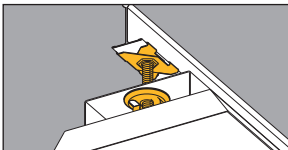
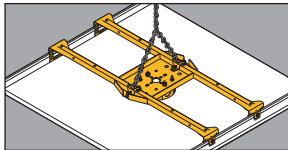

Figure 32 - BA50F



Reprinted with permission from NFPA 70-2005, the *National Electrical Code*®, Copyright® 2005, National Fire Protection Association, Quincy, MA 02269.

This reprinted material is not the complete and official position of the National Fire Protection Association, on the referenced subject which is represented only by the standard in its entirety.

ANSI/TIA/EIA-569-A

4. Horizontal pathways and related spaces

4.6 Ceiling pathway

4.6.2 Design guidelines

4.6.2.1 Planning. The design shall provide a suitable means for supporting cable from the telecommunications closet to the work areas to be served. Cable shall not be laid directly on the ceiling tile or rails.

4.6.2.2 Clearance. A minimum of 75 mm (3 in.) clear vertical space shall be available above the ceiling tiles for the horizontal cabling and pathway. (See Figure 33)

4.6.5 Cable support

4.6.5.1 Where zone conduit or cable tray is not available in a suspended ceiling space and where telecommunications cables are allowed to be placed in the ceiling, adequate open-top cable supports, located on 1220-1525 mm (48-60 inch) centers, shall be provided. Where larger quantities of cables (50-75 cables) bunched together in the ceiling at a congested area, such as close to the telecommunications closet, special supports shall be designed and installed to carry the additional weight. (See Figures 33 & 34)

4.6.5.2 A suspended ceiling support rod or wire may be used to mount appropriate cable fasteners loaded with multiple cables up to the total weight for which the fastener is approved. The T-bar rail of a suspended ceiling may be used to mount appropriate cable fasteners loaded with cable up to a total weight of 0.7 kg/m (0.45 lb/ft). The fastener design shall not interfere with the inserting or removing of the ceiling tile. (See Figures 33 & 34)

NOTES

- 1) A weight of 1.0 kg (2.2 lbs.) or 0.7 kg/m with spacing of support wire/rod at 1.5 m (5 ft.) is equivalent to a bundle of sixteen 4-pair 24 AWG UTP cables, including fasteners.
- 2) If any side pull is exerted on the support wire, like a turn in direction of the cables, the level of the ceiling tee rail could be affected.

Reprinted with permission from NFPA 70-2005, the *National Electrical Code*®, Copyright® 2005, National Fire Protection Association, Quincy, MA 02269.

This reprinted material is not the complete and official position of the National Fire Protection Association, on the referenced subject which is represented only by the standard in its entirety.

Figure 33 - BCHxx-A28

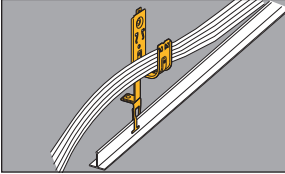
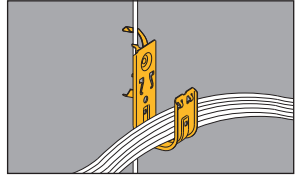

Figure 34 - BCHxx-W2



Reprinted with permission from NFPA 70-2005, the *National Electrical Code*®, Copyright® 2005, National Fire Protection Association, Quincy, MA 02269.

This reprinted material is not the complete and official position of the National Fire Protection Association, on the referenced subject which is represented only by the standard in its entirety.

Reference Data

Cable Hook Technical Data

Single-Sided Single-Tier Cable Fasteners

Hook Size	'A'	'B'	'C'	'D'	'E'	'F'	'G'	'H'
In.	In.	In.	In.	In.	In.	In.	In.	In.
3/4	.88	3.18	2.68	1.00	.75	1.69	.94	–
1 ⁵ / ₁₆	1.62	3.62	2.81	1.69	1.31	2.00	1.37	.20
2	1.62	4.31	3.50	2.38	2.00	2.69	2.06	.20
4	2.00	6.81	5.56	4.55	4.00	4.84	4.06	.31

BCH12

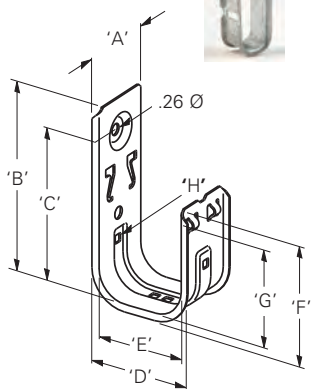

Load Capacity

Cable Hook Size	Static Load Capacity (S.F. 3)	
	Galvanized & Stainless Steel	Lbs.
In.		
3/4	30	
1 ⁵ / ₁₆	30	
2	30	
4	30	

Stated loads are per hook and should not be exceeded. The load capacity of a fastener having more than one component is equal to the load capacity of the lowest rated component.

Double-Sided Single-Tier Cable Fasteners

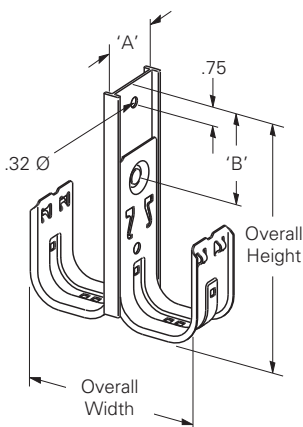

Hook Size	'A'	'B'	Overall Height	Overall Width
In.	In.	In.	In.	In.
1 ⁵ / ₁₆	1.90	2.50	5.50	3.47
2	1.90	2.50	6.19	4.85
4	2.38	2.94	9.00	9.19

Cable Hook Technical Data

Double-Sided Double-Tier Cable Fasteners

Hook Size In.	'A' In.	'B' In.	Spacing In.	Clearance In.	Overall Height In.	Overall Width In.
15/16	1.90	2.50	3.75	1.94	9.25	3.47
2	1.90	2.50	4.75	2.25	10.94	4.85
4	2.38	2.94	9.38	4.50	18.20	9.19

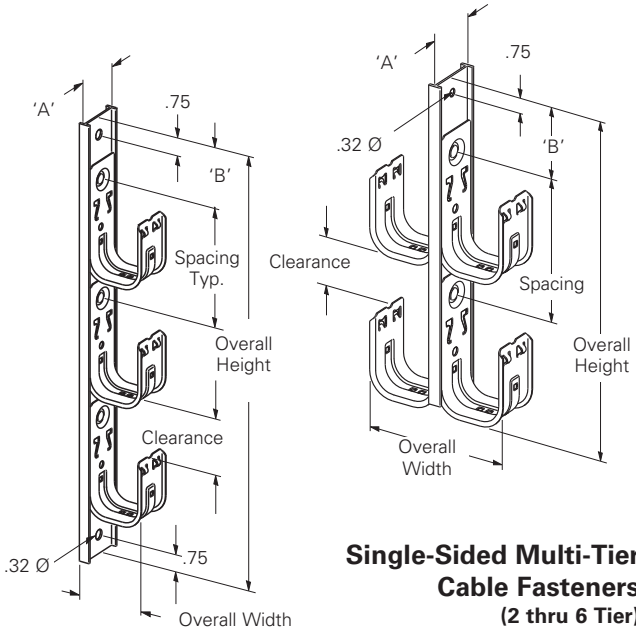

Single-Sided Multi-Tier Cable Fasteners (2 thru 6 Tier)

Hook Size In.	No. Tiers	'A' In.	'B' In.	Spacing In.	Clearance In.	Overall Height In.	Overall Width In.
15/16	2	1.90	2.50	3.75	1.94	11.00	1.96
	3	1.90	2.50	3.75	1.94	14.75	1.96
	4	1.90	2.50	3.75	1.94	18.50	1.96
	5	1.90	2.50	3.75	1.94	22.25	1.96
	6	1.90	2.50	3.75	1.94	26.00	1.96
2	2	1.90	2.50	4.75	2.25	12.75	2.66
	3	1.90	2.50	4.75	2.25	17.50	2.66
	4	1.90	2.50	4.75	2.25	22.25	2.66
	5	1.90	2.50	4.75	2.25	27.00	2.66
	6	1.90	2.50	4.75	2.25	31.75	2.66
4	2	2.38	2.94	8.75	3.19	19.33	4.82
	3	2.38	2.94	8.75	3.19	28.08	4.82

Reference Data

Rigid Steel Conduit (Heavy Wall Conduit)

Nominal Conduit Size	Outside Diameter	Nominal Inside Diameter	Minimum Weight Per 100 Ft. With Couplings Attached	Weight of Conduit and Conductors Per 100 Ft.*
In.	In.	In.	Lbs.	Lbs.
3/8	0.675	0.493	51.5	65.1
1/2	0.840	0.632	79.0	101.1
3/4	1.050	0.836	105.0	145.8
1	1.315	1.063	153.0	219.3
1 1/4	1.660	1.394	201.0	318.3
1 1/2	1.900	1.624	249.0	408.8
2	2.375	2.083	332.0	593.8
2 1/2	2.875	2.489	527.0	901.0
3	3.500	3.090	682.0	1259.0
3 1/2	4.000	3.570	831.0	1604.0
4	4.500	4.050	972.0	1967.0

Intermediate Metal Conduit (IMC)

Nominal Conduit Size	Outside Diameter	Nominal Inside Diameter	Minimum Weight Per 100 Ft. With Couplings Attached	Weight of Conduit and Conductors Per 100 Ft.*
In.	In.	In.	Lbs.	Lbs.
1/2	0.815	0.745	60.0	82.1
3/4	1.029	0.954	82.0	122.8
1	1.290	1.205	116.0	182.3
1 1/4	1.638	1.553	150.0	267.3
1 1/2	1.883	1.793	182.0	341.8
2	2.360	2.266	242.0	503.8
2 1/2	2.857	2.727	401.0	775.0
3	3.476	3.346	493.0	1069.0
3 1/2	3.971	3.841	573.0	1346.0
4	4.466	4.336	638.0	1632.0

Dimensions taken from ANSI C80.3 - 1977.

* Conduit plus weight of heaviest conductor combination as specified by the National Electrical Code.

Electrical Metallic Tubing (EMT) - Thinwall Conduit

Nominal Conduit Size	Outside Diameter	Nominal Inside Diameter	Minimum Weight Per 100 Ft. With Couplings Attached	Weight of Conduit and Conductors Per 100 Ft.*
In.	In.	In.	Lbs.	Lbs.
3/8	0.577	0.493	23.0	36.6
1/2	0.706	0.622	28.5	50.6
3/4	0.922	0.824	43.5	84.3
1	1.163	1.049	64.0	130.3
1 1/4	1.510	1.380	95.0	212.3
1 1/2	1.740	1.610	110.0	269.8
2	2.197	2.067	140.0	401.8
2 1/2	2.875	2.731	205.0	579.0
3	3.500	3.356	250.0	826.3
3 1/2	4.000	3.834	325.0	1098.0
4	4.500	4.334	370.0	1364.0

Rigid Aluminum Conduit

Nominal Conduit Size	Outside Diameter	Nominal Inside Diameter	Minimum Weight Per 100 Ft. With Couplings Attached	Weight of Conduit and Conductors Per 100 Ft.*
In.	In.	In.	Lbs.	Lbs.
1/2	0.840	0.632	27.4	49.5
3/4	1.050	0.836	36.4	77.2
1	1.315	1.063	53.0	119.3
1 1/4	1.660	1.394	69.6	186.9
1 1/2	1.900	1.624	82.2	242.0
2	2.375	2.083	115.7	377.5
2 1/2	2.875	2.489	182.5	556.5
3	3.500	3.090	238.9	815.2
3 1/2	4.000	3.570	287.7	1061.0
4	4.500	4.050	340.0	1334.0
5	5.563	5.073	465.4	2028.0
6	6.625	6.093	612.5	2870.0

Dimensions taken from ANSI C80.3 - 1977.

* Conduit plus weight of heaviest conductor combination as specified by the National Electrical Code.

Reference Data

Schedule 40 PVC Plastic Pipe

Nominal Pipe Size In.	Outside Diameter In.	Wall Thickness In.	Weight of Pipe Lbs. Per Ft.	Weight of Water Lbs. Per Ft.
1/8	0.405	0.068	0.04	0.02
1/4	0.540	0.088	0.07	0.04
3/8	0.675	0.091	0.10	0.08
1/2	0.840	0.109	0.15	0.10
3/4	1.050	0.113	0.20	0.20
1	1.315	0.133	0.30	0.40
1 1/4	1.660	0.140	0.40	0.60
1 1/2	1.900	0.145	0.50	0.90
2	2.375	0.155	0.60	1.40
2 1/2	2.875	0.203	1.00	2.10
3	3.500	0.216	1.30	3.20
3 1/2	4.000	0.226	1.60	4.30
4	4.500	0.237	1.90	5.50

Electrical Non-Metallic Tubing (ENT)

Nominal Size In.	Outside Diameter In.	Nominal Inside Diameter In.	Minimum Weight of Conduit Lbs. Per 100 Ft.	Weight of Conduit and Conductors Lbs. Per 100 Ft.
1/2	0.840	0.560	11.0	33.1
3/4	1.050	0.760	14.0	54.8
1	1.315	1.000	20.0	86.3
1 1/4	1.660	1.402	19.0	136.3
1 1/2	1.990	1.554	27.0	186.8
2	2.375	2.030	32.0	261.8

All Threaded Rod (ATR)

Thread Size	Root Area	Design Load (SF=5)
1/4"-20	0.027 in. ²	240 lbs.
5/16"-18	0.045 in. ²	400 lbs.
3/8"-16	0.068 in. ²	610 lbs.

Tabulated loads are based on an allowable tensile stress of 12000 psi reduced by 25% resulting in 9000 psi. From ANSI/MSS SP-58, Table 3.

Dimensions taken from ANSI B1.1 1982 Unified Inch Screw Threads. All threads are UNCR series.

MC -- Metal Clad Cable Specifications

Trade Size	Grounding Conductor AWG	Armor O.D. In.	Approximate Wt. Per 100 Ft. Lbs.
14-2 Solid	14	0.470	17.5
14-3 Solid	14	0.480	20.5
14-4 Solid	14	0.510	23.0
12-2 Solid	12	0.495	21.5
12-3 Solid	12	0.530	25.5
12-4 Solid	12	0.565	29.5
10-2 Solid	10	0.560	28.5
10-3 Solid	10	0.600	34.0
10-4 Solid	10	0.645	39.5
8-2 Stranded	10	0.710	45.0
8-3 Stranded	10	0.770	54.5
8-4 Stranded	10	0.835	64.5
6-2 Stranded	8	0.795	59.0
6-3 Stranded	8	0.865	72.0
6-4 Stranded	8	0.945	86.0
4-2 Stranded	8	0.945	78.5
4-3 Stranded	8	1.035	98.5
4-4 Stranded	8	1.135	119.5
3-3 Stranded	6	1.025	107.0
3-4 Stranded	6	1.120	126.0
2-2 Stranded	6	1.075	104.5
2-3 Stranded	6	1.180	134.0
2-4 Stranded	6	1.295	164.0

Category 5 Cable

Pair Count	AWG Size	O.D. In.	Weight Lbs. Per 100 Ft.
2	24	0.16	1.3
3	24	0.18	1.7
4	24	0.20	2.1
6	24	0.27	3.5
8	24	0.30	4.2
25	24	0.50	13.0

Reference Data

Type NM -- Non-Metallic Sheathed Cable

Size AWG	Number of Strands	Ground Wire Size	Approximate O.D. In.	Approximate Weight Lbs. Per 100 Ft.
<u>Without Ground Wire</u>				
14-2	Solid	–	.17 x .37	5.3
12-2	Solid	–	.19 x .40	7.0
10-2	Solid	–	.22 x .45	10.1
14-3	Solid	–	0.295	8.2
12-3	Solid	–	0.332	10.9
10-3	Solid	–	0.396	15.7
8-3	7	–	0.538	27.8
6-3	7	–	0.611	42.2
<u>With Ground Wire</u>				
14-2	Solid	14	.17 x .37	6.4
12-2	Solid	12	.19 x .41	9.0
10-2	Solid	10	.22 x .49	13.3
8-2	7	10	.28 x .61	21.5
6-2	7	10	.32 x .73	31.3
14-3	Solid	14	.322	9.3
12-3	Solid	12	.363	12.9
10-3	Solid	10	.436	18.7
14-4	Solid	14	.450	11.6
12-4	Solid	12	.490	16.1
10-4	Solid	10	.550	23.3
8-3	7	10	.552	30.5
6-3	7	10	.611	45.0
4-3	7	8	.821	66.4
2-3	7	8	.946	93.0

Type THHN -- Insulated Single Conductor Building Wire

Trade Size	Approximate O.D. In.	Approximate Weight Lbs. Per 100 Ft.
14 AWG	0.11	1.7
12 AWG	0.13	2.5
10 AWG	0.16	4.0
8 AWG	0.22	6.5
6 AWG	0.25	9.7
4 AWG	0.32	15.5
3 AWG	0.35	19.1
2 AWG	0.38	23.6
1 AWG	0.45	30.4
1/0 AWG	0.49	37.5

AC -- Armored Cable Specifications

Trade Size	Armor O.D. In.	Approximate Weight Lbs. Per 100 Ft.
14-2 Solid	0.433	18.0
14-3 Solid	0.453	20.0
14-4 Solid	0.486	25.0
12-2 Solid	0.467	21.0
12-3 Solid	0.489	24.5
12-4 Solid	0.520	29.0
10-2 Solid	0.476	25.0
10-3 Solid	0.500	29.5
10-4 Solid	0.541	38.0
8-2 Solid	0.570	34.5
8-3 Solid	0.601	41.5
8-4 Solid	0.654	48.0
8-2 Stranded	0.604	34.5
8-3 Stranded	0.637	42.0
8-4 Stranded	0.695	51.5
6-2 Stranded	0.700	44.5
6-3 Stranded	0.739	56.0
6-4 Stranded	0.807	68.5
4-2 Stranded	0.836	62.0
4-3 Stranded	0.885	80.0
4-4 Stranded	0.971	99.5
3-3 Stranded	0.990	94.0
3-4 Stranded	1.085	118.0
2-2 Stranded	0.956	81.5
2-3 Stranded	1.014	109.5
2-4 Stranded	1.115	138.0

Index

<u>Catalog No.</u>	<u>Page</u>	<u>Catalog No.</u>	<u>Page</u>
1314	196	B2RRE	38
1316	196	B2RRP4C	38
1372	196	B2RRP5C	38
1380	196	B2RRR	38
5860	192	B3RRE	38
5874	192	B3RRPC	38
6305	193	B3RRR	38
6307	193	B4RRE	38
6309	193	B4RRPC	38
6311	193	B4RRR	38
6313	193	B444- ¹ / ₄	110
6323	194	B444- ⁵ / ₁₆	110
6336	194	B444- ³ / ₈	110
6338	194	B601-62	185
6407SD	212	B1506S	52
7187	190, 192	B1508	52
7195	192	B1508S	52
7197	192	B1512	52
7198	192	B1512S	52
9221	211	B1516	52
9231	211	B1516S	52
9241	211	B1520	52
9323	195	B1520S	52
9343	195	B1524S	52
9353	195	B1532S	52
		B1534S	52
		B1540S	52
		B1548S	52
		B1556S	52
		B1564S	52
		B3223- ³ / ₈	143

A

ACB Series	196
ACPD Series	210
ACPW Series	209
ACS Series	197-198
ADA Series	203-204
ADI Series	193
ADE Series	207
ADH Series	195
ADM Series	194
ADN Series	213
AMS Series	211
APC Series	219
APD Series	218
APH Series	217
APS Series	216
ARC Series	191-192
ARS Series	189-190
ARW Series	192
ASA Series	205-206
ASE Series	208
ATB Series	214
ATM Series	212
AWA Series	199-200
AWS Series	215
AWSD Series	201-202
AZD Series	218

B

B1RRE	38
B1RRP4C	38
B1RRP5C	38
B1RRR	38

BA

BA1	87
BA1-9	87
BA1-24	87
BA1-32	87
BA1-95	87
BA1-T	87
BA1-T-BN	87
BA-2-9	91
BA-2-9-BN	91
BA-2-9-W	91
BA-2-9-WBN	91
BA-2-9-7	91
BA-2-9-7-BN	91
BA-2-16	90
BA-2-16-BN	90
BA-2-16-W	90
BA-2-16-WBN	90
BA-2-16-7	90
BA-2-16-7-BN	90
BA-2-16-7-W	90
BA-2-16-7-WBN	90
BA-4-9	91
BA-4-9-W	91
BA-4-16	89
BA-4-16-24	89
BA-4-16-32	89
BA-4-16-48	89

<u>Catalog No.</u>	<u>Page</u>	<u>Catalog No.</u>	<u>Page</u>
BA cont.		BB7-24	31
BA-4-16-H	88	BB8-16	32
BA-4-16-H1	88	BB8-24	32
BA-4-16-W	89	BB9	21
BA-4-WN	89	BB10	151
BA-5-4T	77	BB10-2	151
BA-6-4T	78	BB10-3	151
BA12	81	BB10-4	151
BA12-12	81	BB10L	152
BA12-20	81	BB10P	152
BA12-30	81	BB12	21
BA14	76	BB12-6	21
BA15	76	BB15	37, 154
BA17	86	BB-18	36
BA18	86	BB20	151
BA20	86	BB20L	152
BA-21	89	BB27	81
BA-21D	89	BB32	24
BA28	80	BB33	24
BA28B	144, 179	BB33L	24
BA40	85	BB38	45
BA50	82	BB38D	45
BA50A	83	BB40-08	37, 153
BA50CAN	82	BB40-10	37, 153
BA50C3T	82	BB40-12	37, 153
BA50C4T	82	BB45-08	37, 153
BA50D	82	BB45-10	37, 153
BA50DCAN	82	BB45-12	37, 153
BA50E	82	BB70	27
BA50F	84	BB70E	27
BA50-OB-24	83	BB73	26
BA50-OB-34	83	BB74	26
BA50-SB-24	83	BB76	26
BA50-SB-34	83	BB216TCL	30
BA311	92	BB216TS	29
BA311-W2	92	BB224TCL	30
BA311-W6	92	BB224TS	29
BA-SFC	93	BBCC	33
BA-SFC-CF	93	BBF15	35
BA-SFC-CFS	93	BBF15FC	35
BA-SFC-E	93	BBF18	35
BA-SFC-S	93	BBF18FC	35
BAX-4-16	88	BBF24	35
BAX-4-16-24	88	BBF24FC	35
BAX-4-16-32	88	BBFC	35
BAX-4-16-48	88	BBFS-18	33
BB		BC	
BB1	20	BC1	111
BB2-16T	29	BC442	100
BB2-24T	29	BC442-6	100
BB2CL	30	BCH12	155-156
BB2TS	29	BCH12-A28	166
BB4-4	25	BCH12-C1	162
BB4-4D	25	BCH12-C2	162
BB4-6	25	BCH12-C442	161
BB4-6D	25	BCH12-C442A	161
BB4-23	25	BCH12-E-2-4	159
BB4-23D	25	BCH12-E-5-8	159
BB7-16	31		

Index

<u>Catalog No.</u>	<u>Page</u>	<u>Catalog No.</u>	<u>Page</u>
BC cont.			
BCH12-E-9-12	159	BCH32-E-9-12	159
BCH12-F3	164	BCH32-F3	164
BCH12-F4	164	BCH32-F4	164
BCH12-G-8-12	167	BCH32-G-8-12	167
BCH12-L1410	167	BCH32-L1410	167
BCH12-PNA	139	BCH32-PNA	139
BCH12-RB	158	BCH32-RB	158
BCH12-SC4	163	BCH32-SC4	163
BCH12-U-2-4	160	BCH32-U-2-4	160
BCH12-U-5-8	160	BCH32-U-5-8	160
BCH12-U-9-12	160	BCH32-U-9-12	160
BCH12-W2	165	BCH32-W2	165
BCH12-W6	165	BCH32-W6	165
BCH21	155-156	BCH32X	157
BCH21-1D	168	BCH64	155-156
BCH21-2D	168	BCH64-1D	168
BCH21-2S	169	BCH64-2D	168
BCH21-3S	169	BCH64-2S	169
BCH21-4S	170	BCH64-3S	169
BCH21-5S	170	BCH64-4S	170
BCH21-6S	170	BCH64-AB	158
BCH21-A28	166	BCH64-C1	162
BCH21-AB	158	BCH64-C2	162
BCH21-C1	162	BCH64-C442	161
BCH21-C2	162	BCH64-C442A	161
BCH21-C442	161	BCH64-F3	164
BCH21-C442A	161	BCH64-F4	164
BCH21-E-2-4	159	BCH64-G-8-12	167
BCH21-E-5-8	159	BCH64-L1410	167
BCH21-E-9-12	159	BCH64-PNA	139
BCH21-F3	164	BCH64-RB	158
BCH21-F4	164	BCH64-SC4	163
BCH21-G-8-12	167	BCH64-U-2-4	160
BCH21-L1410	167	BCH64-U-5-8	160
BCH21-PNA	139	BCH64-U-9-12	150
BCH21-RB	158	BCH64X	157
BCH21-SC4	163	BCH-HBA	171
BCH21-U-2-4	160	BCH-HB21	171
BCH21-U-5-8	160	BCH-HB64	171
BCH21-U-9-12	160	BCHID-__12	156
BCH21-W2	165	BCHID-__21	156
BCH21-W6	165	BCHID-__32	156
BCH21X	157	BCHID-__64	156
BCH32	155-156	BCHK1	172
BCH32-1D	168	BCHK2	172
BCH32-2D	168	BCHK3	172
BCH32-2S	169	BCHR21	154
BCH32-3S	169	BCHR32	154
BCH32-4S	170	BCHR64	154
BCH32-5S	170	BCS-8	67
BCH32-6S	170	BCS-8C	67
BCH32-A28	166	BCS-12	67
BCH32-AB	158	BCS-12AS	67
BCH32-C1	162	BCS-12C	67
BCH32-C2	162	BCS-16	67
BCH32-C442	161	BCS-16AS	67
BCH32-C442A	161	BCS-16C	67
BCH32-E-2-4	159	BCS-18	67
BCH32-E-5-8	159	BCS-18C	67
		BCS-20	67
		BCS-20C	67

<u>Catalog No.</u>	<u>Page</u>	<u>Catalog No.</u>	<u>Page</u>
BD			
BD2	144, 179	BG6-S18-W2	70
BD4	144, 179	BG6-S18-W2-MC3	70
BD40	178	BG6-S18-W6	70
BE			
BE-1-2	96	BG6-S18-W6-MC3	70
BE-2-4	96	BG6-SC4	138
BE-2-4-CT2	150	BG-6-U-2-4	104
BE-5-8	96	BG-6-U-5-8	104
BE-5-8-CT2	150	BG-6-U-9-12	104
BE-9-12	96	BG-8-12	48
BE-9-12-CT2	150	BG-8-12-4T	48
BES-8	67	BG-8-12-A5	77
BES-8C	67	BG-8-12-A6	78
BES-12	67	BG-8-12-B1	20
BES-12C	67	BG-8-12-B5	23
BES-16	67	BG-8-12-C1	112
BES-16C	67	BG-8-12-C2	111
BF			
BF1	133	BG-8-12-C2	111
BF1-40	22	BG-8-12-D3	68
BF1-56	22	BG-8-12-D4	68
BF1-64	22	BG-8-12-E-2-4	98
BF1-96	22	BG-8-12-E-2-4-AS	106
BF1-CT2	150	BG-8-12-E-5-8	98
BF2	133	BG-8-12-E-5-8-AS	106
BF2-CT2	150	BG-8-12-E-9-12	98
BF3	129	BG-8-12-E-9-12-AS	106
BF4	125	BG-8-12-F1	135
BF12	123	BG-8-12-F2	135
BF13	123	BG-8-12-F13	123
BFA-1215	66	BG-8-12-G6	55
BFA-1520	66	BG-8-12-G20	55
BG			
BG-6	48	BG-8-12-G24	55
BG-6-4T	48	BG-8-12-G32	55
BG-6-A5	77	BG-8-12-G812	55
BG-6-A6	78	BG-8-12-H7	39
BG-6-B1	20	BG-8-12-PNA	140
BG-6-B5	23	BG812-S18	69
BG-6-E-2-4	98	BG812-S18-MC3	69
BG-6-E-5-8	98	BG812-S18S	69
BG-6-E-9-12	98	BG812-S18-S-MC3	69
BG-6-F1	135	BG812-S18-U24	116
BG-6-F2	135	BG812-S18-U24-MC3	116
BG-6-F13	123	BG812-S18-U58	116
BG-6-H7	39	BG812-S18-U58-MC3	116
BG-6-PNA	140	BG812-S18-W2	70
BG6-S18	69	BG812-S18-W2-MC3	70
BG6-S18-MC3	69	BG812-S18-W6	70
BG6-S18-S	69	BG812-S18-W6-MC3	70
BG6-S18-S-MC3	69	BG812-SC4	138
BG6-S18-U24	116	BG-8-12-U-2-4	104
BG6-S18-U24-MC3	116	BG-8-12-U-2-4-AS	106
BG6-S18-U58	116	BG-8-12-U-5-8	104
BG6-S18-U58-MC3	116	BG-8-12-U-5-8-AS	106
		BG-8-12-U-9-12	104
		BG-8-12-U-9-12-AS	106
		BG-8-12-W2	59
		BG-8-12-W6	59
		BG-16	48
		BG-16-4T	48
		BG-16-A5	77
		BG-16-A6	78
		BG-16-B1	20

Index

<u>Catalog No.</u>	<u>Page</u>	<u>Catalog No.</u>	<u>Page</u>
BG cont.			
BG-16-B5	23	BG-24-U-5-8	104
BG-16-C1	112	BG-24-U-9-12	104
BG-16-C2	111	BG-32	48
BG-16-E-2-4	98	BG-32-4T	48
BG-16-E-2-4-AS	106	BG-32-C1	112
BG-16-E-5-8	98	BG-32-C2	111
BG-16-E-5-8-AS	106	BG-32-E-2-4	98
BG-16-E-9-12	98	BG-32-E-5-8	98
BG-16-E-9-12-AS	106	BG-32-E-9-12	98
BG-16-F1	135	BG-32-U-2-4	104
BG-16-F2	135	BG-32-U-5-8	104
BG-16-F13	123	BG-32-U-9-12	104
BG-16-G-6	50	BH	
BG-16-G-8-12	50, 55	BH1	136
BG-16-G-16	50	BH1-E-2-4	121
BG-16-G-20	50	BH1-E-5-8	121
BG-16-G-24	50	BH1-E-9-12	121
BG-16-G-32	50	BH1-F1	133
BG-16-PNA	140	BH1-F2	133
BG-16-S18	69	BH1-F3	130
BG16-S18-MC3	69	BH1-F4	126
BG16-S18-S	69	BH1-F12	124
BG16-S18-S-MC3	69	BH1-H7	141
BG16-S18-U24	116	BH1-H8	142
BG16-S18-U24-MC3	116	BH1-PNA	139
BG16-S18-U58	116	BH-1-2-R	120
BG16-S18-U58-MC3	116	BH2	136
BG16-S18-W2	70	BH2-E-2-4	121
BG16-S18-W2-MC3	70	BH2-E-5-8	121
BG16-S18-W6	70	BH2-E-9-12	121
BG16-S18-W6-MC3	70	BH2-F1	134
BG-16-U-2-4	104	BH2-F2	134
BG-16-U-2-4-AS	106	BH2-F3	130
BG-16-U-5-8	104	BH2-F4	126
BG-16-U-5-8-AS	106	BH2-F12	124
BG-16-U-9-12	104	BH2-H7	141
BG-16-U-9-12-AS	106	BH2-H8	142
BG-16-W2	59	BH2-PNA	139
BG-16-W6	59	BH-2-4	120
BG-20	48	BH-2-4-R	120
BG-20-4T	48	BH4	136
BG-20-B5	23	BH4-E-2-4	122
BG-20-C1	112	BH4-E-2-4-AS	105
BG-20-C2	111	BH4-E-5-8	122
BG-20-E-2-4	98	BH4-E-5-8-AS	105
BG-20-E-5-8	98	BH4-E-9-12	122
BG-20-E-9-12	98	BH4-E-9-12-AS	105
BG-20-F13	123	BH4-F1	134
BG-20-U-2-4	104	BH4-F2	134
BG-20-U-5-8	104	BH4-F3	130
BG-20-U-9-12	104	BH4-F4	126
BG-24	48	BH4-F12	124
BG-24-4T	48	BH4-H7	141
BG-24-C1	112	BH4-H8	142
BG-24-C2	111	BH4-PNA	140
BG-24-E-2-4	98	BH4-SC4	137
BG-24-E-5-8	98	BH5	136
BG-24-E-9-12	98	BH5-E-2-4	122
BG-24-U-2-4	104	BH5-E-5-8	122

<u>Catalog No.</u>	<u>Page</u>	<u>Catalog No.</u>	<u>Page</u>
BH cont.			
BH5-E-9-12	122	BKP10094	182
BH5-F1	134	BKP20125	182
BH5-F2	134	BKP20188	182
BH5-F3	130	BKT Series	184
BH5-F4	126	BKW063	182
BH5-F12	124	BKW094	182
BH5-H7	141	BKW125	182
BH5-H8	142	BKW188	182
BH5-PNA	140	BKYH Series	184
BH-5-8	120	BKYT Series	184
BH-5-8-R	120		
BH6	136	BL	
BH6-E-2-4	122	BL1	147
BH6-E-2-4-AS	105	BL2	147
BH6-E-5-8	122	BL3-8	148
BH6-E-5-8-AS	105	BL3-12	148
BH6-E-9-12	122	BL3-16	148
BH6-E-9-12-AS	105	BL3-20	148
BH6-F1	134	BL-24-2	146
BH6-F2	134	BL-24-4	146
BH6-F3	130	BL-24-4C	146
BH6-F4	126	BL-32-4	146
BH6-F12	124	BL1400	53, 54
BH6-H7	141	BL1400-C442	109
BH6-H8	142	BL1400-PNA	140
BH6-PNA	140	BL1400-SC4	140
BH6-SC4	137	BL1410	53, 54
BH7	136	BL1410-C442	109
BH7-6	136	BL1410-L1400	56
BH8	136	BL1410-L1410	56
BH8-6	136	BL1410-L1420	56
BH9	180	BL1410-L1425	56
BH9-10	180	BL1410-L1430	56
BH-9-12	120	BL1410-L1440	56
BH-9-12-R	120	BL1410-L1450	56
BH10	180	BL1410-L1460	56
BH11	143	BL1410-L1470	56
BH12	143	BL1410-L1480	56
BH15	180	BL1410-PNA	140
BH16	180	BL1410-SC4	138
BHE-1-2	120	BL1420	53, 54
BH-F12	120	BL1420-C442	109
BH-F12-R	120	BL1420-PNA	140
BH-H7	120	BL1420-SC4	138
BH-PNA	139	BL1425	53, 54
		BL1425-C442	109
BK		BL1430	53, 54
BKA Series	184	BL1430-C442	109
BKB Series	184	BL1440	53, 54
BKC100	181	BL1440-C442	109
BKC200	181	BL1450	53, 54
BKCC	185	BL1450-C442	109
BKCP	185	BL1460	53, 54
BKF100-4	183	BL1470	53, 54
BKF100-6	183	BL1480	53, 54
BKH Series	184	BL1490	53, 54
BKL Series	184		
BKP10063	182		

Index

<u>Catalog No.</u>	<u>Page</u>	<u>Catalog No.</u>	<u>Page</u>
BM		BP-12-A6	78
BM1	46	BP-12-B1	20
BM1M	46	BP-12-B5	23
BM2	46	BP-12-C1	112
BM3	44	BP-12-C2	112
BM3M	44	BP-12-D3	68
BM5	179	BP-12-D4	68
BMB1	36	BP-12-E-2-4	97
BN		BP-12-E-5-8	97
BN1	178	BP-12-E-9-12	97
BN-2	178	BP-12-F13	123
BN-4	178	BP-12-H7	39
BN-6	178	BP-12-P-12	50
BP		BP-12-P-16	50
BP-8	49	BP-12-PNA	140
BP-8-4T	49	BP12-S18	71
BP-8-A28	80	BP12-S18-MC3	71
BP-8-A5	77	BP12-S18S	71
BP-8-A6	78	BP12-S18-S-MC3	71
BP-8-B1	20	BP12-S18-U24	117
BP-8-B5	23	BP12-S18-U24-MC3	117
BP-8-C1	112	BP12-S18-U58	117
BP-8-C2	112	BP12-S18-U58-MC3	117
BP-8-D3	68	BP12-S18-W2	72
BP-8-D4	68	BP12-S18-W2-MC3	72
BP-8-E-2-4	97	BP12-S18-W6	72
BP-8-E-5-8	97	BP12-S18-W6-MC3	72
BP-8-E-9-12	97	BP12-SC4	138
BP-8-F13	123	BP-12-U-2-4	103
BP-8-H7	39	BP-12-U-5-8	103
BP-8-P-8	50	BP-12-U-9-12	103
BP-8-P-12	50	BP-12-W2	60
BP-8-P-16	50	BP-12-W6	60
BP-8-PNA	140	BP-16	49
BP8-S18	71	BP-16-4T	49
BP8-S18-MC3	71	BP-16-A28	80
BP8-S18S	71	BP-16-A5	77
BP8-S18-S-MC3	71	BP-16-A6	78
BP8-S18-U24	117	BP-16-B1	20
BP8-S18-U24-MC3	117	BP-16-B5	23
BP8-S18-U58	117	BP-16-C1	112
BP8-S18-U58-MC3	117	BP-16-C2	112
BP8-S18-W2	72	BP-16-D4	68
BP8-S18-W2-MC3	72	BP-16-E-2-4	97
BP8-S18-W6	72	BP-16-E-5-8	97
BP8-S18-W6-MC3	72	BP-16-E-9-12	97
BP8-SC4	138	BP-16-F13	123
BP-8-U-2-4	103	BP-16-P-16	50
BP-8-U-5-8	103	BP-16-PNA	140
BP-8-U-9-12	103	BP-16-S18	71
BP-8-W2	60	BP16-S18-MC3	71
BP-8-W6	60	BP16-S18S	71
BP-12	49	BP16-S18-S-MC3	71
BP-12-4T	49	BP16-S18-U24	117
BP-12-A28	80	BP16-S18-U24-MC3	117
BP-12-A5	77	BP16-S18-U58	117
		BP16-S18-U58-MC3	117
		BP16-S18-W2	72
		BP16-S18-W2-MC3	72
		BP16-S18-W6	72
		BP16-S18-W6-MC3	72

<u>Catalog No.</u>	<u>Page</u>	<u>Catalog No.</u>	<u>Page</u>
BP cont.			
BP-16-U-2-4	103	BRC51-S18-W2	74
BP-16-U-5-8	103	BRC51-S18-W6	74
BP-16-U-9-12	103	BRC51-SC4	138
BP-16-W2	60	BRC5-1-U24	102
BP-16-W6	60	BRC5-1-U58	102
BPC-8	51	BRC5-1-U912	102
BPC-12	51	BRC5-1-W2	64
BPC-16	51	BRC5-1-W6	64
BPC-20	51	BRC5-2	63
BPC-24	51	BRC5-2-C2	114
BPC-32	51	BRC5-2-C442	108
BPC-40	51	BRC5-2-E12	100
BPC-48	51	BRC5-2-E24	100
BPC-56	51	BRC5-2-E58	100
BPC-64	51	BRC5-2-E912	100
BPNA	139	BRC5-2-F3	132
BR			
BR-8-T	173	BRC5-2-F4	128
BR-12-T	173	BRC52-SC4	138
BR-16-3W	173	BRC5-2-U24	102
BR-20-4T	173	BRC5-2-U58	102
BR-20-T	173	BRC5-2-U912	102
BR-24-4W	173	BRC5-2-W2	64
BR-32-4T	173	BRC5-2-W6	64
BR-32-4T-A6	176	BRC5-3	63
BR-32-4T-C1	176	BRC5-3-C2	114
BR-32-4T-U-2-4	175	BRC5-3-C442	108
BR-32-4T-U-5-8	175	BRC5-3-E12	100
BR-32-4T-U-9-12	175	BRC5-3-E24	100
BR-32-4T-W2	175	BRC5-3-E58	100
BR-32-4W	173	BRC5-3-E912	100
BR-32-T	173	BRC5-3-F3	132
BR-64-4T	173	BRC5-3-F4	128
BRC1	43	BRC6M	41
BRC2	43	BRC53-S18	73
BRC3	62	BRC53-S18-S	73
BRC3-E-2-4	115	BRC53-S18-U24	118
BRC3-E-5-8	115	BRC53-S18-U58	118
BRC3-E-9-12	115	BRC53-S18-W2	74
BRC3-F1	135	BRC53-S18-W6	74
BRC3-F2	135	BRC53-SC4	138
BRC3-W2	62	BRC5-3-U24	102
BRC3-W6	62	BRC5-3-U58	102
BRC4	42	BRC5-3-U912	102
BRC5-1	63	BRC5-3-W2	64
BRC5-1-C2	114	BRC5-3-W6	64
BRC5-1-C442	108	BRS-32	174
BRC5-1-E12	100	BRS-32A	174
BRC5-1-E24	100	BRS-64A	174
BRC5-1-E58	100	BS	
BRC5-1-E912	100	BSC4	137
BRC5-1-F3	132		
BRC5-1-F4	128		
BRC51-S18	73		
BRC51-S18-S	73		
BRC51-S18-U24	118		
BRC51-S18-U58	118		

Index

<u>Catalog No.</u>	<u>Page</u>	<u>Catalog No.</u>	<u>Page</u>
BU		BX4M-F13	124
BU-2-4	101	BX4M-H7	39
BU-2-4-S	101	BX4M-PNA	140
BU-2-4-S-AS	105	BX4M-SC4	138
BU-5-8	101	BX4M-U-2-4	107
BU-5-8-S	101	BX4M-U-5-8	107
BU-5-8-S-AS	105	BX4M-U-9-12	107
BU-9-12	101	BX4M-W2	61
BU-9-12-S	101	BX4M-W6	61
BU-9-12-S-AS	105	BX5	45
BW		BX6	65
BW2	57	BX-8	61
BW2-CT2	150	BX-8B	61
BW2S	57	BX9	65
BW4	57	BX-18	61
BW6	57	BX24	65
BW6-CT2	150	BX82	42
BW6S	57	BXL-67	66
BW-8	58	BXL-89	66
BW-12	58	BXL-1011	66
BW-16	58	BXL-1214	66
BW-20	58	BXL-1519	66
BWHS-9	30, 186	BXL-2024	66
BWHS-9D	30, 186	BXL-2530	66
BX		BXM-67	66
BX2	65	BXM-89	66
BX4	40	BXM-1011	66
BX4-A5	79	BXM-1214	66
BX4-A6	79	BXM-1519	66
BX4-C1	113	BXM-2024	66
BX4-C2	113	BXM-2530	66
BX4-E-2-4	99	BXS-67	66
BX4-E-5-8	99	BXS-89	66
BX4-E-9-12	99	BXS-1011	66
BX4-F3	131	BXS-1214	66
BX4-F4	127	BXS-1519	66
BX4-F13	124	BXS-2024	66
BX4-H7	39	BXS-2530	66
BX4-PNA	140	M	
BX4-U-2-4	107	MSQN 1/4	186
BX4-U-5-8	107	S	
BX4-U-9-12	107	SHHMS 1/4 x 1/2	186
BX4-W2	61	SRHMS 1/4 x 3/8	81
BX4-W6	61		
BX4M	40		
BX4M-A5	79		
BX4M-A6	79		
BX4M-A28	80		
BX4M-C1	113		
BX4M-C2	113		
BX4MD	40		
BX4M-E-2-4	99		
BX4M-E-5-8	99		
BX4M-E-9-12	99		
BX4M-F3	131		
BX4M-F4	127		

U.S. Customer Service Center is staffed Monday through Friday from 7 a.m. to 5:00 p.m. Central Standard Time. For more information, visit www.cooperbline.com/fasteners.

**Eaton's B-Line Business
United States**
509 West Monroe Street
Highland, IL 62249
United States
Phone: (800) 851-7415
www.cooperbline.com/contactus

**Eaton's B-Line Business
United Kingdom**
Walrow Industrial Estate
Somerset, TA9 4AQ
United Kingdom
Phone: (44) 1278 772600
www.cooperbline.com/contactuk

**Eaton's B-Line Business
Canada**
5925 McLaughlin Road
Mississauga, ON L5R 1B8
Canada
Phone: (800) 569-3660
www.cooperbline.com/contactca

**Eaton's B-Line Business
Middle East**
PO Box 70160 - Al Khobar - 31952
Kingdom of Saudi Arabia
Phone: 00966 3 812 2236
www.cooperbline.com/contactme

Eaton
1000 Eaton Boulevard
Cleveland, OH 44122
United States
Eaton.com

Eaton's B-Line Business
509 West Monroe Street
Highland, IL 62249
Phone: 800-851-7415
Fax: 618-654-1917
www.bline.com

© 2014 Eaton
All Rights Reserved
Printed in USA
Publication No. PH-13
July 2014 50M



Powering Business Worldwide

Eaton is a registered trademark
All other trademarks are property
of their respective owners