





Catalog Number: A-3630SBP  
Item Description: STEEL PANELS  
UPC Code: 784572288683

Brand Name: Milbank  
Type: Panel for Mounting Electronic Controls  
Application: Enclosure Accessory  
Material: Steel  
Shape: Rectangle  
Color: White  
Mounting: Stud Mount

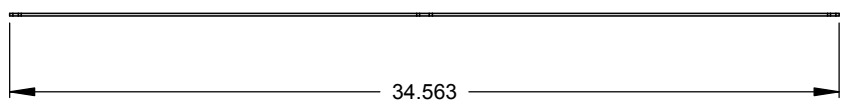
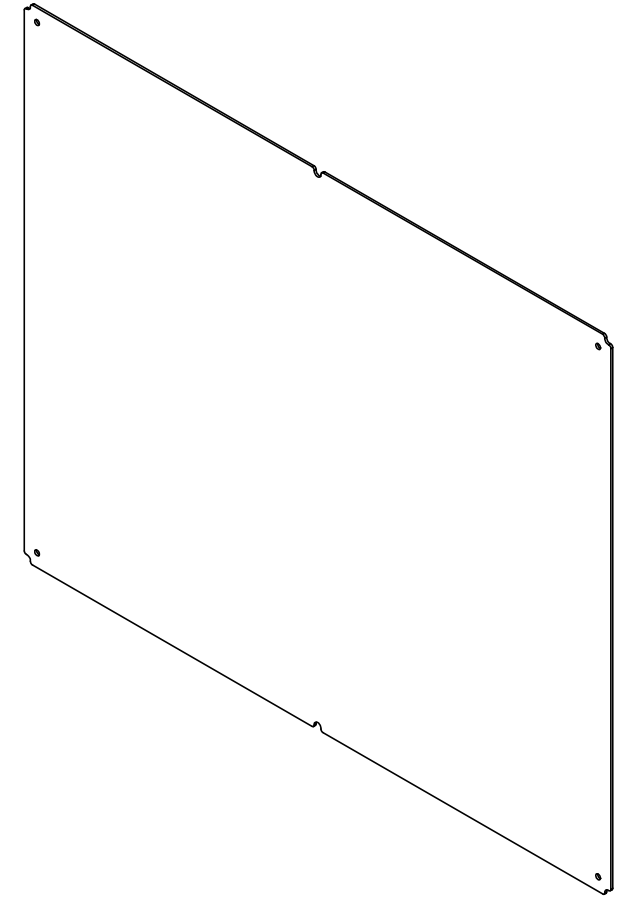
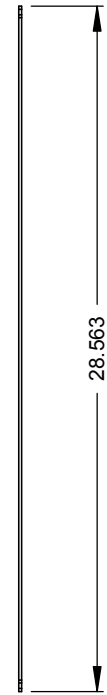
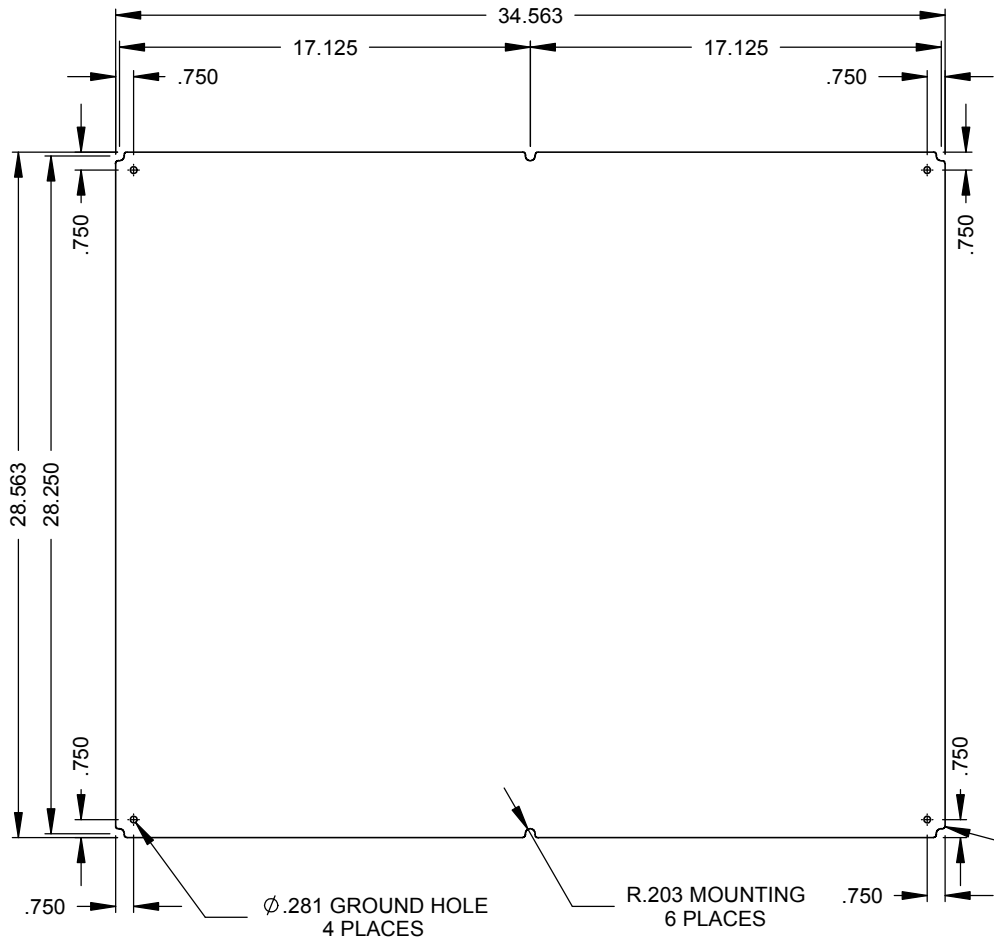

*Utility requirements may vary. Always consult the serving utility for their requirements prior to ordering or installing this equipment. This product must always be installed by a licensed electrician. Installation of this equipment may require local electrical inspector approval.*

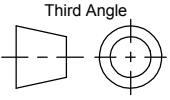

Material:	12 GA. GALV. STEEL		 <b>MILBANK</b> <small>ENERGY AT WORK</small>	General Offices: Kansas City, MO	
Finish:	PAINTED WHITE			Title:	BACK PANEL 36 x 30
Tolerances: Unless Specified Otherwise X.X ±.1 X.XX ±.03 X.XXX ±.015 X° ±2°			Third Angle  Projection	Catalog No.:	A-3630SBP
Scale:	NTS	Checked By:		Ref:	
Drawn By:	AJS	Approved By:	Drawing No.:	<b>1008798</b>	
			Date:	10/21/14	Sheet 1 of 1

**	10/21/14	FIRST RELEASE (eECR2819)	AJS			
----	----------	--------------------------	-----	--	--	--





Catalog Number: A-3630SBP  
Item Description: STEEL PANELS  
UPC Code: 784572288683

Brand Name: Milbank  
Type: Panel for Mounting Electronic Controls  
Application: Enclosure Accessory  
Material: Steel  
Shape: Rectangle  
Color: White  
Mounting: Stud Mount

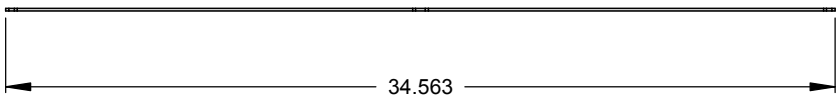
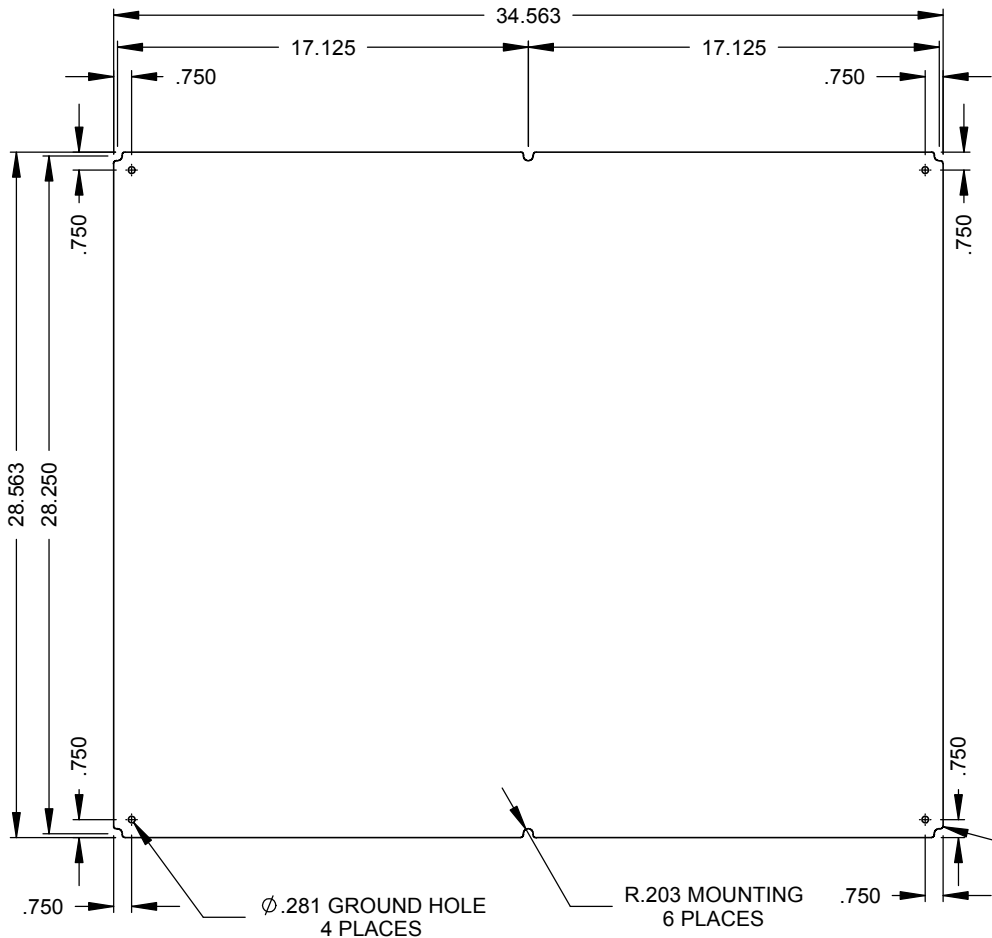

*Utility requirements may vary. Always consult the serving utility for their requirements prior to ordering or installing this equipment. This product must always be installed by a licensed electrician. Installation of this equipment may require local electrical inspector approval.*

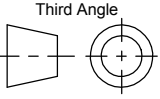

Material:	12 GA. GALV. STEEL		 <b>MILBANK</b> <small>ENERGY AT WORK</small>	General Offices: Kansas City, MO	
Finish:	PAINTED WHITE			Title:	BACK PANEL 36 x 30
Tolerances: Unless Specified Otherwise X.X ±.1 X.XX ±.03 X.XXX ±.015 X° ±2°			Third Angle  Projection	Catalog No.:	A-3630SBP
				Ref:	
			Drawing No.:	<b>1008798</b>	
Scale:	NTS	Checked By:	Date:	10/21/14	Sheet 1 of 1
Drawn By:	AJS	Approved By:			

**	10/21/14	FIRST RELEASE (eECR2819)	AJS			
----	----------	--------------------------	-----	--	--	--