

**Circuit Breakers
Thermal Magnetic Type**

- Rated from 0.05 to 16.0 amps
- Available in single or double pole configurations
- Features a tease free design to reduce contact damage
- Offers push button trip/reset function
- Trip free design means the breaker cannot be held closed against a fault
- Mounts on 32mm* or 35mm DIN-rail
- UL 1077 recognized
- CSA C22.2 No. 235

**CB4200 Series
Single Pole**



**CB4200 Series
Double Pole**



Ordering Data

Current Ratings (amps)	Part No. TS 35 *For TS 32 Rail, see adapter below
0.05	9124083500
0.08	9124653500
0.1	9104173500
0.2	9104183500
0.3	9129813500
0.4	9124093500
0.5	9101003500
0.6	9124113500
0.7	9129563500
0.8	9101103500
1.0	9101203500
1.2	9101303500
1.3	9124123500
1.4	9124133500
1.5	9101403500
1.8	9124143500
2.0	9101503500
2.5	9101603500
3.0	9101703500
3.5	9124163500
4.0	9104353500
4.5	9124173500
5.0	9101803500
5.5	9107833500
6.0	9103813500
6.5	9120043500
7.0	9104153500
8.0	9103003500
9.0	9104613500
10.0	9101903500
11.0	9124183500
12.0	9107843500
13.0	9124193500
14.0	9107853500
15.0	9102003500
16.0	9124213500

Type: Single Pole

Current Ratings (amps)	Part No. TS 35 *For TS 32 Rail, see adapter below
0.05	9124223500
0.08	9124233500
0.1	9120353500
0.2	9124243500
0.3	9124263500
0.4	9124273500
0.5	9129583500
0.6	9124283500
0.7	9124293500
0.8	9129593500
1.0	9129613500
1.2	9129623500
1.3	9124313500
1.4	9124323500
1.5	9129633500
1.8	9124333500
2.0	9129643500
2.5	9129653500
3.0	9129663500
3.5	9124343500
4.0	9129713500
4.5	9124353500
5.0	9129673500
5.5	9124363500
6.0	9124373500
6.5	9124383500
7.0	9124393500
8.0	9104673500
9.0	9124423500
10.0	9129683500
11.0	9124433500
12.0	9124443500
13.0	9124453500
14.0	9124463500
15.0	9129693500
16.0	9124473500

Type: Double Pole

Current Ratings (amps)	Part No. TS 35 *For TS 32 Rail, see adapter below
0.05	9124223500
0.08	9124233500
0.1	9120353500
0.2	9124243500
0.3	9124263500
0.4	9124273500
0.5	9129583500
0.6	9124283500
0.7	9124293500
0.8	9129593500
1.0	9129613500
1.2	9129623500
1.3	9124313500
1.4	9124323500
1.5	9129633500
1.8	9124333500
2.0	9129643500
2.5	9129653500
3.0	9129663500
3.5	9124343500
4.0	9129713500
4.5	9124353500
5.0	9129673500
5.5	9124363500
6.0	9124373500
6.5	9124383500
7.0	9124393500
8.0	9104673500
9.0	9124423500
10.0	9129683500
11.0	9124433500
12.0	9124443500
13.0	9124453500
14.0	9124463500
15.0	9129693500
16.0	9124473500

**Trip Curves
Thermal Magnetic Type
Typical time/current characteristics at 23°C**

CB4200 Series

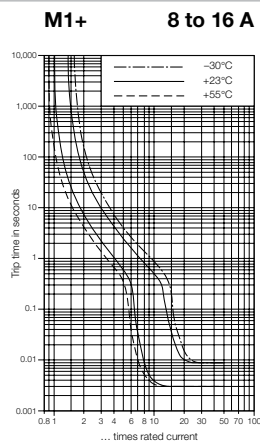
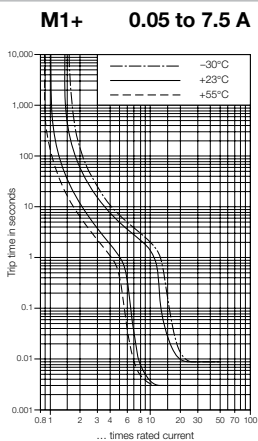

***Adapter foot – dimensions in mm (in.)**

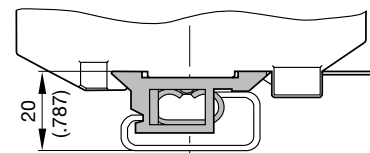

910210000
TS32 adapter

**CB4200 Series
Single Pole**

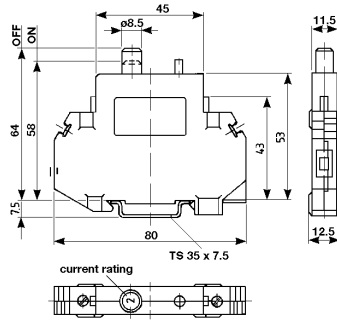

Internal Wiring Diagram

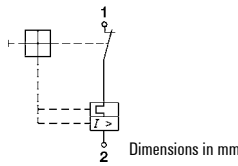

Dimensions in mm

**CB4200 Series
Double Pole**

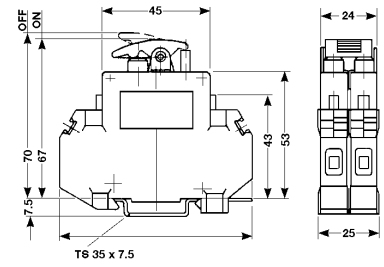

Internal Wiring Diagram

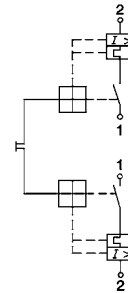

Dimensions in mm

Technical Data

Rated voltage & current†	UL
	CSA
	VDE
Creepage resistance	
Dielectric strength	
Insulation resistance	
Interrupting capacity (VDE 0660, Part 101, P-2)	
Interrupting capacity; 4201 (UL 1077/EN 60934 PC1)	
Typical life at 2 x rated current	
Shock	
Torque	
Vibration	
Temperature range	
Corrosion	
Humidity	
Weight	
Wire size (UL)	

Voltage Ratings		
Current Ratings		
AC 250 V, DC 65 V, 50/60 Hz		0.05...16 A
AC 250 V, DC 65 V, 50/60 Hz		0.05...16 A
AC 250 V, DC 65 V, 50/60 Hz		0.05...16 A
PT1 600 to IEC 112		
4,000 VAC; IEC 664 & 664 A		
> 100 MM (DC 500 V)		
4201-10	Maximum capacity	
0.05...0.8 A	Self-limiting	
1...2 A	200 A	
2.5...16 A	400 A	
Rated current	Rated voltage	Maximum capacity
0.05...2.0 A	AC 250 V	200 A
2.0...16 A	AC 250 V	200 A
20 A	AC 125 V	400 A
5,000 operations		
25 g (11 ms) to IEC 68-2-27, Test Ea		
1.2 Nm		
5 g (57 to 500 Hz / ±0.38 mm, 10 to 57 Hz) to IEC 68-2-6, Test Fc		
-30°C...+55°C (-22°F...+131°F)		
96 hours at 5% salt spray, to IEC 68-2-11, Test Ka		
240 hours at 95% RH, to IEC 68-2-3, Test Ca		
60 g per pole		
#20...8 AWG	solid/0.5...6 mm ²	

Accessories

Jumpers	
	Daisy Chain 50*
	Straight CQB** insulated
	Angled CQB** insulated
Adapter foot (for TS 32 Rail)	
Busbar	Single pole 1 meter
Busbar end cap for 6720000227	
Power lug for 6720000227	

Type	Part No.
BDC 50	9970290000
CQB 2	9970560000
CQB 3	9970570000
CQB 4	9970580000
CQB 10	9970590000
CQB 2	9970600000
CQB 3	9970610000
CQB 4	9970620000
CQB 10	9970630000
MCBAF/TS 32	9102100000
	6720000227
	6720000225
	6720000226

Marking Tags

Note: Part numbers are shown for a single card of pre-printed tags numbered 1-50.	Special print only
	Consecutive horizontal
	Consecutive vertical

WS 8/5 MC	1640750000***
DEK 5/5	0473460001
DEK 5/5	0473560001

†Note: Resistive and inductive loads (0.05 - 16 A)
 *BDC will accommodate 20 A per pin, 20 A total
 **CQB will accommodate 18 A per pin, 18 A total; dedicated to 4201 Series
 ***Please specify horizontal or vertical print when ordering.
 Standard quantity = 144 tags per card.

Circuit Breakers
Thermal Magnetic Type

- Rated from 0.05 to 16.0 amps
- Available in single or double pole configurations
- Features a tease free design to reduce contact damage
- Offers push button trip/reset function
- Trip free design means the breaker cannot be held closed against a fault
- Mounts on 32mm* or 35mm DIN-rail
- UL 1077 recognized
- CSA C22.2 No. 235

CB4200 Series
Single Pole



CB4200 Series
Double Pole



Ordering Data

Current Ratings (amps)	Part No. TS 35 *For TS 32 Rail, see adapter below
0.05	9124083500
0.08	9124653500
0.1	9104173500
0.2	9104183500
0.3	9129813500
0.4	9124093500
0.5	9101003500
0.6	9124113500
0.7	9129563500
0.8	9101103500
1.0	9101203500
1.2	9101303500
1.3	9124123500
1.4	9124133500
1.5	9101403500
1.8	9124143500
2.0	9101503500
2.5	9101603500
3.0	9101703500
3.5	9124163500
4.0	9104353500
4.5	9124173500
5.0	9101803500
5.5	9107833500
6.0	9103813500
6.5	9120043500
7.0	9104153500
8.0	9103003500
9.0	9104613500
10.0	9101903500
11.0	9124183500
12.0	9107843500
13.0	9124193500
14.0	9107853500
15.0	9102003500
16.0	9124213500

Type: Single Pole

Current Ratings (amps)	Part No. TS 35 *For TS 32 Rail, see adapter below
0.05	9124083500
0.08	9124653500
0.1	9104173500
0.2	9104183500
0.3	9129813500
0.4	9124093500
0.5	9101003500
0.6	9124113500
0.7	9129563500
0.8	9101103500
1.0	9101203500
1.2	9101303500
1.3	9124123500
1.4	9124133500
1.5	9101403500
1.8	9124143500
2.0	9101503500
2.5	9101603500
3.0	9101703500
3.5	9124163500
4.0	9104353500
4.5	9124173500
5.0	9101803500
5.5	9107833500
6.0	9103813500
6.5	9120043500
7.0	9104153500
8.0	9103003500
9.0	9104613500
10.0	9101903500
11.0	9124183500
12.0	9107843500
13.0	9124193500
14.0	9107853500
15.0	9102003500
16.0	9124213500

Type: Double Pole

Current Ratings (amps)	Part No. TS 35 *For TS 32 Rail, see adapter below
0.05	9124223500
0.08	9124233500
0.1	9120353500
0.2	9124243500
0.3	9124263500
0.4	9124273500
0.5	9129583500
0.6	9124283500
0.7	9124293500
0.8	9129593500
1.0	9129613500
1.2	9129623500
1.3	9124313500
1.4	9124323500
1.5	9129633500
1.8	9124333500
2.0	9129643500
2.5	9129653500
3.0	9129663500
3.5	9124343500
4.0	9129713500
4.5	9124353500
5.0	9129673500
5.5	9124363500
6.0	9124373500
6.5	9124383500
7.0	9124393500
8.0	9104673500
9.0	9124423500
10.0	9129683500
11.0	9124433500
12.0	9124443500
13.0	9124453500
14.0	9124463500
15.0	9129693500
16.0	9124473500

Trip Curves
Thermal Magnetic Type
Typical time/current characteristics at 23°C

CB4200 Series

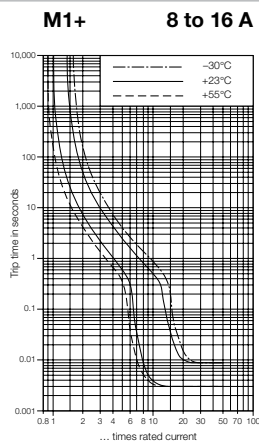
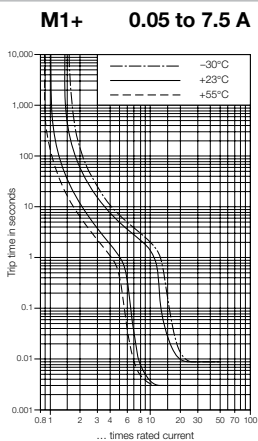

***Adapter foot – dimensions in mm (in.)**

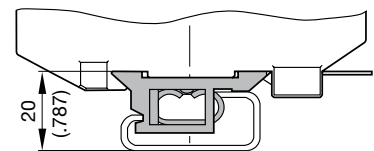

9102100000
TS32 adapter

**CB4200 Series
Single Pole**

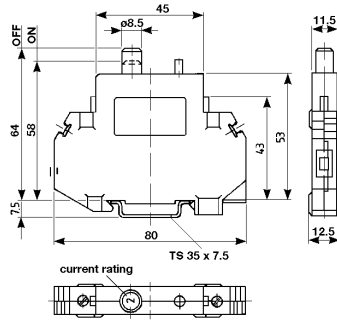

Internal Wiring Diagram

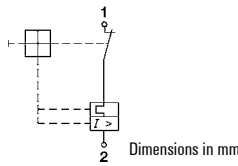

Dimensions in mm

**CB4200 Series
Double Pole**

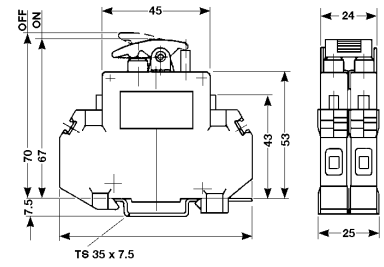

Internal Wiring Diagram

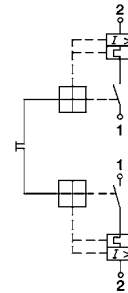

Dimensions in mm

Technical Data

Rated voltage & current†	UL
	CSA
	VDE
Creepage resistance	
Dielectric strength	
Insulation resistance	
Interrupting capacity (VDE 0660, Part 101, P-2)	
Interrupting capacity; 4201 (UL 1077/EN 60934 PC1)	
Typical life at 2 x rated current	
Shock	
Torque	
Vibration	
Temperature range	
Corrosion	
Humidity	
Weight	
Wire size (UL)	

Voltage Ratings		
Current Ratings		
AC 250 V, DC 65 V, 50/60 Hz		0.05...16 A
AC 250 V, DC 65 V, 50/60 Hz		0.05...16 A
AC 250 V, DC 65 V, 50/60 Hz		0.05...16 A
PT1 600 to IEC 112		
4,000 VAC; IEC 664 & 664 A		
> 100 MM (DC 500 V)		
4201-10	Maximum capacity	
0.05...0.8 A	Self-limiting	
1...2 A	200 A	
2.5...16 A	400 A	
Rated current	Rated voltage	Maximum capacity
0.05...2.0 A	AC 250 V	200 A
2.0...16 A	AC 250 V	200 A
20 A	AC 125 V	400 A
5,000 operations		
25 g (11 ms) to IEC 68-2-27, Test Ea		
1.2 Nm		
5 g (57 to 500 Hz / ±0.38 mm, 10 to 57 Hz) to IEC 68-2-6, Test Fc		
-30°C...+55°C (-22°F...+131°F)		
96 hours at 5% salt spray, to IEC 68-2-11, Test Ka		
240 hours at 95% RH, to IEC 68-2-3, Test Ca		
60 g per pole		
#20...8 AWG	solid/0.5...6 mm ²	

Accessories

Jumpers	
	Daisy Chain 50*
	Straight CQB** insulated
	Angled CQB** insulated
Adapter foot (for TS 32 Rail)	
Busbar	Single pole 1 meter
Busbar end cap for 6720000227	
Power lug for 6720000227	

Type	Part No.
BDC 50	9970290000
CQB 2	9970560000
CQB 3	9970570000
CQB 4	9970580000
CQB 10	9970590000
CQB 2	9970600000
CQB 3	9970610000
CQB 4	9970620000
CQB 10	9970630000
MCBAF/TS 32	9102100000
	6720000227
	6720000225
	6720000226

Marking Tags

Note: Part numbers are shown for a single card of pre-printed tags numbered 1-50.	Special print only
	Consecutive horizontal
	Consecutive vertical

WS 8/5 MC	1640750000***
DEK 5/5	0473460001
DEK 5/5	0473560001

†Note: Resistive and inductive loads (0.05 - 16 A)
 *BDC will accommodate 20 A per pin, 20 A total
 **CQB will accommodate 18 A per pin, 18 A total; dedicated to 4201 Series
 ***Please specify horizontal or vertical print when ordering.
 Standard quantity = 144 tags per card.