

Dimmers & Fan Speed Controls



Pass & Seymour

Today's home and business owners want optimum control of their electrical systems. P&S Dimmers & Fan Speed Controls provide that control — along with aesthetics, durability, trouble-free installation, and innovative technologies.

Benefits of Using Legrand/Pass & Seymour Dimming

Save Energy – Dimming reduces the amount of energy consumed by the lamps which reduces energy costs.

Add ambience – Change the lighting to set the mood or highlight the décor.

Add comfort – Use only the light you need for the task.

Add flexibility – Change the look of the room and then change it back. Quickly and easily.

Add convenience – Presets and scene controls make it easy to set up your home the way you like with accuracy and repeatability.

Increase safety and security – Never drive up to a dark house again.

Lower maintenance costs – Dimming increases the life of incandescent lamps.

Add value – A home with lighting controls is worth more.



Index

Device	Page Number
Product Selection Guide	M-2
Catalog Numbering System	M-3
Residential Dimmers & Fan Speed Controls	
RF Lighting Control System	M-4 – M-7
Scene Director	M-8, M-9, M-34
Leandro®	M-10, M-34
Harmony™ TradeMaster®	M-11, M-12, M-34
TradeMaster® Toggle	M-18, M-19, M-20, M-36
Rotary R TradeMaster® Series	M-21
Residential & Light Commercial Dimmers & Fan Speed Controls	
LS TradeMaster® Series	M-13 – M-15, M-35
DR TradeMaster® Series	M-16, M-34
Wide Slide TradeMaster® Series	M-17, M-36
Rotary TradeMaster® Series	M-22, M-23, M-37
Commercial Dimmers & Fan Speed Controls	
Titan™ Series	M-24 – M-31, M-38
Rotary Dimmers	M-32
Rotary Fan Speed Controls	M-33, M-39



Energy concerns have created directives in some states for lighting controls in new residential construction and major renovations. In an effort to reduce electrical power consumption, California has mandated one of the most stringent energy codes in the country. California Title 24 requires high efficacy luminaires, vacancy sensors (Section L), or dimmers to be placed in certain areas of the home. The standard became effective on October 1, 2005. Other states are considering adopting similar mandates to answer their own energy concerns. Legrand/Pass & Seymour has an extensive selection of vacancy sensor and dimmer solutions to address this growing industry trend.



RF Lighting Control System

- Whole house and room scene controls allow homeowners to change their environment at the push of a button.
- Frequency-agile Radio Frequency (RF) wireless communications technology.
- Simple, intuitive programming without the use of a computer or controller.

PAGES M-4 – M-7



Scene Director Control

- Select any lighting scene at the touch of a button.
- Optional infrared remote enables control from anywhere in the room.
- Master can control up to 30 dimmers.
- Easy to program – and won't lose programming during power outage.

PAGES M-8, M-9



Leandro® Decorator Dimmers

- Multi-location dimming.
- Light levels fade elegantly up/down.
- Green LEDs indicate preset level; red LED makes dimmers easy to find in the dark.

PAGE M-10



Harmony™ Decorator Dimmers

- Matches P&S Decorator devices.
- Combines ON/OFF Decorator switch with separate slider for dimming control.
- No lost settings during power outages.

PAGE M-11, M-12



LS Series Decorator Slide Dimmers

- Smooth, ergonomic operation.
- Snap-in LED light modules make dimmers easy to find at night.
- Available in both preset and non-preset models.

PAGES M-13 – M-15



DR Series Decorator Rotary Dimmers

- Illuminated knob shows light level.
- Snap-in LED light modules make dimmers easy to find at night.
- Available for incandescent and low-voltage lighting.

PAGE M-16



Toggle Dimmers

- Convenient preset dimming control.
- Combines ON/OFF toggle with separate preset for dimming control.
- Matches appearance of toggle switches.

PAGE M-18, M-19



- Match appearance of toggle switches.
- No loss of settings during power outages.
- Illuminated versions available.

PAGE M-20



Rotary Dimmers

- Models for incandescent and low-voltage lights; preset and illuminated features available.
- Simple to operate.
- Available in both preset and non-preset models.

PAGE M-21



Dimmers & Fan Speed Controls Catalog Numbering System

Pass & Seymour



All P&S Dimmers and Fan Speed Controls use an easy-to-understand catalog numbering system:

T LV 600 - *

Control Type

D = Decorator
LS = Long Slide
SC = Scene Director
T = Toggle
R = Rotary
DR = Decorator Rotary

Load Type

Blank = Incandescent
FB = Fluorescent Ballast
IR = Infrared Remote
LV = Magnetic Low-Voltage
ELV = Electronic Low-Voltage
MC = Master Controller
DC = Dual Dimmer/De-Hummer Speed Control
DV = Dimmer/Variable Speed Control
DH = De-Hummer Fan Speed Control
SC = Fan Speed Control

Load Size

300 = 300 Watt
600 = 600 Watt/VA
603 = 600 Watt/VA, 3-Way
700 = 700 Watt
703 = 700 Watt 3-Way
1000 = 1000 Watt/VA
1003 = 1000 Watt/VA, 3-Way
1100 = 1100 Watt
1103 = 1100 Watt 3-Way
1600 = 1600 Watt
1603 = 1600 Watt 3-Way
2000 = 2000 Watt
2003 = 2000 Watt 3-Way
3 = 3 Amps
5 = 5 Amps
7 = 7 Amps
8 = 8 Amps
10 = 10 Amps
15 = 1.5 Amps
16 = 1.6 Amps or 16 Amps
25 = 2.5 Amps

Package

Blank = Box
V = VisionPak™
TK = Triple Knob

Color

BK = Black
(Blank) = Brown
CL = Clear
GRY = Gray
I = Ivory
LA = Light Almond
LC = Lighted Clear
W = White

Options

E = Electronic Preset
L = Lighted
M = Multilocation
P = Preset

Examples:

D600MLAV = Decorator Dimmer, Incandescent, 600W, Multilocation, Light Almond, in a VisionPak

LS600LA = Decorator Slide Dimmer, Incandescent, 600W, Light Almond, in a Box

SSSC5-WV = Short Slide, Fan Speed Control, 5 Amp, White, in a VisionPak

Many P&S Dimmers & Fan Speed Controls are available boxed or VisionPak™ clam-shell packaging for high-impact merchandising. Please see the Catalog Numbering System above or specific charts for ordering information.

See Pages M-4 – M-7 to order RF Lighting Control System products.



Pass & Seymour

Commercial Dimmers & Fan Speed Controls Rotary Dimmers

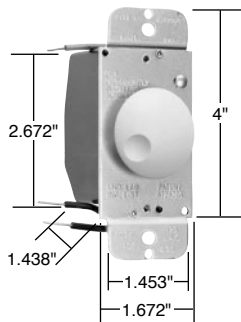

90621

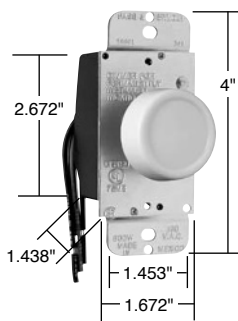

95600

Features	
<ul style="list-style-type: none"> Full range rotary dimming. Low-voltage and fluorescent models have field adjustable trims that may be set to control minimum light level. Ground lead provided on all models. New attractive knob design. 	<ul style="list-style-type: none"> Voltage compensation circuitry in fluorescent and magnetic low-voltage model reduces lighting fluctuations. All models fit standard toggle wall plate. All dimmers on this page may be ganged without de-rating. RFI protected.

Catalog Number	Description	Ratings	Color
Incandescent Specification Grade Rotary Dimmers — Single Pole			
90621IV 90621WV	Low Profile, Dial ON/OFF	120V, 600W max.	Ivory White
Magnetic Low-Voltage Specification Grade Rotary Dimmers — Single Pole*			
95600I 95600W	Preset, Push ON/OFF	120V, 600W max.	Ivory White

*For use with magnetic transformer incandescent low-voltage lighting.

Catalog Number		Description	Ratings	Color
Single Pole	Three-Way			
1000W Max. Incandescent Rotary Dimmers with Architectural Heat Sink				
91000I 91000W	91003I 91003W	Preset, Push ON/OFF	120V 1000W max.	Ivory White
91001I 91001W		Dial, ON/OFF	120V 1000W max.	Ivory White
1500W Max. Incandescent Rotary Dimmers with Architectural Heat Sink				
91500I	91503I 91503W	Preset, Push ON/OFF	120V 1500W max.	Ivory White
91501I 91501W		Dial, ON/OFF	120V 1500W max.	Ivory White
2000W Max. Incandescent Rotary Dimmers with Architectural Heat Sink				
92001I 92001W		Dial, ON/OFF	120V 2000W max.	Ivory White

*Fits in standard toggle wall plate opening.

Catalog Number	Description	Ratings	Color
1000VA Max. Magnetic Low-Voltage Specification Grade Single Pole Rotary Dimmer* with Architectural Heat Sink			
95100I	Dial, ON/OFF	120V, 1000VA max.	Ivory

* For use with magnetic transformer incandescent low-voltage lighting.

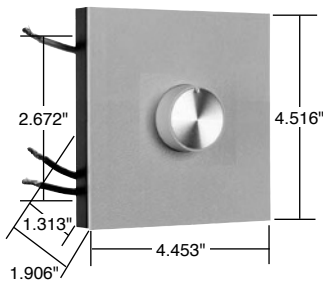

91500 91503
91501 92001

Catalog Number	Description	Color
Accessories for Rotary Heat Sink Dimmers & Fan Speed Controls		
DAPK1I DAPK1W DAPK1	1-Gang Wall Plate – Plate and Knob Kit	Ivory White Brown
DAPK2I DAPK2W DAPK2	2-Gang Wall Plate – Plate and Knob Kit	Ivory White Brown

For wiring diagrams, see Page S-20. For de-rating chart, see Page M-22.

Devices & Wall Plates Color Selection Chart



Pass & Seymour

Devices & Plastic Wall Plate Colors

Ivory	Light Almond	White	Green		
Black	Blue	Brown	Gray	Orange	Red

See specific device and wall plate catalog charts for particular color availabilities.

Metal Wall Plates

Metal Finish Aluminum	Brass (Brushed)	Polished Brass	Stainless Steel	Brushed Bronze	Chrome

Custom Metal Wall Plates Paint Finish Colors

Paint Color Orange	Green	Gray	Yellow	Glossy Black	Brown	White
Paint Color Primer	Red	Pink	Flat Black	Ivory	Light Almond	Blue

To order custom metal wall plates, see Pages Q-43 – Q-45.

For additional colors consult factory.



Pass & Seymour

Technical Specifications High Wattage Rotary Dimmers

Preset Push On/Off Incandescent 120VAC, 60 Hz

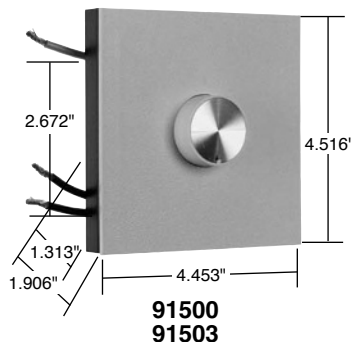
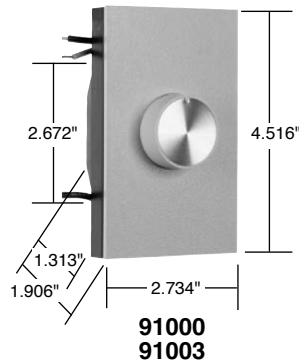

Typical Specifications

Incandescent dimmer shall be UL Listed/CSA Certified Legrand/Pass & Seymour Specification Grade, with full range solid-state circuitry giving even control by means of rotary action and positive ON/OFF switching. All dimmers shall fit standard single gang wall boxes. Conforms to NEMA WD-1 and WD-6.

Catalog Number	Color	Description	Rated Load
<input type="checkbox"/> 91000I	Ivory	Single Pole – Preset Push ON/OFF	1000W
<input type="checkbox"/> 91000W	White	Single Pole – Preset Push ON/OFF	1000W
<input type="checkbox"/> 91003I	Ivory	Three-Way – Preset Push ON/OFF	1000W
<input type="checkbox"/> 91003W	White	Three-Way – Preset Push ON/OFF	1000W
<input type="checkbox"/> 91500I	Ivory	Single Pole – Preset Push ON/OFF	1500W
<input type="checkbox"/> 91503I	Ivory	Three-Way – Preset Push ON/OFF	1500W
<input type="checkbox"/> 91503W	White	Three-Way – Preset Push ON/OFF	1500W

Features

- Maximum ratings are for continuous full load.
- Superior state-of-the-art solid-state electronic circuitry design increases energy savings and extends bulb life as lighting level is reduced.
- Field-adjustable trim control permits user to set minimum light level as desired.
- Includes line voltage compensation circuitry, to reduce changes in light level caused by line voltage fluctuation.
- 600V, UL/CSA hook-up wire, multi-stranded, fray-resistant, pre-tinned, insulation rated at 105°C.
- Anodized extruded aluminum fins provide heat sink for electronic components.
- Installs in NEMA standard single-gang wall boxes.
- De-rating required when fins are removed.

Performance

Electrical

Voltage	120VAC 60 Hz
Rated Load	(See Above) Incandescent Only
Filtering	Radio Frequency Interference Filtering
Construction	Printed Circuit Board for Reliability
3rd Party Compliance	UL Listed CSA Certified

Controls

Output	Safety Power Off Switch
--------	-------------------------

Physical

Size	Gangable
Heat Sink	Finned Aluminum
Wiring	6" Color-Coded Leads Pre-Stripped

Environmental

Application	Indoor Use Only
-------------	-----------------

Materials

Knob	Flame Retardant UL94 V0, UV Stable Polycarbonate
Back Body	Unbreakable ABS

Accessories

Snap-On Cover Plate	Provided
Twist Wire Connectors	Provided
Installation and Operating Instructions	Provided
1000 Watt White Cover Plate and Knob Kit	Available: DAPK1W
1500/2000 Watt White Cover Plate and Knob Kit	Available: DAPK2W
1000 Watt Brown Cover Plate and Knob Kit	Available: DAPK1
1500/2000 Watt Brown Cover Plate and Knob Kit	Available: DAPK2
Matching Rotary Switch	Available: 90200

Project

Location/Type

Dimmers & Fan Speed Controls



Pass & Seymour

Today's home and business owners want optimum control of their electrical systems. P&S Dimmers & Fan Speed Controls provide that control — along with aesthetics, durability, trouble-free installation, and innovative technologies.

Benefits of Using Legrand/Pass & Seymour Dimming

Save Energy – Dimming reduces the amount of energy consumed by the lamps which reduces energy costs.

Add ambience – Change the lighting to set the mood or highlight the décor.

Add comfort – Use only the light you need for the task.

Add flexibility – Change the look of the room and then change it back. Quickly and easily.

Add convenience – Presets and scene controls make it easy to set up your home the way you like with accuracy and repeatability.

Increase safety and security – Never drive up to a dark house again.

Lower maintenance costs – Dimming increases the life of incandescent lamps.

Add value – A home with lighting controls is worth more.



Index

Device	Page Number
Product Selection Guide	M-2
Catalog Numbering System	M-3
Residential Dimmers & Fan Speed Controls	
RF Lighting Control System	M-4 – M-7
Scene Director	M-8, M-9, M-34
Leandro®	M-10, M-34
Harmony™ TradeMaster®	M-11, M-12, M-34
TradeMaster® Toggle	M-18, M-19, M-20, M-36
Rotary R TradeMaster® Series	M-21
Residential & Light Commercial Dimmers & Fan Speed Controls	
LS TradeMaster® Series	M-13 – M-15, M-35
DR TradeMaster® Series	M-16, M-34
Wide Slide TradeMaster® Series	M-17, M-36
Rotary TradeMaster® Series	M-22, M-23, M-37
Commercial Dimmers & Fan Speed Controls	
Titan™ Series	M-24 – M-31, M-38
Rotary Dimmers	M-32
Rotary Fan Speed Controls	M-33, M-39



Energy concerns have created directives in some states for lighting controls in new residential construction and major renovations. In an effort to reduce electrical power consumption, California has mandated one of the most stringent energy codes in the country. California Title 24 requires high efficacy luminaires, vacancy sensors (Section L), or dimmers to be placed in certain areas of the home. The standard became effective on October 1, 2005. Other states are considering adopting similar mandates to answer their own energy concerns. Legrand/Pass & Seymour has an extensive selection of vacancy sensor and dimmer solutions to address this growing industry trend.



RF Lighting Control System

- Whole house and room scene controls allow homeowners to change their environment at the push of a button.
- Frequency-agile Radio Frequency (RF) wireless communications technology.
- Simple, intuitive programming without the use of a computer or controller.

PAGES M-4 – M-7



Scene Director Control

- Select any lighting scene at the touch of a button.
- Optional infrared remote enables control from anywhere in the room.
- Master can control up to 30 dimmers.
- Easy to program – and won't lose programming during power outage.

PAGES M-8, M-9



Leandro® Decorator Dimmers

- Multi-location dimming.
- Light levels fade elegantly up/down.
- Green LEDs indicate preset level; red LED makes dimmers easy to find in the dark.

PAGE M-10



Harmony™ Decorator Dimmers

- Matches P&S Decorator devices.
- Combines ON/OFF Decorator switch with separate slider for dimming control.
- No lost settings during power outages.

PAGE M-11, M-12



LS Series Decorator Slide Dimmers

- Smooth, ergonomic operation.
- Snap-in LED light modules make dimmers easy to find at night.
- Available in both preset and non-preset models.

PAGES M-13 – M-15



DR Series Decorator Rotary Dimmers

- Illuminated knob shows light level.
- Snap-in LED light modules make dimmers easy to find at night.
- Available for incandescent and low-voltage lighting.

PAGE M-16



Toggle Dimmers

- Convenient preset dimming control.
- Combines ON/OFF toggle with separate preset for dimming control.
- Matches appearance of toggle switches.

PAGE M-18, M-19



- Match appearance of toggle switches.
- No loss of settings during power outages.
- Illuminated versions available.

PAGE M-20



Rotary Dimmers

- Models for incandescent and low-voltage lights; preset and illuminated features available.
- Simple to operate.
- Available in both preset and non-preset models.

PAGE M-21



Dimmers & Fan Speed Controls Catalog Numbering System

Pass & Seymour



All P&S Dimmers and Fan Speed Controls use an easy-to-understand catalog numbering system:

T LV 600 - *

Control Type

D = Decorator
LS = Long Slide
SC = Scene Director
T = Toggle
R = Rotary
DR = Decorator Rotary

Load Type

Blank = Incandescent
FB = Fluorescent Ballast
IR = Infrared Remote
LV = Magnetic Low-Voltage
ELV = Electronic Low-Voltage
MC = Master Controller
DC = Dual Dimmer/De-Hummer Speed Control
DV = Dimmer/Variable Speed Control
DH = De-Hummer Fan Speed Control
SC = Fan Speed Control

Load Size

300 = 300 Watt
600 = 600 Watt/VA
603 = 600 Watt/VA, 3-Way
700 = 700 Watt
703 = 700 Watt 3-Way
1000 = 1000 Watt/VA
1003 = 1000 Watt/VA, 3-Way
1100 = 1100 Watt
1103 = 1100 Watt 3-Way
1600 = 1600 Watt
1603 = 1600 Watt 3-Way
2000 = 2000 Watt
2003 = 2000 Watt 3-Way
3 = 3 Amps
5 = 5 Amps
7 = 7 Amps
8 = 8 Amps
10 = 10 Amps
15 = 1.5 Amps
16 = 1.6 Amps or 16 Amps
25 = 2.5 Amps

Package

Blank = Box
V = VisionPak™
TK = Triple Knob

Color

BK = Black
(Blank) = Brown
CL = Clear
GRY = Gray
I = Ivory
LA = Light Almond
LC = Lighted Clear
W = White

Options

E = Electronic Preset
L = Lighted
M = Multilocation
P = Preset

Examples:

D600MLAV = Decorator Dimmer, Incandescent, 600W, Multilocation, Light Almond, in a VisionPak

LS600LA = Decorator Slide Dimmer, Incandescent, 600W, Light Almond, in a Box

SSSC5-WV = Short Slide, Fan Speed Control, 5 Amp, White, in a VisionPak

Many P&S Dimmers & Fan Speed Controls are available boxed or VisionPak™ clam-shell packaging for high-impact merchandising. Please see the Catalog Numbering System above or specific charts for ordering information.

See Pages M-4 – M-7 to order RF Lighting Control System products.



Pass & Seymour

Commercial Dimmers & Fan Speed Controls Rotary Dimmers

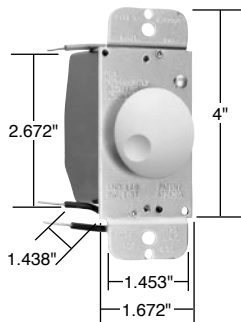

90621

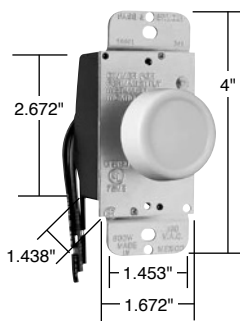

95600

Features	
<ul style="list-style-type: none"> Full range rotary dimming. Low-voltage and fluorescent models have field adjustable trims that may be set to control minimum light level. Ground lead provided on all models. New attractive knob design. 	<ul style="list-style-type: none"> Voltage compensation circuitry in fluorescent and magnetic low-voltage model reduces lighting fluctuations. All models fit standard toggle wall plate. All dimmers on this page may be ganged without de-rating. RFI protected.

Catalog Number	Description	Ratings	Color
Incandescent Specification Grade Rotary Dimmers — Single Pole			
90621IV 90621WV	Low Profile, Dial ON/OFF	120V, 600W max.	Ivory White
Magnetic Low-Voltage Specification Grade Rotary Dimmers — Single Pole*			
95600I 95600W	Preset, Push ON/OFF	120V, 600W max.	Ivory White

*For use with magnetic transformer incandescent low-voltage lighting.

Catalog Number		Description	Ratings	Color
Single Pole	Three-Way			
1000W Max. Incandescent Rotary Dimmers with Architectural Heat Sink				
91000I 91000W	91003I 91003W	Preset, Push ON/OFF	120V 1000W max.	Ivory White
91001I 91001W		Dial, ON/OFF	120V 1000W max.	Ivory White
1500W Max. Incandescent Rotary Dimmers with Architectural Heat Sink				
91500I	91503I 91503W	Preset, Push ON/OFF	120V 1500W max.	Ivory White
91501I 91501W		Dial, ON/OFF	120V 1500W max.	Ivory White
2000W Max. Incandescent Rotary Dimmers with Architectural Heat Sink				
92001I 92001W		Dial, ON/OFF	120V 2000W max.	Ivory White

*Fits in standard toggle wall plate opening.

Catalog Number	Description	Ratings	Color
1000VA Max. Magnetic Low-Voltage Specification Grade Single Pole Rotary Dimmer* with Architectural Heat Sink			
95100I	Dial, ON/OFF	120V, 1000VA max.	Ivory

* For use with magnetic transformer incandescent low-voltage lighting.

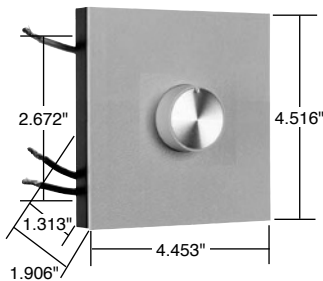

91500 91503
91501 92001

Catalog Number	Description	Color
Accessories for Rotary Heat Sink Dimmers & Fan Speed Controls		
DAPK1I DAPK1W DAPK1	1-Gang Wall Plate – Plate and Knob Kit	Ivory White Brown
DAPK2I DAPK2W DAPK2	2-Gang Wall Plate – Plate and Knob Kit	Ivory White Brown

For wiring diagrams, see Page S-20. For de-rating chart, see Page M-22.

Devices & Wall Plates Color Selection Chart



Pass & Seymour

Devices & Plastic Wall Plate Colors

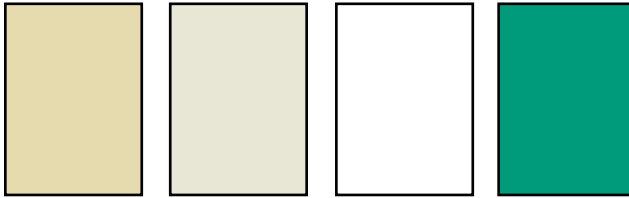

Ivory Light Almond White Green

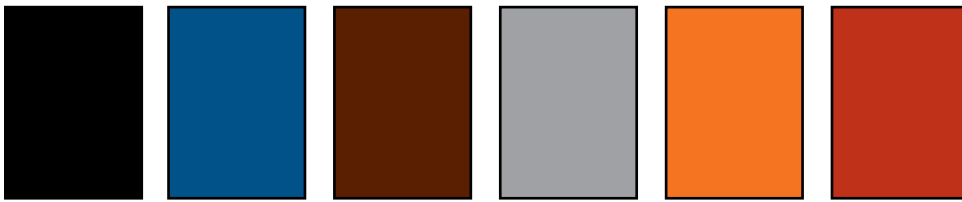

Black Blue Brown Gray Orange Red

See specific device and wall plate catalog charts for particular color availabilities.

Metal Wall Plates

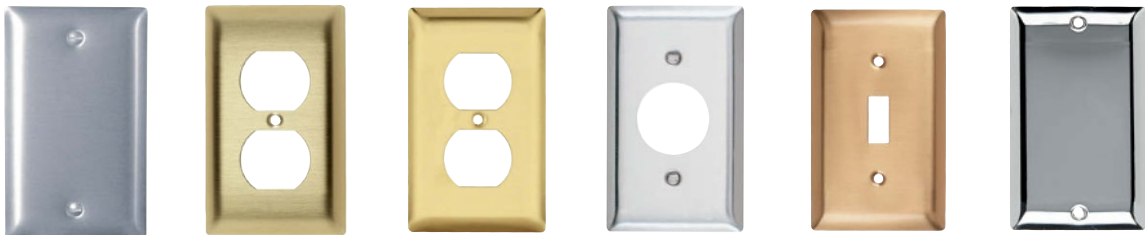

Metal Finish Aluminum Brass (Brushed) Polished Brass Stainless Steel Brushed Bronze Chrome

Custom Metal Wall Plates Paint Finish Colors

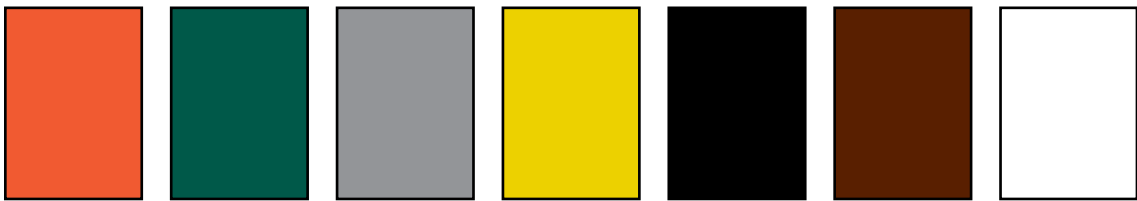

Paint Color Orange Green Gray Yellow Glossy Black Brown White

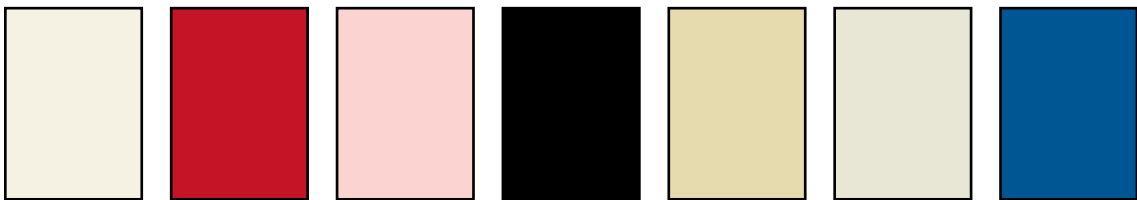

Paint Color Primer Red Pink Flat Black Ivory Light Almond Blue

To order custom metal wall plates, see Pages Q-43 – Q-45.

For additional colors consult factory.



Pass & Seymour

Technical Specifications High Wattage Rotary Dimmers

Preset Push On/Off Incandescent 120VAC, 60 Hz

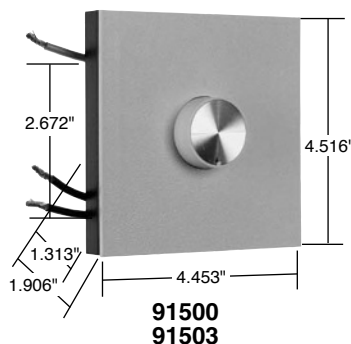
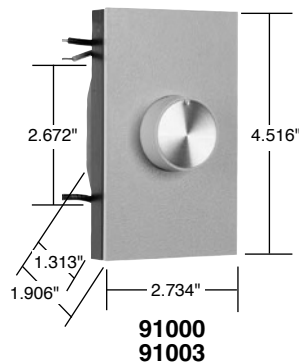

Typical Specifications

Incandescent dimmer shall be UL Listed/CSA Certified Legrand/Pass & Seymour Specification Grade, with full range solid-state circuitry giving even control by means of rotary action and positive ON/OFF switching. All dimmers shall fit standard single gang wall boxes. Conforms to NEMA WD-1 and WD-6.

Catalog Number	Color	Description	Rated Load
<input type="checkbox"/> 91000I	Ivory	Single Pole – Preset Push ON/OFF	1000W
<input type="checkbox"/> 91000W	White	Single Pole – Preset Push ON/OFF	1000W
<input type="checkbox"/> 91003I	Ivory	Three-Way – Preset Push ON/OFF	1000W
<input type="checkbox"/> 91003W	White	Three-Way – Preset Push ON/OFF	1000W
<input type="checkbox"/> 91500I	Ivory	Single Pole – Preset Push ON/OFF	1500W
<input type="checkbox"/> 91503I	Ivory	Three-Way – Preset Push ON/OFF	1500W
<input type="checkbox"/> 91503W	White	Three-Way – Preset Push ON/OFF	1500W

Features

- Maximum ratings are for continuous full load.
- Superior state-of-the-art solid-state electronic circuitry design increases energy savings and extends bulb life as lighting level is reduced.
- Field-adjustable trim control permits user to set minimum light level as desired.
- Includes line voltage compensation circuitry, to reduce changes in light level caused by line voltage fluctuation.
- 600V, UL/CSA hook-up wire, multi-stranded, fray-resistant, pre-tinned, insulation rated at 105°C.
- Anodized extruded aluminum fins provide heat sink for electronic components.
- Installs in NEMA standard single-gang wall boxes.
- De-rating required when fins are removed.

Performance

Electrical

Voltage	120VAC 60 Hz
Rated Load	(See Above) Incandescent Only
Filtering	Radio Frequency Interference Filtering
Construction	Printed Circuit Board for Reliability
3rd Party Compliance	UL Listed CSA Certified

Controls

Output	Safety Power Off Switch
--------	-------------------------

Physical

Size	Gangable
Heat Sink	Finned Aluminum
Wiring	6" Color-Coded Leads Pre-Stripped

Environmental

Application	Indoor Use Only
-------------	-----------------

Materials

Knob	Flame Retardant UL94 V0, UV Stable Polycarbonate
Back Body	Unbreakable ABS

Accessories

Snap-On Cover Plate	Provided
Twist Wire Connectors	Provided
Installation and Operating Instructions	Provided
1000 Watt White Cover Plate and Knob Kit	Available: DAPK1W
1500/2000 Watt White Cover Plate and Knob Kit	Available: DAPK2W
1000 Watt Brown Cover Plate and Knob Kit	Available: DAPK1
1500/2000 Watt Brown Cover Plate and Knob Kit	Available: DAPK2
Matching Rotary Switch	Available: 90200

Project

Location/Type