

# SOCKETS & LAMPHOLDERS

## Medium Base Lampholders

Aluminum—Screw Terminals / Push-In Terminals



### On-Off Push Thru Socket

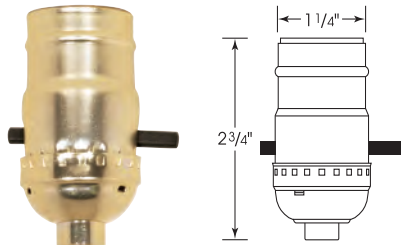

**80-1000**  
660W-250V

Cat No.	Finish	Terminal	Cap	Set Screw	Uno-Thread	Master
80-1000	Brite Gilt	Screw	1/8 IPS	Less	No	500
90-410	Brite Gilt	Screw	1/8 IPS	Less	No	250
80-1001	Nickel	Screw	1/8 IPS	Less	No	500
80-1527	Nickel	Screw	1/8 IPS	With	No	250
80-1529	Brite Gilt	Screw	1/8 IPS	With	No	250
90-1408	Brite Gilt	Screw	1/8 IPS	With	Yes	200/10
80-1348	Brite Gilt	Push-In	1/8 IPS	Less	No	500

### On-Off Push Thru Socket w/Side Outlet - For SPT-2

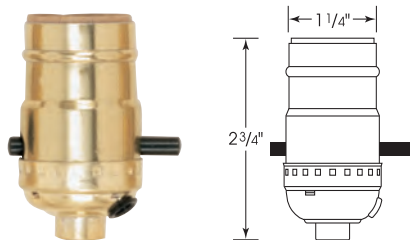

**90-418**  
660W-250V

Cat No.	Finish	Terminal	Cap	Set Screw	Uno-Thread	Master
90-418	Brite Gilt	Screw w/Sideout Hole	1/8 IPS	Less	No	250
80-1754	Nickel	Screw w/Sideout Hole	1/8 IPS	With	No	250
80-2137	Brite Gilt	Screw w/Sideout Hole	1/8 IPS	With	No	250
80-2437	Regular Antique Brass	Screw w/Sideout Hole	1/8 IPS	With	No	250
80-2438	Dark Antique Brass	Screw w/Sideout Hole	1/8 IPS	With	No	250

### 3 Terminal (2 Circuit) Turn Knob Socket w/Removable Knobs

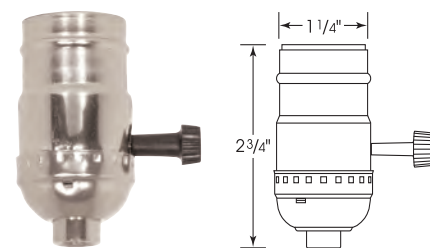

**80-1009**  
250W-250V

Cat No.	Finish	Terminal	Cap	Set Screw	Uno-Thread	Master
80-1008	Brite Gilt	Screw	1/8 IPS	Less	No	500
90-421	Brite Gilt	Screw	1/8 IPS	Less	No	250
80-1009	Nickel	Screw	1/8 IPS	Less	No	500
80-1501	Brite Gilt	Screw	1/4 IPS	Less	No	250
80-2138	Nickel	Screw	1/4 IPS	Less	No	250
80-2392	Brite Gilt	Screw	1/8 IPS	With	No	250
80-2393	Nickel	Screw	1/8 IPS	With	No	250

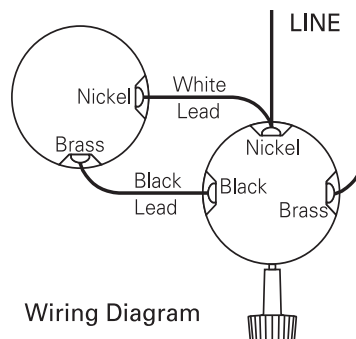

# SOCKETS & LAMPHOLDERS

## Medium Base Lampholders

Aluminum—Screw Terminals / Push-In Terminals



### On-Off Push Thru Socket

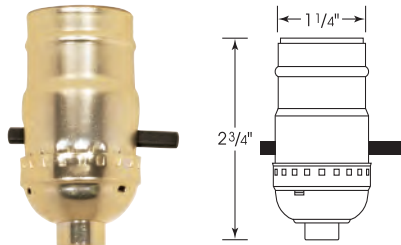

**80-1000**  
660W-250V

Cat No.	Finish	Terminal	Cap	Set Screw	Uno-Thread	Master
80-1000	Brite Gilt	Screw	1/8 IPS	Less	No	500
90-410	Brite Gilt	Screw	1/8 IPS	Less	No	250
80-1001	Nickel	Screw	1/8 IPS	Less	No	500
80-1527	Nickel	Screw	1/8 IPS	With	No	250
80-1529	Brite Gilt	Screw	1/8 IPS	With	No	250
90-1408	Brite Gilt	Screw	1/8 IPS	With	Yes	200/10
80-1348	Brite Gilt	Push-In	1/8 IPS	Less	No	500

### On-Off Push Thru Socket w/Side Outlet - For SPT-2

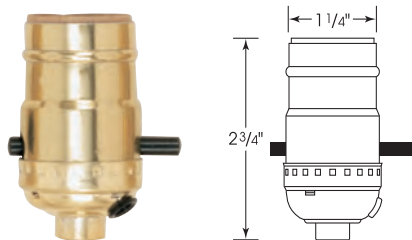

**90-418**  
660W-250V

Cat No.	Finish	Terminal	Cap	Set Screw	Uno-Thread	Master
90-418	Brite Gilt	Screw w/Sideout Hole	1/8 IPS	Less	No	250
80-1754	Nickel	Screw w/Sideout Hole	1/8 IPS	With	No	250
80-2137	Brite Gilt	Screw w/Sideout Hole	1/8 IPS	With	No	250
80-2437	Regular Antique Brass	Screw w/Sideout Hole	1/8 IPS	With	No	250
80-2438	Dark Antique Brass	Screw w/Sideout Hole	1/8 IPS	With	No	250

### 3 Terminal (2 Circuit) Turn Knob Socket w/Removable Knobs

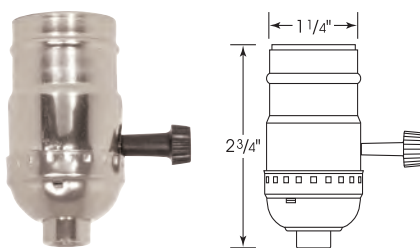

**80-1009**  
250W-250V

Cat No.	Finish	Terminal	Cap	Set Screw	Uno-Thread	Master
80-1008	Brite Gilt	Screw	1/8 IPS	Less	No	500
90-421	Brite Gilt	Screw	1/8 IPS	Less	No	250
80-1009	Nickel	Screw	1/8 IPS	Less	No	500
80-1501	Brite Gilt	Screw	1/4 IPS	Less	No	250
80-2138	Nickel	Screw	1/4 IPS	Less	No	250
80-2392	Brite Gilt	Screw	1/8 IPS	With	No	250
80-2393	Nickel	Screw	1/8 IPS	With	No	250

