

FLUKE®

787

ProcessMeter™

Users Manual

April 1997 Rev. 5, 7/17

© 1997-2017 Fluke Corporation. All rights reserved. Specifications are subject to change without notice.
All product names are trademarks of their respective companies.

LIMITED WARRANTY AND LIMITATION OF LIABILITY

This Fluke product will be free from defects in material and workmanship for three years from the date of purchase. This warranty does not cover fuses, disposable batteries, or damage from accident, neglect, misuse, alteration, contamination, or abnormal conditions of operation or handling. Resellers are not authorized to extend any other warranty on Fluke's behalf. To obtain service during the warranty period, contact your nearest Fluke authorized service center to obtain return authorization information, then send the product to that Service Center with a description of the problem.

THIS WARRANTY IS YOUR ONLY REMEDY. NO OTHER WARRANTIES, SUCH AS FITNESS FOR A PARTICULAR PURPOSE, ARE EXPRESSED OR IMPLIED. FLUKE IS NOT LIABLE FOR ANY SPECIAL, INDIRECT, INCIDENTAL OR CONSEQUENTIAL DAMAGES OR LOSSES, ARISING FROM ANY CAUSE OR THEORY. Since some states or countries do not allow the exclusion or limitation of an implied warranty or of incidental or consequential damages, this limitation of liability may not apply to you.

Fluke Corporation
P.O. Box 9090
Everett, WA 98206-9090
U.S.A.

Fluke Europe B.V.
P.O. Box 1186
5602 BD Eindhoven
The Netherlands

Table of Contents

Title	Page
Introduction	1
Contacting Fluke	1
Safety Information	2
How to Get Started	6
Getting Acquainted with the Meter	7
Measuring Electrical Parameters.....	18
Input Impedance.....	18
Ranges	18
Measuring a Composite Signal.....	18
Testing Diodes.....	19
Displaying Minimum, Maximum, and Average.....	19
Using TouchHold	20
Compensating for Test Lead Resistance.....	20
Using the Current Output Functions	21
Source Mode	21
Simulate Mode.....	23
Changing the Current Span	23
Producing a Steady mA Output	25

Manually Stepping the mA Output	26
Auto Ramping the mA Output	27
Power-Up Options	28
Battery Life.....	29
Using the Holster	29
Maintenance	30
General Maintenance.....	30
Calibration.....	30
Replacing the Battery.....	30
Replacing a Fuse	32
If the Meter does not Work.....	33
Replacement Parts and Accessories	34
Specifications.....	37

List of Tables

Table	Title	Page
1.	Symbols.....	5
2.	Input/Output Jacks.....	8
3.	Rotary Switch Positions for Measurements.....	10
4.	Rotary Knob Positions for mA Output.....	12
5.	Pushbuttons.....	13
6.	Display.....	16
7.	Range Requirements for Measuring a Composite Signal.....	18
8.	Steady mA Output Adjustment.....	25
9.	Steady mA Output Adjustment.....	26
10.	mA Step Values.....	27
11.	Power-Up Options.....	28
12.	Typical Alkaline Battery Life.....	29
13.	Replacement Parts.....	35

List of Figures

Figure	Title	Page
1.	Fluke 787 ProcessMeter.....	6
2.	Input/Output Jacks.....	7
3.	Rotary Switch Positions for Measurements.....	9
4.	Rotary Switch Positions for mA Output.....	11
5.	Pushbuttons.....	13
6.	Elements of the Display.....	15
7.	Sourcing Current.....	22
8.	Simulating a Transmitter.....	24
9.	Using the Holster.....	30
10.	Replacing the Battery.....	31
11.	Replacing a Fuse.....	33
12.	Replacement Parts.....	36

Introduction

⚠ Warning

Read “Safety Information” before you use the Meter.

Your Fluke 787 ProcessMeter™ (referred to as “the Product or Meter”) is a handheld, battery-operated tool for measuring electrical parameters and supplying steady or ramping current to test process instruments. It has all the features of a digital multimeter, plus current output capability.

If the Meter is damaged or something is missing, contact the place of purchase immediately.

Contact your Fluke distributor for information about DMM accessories. To order replacement parts or spares, see Table 13 near the end of this manual.

Contacting Fluke

To contact Fluke, call one of the following telephone numbers:

- Technical Support USA: 1-800-44-FLUKE (1-800-443-5853)
- Calibration/Repair USA: 1-888-99-FLUKE (1-888-993-5853)
- Canada: 1-800-36-FLUKE (1-800-363-5853)
- Europe: +31 402-675-200
- Japan: +81-3-6714-3114
- Singapore: +65-6799-5566
- China: +86-400-921-0835
- Anywhere in the world: +1-425-446-5500

Or, visit Fluke's website at www.fluke.com.

To register your product, visit <http://register.fluke.com>.

To view, print, or download the latest manual supplement, visit <http://us.fluke.com/usen/support/manuals>.

Safety Information

The symbols used on the Product and in this manual are shown in Table 1.

A **Warning** identifies conditions and procedures that are dangerous to the user. A **Caution** identifies conditions and procedures that can cause damage to the Product or the equipment under test.

Warning

To prevent possible electrical shock, fire, or personal injury:

- Read “Safety Information” before using the Product.
- Do not use the Meter if it is damaged. Before you use the Meter, inspect the case. Look for cracks or missing plastic. Pay particular attention to the insulation surrounding the connectors.

- Make sure the battery door is closed and latched before operating the Meter.
- Remove test leads from the Meter before opening the battery door.
- Inspect the test leads for damaged insulation or exposed metal. Check test lead continuity. Replace damaged test leads before you use the Meter.
- Measure a known voltage first to make sure that the Meter operates correctly. If you are unsure, have the Meter examined.
- Do not operate the Meter around explosive gas, vapor, or dust. Do not use in a damp or wet environment.
- Use only a single 9 V battery, properly installed in the meter case, to power the Meter.
- When servicing the Meter, use only specified replacement parts.
- Before a current measurement, do the fuse test.
- Use the correct terminals, function, and range for measurements.
- Do not work alone.

- For current measurements, connect the Meter to the circuit after you remove circuit power. Always put the Meter in series with the circuit.
- Comply with local and national safety requirements when in hazardous locations.
- Only use test leads that have the same voltage, category, and amperage ratings as the Meter and that are approved by a safety agency. When used with optional accessories, the lowest category rating applies.
- Do not use TouchHold to determine if dangerous voltage is present. TouchHold will not capture unstable or noisy readings.
- To avoid false readings, which could lead to possible electric shock or personal injury, replace the battery as soon as the battery indicator (🔋) appears.
- Remove test leads from the Meter before you open the battery door.
- Close and latch the battery door before using the Meter.
- To avoid personal injury or damage to the Meter, use only the specified replacement fuse, 440 mA 1000 V fast-blow, Fluke PN 943121.
- Do not exceed the Measurement Category (CAT) rating of the lowest rated individual component of a Product, probe, or accessory.
- Do not use the TL175 or TP175 test probes in CAT III or CAT IV environments without the probe tip fully extended and correct category rating visible in the window.
- When the TL175 is used with instruments or other accessories, the lowest category rating of the combination applies. One exception is when the probe is used with the AC172 or AC175.

⚠ Caution

To prevent possible damage to Product or to equipment under test:















- Disconnect the power and discharge all high-voltage capacitors before testing resistance or continuity.

- **Use the proper jacks, function, and range for your measurement or sourcing application.**
- **For best mechanical performance, the Product must remain in the holster at all times.**

To protect yourself, adhere to the following guidelines:

- Use caution when working above 30 V ac rms, 42 V ac pk, or 60 V dc. Such voltages pose a shock hazard.
- When using the probes, keep your fingers behind the finger guards on the probes.
- Connect the common test lead before you connect the live test lead. When you disconnect test leads, disconnect the live test lead first.

Table 1. Symbols

Symbol	Meaning	Symbol	Meaning
	WARNING. HAZARDOUS VOLTAGE. Risk of electric shock.		Fuse
	WARNING. RISK OF DANGER.		Double Insulated
	Consult user documentation		Conforms to relevant Australian EMC standards.
	AC (Alternating Current)		Battery
	DC (Direct Current)		Earth
	Alternating or direct current		Conforms to relevant South Korean EMC Standards.
	Conforms to relevant North American Safety Standards.		
CAT II	Measurement Category II is applicable to test and measuring circuits connected directly to utilization points (socket outlets and similar points) of the low-voltage MAINS installation.		
CAT III	Measurement Category III is applicable to test and measuring circuits connected to the distribution part of the building's low-voltage MAINS installation.		
CAT IV	Measurement Category IV is applicable to test and measuring circuits connected at the source of the building's low-voltage MAINS installation.		
	This product complies with the WEEE Directive marking requirements. The affixed label indicates that you must not discard this electrical/electronic product in domestic household waste. Product Category: With reference to the equipment types in the WEEE Directive Annex I, this product is classed as category 9 "Monitoring and Control Instrumentation" product. Do not dispose of this product as unsorted municipal waste.		

How to Get Started

If you are familiar with the Fluke 80 Series DMM, read “Using the Current Output Functions,” review the tables and figures in “Getting Acquainted with the Meter,” and begin using your Meter.

If you are unfamiliar with Fluke 80 Series DMMs, or DMMs in general, read “Measuring Electrical Parameters” in addition to the sections referenced in the previous paragraph.

The sections following “Using the Current Output Functions” contain information about the power-up options, and battery and fuse replacement instructions.

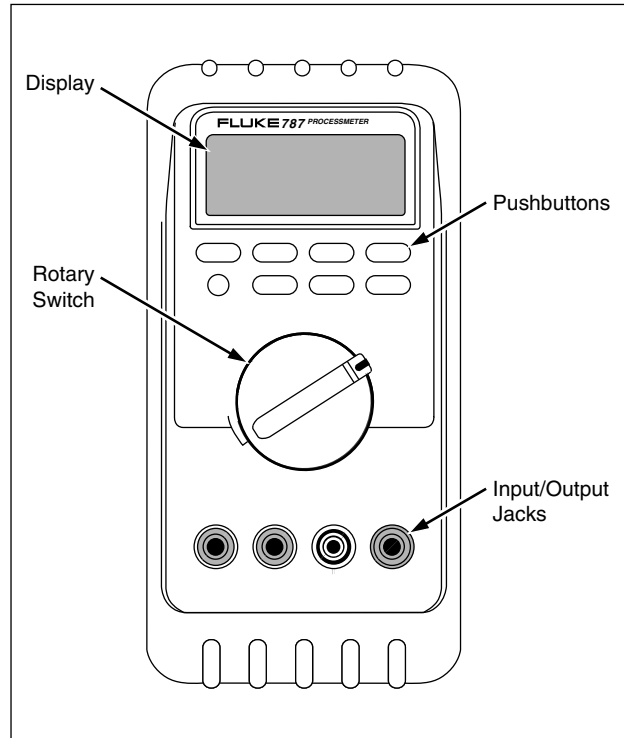

ee014f.eps

Figure 1. Fluke 787 ProcessMeter

Getting Acquainted with the Meter

To become familiar with the features and functions of the Meter, study the following figures and tables.

- Figure 2 and Table 2 describe the input/output jacks.
- Figure 3 and Table 3 describe the input functions you get with the first five rotary switch positions.
- Figure 4 and Table 4 describe the output functions you get with the last two rotary switch positions.
- Figure 5 and Table 5 describe the functions of the pushbuttons.
- Figure 6 and Table 6 explain what all the elements of the display indicate.

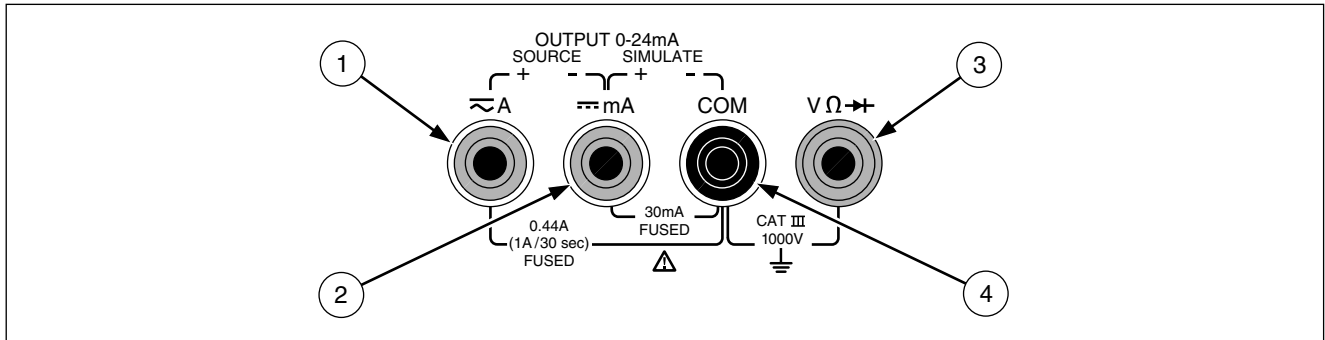





Figure 2. Input/Output Jacks

ee001f.eps

Table 2. Input/Output Jacks

Item	Jack	Measurement Functions	Source Current Function	Simulate Transmitter Function
①	 A	Input for current to 440 mA continuous. (1A for up to 30 seconds.) Fused with a 440 mA fuse.	Output for dc current to 24 mA.	
②	 mA	Input for current to 30 mA. Fused with a 440 mA fuse.	Common for dc current output to 24 mA.	Output for transmitter simulation to 24 mA. (Use in series with an external loop supply.)
③	V Ω 	Input for voltage to 1000V, Ω , continuity, and diode test.		
④	COM	Common for all measurements.		Common for transmitter simulation to 24 mA. (Use in series with an external loop supply.)

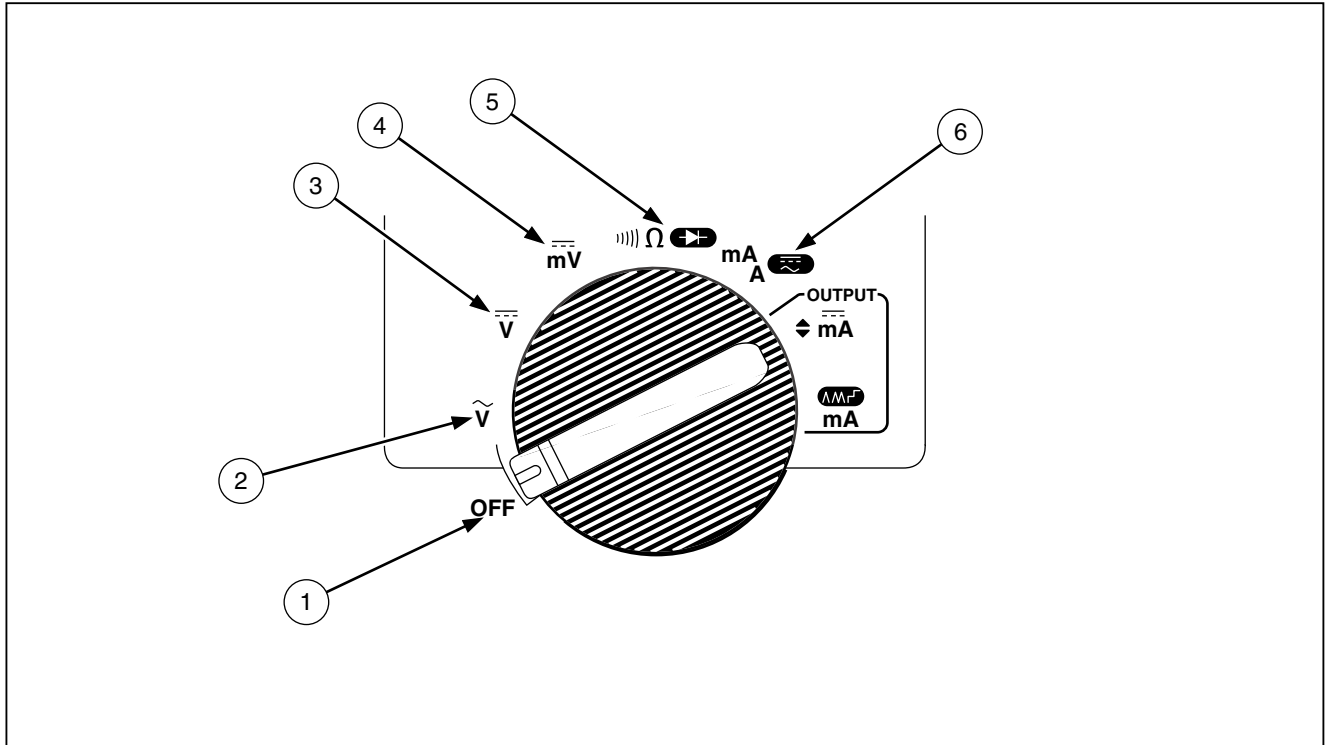













Figure 3. Rotary Switch Positions for Measurements

ee002f.eps

Table 3. Rotary Switch Positions for Measurements

No.	Position	Function(s)	Pushbutton Actions
①	OFF	Meter off	
②	V ~	Default: measure ac V  Hz Frequency counter	 Selects a MIN, MAX, or AVG action (see pg. 18)  Selects a fixed range (hold 1 second for auto range)  Toggles TouchHold  Toggles relative reading (sets a relative zero point)
③	== V	Measure dc V	Same as above
④	== mV	Measure dc mV	Same as above
⑤	 Ω 	Default: measure Ω  for continuity BLUE  test	Same as above, except diode test has only one range
⑥	mA A 	<i>High test lead in</i>  A: measure A dc BLUE selects ac <i>High test lead in</i>  mA: measure mA dc	Same as above, except there is only one range for each input jack position, 30 mA or 1A

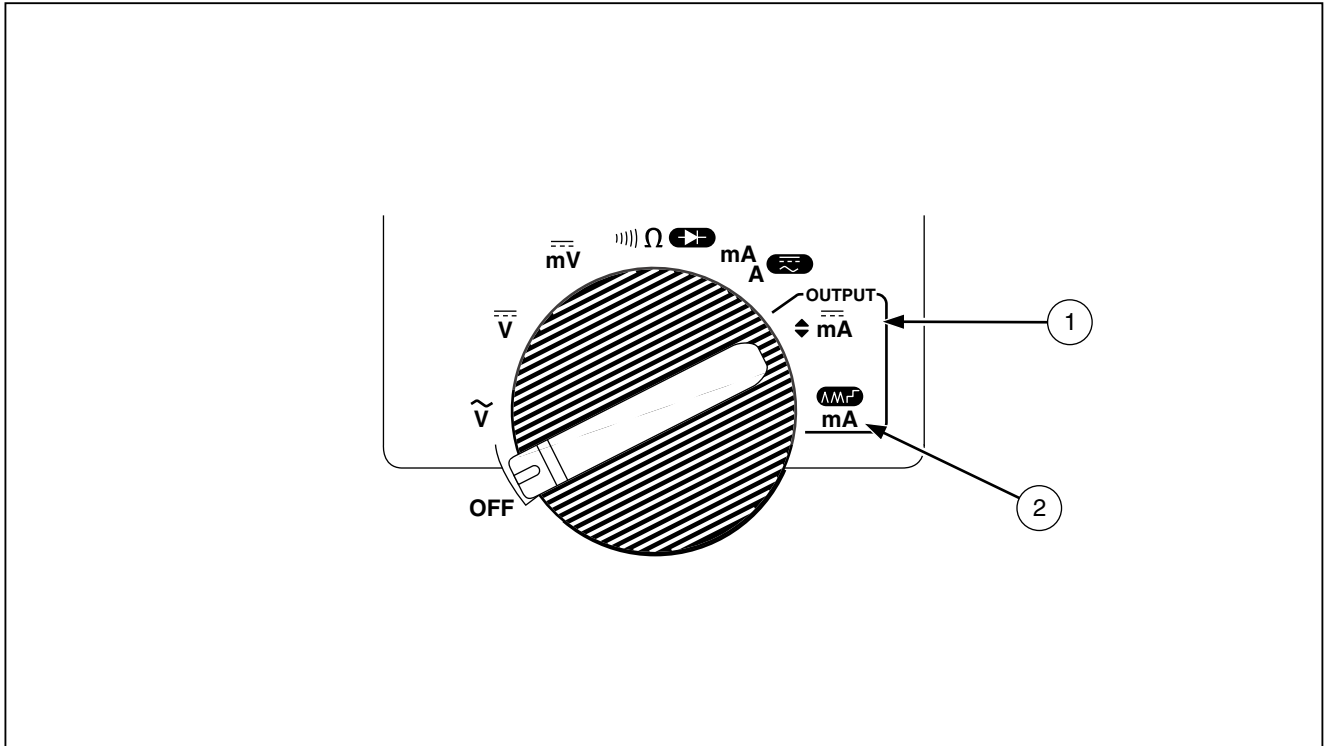

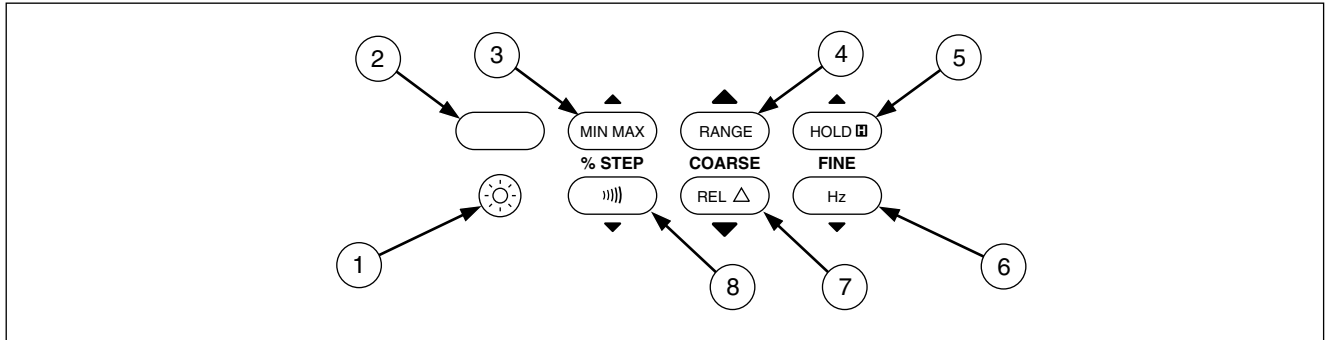

Figure 4. Rotary Switch Positions for mA Output

ee008.eps

Table 4. Rotary Switch Positions for mA Output

No.	Position	Default Function	Pushbutton Actions
①	OUTPUT ◆ mA	<i>Test leads in SOURCE:</i> Source 0 % mA <i>Test leads in SIMULATE:</i> Sink 0 % mA	% STEP ▲ or ▼: Adjusts output up or down to the next 25 % step COARSE ▲ or ▼: Adjusts output up or down 0.1 mA FINE ▲ or ▼: Adjusts output up or down 0.001 mA
②	OUTPUT mA 	<i>Test leads in SOURCE:</i> Source repeating 0 % -100 %-0 % slow ramp (∧) <i>Test leads in SIMULATE:</i> Sink repeating 0 % -100 %-0 % slow ramp (∧)	BLUE cycles through: <ul style="list-style-type: none"> • Fast repeating 0 % -100 % - 0 % ramp (∧ on display) • Repeating 0 % -100 % - 0 % ramp in 25 % steps (□ on display) • Slow repeating 0 % -100 % - 0 % ramp (∧ on display)





ee003f.eps

Figure 5. Pushbuttons

Table 5. Pushbuttons

No.	Pushbutton	Function(s)
①		Toggles the backlight
②	 (BLUE)	<p>Rotary switch in mA A position and test lead plugged into A jack: Toggles between ac and dc ampere measure</p> <p>Rotary switch in Ω position: Selects diode test function ()</p> <p>Rotary switch in OUTPUT mA position: Cycles through</p> <ul style="list-style-type: none"> • Slow repeating 0 % -100 % - 0 % ramp (on display) • Fast repeating 0 % -100 % - 0 % ramp (on display) • Repeating 0 % -100 % - 0 % ramp in 25 % steps (on display)

Table 5. Pushbuttons (cont.)

No.	Pushbutton	Function(s)
③	▲ (MIN MAX) % STEP	<i>Measuring:</i> Selects a MIN, MAX, or AVG action (see pg. 18) <i>mA Output:</i> Adjusts mA output up to the next higher 25% step
④	▲ (RANGE) COARSE	<i>Measuring:</i> Selects a fixed range (hold for 1 second for auto range) <i>mA Output:</i> Adjusts output up 0.1 mA
⑤	▲ (HOLD)  FINE	<i>Measuring:</i> Toggles TouchHold, or in MIN MAX recording, suspends recording <i>mA Output:</i> Adjusts output up 0.001 mA
⑥	FINE (Hz) ▼	<i>Measuring:</i> Toggles between frequency counter and ac voltage measurement functions <i>mA Output:</i> Adjusts output down 0.001 mA
⑦	COARSE (REL)  ▼	<i>Measuring:</i> Toggles relative reading (sets a relative zero point) <i>mA Output:</i> Adjusts output down 0.1 mA
⑧	% STEP ()))  ▼	<i>Measuring:</i> Toggles between Ω measure and continuity functions <i>mA Output:</i> Adjusts mA output down to the next lower 25 % step

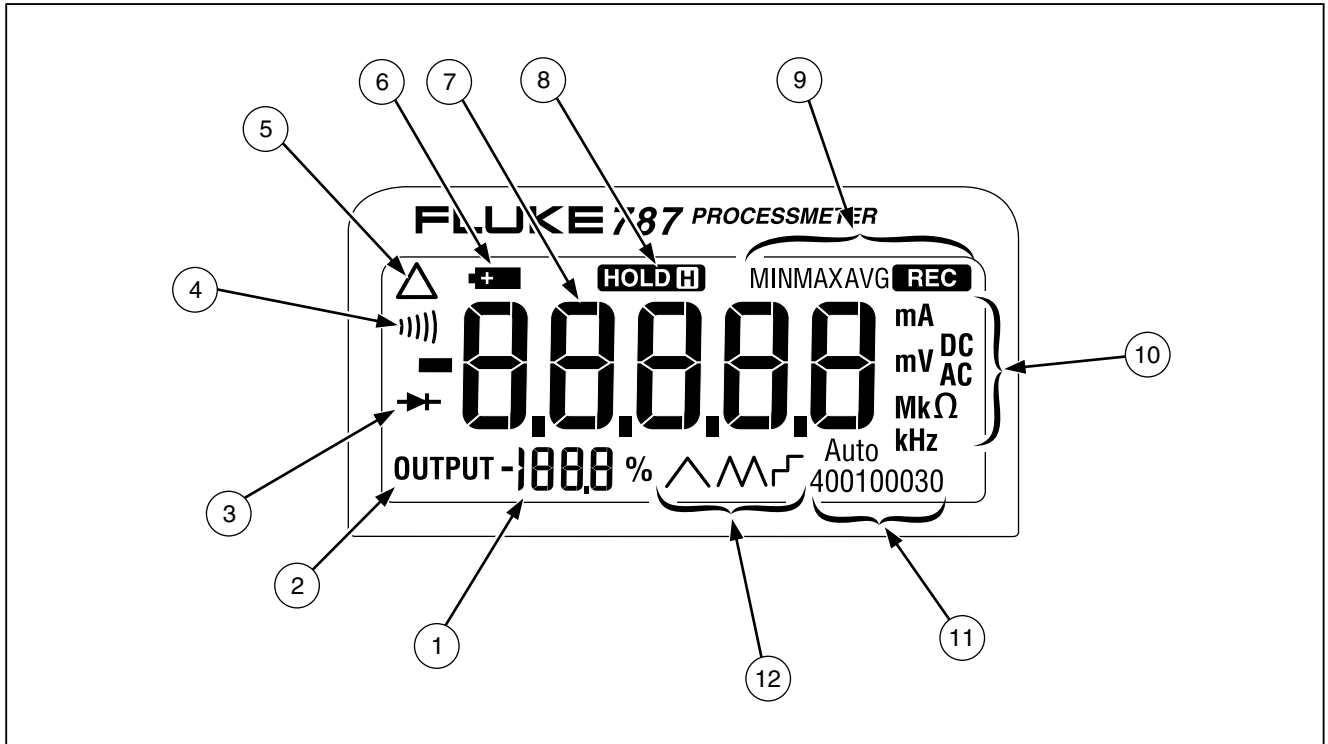

Figure 6. Elements of the Display

ee004f.eps

Table 6. Display





No.	Element	Meaning
①	Percentage display	Shows the mA measured value or output level in %, in a 0-20 mA or 4-20 mA scale (change scales with power-up option)
②	OUTPUT	Lights when mA output (source or simulate) is active
③		Lights in diode test function
④)	Lights in continuity function
⑤	△	Lights when relative reading is on
⑥		Lights when the battery is low
⑦	Numerals	Show the input or output value
⑧		Lights when TouchHold is on
⑨	MINMAXAVG 	<p>MIN MAX recording status indicators:</p> <p>MIN means the display is showing the minimum recorded value.</p> <p>MAX means the display is showing the maximum recorded value.</p> <p>AVG means the display is showing the average value since starting recording (up to about 35 hours continuous recording time).</p> <p> means MIN MAX recording is on.</p>

Table 6. Display (cont.)

No.	Element	Meaning
⑩	mA, DC, mV, AC, M or kΩ, kHz	Show the input or output units and multipliers associated with the numerals
⑪	Auto 400100030	Range status indicators: Auto means autoranging is on. The number plus the unit and multiplier indicate the active range.
⑫	∧ ∞ ⌐	One of these lights in mA ramping or step output (rotary switch position mA ∧∞⌐): ∧ means slow continuous 0% - 100% - 0% ramping. ∞ means fast continuous 0% - 100% - 0% ramping. ⌐ means ramping in 25% steps.

Measuring Electrical Parameters

The proper sequence for taking measurements is as follows:

1. Plug the test leads into the appropriate jacks.
2. Set the rotary knob.
3. Touch the probes to the test points.

Input Impedance

For the voltage measurement functions, input impedance is 10 M Ω . See the specifications for more information.

Ranges

A measurement range determines the highest value the Meter can measure. Most meter measurement functions have more than one range (see the Specifications).

Being in the right range is important:

- If the range is too low, the display shows **OL** (overload).
- If the range is too high, the Meter will not be displaying its most accurate measurement.

The Meter normally automatically selects the lowest range that will measure the applied input signal (Auto showing on the display). Press **RANGE** if you want to lock the

range. Each time you press **RANGE**, the Meter selects the next higher range.

If you have locked the range, the Meter resumes auto ranging when you change to another measurement function or you press **RANGE** and hold it for 1 second.

Measuring a Composite Signal

Because the input is dc-coupled, to measure an ac voltage or frequency with a dc bias, you must manually select the range specified in Table 7. For example, to measure 100 mV ac with 20 V dc superimposed, select the 4 V range.

Table 7. Range Requirements for Measuring a Composite Signal

Range (ac)	Max. Allowable AC + DC
400.0 mV	3 V
4.000 V	30 V
40.00 V	300 V
400.0 V	400 V
1000 V	1000 V

Testing Diodes

To test a single diode:

1. Insert the red test lead into the $V\Omega \rightarrow +$ jack and black test lead into the COM jack.
2. Set the rotary switch to $\Omega \rightarrow +$.
3. Press the BLUE pushbutton so that the $\rightarrow +$ symbol is on the display.
4. Touch the red probe to the anode and the black probe to the cathode (side with band or bands). The Meter should indicate the appropriate diode voltage drop.
5. Reverse the probes. The Meter should display OL, indicating high impedance.
6. The diode is good if it passes the tests in steps 4 and 5.

Displaying Minimum, Maximum, and Average

MIN MAX recording stores the lowest and highest measurements, and maintains the average of all measurements.

Press MIN MAX to turn on MIN MAX recording. Readings are stored until you turn the Meter off, switch to another measurement or source function, or turn MIN MAX off. The beeper sounds when a new maximum or minimum is recorded. Auto power-off is disabled and auto ranging is turned off during MIN MAX recording.

Press MIN MAX again to cycle through the MAX, MIN, and AVG displays. Press and hold MIN MAX for 1 second to erase stored measurements and exit.

If MIN MAX recording is on continuously for over 40 hours, minimum and maximum readings are still recorded, but the displayed average no longer changes.

In MIN MAX recording, press HOLD to suspend recording; press HOLD again to resume recording.

Using TouchHold

Note

You must have MIN MAX recording off to use TouchHold.



Warning

To avoid possible electric shock, do not use TouchHold to determine if dangerous voltage is present. TouchHold will not capture unstable or noisy readings.

Activate TouchHold® if you want the Meter to freeze the display on each new stable reading (except in the frequency counter function). Press  to activate TouchHold. This feature allows you to take measurements in situations in which it is difficult to look at the display. The Meter beeps and updates the display with each new stable reading.

Compensating for Test Lead Resistance

Use the relative reading feature (Δ on the display) to set the present measurement as a relative zero. A common use for this is to compensate for test lead resistance when measuring Ω .

Select the Ω measure function, touch the test leads together, then press . Until you press  again, or switch to another measurement or source function, the readings on the display will subtract the lead resistance.

Using the Current Output Functions

The Meter provides steady, stepped, and ramped current output for testing 0-20 mA and 4-20 mA current loops. You can choose source mode, in which the Meter supplies the current, or simulate mode, in which the Meter regulates current in an externally-powered current loop.

Source Mode

Source mode is selected automatically by inserting the test leads into the SOURCE + and – jacks as shown in Figure 7. Use source mode whenever you need to supply

current into a passive circuit such as a current loop with no loop supply. Source mode depletes the battery faster than simulate mode, so use simulate mode whenever possible.

The display looks the same in source and simulate modes. The way to tell which mode is in use is to see which pair of output jacks is in use.

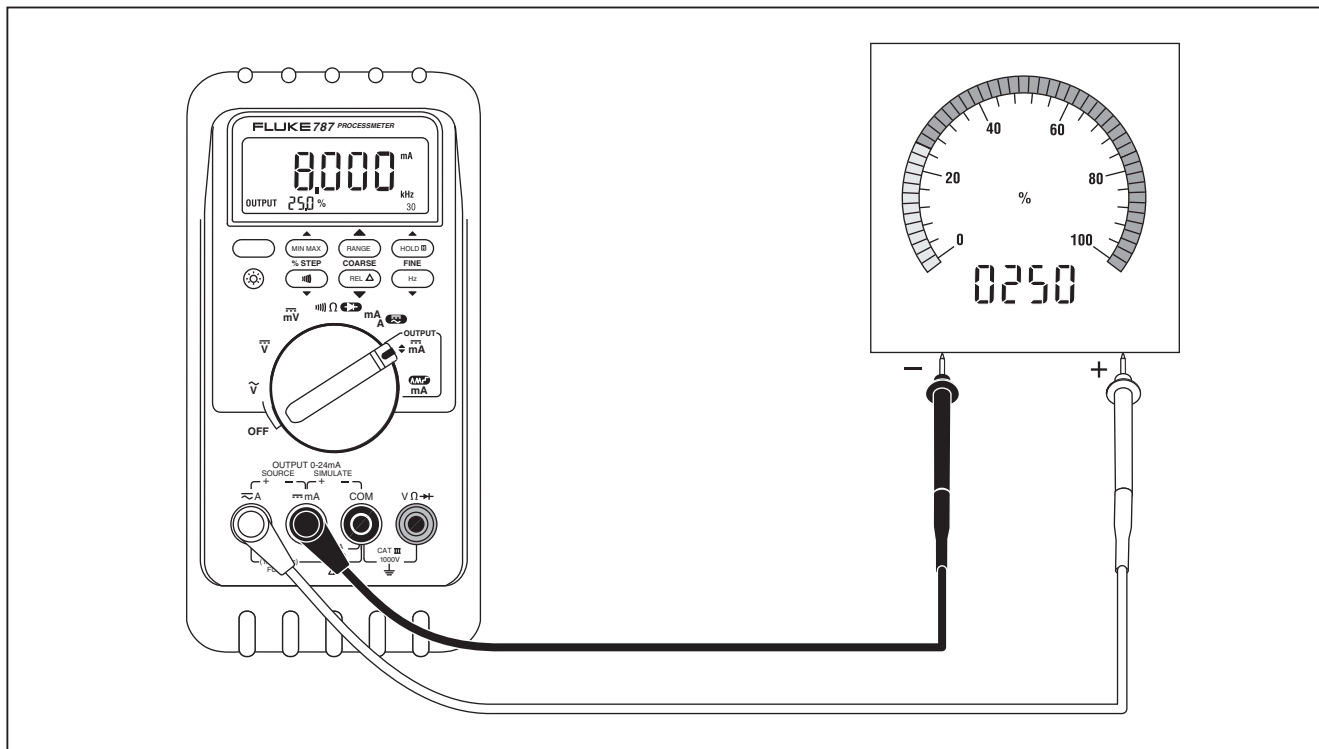

Figure 7. Sourcing Current

ee010f.eps

Simulate Mode

Simulate mode is so named because the Meter simulates a current loop transmitter. Use simulate mode when an external dc voltage of 24 to 30V is in series with the current loop under test.

Caution

Set the rotary switch to one of the mA output settings BEFORE you connect the test leads to a current loop. Otherwise, a low impedance from the other rotary switch positions could be presented to the loop, causing up to 50 mA to flow in the loop.

Simulate mode is selected automatically by inserting the test leads into the SIMULATE + and – jacks as shown in Figure 8. Simulate mode conserves battery life, so use it instead of source mode whenever possible.

The display looks the same in source and simulate modes. The way to tell which mode is in use is to see which pair of output jacks is in use.



Changing the Current Span

The Meter's current output span has two settings (with overrange to 24 mA):

- 4 mA = 0%, 20 mA = 100% (factory default)
- 0 mA = 0%, 20 mA = 100%

To find out which span is selected, short the OUTPUT SOURCE + and – jacks, turn the rotary switch to OUTPUT  mA, and observe the 0% output level.

To toggle and save the current output span in nonvolatile memory (retained when the power is turned off):

1. Turn off the Meter.
2. Hold down the  pushbutton while you turn the rotary switch to OUTPUT  mA.
3. Wait at least 2 seconds, then release .

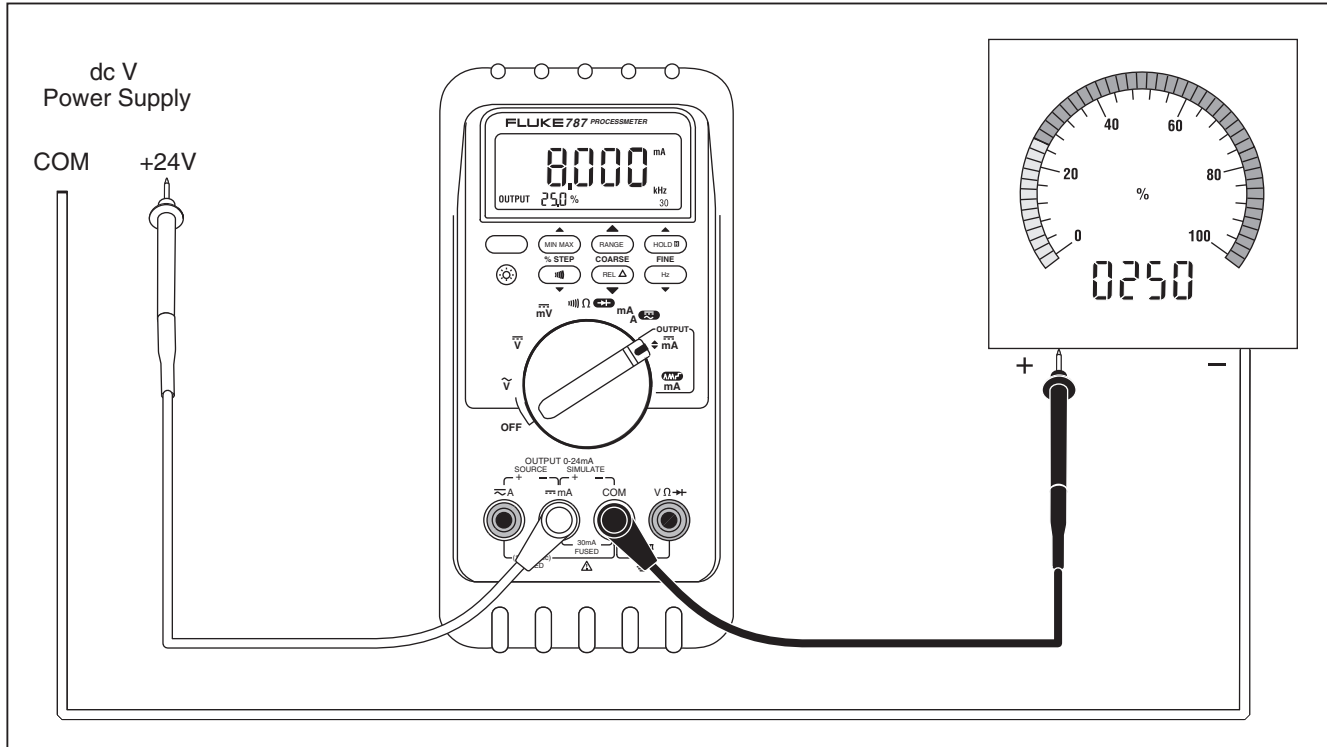

Figure 8. Simulating a Transmitter

ee011f.eps

Producing a Steady mA Output

When the rotary switch is in the OUTPUT \blacklozenge mA position, and the OUTPUT jacks are connected to an appropriate load, the Meter produces a steady mA dc output. The Meter begins sourcing or simulating 0%. Use the pushbuttons to adjust the current as shown in Table 8.

Select either sourcing or simulating by choosing the SOURCE or SIMULATE output jacks.

If the Meter cannot deliver the programmed current because the load resistance is too high or the loop supply voltage is too low, dashes (-----) appear on the numeric display. When the impedance between the SOURCE jacks is low enough, the Meter will resume sourcing.

Note

The STEP pushbuttons described on the next page are available when the Meter is producing a steady mA output. The STEP pushbuttons go to the next multiple of 25 %.

Table 8. mA Output Adjust Pushbuttons

Pushbutton	Adjustment
▲ RANGE COARSE	Adjusts up 0.1 mA
▲ HOLD \square FINE	Adjusts up 0.001 mA
FINE Hz ▼	Adjusts down 0.001 mA
COARSE REL Δ ▼	Adjusts down 0.1 mA

Manually Stepping the mA Output

When the rotary switch is in the OUTPUT \blacklozenge mA position, and the OUTPUT jacks are connected to an appropriate load, the Meter produces a steady mA dc output. The Meter begins sourcing or simulating 0 %. Use the pushbuttons to step the current up and down in 25 % steps as shown in Table 9. See Table 10 for mA values at each 25 % step.

Select either sourcing or simulating by choosing the SOURCE or SIMULATE output jacks.

If the Meter cannot deliver the programmed current because the load resistance is too high or the loop supply voltage is too low, dashes (----) appear on the numeric display. When the impedance between the SOURCE jacks is low enough, the Meter will resume sourcing.

Note

The COARSE and FINE adjustment pushbuttons described on the previous page are available when you are manually stepping the mA output.

Table 9. mA Stepping Pushbuttons



Pushbutton	Adjustment
	Adjusts up to the next higher 25 % step
	Adjusts down to the next lower 25 % step



Table 10. mA Step Values

Step	Value (for each span setting)	
	4 to 20 mA	0 to 20 mA
0 %	4.000 mA	0.000 mA
25 %	8.000 mA	5.000 mA
50 %	12.000 mA	10.000 mA
75 %	16.000 mA	15.000 mA
100 %	20.000 mA	20.000 mA
125 %	24.000 mA	
120 %		24.000 mA

Auto Ramping the mA Output

Auto ramping gives you the ability to continuously apply a varying current stimulus from the Meter to a transmitter, while your hands remain free to test the response of the transmitter. Select either sourcing or simulating by choosing the SOURCE or SIMULATE jacks.

When the rotary switch is in the OUTPUT mA  position, the Meter produces a continuously repeating 0 % - 100 % - 0 % ramp in your choice of three ramp waveforms:

-  0 % - 100 % - 0 % 40-second smooth ramp, (default)
-  0 % - 100 % - 0 % 15-second smooth ramp
-  0 % - 100 % - 0 % Stair-step ramp in 25 % steps, pausing 5 seconds at each step. Steps are listed in Table 10.

The ramp times are not adjustable. Press the BLUE pushbutton to cycle through the three waveforms.

Note

At any time during auto ramping, you can freeze the ramp simply by moving the rotary switch to the  mA position. Then you can use the COARSE, FINE, and % STEP adjust pushbuttons to make adjustments.



Power-Up Options

To select a power-up option, hold down the pushbutton shown in Table 11 while turning the rotary switch from OFF to any on position. Wait 2 seconds before you release the pushbutton after powering up the Meter. The Meter beeps to acknowledge the power-up option.

Only the setting for current span is retained when the power is turned off. The others have to be repeated for each operating session.

You may activate more than one power-up option by holding down more than one pushbutton.

Table 11. Power-Up Options

Option	Pushbutton	Default	Action Taken
Change current span 0 % setting		Remembers last setting	Toggles between 0 and 4 mA
Disable beeper		Enabled	Disables beeper
Disable auto power-off	BLUE	Enabled	Disables the feature that turns off the Meter power after 30 minutes of inactivity. Auto power off is disabled regardless of this option if MIN MAX recording is on.

Battery Life

Warning

To avoid false readings, which could lead to possible electric shock or personal injury, replace the battery as soon as the battery indicator () appears.

Table 12 shows typical alkaline battery life. To preserve battery life:

- Use current simulation instead of sourcing when possible.
- Avoid using the backlight.
- Do not disable the automatic power-off feature.
- Turn the Meter off when you are not using it.

Table 12. Typical Alkaline Battery Life

Meter Operation	Hours
Measuring any parameter or simulating current	80
Sourcing 12 mA into 500Ω	12

Using the Holster

The Meter is supplied with a snap-on holster that absorbs shocks and protects the Meter from rough handling. You can turn the Meter over in the holster to protect the face of the meter from scratches when carrying the Meter.

Caution

For best mechanical performance, the Product must remain in the holster at all times.

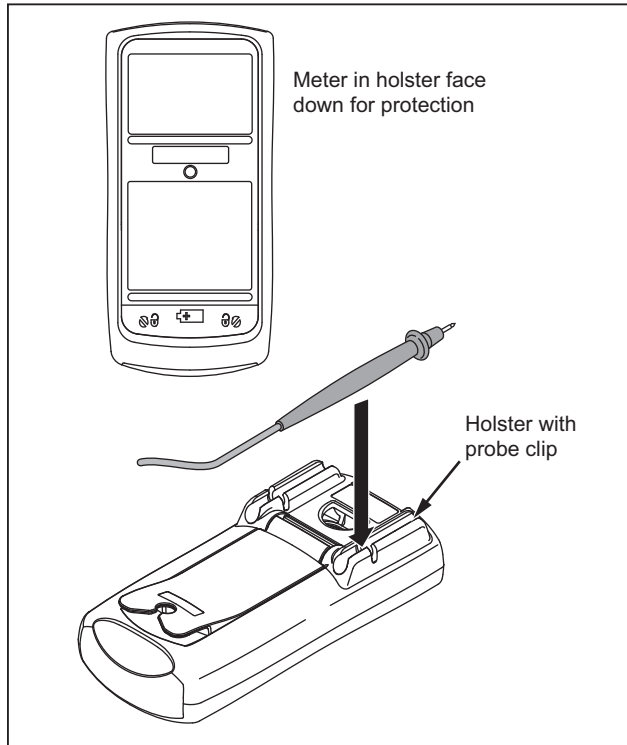

ee009f.eps

Figure 9. Using the Holster

Maintenance

This section provides some basic maintenance procedures. Repair, calibration, servicing not covered in this manual must be performed by qualified personnel. For maintenance procedures not described in this manual, contact a Fluke Service Center.

General Maintenance

Periodically wipe the case with a damp cloth and detergent; do not use abrasives or solvents.

Calibration

Calibrate your Meter once a year to ensure that it performs according to its specifications. Contact a Fluke Service Center for instructions.

Replacing the Battery

⚠ ⚠ Warning

To prevent possible electrical shock, fire, or personal injury:

- Remove test leads from the Meter before opening the battery door.
- Make sure the battery door is closed and latched before operating the Meter.

Remove test leads from the Meter before you open the battery door.

Replace the battery as follows. Refer to Figure 10. Use an alkaline 9 V battery.

1. Remove the test leads and set the rotary switch to OFF.
2. With a standard blade hand screwdriver, turn each battery door screw counterclockwise so that the slot is parallel with the screw picture molded into the case.
3. Lift off the battery door.

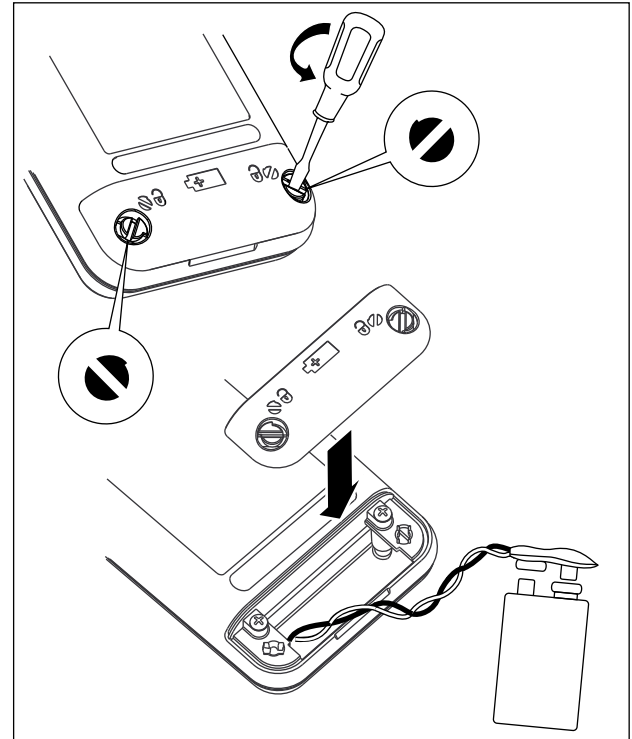

Figure 10. Replacing the Battery



ee007f.eps

Replacing a Fuse

Warning

To avoid personal injury or damage to the Meter, use only the specified replacement fuse, 440 mA 1000V fast-blow, Fluke PN 943121.

Both current input jacks are fused with a separate 440 mA fuse. To determine if a fuse is blown:

1. Turn the rotary switch to mA A .
2. Plug the black test lead into COM, and the red test lead into  A.
3. Using an ohmmeter, check the resistance between the meter test leads. If the resistance is about 1Ω , the fuse is good. An open means the fuse is blown.
4. Move red test lead to  mA.
5. Using an ohmmeter, check the resistance between the meter test leads. If the resistance is about 14Ω , the fuse is good. An open means the fuse is blown.

If a fuse is blown, replace it as follows. Refer to Figure 11 as necessary:

1. Remove the test leads from the Meter and turn the rotary switch to OFF.
2. Remove the battery door.
3. Remove the three Hexalobular (star) screws from the case bottom and turn the case over.
4. Gently lift the bottom of the front of the case (nearest the input/output jacks) until the top unsnaps from the rear half of the case.
5. Replace the blown fuse with the exact type specified: 440 mA 1000V fast-blow fuse, Fluke PN 943121. Both fuses are the same type.
6. Make sure the rotary switch is in the OFF position.
7. Fit the top of case together, engaging the two snaps (item ①). Make sure that the gasket is properly seated.
8. Close the case and reinstall the three screws.
9. Replace the battery door.

If the Meter does not Work

- Examine the case for physical damage. If there is damage, make no further attempt to use the Meter, and contact a Fluke Service Center.
- Check the battery, fuses, and test leads.
- Review this manual to make sure you are using the correct jacks and rotary switch position.

If the Meter still does not work, contact a Fluke Service Center. If the Meter is under warranty, it will be repaired or replaced (at Fluke's option) and returned at no charge. See the Warranty on the back of the title page for terms. If the warranty has lapsed, the Meter will be repaired and returned for a fixed fee. Contact a Fluke Service Center for information and price.

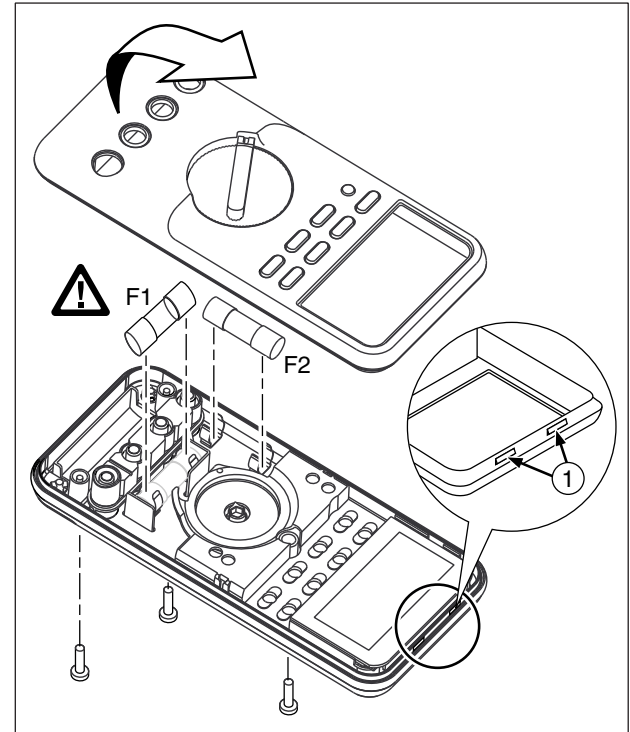

ee012f.eps

Figure 11. Replacing a Fuse

Replacement Parts and Accessories

Warning

To avoid personal injury or damage to the Meter, use only the specified replacement fuse, 440 mA 1000V fast-blow, Fluke PN 943121.

Note

When servicing the Meter, use only the replacement parts specified here.

Replacement parts and some accessories are shown in Figure 12 and listed in Table 13. Many more DMM accessories are available from Fluke. For a catalog, contact your nearest Fluke distributor.

To find out how to order parts or accessories use the telephone numbers or addresses shown on page 1 of this manual.

Table 13. Replacement Parts

Item	Description	Fluke PN or Model no.	Quantity
BT1	9 V battery, IEC 6LR61	614487	1
MP103	Holster, Yellow	2074033	1
△ F1, 2	Fuse, 440 mA, 1000V fast-blow	943121	2
MP85	Case top	619962	1
MP86	Case bottom	619939	1
H2, 3, 4	Case screw	832246	3
MP89, 90	Non-skid foot	824466	2
MP8	O-ring for input/output receptacle	831933	1
MP92	Battery door	619947	1
H5, 6	Battery door fasteners	948609	2
S1	Keypad	646932	1
Not shown	Test Leads	variable ^[1]	1 (set of 2)
Not shown	Alligator Clips	variable ^[1]	1 (set of 2)
Not shown	Industrial test lead set	variable ^[1]	Option
Not shown	Quick Reference Guide	4276679	1
Not shown	Users Manual	See Fluke website	-
Not shown	Calibration Manual	See Fluke website	-
[1] See www.fluke.com for more information about the test leads and alligator clips available for your region.			

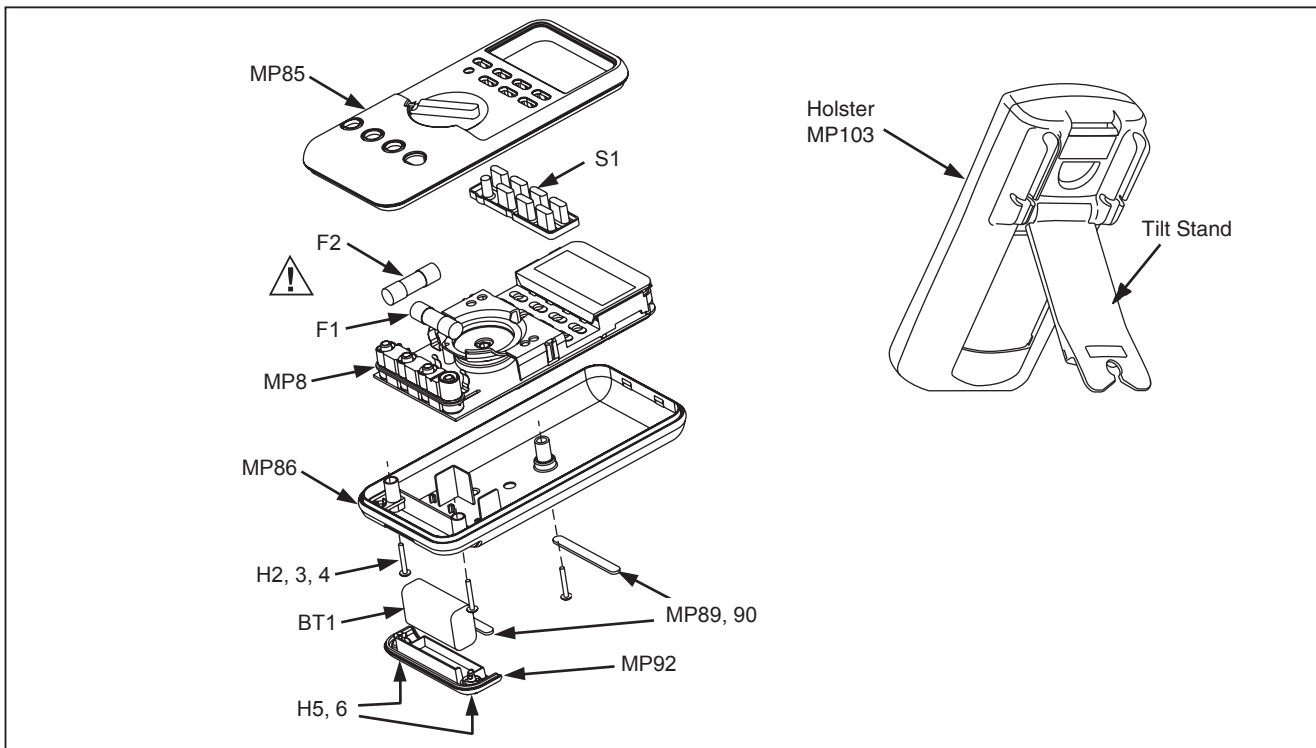

Figure 12. Replacement Parts

ee015c.eps

Specifications

All specifications apply from +18°C to +28°C unless stated otherwise.

All specifications assume a 5 minute warmup period.

The standard specification interval is 1 year.

Note

“Counts” means number of increments or decrements of the least significant digit.

DC Volts Measurement

Range (V dc)	Resolution	Accuracy, \pm (% of Reading + Counts)
4.000	0.001 V	0.1 % + 1
40.00	0.01 V	0.1 % + 1
400.0	0.1 V	0.1 % + 1
1000	1 V	0.1 % + 1

Input impedance: 10 M Ω (nominal), <100 pF
Normal mode rejection ratio: >60 dB at 50 Hz or 60 Hz
Common mode rejection ratio: >120 dB at dc, 50 Hz, or 60 Hz
Overvoltage protection: 1000V

DC Millivolts Measurement

Range (mV dc)	Resolution	Accuracy (% of Reading + Counts)
400.0	0.1 mV	0.1 % + 1

AC Volts Measurement

Range (ac)	Resolution	Accuracy, \pm (% of Reading + Counts)		
		50 Hz to 60 Hz	45 Hz to 200 Hz	200 Hz to 500 Hz
400.0 mV	0.1 mV	0.7 % + 4	1.2 % + 4	7.0 % + 4
4.000 V	0.001 V	0.7 % + 2	1.2 % + 4	7.0 % + 4
40.00 V	0.01 V	0.7 % + 2	1.2 % + 4	7.0 % + 4
400.0 V	0.1 V	0.7 % + 2	1.2 % + 4	7.0 % + 4
1000 V	1 V	0.7 % + 2	1.2 % + 4	7.0 % + 4

Specifications are valid from 5 % to 100 % of amplitude range.

AC conversion: true rms

Maximum crest factor: 3

For non-sinusoidal waveforms, add \pm (2 % reading + 2 % f.s.) typical

Input impedance: 10 M Ω (nominal), < 100 pF, ac-coupled

Common mode rejection ratio: >60 dB at dc, 50 Hz, or 60 Hz

AC Current Measurement

Range 45 Hz to 2 kHz	Resolution	Accuracy, \pm(% of Reading + Counts)	Typical Burden Voltage
1.000 A (Note)	0.001 A	1 % + 2	1.5 V/A
<i>Note: 440 mA continuous, 1 A 30 seconds maximum on, 5 minutes off</i>			
<i>Specifications are valid from 5 % to 100 % of amplitude range.</i>			
<i>AC conversion: true rms</i>			
<i>Maximum crest factor: 3</i>			
<i>For non-sinusoidal waveforms, add \pm(2 % reading + 2 % f.s.) typical</i>			
<i>Overload protection 440 mA, 1000V fast-blow fuse</i>			

DC Current Measurement

Range	Resolution	Accuracy, \pm(% of Reading + Counts)	Typical Burden Voltage
30.000 mA	0.001 mA	0.05 % + 2	14 mV/mA
1.000 A (Note)	0.001 A	0.2 % + 2	1.5 V/A
<i>Note: 440 mA continuous, 1A 30 seconds maximum on, 5 minutes off</i>			
<i>Overload protection: 440 mA, 1000V fast-blow fuse</i>			

Ohms Measurement

Range	Resolution	Measurement Current	Accuracy, \pm(% of Reading + Counts)
400.0 Ω	0.1 Ω	220 μ A	0.2 % + 2
4.000 k Ω	0.001 k Ω	59 μ A	0.2 % + 1
40.00 k Ω	0.01 k Ω	5.9 μ A	0.2 % + 1
400.0 k Ω	0.1 k Ω	590 nA	0.2 % + 1
4.000 M Ω	0.001 M Ω	220 nA	0.35 % + 3
40.00 M Ω	0.01 M Ω	22 nA	2.5 % + 3
<i>Overload protection: 1000 V</i> <i>Open circuit voltage: <3.9 V</i>			

Frequency Counter Accuracy

Range	Resolution	Accuracy, \pm (% of Reading + Counts)
199.99 Hz	0.01 Hz	0.005 % + 1
1999.9 Hz	0.1 Hz	0.005 % + 1
19.999 kHz	0.001 kHz	0.005 % + 1

Display updates 3 times/second at >10 Hz

Frequency Counter Sensitivity

Input Range	Minimum Sensitivity (rms Sinewave) 5 Hz to 5 kHz*
1 V	0.1 V
4 V	1 V
40 V	3 V
400 V	30 V
1000 V	300 V

* Usable 0.5 Hz to 20 kHz with reduced sensitivity.

Diode Test and Continuity Test

Diode test indication: display voltage drop: 0.2 mA nominal test current at 0.6V: 2.4V full scale, accuracy $\pm(2\% + 1 \text{ count})$

Continuity test indication: continuous audible tone for test resistance $<100 \Omega$

Open circuit voltage: $<3.9 \text{ V}$

Short circuit current: 1.2 mA typical

Overload protection: 1000 V rms

DC Current Output

Source mode:

Span: 0 mA or 4 mA to 20 mA, with overrange to 24 mA

Accuracy: 0.05 % of span

Compliance voltage: 12 V with battery voltage $>8.5 \text{ V}$

Simulate Mode:

Span: 0 mA or 4 mA to 20 mA, with overrange to 24 mA

Accuracy: 0.05 % of span

Loop voltage: 24 V nominal, 30 V maximum, 15 V minimum

Compliance voltage: 21 V for 24 V supply

Burden voltage: $<3 \text{ V}$

General Specifications

Maximum voltage applied between any jack and earth ground	1000 V
Storage temperature	-40 °C to 60 °C
Operating temperature	-20 °C to 55 °C
Operating altitude	2000 meters maximum
Temperature coefficient	0.05 x specified accuracy per °C for temperatures <18 °C or >28 °C
Relative humidity	95 % up to 30 °C, 75 % up to 40 °C, 45 % up to 50 °C, and 35 % up to 55 °C
Vibration	Random Mil-prf-28800f, 10 Hz to 500 Hz
Shock	1 meter drop test
Power requirements	Single 9 V battery (IEC 6LR61)
Size	32 mm H x 87 mm W x 187 mm L (1.25 in H x 3.41 in W x 7.35 in L)
With holster	52 mm H x 98 mm W x 201 mm L (2.06 in H x 3.86 in W x 7.93 in L)
Weight	369 g (13 oz)
With holster	638 g (22.5 oz)

Safety

General IEC 61010-1: Pollution Degree 2

Measurement IEC 61010-2-033: CAT III 1000 V

Electromagnetic Compatibility (EMC) Accuracy for all ProcessMeter functions is not specified in RF field >3 V/m

International IEC 61326-1: Portable Electromagnetic Environment; IEC 61326-2-2
CISPR 11: Group 1, Class A

Group 1: Equipment has intentionally generated and/or use conductively coupled radio-frequency energy that is necessary for the internal functioning of the equipment itself.

Class A: Equipment is suitable for use in all establishments other than domestic and those directly connected to a low-voltage power supply network that supplies buildings used for domestic purposes. There may be potential difficulties in ensuring electromagnetic compatibility in other environments, due to conducted and radiated disturbances.

Caution: This equipment is not intended for use in residential environments and may not provide adequate protection to radio reception in such environments.

Korea (KCC)..... Class A Equipment (Industrial Broadcasting & Communication Equipment)

Class A: Equipment meets requirements for industrial electromagnetic wave equipment and the seller or user should take notice of it. This equipment is intended for use in business environments and not to be used in homes.

USA (FCC) 47 CFR 15 subpart B. This product is considered an exempt device per clause 15.103.

FLUKE®

787

ProcessMeter™

Users Manual

April 1997 Rev. 5, 7/17

© 1997-2017 Fluke Corporation. All rights reserved. Specifications are subject to change without notice.
All product names are trademarks of their respective companies.

LIMITED WARRANTY AND LIMITATION OF LIABILITY

This Fluke product will be free from defects in material and workmanship for three years from the date of purchase. This warranty does not cover fuses, disposable batteries, or damage from accident, neglect, misuse, alteration, contamination, or abnormal conditions of operation or handling. Resellers are not authorized to extend any other warranty on Fluke's behalf. To obtain service during the warranty period, contact your nearest Fluke authorized service center to obtain return authorization information, then send the product to that Service Center with a description of the problem.

THIS WARRANTY IS YOUR ONLY REMEDY. NO OTHER WARRANTIES, SUCH AS FITNESS FOR A PARTICULAR PURPOSE, ARE EXPRESSED OR IMPLIED. FLUKE IS NOT LIABLE FOR ANY SPECIAL, INDIRECT, INCIDENTAL OR CONSEQUENTIAL DAMAGES OR LOSSES, ARISING FROM ANY CAUSE OR THEORY. Since some states or countries do not allow the exclusion or limitation of an implied warranty or of incidental or consequential damages, this limitation of liability may not apply to you.

Fluke Corporation
P.O. Box 9090
Everett, WA 98206-9090
U.S.A.

Fluke Europe B.V.
P.O. Box 1186
5602 BD Eindhoven
The Netherlands

Table of Contents

Title	Page
Introduction	1
Contacting Fluke	1
Safety Information	2
How to Get Started	6
Getting Acquainted with the Meter	7
Measuring Electrical Parameters.....	18
Input Impedance.....	18
Ranges	18
Measuring a Composite Signal.....	18
Testing Diodes.....	19
Displaying Minimum, Maximum, and Average.....	19
Using TouchHold	20
Compensating for Test Lead Resistance.....	20
Using the Current Output Functions	21
Source Mode	21
Simulate Mode.....	23
Changing the Current Span	23
Producing a Steady mA Output	25

Manually Stepping the mA Output	26
Auto Ramping the mA Output	27
Power-Up Options	28
Battery Life.....	29
Using the Holster	29
Maintenance	30
General Maintenance.....	30
Calibration.....	30
Replacing the Battery.....	30
Replacing a Fuse	32
If the Meter does not Work.....	33
Replacement Parts and Accessories	34
Specifications.....	37

List of Tables

Table	Title	Page
1.	Symbols.....	5
2.	Input/Output Jacks.....	8
3.	Rotary Switch Positions for Measurements.....	10
4.	Rotary Knob Positions for mA Output.....	12
5.	Pushbuttons.....	13
6.	Display.....	16
7.	Range Requirements for Measuring a Composite Signal.....	18
8.	Steady mA Output Adjustment.....	25
9.	Steady mA Output Adjustment.....	26
10.	mA Step Values.....	27
11.	Power-Up Options.....	28
12.	Typical Alkaline Battery Life.....	29
13.	Replacement Parts.....	35

List of Figures

Figure	Title	Page
1.	Fluke 787 ProcessMeter.....	6
2.	Input/Output Jacks.....	7
3.	Rotary Switch Positions for Measurements.....	9
4.	Rotary Switch Positions for mA Output.....	11
5.	Pushbuttons.....	13
6.	Elements of the Display.....	15
7.	Sourcing Current.....	22
8.	Simulating a Transmitter.....	24
9.	Using the Holster.....	30
10.	Replacing the Battery.....	31
11.	Replacing a Fuse.....	33
12.	Replacement Parts.....	36

Introduction

⚠ Warning

Read “Safety Information” before you use the Meter.

Your Fluke 787 ProcessMeter™ (referred to as “the Product or Meter”) is a handheld, battery-operated tool for measuring electrical parameters and supplying steady or ramping current to test process instruments. It has all the features of a digital multimeter, plus current output capability.

If the Meter is damaged or something is missing, contact the place of purchase immediately.

Contact your Fluke distributor for information about DMM accessories. To order replacement parts or spares, see Table 13 near the end of this manual.

Contacting Fluke

To contact Fluke, call one of the following telephone numbers:

- Technical Support USA: 1-800-44-FLUKE (1-800-443-5853)
- Calibration/Repair USA: 1-888-99-FLUKE (1-888-993-5853)
- Canada: 1-800-36-FLUKE (1-800-363-5853)
- Europe: +31 402-675-200
- Japan: +81-3-6714-3114
- Singapore: +65-6799-5566
- China: +86-400-921-0835
- Anywhere in the world: +1-425-446-5500

Or, visit Fluke's website at www.fluke.com.

To register your product, visit <http://register.fluke.com>.

To view, print, or download the latest manual supplement, visit <http://us.fluke.com/usen/support/manuals>.

Safety Information

The symbols used on the Product and in this manual are shown in Table 1.

A **Warning** identifies conditions and procedures that are dangerous to the user. A **Caution** identifies conditions and procedures that can cause damage to the Product or the equipment under test.

Warning

To prevent possible electrical shock, fire, or personal injury:

- Read “Safety Information” before using the Product.
- Do not use the Meter if it is damaged. Before you use the Meter, inspect the case. Look for cracks or missing plastic. Pay particular attention to the insulation surrounding the connectors.

- Make sure the battery door is closed and latched before operating the Meter.
- Remove test leads from the Meter before opening the battery door.
- Inspect the test leads for damaged insulation or exposed metal. Check test lead continuity. Replace damaged test leads before you use the Meter.
- Measure a known voltage first to make sure that the Meter operates correctly. If you are unsure, have the Meter examined.
- Do not operate the Meter around explosive gas, vapor, or dust. Do not use in a damp or wet environment.
- Use only a single 9 V battery, properly installed in the meter case, to power the Meter.
- When servicing the Meter, use only specified replacement parts.
- Before a current measurement, do the fuse test.
- Use the correct terminals, function, and range for measurements.
- Do not work alone.

- For current measurements, connect the Meter to the circuit after you remove circuit power. Always put the Meter in series with the circuit.
- Comply with local and national safety requirements when in hazardous locations.
- Only use test leads that have the same voltage, category, and amperage ratings as the Meter and that are approved by a safety agency. When used with optional accessories, the lowest category rating applies.
- Do not use TouchHold to determine if dangerous voltage is present. TouchHold will not capture unstable or noisy readings.
- To avoid false readings, which could lead to possible electric shock or personal injury, replace the battery as soon as the battery indicator (🔋) appears.
- Remove test leads from the Meter before you open the battery door.
- Close and latch the battery door before using the Meter.
- To avoid personal injury or damage to the Meter, use only the specified replacement fuse, 440 mA 1000 V fast-blow, Fluke PN 943121.
- Do not exceed the Measurement Category (CAT) rating of the lowest rated individual component of a Product, probe, or accessory.
- Do not use the TL175 or TP175 test probes in CAT III or CAT IV environments without the probe tip fully extended and correct category rating visible in the window.
- When the TL175 is used with instruments or other accessories, the lowest category rating of the combination applies. One exception is when the probe is used with the AC172 or AC175.

⚠ Caution

To prevent possible damage to Product or to equipment under test:















- Disconnect the power and discharge all high-voltage capacitors before testing resistance or continuity.

- **Use the proper jacks, function, and range for your measurement or sourcing application.**
- **For best mechanical performance, the Product must remain in the holster at all times.**

To protect yourself, adhere to the following guidelines:

- Use caution when working above 30 V ac rms, 42 V ac pk, or 60 V dc. Such voltages pose a shock hazard.
- When using the probes, keep your fingers behind the finger guards on the probes.
- Connect the common test lead before you connect the live test lead. When you disconnect test leads, disconnect the live test lead first.

Table 1. Symbols

Symbol	Meaning	Symbol	Meaning
	WARNING. HAZARDOUS VOLTAGE. Risk of electric shock.		Fuse
	WARNING. RISK OF DANGER.		Double Insulated
	Consult user documentation		Conforms to relevant Australian EMC standards.
	AC (Alternating Current)		Battery
	DC (Direct Current)		Earth
	Alternating or direct current		Conforms to relevant South Korean EMC Standards.
	Conforms to relevant North American Safety Standards.		
CAT II	Measurement Category II is applicable to test and measuring circuits connected directly to utilization points (socket outlets and similar points) of the low-voltage MAINS installation.		
CAT III	Measurement Category III is applicable to test and measuring circuits connected to the distribution part of the building's low-voltage MAINS installation.		
CAT IV	Measurement Category IV is applicable to test and measuring circuits connected at the source of the building's low-voltage MAINS installation.		
	This product complies with the WEEE Directive marking requirements. The affixed label indicates that you must not discard this electrical/electronic product in domestic household waste. Product Category: With reference to the equipment types in the WEEE Directive Annex I, this product is classed as category 9 "Monitoring and Control Instrumentation" product. Do not dispose of this product as unsorted municipal waste.		

How to Get Started

If you are familiar with the Fluke 80 Series DMM, read “Using the Current Output Functions,” review the tables and figures in “Getting Acquainted with the Meter,” and begin using your Meter.

If you are unfamiliar with Fluke 80 Series DMMs, or DMMs in general, read “Measuring Electrical Parameters” in addition to the sections referenced in the previous paragraph.

The sections following “Using the Current Output Functions” contain information about the power-up options, and battery and fuse replacement instructions.

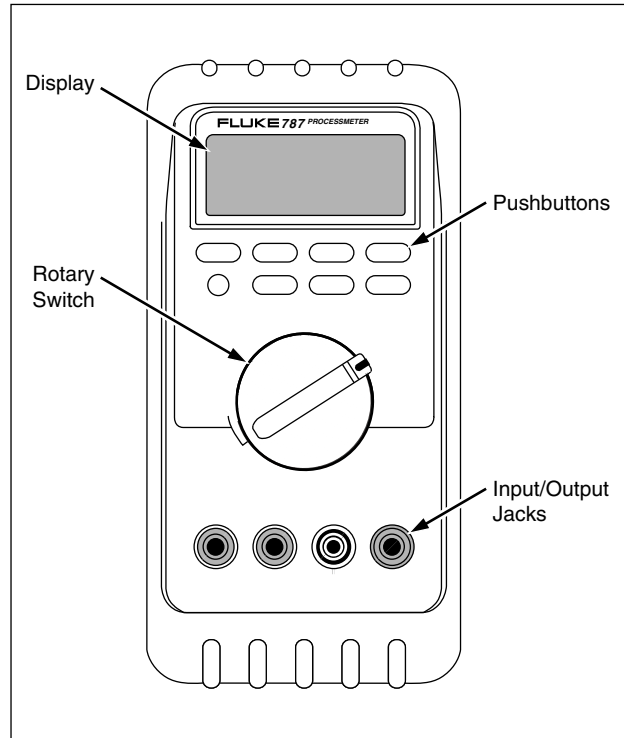

ee014f.eps

Figure 1. Fluke 787 ProcessMeter

Getting Acquainted with the Meter

To become familiar with the features and functions of the Meter, study the following figures and tables.

- Figure 2 and Table 2 describe the input/output jacks.
- Figure 3 and Table 3 describe the input functions you get with the first five rotary switch positions.
- Figure 4 and Table 4 describe the output functions you get with the last two rotary switch positions.
- Figure 5 and Table 5 describe the functions of the pushbuttons.
- Figure 6 and Table 6 explain what all the elements of the display indicate.

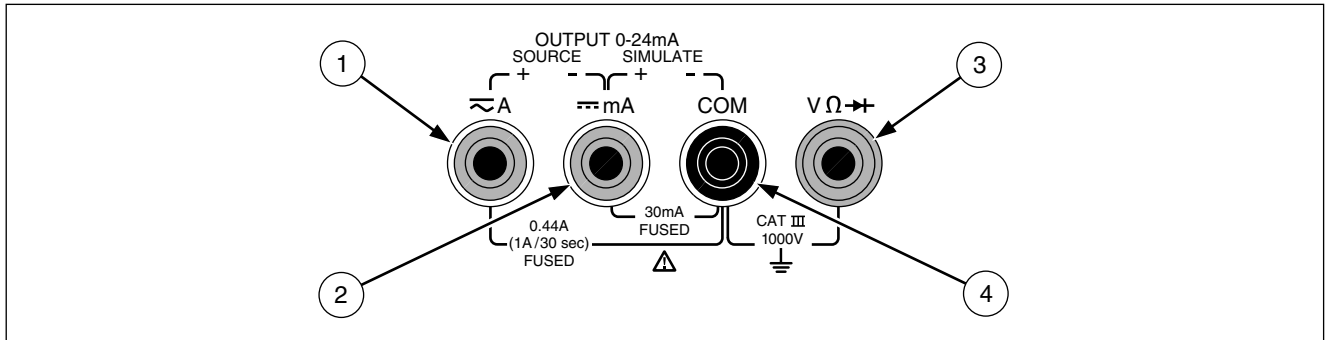





Figure 2. Input/Output Jacks

ee001f.eps

Table 2. Input/Output Jacks

Item	Jack	Measurement Functions	Source Current Function	Simulate Transmitter Function
①	 A	Input for current to 440 mA continuous. (1A for up to 30 seconds.) Fused with a 440 mA fuse.	Output for dc current to 24 mA.	
②	 mA	Input for current to 30 mA. Fused with a 440 mA fuse.	Common for dc current output to 24 mA.	Output for transmitter simulation to 24 mA. (Use in series with an external loop supply.)
③	V Ω 	Input for voltage to 1000V, Ω , continuity, and diode test.		
④	COM	Common for all measurements.		Common for transmitter simulation to 24 mA. (Use in series with an external loop supply.)

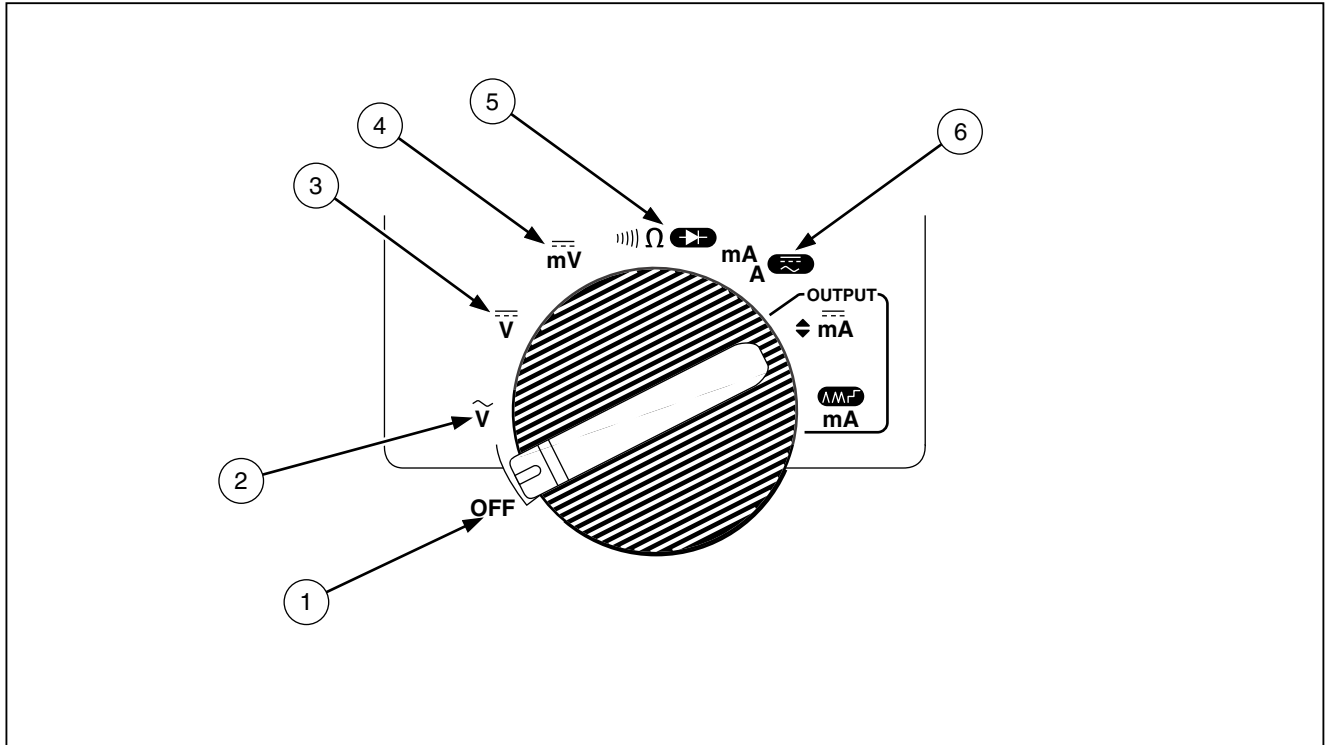













Figure 3. Rotary Switch Positions for Measurements

ee002f.eps

Table 3. Rotary Switch Positions for Measurements

No.	Position	Function(s)	Pushbutton Actions
①	OFF	Meter off	
②	V ~	Default: measure ac V  Hz Frequency counter	 Selects a MIN, MAX, or AVG action (see pg. 18)  Selects a fixed range (hold 1 second for auto range)  Toggles TouchHold  Toggles relative reading (sets a relative zero point)
③	== V	Measure dc V	Same as above
④	== mV	Measure dc mV	Same as above
⑤	 Ω 	Default: measure Ω  for continuity BLUE  test	Same as above, except diode test has only one range
⑥	mA A 	<i>High test lead in</i>  A: measure A dc BLUE selects ac <i>High test lead in</i> == mA: measure mA dc	Same as above, except there is only one range for each input jack position, 30 mA or 1A

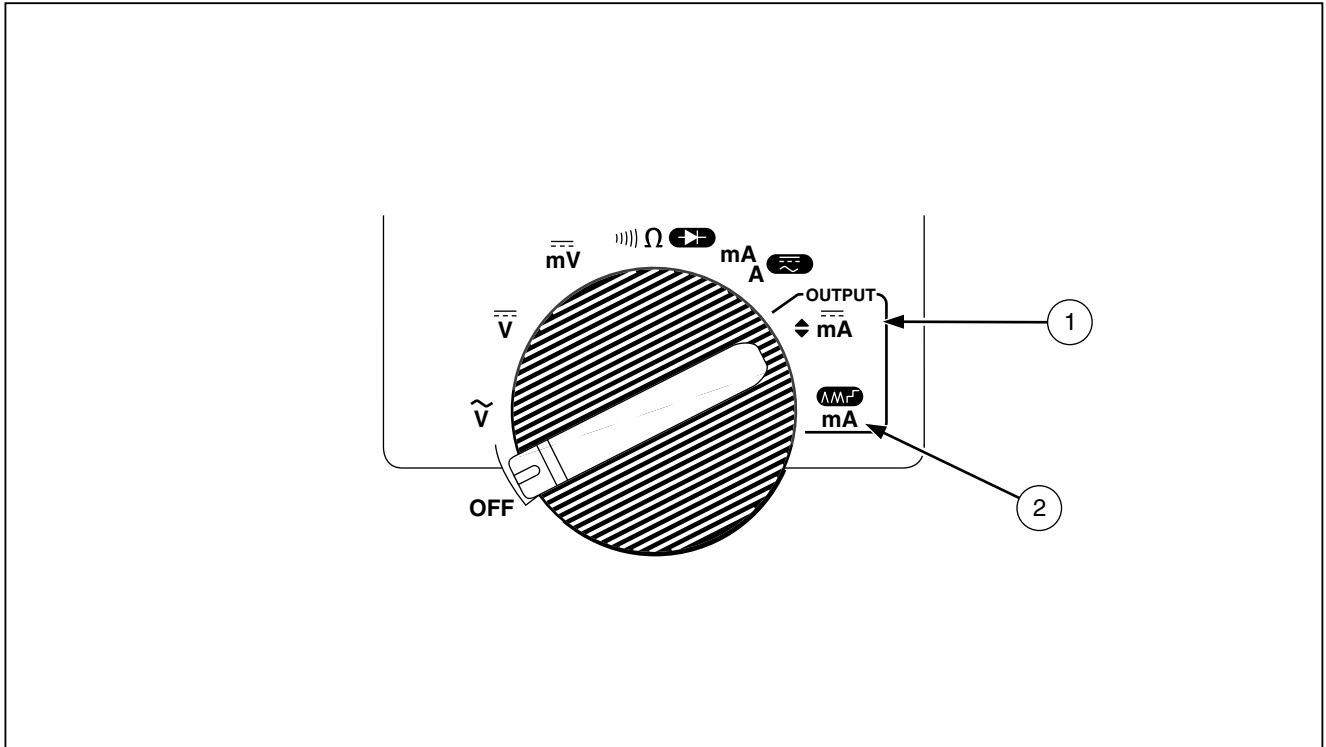

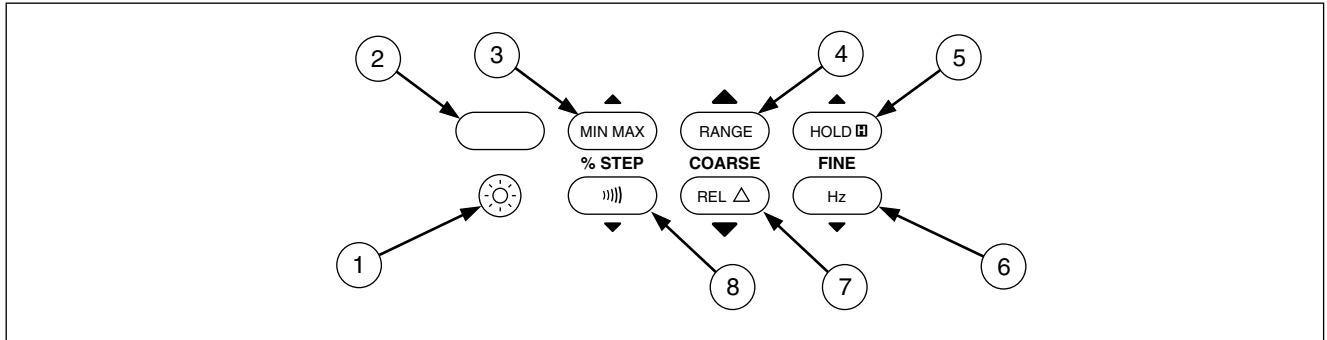

Figure 4. Rotary Switch Positions for mA Output

ee008.eps

Table 4. Rotary Switch Positions for mA Output

No.	Position	Default Function	Pushbutton Actions
①	OUTPUT ◆ mA	<i>Test leads in SOURCE:</i> Source 0 % mA <i>Test leads in SIMULATE:</i> Sink 0 % mA	% STEP ▲ or ▼: Adjusts output up or down to the next 25 % step COARSE ▲ or ▼: Adjusts output up or down 0.1 mA FINE ▲ or ▼: Adjusts output up or down 0.001 mA
②	OUTPUT mA 	<i>Test leads in SOURCE:</i> Source repeating 0 % -100 %-0 % slow ramp (∧) <i>Test leads in SIMULATE:</i> Sink repeating 0 % -100 %-0 % slow ramp (∧)	BLUE cycles through: <ul style="list-style-type: none"> • Fast repeating 0 % -100 % - 0 % ramp (∧ on display) • Repeating 0 % -100 % - 0 % ramp in 25 % steps (□ on display) • Slow repeating 0 % -100 % - 0 % ramp (∧ on display)



ee003f.eps

Figure 5. Pushbuttons

Table 5. Pushbuttons













No.	Pushbutton	Function(s)
①		Toggles the backlight
②	 (BLUE)	Rotary switch in mA A  position and test lead plugged into  A jack: Toggles between ac and dc ampere measure Rotary switch in Ω  position: Selects diode test function () Rotary switch in OUTPUT mA  position: Cycles through <ul style="list-style-type: none"> • Slow repeating 0 % -100 % - 0 % ramp ( on display) • Fast repeating 0 % -100 % - 0 % ramp ( on display) • Repeating 0 % -100 % - 0 % ramp in 25 % steps ( on display)

Table 5. Pushbuttons (cont.)

No.	Pushbutton	Function(s)
③	▲ (MIN MAX) % STEP	<i>Measuring:</i> Selects a MIN, MAX, or AVG action (see pg. 18) <i>mA Output:</i> Adjusts mA output up to the next higher 25% step
④	▲ (RANGE) COARSE	<i>Measuring:</i> Selects a fixed range (hold for 1 second for auto range) <i>mA Output:</i> Adjusts output up 0.1 mA
⑤	▲ (HOLD)  FINE	<i>Measuring:</i> Toggles TouchHold, or in MIN MAX recording, suspends recording <i>mA Output:</i> Adjusts output up 0.001 mA
⑥	FINE (Hz) ▼	<i>Measuring:</i> Toggles between frequency counter and ac voltage measurement functions <i>mA Output:</i> Adjusts output down 0.001 mA
⑦	COARSE (REL)  ▼	<i>Measuring:</i> Toggles relative reading (sets a relative zero point) <i>mA Output:</i> Adjusts output down 0.1 mA
⑧	% STEP ()))  ▼	<i>Measuring:</i> Toggles between Ω measure and continuity functions <i>mA Output:</i> Adjusts mA output down to the next lower 25 % step

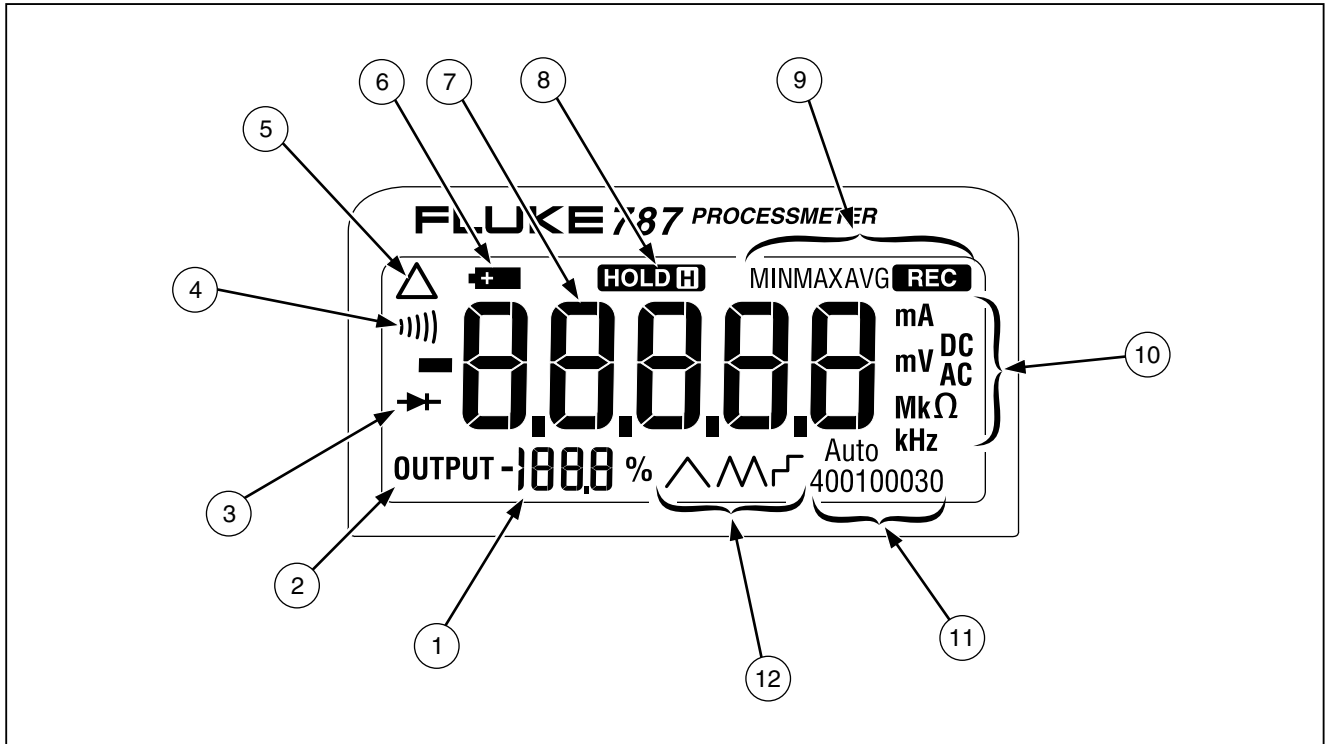

Figure 6. Elements of the Display

ee004f.eps

Table 6. Display







No.	Element	Meaning
①	Percentage display	Shows the mA measured value or output level in %, in a 0-20 mA or 4-20 mA scale (change scales with power-up option)
②	OUTPUT	Lights when mA output (source or simulate) is active
③		Lights in diode test function
④		Lights in continuity function
⑤		Lights when relative reading is on
⑥		Lights when the battery is low
⑦	Numerals	Show the input or output value
⑧		Lights when TouchHold is on
⑨	MINMAXAVG 	<p>MIN MAX recording status indicators:</p> <p>MIN means the display is showing the minimum recorded value.</p> <p>MAX means the display is showing the maximum recorded value.</p> <p>AVG means the display is showing the average value since starting recording (up to about 35 hours continuous recording time).</p> <p> means MIN MAX recording is on.</p>

Table 6. Display (cont.)

No.	Element	Meaning
⑩	mA, DC, mV, AC, M or kΩ, kHz	Show the input or output units and multipliers associated with the numerals
⑪	Auto 400100030	Range status indicators: Auto means autoranging is on. The number plus the unit and multiplier indicate the active range.
⑫	∧ ∞ ⌐	One of these lights in mA ramping or step output (rotary switch position mA ∧∞⌐): ∧ means slow continuous 0% - 100% - 0% ramping. ∞ means fast continuous 0% - 100% - 0% ramping. ⌐ means ramping in 25% steps.

Measuring Electrical Parameters

The proper sequence for taking measurements is as follows:

1. Plug the test leads into the appropriate jacks.
2. Set the rotary knob.
3. Touch the probes to the test points.

Input Impedance

For the voltage measurement functions, input impedance is 10 M Ω . See the specifications for more information.

Ranges

A measurement range determines the highest value the Meter can measure. Most meter measurement functions have more than one range (see the Specifications).

Being in the right range is important:

- If the range is too low, the display shows **OL** (overload).
- If the range is too high, the Meter will not be displaying its most accurate measurement.

The Meter normally automatically selects the lowest range that will measure the applied input signal (Auto showing on the display). Press **RANGE** if you want to lock the

range. Each time you press **RANGE**, the Meter selects the next higher range.

If you have locked the range, the Meter resumes auto ranging when you change to another measurement function or you press **RANGE** and hold it for 1 second.

Measuring a Composite Signal

Because the input is dc-coupled, to measure an ac voltage or frequency with a dc bias, you must manually select the range specified in Table 7. For example, to measure 100 mV ac with 20 V dc superimposed, select the 4 V range.

Table 7. Range Requirements for Measuring a Composite Signal

Range (ac)	Max. Allowable AC + DC
400.0 mV	3 V
4.000 V	30 V
40.00 V	300 V
400.0 V	400 V
1000 V	1000 V

Testing Diodes

To test a single diode:

1. Insert the red test lead into the $V\Omega\rightarrow+$ jack and black test lead into the COM jack.
2. Set the rotary switch to $\Omega\rightarrow+$.
3. Press the BLUE pushbutton so that the $\rightarrow+$ symbol is on the display.
4. Touch the red probe to the anode and the black probe to the cathode (side with band or bands). The Meter should indicate the appropriate diode voltage drop.
5. Reverse the probes. The Meter should display OL, indicating high impedance.
6. The diode is good if it passes the tests in steps 4 and 5.

Displaying Minimum, Maximum, and Average

MIN MAX recording stores the lowest and highest measurements, and maintains the average of all measurements.

Press MIN MAX to turn on MIN MAX recording. Readings are stored until you turn the Meter off, switch to another measurement or source function, or turn MIN MAX off. The beeper sounds when a new maximum or minimum is recorded. Auto power-off is disabled and auto ranging is turned off during MIN MAX recording.

Press MIN MAX again to cycle through the MAX, MIN, and AVG displays. Press and hold MIN MAX for 1 second to erase stored measurements and exit.

If MIN MAX recording is on continuously for over 40 hours, minimum and maximum readings are still recorded, but the displayed average no longer changes.

In MIN MAX recording, press HOLD to suspend recording; press HOLD again to resume recording.

Using TouchHold

Note

You must have MIN MAX recording off to use TouchHold.



Warning

To avoid possible electric shock, do not use TouchHold to determine if dangerous voltage is present. TouchHold will not capture unstable or noisy readings.

Activate TouchHold® if you want the Meter to freeze the display on each new stable reading (except in the frequency counter function). Press  to activate TouchHold. This feature allows you to take measurements in situations in which it is difficult to look at the display. The Meter beeps and updates the display with each new stable reading.

Compensating for Test Lead Resistance

Use the relative reading feature (Δ on the display) to set the present measurement as a relative zero. A common use for this is to compensate for test lead resistance when measuring Ω .

Select the Ω measure function, touch the test leads together, then press . Until you press  again, or switch to another measurement or source function, the readings on the display will subtract the lead resistance.

Using the Current Output Functions

The Meter provides steady, stepped, and ramped current output for testing 0-20 mA and 4-20 mA current loops. You can choose source mode, in which the Meter supplies the current, or simulate mode, in which the Meter regulates current in an externally-powered current loop.

Source Mode

Source mode is selected automatically by inserting the test leads into the SOURCE + and – jacks as shown in Figure 7. Use source mode whenever you need to supply

current into a passive circuit such as a current loop with no loop supply. Source mode depletes the battery faster than simulate mode, so use simulate mode whenever possible.

The display looks the same in source and simulate modes. The way to tell which mode is in use is to see which pair of output jacks is in use.

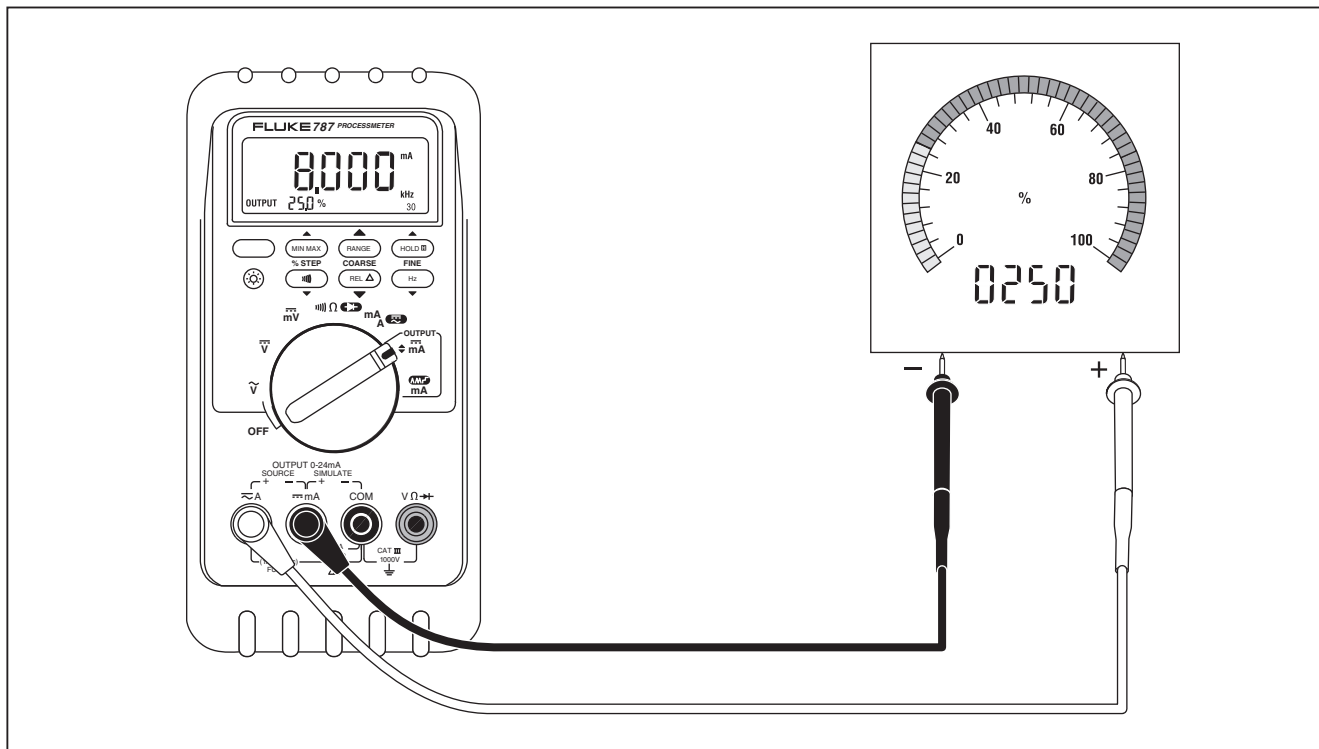

Figure 7. Sourcing Current

ee010f.eps

Simulate Mode

Simulate mode is so named because the Meter simulates a current loop transmitter. Use simulate mode when an external dc voltage of 24 to 30V is in series with the current loop under test.

Caution

Set the rotary switch to one of the mA output settings BEFORE you connect the test leads to a current loop. Otherwise, a low impedance from the other rotary switch positions could be presented to the loop, causing up to 50 mA to flow in the loop.

Simulate mode is selected automatically by inserting the test leads into the SIMULATE + and – jacks as shown in Figure 8. Simulate mode conserves battery life, so use it instead of source mode whenever possible.

The display looks the same in source and simulate modes. The way to tell which mode is in use is to see which pair of output jacks is in use.



Changing the Current Span

The Meter's current output span has two settings (with overrange to 24 mA):

- 4 mA = 0%, 20 mA = 100% (factory default)
- 0 mA = 0%, 20 mA = 100%

To find out which span is selected, short the OUTPUT SOURCE + and – jacks, turn the rotary switch to OUTPUT  mA, and observe the 0% output level.

To toggle and save the current output span in nonvolatile memory (retained when the power is turned off):

1. Turn off the Meter.
2. Hold down the  pushbutton while you turn the rotary switch to OUTPUT  mA.
3. Wait at least 2 seconds, then release .

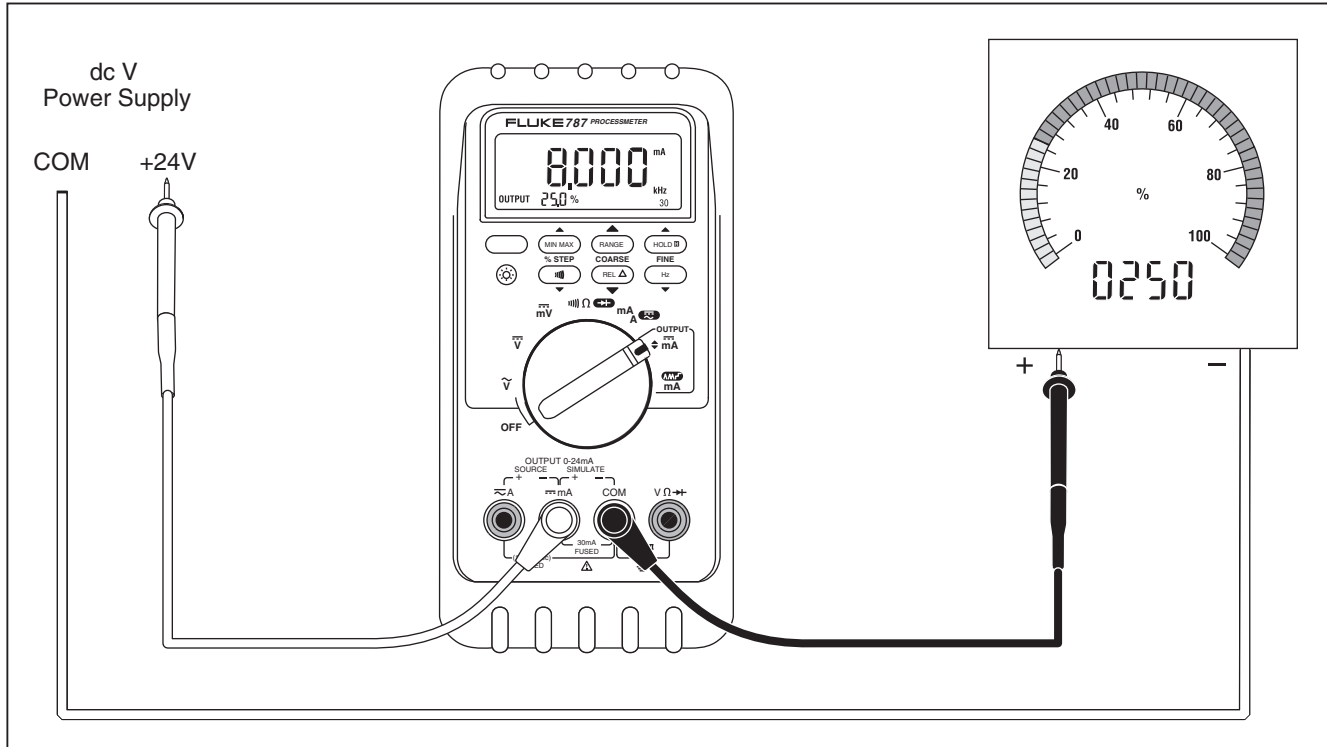

Figure 8. Simulating a Transmitter

ee011f.eps

Producing a Steady mA Output

When the rotary switch is in the OUTPUT \blacklozenge mA position, and the OUTPUT jacks are connected to an appropriate load, the Meter produces a steady mA dc output. The Meter begins sourcing or simulating 0%. Use the pushbuttons to adjust the current as shown in Table 8.

Select either sourcing or simulating by choosing the SOURCE or SIMULATE output jacks.

If the Meter cannot deliver the programmed current because the load resistance is too high or the loop supply voltage is too low, dashes (-----) appear on the numeric display. When the impedance between the SOURCE jacks is low enough, the Meter will resume sourcing.

Note

The STEP pushbuttons described on the next page are available when the Meter is producing a steady mA output. The STEP pushbuttons go to the next multiple of 25 %.

Table 8. mA Output Adjust Pushbuttons

Pushbutton	Adjustment
\blacktriangle RANGE COARSE	Adjusts up 0.1 mA
\blacktriangle HOLD \square FINE	Adjusts up 0.001 mA
FINE Hz \blacktriangledown	Adjusts down 0.001 mA
COARSE REL \triangle \blacktriangledown	Adjusts down 0.1 mA

Manually Stepping the mA Output

When the rotary switch is in the OUTPUT \blacklozenge mA position, and the OUTPUT jacks are connected to an appropriate load, the Meter produces a steady mA dc output. The Meter begins sourcing or simulating 0 %. Use the pushbuttons to step the current up and down in 25 % steps as shown in Table 9. See Table 10 for mA values at each 25 % step.

Select either sourcing or simulating by choosing the SOURCE or SIMULATE output jacks.

If the Meter cannot deliver the programmed current because the load resistance is too high or the loop supply voltage is too low, dashes (----) appear on the numeric display. When the impedance between the SOURCE jacks is low enough, the Meter will resume sourcing.

Note

The COARSE and FINE adjustment pushbuttons described on the previous page are available when you are manually stepping the mA output.

Table 9. mA Stepping Pushbuttons



Pushbutton	Adjustment
	Adjusts up to the next higher 25 % step
	Adjusts down to the next lower 25 % step



Table 10. mA Step Values

Step	Value (for each span setting)	
	4 to 20 mA	0 to 20 mA
0 %	4.000 mA	0.000 mA
25 %	8.000 mA	5.000 mA
50 %	12.000 mA	10.000 mA
75 %	16.000 mA	15.000 mA
100 %	20.000 mA	20.000 mA
125 %	24.000 mA	
120 %		24.000 mA

Auto Ramping the mA Output

Auto ramping gives you the ability to continuously apply a varying current stimulus from the Meter to a transmitter, while your hands remain free to test the response of the transmitter. Select either sourcing or simulating by choosing the SOURCE or SIMULATE jacks.

When the rotary switch is in the OUTPUT mA  position, the Meter produces a continuously repeating 0 % - 100 % - 0 % ramp in your choice of three ramp waveforms:

-  0 % - 100 % - 0 % 40-second smooth ramp, (default)
-  0 % - 100 % - 0 % 15-second smooth ramp
-  0 % - 100 % - 0 % Stair-step ramp in 25 % steps, pausing 5 seconds at each step. Steps are listed in Table 10.

The ramp times are not adjustable. Press the BLUE pushbutton to cycle through the three waveforms.

Note

At any time during auto ramping, you can freeze the ramp simply by moving the rotary switch to the  mA position. Then you can use the COARSE, FINE, and % STEP adjust pushbuttons to make adjustments.



Power-Up Options

To select a power-up option, hold down the pushbutton shown in Table 11 while turning the rotary switch from OFF to any on position. Wait 2 seconds before you release the pushbutton after powering up the Meter. The Meter beeps to acknowledge the power-up option.

Only the setting for current span is retained when the power is turned off. The others have to be repeated for each operating session.

You may activate more than one power-up option by holding down more than one pushbutton.

Table 11. Power-Up Options

Option	Pushbutton	Default	Action Taken
Change current span 0 % setting		Remembers last setting	Toggles between 0 and 4 mA
Disable beeper		Enabled	Disables beeper
Disable auto power-off	BLUE	Enabled	Disables the feature that turns off the Meter power after 30 minutes of inactivity. Auto power off is disabled regardless of this option if MIN MAX recording is on.

Battery Life

Warning

To avoid false readings, which could lead to possible electric shock or personal injury, replace the battery as soon as the battery indicator () appears.

Table 12 shows typical alkaline battery life. To preserve battery life:

- Use current simulation instead of sourcing when possible.
- Avoid using the backlight.
- Do not disable the automatic power-off feature.
- Turn the Meter off when you are not using it.

Table 12. Typical Alkaline Battery Life

Meter Operation	Hours
Measuring any parameter or simulating current	80
Sourcing 12 mA into 500Ω	12

Using the Holster

The Meter is supplied with a snap-on holster that absorbs shocks and protects the Meter from rough handling. You can turn the Meter over in the holster to protect the face of the meter from scratches when carrying the Meter.

Caution

For best mechanical performance, the Product must remain in the holster at all times.

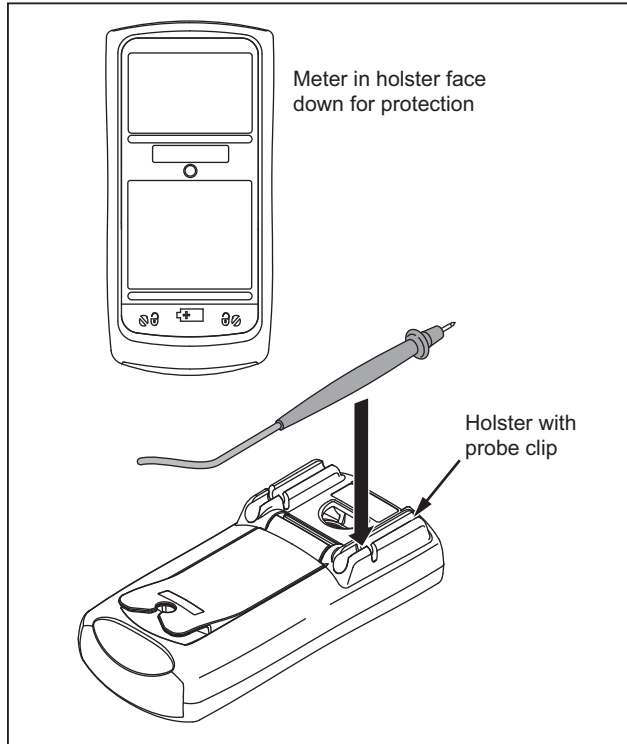

ee009f.eps

Figure 9. Using the Holster

Maintenance

This section provides some basic maintenance procedures. Repair, calibration, servicing not covered in this manual must be performed by qualified personnel. For maintenance procedures not described in this manual, contact a Fluke Service Center.

General Maintenance

Periodically wipe the case with a damp cloth and detergent; do not use abrasives or solvents.

Calibration

Calibrate your Meter once a year to ensure that it performs according to its specifications. Contact a Fluke Service Center for instructions.

Replacing the Battery

⚠ ⚠ Warning

To prevent possible electrical shock, fire, or personal injury:

- **Remove test leads from the Meter before opening the battery door.**
- **Make sure the battery door is closed and latched before operating the Meter.**

Remove test leads from the Meter before you open the battery door.

Replace the battery as follows. Refer to Figure 10. Use an alkaline 9 V battery.

1. Remove the test leads and set the rotary switch to OFF.
2. With a standard blade hand screwdriver, turn each battery door screw counterclockwise so that the slot is parallel with the screw picture molded into the case.
3. Lift off the battery door.

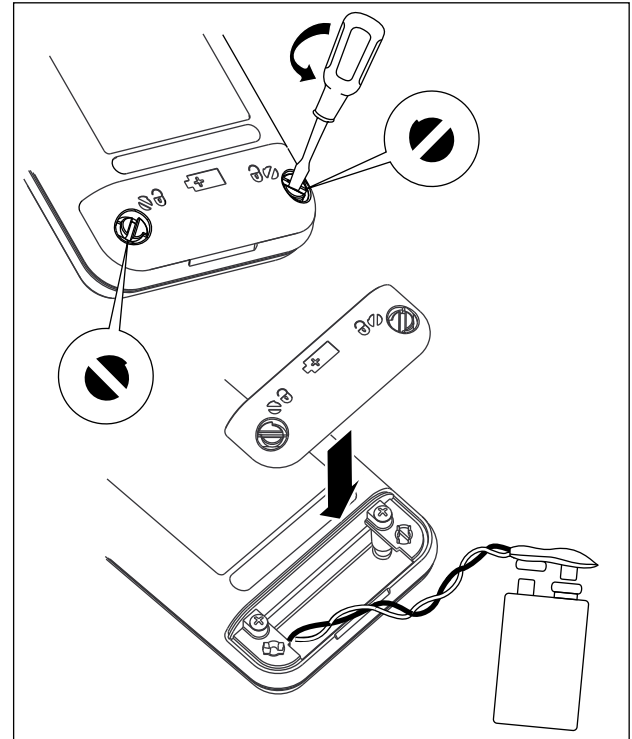

ee007f.eps



Figure 10. Replacing the Battery

Replacing a Fuse

Warning

To avoid personal injury or damage to the Meter, use only the specified replacement fuse, 440 mA 1000V fast-blow, Fluke PN 943121.

Both current input jacks are fused with a separate 440 mA fuse. To determine if a fuse is blown:

1. Turn the rotary switch to mA A .
2. Plug the black test lead into COM, and the red test lead into  A.
3. Using an ohmmeter, check the resistance between the meter test leads. If the resistance is about 1Ω , the fuse is good. An open means the fuse is blown.
4. Move red test lead to  mA.
5. Using an ohmmeter, check the resistance between the meter test leads. If the resistance is about 14Ω , the fuse is good. An open means the fuse is blown.

If a fuse is blown, replace it as follows. Refer to Figure 11 as necessary:

1. Remove the test leads from the Meter and turn the rotary switch to OFF.
2. Remove the battery door.
3. Remove the three Hexalobular (star) screws from the case bottom and turn the case over.
4. Gently lift the bottom of the front of the case (nearest the input/output jacks) until the top unsnaps from the rear half of the case.
5. Replace the blown fuse with the exact type specified: 440 mA 1000V fast-blow fuse, Fluke PN 943121. Both fuses are the same type.
6. Make sure the rotary switch is in the OFF position.
7. Fit the top of case together, engaging the two snaps (item ①). Make sure that the gasket is properly seated.
8. Close the case and reinstall the three screws.
9. Replace the battery door.

If the Meter does not Work

- Examine the case for physical damage. If there is damage, make no further attempt to use the Meter, and contact a Fluke Service Center.
- Check the battery, fuses, and test leads.
- Review this manual to make sure you are using the correct jacks and rotary switch position.

If the Meter still does not work, contact a Fluke Service Center. If the Meter is under warranty, it will be repaired or replaced (at Fluke's option) and returned at no charge. See the Warranty on the back of the title page for terms. If the warranty has lapsed, the Meter will be repaired and returned for a fixed fee. Contact a Fluke Service Center for information and price.

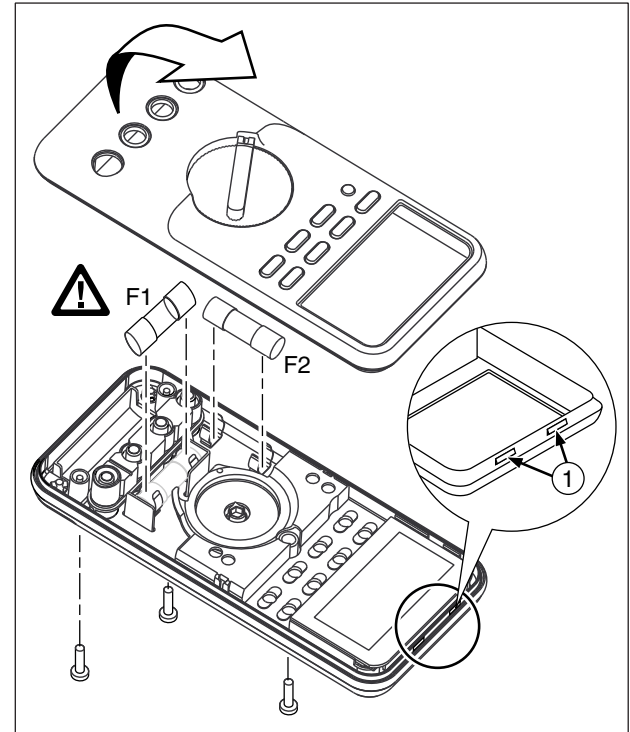

ee012f.eps

Figure 11. Replacing a Fuse

Replacement Parts and Accessories

Warning

To avoid personal injury or damage to the Meter, use only the specified replacement fuse, 440 mA 1000V fast-blow, Fluke PN 943121.

Note

When servicing the Meter, use only the replacement parts specified here.

Replacement parts and some accessories are shown in Figure 12 and listed in Table 13. Many more DMM accessories are available from Fluke. For a catalog, contact your nearest Fluke distributor.

To find out how to order parts or accessories use the telephone numbers or addresses shown on page 1 of this manual.

Table 13. Replacement Parts

Item	Description	Fluke PN or Model no.	Quantity
BT1	9 V battery, IEC 6LR61	614487	1
MP103	Holster, Yellow	2074033	1
△ F1, 2	Fuse, 440 mA, 1000V fast-blow	943121	2
MP85	Case top	619962	1
MP86	Case bottom	619939	1
H2, 3, 4	Case screw	832246	3
MP89, 90	Non-skid foot	824466	2
MP8	O-ring for input/output receptacle	831933	1
MP92	Battery door	619947	1
H5, 6	Battery door fasteners	948609	2
S1	Keypad	646932	1
Not shown	Test Leads	variable ^[1]	1 (set of 2)
Not shown	Alligator Clips	variable ^[1]	1 (set of 2)
Not shown	Industrial test lead set	variable ^[1]	Option
Not shown	Quick Reference Guide	4276679	1
Not shown	Users Manual	See Fluke website	-
Not shown	Calibration Manual	See Fluke website	-

[1] See www.fluke.com for more information about the test leads and alligator clips available for your region.

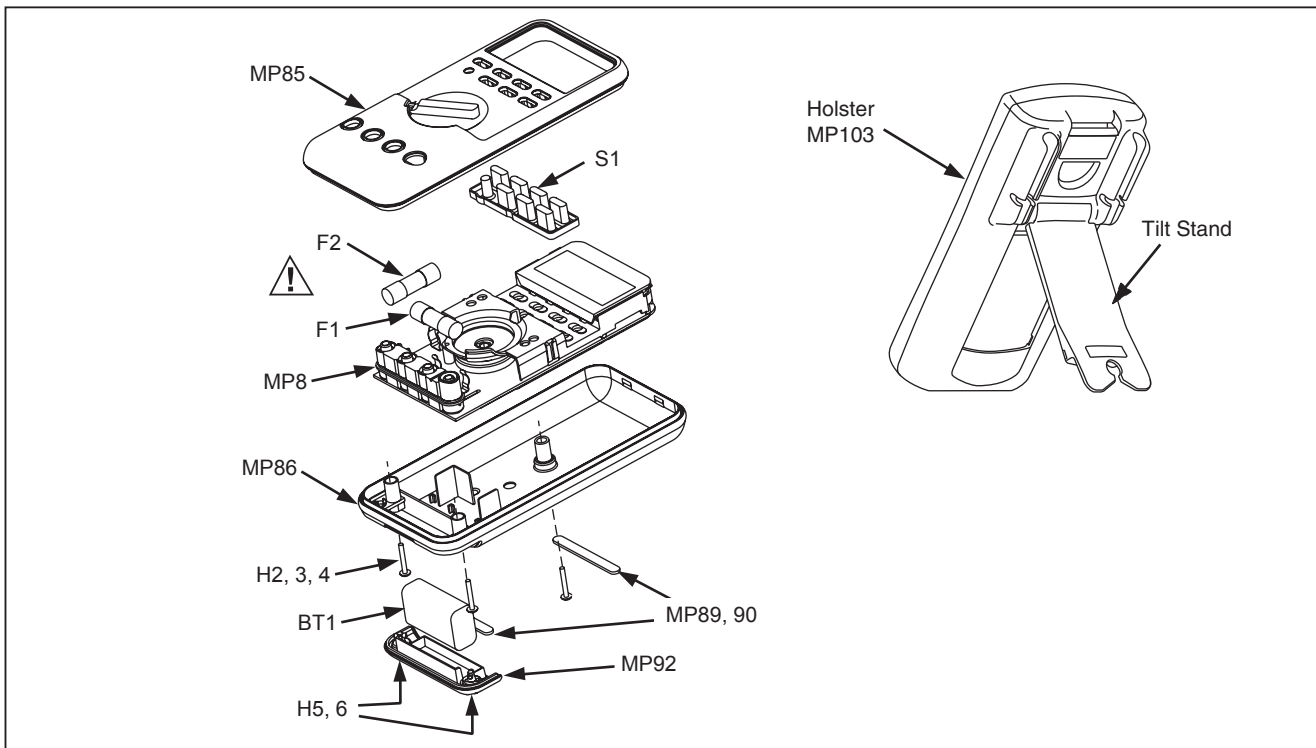

Figure 12. Replacement Parts

ee015c.eps

Specifications

All specifications apply from +18°C to +28°C unless stated otherwise.

All specifications assume a 5 minute warmup period.

The standard specification interval is 1 year.

Note

“Counts” means number of increments or decrements of the least significant digit.

DC Volts Measurement

Range (V dc)	Resolution	Accuracy, \pm (% of Reading + Counts)
4.000	0.001 V	0.1 % + 1
40.00	0.01 V	0.1 % + 1
400.0	0.1 V	0.1 % + 1
1000	1 V	0.1 % + 1

Input impedance: 10 M Ω (nominal), <100 pF
Normal mode rejection ratio: >60 dB at 50 Hz or 60 Hz
Common mode rejection ratio: >120 dB at dc, 50 Hz, or 60 Hz
Overvoltage protection: 1000V

DC Millivolts Measurement

Range (mV dc)	Resolution	Accuracy (% of Reading + Counts)
400.0	0.1 mV	0.1 % + 1

AC Volts Measurement

Range (ac)	Resolution	Accuracy, \pm (% of Reading + Counts)		
		50 Hz to 60 Hz	45 Hz to 200 Hz	200 Hz to 500 Hz
400.0 mV	0.1 mV	0.7 % + 4	1.2 % + 4	7.0 % + 4
4.000 V	0.001 V	0.7 % + 2	1.2 % + 4	7.0 % + 4
40.00 V	0.01 V	0.7 % + 2	1.2 % + 4	7.0 % + 4
400.0 V	0.1 V	0.7 % + 2	1.2 % + 4	7.0 % + 4
1000 V	1 V	0.7 % + 2	1.2 % + 4	7.0 % + 4

Specifications are valid from 5 % to 100 % of amplitude range.

AC conversion: true rms

Maximum crest factor: 3

For non-sinusoidal waveforms, add \pm (2 % reading + 2 % f.s.) typical

Input impedance: 10 M Ω (nominal), < 100 pF, ac-coupled

Common mode rejection ratio: >60 dB at dc, 50 Hz, or 60 Hz

AC Current Measurement

Range 45 Hz to 2 kHz	Resolution	Accuracy, \pm(% of Reading + Counts)	Typical Burden Voltage
1.000 A (Note)	0.001 A	1 % + 2	1.5 V/A
<i>Note: 440 mA continuous, 1 A 30 seconds maximum on, 5 minutes off</i>			
<i>Specifications are valid from 5 % to 100 % of amplitude range.</i>			
<i>AC conversion: true rms</i>			
<i>Maximum crest factor: 3</i>			
<i>For non-sinusoidal waveforms, add \pm(2 % reading + 2 % f.s.) typical</i>			
<i>Overload protection 440 mA, 1000V fast-blow fuse</i>			

DC Current Measurement

Range	Resolution	Accuracy, \pm(% of Reading + Counts)	Typical Burden Voltage
30.000 mA	0.001 mA	0.05 % + 2	14 mV/mA
1.000 A (Note)	0.001 A	0.2 % + 2	1.5 V/A
<i>Note: 440 mA continuous, 1A 30 seconds maximum on, 5 minutes off</i>			
<i>Overload protection: 440 mA, 1000V fast-blow fuse</i>			

Ohms Measurement

Range	Resolution	Measurement Current	Accuracy, \pm(% of Reading + Counts)
400.0 Ω	0.1 Ω	220 μ A	0.2 % + 2
4.000 k Ω	0.001 k Ω	59 μ A	0.2 % + 1
40.00 k Ω	0.01 k Ω	5.9 μ A	0.2 % + 1
400.0 k Ω	0.1 k Ω	590 nA	0.2 % + 1
4.000 M Ω	0.001 M Ω	220 nA	0.35 % + 3
40.00 M Ω	0.01 M Ω	22 nA	2.5 % + 3
<i>Overload protection: 1000 V</i> <i>Open circuit voltage: <3.9 V</i>			

Frequency Counter Accuracy

Range	Resolution	Accuracy, \pm (% of Reading + Counts)
199.99 Hz	0.01 Hz	0.005 % + 1
1999.9 Hz	0.1 Hz	0.005 % + 1
19.999 kHz	0.001 kHz	0.005 % + 1

Display updates 3 times/second at >10 Hz

Frequency Counter Sensitivity

Input Range	Minimum Sensitivity (rms Sinewave) 5 Hz to 5 kHz*
1 V	0.1 V
4 V	1 V
40 V	3 V
400 V	30 V
1000 V	300 V

* Usable 0.5 Hz to 20 kHz with reduced sensitivity.

Diode Test and Continuity Test

Diode test indication: display voltage drop: 0.2 mA nominal test current at 0.6V: 2.4V full scale, accuracy $\pm(2\% + 1 \text{ count})$

Continuity test indication: continuous audible tone for test resistance $<100 \Omega$

Open circuit voltage: $<3.9 \text{ V}$

Short circuit current: 1.2 mA typical

Overload protection: 1000 V rms

DC Current Output

Source mode:

Span: 0 mA or 4 mA to 20 mA, with overrange to 24 mA

Accuracy: 0.05 % of span

Compliance voltage: 12 V with battery voltage $>8.5 \text{ V}$

Simulate Mode:

Span: 0 mA or 4 mA to 20 mA, with overrange to 24 mA

Accuracy: 0.05 % of span

Loop voltage: 24 V nominal, 30 V maximum, 15 V minimum

Compliance voltage: 21 V for 24 V supply

Burden voltage: $<3 \text{ V}$

General Specifications

Maximum voltage applied between any jack and earth ground	1000 V
Storage temperature	-40 °C to 60 °C
Operating temperature	-20 °C to 55 °C
Operating altitude	2000 meters maximum
Temperature coefficient	0.05 x specified accuracy per °C for temperatures <18 °C or >28 °C
Relative humidity	95 % up to 30 °C, 75 % up to 40 °C, 45 % up to 50 °C, and 35 % up to 55 °C
Vibration	Random Mil-prf-28800f, 10 Hz to 500 Hz
Shock	1 meter drop test
Power requirements	Single 9 V battery (IEC 6LR61)
Size	32 mm H x 87 mm W x 187 mm L (1.25 in H x 3.41 in W x 7.35 in L)
With holster	52 mm H x 98 mm W x 201 mm L (2.06 in H x 3.86 in W x 7.93 in L)
Weight	369 g (13 oz)
With holster	638 g (22.5 oz)

Safety

General IEC 61010-1: Pollution Degree 2

Measurement IEC 61010-2-033: CAT III 1000 V

Electromagnetic Compatibility (EMC) Accuracy for all ProcessMeter functions is not specified in RF field >3 V/m

International IEC 61326-1: Portable Electromagnetic Environment; IEC 61326-2-2
CISPR 11: Group 1, Class A

Group 1: Equipment has intentionally generated and/or use conductively coupled radio-frequency energy that is necessary for the internal functioning of the equipment itself.

Class A: Equipment is suitable for use in all establishments other than domestic and those directly connected to a low-voltage power supply network that supplies buildings used for domestic purposes. There may be potential difficulties in ensuring electromagnetic compatibility in other environments, due to conducted and radiated disturbances.

Caution: This equipment is not intended for use in residential environments and may not provide adequate protection to radio reception in such environments.

Korea (KCC)..... Class A Equipment (Industrial Broadcasting & Communication Equipment)

Class A: Equipment meets requirements for industrial electromagnetic wave equipment and the seller or user should take notice of it. This equipment is intended for use in business environments and not to be used in homes.

USA (FCC) 47 CFR 15 subpart B. This product is considered an exempt device per clause 15.103.