

PRODUCT DATA SHEET



June 2007

Charter Member



Metacaulk® 1000 Firestopping Sealant

Classified System Numbers TRC/PV 60-03, TRC/PV 120-13, TRC/PV 120-15, TRC/PV 120-17, TRC/PHV 120-09, CAJ1320, CAJ 2112, CAJ 2113, CAJ 3086, CAJ 3087, CAJ5134, CAJ 5070, CAJ 5077, CAJ 5078, CAJ 1221, CAJ 2120, CAJ 2119, CAJ 2122, CAJ 5085, CAJ8047, CAJ 8050, CAJ 2134, CAJ1260, CAJ1261, CAJ1263, CAJ1296, CAJ1263, CAJ5136, CAJ1329, CAJ1327, CAJ2245, CAJ2247, CAJ6025, WL 5057, WL 5059, WL 5061, WL 5063, WL5084, WL5092, WL 2102, WL 2104, WL 2106, WL 1099, WL1159, WL1199, WL 1104, WL 1102, WL 1108, WL 1106, WL 2108, WL2238, WL2192, WL2190, WL2201, WL2209, WL3155, WL3152, WL5075, WL1120, WL1110, WL1116, WL1114, WL1161, WL1177, WL1179, WL1181, WL5127, WL7034, WL7036, WL6008, WJ 5016, WJ 5018, WJ 5020, WJ 5022, WJ 2023, WJ 2025, WJ 2027, WJ2065, WJ2063, WJ2073, WJ 1036, WJ 1038, WJ3056, WJ3058, WJ3058, WJ5029, WJ5033, WJ1045, WJ1043, WJ1081, WJ1059, WJ1061, WJ1079, WJ 5059, WJ7016, WJ7014, WJ5039, FC 1030, FC 1032, FC 2065, FC 5020, FC 5022, FC 2077, FC 2075, FC 2076, FC2190, FC2192, FC2132, FC2130, FC1055, FC1041, FC2148, FC1061, FC3035, FC1065, FC1063, FC3051, HWD 0014, HWD 0179, HWD0056

1. Product Description

Metacaulk® 1000 is a one component, general purpose fire rated sealant and smoke seal for construction joints and through-penetrations. Metacaulk® 1000 is a water based, extremely intumescent, non-sag caulking grade sealant that is easy to apply as well as to retrofit. It cures to an elastomeric seal that is suitable where dynamic movement is expected. In the event of a fire, Metacaulk® 1000 will prevent the spread of flames, smoke, hot gases and water through joint openings and through-penetrations. No dilution or mixing is required for use. No special skills are necessary for installation. Metacaulk® 1000 is applied with a conventional caulking gun, bulk loading gun or can be troweled from the pail. For large applications, it can be pumped directly from the pail. Metacaulk® 1000 systems are rated for 1, 2, 3 and 4 hours in accordance with the ASTM E814 (UL1479), UL 2079 and ULC-S115-95 test standards. **Metacaulk® 1000 is protected in a wet stage as well as in a dry stage against mold growth with a combination of biocides.**

Use Metacaulk® 1000 for various applications:

- Top of the Wall Construction Joints
- Deflection Track Wall Systems
- Up to 2" (51 mm) PVC (Open)
- Up to 3" (76 mm) PVC & ABS (Closed)
- Crosslinked Polyethylene (PEX) tubing
- Steel, Copper, Cast Iron and EMT Pipe
- Flexible Conduit
- Fiberglass Insulated Pipe
- Armaflex Insulated Pipe
- Telephone, Communication and Power Cables
- HVAC Ductwork

For a complete list of product applications or for additional technical information, call RECTORSEAL for the latest updated information.

Metacaulk® 1000 Features

- Water Based
- Excellent Freeze-Thaw
- Flexible Set
- Highly Intumescent
- Paintable
- VOC Compliant
- Safe and Easy to Use
- Minimum 2 Year Shelf Life

2. Material Properties

Asbestos Fillers	None
Solvents	None
Hazardous Ingredients	None

Application	Caulking Gun or Trowel
-------------	------------------------------

Activation of Intumescence:

Expansion Begins	375° F (190°C)
Expansion Greatest	575° (302°) to 1100° F (593° C)

Color	Red
Cure Time	3 to 4 weeks (at 77° F/ 25°C)
Density	10.5 +/- 0.5 lbs./gal. 1.25 kg/L
Elastomeric	Yes
Freeze-Thaw	Excellent
Skin Over Time	30 min. (at 77° F/ 25°C)
pH Value	6.5 to 7

Volume Coverage:	
for 10.3 oz. tube (304ml)	18 cu. in. (295 cc)
for 5 gallon (18.9 liter)	1155 cu. in. (5000 cu. cm/L)
VOC	Negligible

ASTM E 84, UL 723 Tunnel Test

Flame Spread	5
Smoke Index	10

STC 54*

*Tested in a UL 411 wall assembly/section to ASTM E90.

3. Applications

Metacaulk® 1000 can be used in interior applications as a general purpose fire rated sealant and smoke seal for construction joints on both vertical and horizontal surfaces.



Metacaulk® 1000 is also an excellent fire rated acoustical sealant and can be used in areas under constant vibration or movement. Metacaulk® 1000 can also be used on various penetrations such as EMT, telephone & power cables, insulated pipes, etc. in concrete floors and walls, gypsum walls as well as wood floors. Use Metacaulk® 1000 to prevent the spread of fire and smoke through joints in fire rated gypsum wallboard partitions, concrete block or concrete walls and/or concrete or corrugated steel deck floor/ceiling assemblies.

4. Installation Data

Install Metacaulk® 1000 using standard caulking techniques or trowel from pails. Metacaulk® 1000 may also be pumped from the pails. When damming materials are needed, use only materials approved for the specific application.

TYPICAL TOP OF WALL INSTALLATION

Step 1)

Cut and fit the gypsum wallboard to the contour of the steel decking leaving a maximum 3/4" (19 mm) relief gap.

Step 2)

Pack the flute openings and relief gap with required amount of fiberglass insulation and recess to required depth.

Step 3)

Gun, trowel or pump the sealant as required to the specified depth. Properly tool sealant surface flush with the wall.

5. Testing Data

For specific test criteria, refer to the UL's Fire Resistance Directory or Warnock Hersey International Listing Directory or call RECTORSEAL

Metacaulk® 1000 was tested at positive

10. LIMITED WARRANTY

RectorSeal makes the Limited Express Warranty that when the instructions for storage and handling of our products are followed we warrant our products to be free from defects. THIS LIMITED EXPRESS WARRANTY IS EXPRESSLY IN LIEU OF ANY OTHER EXPRESS OR IMPLIED WARRANTIES, INCLUDING ANY IMPLIED WARRANTY OF MERCHANTABILITY OR FITNESS FOR A PARTICULAR PURPOSE, AND OF ANY OTHER OBLIGATION ON THE PART OF RECTORSEAL. The sole remedy for breach of the Limited Express Warranty shall be the refund of the purchase price. All other liability is negated and disclaimed, and RectorSeal shall not be liable for incidental or consequential damages.

Suggestions and recommendations covering the use of our products are based on our past experience and laboratory findings. However, as we have no control as to the methods and conditions of application, we only assume responsibility for the uniformity of our products within manufacturing tolerances.

pressure with a minimum 0.01 (2.5 Pa) inches water and in accordance with ASTM E814 (UL 1479), UL 2079 and ULC-S115-95.

Complies to Required Environmental Exposure Testing of Accelerated Aging and High Humidity as per UL 1479 Fire Test of Through-Penetration Firestops.



FGG/BM/CZ™ System Compatible* indicates that this product has been tested, and is monitored on an ongoing basis, to assure its chemical compatibility with FlowGuard Gold®, BlazeMaster® and Corzan® pipe and fittings. FlowGuard Gold®, BlazeMaster® and Corzan® are licensed trademarks of the Lubrizol corporation.

6. Storage & Handling

Metacaulk® 1000 should be stored between 35°F (2°C) and 120° F (49° C). to obtain a minimum 2 year shelf life. NOTE: Do not dilute, no mixing is required. Best if protected from freezing. If freezing occurs, thaw completely before using. Keep products stored under protective cover in original containers.

7. Availability

Metacaulk® 1000 is available in 10.3 oz. (304 ml), 30 oz. (887 ml) caulking tubes and 20.2 oz. (597 ml) sausage pack

and in 5 gallon (18.9 L) pails.

8. Limitations

Metacaulk® 1000 is not designed to be used in areas under continuous immersion or in areas which would be continuously wet. Metacaulk® 1000 should not be used against hot uninsulated surfaces above 300° F (149° C).

9. Cautions

FOR CHEMICAL EMERGENCY, SPILL, LEAK, FIRE, EXPOSURE OR ACCIDENT, CALL CHEMTREC-DAY OR NIGHT 1-800-424-9300.

PRECAUTIONS: Do not take internally. May be harmful if swallowed. May cause eye and skin irritation if prolonged or repeated contact occurs. Wash after handling. **FIRST AID:** For any overexposure, get immediate medical attention after first aid is given. **Eyes-** Flush 15 minutes with clean water. **Skin-** Wash with soap and water. **Inhalation-** Remove to fresh air. **Ingestion-** Only if conscious, give large amounts of water and INDUCE VOMITING. **FIRE AND SPILLS:** Use water fog, CO₂, foam, or dry chemicals. Wipe up spills to prevent footing hazard. Clean up with scrapers and water. **STORAGE AND HANDLING:** Store away from heat sources. Keep container closed. Do not reuse empty container. **KEEP OUT OF REACH OF CHILDREN.**

For additional information, refer to Material Safety Data Sheet.

For additional technical service, call: 1-800-231-3345 fax: 1-800-452-2824 www.rectorseal.com www.metacaulk.com

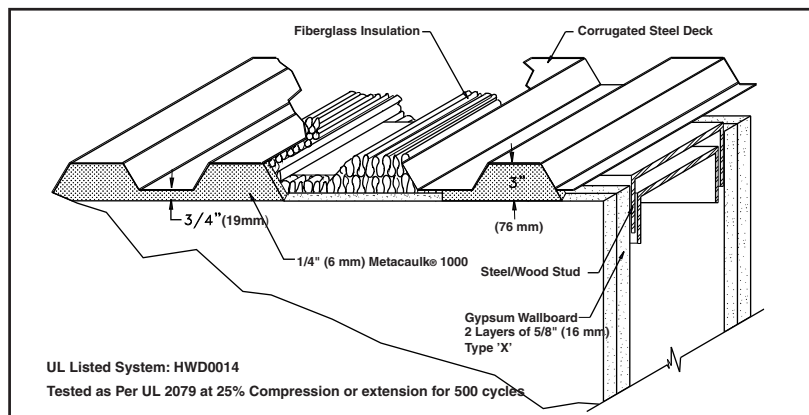

PRODUCT DATA SHEET



June 2007

Charter Member



Metacaulk® 1000 Firestopping Sealant

Classified System Numbers TRC/PV 60-03, TRC/PV 120-13, TRC/PV 120-15, TRC/PV 120-17, TRC/PHV 120-09, CAJ1320, CAJ 2112, CAJ 2113, CAJ 3086, CAJ 3087, CAJ5134, CAJ 5070, CAJ 5077, CAJ 5078, CAJ 1221, CAJ 2120, CAJ 2119, CAJ 2122, CAJ 5085, CAJ8047, CAJ 8050, CAJ 2134, CAJ1260, CAJ1261, CAJ1263, CAJ1296, CAJ1263, CAJ5136, CAJ1329, CAJ1327, CAJ2245, CAJ2247, CAJ6025, WL 5057, WL 5059, WL 5061, WL 5063, WL5084, WL5092, WL 2102, WL 2104, WL 2106, WL 1099, WL1159, WL1199, WL 1104, WL 1102, WL 1108, WL 1106, WL 2108, WL2238, WL2192, WL2190, WL2201, WL2209, WL3155, WL3152, WL5075, WL1120, WL1110, WL1116, WL1114, WL1161, WL1177, WL1179, WL1181, WL5127, WL7034, WL7036, WL6008, WJ 5016, WJ 5018, WJ 5020, WJ 5022, WJ 2023, WJ 2025, WJ 2027, WJ2065, WJ2063, WJ2073, WJ 1036, WJ 1038, WJ3056, WJ3058, WJ3059, WJ5029, WJ5033, WJ1045, WJ1043, WJ1081, WJ1059, WJ1061, WJ1079, WJ 5059, WJ7016, WJ7014, WJ5039, FC 1030, FC 1032, FC 2065, FC 5020, FC 5022, FC 2077, FC 2075, FC 2076, FC2190, FC2192, FC2132, FC2130, FC1055, FC1041, FC2148, FC1061, FC3035, FC1065, FC1063, FC3051, HWD 0014, HWD 0179, HWD0056

1. Product Description

Metacaulk® 1000 is a one component, general purpose fire rated sealant and smoke seal for construction joints and through-penetrations. Metacaulk® 1000 is a water based, extremely intumescent, non-sag caulking grade sealant that is easy to apply as well as to retrofit. It cures to an elastomeric seal that is suitable where dynamic movement is expected. In the event of a fire, Metacaulk® 1000 will prevent the spread of flames, smoke, hot gases and water through joint openings and through-penetrations. No dilution or mixing is required for use. No special skills are necessary for installation. Metacaulk® 1000 is applied with a conventional caulking gun, bulk loading gun or can be troweled from the pail. For large applications, it can be pumped directly from the pail. Metacaulk® 1000 systems are rated for 1, 2, 3 and 4 hours in accordance with the ASTM E814 (UL1479), UL 2079 and ULC-S115-95 test standards. **Metacaulk® 1000 is protected in a wet stage as well as in a dry stage against mold growth with a combination of biocides.**

Use Metacaulk® 1000 for various applications:

- Top of the Wall Construction Joints
- Deflection Track Wall Systems
- Up to 2" (51 mm) PVC (Open)
- Up to 3" (76 mm) PVC & ABS (Closed)
- Crosslinked Polyethylene (PEX) tubing
- Steel, Copper, Cast Iron and EMT Pipe
- Flexible Conduit
- Fiberglass Insulated Pipe
- Armaflex Insulated Pipe
- Telephone, Communication and Power Cables
- HVAC Ductwork

For a complete list of product applications or for additional technical information, call RECTORSEAL for the latest updated information.

Metacaulk® 1000 Features

- Water Based
- Excellent Freeze-Thaw
- Flexible Set
- Highly Intumescent
- Paintable
- VOC Compliant
- Safe and Easy to Use
- Minimum 2 Year Shelf Life

2. Material Properties

Asbestos Fillers	None
Solvents	None
Hazardous Ingredients	None

Application	Caulking Gun or Trowel
-------------	------------------------------

Activation of Intumescence:

Expansion Begins	375° F (190°C)
Expansion Greatest	575° (302°) to 1100° F (593° C)

Color	Red
Cure Time	3 to 4 weeks (at 77° F/ 25°C)
Density	10.5 +/- 0.5 lbs./gal. 1.25 kg/L
Elastomeric	Yes
Freeze-Thaw	Excellent
Skin Over Time	30 min. (at 77° F/ 25°C)
pH Value	6.5 to 7

Volume Coverage:	
for 10.3 oz. tube (304ml)	18 cu. in. (295 cc)
for 5 gallon (18.9 liter)	1155 cu. in. (5000 cu. cm/L)
VOC	Negligible

ASTM E 84, UL 723 Tunnel Test

Flame Spread	5
Smoke Index	10

STC 54*

*Tested in a UL 411 wall assembly/section to ASTM E90.

3. Applications

Metacaulk® 1000 can be used in interior applications as a general purpose fire rated sealant and smoke seal for construction joints on both vertical and horizontal surfaces.



Metacaulk® 1000 is also an excellent fire rated acoustical sealant and can be used in areas under constant vibration or movement. Metacaulk® 1000 can also be used on various penetrations such as EMT, telephone & power cables, insulated pipes, etc. in concrete floors and walls, gypsum walls as well as wood floors. Use Metacaulk® 1000 to prevent the spread of fire and smoke through joints in fire rated gypsum wallboard partitions, concrete block or concrete walls and/or concrete or corrugated steel deck floor/ceiling assemblies.

4. Installation Data

Install Metacaulk® 1000 using standard caulking techniques or trowel from pails. Metacaulk® 1000 may also be pumped from the pails. When damming materials are needed, use only materials approved for the specific application.

TYPICAL TOP OF WALL INSTALLATION

Step 1)

Cut and fit the gypsum wallboard to the contour of the steel decking leaving a maximum 3/4" (19 mm) relief gap.

Step 2)

Pack the flute openings and relief gap with required amount of fiberglass insulation and recess to required depth.

Step 3)

Gun, trowel or pump the sealant as required to the specified depth. Properly tool sealant surface flush with the wall.

5. Testing Data

For specific test criteria, refer to the UL's Fire Resistance Directory or Warnock Hersey International Listing Directory or call RECTORSEAL

Metacaulk® 1000 was tested at positive

10. LIMITED WARRANTY

RectorSeal makes the Limited Express Warranty that when the instructions for storage and handling of our products are followed we warrant our products to be free from defects. THIS LIMITED EXPRESS WARRANTY IS EXPRESSLY IN LIEU OF ANY OTHER EXPRESS OR IMPLIED WARRANTIES, INCLUDING ANY IMPLIED WARRANTY OF MERCHANTABILITY OR FITNESS FOR A PARTICULAR PURPOSE, AND OF ANY OTHER OBLIGATION ON THE PART OF RECTORSEAL. The sole remedy for breach of the Limited Express Warranty shall be the refund of the purchase price. All other liability is negated and disclaimed, and RectorSeal shall not be liable for incidental or consequential damages.

Suggestions and recommendations covering the use of our products are based on our past experience and laboratory findings. However, as we have no control as to the methods and conditions of application, we only assume responsibility for the uniformity of our products within manufacturing tolerances.

pressure with a minimum 0.01 (2.5 Pa) inches water and in accordance with ASTM E814 (UL 1479), UL 2079 and ULC-S115-95.

Complies to Required Environmental Exposure Testing of Accelerated Aging and High Humidity as per UL 1479 Fire Test of Through-Penetration Firestops.



FGG/BM/CZ™ System Compatible* indicates that this product has been tested, and is monitored on an ongoing basis, to assure its chemical compatibility with FlowGuard Gold®, BlazeMaster® and Corzan® pipe and fittings. FlowGuard Gold®, BlazeMaster® and Corzan® are licensed trademarks of the Lubrizol corporation.

6. Storage & Handling

Metacaulk® 1000 should be stored between 35°F (2°C) and 120° F (49° C). to obtain a minimum 2 year shelf life. NOTE: Do not dilute, no mixing is required. Best if protected from freezing. If freezing occurs, thaw completely before using. Keep products stored under protective cover in original containers.

7. Availability

Metacaulk® 1000 is available in 10.3 oz. (304 ml), 30 oz. (887 ml) caulking tubes and 20.2 oz. (597 ml) sausage pack

and in 5 gallon (18.9 L) pails.

8. Limitations

Metacaulk® 1000 is not designed to be used in areas under continuous immersion or in areas which would be continuously wet. Metacaulk® 1000 should not be used against hot uninsulated surfaces above 300° F (149° C).

9. Cautions

FOR CHEMICAL EMERGENCY, SPILL, LEAK, FIRE, EXPOSURE OR ACCIDENT, CALL CHEMTREC-DAY OR NIGHT 1-800-424-9300.

PRECAUTIONS: Do not take internally. May be harmful if swallowed. May cause eye and skin irritation if prolonged or repeated contact occurs. Wash after handling. **FIRST AID:** For any overexposure, get immediate medical attention after first aid is given. **Eyes-** Flush 15 minutes with clean water. **Skin-** Wash with soap and water. **Inhalation-** Remove to fresh air. **Ingestion-** Only if conscious, give large amounts of water and INDUCE VOMITING. **FIRE AND SPILLS:** Use water fog, CO₂, foam, or dry chemicals. Wipe up spills to prevent footing hazard. Clean up with scrapers and water. **STORAGE AND HANDLING:** Store away from heat sources. Keep container closed. Do not reuse empty container. **KEEP OUT OF REACH OF CHILDREN.**

For additional information, refer to Material Safety Data Sheet.

For additional technical service, call: 1-800-231-3345 fax: 1-800-452-2824 www.rectorseal.com www.metacaulk.com

