

In This Section...

Color-Keyed® Compression

Connection by Compression	B-2-B-5
Color-Keyed® Connectors.....	B-6-B-9
Connectors for Copper Conductor.....	B-10-B-42
C-Tap Connectors for Copper Conductor.....	B-43-B-44
Copper H-Tap Connectors for Copper Conductor.....	B-45-B-46
Aluminum H-Tap Connectors.....	B-47
Interlocking Insulating Covers for H- and C-Type Compression Taps.....	B-48-B-50
Wire Joints for Copper Conductor.....	B-51
Cast Copper Bus Taps for Copper Conductor	B-52
Motor Pigtail Connectors	B-53-B-57
KUBE™ Connectors	B-58-B-60
Copper Disconnects	B-61
Connector Kits.....	B-62
Connectors for Aluminum/Copper Code Conductor	B-63-B-66
Connectors for Aluminum Code Conductor	B-67
Splice Connectors for Aluminum/Copper Code Conductor.....	B-68
Transformer Lug Kits for Aluminum Code Conductor	B-69
Pin Connectors for Aluminum/Copper Code Conductor	B-70
Flag Lugs for Aluminum/Copper Code Conductor	B-71
Heavy-Duty Battery Connectors.....	B-72-B-74
Battery Cables, Heavy-Duty Battery Cables	B-75
Mechanical Compression Tools: #8 to 250 MCM and #8 to 500 MCM.....	B-76-B-77
Power-Assisted Compression Tools: #8 to 500 MCM #8 to 600 MCM; #8 to 750 MCM; #8 to 900 MCM; #8 to 1500 MCM; and #8 to 2000 MCM	B-78-B-84
Hydraulic Pumps	B-85-B-87
Battery Connector Tools	B-87
Strippers, Cutters and Other Tools.....	B-88-B-92
Seals and Lubricants.....	B-92
Installing Dies.....	B-93-B-95
Connectors for Copper Conductors (Metric)	B-96-B-99
Metric Compression Tools	B-100
Tool Services.....	B-101

Color-Keyed® Compression

Thomas & Betts

United States
Tel: 901.252.8000
Fax: 901.252.1354

Canada
Tel: 450.347.5318
Fax: 450.347.1976

Technical Services
Tel: 888.862.3289

www.tnb.com

Connection by Compression

The Thomas & Betts Method is Better.

The Thomas & Betts method of installing compression connectors on power cables is designed to provide a high degree of reliability in electrical wiring. This method allows electrical workers to make installations with little effort and at a considerable savings in time. The benefit, of course, is a high quality connection at a low installed cost.

Just Four Easy Steps to a Perfect Connection!

Step 1

Strip the insulation carefully to avoid nicking or cutting conductors (wire brush if required).



Color-Keyed® Compression

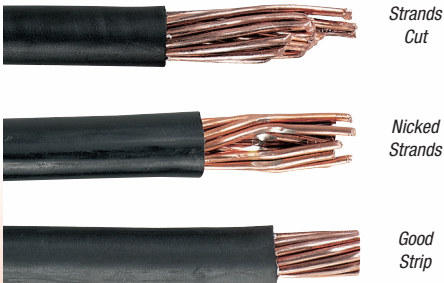

Strip the insulation to the proper length so that conductors can be fully inserted into the connector barrel.

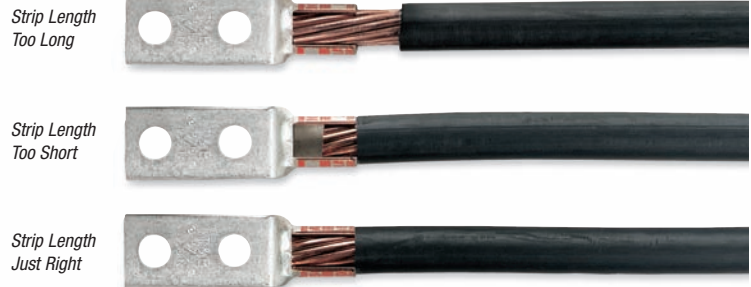

Step 2

Determine the proper Color-Keyed® Connector for the cable size being used. Connectors are marked to show cable size.

- Connectors marked with just cable size or CU should be used on copper conductors only.
- Connectors marked "AL9"* with the cable size should be used on aluminum conductors only.
- Connectors marked "AL9CU" with the cable size may be used on the aluminum or copper conductors.

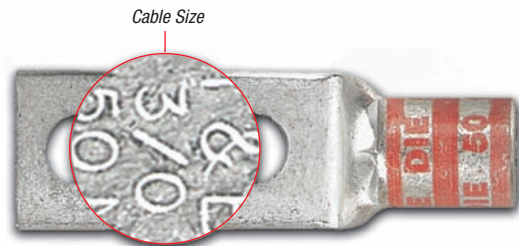

* Aluminum lugs with a "9" indicate 90°C rating.

Connection by Compression

Step 3

Select the proper installing die and appropriate tool.

Color-Keyed® Connectors have colored bands or colored dots that correspond to color markings on the dies.

Connectors and dies also have a die code number marked or stamped on them. Dies have a code number engraved in the crimp surface.



Step 4

Locate tool with correct die in proper position on connector and activate tool.

When making multiple crimps, make the first crimp nearest the tongue and work towards the barrel end.

When properly crimped, the die code number will be embossed on the connector for easy inspection to determine if correct die and connector combination were used.

Copper
Die located
BETWEEN bands



Aluminum
Die located
ON Bands



Die location for compression

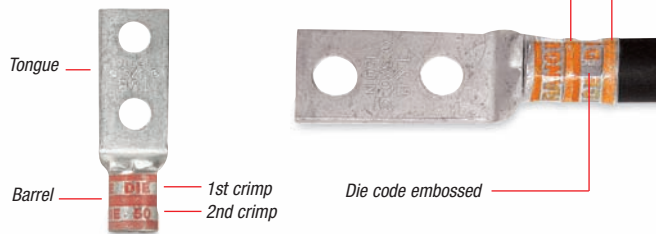

Color-Keyed® Connectors are banded by colored stripes or engraving to indicate location of die on connector for compression.

Thomas & Betts uses "full-width" and "half-width" dies dependent on connector size and tool used. "Half-width" dies are marked with the letter "H" after the die code number.

Refer to the instruction sheet supplied with the connectors for information regarding strip length, die selection and number of compressions required.

Connection by Compression

Color-Keyed® Compression

Precision Dies form a Solid Homogenous Mass...

The T&B method utilizing compression tools with matching dies forms the connector and conductor into a solid, homogenous mass to provide an optimum electrical bond between connector and conductor.

Thomas & Betts method dies are designed to produce a circumferential, hex- or diamond-shaped compression rather than a simple indent. Precision dies are an integral part of the Thomas & Betts method. The precision hardened steel dies exert tremendous, controlled pressure on the connector and conductor. The dies compress the connector around the cable, converting the round strands to hexagonal or diamond shapes and forming the strands and connector into a solid mass. Each die is designed so that all conductors receive the same amount of compression force.

The circumferential compression creates a large area of high pressure contact between cable and connector which, in turn, assures high conductivity, low resistance, and high pullout values which exceed UL requirements. These features result in a permanent, low installed cost connection. You can install it, and forget it.



Thomas & Betts' System Tells You Where to Place the Installing Die.



Before compression, a typical cross section of cable and connector consists of about 75% metal and 25% air.

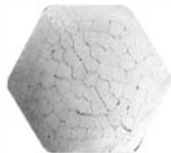

After air compression by the T&B Method, the cross section looks like this, 100% metal with virtually no air spaces.

Color-Keyed® connectors not only identify the correct installing die to be used for positive compressions, but also indicate the proper placement of the die on the connector. This is done by the bands of color on the connector which match the color on the dies. Compression is made between or on these color bands. The color name is also spelled on the connector as an added means of identification.

Thomas & Betts Dies Offer Inspection Capability.

Copper

Die located BETWEEN bands



Aluminum

Die located ON Bands



Color-Keyed® Connectors are banded by colored stripes or engraving to indicate location of die on connector for compression.

Dies that are used in Thomas & Betts hand and hydraulic tools contain the "die code" numbers which are engraved on the compression surface of the die. Under compression, this number becomes embossed on the completed connection for inspection purposes.

The inspector compares the die code number embossed on the connector with the die table to ensure that the proper connector was compressed with the correct die for that particular size conductor.



Connection by Compression

Quality Tooling with the Shure-Stake® Mechanism

T&B manual tools with the exclusive, Shure-Stake® mechanism take the guesswork out of making compression connections. The Shure-Stake® mechanism provides a full cycle compression stroke every time. Once the stroke has started, the tool will not release the connector until the proper amount of force has been applied. This is your assurance of a fully compressed connection. T&B compression tools develop uniform, controlled pressure to each connector within their size range. Thomas & Betts offers electric and battery-powered hydraulic pumps with a Shure-Stake® feature that guarantees a full cycle compression.



Color-Keyed® Compression



Battpac® LT Pump
The newest battery-powered hydraulic pump, rated for 10,000 PSI. Portable power for all T&B hydraulic heads, using just one Ni-MH 24V rechargeable battery.



TBM62BSCR
Single-handed battery-powered compression tool, features rotating head and comfortable balance. For connectors up to 500MCM CU, 350MCM AL.

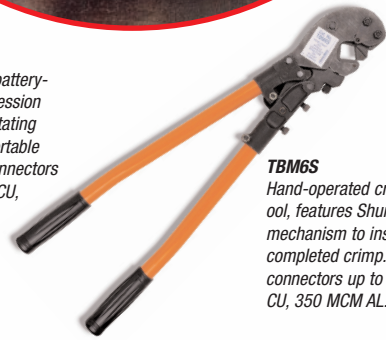

TBM6S
Hand-operated crimping tool, features Shure-Stake® mechanism to insure a completed crimp. For connectors up to 500 MCM CU, 350 MCM AL.

Thomas & Betts Method Components Meet Industry Standards.

Depending on the application, all Thomas & Betts copper connectors meet U.L. Std. 486A for code stranded and 24 gauge flex, CSA Std. C22.2, No. 65.600 V. requirements for power and U.L. Std. 467, CSA Std. 22.2 No. 0.4 requirements for direct buried grounding.

T&B method connectors are available in a range of sizes and styles to accommodate No. 8AWG through 1000 kcmil and larger copper or 2000 kcmil and larger aluminum cable. They may be compressed on cable with either manual or hydraulic tools. They are offered with standard length or long barrels, with one bolt or two bolt holes, or in two-way styles, for splicing applications. Two-way connectors are compact, providing high pullout values with low resistance.

Color-Keyed® two-hole lugs are ideal for bus bar applications that require two bolts to prevent lug rotation.

The T&B method is the most efficient, highest quality connection that has been engineered and delivers the best electrical performance and highest reliability.

T&B Compression Connectors eliminate risk of problems relating to loose connections when installed properly.

High Grade Materials Incorporated in Thomas & Betts Method

Low installed cost connections of superior quality can be achieved only through the use of high grade components. That is an important part of the T&B method — quality products you can depend on.

Copper Color-Keyed® connectors are made of high conductivity wrought copper, and are electro-tin plated to prevent corrosion and to improve conductivity. Thomas & Betts Color-Keyed® connectors offer the thickest tin-plating in the industry. Other copper connectors for heavy duty use and grid grounding applications are made of high conductivity cast copper, bright finished.

High conductivity cast aluminum connectors are available for heavy-duty application.

Color-Keyed® Connectors

Color-Keyed® Special Lugs for Special Problems — Angled, Shaped and Trimmed the Way You Need Them



Thomas & Betts can solve your difficult wire bending and terminating problems in confined power distribution panels, switchgear and motor control enclosures.

We have the design and production capability to deliver exactly the type lug you need, shaped the way you need.

- Straight, 45° and 90° angle
- Stacking or non-stacking
- Narrow tongue or standard
- Tin, silver, lead, nickel

Thomas & Betts offers an extensive line of copper Color-Keyed® lugs for #8 AWG through 1000 kcmil flex and code cables. The lug tongues are modified in several different configurations to meet your exact needs: 45° and 90° bend angles, narrow tongues to fit into circuit breakers, offset tongues to stack two cables, and special stud hole drilling. These special configurations let you:

- 1 run cable directly to the bus bar with no bending,
- 2 terminate into very narrow spaces, and
- 3 utilize minimal bus bar space.

The specially designed lugs help you “clean up” your cabling in crowded enclosures.

The photographs show some examples of how and where the lugs can be used.

Customized Color-Keyed® Connectors for Copper Cables

- Standard and special tongue angles, stacking and non-stacking, bolt holes sizes and centers, protective platings.
- Specially modified one and two hole copper Color-Keyed® compression lugs, Series 54100, 54200, 54850BE and 54930BE for flex and code copper stranded cables. Material high conductivity wrought copper.
- Minimum order quantity: Standard package quantity by cable size. Consult factory for price and delivery. All customized lugs are made to order. A.R.O. Non-cancelable.



Color-Keyed® Connectors

Order Form

Catalog No. _____ Qty. _____

(For 54100, 54200, 54800 & 54900 Series Copper Lugs Only)

Design Controls and Requirements

All "MADE-UP" catalog numbers start with a standard or basic catalog number and are followed by the customer-required extra features: tongue shape, bolt hole size, distance between bolt holes, stacking, plating and inspection hole (peep hole). A code letter or a number has been assigned to each extra feature. See CODE TABLE.

NOTES: 1) Lack of any of the extra features on the "MADE-UP" catalog number means that the standard Cat. No. features are prevalent.

2) If either bolt hole size or distance between bolt holes needs to be changed from standard Cat. No., both code numbers will appear on the "MADE-UP" Cat. No. (See example below)

CAT. NO. 54212UB0416BSP

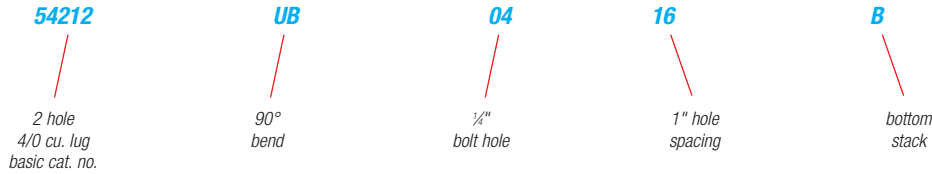

CODE TABLE

TONGUE SHAPE		BOLT HOLES		BOLT HOLE CENTERS		STACKING		FINISH (PLATING)		INSPECTION HOLE (LONG BARREL)		INSPECTION HOLE (SHORT BARREL)		
TYPE	CODE	SIZE	.020	CODE	DISTANCE .015	CODE	TYPE	CODE	TYPE 1	CODE	I.D.	CODE	I.D.	CODE
45°	UF	#8	.173	02	1/2"	08	Top	T**	Silver Plate	SP	Peep Hole	PH	Blind End	BE
90°	UB	#10	.204	03	5/8"	10	Bottom	B	Lead Plate	LP				
Blank	BT	1/4"	.281	04	3/4"	12			Nickel Plate	NP				
(No Bolt Hole)		5/16"	.344	05	7/8"	14			Plain Finish	PF				
		3/8"	.406	06	1"	16			No Marking	NM				
		1/2"	.531	08	1 1/8"	18			Not QTP if					
		5/8"	.656	10	1 1/4"	20			suffix other					
		3/4"	.812	12	1 3/8"	22			than - PF or					
		7/8"	.937	14	1 1/2"	24			standard					
		1"	1.062	16	1 5/8"	26			tin plate					
					1 3/4"	28								
					*1 7/8"	30								
					*2"	32								

* These bolt centers not available for bolt holes larger than 1 3/8".

** Not required for 45° & 90° Top Stacking.

Cable	Code <input type="checkbox"/>	
	Weld <input type="checkbox"/>	
<input type="checkbox"/> #8	<input type="checkbox"/> #6	<input type="checkbox"/> #4
<input type="checkbox"/> #2	<input type="checkbox"/> #1	<input type="checkbox"/> 1/0
<input type="checkbox"/> 2/0	<input type="checkbox"/> 3/0	<input type="checkbox"/> 4/0
<input type="checkbox"/> 250 kcmil & up (Code Only)		

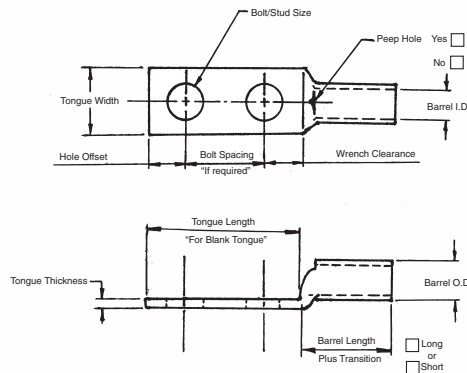

United States
Tel: 901.252.8000
800.816.7809
Fax: 901.252.1354

Canada
Tel: 450.347.5318
Fax: 450.347.1976

Technical Services
Tel: 888.862.3289

Thomas & Betts

www.tnb.com

Tongue Specifications — See Chart “A” For Dimensions

Stud Sizes		
<input type="checkbox"/> #8	<input type="checkbox"/> #10	<input type="checkbox"/> ¼"
<input type="checkbox"/> ⅝"	<input type="checkbox"/> ¾"	<input type="checkbox"/> ½"
<input type="checkbox"/> ⅜"	<input type="checkbox"/> ⅜"	<input type="checkbox"/> ⅜"
<input type="checkbox"/> 1"		

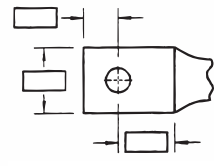

Single Hole

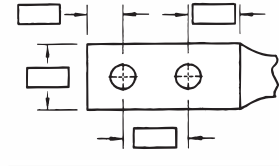

Double Hole

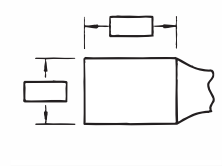

Blank

Chart A

NOMINAL BOLT HOLE SIZE .015	HOLE OFFSET .030	WRENCH CLEARANCE MIN.	TONGUE WIDTH CABLE SIZE										
			#8 CODE #8 WELD	#6 CODE #6 WELD	#4 CODE #4 WELD	#2 CODE #2 WELD	#1 CODE #1 WELD	1/0 CODE 1/0 WELD	2/0 CODE 2/0 WELD	3/0 CODE 3/0 WELD	4/0 CODE 4/0 WELD	250 CODE	
#8	.173	.200	.240	.406	.437	.562	.593	.672	.750	.825	.937	1.030	1.125
#10	.204	.218	.250	.406	.437	.562	.593	.672	.750	.825	.937	1.030	1.125
¼	.281	.250	.312	.469	.500	.562	.593	.672	.750	.825	.937	1.030	1.125
⅝	.344	.375	.406	.562	.562	.562	.675	.672	.750	.825	.937	1.030	1.125
⅜	.406	.375	.440	.578	.578	.594	.675	.672	.750	.825	.937	1.030	1.125
½	.531	.500	.562	—	—	—	.750	.750	.750	.825	.937	1.030	1.125
⅝	.656	.812	.875	—	—	—	—	—	—	—	.937	1.030	1.125
¾	.812	.750	.770	—	—	—	—	—	—	—	—	—	—
*⅞	.937	.875	.890	—	—	—	—	—	—	—	—	—	—
*1	1.062	.937	1.000	—	—	—	—	—	—	—	—	—	—

* These bolt holes available in one hole lug only.

Chart B

CABLE SIZE	TONGUE THICKNESS	STRAIGHT LUG BARREL LENGTH PLUS TRANSITION		BARREL		DIM "X" STACKED LUGS			DIM "Y"		DIM "H"	
		SHORT	LONG	O.D.	I.D.	STRAIGHT	45°	90°	SHORT	LONG	SHORT	LONG
#8	.080	.635	.935	.260	.180	.158	.478	.394	.595	.808	.779	1.079
#6	.081	.675	.975	.296	.215	.134	.544	.432	.587	.799	.767	1.067
#4	.099	.685	.985	.365	.266	.175	.622	.502	.637	.849	.838	1.138
#2	.108	.815	1.115	.410	.302	.216	.649	.535	.711	.923	.958	1.258
#1	.106	.825	1.275	.467	.361	.212	.731	.592	.710	1.028	.956	1.406
1/0	.125	.975	1.325	.520	.396	.250	.789	.646	.794	1.042	1.075	1.425
2/0	.125	.965	1.315	.571	.446	.250	.859	.696	.829	1.077	1.125	1.475
3/0	.125	1.085	1.435	.632	.507	.250	.946	.757	.900	1.148	1.225	1.575
4/0	.137	1.255	1.705	.701	.564	.274	1.031	.826	1.015	1.333	1.387	1.837
250	.137	1.375	1.925	.766	.629	.274	1.123	.891	1.085	1.474	1.487	2.037
300	.153	1.900	2.675	.850	.660	.459	1.226	.975	1.180	1.726	1.924	2.679
350	.177	2.090	2.896	.926	.720	.531	1.333	1.103	1.267	1.830	2.096	2.896
400	.173	2.460	2.980	.960	.757	.519	1.370	1.085	1.551	1.913	2.484	2.984
500	.218	2.670	3.610	1.100	.852	.654	1.514	1.225	1.629	2.266	2.669	3.619
600	.244	2.900	3.490	1.200	.926	.732	1.630	1.325	1.762	2.147	2.897	3.497
700	.228	2.784	-	1.255	.997	.684	1.662	1.375	1.780	—	3.011	—
750	.270	3.050	3.925	1.330	1.030	.810	1.745	1.455	1.827	2.434	3.050	3.925
800	.266	3.213	-	1.375	1.079	.800	1.728	1.625	1.952	2.787	3.213	4.554
900	.313	3.450	4.550	1.500	1.145	.940	1.900	1.650	2.065	—	1.387	—
1,000	.297	3.356	4.500	1.550	1.203	.890	2.070	1.675	2.031	2.787	1.487	4.506

NOTE: Stacking lugs are available for one bolt only.
 Consult Factory: Straight: 700 kcmil & up
 45°: 400 kcmil & up
 90°: 500 kcmil & up

Color-Keyed® Connectors

Tongue Specifications — See Chart “A” For Dimensions

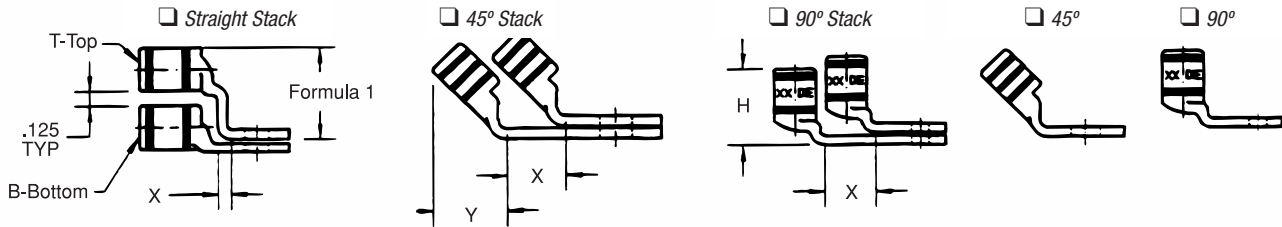

Formula 1 = (.125 + 2 (OD) + .037 – Tongue Thickness)

Chart C

BOLT HOLE SIZE	TONGUE WIDTH .030 CODE CABLE SIZE										
	300 KCMIL 4/0 WELD	350 KCMIL	400 KCMIL	500 KCMIL 400 WELD	600 KCMIL 500 WELD	1325/24	700 KCMIL	750 KCMIL	800 KCMIL	900 KCMIL	1000 KCMIL
#8	—	—	—	—	—	—	—	—	—	—	—
#10	—	—	—	—	—	—	—	—	—	—	—
¼	1.250	1.355	1.410	1.605	1.745	1.805	1.840	1.935	2.010	2.180	2.265
⅜	1.250	1.355	1.410	1.605	1.745	1.805	1.840	1.935	2.010	2.180	2.265
½	1.250	1.355	1.410	1.605	1.745	1.805	1.840	1.935	2.010	2.180	2.265
¾	1.250	1.355	1.410	1.605	1.745	1.805	1.840	1.935	2.010	2.180	2.265
¾	1.250	1.355	1.410	1.605	1.745	1.805	1.840	1.935	2.010	2.180	2.265
*¾	—	—	—	1.605	1.745	1.805	1.840	1.935	2.010	2.180	2.265
*1	—	—	—	—	1.745	1.805	1.840	1.935	2.010	2.180	2.265

Color-Keyed® Compression

Connectors for Copper Conductor

One-Hole Lugs — Standard Barrel 600V to 35KV

Material: High-Conductivity
Wrought Copper

Finish: Electro Tin Plate

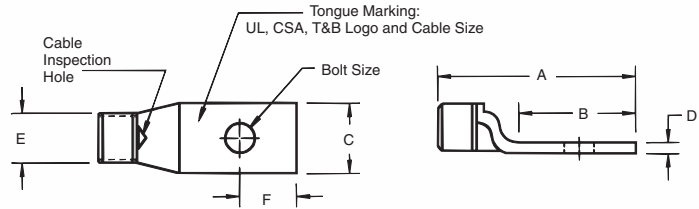

CAT. NO.	CODE	WIRE SIZE		DIMENSIONS (IN.)							DIE CODE	DIE COLOR
		FLEX CLASS G, H, I, K, M†	BOLT SIZE	A	B	C	D	E	F			
54101			¼	1.23	.56	.50	.05	.20	¼	ERG2002	YELLOW	
256-30695-1351	#14-10 AWG		#8	1.36	.68	.36	.05	.20	¼	ERG2002	YELLOW	
256-30695-1352			¼	1.36	.68	.41	.05	.20	¼	ERG2002	YELLOW	
256-30695-263			¼	1.69	.81	.50	.07	.20	¼	ERG2002	YELLOW	
54104			#10	1.16	.50	.39	.08	.25	⅜	21	RED	
54130	#8 AWG	23 Navy	¼	1.20	.61	.45	.07	.25	¼	21	RED	
54131		#8 Weld	⅝	1.33	.64	.56	.05	.25	⅝	21	RED	
54132		37/24 = 14.9 kcmil	⅝	1.33	.64	.56	.05	.25	⅝	21	RED	
256-30695-424			½	1.75	1.31	1.00	.13	.25	½	21	RED	
256-30695-1361			#12	1.23	.53	.44	.07	.31	⅜	24	BLUE	
54134	#6 AWG		#10	1.23	.53	.44	.07	.31	⅜	24	BLUE	
54105		#30 Navy	¼	1.23	.53	.44	.07	.31	⅜	24	BLUE	
54135		#6 Weld	⅝	1.41	.67	.60	.07	.31	⅝	24	BLUE	
54136		61/24 = 24.6 kcmil	⅝	1.41	.67	.60	.07	.31	⅝	24	BLUE	
256-30695-282		133/.014	⅝	1.41	.75	.56	.06	.31	⅝	24	BLUE	
256-30695-422			½	1.75	1.31	1.00	.13	.31	½	24	BLUE	
256-30695-1362			#12	1.38	.60	.55	.09	.37	¼	29	GRAY	
54138	#4 AWG		#10	1.38	.60	.55	.09	.37	¼	29	GRAY	
54106		40-50 Navy	¼	1.38	.60	.55	.09	.37	¼	29	GRAY	
54139		91/24 = 36.7 kcmil	⅝	1.42	.66	.61	.07	.37	⅝	29	GRAY	
54140		133/.0177	⅝	1.42	.66	.61	.07	.37	⅝	29	GRAY	
256-30695-233		49/.029	⅝	1.56	.75	.59	.06	.37	⅝	29	GRAY	
256-30695-264			½	2.20	1.40	1.00	.06	.37	½	29	GRAY	
54107	#2 AWG		¼	1.50	.65	.59	.11	.41	¼	33	BROWN	
54142-TB		#60 Navy	⅝	1.73	.88	.59	.11	.41	⅝	33	BROWN	
54143-TB		125/24 = 50.5 kcmil	⅝	1.65	.80	.59	.11	.41	⅝	33	BROWN	
54145-TB		#4 Weld	½	1.92	1.08	.75	.08	.41	½	33	BROWN	
54108	#1 AWG	75 Navy, #2 Weld	¼	1.50	.65	.68	.11	.47	¼	37	GREEN	
54147		150/24 = 60.5 kcmil	⅝	1.73	.93	.68	.11	.47	⅝	37	GREEN	
54148		175/24 = 70.6 kcmil	⅝	1.78	.98	.68	.11	.47	⅝	37	GREEN	
54150		133/.0223	½	2.10	1.25	.76	.11	.47	½	37	GREEN	
54152-TB			¼	1.60	.65	.75	.13	.52	¼	42	PINK	
54153-TB	1/0 AWG	#100 Navy	⅝	1.83	.88	.75	.13	.52	⅝	42	PINK	
54109		#1 Weld	⅝	1.88	.93	.75	.13	.52	⅝	42	PINK	
54155-TB		225/24 = 90.8 kcmil	½	2.20	1.25	.75	.13	.52	½	42	PINK	
256-30695-1383		133/.0254	⅝	2.54	1.50	.88	.13	.52	⅝	42	PINK	
54157	2/0 AWG	125 Navy	¼	1.65	.65	.83	.13	.57	¼	45	BLACK	
54158		1/0 Weld	⅝	1.88	.88	.83	.13	.57	⅝	45	BLACK	
54110		275/24 = 111 kcmil	⅝	1.93	.93	.83	.13	.57	⅝	45	BLACK	
54160		427/.0155	½	2.25	1.25	.83	.13	.57	½	45	BLACK	
256-30695-131			½	2.56	1.50	.83	.13	.57	½	45	BLACK	

† Contact Technical Services for specific stranding listings

Tooling: pp. B76-B92

Die Selector Chart: pp. B93-B95

Connectors for Copper Conductor

One-Hole Lugs — Standard Barrel 600V to 35KV (continued)

Material: High-Conductivity
Wrought Copper

Finish: Electro Tin Plate

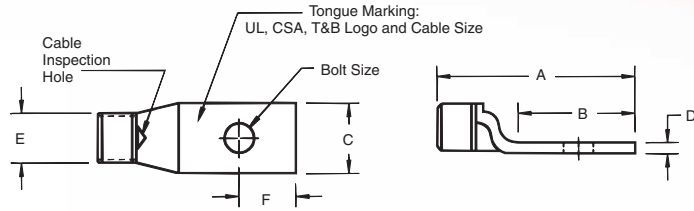

Color-Keyed Compression

CAT. NO.	CODE	WIRE SIZE		DIMENSIONS (IN.)							DIE CODE	DIE COLOR
		FLEX CLASS	G, H, I, K, M†	BOLT SIZE	A	B	C	D	E	F		
54162-TB		150 Navy, 2/0 Weld		¼	1.75	.65	.92	.13	.63	¼	50	ORANGE
54163-TB		325/24 = 131 kcmil		⅝	1.98	.88	.92	.13	.63	⅝	50	ORANGE
54111	3/0 AWG	133/.0316, 259/.0227		¾	2.03	.93	.92	.13	.63	¾	50	ORANGE
54165-TB		427/.0177		½	2.35	1.25	.92	.13	.63	½	50	ORANGE
54167		200 Navy		¼	1.90	.65	1.03	.14	.70	¼	54	PURPLE
54168		3/0 Weld		⅝	2.13	.87	1.03	.14	.70	⅝	54	PURPLE
54112	4/0 AWG	450/24 = 182 kcmil		¾	2.18	.93	1.03	.14	.70	¾	54	PURPLE
54170		703/.0154		½	2.50	1.25	1.03	.14	.70	½	54	PURPLE
256-30695-1174		4/0 Weld		¼	2.86	1.56	1.03	.14	.70	¼	54	PURPLE
58161		550/24 = 222 kcmil		⅝	2.23	.78	1.25	.15	.79	⅝	62	YELLOW
58162		133/.0399		¾	2.33	.88	1.25	.15	.79	¾	62	YELLOW
58163		259/.0286		½	2.38	.93	1.25	.15	.79	½	62	YELLOW
58165		637/.0183		¾	2.76	1.25	1.25	.15	.79	¾	62	YELLOW
58166				¾	3.03	1.58	1.25	.15	.79	¾	62	YELLOW
54172-TB		250 Navy		¼	2.00	.65	1.13	.14	.77	¼	62	YELLOW
54173	250 kcmil			⅝	2.23	.88	1.13	.14	.77	⅝	62	YELLOW
54174				¾	2.28	.93	1.13	.14	.77	¾	62	YELLOW
54113				½	2.60	1.25	1.13	.14	.77	½	62	YELLOW
58168		250 Weld, 650/24 = 262 kcmil, 259/.0311, 703/.0189		½	2.70	1.25	1.25	.15	.85	½	66	WHITE
54178				⅝	2.33	.88	1.25	.15	.85	⅝	66	WHITE
54179	300 kcmil	300 Navy		¾	2.43	.93	1.25	.15	.85	¾	66	WHITE
54114				½	2.70	1.25	1.25	.15	.85	½	66	WHITE
54181				¾	3.03	1.58	1.25	.15	.85	¾	66	WHITE
58171		300 Weld, 259/.034, 427/.0265, 889/.0183 775/24 = 313 kcmil		½	2.85	1.25	1.36	.18	.93	½	71	RED
256-30695-112				¾	2.90	1.25	1.36	.18	.93	¾	71	RED
54115	350 kcmil	350 Navy		½	2.85	1.25	1.36	.18	.93	½	71	RED
54183				¾	3.21	1.58	1.36	.18	.93	¾	71	RED
58174		350 Weld, 259/.0368, 427/.0285, 703/.0224, 889/.0201		½	3.35	1.25	1.61	.22	1.09	½	76	BLUE
54116	400 kcmil	400 Navy		¾	3.20	1.25	1.41	.17	.96	¾	76	BLUE
54185				¾	3.53	1.58	1.41	.17	.96	¾	76	BLUE

† Contact Technical Services for specific stranding listings

Tooling: pp. B76–B92

Die Selector Chart: pp. B93–B95

Connectors for Copper Conductor

One-Hole Lugs — Standard Barrel 600V to 35KV (continued)

Material: High-Conductivity Wrought Copper

Finish: Electro Tin Plate

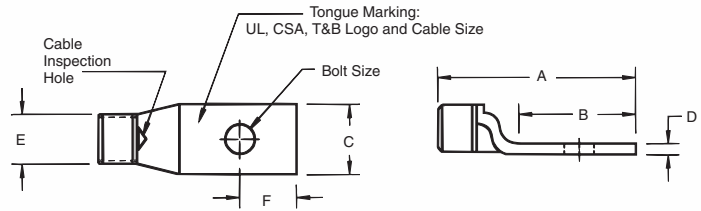

CAT. NO.	WIRE SIZE			DIMENSIONS (IN.)						DIE CODE	DIE COLOR	
	CODE	FLEX CLASS G, H, I, K, M†	BOLT SIZE	A	B	C	D	E	F			
256-30695-1403 58177		400 Weld										
		925/24 = 373 kcmil	3/8	3.31	1.31	1.61	.22	1.04	5/8	80	N/A	
		259/.0393 or 427/.0306	1/2	3.31	1.25	1.61	.22	1.04	1/2	80	N/A	
256-30695-339 54118 54187			3/8	3.10	1.00	1.61	.22	1.10	3/8	87	BROWN	
	500 kcmil	500 Navy	1/2	3.30	1.25	1.61	.22	1.10	1/2	87	BROWN	
			3/8	3.63	1.58	1.61	.22	1.10	5/8	87	BROWN	
58180		1100/24 = 444 kcmil, 500 Weld, 259/.0417, 427/.0325, 703/.0253	3/8	3.79	1.58	1.75	.24	1.20	5/8	94	GREEN	
	256-30695-1370 54120	600 kcmil	1/2	3.65	1.44	1.75	.24	1.20	3/4	94	GREEN GREEN	
54122-TB	700 kcmil		3/8	3.68	1.58	1.84	.23	1.26	5/8	99	PINK	
256-30695-1404			3/8	3.29	1.29	1.81	.28	1.25	21/32	99	PINK	
256-30695-1405		1325/24 = 535 kcmil	1/2	3.29	1.29	1.81	.28	1.25	21/32	99	PINK	
256-30695-840		427/.0342	1/2	4.00	1.69	1.81	.28	1.25	31/64	99	PINK	
58182			3/8	3.83	1.58	1.81	.28	1.25	5/8	99	PINK	
256-30695-193 54123-TB	750 kcmil		1/2	4.00	1.69	1.94	.27	1.33	31/64	106	BLACK	
58184		1600/24 = 646 kcmil	3/8	3.80	1.58	1.94	.27	1.33	5/8	106	BLACK	
54124-TB	800 kcmil	800 Navy	3/8	4.04	1.58	2.01	.27	1.38	5/8	107	ORANGE	
256-30695-843 54126	900 kcmil	1925/24 = 777 kcmil	1/2	4.31	1.81	2.17	.31	1.50	7/8	115	YELLOW	
54128			3/8	4.15	1.58	2.17	.31	1.50	5/8	115	YELLOW	
	1000 kcmil	1000 Navy	3/8	4.09	1.58	2.27	.30	1.55	5/8	125	N/A	

† Contact Technical Services for specific stranding listings

Tooling: pp. B76-B92

Die Selector Chart: pp. B93-B95

NOTE: Angled Lugs can be readily available as: 15°, 30°, 45°, 60°, and 90°

Connectors for Copper Conductor

One-Hole Lugs — 45° Standard Barrel 600V to 35KV

Material: High-Conductivity
Wrought Copper

Finish: Electro Tin Plate

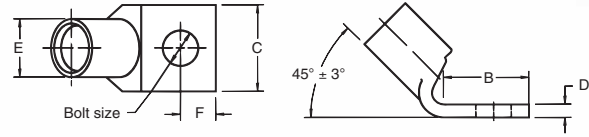

Color-Keyed Compression

CAT. NO.	CODE	WIRE SIZE		DIMENSIONS (IN.)							DIE CODE	DIE COLOR
		FLEX CLASS	G, H, I, K, M†	BOLT SIZE	B	C	D	E	F			
54104UF	#8 AWG	23 Navy		#10	.50	.39	.08	.25	1/2	21	RED	
54130UF		#8 Weld		1/4	.61	.45	.07	.25	1/4	21	RED	
54131UF				5/16	.64	.56	.05	.25	3/2	21	RED	
54132UF		37/24 = 14.9 kcmil		3/8	.64	.56	.05	.25	3/2	21	RED	
54134UF	#6 AWG	30 Navy		#10	.53	.44	.07	.31	1/2	24	BLUE	
54105UF		#6 Weld		1/4	.53	.44	.07	.31	1/2	24	BLUE	
54135UF		61/24 = 24.6 kcmil		5/16	.67	.60	.07	.31	3/16	24	BLUE	
54136UF		133/.014		3/8	.67	.60	.07	.31	3/16	24	BLUE	
54138UF	#4 AWG	40-50 Navy		#10	.60	.55	.09	.37	1/4	29	GRAY	
54106UF				1/4	.60	.55	.09	.37	1/4	29	GRAY	
54139UF		91/24 = 36.7 kcmil		5/16	.66	.61	.07	.37	3/16	29	GRAY	
54140UF		133/.0177		3/8	.66	.61	.07	.37	3/16	29	GRAY	
256-30695-264UF		49/.029		1/2	1.40	1.00	.06	.37	1/2	29	GRAY	
54107UF	#2 AWG	60 Navy		1/4	.65	.59	.11	.41	1/4	33	BROWN	
54142UF				5/16	.88	.59	.11	.41	3/8	33	BROWN	
54143UF		125/24 = 50.4 kcmil		3/8	.80	.59	.11	.41	3/8	33	BROWN	
54145UF		#4 Weld		1/2	1.08	.75	.08	.41	1/2	33	BROWN	
54108UF	#1 AWG	75 Navy, #2 Weld		1/4	.65	.68	.11	.47	1/4	37	GREEN	
54147UF				5/16	.93	.68	.11	.47	3/8	37	GREEN	
54148UF		150/24 = 60.5 kcmil		3/8	.98	.68	.11	.47	3/8	37	GREEN	
54150UF		175/24 = 70.6 kcmil		1/2	1.25	.76	.11	.47	1/2	37	GREEN	
54152UF	1/0 AWG	100 Navy		1/4	.65	.75	.13	.52	1/4	42	PINK	
54153UF				5/16	.88	.75	.13	.52	3/8	42	PINK	
54109UF		225/24 = 90.8 kcmil		3/8	.93	.75	.13	.52	3/8	42	PINK	
54155UF		133/.0254		1/2	1.25	.75	.13	.52	1/2	42	PINK	
54157UF	2/0 AWG	125 Navy		1/4	.65	.83	.13	.57	1/4	45	BLACK	
54158UF				5/16	.88	.83	.13	.57	3/8	45	BLACK	
54110UF		275/24 = 111 kcmil		3/8	.93	.83	.13	.57	3/8	45	BLACK	
54160UF		427/.0155, 133/.0282		1/2	1.25	.83	.13	.57	1/2	45	BLACK	
54162UF	3/0 AWG	150 Navy, 2/0 Weld		1/4	.65	.92	.13	.63	1/4	50	ORANGE	
54163UF				5/16	.88	.92	.13	.63	3/8	50	ORANGE	
54111UF		325/24 = 131 kcmil		3/8	.93	.92	.13	.63	3/8	50	ORANGE	
54165UF		133/.0316, 259/.0227		1/2	1.25	.92	.13	.63	1/2	50	ORANGE	
54167UF	4/0 AWG	200 Navy		1/4	.65	1.03	.14	.70	1/4	54	PURPLE	
54168UF				5/16	.87	1.03	.14	.70	3/8	54	PURPLE	
54112UF		450/24 = 182 kcmil		3/8	.93	1.03	.14	.70	3/8	54	PURPLE	
54170UF		703/.0154		1/2	1.25	1.03	.14	.70	1/2	54	PURPLE	
58161UF	58162UF	4/0 Weld		1/4	.78	1.25	.15	.79	3/8	62	YELLOW	
58162UF				5/16	.88	1.25	.15	.79	3/8	62	YELLOW	
58163UF		550/24 = 222 kcmil		3/8	.93	1.25	.15	.79	3/8	62	YELLOW	
58165UF		133/.0399		1/2	1.25	1.25	.15	.79	1/2	62	YELLOW	
58166UF		259/.0286		3/8	.93	1.25	.15	.79	3/8	62	YELLOW	
		637/.0183		1/2	1.58	1.25	.15	.79	3/8	62	YELLOW	

† Contact Technical Services for specific stranding listings

Tooling: pp. B76-B92 Die Selector Chart: pp. B93-B95

United States
Tel: 901.252.8000
800.816.7809
Fax: 901.252.1354

Canada
Tel: 450.347.5318
Fax: 450.347.1976

Technical Services
Tel: 888.862.3289

Thomas & Betts

www.tnb.com

Connectors for Copper Conductor

One-Hole Lugs — 45° Standard Barrel 600V to 35KV (continued)

Material: High-Conductivity
Wrought Copper

Finish: Electro Tin Plate

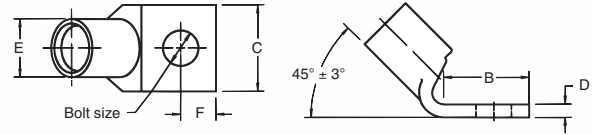

CAT. NO.	CODE	WIRE SIZE		BOLT SIZE	DIMENSIONS (IN.)					DIE CODE	DIE COLOR
		FLEX CLASS	G, H, I, K, M†		B	C	D	E	F		
54172UF				¼	.65	1.13	.14	.77	¼	62	YELLOW
54173UF				⅜	.88	1.13	.14	.77	⅜	62	YELLOW
54174UF	250 kcmil	250 Navy		⅜	.93	1.13	.14	.77	⅜	62	YELLOW
54113UF				½	1.25	1.13	.14	.77	½	62	YELLOW
58168UF		250 Weld, 650/24 = 262 kcmil, 259/.0311, 703/.0189		½	1.25	1.25	.15	.85	½	66	WHITE
54178UF				⅜	.88	1.25	.15	.85	⅜	66	WHITE
54179UF				⅜	.93	1.25	.15	.85	⅜	66	WHITE
54114UF	300 kcmil	300 Navy		½	1.25	1.25	.15	.85	½	66	WHITE
54181UF				⅝	1.58	1.25	.15	.85	⅝	66	WHITE
58171UF		300 Weld, 259/.034, 427/.0265, 889/.0183 775/24 = 313 kcmil		½	1.25	1.36	.18	.93	½	71	RED
256-30695-112UF				⅜	1.25	1.36	.18	.93	½	71	RED
54115UF	350 kcmil	350 Navy		½	1.25	1.36	.18	.93	½	71	RED
54183UF				⅝	1.58	1.36	.18	.93	⅝	71	RED
58174UF		350 Weld, 259/.0368, 427/.0285, 703/.0224, 889/.0201		½	1.25	1.61	.22	1.09	½	76	BLUE
54116UF				½	1.25	1.41	.17	.96	½	76	BLUE
54185UF	400 kcmil	400 Navy		⅝	1.58	1.41	.17	.96	⅝	76	BLUE
256-30695-1403UF		400 Weld		⅜	1.31	1.61	.22	1.04	⅜	80	N/A
58177UF		925/24 = 373 kcmil		½	1.25	1.61	.22	1.04	½	80	N/A
54118UF				½	1.25	1.61	.22	1.10	½	87	BROWN
54187UF	500 kcmil	500 Navy		⅝	1.58	1.61	.22	1.10	⅝	87	BROWN
58180UF		1100/24 = 444 kcmil, 500 Weld, 259/.0417, 427/.0325, 703/.0253		⅝	1.58	1.75	.24	1.20	½	94	GREEN
54120UF	600 kcmil			⅝	1.58	1.75	.24	1.20	½	94	GREEN
54122UF	700 kcmil			⅝	1.58	1.84	.23	1.26	½	99	PINK
256-30695-840UF		1325/24 = 535 kcmil		½	1.69	1.81	.28	1.25	⅞	99	PINK
58182UF		427/.0342		⅝	1.58	1.81	.28	1.25	⅝	99	PINK
54123UF	750 kcmil			⅝	1.58	1.94	.27	1.33	⅝	106	BLACK
58184UF		1600/24 = 646 kcmil		⅝	1.58	1.94	.27	1.33	⅝	106	BLACK
54124UF	800 kcmil	800 Navy		⅝	1.58	2.01	.27	1.38	⅝	107	ORANGE
54126UF	900 kcmil	1925/24 = 777 kcmil		⅝	1.58	2.17	.31	1.50	⅝	115	YELLOW
54128UF	1000 kcmil	1000 Navy		⅝	1.58	2.27	.30	1.55	⅝	125	N/A

† Contact Technical Services for specific stranding listings

Tooling: pp. B76-B92

Die Selector Chart: pp. B93-B95

Connectors for Copper Conductor

One-Hole Lugs — 90° Standard Barrel 600V to 35KV

Material: High-Conductivity
Wrought Copper

Finish: Electro Tin Plate

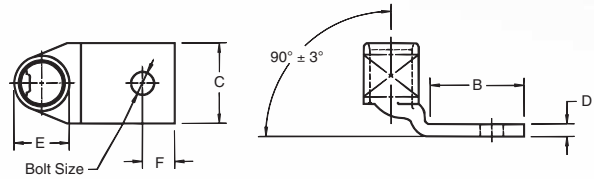

Color-Keyed Compression

CAT. NO.	CODE	WIRE SIZE		DIMENSIONS (IN.)					DIE CODE	DIE COLOR
		FLEX CLASS G, H, I, K, M†	BOLT SIZE	B	C	D	E	F		
54104UB			#10	.50	.39	.08	.25	1/2	21	RED
54130UB	#8 AWG	23 Navy	1/4	.61	.45	.07	.25	1/4	21	RED
54131UB		#8 Weld	5/16	.64	.56	.05	.25	1/2	21	RED
54132UB		37/24 = 14.9 kcmil	3/8	.64	.56	.05	.25	1/2	21	RED
54134UB	#6 AWG	30 Navy	#10	.53	.44	.07	.31	1/2	24	BLUE
54105UB		#6 Weld	1/4	.53	.44	.07	.31	1/2	24	BLUE
54135UB		61/24 = 24.6 kcmil	5/16	.67	.60	.07	.31	1/16	24	BLUE
54136UB		133/.014	3/8	.67	.60	.07	.31	1/16	24	BLUE
54138UB	#4 AWG	40-50 Navy	#10	.60	.55	.09	.37	1/4	29	GRAY
54106UB			1/4	.60	.55	.09	.37	1/4	29	GRAY
54139UB		91/24 = 36.7 kcmil	5/16	.66	.61	.07	.37	1/16	29	GRAY
54140UB		133/.0177	3/8	.66	.61	.07	.37	1/16	29	GRAY
256-30695-264UB		49/.029	1/2	1.40	1.00	.06	.37	1/2	29	GRAY
54107UB	#2 AWG	60 Navy	1/4	.65	.59	.11	.41	1/4	33	BROWN
54142UB		125/24 = 50.4 kcmil	5/16	.88	.59	.11	.41	1/8	33	BROWN
54143UB		#4 Weld	3/8	.80	.59	.11	.41	1/8	33	BROWN
54145UB			1/2	1.08	.75	.08	.41	1/2	33	BROWN
54108UB	#1 AWG	75 Navy, #2 Weld	1/4	.65	.68	.11	.47	1/4	37	GREEN
54147UB		150/24 = 60.5 kcmil	5/16	.93	.68	.11	.47	1/8	37	GREEN
54148UB		175/24 = 70.6 kcmil	3/8	.98	.68	.11	.47	1/8	37	GREEN
54150UB		133/.0223	1/2	1.25	.76	.11	.47	1/2	37	GREEN
54152UB	1/0 AWG	100 Navy	1/4	.65	.75	.13	.52	1/4	42	PINK
54153UB		#1 Weld	5/16	.88	.75	.13	.52	1/8	42	PINK
54109UB		225/24 = 90.8 kcmil	3/8	.93	.75	.13	.52	1/8	42	PINK
54155UB		133/.0254	1/2	1.25	.75	.13	.52	1/2	42	PINK
54157UB	2/0 AWG	125 Navy	1/4	.65	.83	.13	.57	1/4	45	BLACK
54158UB		1/0 Weld	5/16	.88	.83	.13	.57	1/8	45	BLACK
54110UB		275/24 = 111 kcmil	3/8	.93	.83	.13	.57	1/8	45	BLACK
54160UB		427/.0155, 133/.0282	1/2	1.25	.83	.13	.57	1/2	45	BLACK
54162UB	3/0 AWG	150 Navy, 2/0 Weld	1/4	.65	.92	.13	.63	1/4	50	ORANGE
54163UB		325/24 = 131 kcmil	5/16	.88	.92	.13	.63	1/8	50	ORANGE
54111UB		133/.0316, 259/.0227	3/8	.93	.92	.13	.63	1/8	50	ORANGE
54165UB		427/.0177	1/2	1.25	.92	.13	.63	1/2	50	ORANGE
54167UB	4/0 AWG	200 Navy	1/4	.65	1.03	.14	.70	1/4	54	PURPLE
54168UB		3/0 Weld	5/16	.87	1.03	.14	.70	1/8	54	PURPLE
54112UB		450/24 = 182 kcmil	3/8	.93	1.03	.14	.70	1/8	54	PURPLE
54170UB		703/.0154	1/2	1.25	1.03	.14	.70	1/2	54	PURPLE
58161UB	58162UB	4/0 Weld	1/4	.78	1.25	.15	.79	1/8	62	YELLOW
58162UB		550/24 = 222 kcmil	5/16	.88	1.25	.15	.79	1/8	62	YELLOW
58163UB		133/.0399	3/8	.93	1.25	.15	.79	1/8	62	YELLOW
58165UB		259/.0286	1/2	1.25	1.25	.15	.79	1/2	62	YELLOW
58166UB		637/.0183	3/4	1.58	1.25	.15	.79	1/2	62	YELLOW

† Contact Technical Services for specific stranding listings

Tooling: pp. B76-B92 Die Selector Chart: pp. B93-B95

United States
Tel: 901.252.8000
800.816.7809
Fax: 901.252.1354

Canada
Tel: 450.347.5318
Fax: 450.347.1976

Technical Services
Tel: 888.862.3289

Thomas & Betts

www.tnb.com

Connectors for Copper Conductor

One-Hole Lugs — 90° Standard Barrel 600V to 35KV (continued)

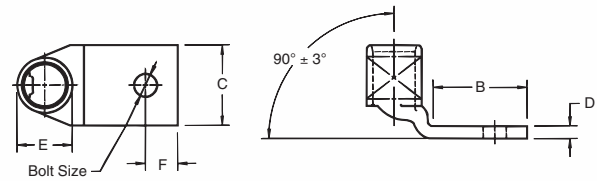

Material: High-Conductivity
Wrought Copper

Finish: Electro Tin Plate



CAT. NO.	WIRE SIZE		BOLT SIZE	DIMENSIONS (IN.)					DIE CODE	DIE COLOR
	CODE	FLEX CLASS G, H, I, K, M†		B	C	D	E	F		
54172UB	250 kcmil	250 Navy	¼	.65	1.13	.14	.77	¼	62	YELLOW
54173UB			⅝	.88	1.13	.14	.77	⅝	62	YELLOW
54174UB			¾	.93	1.13	.14	.77	¾	62	YELLOW
54113UB			1	1.25	1.13	.14	.77	1	62	YELLOW
58168UB		250 Weld, 650/24 = 262 kcmil, 259/.0311, 703/.0189	½	1.25	1.25	.15	.85	½	66	WHITE
54178UB	300 kcmil	300 Navy	⅝	.88	1.25	.15	.85	⅝	66	WHITE
54179UB			¾	.93	1.25	.15	.85	¾	66	WHITE
54114UB			1	1.25	1.25	.15	.85	1	66	WHITE
54181UB			1 ½	1.58	1.25	.15	.85	1 ½	66	WHITE
58171UB		300 Weld, 259/.034, 427/.0265, 889/.0183 775/24 = 313 kcmil	½	1.25	1.36	.18	.93	½	71	RED
256-30695-112UB	350 kcmil	350 Navy	¾	1.25	1.36	.18	.93	¾	71	RED
54115UB			1	1.25	1.36	.18	.93	1	71	RED
54183UB			1 ½	1.58	1.36	.18	.93	1 ½	71	RED
58174UB		350 Weld, 259/.0368, 427/.0285, 703/.0224, 889/.0201	½	1.25	1.61	.22	1.09	½	76	BLUE
54116UB	400 kcmil	400 Navy	¾	1.25	1.41	.17	.96	¾	76	BLUE
54185UB			1	1.58	1.41	.17	.96	1	76	BLUE
256-30695-1403UB	500 kcmil	400 Weld, 925/24 = 373 kcmil 259/.0393, 427/.0306	¾	1.31	1.61	.22	1.04	¾	80	N/A
58177UB			1	1.25	1.61	.22	1.04	1	80	N/A
54118UB	500 kcmil	500 Navy	¾	1.25	1.61	.22	1.10	¾	87	BROWN
54187UB			1	1.58	1.61	.22	1.10	1	87	BROWN
58180UB		1100/24 = 444 kcmil, 500 Weld, 259/.0417, 427/.0325, 703/.0253	¾	1.58	1.75	.24	1.20	¾	94	GREEN
54120UB	600 kcmil		¾	1.58	1.75	.24	1.20	¾	94	GREEN
54122UB	700 kcmil		¾	1.58	1.84	.23	1.26	¾	99	PINK
256-30695-840UB	750 kcmil	1325/24 = 535 kcmil 427/.0342	¾	1.69	1.81	.28	1.25	13/16	99	PINK
58182UB			1	1.58	1.81	.28	1.25	1	99	PINK
54123UB	750 kcmil	1600/24 = 646 kcmil	¾	1.58	1.94	.27	1.33	¾	106	BLACK
58184UB			1	1.58	1.94	.27	1.33	1	106	BLACK
54124UB	800 kcmil	800 Navy	¾	1.58	2.01	.27	1.38	¾	107	ORANGE
54126UB	900 kcmil	1925/24 = 777 kcmil	¾	1.58	2.17	.31	1.50	¾	115	YELLOW
54128UB	1000 kcmil	1000 Navy	¾	1.58	2.27	.30	1.55	¾	125	N/A

† Contact Technical Services for specific stranding listings

Tooling: pp. B76-B92

Die Selector Chart: pp. B93-B95

Connectors for Copper Conductor

Two-Hole Lugs — Standard Barrel 600V to 35KV

Material: High-Conductivity Wrought Copper

Finish: Electro Tin Plate

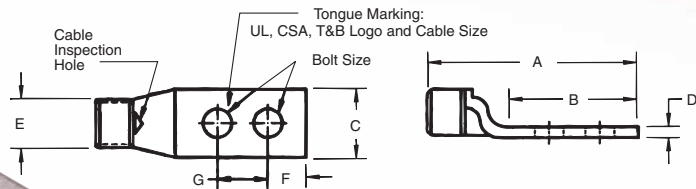

CAT. NO.	CODE	WIRE SIZE		DIMENSIONS (IN.)								DIE CODE	DIE COLOR
		FLEX CLASS G, H, I, K, M†	BOLT SIZE	A	B	C	D	E	F	G			
54201	#14-10 AWG		¼	1.86	1.19	.50	.05	.20	¼	¾	ERG2002	YELLOW	
256-30695-1302			¾	2.48	1.81	.56	.04	.22	¾	1	ERG2002	YELLOW	
54204	8 AWG		#10	1.88	1.18	.42	.08	.26	¼	¾	21	RED	
256-31426-33*			#10	1.88	1.18	.41	.06	.26	½	¾	21	RED	
256-31426-33PH		23 Navy	#10	1.88	1.18	.41	.06	.26	½	¾	21	RED	
542040410		#8 Weld	¼	2.01	1.31	.42	.08	.26	¼	¾	21	RED	
542040416		37/24 = 14.9 kcmil	¼	2.38	1.68	.42	.08	.26	¼	1	21	RED	
256-30695-1094			¼	2.50	1.81	.56	.05	.26	¼	¾	21	RED	
256-30695-251			¾	2.50	1.81	.56	.05	.26	¾	1	21	RED	
256-30695-1070			#12	1.81	1.19	.44	.11	.30	¼	½-¾	24	BLUE	
256-30695-1153			#10	1.98	1.28	.44	.08	.30	¼	½	24	BLUE	
256-30695-1183			#10	1.98	1.19	.44	.08	.30	½	¾-¾	24	BLUE	
54205	#6 AWG	30 Navy	¼	1.98	1.28	.44	.08	.30	¼	¾	24	BLUE	
256-30695-1095		#6 Weld	¼	2.13	1.31	.43	.08	.30	¼	¾	24	BLUE	
256-30695-252		61/24 = 24.6 kcmil	¼	2.38	1.63	.43	.08	.30	¼	1	24	BLUE	
256-30695-372		133/.014	¼	2.13	1.43	.43	.08	.30	¼	¾	24	BLUE	
256-30695-913			¼	2.38	1.75	.43	.08	.30	¼	1	24	BLUE	
256-30695-253			¾	2.58	1.81	.55	.08	.30	¾	1	24	BLUE	
54206		#4 AWG	40-50 Navy	¼	2.03	1.28	.52	.10	.37	¼	¾	29	GRAY
256-30695-1184			91/24 = 36.7 kcmil	¾	2.31	1.63	.52	.10	.37	¾	1	29	GRAY
256-30695-255			133/.0177, 49/.029	¾	2.56	1.81	.59	.09	.37	¾	1	29	GRAY
54207		#2 AWG		¼	2.13	1.28	.59	.11	.41	¼	¾	33	BROWN
256-30695-1355	60 Navy		¼	2.15	1.31	.59	.13	.41	¼	¾	33	BROWN	
256-30695-1185	125/24 = 50.4 kcmil		¼	2.38	1.53	.59	.11	.41	¼	1	33	BROWN	
256-30695-257	#4 Weld		¾	2.67	1.81	.60	.1	.41	¾	1	33	BROWN	
256-30695-1049			¼	3.75	2.88	.75	.09	.41	¾	1¼	33	BROWN	
54208	#1 AWG		75 Navy	¼	2.13	1.28	.68	.11	.47	¼	¾	37	GREEN
256-30695-1233		150/24 = 60.5 kcmil	¾	2.69	1.62	.69	.13	.47	½	1	37	GREEN	
256-30695-1236		175/24 = 70.6 kcmil, 133/.0223	¾	2.75	1.81	.68	.11	.47	¾	1	37	GREEN	
256-30695-329	1/0 AWG		¼	2.75	1.81	.75	.14	.52	¾	¾	42	PINK	
54255		100 Navy	¾	2.56	1.56	.75	.14	.52	¾	¾	42	PINK	
256-30695-1234		#1 Weld	¾	2.75	1.78	.75	.14	.52	¾	1	42	PINK	
54209		225/24 = 90.8 kcmil	¾	2.88	1.93	.75	.13	.52	¾	1	42	PINK	
256-30695-1265		133/.0254	¾	3.50	2.57	.75	.14	.52	¾	1¼	42	PINK	
256-30695-886			½	3.78	2.83	.75	.13	.52	½	1¼	42	PINK	
256-30695-1175	2/0 AWG	125 Navy	¼	2.45	1.44	.83	.14	.57	¼	¾	45	BLACK	
54261		1/0 Weld	¾	2.70	1.63	.83	.14	.57	¾	¾	45	BLACK	
256-30695-832		275/24 = 111 kcmil	¾	2.88	1.81	.81	.14	.57	¾	1	45	BLACK	
54210		133/.0282	¾	2.93	1.93	.83	.13	.57	¾	1	45	BLACK	
54260			½	3.83	2.81	.83	.14	.57	¾	1¼	45	BLACK	
54266		150 Navy, 2/0 Weld	¾	2.88	1.75	.94	.14	.63	½	1	50	ORANGE	
54211	3/0 AWG	325/24 = 131 kcmil	¾	2.94	1.81	.94	.14	.63	¾	1	50	ORANGE	
54265		133/.0316, 259/.0227, 427/.0177	½	3.94	2.81	.94	.14	.63	½	1¼	50	ORANGE	

† Contact Technical Services for specific stranding listings

Tooling: pp. B76-B92

Die Selector Chart: pp. B93-B95

* Blind End

Color-Keyed Compression

United States
Tel: 901.252.8000
800.816.7809
Fax: 901.252.1354

Canada
Tel: 450.347.5318
Fax: 450.347.1976

Technical Services
Tel: 888.862.3289

Thomas & Betts

www.tnb.com

Connectors for Copper Conductor

Two-Hole Lugs — Standard Barrel 600V to 35KV (continued)

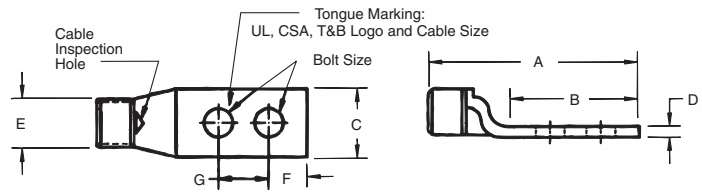

Material: High-Conductivity Wrought Copper

Finish: Electro Tin Plate



Color-Keyed Compression

CAT. NO.	WIRE SIZE		BOLT SIZE	DIMENSIONS (IN.)								DIE CODE	DIE COLOR
	CODE	FLEX CLASS G, H, I, K, M†		A	B	C	D	E	F	G			
54212			3/8	3.18	1.93	1.03	.14	.70	3/8	1	54	PURPLE	
54270		200 Navy	1/2	4.25	3.00	1.03	.14	.70	1/2	1 1/4	54	PURPLE	
256-30695-1247	4/0 AWG	3/0 Weld	1/4	3.06	1.44	1.03	.16	.70	3/8	3/8	54	PURPLE	
256-30695-331		450/24 = 182 kcmil	1/4	3.06	1.81	1.03	.14	.70	3/8	3/8	54	PURPLE	
256-30695-1261		703/.0154	5/16	3.18	1.93	1.03	.14	.70	3/8	1	54	PURPLE	
54213	250 kcmil	250 Navy	3/8	3.28	1.93	1.13	.14	.77	3/8	1	62	YELLOW	
54275			1/2	4.19	2.81	1.13	.18	.77	1/2	1 1/4	62	YELLOW	
256-30695-345		4/0 Weld	3/8	3.25	1.69	1.25	.15	.79	3/8	7/8	62	YELLOW	
256-30695-835		550/24 = 222 kcmil	3/8	4.25	2.80	1.25	.15	.79	3/8	1	62	YELLOW	
256-30695-452		133/.0399	3/8	3.13	1.88	1.25	.16	.79	3/8	3/8	62	YELLOW	
58265		259/.0286, 637/.018	1/2	3.94	2.81	.94	.14	.79	1/2	1 1/4	62	YELLOW	
54214	300 kcmil	300 Navy	3/8	3.45	1.93	1.25	.15	.85	3/8	1	66	WHITE	
54280			1/2	4.45	3.00	1.25	.15	.85	1/2	1 1/4	66	WHITE	
256-30695-332			1/4	3.40	1.81	1.36	.18	.93	3/8	3/8	71	RED	
256-30695-1240			5/16	4.18	2.63	1.36	.18	.93	3/8	1 1/4	71	RED	
54215	350 kcmil	350 Navy	3/8	3.51	1.93	1.36	.18	.93	3/8	1	71	RED	
54282			1/2	4.60	3.00	1.36	.18	.93	1/2	1 1/4	71	RED	
54216	400 kcmil		3/8	3.93	1.93	1.41	.17	.96	3/8	1	76	BLUE	
54283			3/8	3.88	1.93	1.41	.17	.96	3/8	1 1/8	76	BLUE	
256-30695-439		400 Weld	3/8	4.35	2.25	1.61	.22	1.04	3/8	1	80	N/A	
58277		925/24 = 373 kcmil	1/2	5.06	3.00	1.61	.22	1.04	1/2	1 1/4	80	N/A	
256-30695-839		259/.0393, 427/.0306	3/8	4.09	2.06	1.61	.22	1.04	3/8	1	80	N/A	
54218			3/8	3.96	1.93	1.61	.22	1.10	3/8	1	87	BROWN	
54286	500 kcmil	500 Navy	1/2	5.07	3.00	1.61	.22	1.10	1/2	1 1/4	87	BROWN	
256-30695-188			1/2	4.06	2.31	1.63	.22	1.10	3/8	1 1/4	87	BROWN	
54220			3/8	4.13	1.93	1.75	.24	1.20	3/8	1	94	GREEN	
54289	600 kcmil	1100/24 = 444 kcmil	1/2	5.23	3.00	1.75	.24	1.20	1/2	1 1/4	94	GREEN	
256-30695-1406			3/8	4.05	2.11	1.78	.24	1.25	3/8	1	99	PINK	
256-30695-842			3/8	4.30	2.06	1.80	.28	1.25	3/8	1	99	PINK	
256-30695-898	700 kcmil	1325/24 = 535 kcmil	3/8	4.30	2.06	1.80	.28	1.25	3/8	1	99	PINK	
54291			1/2	5.18	3.00	1.84	.23	1.25	1/2	1 1/4	99	PINK	
58281		535, 1325/24	1/2	5.23	3.00	1.80	.28	1.25	3/8	1 1/4	99	PINK	
256-30695-237			3/8	5.10	2.80	1.94	.27	1.33	3/8	1	106	BLACK	
54223	750 kcmil		1/2	5.32	3.00	1.94	.27	1.33	1/2	1 1/4	106	BLACK	
256-30695-1376			3/8	4.78	2.28	2.01	.27	1.38	7/16	1 1/8	107	ORANGE	
54224	800 kcmil		1/2	5.50	3.00	2.01	.27	1.38	1/2	1 1/4	107	ORANGE	
256-30695-694			3/8	4.65	2.06	2.18	.31	1.50	3/8	1	115	YELLOW	
54226			1/2	5.59	3.00	2.18	.31	1.50	3/8	1 1/4	115	YELLOW	
256-30695-846	900 kcmil	1925/24 = 777 kcmil	3/8	4.60	2.06	2.12	.31	1.50	3/8	1	115	YELLOW	
256-30695-844			3/8	5.00	2.63	2.18	.31	1.50	7/16	1 1/2	115	YELLOW	
54228	1000 kcmil	1000 Navy	1/2	5.45	3.00	2.27	.30	1.55	3/8	1 1/4	125	N/A	

† Contact Technical Services for specific stranding listings

Tooling: pp. B76-B92 Die Selector Chart: pp. B93-B95

Connectors for Copper Conductor

Two-Hole Lugs — 45° Standard Barrel 600V to 35KV

Material: High-Conductivity
Wrought Copper

Finish: Electro Tin Plate

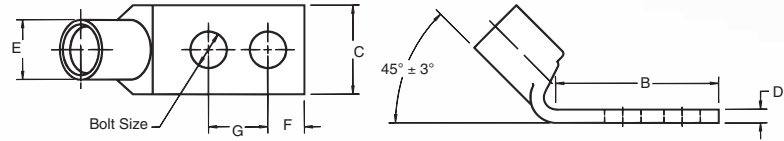
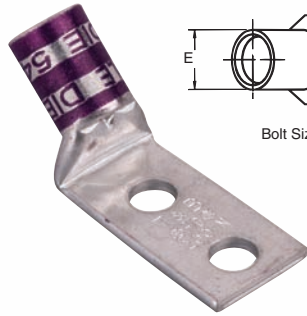

CAT. NO.	WIRE SIZE			DIMENSIONS (IN.)						DIE CODE	DIE COLOR	
	CODE	FLEX CLASS G, H, I, K, M†	BOLT SIZE	B	C	D	E	F	G			
256-31426-9	#14-10 AWG		#10	1.22	.37	.05	.200	¼	⅝	N/A	N/A	
54204UF	#8 AWG	23 Navy	#8 Weld	#10	1.18	.42	.08	.26	¼	⅝	21	RED
		37/24 = 14.9 kcmil										
256-30695-1183UF	#6 AWG	30 Navy, #6 Weld	#6 Weld	#10	1.19	.44	.08	.30	⅜	⅝-¾	24	BLUE
54205UF		61/24 = 24.6 kcmil										
54205UF0416		133/.014										
54206UF	#4 AWG	40-50 Navy	#4 Weld	¼	1.28	.52	.10	.37	¼	⅝	29	GRAY
		91/24 = 36.7 kcmil										
54207UF	#2 AWG	133/.0177, 49/.029	#2 Weld	¾	1.28	.59	.11	.41	¼	⅝	33	BROWN
256-30695-257UF		125/24 = 50.4 kcmil										
54208UF		#1 AWG										
	150/24 = 60.5 kcmil											
54209UF	1/0 AWG	175/24 = 70.6 kcmil, 133/.0223	#1 Weld	¾	1.93	.75	.13	.52	¾	1	42	PINK
54209UF0412		100 Navy										
54261UF		2/0 AWG										
	133/.0254											
	54210UF		125 Navy, 1/0 Weld									
54260UF	3/0 AWG	275/24 = 111 kcmil	#3 Weld	½	1.63	.83	.14	.57	½	⅞	45	BLACK
54266UF		133/.0282										
		54211UF										
54265UF	4/0 AWG	325/24 = 131 kcmil	#4 Weld	¾	1.75	.94	.14	.63	½	1	50	ORANGE
54212UF		133/.0316										
		54270UF										
54213UF	250 kcmil	427/.0177	#5 Weld	½	2.81	.94	.14	.63	½	1½	50	ORANGE
54275UF		200 Navy										
		256-30695-399UF										
58265UF	250 kcmil	450/24 = 182 kcmil	#6 Weld	½	3.00	1.03	.14	.70	½	1½	54	PURPLE
58265UF		703/.0154										
54213UF	250 kcmil	250 Navy	#6 Weld	½	1.93	1.13	.14	.77	¾	1	62	YELLOW
54275UF		4/0 Weld										
256-30695-399UF	250 kcmil	550/24 = 222 kcmil	#6 Weld	¾	2.80	1.25	.15	.79	¾	1	62	YELLOW
58265UF		133/.0399, 259/.0286										
58265UF		637/.018		½	2.81	.94	.14	.79	½	1½	62	YELLOW

† Contact Technical Services for specific stranding listings

Tooling: pp. B76–B92

Die Selector Chart: pp. B93–B95

Color-Keyed Compression

Connectors for Copper Conductor

Two-Hole Lugs — 45° Standard Barrel 600V to 35KV (continued)

Material: High-Conductivity Wrought Copper

Finish: Electro Tin Plate

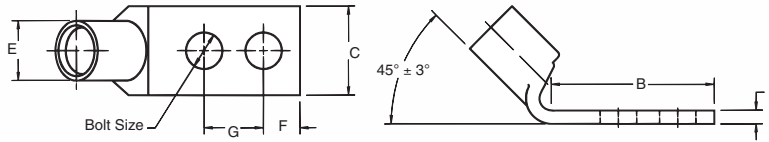

CAT. NO.	WIRE SIZE			DIMENSIONS (IN.)						DIE CODE	DIE COLOR
	CODE	FLEX CLASS G, H, I, K, M†	BOLT SIZE	B	C	D	E	F	G		
54214UF	300 kcmil	300 Navy	3/8	1.93	1.25	.15	.85	3/8	1	66	WHITE
54280UF			1/2	3.00	1.25	.15	.85	1/2	1 1/4	66	WHITE
54215UF	350 kcmil	350 Navy	3/8	1.93	1.36	.18	.93	3/8	1	71	RED
54282UF			1/2	3.00	1.36	.18	.93	1/2	1 1/4	71	RED
54216UF	400 kcmil		3/8	1.93	1.41	.17	.96	3/8	1	76	BLUE
54283UF			1/2	1.93	1.41	.17	.96	3/8	1 1/16	76	BLUE
58277UF		400 Weld 925/24 = 373 kcmil 259/.0393, 427/.0306	1/2	3.00	1.61	.22	1.04	1/2	1 1/4	80	N/A
54218UF	500 kcmil	500 Navy	3/8	1.93	1.61	.22	1.10	3/8	1	87	BROWN
54286UF			1/2	3.00	1.61	.22	1.10	1/2	1 1/4	87	BROWN
54220UF	600 kcmil	1100/24 = 444 kcmil	3/8	1.93	1.75	.24	1.20	3/8	1	94	GREEN
54289UF			1/2	3.00	1.75	.24	1.20	1/2	1 1/4	94	GREEN
54291UF	700 kcmil	1325/24 = 535 kcmil	1/2	3.00	1.84	.23	1.25	1/2	1 1/4	99	PINK
58281UF			1/2	3.00	1.8	.28	1.25	1/2	1 1/4	99	PINK
256-30695-237UF	750 kcmil		3/8	2.80	1.94	.27	1.33	3/8	1	106	BLACK
54223UF			1/2	3.00	1.94	.27	1.33	1/2	1 1/4	106	BLACK
54224UF	800 kcmil		1/2	3.00	2.01	.27	1.38	1/2	1 1/4	106	BLACK
54226UF	900 kcmil	1925/24 = 777 kcmil	1/2	3.00	2.18	.31	1.50	1/2	1 1/4	115	YELLOW
54228UF	1000 kcmil	1000 Navy	1/2	3.00	2.27	.30	1.55	1/2	1 1/4	125	N/A

† Contact Technical Services for specific stranding listings

Tooling: pp. B76-B92

Die Selector Chart: pp. B93-B95

NOTE: Angled Lugs can be readily available as: 15°, 30°, 45°, 60°, and 90°

Connectors for Copper Conductor

Two-Hole Lugs — 90° Standard Barrel 600V to 35KV Applications

Material: High-Conductivity Wrought Copper

Finish: Electro Tin Plate

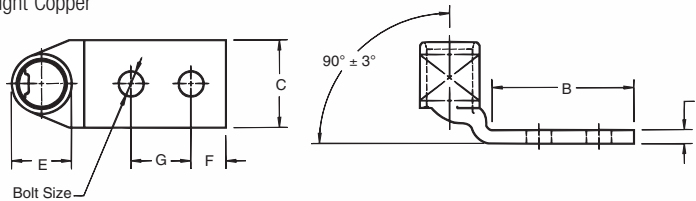

Color-Keyed Compression

CAT. NO.	CODE	WIRE SIZE		DIMENSIONS (IN.)						DIE CODE	DIE COLOR															
		FLEX CLASS	G, H, I, K, M†	BOLT SIZE	B	C	D	E	F			G														
256-31426-141	#14-10 AWG			#10	1.25	.37	.07	.20	7/32	3/8	ERG2002	YELLOW														
256-31426-6SPH				#10	1.30	.37	.07	.20	7/32	5/8-3/4	ERG2002	YELLOW														
256-31426-6				#10	1.30	.37	.07	.20	7/32	3/8	ERG2002	YELLOW														
256-31426-6S				#10	1.30	.37	.07	.20	7/32	5/8-3/4	ERG2002	YELLOW														
256-30695-1409	#8 AWG	23 Navy, #8 Weld	37/24 = 14.9 kcmil	#10	1.19	.41	.06	.26	7/32	5/8-3/4	21	RED														
54204UB				#10	1.25	.42	.08	.26	1/4	3/8	21	RED														
256-31426-33UB*				#10	1.19	.41	.06	.26	7/32	5/8-3/4	21	RED														
256-31426-33UBPH				#10	1.19	.41	.06	.26	7/32	5/8-3/4	21	RED														
256-30695-1411	#6 AWG	30 Navy	#6 Weld	#10	1.19	.44	.08	.30	7/32	5/8-3/4	24	BLUE														
256-30695-1183B				#10	1.19	.44	.08	.30	7/32	5/8-3/4	24	BLUE														
256-30695-1356				#10	1.19	.43	.08	.30	7/32	3/8	24	BLUE														
54205UB				133/.014	1/4	1.28	.44	.08	.30	1/4	3/8	24	BLUE													
256-30695-252UB	#4 AWG	40-50 Navy	91/24 = 36.7 kcmil	133/.0177, 49/.029	1/4	1.28	.52	.10	.37	1/4	3/8	29	GRAY													
54206UB																										
54207UB														#2 AWG	60 Navy	#4 Weld	125/24 = 50.4 kcmil	1/4	1.28	.59	.11	.41	1/4	3/8	33	BROWN
54208UB	#1 AWG	75 Navy	150/24 = 60.5 kcmil	175/24 = 70.6 kcmil, 133/.0223	1/4	1.28	.68	.11	.47	1/4	3/8	37	GREEN													
54209UB	1/0 AWG	100 Navy, #1 Weld	225/24 = 90.8 kcmil, 133/.0254	225/24 = 90.8 kcmil, 133/.0254	3/8	1.93	.75	.13	.52	3/8	1	42	PINK													
54209UB0412					1/4	1.55	.75	.13	.52	1/4	3/4	42	PINK													
54261UB	2/0 AWG	125 Navy, 1/0 Weld	275/24 = 111 kcmil	133/.0282	5/16	1.63	.83	.14	.57	1/2	3/8	45	BLACK													
54210UB					3/8	1.93	.83	.13	.57	3/8	1	45	BLACK													
54260UB					1/2	2.81	.83	.14	.57	3/8	1 1/4	45	BLACK													
54266UB					150 Navy, 2/0 Weld	5/16	1.75	.94	.14	.63	1/2	1	50	ORANGE												
54211UB	3/0 AWG	325/24 = 131 kcmil	133/.0316, 259/.0227, 427/.0177	1/2	2.81	.94	.14	.63	3/8	1 1/4	50	ORANGE														
54265UB																										
54212UB	4/0 AWG	200 Navy, 3/0 Weld	450/24 = 182 kcmil, 703/.0154	1/2	3.00	1.03	.14	.70	3/8	1	54	PURPLE														
54270UB																										
54213UB	250 kcmil	250 Navy		3/8	1.93	1.13	.14	.77	3/8	1	62	YELLOW														
54275UB													1/2	2.81	1.13	.18	.77	1/2	1 1/4	62	YELLOW					
256-30695-399UB	58265UB	4/0 Weld, 550/24 = 222 kcmil	133/.0399, 259/.0286, 637/.018	3/8	2.80	1.25	.15	.79	3/8	1	62	YELLOW														
58265UB													1/2	2.81	.94	.14	.79	1/2	1 1/4	62	YELLOW					

† Contact Technical Services for specific stranding listings

Tooling: pp. B76-B92

Die Selector Chart: pp. B93-B95

* Blind End

Connectors for Copper Conductor

Two-Hole Lugs — 90° Standard Barrel 600V to 35KV Applications (continued)

Material: High-Conductivity Wrought Copper

Finish: Electro Tin Plate

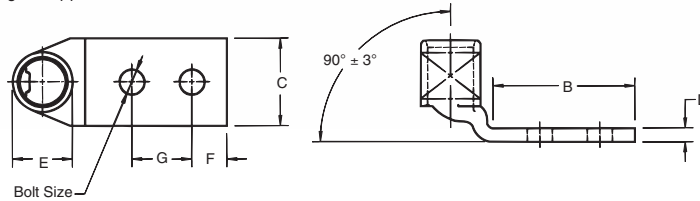

CAT. NO.	CODE	WIRE SIZE		DIMENSIONS (IN.)							DIE CODE	DIE COLOR
		FLEX CLASS G, H, I, K, M†	BOLT SIZE	B	C	D	E	F	G			
54214UB			3/8	1.93	1.25	.15	.85	3/8	1	66	WHITE	
54280UB	300 kcmil	300 Navy	1/2	3.00	1.25	.15	.85	1/2	1 1/4	66	WHITE	
54215UB			3/8	1.93	1.36	.18	.93	3/8	1	71	RED	
54282UB	350 kcmil	350 Navy	1/2	3.00	1.36	.18	.93	1/2	1 1/4	71	RED	
54216UB			3/8	1.93	1.41	.17	.96	3/8	1	76	BLUE	
54283UB	400 kcmil		3/8	1.93	1.41	.17	.96	3/8	1 1/6	76	BLUE	
58277UB		400 Weld, 925/24 = 373 kcmil 259/.0393, 427/.0306	1/2	3.00	1.61	.22	1.04	1/2	1 1/4	80	N/A	
54218UB	500 kcmil	500 Navy	3/8	1.93	1.61	.22	1.10	3/8	1	87	BROWN	
54286UB			1/2	3.00	1.61	.22	1.10	1/2	1 1/4	87	BROWN	
256-30695-1221B			3/8		1.61	.22	1.10	3/8	1	87	BROWN	
54220UB	600 kcmil	1100/24 = 444 kcmil	3/8	1.93	1.75	.24	1.20	3/8	1	94	GREEN	
54289UB			1/2	3.00	1.75	.24	1.20	1/2	1 1/4	94	GREEN	
54291UB	700 kcmil	1325/24 = 535 kcmil	1/2	3.00	1.84	.23	1.25	1/2	1 1/4	99	PINK	
58281UB			1/2	3.00	1.80	.28	1.25	1/2	1 1/4	99	PINK	
54223UB	750 kcmil		1/2	3.00	1.94	.27	1.33	1/2	1 1/4	106	BLACK	
54224UB	800 kcmil		1/2	3.00	2.01	.27	1.38	1/2	1 1/4	106	BLACK	
54226UB	900 kcmil	1925/24 = 777 kcmil	1/2	3.00	2.18	.31	1.50	1/2	1 1/4	115	YELLOW	
54228UB	1000 kcmil	1000 Navy	1/2	3.00	2.27	.30	1.55	1/2	1 1/4	125	N/A	

† Contact Technical Services for specific stranding listings

Tooling: pp. B76–B92

Die Selector Chart: pp. B93–B95

Connectors for Copper Conductor

Ideal for confined-space terminations.

Narrow-Tongue Lugs — One-Hole, Standard Barrel 600V Applications

To meet increasing demand for smaller components in today's panels and switchgear, Thomas & Betts introduces a new line of Color-Keyed® Narrow-Tongue Lugs. These improved lugs have been precision engineered for consistency in width the entire length of the connector, from barrel to tongue, ensuring a reliable fit in confined-space applications.

- Narrow-width tongue and barrel, engineered for dimensional consistency the entire length of the lug
- Perfect for connections in limited-space applications
- High-conductivity copper alloy construction
- Electro-tin-plated finish resists corrosion
- T&B Color-Keyed® marking system makes connections and verification easy
- Double-chamfered barrel eases insertion of wire
- Available in one-hole versions now — two-hole and angled lugs coming soon

..... **Specifications**

- Material: 99% pure high conductivity seamless wrought copper
- Finish: Electro-tin plated
- Standards: UL Listed, CSA Certified, RoHS compliant

NEW!

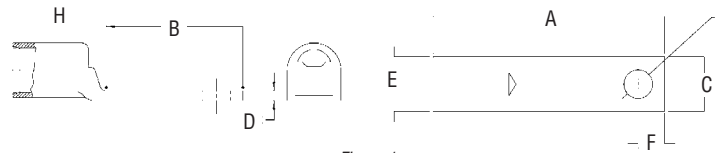

Figure 1

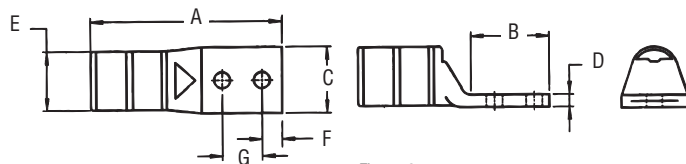

Figure 2



CAT. NO.	CODE	WIRE SIZE FLEX CLASS G, H, I, K, M†	BOLT SIZE	DIMENSIONS (IN.)						DIE CODE	STD. PKG. QTY.	DIE COLOR
				A	B	C	D	E	F			
54138NT	#4 AWG	91/24	#10	1.312	.562	.365	.099	.365	.250	29	50/500	GRAY
54107NT	#2-3 AWG	125/24	¼	1.500	.650	.410	.070	.410	.250	33	25/250	BROWN
54108NT	#1 AWG	150,175/24	¼	1.500	.650	.467	.106	.467	.250	37	20/200	GREEN
54152NT	1/0 AWG	225/24	¼	1.600	.650	.521	.125	.521	.250	42	10/100	PINK
54157NT	2/0 AWG	275/24	¼	1.600	.650	.571	.125	.571	.250	45	10/100	BLACK
54162NT	3/0 AWG	325/24	¼	1.680	.650	.632	.125	.632	.250	50	10/100	ORANGE
54167NT	4/0 AWG	450/24	¼	1.900	.650	.701	.137	.701	.250	54	10/100	PURPLE
54172NT	250 kcmil	550/24	¼	2.000	.650	.766	.140	.766	.250	62	10/100	YELLOW
54178NT04	300 kcmil	775/24	¼	2.325	.875	.850	.153	.850	.250	66	10/100	WHITE
54115NT	350 kcmil	—	½	2.750	1.250	.926	.177	.926	.500	71	10/100	RED
54115NT06	350 kcmil	—	¾	2.500	1.000	.926	.177	.926	.375	71	10/100	RED
54118NT	500 kcmil	925/24	½	3.250	1.250	1.100	.218	1.100	.500	87	6/60	BROWN
54123NT08	750 kcmil	1325/24	½	3.475	1.250	1.330	.270	1.330	.500	106	6/60	BLACK
54123NT	750 kcmil	1325/24	¾	3.800	1.575	1.330	.270	1.330	.625	106	6/60	BLACK
54879NT	750 kcmil	—	¾	5.00	2.02	1.66	.27	1.33	½	1	106	BLACK
58825NT	900 kcmil	—	¾	5.00	2.13	1.66	.31	1.50	½	1	115	YELLOW
58825NT0828	900 kcmil	1925/24 = 777 kcmil	¾	5.75	2.88	1.66	.31	1.50	½	1½	115	YELLOW

† Contact Technical Services for specific stranding listings

Tooling: pp. B76-B92 Die Selector Chart: pp. B93-B95

United States
Tel: 901.252.8000
800.816.7809
Fax: 901.252.1354

Canada
Tel: 450.347.5318
Fax: 450.347.1976

Technical Services
Tel: 888.862.3289

Thomas & Betts

www.tnb.com

Connectors for Copper Conductor

One-Hole Lugs — Long Barrel 600V to 35KV

Material: High-Conductivity
Wrought Copper

Finish: Electro Tin Plate

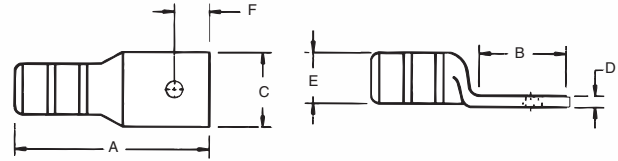

Peep Holes Available!
Add suffix **-PH**



Color-Keyed® Compression

CAT. NO.	CODE	WIRE SIZE		DIMENSIONS (IN.)						DIE CODE	DIE COLOR
		FLEX CLASS G, H, I, K, M†	BOLT SIZE	A	B	C	D	E	F		
54901BE	#14-10 AWG		¼	1.23	.56	.50	.05	.20	¼	ERG2002	N/A
54929BE			#10	1.65	.65	.42	.08	.26	¼	21	RED
54930BE	#8 AWG	37/24 = 14.9 kcmil	¼	1.65	.65	.42	.08	.26	¼	21	RED
54904BE	#6 AWG	61/24 = 24.6 kcmil	#10	1.65	.65	.44	.08	.30	¼	24	BLUE
54905BE			¼	1.65	.65	.44	.08	.30	¼	24	BLUE
54908BE			#10	1.70	.65	.52	.10	.37	¼	29	GRAY
54906BE	#4 AWG	91/24 = 36.7 kcmil	¼	1.70	.65	.52	.10	.37	¼	29	GRAY
54933BE	#2-3 AWG	125/24 = 50.4 kcmil	#10	1.88	.65	.59	.11	.41	¼	33	BROWN
54942BE			⅝	2.03	.88	.59	.11	.41	⅝	33	BROWN
54945BE			#10	1.95	.65	.68	.11	.47	¼	37	GREEN
54947BE	#1 AWG	150/24 = 60.5 kcmil	⅝	2.18	.88	.68	.11	.47	⅝	37	GREEN
54946BE			#10	1.95	.65	.75	.13	.52	¼	42	PINK
54949BE			⅝	2.18	.88	.75	.13	.52	⅝	42	PINK
54909BE	1/0 AWG	225/24 = 90.8 kcmil	¾	2.23	.93	.75	.13	.52	¾	42	PINK
54950BE			½	2.55	1.25	.75	.13	.52	½	42	PINK
54910BE			¾	2.28	.93	.83	.13	.57	¾	45	BLACK
54951BE	2/0 AWG	275/24 = 111 kcmil	¾	2.60	1.25	.83	.13	.57	¾	45	BLACK
54965BE	3/0 AWG	325/24 = 131 kcmil	½	2.70	1.25	.92	.13	.63	½	50	ORANGE
256-30695-1252			¼	2.35	.65	1.03	.14	.70	¼	54	PURPLE
256-30695-1253	4/0 AWG	450/24 = 182 kcmil	¾	2.95	1.25	1.03	.14	.70	¾	54	PURPLE
54970BE		3/0 Weld	¾	2.95	1.25	1.03	.14	.70	¾	54	PURPLE
54913BE	250 kcmil	550/24 = 222 kcmil, 4/0 Weld	½	3.15	1.25	1.13	.14	.77	½	62	YELLOW
54914BE	300 kcmil	250	½	3.50	1.25	1.25	.15	.85	½	66	WHITE
54915BE	350 kcmil	650/24 = 262 kcmil	½	3.68	1.25	1.36	.18	.93	½	71	RED
54916BE			½	3.75	1.25	1.41	.17	.96	½	76	BLUE
54917BE	400 kcmil	775/24 = 313 kcmil	¾	4.03	1.58	1.41	.17	.96	¾	76	BLUE
54918BE	500 kcmil	925/24 = 373 kcmil	½	4.25	1.25	1.61	.22	1.10	½	87	BROWN
54919BE			¾	4.57	1.58	1.61	.22	1.10	¾	87	BROWN
54921BE			¾	4.10	1.25	1.75	.24	1.20	¾	94	GREEN
54920BE	600 kcmil	1100/24 = 444 kcmil	¾	4.39	1.58	1.75	.24	1.20	¾	94	GREEN
54979BE		1325/24 = 535 kcmil	½	4.40	1.25	1.80	.24	1.25	½	99	PINK
54922BE	750 kcmil	1325/24 = 535 kcmil	¾	4.40	1.25	1.94	.27	1.33	¾	106	BLACK
54923BE			¾	4.72	1.58	1.94	.27	1.33	¾	106	BLACK
58984BE		1600/24 = 646 kcmil	¾	4.73	1.58	1.94	.27	1.33	¾	106	BLACK
58926BE	900 kcmil	1925/24 = 777 kcmil	¾	5.23	1.58	2.17	.310	1.50	¾	115	YELLOW
54928BE			¾	5.24	1.58	2.27	.30	1.55	¾	125	N/A
256-30695-918	1000 kcmil		¾	5.42	1.82	2.37	.30	1.55	¾	125	N/A

† Contact Technical Services for specific stranding listings

Tooling: pp. B76-B92

Die Selector Chart: pp. B93-B95

Connectors for Copper Conductor

One-Hole Lugs — 45° Long Barrel 600V to 35KV

Material: High-Conductivity
Wrought Copper

Finish: Electro Tin Plate

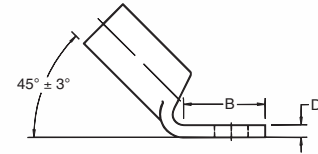
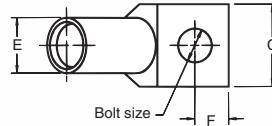

Color-Keyed Compression

CAT. NO.	WIRE SIZE			DIMENSIONS (IN.)					DIE CODE	DIE COLOR
	CODE	FLEX CLASS G, H, I, K, M†	BOLT SIZE	B	C	D	E	F		
54929BEUF			#10	.65	.42	.08	.26	¼	21	RED
54930BEUF	#8 AWG	37/24 = 14.9 kcmil	¼	.65	.42	.08	.26	¼	21	RED
54904BEUF	#6 AWG	61/24 = 24.6 kcmil	#10	.65	.44	.08	.30	¼	24	BLUE
54905BEUF			¼	.65	.44	.08	.30	¼	24	BLUE
54908BEUF			#10	.65	.52	.10	.37	¼	29	GRAY
54906BEUF	#4 AWG	91/24 = 36.7 kcmil	¼	.65	.52	.10	.37	¼	29	GRAY
54933BEUF	#2-3 AWG	125/24 = 50.4 kcmil	#10	.65	.59	.11	.41	¼	33	BROWN
54942BEUF			⅝	.88	.59	.11	.41	⅝	33	BROWN
54945BEUF			#10	.65	.68	.11	.47	¼	37	GREEN
54947BEUF	#1 AWG	150/24 = 60.5 kcmil	⅝	.88	.68	.11	.47	⅝	37	GREEN
54946BEUF			#10	.65	.75	.13	.52	¼	42	PINK
54949BEUF			⅝	.88	.75	.13	.52	⅝	42	PINK
54909BEUF	1/0 AWG	225/24 = 90.8 kcmil	⅝	.93	.75	.13	.52	⅝	42	PINK
54950BEUF			½	1.25	.75	.13	.52	½	42	PINK
54910BEUF			⅝	.93	.83	.13	.57	⅝	45	BLACK
54951BEUF	2/0 AWG	275/24 = 111 kcmil	½	1.25	.83	.13	.57	½	45	BLACK
54965BEUF	3/0 AWG	325/24 = 131 kcmil	½	1.25	.92	.13	.63	½	50	ORANGE
54970BEUF04			¼	1.00	1.03	.14	.70	¼	54	PURPLE
54970BEUF06	4/0 AWG	450/24 = 182 kcmil	⅝	1.13	1.03	.14	.70	⅝	54	PURPLE
54970BEUF		3/0 Weld	½	1.25	1.03	.14	.70	½	54	PURPLE
54913BEUF	250 kcmil	550/24 = 222 kcmil, 4/0 Weld	½	1.25	1.13	.14	.77	½	62	YELLOW
54914BEUF	300 kcmil	250	½	1.25	1.25	.15	.85	½	66	WHITE
54915BEUF	350 kcmil	650/24 = 262 kcmil	½	1.25	1.36	.18	.93	½	71	RED
54916BEUF			½	1.25	1.41	.17	.96	½	76	BLUE
54917BEUF	400 kcmil	775/24 = 313 kcmil	⅝	1.58	1.41	.17	.96	⅝	76	BLUE
54918BEUF	500 kcmil	925/24 = 373 kcmil	½	1.25	1.61	.22	1.10	½	87	BROWN
54919BEUF			⅝	1.58	1.61	.22	1.10	⅝	87	BROWN
54921BEUF			½	1.25	1.75	.24	1.20	½	94	GREEN
54920BEUF	600 kcmil	1100/24 = 444 kcmil	⅝	1.58	1.75	.24	1.20	⅝	94	GREEN
54922BEUF	750 kcmil	1325/24 = 535 kcmil	½	1.25	1.94	.27	1.33	½	106	BLACK
54923BEUF			⅝	1.58	1.94	.27	1.33	⅝	106	BLACK
58984BEUF		1600/24 = 646 kcmil	⅝	1.58	1.94	.27	1.33	⅝	106	BLACK
58926BEUF	900 kcmil	1925/24 = 777 kcmil	⅝	1.58	2.17	.31	1.50	⅝	115	YELLOW
54928BEUF			⅝	1.58	2.27	.30	1.55	⅝	125	N/A
54928BEUF12	1000 kcmil		⅝	1.83	2.37	.30	1.55	⅝	125	N/A

† Contact Technical Services for specific stranding listings

Tooling: pp. B76–B92

Die Selector Chart: pp. B93–B95

Connectors for Copper Conductor

One-Hole Lugs — 90° Long Barrel 600V to 35KV

Material: High-Conductivity
Wrought Copper

Finish: Electro Tin Plate

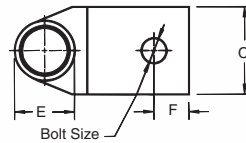

Peep Holes Available!
Add suffix -PH

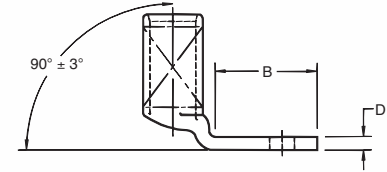

Color-Keyed® Compression

CAT. NO.	CODE	WIRE SIZE		DIMENSIONS (IN.)					DIE CODE	DIE COLOR
		FLEX CLASS G, H, I, K, M†	BOLT SIZE	B	C	D	E	F		
549298EUB			#10	.65	.42	.08	.26	¼	21	RED
549308EUB	#8 AWG	37/24 = 14.9 kcmil	¼	.65	.42	.08	.26	¼	21	RED
549048EUB	#6 AWG	61/24 = 24.6 kcmil	#10	.65	.44	.08	.30	¼	24	BLUE
549058EUB			¼	.65	.44	.08	.30	¼	24	BLUE
549088EUB			#10	.65	.52	.10	.37	¼	29	GRAY
549068EUB	#4 AWG	91/24 = 36.7 kcmil	¼	.65	.52	.10	.37	¼	29	GRAY
549338EUB	#2-3 AWG	125/24 = 50.4 kcmil	#10	.65	.59	.11	.41	¼	33	BROWN
549428EUB			⅝	.88	.59	.11	.41	¾	33	BROWN
549458EUB			#10	.65	.68	.11	.47	¼	37	GREEN
549478EUB	#1 AWG	150/24 = 60.5 kcmil	⅝	.88	.68	.11	.47	¾	37	GREEN
549468EUB			#10	.65	.75	.13	.52	¼	42	PINK
549498EUB	1/0 AWG	225/24 = 90.8 kcmil	⅝	.88	.75	.13	.52	¾	42	PINK
549098EUB			¾	.93	.75	.13	.52	¾	42	PINK
549508EUB			½	1.25	.75	.13	.52	½	42	PINK
549108EUB			¾	.93	.83	.13	.57	¾	45	BLACK
549518EUB	2/0 AWG	275/24 = 111 kcmil	½	1.25	.83	.13	.57	½	45	BLACK
549658EUB	3/0 AWG	325/24 = 131 kcmil	½	1.25	.92	.13	.63	½	50	ORANGE
549708EUB04			¼	1.00	1.03	.14	.70	¼	54	BLACK
549708EUB06	4/0 AWG	450/24 = 182 kcmil	¾	1.13	1.03	.14	.70	¾	54	BLACK
549708EUB		3/0 Weld	½	1.25	1.03	.14	.70	½	54	BLACK
549138EUB	250 kcmil	550/24 = 222 kcmil, 4/0 Weld	½	1.25	1.13	.14	.77	½	62	YELLOW
549148EUB	300 kcmil	250	½	1.25	1.25	.15	.85	½	66	WHITE
549158EUB	350 kcmil	650/24 = 262 kcmil	½	1.25	1.36	.18	.93	½	71	RED
549168EUB			½	1.25	1.41	.17	.96	½	76	BLUE
549178EUB	400 kcmil	775/24 = 313 kcmil	¾	1.58	1.41	.17	.96	¾	76	BLUE
549188EUB	500 kcmil	925/24 = 373 kcmil	½	1.25	1.61	.22	1.10	½	87	BROWN
549198EUB			¾	1.58	1.61	.22	1.10	¾	87	BROWN
549218EUB			½	1.25	1.75	.24	1.20	½	94	GREEN
549208EUB	600 kcmil	1100/24 = 444 kcmil	¾	1.58	1.75	.24	1.20	¾	94	GREEN
549228EUB	750 kcmil	1325/24 = 535 kcmil	½	1.25	1.94	.27	1.33	½	106	BLACK
549238EUB			¾	1.58	1.94	.27	1.33	¾	106	BLACK
589848EUB		1600/24 = 646 kcmil	¾	1.58	1.94	.27	1.33	¾	106	BLACK
589268EUB	900 kcmil	1925/24 = 777 kcmil	¾	1.58	2.17	.31	1.50	¾	115	YELLOW
549288EUB			¾	1.58	2.27	.30	1.55	¾	125	N/A
549288EUB12	1000 kcmil		¾	1.83	2.37	.30	1.55	¾	125	N/A

† Contact Technical Services for specific stranding listings

Tooling: pp. B76-B92

Die Selector Chart: pp. B93-B95

Connectors for Copper Conductor

Two-Hole Lugs — Long Barrel 600V to 35KV

Material: High-Conductivity
Wrought Copper

Finish: Electro Tin Plate

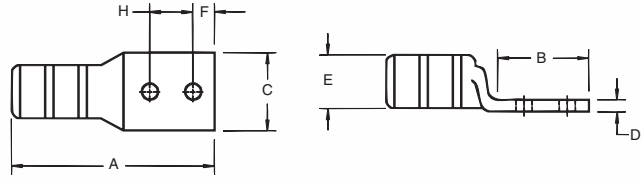

Peep Holes Available!
Add suffix -PH



Color-Keyed Compression

CAT. NO.	WIRE SIZE			DIMENSIONS (IN.)								DIE CODE	DIE COLOR
	CODE	FLEX CLASS	G, H, I, K, M†	BOLT SIZE	A	B	C	D	E	F	H		
54801BE	#14-10 AWG			¼	1.86	1.19	.50	.05	.20	¼	¾	ERG2002	YELLOW
256-31426-3	#14-10 AWG			#10	2.00	1.25	.37	.07	.20	¼	¾	ERG2002	YELLOW
256-31426-3SPH	#14-10 AWG			#10	2.00	1.25	.37	.07	.20	½	¾	ERG2002	YELLOW
256-30695-1298	#14-10 AWG			¼	1.89	1.22	.50	.05	.20	¼	¾	ERG2002	YELLOW
256-30695-1730	#14-10 AWG			¼	1.98	1.31	.50	.05	.20	¼	¾	ERG2002	YELLOW
54850BE	#8 AWG	37/24 = 14.9 kcmil		¼	2.19	1.89	.42	.07	.26	¼	¾	21	RED
54851BE	#8 AWG	#8 Weld		¼	2.31	1.29	.47	.06	.26	¼	¾	21	RED
256-30695-1157	#8 AWG			¼	3.00	2.10	.56	.06	.26	¾	1	21	RED
54852BE	#6 AWG			¼	2.28	1.28	.44	.08	.30	¼	¾	24	BLUE
256-30695-1014	#6 AWG			¼	2.63	1.63	.43	.08	.30	¼	1	24	BLUE
256-30695-1225	#6 AWG	61/24 = 24.6 kcmil		¼	2.43	1.43	.43	.08	.30	¼	¾	24	BLUE
256-30695-1158	#6 AWG	#6 Weld		¾	2.93	1.93	.59	.06	.30	¾	1	24	BLUE
256-30695-868	#6 AWG			½	4.18	3.00	.88	.11	.30	½	1¾	24	BLUE
54854BE	#4 AWG			¼	2.31	1.19	.52	.10	.37	¼	¾	29	GRAY
256-30695-1246	#4 AWG			¼	2.31	1.31	.56	.09	.37	¼	¾	29	GRAY
256-30695-1015	#4 AWG	91/24 = 36.7 kcmil		¼	2.88	1.88	.58	.09	.37	¾	1	29	GRAY
256-30695-1337	#4 AWG	#4 Weld		⅝	2.75	1.75	.56	.10	.37	1½	1	29	GRAY
256-30695-1159	#4 AWG			¾	3.13	1.98	.59	.09	.37	¾	1	29	GRAY
256-30695-733	#4 AWG			½	4.18	3.00	.88	.09	.37	½	1¾	29	GRAY
256-30695-1016	#2-3 AWG			¼	3.06	1.88	.67	.09	.41	¾	1	33	BROWN
54855BE	#2-3 AWG			¼	2.43	1.28	.59	.11	.41	¼	¾	33	BROWN
256-30695-1300	#2-3 AWG			¼	2.63	1.35	.68	.11	.41	¼	¾	33	BROWN
54856BE	#2-3 AWG			⅝	2.78	1.63	.59	.11	.41	¾	¾	33	BROWN
54810BE	#2-3 AWG	125/24 = 50.4 kcmil		¾	3.80	2.57	.59	.11	.41	¾	1¾	33	BROWN
256-30695-1160	#2-3 AWG			¾	3.08	1.94	.59	.11	.41	¾	1	33	BROWN
256-30695-869	#2-3 AWG			½	4.02	2.88	.75	.09	.41	¾	1¾	33	BROWN
54811BE	#2-3 AWG			½	4.28	3.00	.88	.11	.41	½	1¾	33	BROWN
54809BE	#1 AWG			¼	2.88	1.19	.67	.11	.47	¼	¾	37	GREEN
54812BE	#1 AWG	150/24 = 60.5 kcmil		¼	2.75	1.40	.67	.11	.47	¼	¾	37	GREEN
54858BE	#1 AWG	175/24 = 70.6 kcmil,		⅝	2.97	1.63	.67	.11	.47	¾	¾	37	GREEN
256-30695-1161	#1 AWG	#2 Weld		¾	3.30	1.98	.67	.11	.47	¾	1	37	GREEN
54857BE	#1 AWG			½	4.43	3.00	.88	.11	.47	½	1¾	37	GREEN
256-30695-1018	1/0 AWG			¼	3.63	1.88	.75	.13	.52	¾	1	42	PINK
256-30695-1018P	1/0 AWG			¼	3.63	1.88	.75	.13	.52	¾	1	42	PINK
54859BE	1/0 AWG			¼	2.63	1.19	.75	.13	.52	¼	¾	42	PINK
54813BE	1/0 AWG			¼	2.71	1.38	.75	.13	.52	¼	¾	42	PINK
54860BE	1/0 AWG	225/24 = 90.8 kcmil		⅝	2.97	1.63	.75	.13	.52	¾	¾	42	PINK
256-30695-1162P	1/0 AWG			¾	3.25	1.98	.75	.13	.52	¾	1	42	PINK
256-30695-1162	1/0 AWG			¾	3.23	1.93	.75	.13	.52	¾	1	42	PINK
256-30695-593	1/0 AWG			¾	4.33	3.00	.75	.13	.52	¾	1¾	42	PINK

† Contact Technical Services for specific stranding listings

Tooling: pp. B76-B92 Die Selector Chart: pp. B93-B95

United States
Tel: 901.252.8000
800.816.7809
Fax: 901.252.1354

Canada
Tel: 450.347.5318
Fax: 450.347.1976

Technical Services
Tel: 888.862.3289

Thomas & Betts

www.tnb.com

Connectors for Copper Conductor

Two-Hole Lugs — Long Barrel 600V to 35KV (continued)

Material: High-Conductivity
Wrought Copper

Finish: Electro Tin Plate

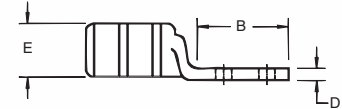
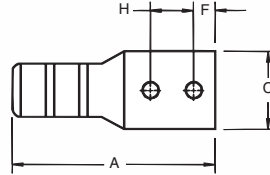

Peep Holes Available!
Add suffix **-PH**



CAT. NO.	CODE	WIRE SIZE		BOLT SIZE	DIMENSIONS (IN.)							DIE CODE	DIE COLOR
		FLEX CLASS	G, H, I, K, M†		A	B	C	D	E	F	H		
548148E	2/0 AWG			¼	2.62	1.25	.83	.13	.57	¼	¾	45	BLACK
256-30695-1299	2/0 AWG			¼	2.69	1.31	.81	.13	.57	¼	¾	45	BLACK
256-30695-1116	2/0 AWG	275/24 = 111	kcmil	¾	3.19	1.81	.83	.13	.57	¾	1	45	BLACK
256-30695-1116P	2/0 AWG	1/0	Weld	¾	3.19	1.81	.83	.13	.57	¾	1	45	BLACK
548628E	2/0 AWG			½	4.20	2.81	.83	.13	.57	½	1¼	45	BLACK
548158E	3/0 AWG	2/0	Weld	¼	2.89	1.45	.92	.13	.63	¼	¾	50	ORANGE
548168E	3/0 AWG	325/24 = 131	kcmil	¾	3.25	1.63	.92	.13	.63	¾	1	50	ORANGE
548648E	3/0 AWG			½	4.48	3.00	.94	.13	.63	½	1¼	50	ORANGE
548178E	4/0 AWG			¼	3.15	1.38	1.03	.14	.70	¼	¾	54	PURPLE
548188E	4/0 AWG			¾	4.38	2.63	1.03	.14	.70	¾	1¼	54	PURPLE
256-30695-1117	4/0 AWG	450/24 = 182	kcmil	¾	3.35	1.81	1.03	.14	.70	¾	1	54	PURPLE
256-30695-1117P	4/0 AWG	3/0	Weld	¾	3.50	1.88	1.03	.14	.70	¾	1	54	PURPLE
548668E	4/0 AWG			½	4.70	3.00	1.03	.14	.70	½	1¼	54	PURPLE
256-30695-1245	250 kcmil			¾	3.83	1.93	1.13	.14	.77	¾	1	62	YELLOW
256-30695-1245P	250 kcmil	550/24 = 222	kcmil,	¾	3.83	1.93	1.13	.14	.77	¾	1	62	YELLOW
548688E	250 kcmil	4/0	Weld	½	4.92	3.00	1.13	.14	.77	½	1¼	62	YELLOW
548198E	300 kcmil			¾	5.04	2.80	1.25	.15	.85	¾	1	66	WHITE
548708E	300 kcmil	250		½	5.23	3.00	1.25	.15	.85	½	1¼	66	WHITE
548208E	350 kcmil			¼	4.29	1.93	1.36	.18	.93	¼	¾	71	RED
256-30695-1118	350 kcmil	650/24 = 262	kcmil	¾	4.33	1.93	1.36	.18	.93	¾	1	71	RED
256-30695-1118P	350 kcmil			¾	4.33	1.93	1.36	.18	.93	¾	1	71	RED
548728E	350 kcmil			½	5.40	3.00	1.36	.18	.93	½	1¼	71	RED
548228E	400 kcmil			¼	4.38	1.93	1.41	.17	.96	¼	¾	76	BLUE
548218E	400 kcmil	775/24 = 313	kcmil	¾	4.43	1.93	1.41	.17	.96	¾	1	76	BLUE
548748E	400 kcmil			½	5.51	3.00	1.41	.17	.96	½	1¼	76	BLUE
548238E	500 kcmil			¼	4.93	1.94	1.61	.22	1.10	¼	¾	87	BROWN
256-30695-1119	500 kcmil			¾	5.00	1.93	1.61	.22	1.10	¾	1	87	BROWN
256-30695-1119P	500 kcmil	925/24 = 373	kcmil	¾	5.00	1.93	1.61	.22	1.10	¾	1	87	BROWN
548768E	500 kcmil			½	6.00	3.00	1.61	.22	1.10	½	1¼	87	BROWN
548248E	600 kcmil			¾	5.70	2.80	1.75	.24	1.20	¾	1	94	GREEN
548788E	600 kcmil	1100/24 = 444	kcmil	½	5.83	3.00	1.75	.24	1.20	½	1¼	94	GREEN
548798E	700 kcmil	1325/24 = 535	kcmil	½	5.83	3.00	1.80	.24	1.25	½	1¼	99	PINK
256-30695-1222	750 kcmil			¾	5.25	2.06	1.94	.27	1.33	¾	1	106	BLACK
256-30695-1222P	750 kcmil	1325/24 = 535	kcmil	¾	5.25	2.06	1.94	.27	1.33	¾	1	106	BLACK
548808E	750 kcmil			½	6.20	3.00	1.94	.27	1.33	½	1¼	106	BLACK
588848E		1600/24 = 646	kcmil	¾	6.16	3.00	1.94	.27	1.33	¾	1¼	106	BLACK
588268E	900 kcmil	1925/24 = 777	kcmil	½	6.74	3.00	2.18	.31	1.50	½	1¼	115	YELLOW
548268E	1000 kcmil			¾	6.49	2.80	2.27	.30	1.55	¾	1	125	N/A
548828E	1000 kcmil			½	6.66	3.00	2.27	.30	1.55	½	1¼	125	N/A
548888E	1250 kcmil			½	7.88	3.00	2.42	.35	1.67	¾	1¼	140	N/A

† Contact Technical Services for specific stranding listings

Tooling: pp. B76–B92

Die Selector Chart: pp. B93–B95

Connectors for Copper Conductor

Two-Hole Lugs — 45° Long Barrel 600V to 35KV

Material: High-Conductivity
Wrought Copper

Finish: Electro Tin Plate

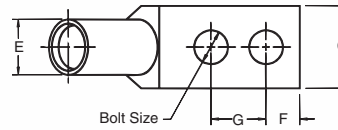
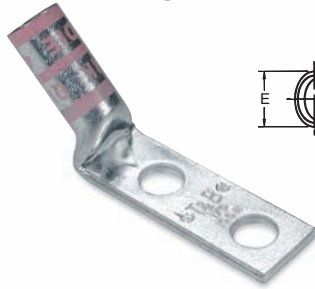

Peep Holes Available!
Add suffix -PH

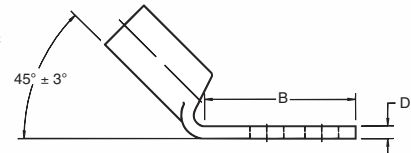

CAT. NO.	CODE	WIRE SIZE		DIMENSIONS (IN.)							DIE CODE	DIE COLOR
		FLEX CLASS	G, H, I, K, M†	BOLT SIZE	B	C	D	E	F	G		
256-31426-3SPHUF	#14-10 AWG			#10	1.25	.37	.07	.20	3/32	5/8-3/4	ERG2002	YELLOW
256-30695-1298UF	#14-10 AWG			1/4	1.22	.50	.05	.20	1/4	5/8	ERG2002	YELLOW
256-30695-1055UF	#14-10 AWG			1/4	1.31	.50	.13	.36	1/4	5/8-3/4	ERG2002	YELLOW
54850BEUF	#8 AWG	37/24 = 14.9 kcmil		1/4	1.89	.42	.07	.26	1/4	5/8	21	RED
54851BEUF	#8 AWG	#8 Weld		1/4	1.29	.47	.06	.26	1/4	3/4	21	RED
54851BEUF0612	#8 AWG			3/8	1.42	.47	.06	.26	3/8	3/4	21	RED
54852BEUF	#6 AWG			1/4	1.28	.44	.08	.30	1/4	5/8	24	BLUE
54852BEUF0416	#6 AWG			1/4	1.63	.43	.08	.30	1/4	1	24	BLUE
54852BEUF0412	#6 AWG	61/24 = 24.6 kcmil		1/4	1.43	.43	.08	.30	1/4	3/4	24	BLUE
54852BEUF0616	#6 AWG	#6 Weld		3/8	1.93	.59	.06	.30	3/8	1	24	BLUE
54852BEUF0828	#6 AWG			1/2	3.00	.88	.11	.30	1/2	1 1/4	24	BLUE
54854BEUF	#4 AWG			1/4	1.19	.52	.10	.37	1/4	5/8	29	GRAY
54854BEUF0412	#4 AWG			1/4	1.31	.56	.09	.37	1/4	3/4	29	GRAY
54854BEUF0416	#4 AWG	91/24 = 36.7 kcmil		1/4	1.88	.58	.09	.37	3/8	1	29	GRAY
54854BEUF0516	#4 AWG	#4 Weld		5/16	1.75	.56	.10	.37	1 1/2	1	29	GRAY
54854BEUF0616	#4 AWG			3/8	1.98	.59	.09	.37	3/8	1	29	GRAY
54854BEUF0828	#4 AWG			1/2	3.00	.88	.09	.37	1/2	1 1/4	29	GRAY
54855BEUF0416	#2-3 AWG			1/4	1.88	.67	.09	.41	3/8	1	33	BROWN
54855BEUF	#2-3 AWG			1/4	1.28	.59	.11	.41	1/4	5/8	33	BROWN
54855BEUF0412	#2-3 AWG			1/4	1.35	.68	.11	.41	1/4	3/4	33	BROWN
54856BEUF	#2-3 AWG	125/24 = 50.4 kcmil		5/16	1.63	.59	.11	.41	3/8	3/4	33	BROWN
54810BEUF	#2-3 AWG			3/8	2.57	.59	.11	.41	3/8	1 1/4	33	BROWN
54810BEUF0616	#2-3 AWG			3/8	1.94	.59	.11	.41	3/8	1	33	BROWN
54811BEUF	#2-3 AWG			1/2	3.00	.88	.11	.41	1/2	1 1/4	33	BROWN
54809BEUF	#1 AWG			1/4	1.19	.67	.11	.47	1/4	5/8	37	GREEN
54812BEUF	#1 AWG	150/24 = 60.5 kcmil		1/4	1.40	.67	.11	.47	1/4	3/4	37	GREEN
54858BEUF	#1 AWG	175/24 = 70.6 kcmil,		5/16	1.63	.67	.11	.47	3/8	3/8	37	GREEN
54857BEUF0616	#1 AWG	#2 Weld		3/8	1.98	.67	.11	.47	3/8	1	37	GREEN
54857BEUF	#1 AWG			1/2	3.00	.88	.11	.47	1/2	1 1/4	37	GREEN
54859BEUF0416	1/0 AWG			1/4	1.88	.75	.13	.52	3/8	1	42	PINK
54859BEUF0416PH	1/0 AWG			1/4	1.88	.75	.13	.52	3/8	1	42	PINK
54859BEUF	1/0 AWG			1/4	1.19	.75	.13	.52	1/4	5/8	42	PINK
54813BEUF	1/0 AWG			1/4	1.38	.75	.13	.52	1/4	3/4	42	PINK
54860BEUF	1/0 AWG	225/24 = 90.8 kcmil		5/16	1.63	.75	.13	.52	3/8	3/8	42	PINK
54860BEUF0616	1/0 AWG			3/8	1.98	.75	.13	.52	3/8	1	42	PINK
54860BEUF0616PH	1/0 AWG			3/8	1.93	.75	.13	.52	3/8	1	42	PINK
54860BEUF0828	1/0 AWG			1/2	3.00	.75	.13	.52	3/8	1 1/4	42	PINK
54814BEUF	2/0 AWG			1/4	1.25	.83	.13	.57	1/4	5/8	45	BLACK
54814BEUF0412	2/0 AWG			1/4	1.31	.81	.13	.57	1/4	3/4	45	BLACK
54862BEUF0616	2/0 AWG	275/24 = 111 kcmil		3/8	1.81	.83	.13	.57	3/8	1	45	BLACK
54862BEUF0616PH	2/0 AWG	1/0 Weld		3/8	1.81	.83	.13	.57	3/8	1	45	BLACK
54862BEUF	2/0 AWG			1/2	2.81	.83	.13	.57	1/2	1 1/4	45	BLACK

† Contact Technical Services for specific stranding listings

Tooling: pp. B76-B92 Die Selector Chart: pp. B93-B95

Color-Keyed Compression

United States
Tel: 901.252.8000
800.816.7809
Fax: 901.252.1354

Canada
Tel: 450.347.5318
Fax: 450.347.1976

Technical Services
Tel: 888.862.3289

Thomas & Betts

www.tnb.com

Connectors for Copper Conductor

Two-Hole Lugs — 45° Long Barrel 600V to 35KV (continued)

Material: High-Conductivity
Wrought Copper

Finish: Electro Tin Plate

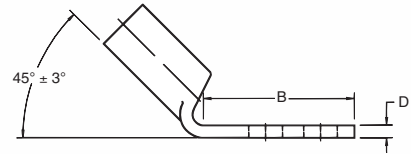
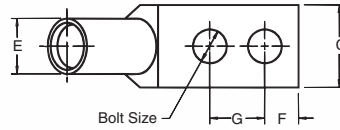
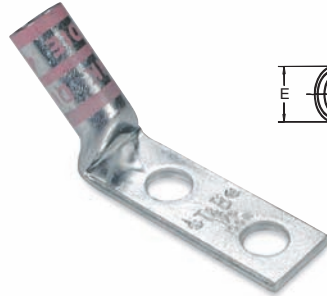

Peep Holes Available!
Add suffix **-PH**



CAT. NO.	CODE	WIRE SIZE		DIMENSIONS (IN.)							DIE CODE	DIE COLOR
		FLEX CLASS G, H, I, K, M†	BOLT SIZE	B	C	D	E	F	G			
54815BEUF	3/0 AWG	2/0 Weld	¼	1.45	.92	.13	.63	¼	¾	50	ORANGE	
54816BEUF	3/0 AWG	325/24 = 131 kcmil	¾	1.63	.92	.13	.63	¾	1	50	ORANGE	
54864BEUF	3/0 AWG		½	3.00	.94	.13	.63	½	1¾	50	ORANGE	
54817BEUF	4/0 AWG		¼	1.38	1.03	.14	.70	¼	¾	54	PURPLE	
54818BEUF	4/0 AWG		¾	2.63	1.03	.14	.70	¾	1¾	54	PURPLE	
54818BEUF0616	4/0 AWG	450/24 = 182 kcmil	¾	1.81	1.03	.14	.70	¾	1	54	PURPLE	
54818BEUF0616PH	4/0 AWG	3/0 Weld	¾	1.88	1.03	.14	.70	¾	1	54	PURPLE	
54866BEUF	4/0 AWG		½	3.00	1.03	.14	.70	½	1¾	54	PURPLE	
54868BEUF0616	250 kcmil		¾	1.93	1.13	.14	.77	¾	1	62	YELLOW	
54868BEUF0616PH	250 kcmil	550/24 = 222 kcmil	¾	1.93	1.13	.14	.77	¾	1	62	YELLOW	
54868BEUF	250 kcmil	4/0 Weld	½	3.00	1.13	.14	.77	½	1¾	62	YELLOW	
54819BEUF	300 kcmil		¾	2.80	1.25	.15	.85	¾	1	66	WHITE	
54870BEUF	300 kcmil	250	½	3.00	1.25	.15	.85	½	1¾	66	WHITE	
54820BEUF	350 kcmil		¼	1.93	1.36	.18	.93	¼	¾	71	RED	
54872BEUF0616	350 kcmil		¾	1.93	1.36	.18	.93	¾	1	71	RED	
54872BEUF0616PH	350 kcmil	650/24 = 262 kcmil	¾	1.93	1.36	.18	.93	¾	1	71	RED	
54872BEUF	350 kcmil		½	3.00	1.36	.18	.93	½	1¾	71	RED	
54822BEUF	400 kcmil		¼	1.93	1.41	.17	.96	¼	¾	76	BLUE	
54821BEUF	400 kcmil	775/24 = 313 kcmil	¾	1.93	1.41	.17	.96	¾	1	76	BLUE	
54874BEUF	400 kcmil		½	3.00	1.41	.17	.96	½	1¾	76	BLUE	
54823BEUF	500 kcmil		¼	1.94	1.61	.22	1.10	¼	¾	87	BROWN	
54876BEUF0616	500 kcmil		¾	1.93	1.61	.22	1.10	¾	1	87	BROWN	
54876BEUF0616PH	500 kcmil	925/24 = 373 kcmil	¾	1.93	1.61	.22	1.10	¾	1	87	BROWN	
54876BEUF	500 kcmil		½	3.00	1.61	.22	1.10	½	1¾	87	BROWN	
54824BEUF	600 kcmil		¾	2.80	1.75	.24	1.20	¾	1	94	GREEN	
54878BEUF	600 kcmil	1100/24 = 444 kcmil	¾	3.00	1.75	.24	1.20	¾	1¾	94	GREEN	
54880BEUF0616	750 kcmil		¾	2.06	1.94	.27	1.33	¾	1	106	BLACK	
54880BEUF0616PH	750 kcmil	1325/24 = 535 kcmil	¾	2.06	1.94	.27	1.33	¾	1	106	BLACK	
54880BEUF	750 kcmil		½	3.00	1.94	.27	1.33	½	1¾	106	BLACK	
58884BEUF		1600/24 = 646 kcmil	¾	3.00	1.94	.27	1.33	¾	1¾	106	BLACK	
58826BEUF	900 kcmil	1925/24 = 777 kcmil	¾	3.00	2.18	.31	1.50	¾	1¾	115	YELLOW	
54826BEUF	1000 kcmil		¾	2.80	2.27	.30	1.55	¾	1	125	N/A	
54882BEUF	1000 kcmil		¾	3.00	2.27	.30	1.55	¾	1¾	125	N/A	

† Contact Technical Services for specific stranding listings

Tooling: pp. B76–B92

Die Selector Chart: pp. B93–B95

Connectors for Copper Conductor

Two-Hole Lugs — 90° Long Barrel 600V to 35KV Applications

Material: High-Conductivity
Wrought Copper

Finish: Electro Tin Plate

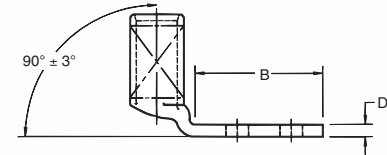
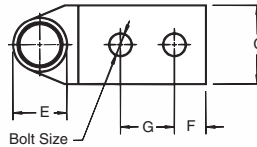

Peep Holes Available!
Add suffix -PH



Color-Keyed Compression

CAT. NO.	CODE	WIRE SIZE		DIMENSIONS (IN.)							DIE CODE	DIE COLOR
		FLEX CLASS	G, H, I, K, M*	BOLT SIZE	B	C	D	E	F	G		
256-31426-3SPHUB	#14-10 AWG			#10	1.25	.37	.07	.20	3/32	5/16	ERG2002	YELLOW
256-30695-1298UB	#14-10 AWG			1/4	1.22	.50	.05	.20	1/4	5/8	ERG2002	YELLOW
256-30695-1055UB	#14-10 AWG			1/4	1.31	.50	.13	.36	1/4	5/8-3/4	ERG2002	YELLOW
54850BEUB	#8 AWG	37/24 = 14.9	kcmil	1/4	1.89	.42	.07	.26	1/4	1 1/16	21	RED
54851BEUB	#8 AWG		#8 Weld	1/4	1.29	.47	.06	.26	1/4	3/4	21	RED
54851BEUB0616	#8 AWG			3/8	2.10	.56	.06	.26	3/8	1	21	RED
54852BEUB	#6 AWG			1/4	1.28	.44	.08	.30	1/4	5/8	24	BLUE
256306951014B	#6 AWG			1/4	1.63	.43	.08	.30	1/4	1	24	BLUE
54852BEUB0412	#6 AWG	61/24 = 24.6	kcmil	1/4	1.43	.43	.08	.30	1/4	3/4	24	BLUE
54852BEUB0616	#6 AWG		#6 Weld	3/8	1.93	.59	.06	.30	3/8	1	24	BLUE
54852BEUB0828	#6 AWG			1/2	3.00	.88	.11	.30	1/2	1 1/4	24	BLUE
54854BEUB	#4 AWG			1/4	1.19	.52	.10	.37	1/4	3/4	29	GRAY
54854BEUB0412	#4 AWG			1/4	1.31	.56	.09	.37	1/4	3/4	29	GRAY
54854BEUB0416	#4 AWG	91/24 = 36.7	kcmil	1/4	1.88	.58	.09	.37	3/8	1	29	GRAY
54854BEUB0516	#4 AWG		#4 Weld	5/16	1.75	.56	.10	.37	1 1/32	1	29	GRAY
54854BEUB0616	#4 AWG			3/8	1.98	.59	.09	.37	3/8	1	29	GRAY
54854BEUB0828	#4 AWG			1/2	3.00	.88	.09	.37	1/2	1 1/4	29	GRAY
54858BEUB0416	#2-3 AWG			1/4	1.88	.67	.09	.41	3/8	1	33	BROWN
54855BEUB	#2-3 AWG			1/4	1.28	.59	.11	.41	1/4	5/8	33	BROWN
54855BEUB0412	#2-3 AWG			1/4	1.35	.68	.11	.41	1/4	3/4	33	BROWN
54856BEUB	#2-3 AWG	125/24 = 50.4	kcmil	5/16	1.63	.59	.11	.41	3/8	3/4	33	BROWN
54810BEUB	#2-3 AWG			3/8	2.57	.59	.11	.41	3/8	1 1/4	33	BROWN
54810BEUB0616	#2-3 AWG			3/8	1.94	.59	.11	.41	3/8	1	33	BROWN
54811BEUB	#2-3 AWG			1/2	3.00	.88	.11	.41	1/2	1 1/4	33	BROWN
54809BEUB	#1 AWG			1/4	1.19	.67	.11	.47	1/4	3/4	37	GREEN
54812BEUB	#1 AWG	150/24 = 60.5	kcmil	1/4	1.40	.67	.11	.47	1/4	3/4	37	GREEN
54858BEUB	#1 AWG	175/24 = 70.6	kcmil	5/16	1.63	.67	.11	.47	3/8	3/4	37	GREEN
54857BEUB0616	#1 AWG		#2 Weld	3/8	1.98	.67	.11	.47	3/8	1	37	GREEN
54857BEUB	#1 AWG			1/2	3.00	.88	.11	.47	1/2	1 1/4	37	GREEN
54859BEUB0416	1/0 AWG			1/4	1.88	.75	.13	.52	3/8	1	42	PINK
54859BEUB0416PH	1/0 AWG			1/4	1.88	.75	.13	.52	3/8	1	42	PINK
54859BEUB	1/0 AWG			1/4	1.19	.75	.13	.52	1/4	5/8	42	PINK
54813BEUB	1/0 AWG	225/24 = 90.8	kcmil	1/4	1.38	.75	.13	.52	1/4	3/4	42	PINK
54860BEUB	1/0 AWG			5/16	1.63	.75	.13	.52	3/8	3/4	42	PINK
54860BEUB0616	1/0 AWG			3/8	1.98	.75	.13	.52	3/8	1	42	PINK
54860BEUB0828	1/0 AWG			1/2	3.00	.75	.13	.52	3/8	1 1/4	42	PINK
54814BEUB	2/0 AWG			1/4	1.25	.83	.13	.57	1/4	3/4	45	BLACK
54814BEUB0412	2/0 AWG			1/4	1.31	.81	.13	.57	1/4	3/4	45	BLACK
54862BEUB0616	2/0 AWG	275/24 = 111	kcmil	3/8	1.81	.83	.13	.57	3/8	1	45	BLACK
54862BEUB0616PH	2/0 AWG		1/0 Weld	3/8	1.81	.83	.13	.57	3/8	1	45	BLACK
54862BEUB	2/0 AWG			1/2	2.81	.83	.13	.57	1/2	1 1/4	45	BLACK

† Contact Technical Services for specific stranding listings

Tooling: pp. B76-B92 Die Selector Chart: pp. B93-B95

United States
Tel: 901.252.8000
800.816.7809
Fax: 901.252.1354

Canada
Tel: 450.347.5318
Fax: 450.347.1976

Technical Services
Tel: 888.862.3289

Thomas & Betts

www.tnb.com

Connectors for Copper Conductor

Two-Hole Lugs — 90° Long Barrel 600V to 35KV Applications (continued)

Material: High-Conductivity
Wrought Copper

Finish: Electro Tin Plate

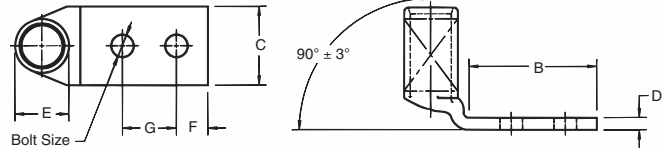

Peep Holes Available!
Add suffix **-PH**



Color-Keyed® Compression

CAT. NO.	CODE	WIRE SIZE		DIMENSIONS (IN.)						DIE CODE	DIE COLOR	
		FLEX CLASS	G, H, I, K, M†	BOLT SIZE	B	C	D	E	F			G
54815BEUB	3/0 AWG	2/0 Weld		¼	1.45	.92	.13	.63	¼	¾	50	ORANGE
54816BEUB	3/0 AWG	325/24 = 131 kcmil		¾	1.63	.92	.13	.63	¾	¾	50	ORANGE
54864BEUB	3/0 AWG			½	3.00	.94	.13	.63	½	1¼	50	ORANGE
54817BEUB	4/0 AWG			¼	1.38	1.03	.14	.70	¼	¾	54	PURPLE
54818BEUB	4/0 AWG			¾	2.63	1.03	.14	.70	¾	1¼	54	PURPLE
54818BEUB0616	4/0 AWG	450/24 = 182 kcmil		¾	1.81	1.03	.14	.70	¾	1	54	PURPLE
54818BEUB0616PH	4/0 AWG	3/0 Weld		¾	1.88	1.03	.14	.70	¾	1	54	PURPLE
54866BEUB	4/0 AWG			½	3.00	1.03	.14	.70	½	1¼	54	PURPLE
54868BEUB0616	250 kcmil			¾	1.93	1.13	.14	.77	¾	1	62	YELLOW
54868BEUB0616PH	250 kcmil	550/24 = 222 kcmil		¾	1.93	1.13	.14	.77	¾	1	62	YELLOW
54868BEUB	250 kcmil	4/0 Weld		½	3.00	1.13	.14	.77	½	1¼	62	YELLOW
54819BEUB	300 kcmil			¾	2.80	1.25	.15	.85	¾	1	66	WHITE
54870BEUB	300 kcmil	250		½	3.00	1.25	.15	.85	½	1¼	66	WHITE
54820BEUB	350 kcmil			¼	1.93	1.36	.18	.93	¼	¾	71	RED
54872BEUB0616	350 kcmil			¾	1.93	1.36	.18	.93	¾	1	71	RED
54872BEUB0616PH	350 kcmil	650/24 = 262 kcmil		¾	1.93	1.36	.18	.93	¾	1	71	RED
54872BEUB	350 kcmil			½	3.00	1.36	.18	.93	½	1¼	71	RED
54822BEUB	400 kcmil			¼	1.93	1.41	.17	.96	¼	¾	76	BLUE
54821BEUB	400 kcmil	775/24 = 313 kcmil		¾	1.93	1.41	.17	.96	¾	1	76	BLUE
54874BEUB	400 kcmil			½	3.00	1.41	.17	.96	½	1¼	76	BLUE
54823BEUB	500 kcmil			¼	1.94	1.61	.22	1.10	¼	¾	87	BROWN
54823BEUB0616	500 kcmil			¾	1.93	1.61	.22	1.10	¾	1	87	BROWN
54876BEUB0616PH	500 kcmil	925/24 = 373 kcmil		¾	1.93	1.61	.22	1.10	¾	1	87	BROWN
54876BEUB	500 kcmil			½	3.00	1.61	.22	1.10	½	1¼	87	BROWN
54824BEUB	600 kcmil			¾	2.80	1.75	.24	1.20	¾	1	94	GREEN
54878BEUB	600 kcmil	1100/24 = 444 kcmil		½	3.00	1.75	.24	1.20	½	1¼	94	GREEN
54880BEUB0616	750 kcmil			¾	2.06	1.94	.27	1.33	¾	1	106	BLACK
54880BEUB0616PH	750 kcmil	1325/24 = 535 kcmil		¾	2.06	1.94	.27	1.33	¾	1	106	BLACK
54880BEUB	750 kcmil			½	3.00	1.94	.27	1.33	½	1¼	106	BLACK
58884BEUB		1600/24 = 646 kcmil		½	3.00	1.94	.27	1.33	½	1¼	106	BLACK
58826BEUB	900 kcmil	1925/24 = 777 kcmil		½	3.00	2.18	.31	1.50	½	1¼	115	YELLOW
54826BEUB	1000 kcmil			¾	2.80	2.27	.30	1.55	¾	1	125	N/A
54882BEUB	1000 kcmil			¾	3.00	2.27	.30	1.55	¾	1¼	125	N/A

† Contact Technical Services for specific stranding listings

Tooling: pp. B76–B92

Die Selector Chart: pp. B93–B95

Connectors for Copper Conductor

Copper One-Hole Lugs for 600V to 35KV Applications

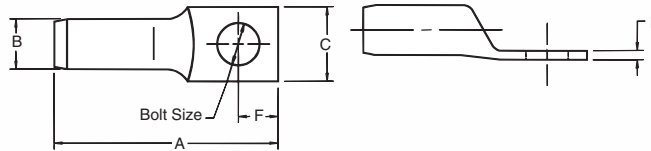

These Color-Keyed® Connectors are recommended for up to 15 KV applications. Installed with standard T&B Cat. No. TBM15I, 13100A, TBM14M hydraulic compression tools with special rounding dies. The compression forms the connector and conductor into a solid mass to provide an optimum electrical bond between connector and conductor. The rounding die overlapped compressions provide a smooth round surface. This, combined with the tapered barrel ends, addresses the controlling of potentially damaging electrical stresses of high voltages.

CAT. NO.	CABLE SIZE†		DIMENSIONS (IN.)					INSTALLING TOOLS			
	STUD SIZE (IN.)		A	B	C	D	E	F	DIE SET CAT. NO.	STRIP LENGTH (IN.)	COLOR CODE
54440	#4 AWG	3/8	2.08	.81	.58	.08	3/8	1/2	15CA29R	1 1/16	GRAY
54443	#2 AWG	3/8	2.25	.81	.66	.09	3/8	1/2	15CA33R	1 1/16	BROWN
54448	#1 AWG	3/8	2.36	.81	.69	.10	3/8	1/2	15CA37R	1 1/2	GREEN
54409	1/0 AWG	3/8	2.38	.81	.75	.12	3/8	1/2	15CA42R	1 1/2	PINK
54460	2/0 AWG	1/2	2.73	1.06	.83	.12	1/2	1/2	15CA45R	1 1/2	BLACK
54465	3/0 AWG	1/2	2.81	1.06	.94	.12	1/2	1/2	15CA49R	1 1/2	ORANGE
54470	4/0 AWG	1/2	2.78	1.06	1.00	.13	1/2	1/2	15CA54R	1 1/2	PURPLE
54413	250 kcmil	1/2	3.19	1.06	1.07	.14	1/2	1/2	15CA60R	2 1/2	RUBY

† Cable size: Concentric and compact strandings

* Cat. No. TB15500 Die Adaptor required for TBM15I

Tooling: pp. B76–B92

Die Selector Chart: pp. B93–B95

Copper Two-Hole Lugs for 600V to 35KV Application

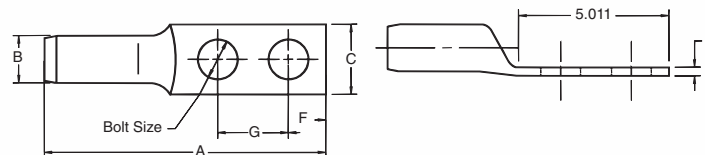

CAT. NO.	CABLE SIZE†		DIMENSIONS (IN.)							INSTALLING TOOLS		
	STUD SIZE (IN.)		A	B	C	D	E	F	G	DIE SET CAT. NO.	STRIP LENGTH (IN.)	COLOR CODE
54475	1/0 AWG	3/8	3.56	1 1/2	.77	.12	3/8	3/8	1.00	15CA42R	1 1/2	PINK
54476	2/0 AWG	1/2	4.67	3/8	.83	.12	1/2	1/2	1.75	15CA45R	1 1/2	BLACK
54478	3/0 AWG	1/2	4.75	3/8	.94	.12	1/2	1/2	1.75	15CA49R	1 1/2	ORANGE
54479	4/0 AWG	1/2	4.64	1 1/16	1.00	.13	1/2	1/2	1.75	15CA54R	1 1/2	PURPLE
54480	250 kcmil	1/2	5.17	3/4	1.08	.14	1/2	1/2	1.75	15CA60R	2 1/2	RUBY
54481	300 kcmil	1/2	5.16	1 1/16	1.19	.16	1/2	1/2	1.75	15CA66R	2 1/2	WHITE
54482	350 kcmil	1/2	5.35	3/8	1.29	.19	1/2	1/2	1.75	15CA71R	2 1/2	RED
54483	400 kcmil	1/2	5.35	5 9/16	1.36	.18	1/2	1/2	1.75	15CA76R	2 1/2	BLUE
54484	500 kcmil	1/2	5.60	1 1/8	1.54	.23	1/2	1/2	1.75	15CA87R	2 1/2	BROWN
54485	600 kcmil	1/2	5.83	1 1 1/4	1.70	.24	1/2	1/2	1.75	15CA94R	2 1/2	GREEN
54487	750 kcmil	1/2	6.13	1 1 1/4	1.89	.27	1/2	1/2	1.75	15CA106R	2 1/2	BLACK
54490	1000 kcmil	1/2	6.60	1 1/2	2.18	.31	1/2	1/2	1.75	•15C125R	2 3/4	-

• No adaptor required – TBM15I only

† Cable size: Concentric and compact strandings

TBM14M and 13100A UL Listing limited to 1/0 AWG 500 kcmil cable sizes

* Cat. No. TB15500 Die Adaptor required for TBM15I

Tooling: pp. B76–B92

Die Selector Chart: pp. B93–B95

Connectors for Copper Conductor

Bell-Ended Lugs — Standard Barrel

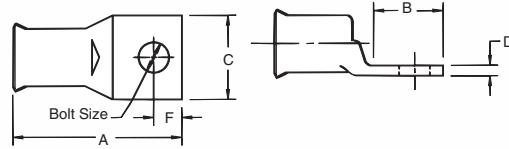

Bell-Shaped Barrel



CAT. NO.	WIRE SIZE*			CLASS G	CLASS H	CLASS I	CLASS K	CLASS M	BOLT SIZE (IN.)	DIMENSIONS (IN.)					DIE CODE	DIE COLOR
	CODE	NAVY	FLEX							A	B	C	D	F		
54104BS	8	23	37/24	8	8	—	8	8	#10	1 1/16	1 5/32	1 1/2	5/4	7/32	21	RED
54105BS	6	30	61/24	5	5	5	5	5	1/4	1 1/16	9/16	7/16	7/4	1/4	24	BLUE
54106BS	4	40-50	91/24	5	5	5	5	5	1/4	1 1/32	9/16	9/16	7/4	1/4	29	GRAY
54139BS	3 & 4	40-50	91/24	4	4	4	4	4	3/16	1 1/16	2 5/32	1 5/32	5/4	1 1/32	29	GRAY
54142BS	2	60	125/24	3	3	3	3	3	5/16	1 1/32	2 3/32	2 1/32	5/4	1 1/32	33	BROWN
54147BS	1	75	150, 175/24	2	2	2	2	2	3/16	1 21/32	2 3/32	4 3/4	1/4	3/8	37	GREEN
54153BS	1/0	100	225/24	1	1	1	1	1	3/16	1 3/8	2 3/32	3/4	5/4	3/8	42	PINK
54110BS	2/0	125	275/24	1/0	1/0	1/0	1/0	1/0	3/8	1 3/8	1 3/16	1 3/16	5/4	3/8	45	BLACK
54165BS	3/0	150	325/24	2/0	2/0	2/0	2/0	2/0	1/2	2 1/32	1 1/16	1 5/16	5/4	1/2	50	ORANGE
54170BS	4/0	200	450/24	3/0	3/0	3/0	3/0	3/0	1/2	2 3/16	1 1/16	1 1/2	5/2	1/2	54	PURPLE
58165BS	250	—	550/24	4/0	4/0	—	—	—	1/2	2 15/32	1 1/8	1 1/4	3/6	1/2	62	YELLOW
54114BS	300	300	650/24	250	250	250	250	—	1/2	2 15/32	1 1/8	1 1/4	3/6	1/2	66	WHITE
5411440BS	300	300	—	250	250	4/0	4/0	4/0	1/2	2 3/8	1 1/8	1 1/4	3/6	1/2	66	WHITE
54115260BS	350	350	650/24	—	—	250	250	250	1/2	2 5/8	1 1/8	1 3/8	1 3/4	9/16	66	WHITE
54185BS	400	400	775/24	300	300	300	300	300	3/8	3 1/16	1 11/16	1 13/32	7/32	1 3/16	76	BLUE
58177BS	500	—	925/24	400	400	400	350	350	3/8	3	1 1/16	1 1/8	1/4	1 3/16	80	N/A
58180BS	600	—	1100/24	—	—	450	450	450	3/8	3 5/8	1 11/16	1 25/32	1 7/4	1 3/16	94	GREEN
54122BS	700	—	1325/24	500	500	500	500	500	3/8	3 5/8	1 11/16	1 25/32	5/32	1 3/16	99	PINK
54123BS	750	—	—	600	—	—	—	550	3/8	3 3/8	1 11/16	1 15/16	3/16	1 3/16	106	BLACK
54124BS	800	800	—	—	—	—	600	—	3/8	3 7/16	1 1/16	2	5/16	5/8	107	ORANGE
54126BS	900	—	1925/24	—	—	—	—	v	3/8	4 1/8	1 13/16	2 3/16	1 1/2	7/8	115	YELLOW

Tooling: pp. B76–B92

Die Selector Chart: pp. B93–B95

Connectors for Copper Conductor

Bell-Ended Lugs — Long Barrel

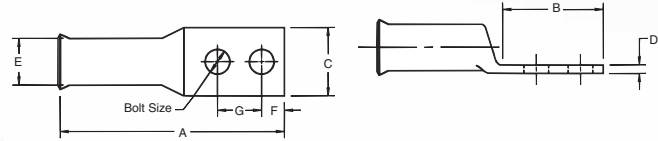

Bell-Shaped Copper Lugs with Two Bolt Holes



CAT. NO.	WIRE SIZE*			CLASS G	CLASS H	CLASS I	CLASS K	CLASS M	BOLT SIZE (IN.)	DIMENSIONS (IN.)							DIE CODE	DIE COLOR
	CODE	NAVY	FLEX							A	B	C	D	E	F	G		
54850BEBS	8	23	8	8	8	—	8	—	1/4	2.19	1.88	.42	.07	.26	.25	.63	21	RED
54851BEBS	8	23	8	8	8	—	8	—	1/4	2.31	1.29	.47	.06	.26	.25	.75	21	RED
54851BE0412BS	8	23	8	8	8	—	8	—	3/8	3.00	2.10	.56	.06	.26	.38	1.00	21	RED
54852BE0616BS	6	30	6	5	5	5	5	—	1/4	2.93	1.93	.59	.06	.30	.38	1.00	24	BLUE
54852BEBS	6	30	6	5	5	5	5	—	1/4	2.28	1.28	.44	.08	.30	.25	.63	24	BLUE
54852BE0412BS	6	30	6	5	5	5	5	—	1/4	2.43	1.43	.43	.07	.30	.25	.75	24	BLUE
54854BEBS	4-3	40-50	5	5	5	5	5	—	1/4	2.31	1.19	.52	.10	.37	.25	.63	29	GRAY
54854BE0412BS	4-3	40-50	5	5	5	5	5	—	1/4	2.31	1.31	.56	.09	.37	.25	.75	29	GRAY
54854BE0616BS	4-3	40-50	5	5	5	5	5	—	3/8	3.13	1.98	.59	.09	.37	.38	1.00	29	GRAY
54855BE0412BS	2	60	3	3	3	3	3	3	3	2.63	1.35	.68	.11	.41	.25	.75	33	BROWN
54855BEBS	2	60	3	3	3	3	3	3	1/4	2.43	1.28	.59	.11	.41	.25	.63	33	BROWN
54856BEBS	2	60	3	3	3	3	3	3	5/16	2.78	1.63	.59	.11	.41	.38	.75	33	BROWN
54810BE0616BS	2	60	3	3	3	3	3	3	3/8	3.08	1.94	.59	.11	.41	.38	1.00	33	BROWN
54811BEBS	2	60	3	3	3	3	3	3	3	4.28	3.00	.88	.09	.41	.50	1.75	33	BROWN
54809BEBS	1	75	2	2	2	2	2	2	1/4	2.88	1.19	.67	.11	.47	.25	.63	37	GREEN
54812BEBS	1	75	2	2	2	2	2	2	1/4	2.75	1.40	.67	.11	.47	.25	.75	37	GREEN
54858BEBS	1	75	2	2	2	2	2	2	5/16	2.97	1.63	.67	.11	.47	.38	.88	37	GREEN
54857BEBS	1	75	2	2	2	2	2	2	1/4	4.43	3.00	.88	.10	.47	.50	1.75	37	GREEN
54859BEBS	1/0	100	1	1	1	1	1	1	1/4	2.63	1.19	.75	.13	.52	.25	.63	42	PINK
54813BEBS	1/0	100	1	1	1	1	1	1	1/4	2.71	1.38	.75	.13	.52	.25	.75	42	PINK
54860BEBS	1/0	100	1	1	1	1	1	1	5/16	2.97	1.63	.75	.13	.52	.38	.88	42	PINK
54860BE0616BS	1/0	100	1	1	1	1	1	1	3/8	3.23	1.93	.75	.13	.52	.38	1.00	42	PINK
5414BEBS	2/0	125	1/0	1/0	1/0	1/0	1/0	1/0	1/4	2.62	1.25	.83	.13	.57	.25	.63	45	BLACK
54814BE0412BS	2/0	125	1/0	1/0	1/0	1/0	1/0	1/0	1/4	2.69	1.31	.81	.13	.57	.25	.75	45	BLACK
54862BE0616BS	2/0	125	1/0	1/0	1/0	1/0	1/0	1/0	3/8	3.19	1.81	.83	.13	.57	.38	1.00	45	BLACK
54862BEBS	2/0	125	1/0	1/0	1/0	1/0	1/0	1/0	1/4	4.20	2.81	.83	.13	.57	.50	1.75	45	BLACK
54815BEBS	3/0	150	2/0	2/0	2/0	2/0	2/0	2/0	1/4	2.89	1.45	.92	.13	.63	.25	.75	50	ORANGE
54816BEBS	3/0	150	2/0	2/0	2/0	2/0	2/0	2/0	3/8	3.25	1.63	.92	.13	.63	.38	1.00	50	ORANGE
54864BEBS	3/0	150	2/0	2/0	2/0	2/0	2/0	2/0	1/4	4.45	3.00	.92	.13	.63	.50	1.75	50	ORANGE
54817BEBS	4/0	200	3/0	3/0	3/0	3/0	3/0	3/0	1/4	3.15	1.38	1.03	.14	.70	.50	.75	54	PURPLE
54818BE0616BS	4/0	200	3/0	3/0	3/0	3/0	3/0	3/0	3/8	3.35	1.81	1.03	.14	.70	.25	1.00	54	PURPLE
54818BEBS	4/0	200	3/0	3/0	3/0	3/0	3/0	3/0	3/8	4.38	2.63	1.03	.14	.70	.38	1.75	54	PURPLE
54866BEBS	4/0	200	3/0	3/0	3/0	3/0	3/0	3/0	1/4	4.70	3.00	1.03	.14	.70	.50	1.75	54	PURPLE
54868BE0616BS	250	—	4/0	4/0	4/0	4/0	4/0	4/0	3/8	3.83	1.93	1.13	.14	.77	.50	1.00	62	YELLOW
54868BEBS	250	—	4/0	4/0	4/0	4/0	4/0	4/0	1/4	4.92	3.00	1.13	.14	.77	.50	1.75	62	YELLOW
54819BEBS	300	300	262 kcmil	250 kcmil	250	250	250	—	3/8	5.04	2.80	1.25	.15	.85	.50	1.00	66	WHITE
54870BEBS	300	300	262 kcmil	250 kcmil	250	250	250	—	1/2	5.23	3.00	1.25	.15	.85	.50	1.75	66	WHITE
54822BEBS	400	400	313 kcmil	300 kcmil	300	300	300	—	1/4	4.38	1.93	1.41	.17	.96	.63	.75	76	BLUE
54821BEBS	400	400	313 kcmil	300 kcmil	300	300	300	—	3/8	4.43	1.93	1.41	.17	.96	.63	1.00	76	BLUE
54874BEBS	400	400	313 kcmil	300 kcmil	300	300	300	—	1/2	5.51	3.00	1.41	.17	.96	.63	1.75	76	BLUE
54823BEBS	500	—	373 kcmil	400 kcmil	400	400	350	—	1/4	4.93	1.94	1.61	.22	1.10	.50	.75	87	BROWN
54876BE0616BS	500	—	373 kcmil	400 kcmil	400	400	350	—	3/8	5.00	1.93	1.61	.22	1.10	.50	1.00	87	BROWN
54876BEBS	500	—	373 kcmil	400 kcmil	400	400	350	—	1/2	6.00	3.00	1.61	.22	1.10	.50	1.75	87	BROWN
54824BEBS	—	—	444 kcmil	—	—	450	450	—	3/8	5.70	2.80	1.75	.24	1.20	.63	1.00	94	GREEN
54878BEBS	—	—	444 kcmil	—	—	450	450	—	1/2	5.83	3.00	1.75	.24	1.20	.63	1.75	94	GREEN
54880BEBS	700	—	535 kcmil	500 kcmil	500	500	500	—	1/2	6.20	3.00	1.94	.27	1.33	.63	1.75	106	BLACK
58826BEBS	900	—	777 kcmil	—	—	—	—	—	3/8	6.49	2.80	2.27	.30	1.50	.63	1.00	115	YELLOW

* = Cat 58180 is made of the same tubing as Cat. 54120. Cat. 54120 is listed for 600 mcm.

Tooling: pp. B76-B92

Die Selector Chart: pp. B93-B95

Connectors for Copper Conductor

Two-Barrel Lugs 600V to 35KV Applications

Material: High-Conductivity
Wrought Copper

Finish: Electro Tin Plate

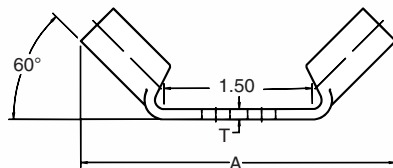
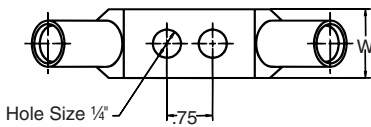

Figure 1

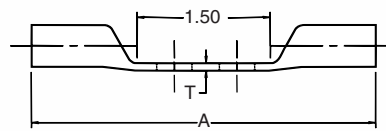
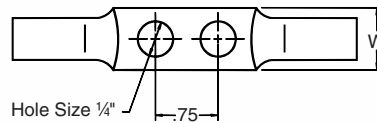

Figure 2



CAT. NO.	WIRE SIZE		HOLE SIZE (IN.)	FIG. NO.	DIMENSIONS (IN.)			DIE CODE	COLOR KEY
	CODE	FLEX			A	W	T		
256-30695-828	6	61/24	1/4	1	2 ⁵ / ₁₆	7/16	1/16	24	BLUE
256-30695-1227	6	61/24	1/4	2	3	7/16	1/16	24	BLUE

Tooling: pp. B76-B92

Die Selector Chart: pp. B93-B95

Connectors for Copper Conductor

Cast Copper One-Hole Lugs 600V to 35KV Applications — Heavy-Duty

Material: Cast Copper

Finish: Electro Tin Plate

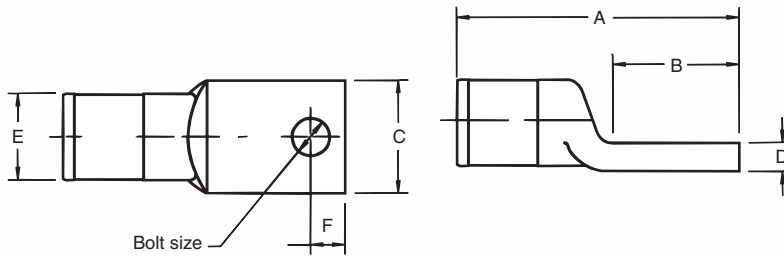

CAT. NO.	CABLE SIZE	DIMENSIONS (IN.)					BOLT SIZE (IN.)	DIE CODE
		A	B	C	D	F		
53104	8	1 ¹ / ₆	3 ⁴ / ₄	1 ¹ / ₂	1 ¹ / ₆	9 ¹ / ₃₂	#10	29
53105	6	1 ¹ / ₆	3 ⁴ / ₄	1 ¹ / ₂	1 ¹ / ₆	9 ¹ / ₃₂	1 ¹ / ₄	29
53106	4	1 ¹ / ₆	3 ⁴ / ₄	1 ¹ / ₂	1 ¹ / ₆	9 ¹ / ₃₂	1 ¹ / ₄	29
53107	2	2	1	3 ⁴ / ₄	1 ¹ / ₄	7 ¹ / ₁₆	1 ¹ / ₄	45
53108	1	2	1	3 ⁴ / ₄	1 ¹ / ₄	7 ¹ / ₁₆	1 ¹ / ₄	45
53109	1/0	2	1	3 ⁴ / ₄	1 ¹ / ₄	7 ¹ / ₁₆	3 ⁸ / ₈	45
53161**	325/24	2 ¹ / ₆	3 ⁴ / ₄	1 ³ / ₁₆	7 ¹ / ₃₂	7 ¹ / ₁₆	3 ⁸ / ₈	54
53110	2/0	2 ⁵ / ₈	1 ¹ / ₄	1	9 ¹ / ₃₂	11 ¹ / ₃₂	3 ⁸ / ₈	66
53111	3/0	2 ⁵ / ₈	1 ¹ / ₄	1	9 ¹ / ₃₂	11 ¹ / ₃₂	3 ⁸ / ₈	66
53112	4/0	2 ⁵ / ₈	1 ¹ / ₄	1	9 ¹ / ₃₂	11 ¹ / ₃₂	3 ⁸ / ₈	66
53165**	650/24	3 ³ / ₈	1 ³ / ₈	1 ³ / ₁₆	5 ¹ / ₁₆	3 ⁴ / ₄	1 ¹ / ₂	76
53113	250 kcmil	3 ³ / ₈	1 ¹ / ₂	1 ³ / ₁₆	5 ¹ / ₁₆	3 ⁴ / ₄	1 ¹ / ₂	76
53114	300 kcmil	3 ³ / ₈	1 ¹ / ₂	1 ³ / ₁₆	5 ¹ / ₁₆	3 ⁴ / ₄	1 ¹ / ₂	76
53115	350 kcmil	3 ¹³ / ₁₆	2	1 ¹ / ₈	3 ⁸ / ₈	13 ¹ / ₁₆	1 ¹ / ₂	99
53116	400 kcmil	3 ¹³ / ₁₆	2	1 ¹ / ₈	3 ⁸ / ₈	13 ¹ / ₁₆	1 ¹ / ₂	99
53118	500 kcmil	3 ³ / ₈	2	1 ¹ / ₈	3 ⁸ / ₈	13 ¹ / ₁₆	1 ¹ / ₂	99
53168**	1100/24	3 ³ / ₈	1 ¹ / ₈	1 ¹ / ₈	13 ¹ / ₃₂	7 ¹ / ₈	1 ¹ / ₂	107
53169**	1325/24	3 ³ / ₈	1 ¹ / ₈	1 ¹ / ₈	13 ¹ / ₃₂	7 ¹ / ₈	1 ¹ / ₂	107
53123	750 kcmil	4 ³ / ₈	2 ¹ / ₈	1 ¹ / ₈	7 ¹ / ₁₆	1	1 ¹ / ₂	112
53173**	2750/24*	5 ¹ / ₈	1 ¹ / ₈	2 ¹ / ₈	9 ¹ / ₁₆	1 ¹ / ₁₆	1 ¹ / ₂	150

All other Cat Nos.: Use hydraulic tools with hex dies.

** No UL/CSA

Tooling: pp. B76-B92

Die Selector Chart: pp. B93-B95

United States
Tel: 901.252.8000
800.816.7809
Fax: 901.252.1354

Canada
Tel: 450.347.5318
Fax: 450.347.1976

Technical Services
Tel: 888.862.3289

Thomas & Betts

www.tnb.com

Connectors for Copper Conductor

Cast Copper Two-Hole Lugs for Code Copper Cable 600V to 35KV

Material: Cast Copper

Finish: Electro Tin Plate

Details: 53273 2750/24 (1250 kcmil)
251-30485-1275

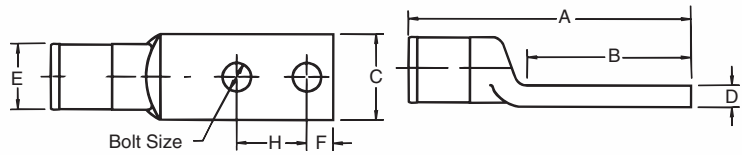
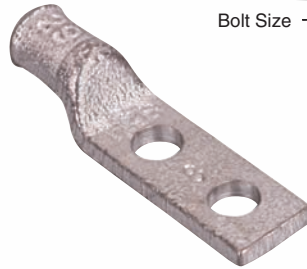

Figure 1

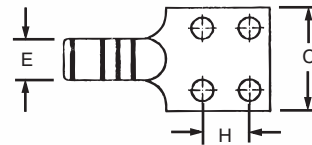

Figure 2



CAT. NO.	CODE CABLE SIZE	BOLT G SIZE (IN.)	DIMENSIONS (IN.)							DIE CODE	NO. OF CRIMPS		
			A APPROX. (IN.)	B	C	D	E	F	H		12 TON	15 TON	40 TON
256-30695-1055	#14-10	¼	2	1½	½	¾	¾	¼	¾ - ¾	29	1	1	1
53204	#8	¼	2	1½	½	¾*	¾	¼	¾	29	1	1	1
53205	#8	¼	2	1½	½	¾	¾	¼	¾	29	1	1	1
53206	#4	¼	2	1½	½	¾	¾	¼	¾	29	1	1	1
53207	#2	¼	3	2	¾	1½*	1½	¾	¾	45	1	1	1
53208	#1	¼	3	2	¾	1½	1½	1	¾	45	1	1	1
53209	1/0	¾	3	2	¾	1½	1½	1	¾	45	1	1	1
53210	2/0	¾	4½	3	¾	1½*	1½	1½	¾	66	1	1	1
53211	3/0	½	4½	3	1	1½	1½	1½	¾	66	1	1	1
53212	4/0	½	4½	3	1	1½	1½	1½	¾	66	1	1	1
53213	250 kcmil	½	4½	3	1½	1½*	1½	1½	¾	76	1	1	1
53214	300 kcmil	½	4½	3	1½	1½	1½	1½	¾	76	1	1	1
53215	350 kcmil	½	5½	3½	1½	1½*	1½	1½	¾	99	2	1	1
53216	400 kcmil	½	5½	3½	1½	1½	1½	1½	¾	99	2	1	1
53218	500 kcmil	½	5½	3½	1½	1½	1½	1½	¾	99	2	1	1
53220M	600 kcmil	½	5½	3½	1½	1½	1½	1½	¾	112	2	1	1
53222M	700 kcmil	½	5½	3½	1½	±½	1½	1½	¾	112	2	1	1
53223M	750 kcmil	½	5½	3½	1½	±½	1½	1½	¾	112	2	1	1
53269	1325/24	½	5½	3½	1½	1½	1½	1½	¾	107	2	1	1
53224	800 kcmil	½	6	3½	1½	1½*	1½	1½	¾	130	—	1	1
53226	900 kcmil	½	6	3½	1½	1½	1½	1½	¾	130	—	1	1
53228	1000 kcmil	½	6	3½	1½	1½	1½	1½	¾	130	—	1	1
53273	1100 kcmil 2750/24	½	6½	3½	2½	1½	1½	1½	¾	—	—	—	—
53233	1500 kcmil	½	6½	3½	2½	1½*	1½	1½	¾	150	—	1	1
53233L	1500 kcmil	½	7½	3½	2	1½	1½	1½	¾	150	—	1	—
53432L**	1500 kcmil	½	7½	3½	3	1½	1½	1½	¾	150	—	1	—
251-30485-1275	1250 kcmil	¾	6½	3½	2½	1½	1½	1½	¾	150	—	—	—
251-30485-1211	1750 kcmil	—	6½	3½	3	1½	2½	—	—	175	—	—	2 (Fig. 2)
251-30485-1212	1750 kcmil	—	6½	3½	2½	1½	2½	—	—	175	—	—	2 (Fig. 1)
53239	2000 kcmil 169/110	½	6½	3½	2½	1½	2½	1½	¾	175	—	—	—
53239L	178/.104 2000 kcmil	½	7½	3½	2½	1½	2½	1½	¾	175	—	—	—
53439L**	169/.110 178/.104 2000 kcmil	½	7½	3½	3	1½	2½	1½	¾	175	—	—	11421 Die

* Denotes tongue thickness of alternate construction (Brazed wrought copper tongue).

** Figure 2. All others Figure 1.

Tooling: pp. B76-B92

Die Selector Chart: pp. B93-B95

Connectors for Copper Conductor

Two-Way Splice Connectors — Standard Barrel 600V to 35KV

Material: High-Conductivity Wrought Copper

Finish: Electro Tin Plate

Two-way connectors provide high pullout values, are easy to insulate and provide a low-resistance connection of high quality and low installed cost.

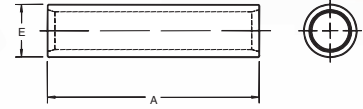

CAT. NO.	CODE	WIRE SIZE		DIMENSIONS (IN.)		DIE CODE	DIE COLOR
		FLEX CLASS G, H, I, K, M†		A	E		
54504	#8 AWG	37/24 = 14.9 kcmil, #8 Weld		1.00	.27	21	RED
54505	#6 AWG	61/24 = 24.6 kcmil, #6 Weld, 133/.014		1.00	.30	24	BLUE
54506	#4 AWG	91/24 = 36.7 kcmil, 133/.0177, 49/.029		1.00	.37	29	GRAY
54507	#2 AWG	125/24 = 50.4 kcmil, #4 Weld		1.25	.41	33	BROWN
54508	#1 AWG	150/24 = 60.5 kcmil, 175/24 = 70.6 kcmil, #2 Weld, 133/.0223		1.50	.47	37	GREEN
54509	1/0 AWG	225/24 = 90.8 kcmil, #1 Weld, 133/.0254		1.63	.52	42	PINK
54510	2/0 AWG	275/24 = 111 kcmil, 1/0 Weld, 427/.0155, 133/.0282		1.75	.57	45	BLACK
54511	3/0 AWG	325/24 = 131 kcmil, 2/0 Weld, 133/.0316, 259/.0227, 427/.0177		1.75	.63	50	ORANGE
53962		375/24 = 179 kcmil, 133/.0355, 259/.0255, 427/.0199		1.81	.70	50	ORANGE
54512	4/0 AWG	450/24 = 182 kcmil, 3/0 Weld, 703/.0154		1.88	.70	54	PURPLE
54513	250 kcmil			2.25	.77	62	YELLOW
53964		550/24 = 222 kcmil, 4/0 Weld, 133/.0399, 259/.0286, 637/.0183		2.13	.79	62	YELLOW
54514	300 kcmil	—		2.13	.83	66	WHITE
54515	350 kcmil	—		2.25	.90	71	RED
54516	400 kcmil	—		2.75	.93	76	BLUE
53968		1100/24 = 444 kcmil, 500 Weld, 259/.0417, 427/.0325, 703/.0253		3.00	1.13	87	BROWN
54518	500 kcmil	—		2.75	1.11	87	BROWN
54520	600 kcmil	—		3.00	1.18	94	GREEN
54522-TB	700 kcmil	—		3.25	1.23	99	PINK
53969		1325/24 = 535 kcmil, 427/.0342		3.00	1.24	99	PINK
54523-TB	750 kcmil	—		3.00	1.30	106	BLACK
54528	1000 kcmil	—		3.63	1.50	125	N/A
54530	1250 kcmil	—		4.13	1.67	140	N/A

† Contact Technical Services for specific stranding listings

Tooling: pp. B76-B92 Die Selector Chart: pp. B93-B95

Two-Way Splice Connectors — Long Barrel 600V to 35KV Applications

Material: High-Conductivity Wrought Copper

Finish: Electro Tin Plate

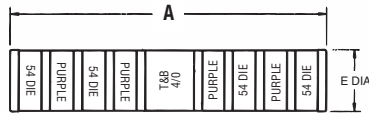

CAT. NO.	CODE	WIRE SIZE		DIMENSIONS (IN.)		DIE CODE	DIE COLOR
		FLEX CLASS G, H, I, K, M†		A	E		
54804	#8 AWG	37/24 = 14.9 kcmil		1.75	.27	21	RED
54805	#6 AWG	61/24 = 24.6 kcmil		1.75	.31	24	BLUE
54806	#4 AWG	91/24 = 36.7 kcmil		1.75	.39	29	GRAY
54807	#2 AWG	125/24 = 50.4 kcmil		1.88	.43	33	BROWN
54808	#1 AWG	150/24 = 60.5 kcmil, 175/24 = 70.6 kcmil		2.00	.49	37	GREEN
54809	1/0 AWG	225/24 = 90.8 kcmil		2.00	.54	42	PINK
54810	2/0 AWG	275/24 = 111 kcmil		2.13	.59	45	BLACK
54811	3/0 AWG	325/24 = 131 kcmil		2.25	.65	50	ORANGE
54812	4/0 AWG	450/24 = 182 kcmil		2.75	.72	54	PURPLE
54813	250 kcmil	550/24 = 222 kcmil		3.38	.79	62	YELLOW

CAT. NO.	CODE	WIRE SIZE		DIMENSIONS (IN.)		DIE CODE	DIE COLOR
		FLEX		A	E		
54814	300 kcmil	—		3.50	.87	66	WHITE
54815	350 kcmil	650/24 = 262 kcmil		3.75	.95	71	RED
54816	400 kcmil	775/24 = 313 kcmil		3.75	.98	76	BLUE
54818	500 kcmil	925/24 = 373 kcmil		4.75	1.11	87	BROWN
54820	600 kcmil	1100/24 = 444 kcmil		4.25	1.21	94	GREEN
54823	750 kcmil	1325/24 = 535 kcmil		4.75	1.34	106	BLACK
58524		1600/24 = 646 kcmil		5.00	1.39	106	BLACK
58526	900 kcmil	1925/24 = 777 kcmil		5.50	1.51	115	YELLOW
54828	1000 kcmil	—		5.63	1.56	125	N/A
54833	1500 kcmil	—		5.63	1.56	125	N/A
54839	2000 kcmil	—		7.06	2.125	—	N/A

† Contact Technical Services for specific stranding listings

Tooling: pp. B76-B92 Die Selector Chart: pp. B93-B95

United States
Tel: 901.252.8000
800.816.7809
Fax: 901.252.1354

Canada
Tel: 450.347.5318
Fax: 450.347.1976

Technical Services
Tel: 888.862.3289

Thomas & Betts

www.tnb.com

Connectors for Copper Conductor

Copper Two-Way Splicers for 600V to 35KV Applications

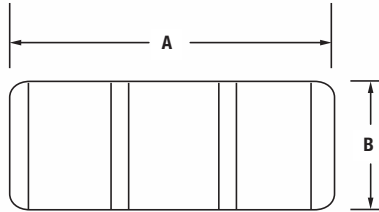

Color-Keyed® Compression

CAT. NO.	CABLE+ SIZE	DIMENSIONS (IN.)		INSTALLING TOOLS		
		A	B	DIE SET CAT. NO.	STRIP LENGTH (IN.)	COLOR CODE
54006	#4 AWG	2.00	.37	15CA29R	1½	GRAY
54007	#2 AWG	2.13	.41	15CA33R	1¾	BROWN
54008	#1 AWG	2.25	.47	15CA37R	1¾	GREEN
54009	1/0 AWG	2.38	.52	15CA42R	1¾	PINK
54010	2/0 AWG	2.38	.57	15CA45R	1¾	BLACK
54011	3/0 AWG	2.63	.63	15CA49R	1⅞	ORANGE
54012	4/0 AWG	2.69	.69	15CA54R	1⅞	PURPLE
54013	250 kcmil	3.19	.74	15CA60R	2¼	RUBY
54015	350 kcmil	4.13	.89	15CA71R	2¾	RED
54018	500 kcmil	4.13	1.06	15CA87R	2¾	BROWN
54023	750 kcmil	4.75	1.30	15CA106R	2¾	BLACK

* Cat. No. 15500-TB Die Adaptor required for TBM15I

+ Cable Size: Concentric and Compact strandings

Tooling: pp. B76-B92

Die Selector Chart: pp. B93-B95

Cast-Copper Two-Way Splice Connectors for 600V to 35KV Applications — Heavy-Duty



Material: Cast Copper

Finish: Electro Tin Plate

Satisfies requirements of NEC250-81 and 250-91 for connecting to the grounding electrode system.

AT. NO.	CABLE SIZE	DIE CODE
3504	8 AWG	29
53505	6 AWG	29
53506	4 AWG	29
53507	2 AWG	45
53508	1 AWG	45
53509	1/0 AWG	45
53510	2/0 AWG	66
53511	3/0 AWG	66
53512	4/0 AWG	66
53513	250 kcmil	76
53515	350 kcmil	99
53518	500 kcmil	99
53523	750 kcmil	112

Use hydraulic tools with hex dies.

Tooling: pp. B76-B92

Die Selector Chart: pp. B93-B95

Connectors for Copper Conductor

Compact design for low-profile installation.

Copper Reducing Splices

Thomas & Betts copper reducing splices are the most recent addition to the telecom line of copper compression lugs and connectors. They are designed for use in Central Office Equipment Installations in place of H-Taps in applications where the main cable is stepped down. When space is at a premium and standard H-Tap splicing options are too cumbersome, the Thomas & Betts reducing splices can be the right choice. These splices are available for a range of cables from 750 Flex to 6 Code.

- Requires less “real estate” in a Central Office
- Does not require a cover other than clear heat shrink
- One-person installation. Each side crimped separately
- Utilizes standard lug crimping dies. More standard tooling options. Lower tonnage tools can now install even the largest splice
- Hand tools can be used on splices for 500 Code/350 Flex and smaller
- Inspection holes verify cable is fully inserted into each barrel

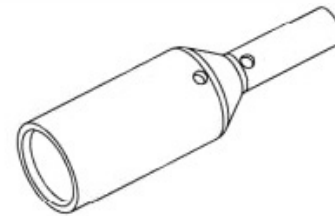

Splices for the following cable combinations are available. Appropriate quantities of pre-cut lengths of UL listed clear heat shrink are provided with each splice:

CAT. NO.	MAIN	COLOR CODE	BRANCH	COLOR CODE
TBRS75F-75C50FHS	750 Flex	YELLOW	750 Code/500 Flex	BLACK
TBRS75F-50C35FHS	750 Flex	YELLOW	500 Code/350 Flex	BROWN
TBRS75F-25C4/0FHS	750 Flex	YELLOW	250 Code/4/0 Flex	YELLOW
TBRS75C50F-75C50FHS	750 Code/500 Flex	BLACK	750 Code/500 Flex	BLACK
TBRS75C50F-50C35FHS	750 Code/500 Flex	BLACK	500 Code/350 Flex	BROWN
TBRS75C50F-25C4/0FHS	750 Code/500 Flex	BLACK	250 Code/4/0 Flex	YELLOW
TBRS75C50F-4/0CHS	750 Code/500 Flex	BLACK	4/0 Code	PURPLE
TBRS4/0C-2CHS	4/0 Code	PURPLE	2 Code	BROWN
TBRS4/0C-6CHS	4/0 Code	PURPLE	6 Code	BLUE
TBRS2/0C1/0F-2CHS	2/0 Code/1/0 Flex	BLACK	2 Code	BROWN
TBRS2/0C1/0F-6CHS	2/0 Code/1/0 Flex	BLACK	6 Code	BLUE
TBRS1/0C1F-2CHS	1/0 Code/1 Flex	PINK	2 Code	BROWN
TBRS1/0C1F-6CHS	1/0 Code/1 Flex	PINK	6 Code	BLUE
TBRS2C-6CHS	2 Code	BROWN	6 Code	BLUE

Tooling: pp. B76–B92

Die Selector Chart: pp. B93–B95

Connectors for Copper Conductor

Constant O.D. enables faster, easier installation than contoured design.

Cast-Copper Reducing Splices



Color-Keyed® Compression



Thomas & Betts takes the splicing of different-sized conductors to a new level of economy and efficiency with Color-Keyed Cast-Copper Reducing Splices. In addition to a lower cost, the key benefit to these splices is in their constant outer diameter. Unlike screw-machined, externally contoured splices, Cast-Copper Reducing Splices require no change of tool or die between crimping each end. Just slide

each wire easily into the chamfered barrel, and use the same Color-Keyed tool and die to crimp both ends. The consistent O.D. also makes these splices faster and easier to insulate with clear heat-shrink wrap than a contoured splice. Sand-cast construction ensures high tensile strength for heavy-duty applications, and tin-plated copper material provides high conductivity and superior corrosion-resistance.

- Ideal for telecom (inside office/outside plant), commercial, industrial MRO, and any other 600V-35KV applications requiring splicing of different-sized conductors
- Tin-plated, sand-cast copper construction provides superior tensile strength, high conductivity, and excellent corrosion-resistance
- Easier to install and insulate than screw-machined, contour-designed reducing splices
- Constant O.D. saves time on installation by eliminating the need for crimp-tool/die change
- Fast and simple to insulate with clear or colored heat-shrink wrap
- Chamfered barrel facilitates easy wire insertion
- Compact, low-profile design takes up minimal space in cable tray or wire run
- Simple installation with Color-Keyed® crimp tools

CAT. NO.	COND. 1 SIZE	COND. 2 SIZE	DIM. A	DIM. E	DIE CODE	DIE COLOR
251-30485-19	4/0 Str.	2 Str.	2 1/4"	1 1/16"	66	WHITE
251-30485-91	500mcm Str.	300mcm Str.	3 1/16"	1 1/16"	99	PINK
251-30485-229	2/0 Str.	250mcm Str.	2 3/8"	1 5/16"	76	BLUE
251-30485-247	2 Str.	8 Str.	1 9/16"	1 9/32"	45	BLACK
251-30485-294	4 Str.	2/0 Str.	2 1/4"	2 1/32"	66	WHITE
251-30485-295	4/0 Str.	4 Str.	2 1/4"	1 1/16"	66	WHITE
251-30485-331	4/0 Str.	350mcm Str.	3 5/16"	1 7/32"	99	PINK
251-30485-445	4/0 Str.	2/0 Str.	2 1/4"	1 3/16"	66	WHITE
251-30485-495	1/0 Str.	2 Str.	1 1/16"	1 1/32"	45	BLACK
251-30485-610	6 Str.	8 Str.	1 1/32"	3/4"	29	GRAY
251-30485-611	4 Str.	8 Str.	1 1/32"	3/4"	29	GRAY
251-30485-612	4 Str.	6 Str.	1 1/32"	3/4"	29	GRAY
251-30485-613	2 Str.	6 Str.	1 1/16"	1 9/32"	45	BLACK
251-30485-640	4/0 Str.	1/0 Str.	2 1/4"	1 3/16"	66	WHITE
251-30485-653	2 Str.	250mcm Str.	2 3/8"	1 5/16"	76	BLUE
251-30485-739	1/0 Str.	250mcm Str.	2 3/8"	1 5/16"	76	BLUE
251-30485-882	400mcm Str.	350mcm Str.	3 5/16"	1 7/32"	99	PINK
251-30485-950	1/0 Str.	6 Str.	1 1/16"	1 9/32"	45	BLACK
251-30485-951	6 Str.	2/0 Str.	2 1/4"	2 1/32"	66	WHITE
251-30485-1027	1/0 Str.	4 Str.	1 1/16"	1 9/32"	45	BLACK
251-30485-1029	1/0 Str.	#12 Str.	1 1/16"	2 3/64"	45	BLACK
251-30485-1030	10 Str.	4 Str.	1 1/32"	3/4"	29	GRAY
251-30485-1031	12 Str.	4 Str.	1 1/32"	3/4"	29	GRAY
251-30485-1032	#6 Str.	#10 Str.	1 1/32"	3/4"	29	GRAY
251-30485-1033	12 Str.	6 Str.	1 1/32"	3/4"	29	GRAY
251-30485-1034	14 Str.	8 Str.	1 1/32"	3/4"	29	GRAY
251-30485-1035	1 Str.	1/0 Str.	1 1/16"	1 9/32"	45	BLACK
251-30485-1044	10 Str.	8 Str.	1 1/32"	3/4"	29	GRAY
251-30485-1045	12 Str.	8 Str.	1 1/32"	3/4"	29	GRAY
251-30485-1085	10 Str.	1/0 Str.	1 1/16"	1 9/32"	45	BLACK
251-30485-1086	10 Str.	2/0 Str.	2 1/4"	2 1/32"	66	WHITE
251-30485-1087	4 Str.	250mcm Str.	2 3/8"	1 5/16"	76	BLUE
251-30485-1088	400mcm Str.	250mcm Str.	3 5/16"	1 7/32"	99	PINK
251-30485-1089	14 Str.	8 Sol.	1 1/32"	3/4"	29	GRAY
251-30485-1090	12 Str.	8 Sol.	1 1/32"	3/4"	29	GRAY
251-30485-1091	10 Str.	8 Sol.	1 1/32"	3/4"	29	GRAY
251-30485-1092	12 Str.	6 Sol.	1 1/32"	3/4"	29	GRAY
251-30485-1093	8 Str.	6 Sol.	1 1/32"	3/4"	29	GRAY
251-30485-1094	4 Str.	6 Sol.	1 1/32"	3/4"	29	GRAY
251-30485-1095	2 Str.	6 Sol.	1 1/16"	1 9/32"	45	BLACK
251-30485-1096	12 Str.	4 Sol.	1 1/32"	3/4"	29	GRAY
251-30485-1097	10 Str.	4 Sol.	1 1/32"	3/4"	29	GRAY
251-30485-1098	8 Str.	4 Sol.	1 1/32"	3/4"	29	GRAY
251-30485-1099	6 Str.	4 Sol.	1 1/32"	3/4"	29	GRAY
251-30485-1100	1/0 Str.	4 Sol.	1 1/16"	1 9/32"	45	BLACK
251-30485-1130	Cast Solid*	12-4 Str.	1 3/8"	3/4"	29 1	BLACK
251-30485-1245	1/0 Flex	#4 Flex	2 1/4"	1 1/16"	66	WHITE
251-30485-1246	#4 Flex	#8 Flex	1 1/16"	3 3/64"	45	BLACK

*Cast Solid — Field Modifiable Special

C-Tap Connectors for Copper Conductor

Positive, all-around compression with low resistance and high pull-out values.

C-Taps for 600V Applications

- Ideal for pigtailing, 2-way splicing or tapping to an unbroken continuous main
- Heavy reinforcing ribs help locate compression dies and strengthen compressed joint

Material: High-Conductivity Wrought Copper

Finish: Plain

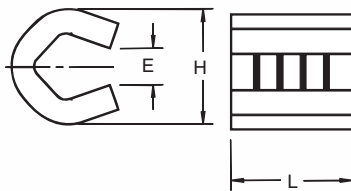

Figure 1

"E" represents gap in side

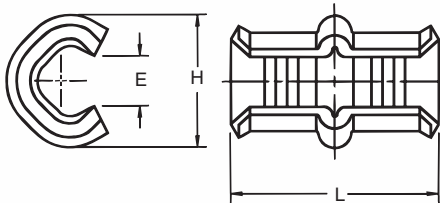

Figure 2

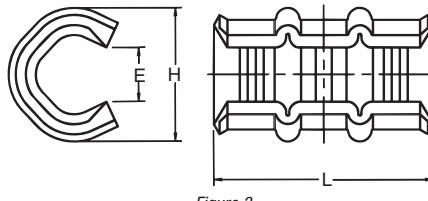

Figure 3



Cat. No.	FIG. NO.	DIMENSIONS (IN.)			COLOR KEY
		L	H	E	
54705	1	5/16	5/16	7/64	RED
54710	1	9/16	7/16	9/64	BLUE
54715	1	9/16	5/8	1/64	GRAY
54720	2	1 1/2	1 1/16	7/32	BROWN
54725	2	1 5/2	13/16	1/4	GREEN
54730	2	1 5/2	27/32	9/32	PINK
54735	3	1 11/16	7/8	21/64	BLACK
54740	3	1 11/16	31/32	23/64	ORANGE
54745	3	1 11/16	1 1/16	13/32	PURPLE
54750	3	1 11/16	1 1/8	15/32	YELLOW

UL approved for direct burial.

For covers see **page B48**.

Taps can be supplied tin-plated. Add suffix "TP" to any catalog number (i.e., 54725TP).

Typical Cable Combinations

MAIN	BRANCH							
	#12 SOL. OR STR.	#10 SOL. OR STR.	#8 SOL. OR STR.	#6 SOL. OR STR.	#4 STR.	#2 STR.	#1 STR.	1/0 STR.
#10 Sol. or Str.	54705	54710	54715	54715	54720	54730	54735	54740
#8 Sol. or Str.	54710	54715	54715	54720	54720	54730	54735	54740
#6 Sol. or Str.	54715	54715	54720	54720	54725	54730	54735	54740
#4 Str.	54720	54720	54720	54725	54730	54735	54740	54740
#2 Str.	54730	54730	54730	54730	54735	54740	54745	54745
#1 Str.	54735	54735	54735	54735	54740	54745	54745	54750
1/0 Str.	54740	54740	54740	54740	54740	54745	54750	54750
2/0 Str.	54745	54745	54745	54745	54745	54750	54750	
3/0 Str.	54750	54750	54750	54750	54750	54750		

Tooling: **pp. B76–B92**

Die Selector Chart: **pp. B93–B95**

United States
Tel: 901.252.8000
800.816.7809
Fax: 901.252.1354

Canada
Tel: 450.347.5318
Fax: 450.347.1976

Technical Services
Tel: 888.862.3289

Thomas & Betts

www.tnb.com

C-Tap Connectors for Copper Conductor

Easy to work with in tight spaces.

C-Taps — Large Size for 600V Applications

- More economical than other taps and split bolts in terms of purchase, inventory, installation time, insulation and maintenance
- Color-coded for easy matching with proper die
- Barely larger than conductor insulation once installed

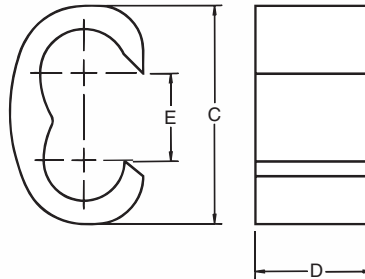

Material: High-Conductivity Wrought Copper

Finish: Plain



CAT. NO.	WIRE SIZE		DIMENSIONS (IN.)			INSTALLING DIE		DIE CODE	NO. OF CRIMPS	COLOR KEY
	MAIN	BRANCH	C	D	E	TOOL	CAT NO.			
54755	#1	#1				TBM14M	15512	76	1	BLUE
	1/0	1/0-#2				TBM15I	15512*	76		
	2/0	2/0-#4	1 ¹ / ₁₆	3/4	1 ¹ / ₂	TBM12	TBM12D-4	76		
	3/0	1/0-#6				13100A	15512	76		
54760	4/0	#1-#8				TBM14M	15506	87H	2	BROWN
	2/0	2/0-#1				TBM15I	15506*	87H		
	3/0	3/0-#3	1 ¹ / ₁₆	3/4	1 ¹ / ₂	TBM12	TBM12D-3	87H		
	4/0	4/0-#4				13100A	15506	87H		
54765	250 kcmil	#1-#8				TBM14M	15505	99H	2	PINK
	2/0	2/0-#1				TBM15I	15505*	99H		
	3/0	3/0-#2	1 ¹ / ₁₆	1	4 ¹ / ₄	TBM12	TBM12D-2	99H		
	4/0	4/0-#4				13100A	15505	99H		
54770	250 kcmil	3/0-#6				TBM14M	15515	106H	2	BLACK
	300 kcmil	2/0-#8				TBM15I	15515*	106H		
	4/0	4/0-2/0	1 ¹ / ₁₆	1	1 ¹ / ₁₆	TBM12	TBM12D-2	106H		
	350 kcmil	3/0-#6				13100A	15515	106H		
54775**	250 kcmil	250 kcmil				TBM14M	15504	115H	2	YELLOW
	300 kcmil	300-3/0				TBM15I	15504*	115H		
	350 kcmil	350-1/0	1 ¹ / ₁₆	1 ¹ / ₄	1 ¹ / ₁₆	TBM12	TBM12D-1	115H		
	400 kcmil	300-#2				13100A	15504	115H		
	450 kcmil	250-#4								
54780	500 kcmil	250-#6				TBM15I	15603	125H	2	N/A
	350 kcmil	350-4/0	2 ³ / ₁₆	1 ¹ / ₄	5 ³ / ₄					
	400 kcmil	400-2/0								
	450 kcmil	450-#1								
54785	750 kcmil	4/0-#6	2 ¹ / ₁₆	2	1	TBM15I	15603	125H	3	N/A
54790	750 kcmil	750-4/0	2 ¹ / ₁₆	2	1 ¹ / ₁₆	TBM15I	15603	125H	3	N/A

UL approved for direct burial.

For covers see **page B48**.

Taps can be supplied tin-plated. Add suffix "TP" to any catalog number (i.e., 54725TP).

* Cat. No. 15500-TB adapter required if using TBM15I and 155XX series dies.

** #6 AWG branch must be doubled.

Tooling: **pp. B76-B92**

Die Selector Chart: **pp. B93-B95**

Copper H-Tap Connectors for Copper Conductor

Copper H-Taps — 600V Application

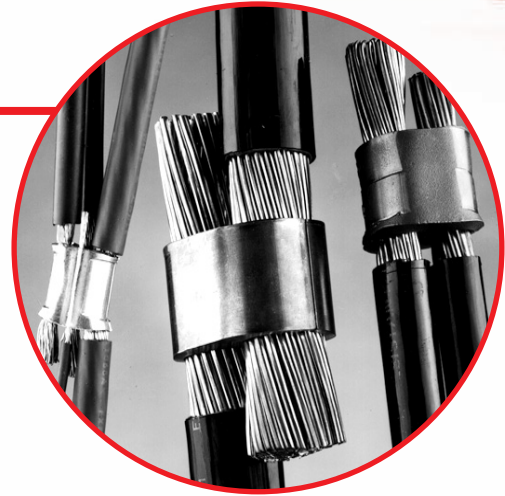
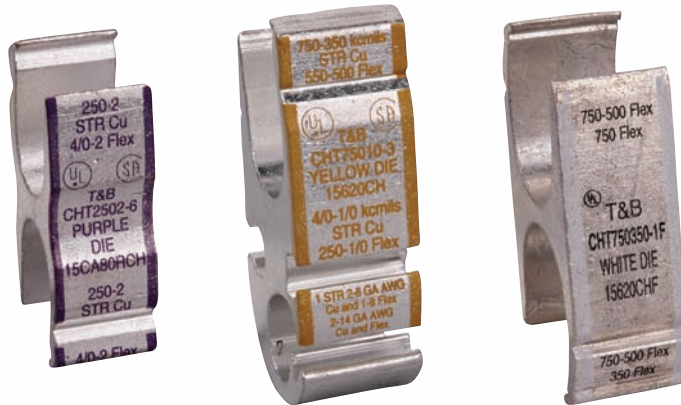

Color-Keyed Compression



CAT. NO.	FIG. NO.	COLOR CODE	CONDUCTOR SIZE CODE (FLEX CABLE)				CRIMPING INFORMATION						
			MAIN	BRANCH 1	BRANCH 2	BRANCH 3	HYDRAULIC HEAD	INSTALLING DIE	# OF CRIMPS	COLOR CODE	DIE CODE	STRIP LENGTH	INSULATING COVERS
CHT750350-1F	1	WHITE	(750-500) (750) Flex Only	(750-500) (350) Flex Only	—	—	TBM15I	15620CHF	1	WHITE	F	1 1/8"	HTC1000
CHT750350-2	2	YELLOW	750-500 (550-500)	750-500 (550-350)	—	—	TBM15I	15620CH	1	YELLOW	Z	1 1/8"	HTC500
CHT75010-3	9	YELLOW	750-350 (550-500)	4/0-1/0 (250-1/0)	1 Str. 2-6 AWG (1-8)	2-14 (2-14)	TBM15I	15620CH	1	YELLOW	Z	1 1/8"	
CHT50040-4	2	BROWN	500-250 (350-4/0)	500-4/0 (350-4/0)	—	—	TBM15I	15612CH	2	BROWN	N	1 1/8"	HTC40
CHT50010-5	3	BROWN	500-4/0 (350-4/0)	250-1/0 (4/0-1/0)	1 Str. 2-6 AWG (1-8)	8-14 (8-14)	TBM15I	15612CH	2	BROWN	N	1 1/8"	
CHT2502-6	2	PURPLE	250-2 (4/0-2)	250-2 (4/0-2)	—	—	•TBM15I TBM14M	15CA80RCH	1	PURPLE	80R	3/8"	HTC40
CHT25014-7	4	PURPLE	250-2 (4/0-2)	2-6 Str/Sol (2-8)	8-14 (8-14)	—	•TBM15I TBM14M	15CA80RCH	1	PURPLE	80R	1 1/8"	
CHT250214-8	5	PURPLE	250-2 (4/0-2)	8-14 (8-14)	8-14 (8-14)	—	•TBM15I TBM14M	15CA80RCH	1	PURPLE	80R	1 1/8"	
CHT214-9	6	BROWN	2-6 Str/Sol (2-8)	2-6 Str/Sol (2-8)	8-14 (8-14)	8-14 (8-14)	•TBM15I TBM14M 13100A	15CA71RCH	3	BROWN	71R	7/8"	HTC2S
CHT814-10	7	GREEN	8-14 (8-14)	8-14 (8-14)	—	—	•TBM15I TBM14M 13100A	15CA37RCH	1	GREEN	37R	1/2"	
CHT75040-11	8	YELLOW	750 Str. (750-500)	350-4/0 Str. Cu. & Flex	—	—	TBM15I	15620CH	1	YELLOW	Z	1 1/8"	HTC500

• Requires adapter Cat. No. 15500-TB when used with hydraulic head TBM15I.
 Material: Copper per ASTM designation
 B-124-55 Alloy 12
 Available packaged with HTC series covers Add "WC" to standard catalog number.
 Tooling: pp. B76-B92
 Die Selector Chart: pp. B93-B95

United States
 Tel: 901.252.8000
 800.816.7809
 Fax: 901.252.1354

Canada
 Tel: 450.347.5318
 Fax: 450.347.1976

Technical Services
 Tel: 888.862.3289

Thomas & Betts

www.tnb.com

Copper H-Tap Connectors for Copper Conductor

Copper H-Taps — 600V Application (continued)

Material: High-Conductivity Extruded Copper

Finish: Electro Tin Plate

Color-Keyed Compression

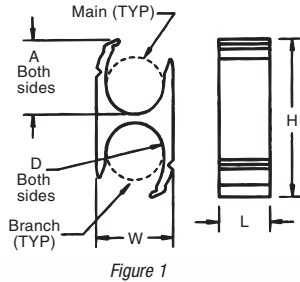

Figure 1

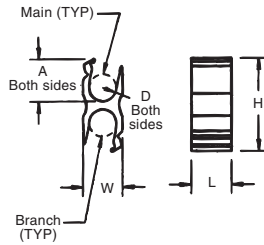

Figure 2

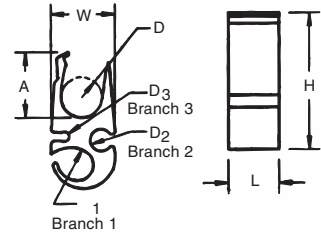

Figure 3

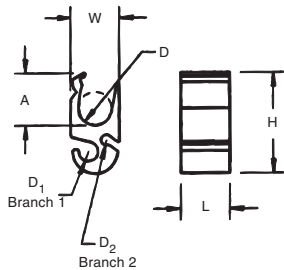

Figure 4

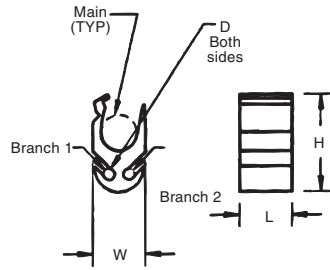

Figure 5

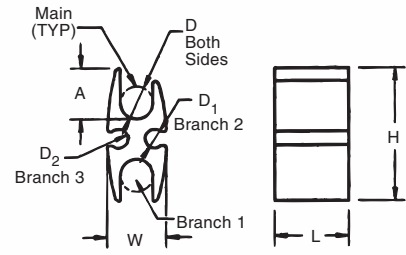

Figure 6

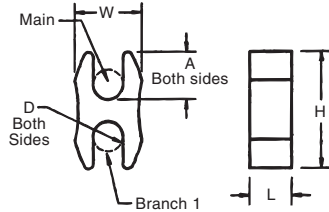

Figure 7

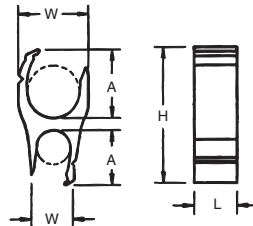

Figure 8

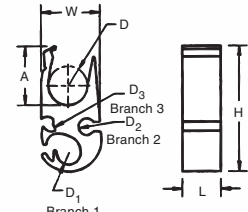

Figure 9



CAT. NO.	FIG. NO.	DIMENSIONS (IN.)							STRIP LENGTH (IN.)	INSULATING COVERS	
		H	W	L	A	D	D1	D2			D3
CHT750350-1F	1	3.46	1.66	1.10	1.73	1.23	—	—	—	1½	HTC1000
CHT750350-2	2	3.24	1.50	1.25	1.62	1.02	—	—	—	1½	
CHT75010-3	9	3.13	1.50	1.00	1.54	1.00	.40	0.35	0.41	1½	
CHT75040-11	8	3.19	(1) 1.65	1.00	(1) 1.61	(1) 1.24	—	—	—	1½	HTC500
				(2) 1.05		(2) 1.29	(2).80				
CHT50040-4	2	2.64	1.18	1.00	1.32	.80	—	—	—	1½	HTC40
CHT50010-5	3	2.28	1.30	1.00	1.20	.80	.67	.19	0.43	1½	
CHT2502-6	2	1.99	.90	.66	1.00	.62	—	—	—	¾	
CHT25014-7	4	1.63	.90	.90	.96	.52	0.35	0.19	—	1½	HTC2S
CHT250214-8	5	1.63	.90	.90	.96	0.62	0.19	0.19	—	¾	
CHT214-9	6	1.35	.60	0.75	0.50	0.33	0.19	0.19	—	¾	
CHT814-10	7	.62	0.60	0.37	0.25	0.16	—	—	—	¾	

Aluminum H-Tap Connectors

Exclusive FILLERLOK tab design.

Compression Taps for 600V — 90° C Applications

- H-type compression taps
- For aluminum-to-aluminum, aluminum-to-copper and copper-to-copper stranded-conductor applications
- Concentric and compact code strandings

Material: High-Conductivity Wrought Aluminum



Color-Keyed® Compression



CAT. NO.	COMBINATIONS		SIDE TAP	LENGTH (IN.)	COLOR KEY	DIE CODE CAT. NO.			
	MAIN	BRANCH				TBM6-TBM6S TBM60RS	HYDRAULIC TBM14M 13100A	TBM12 12-TON HEAD	TBM15I 15-TON HEAD
63105†	2-6	8-14	—	¾	ORANGE	13474 upper 13477 lower	15530	TBM12D-4	15530*
63110	4-6	4-6	—	1½	GREEN	13470	15501A	TBM12D-H	15001A*
63118	2/0-2	8-14	—	¾	GREEN	13470	15501A	TBM12D-H	15501A*
63125	2/0-2	1/0-6	—	1½	GREEN	13470	15501A	TBM12D-H	15501A*
63140	4/0-2/0	2-10	—	1½	BLUE	13471	15502	TBM12D-H	15502*
63148•	4/0-2/0	3/0-1	8-14	3	BLUE	—	15502	TBM12D-H	15502
63160	500-4/0	4/0-2	2-6	2¾	RED	—	—	—	15612
63169	750-4/0	750-4/0	—	3	BLACK	—	—	—	15620
63170	1000-500	1000-1/0	—	6	BLACK	—	—	—	15620
63180	750-350	350-1/0	1-6	3	BLACK	—	—	—	15620

* Use with adaptor Cat. No. 15500-TB

† 63105 also installed by TBM5/TBM5S with 13455 die or TBM8/TBM8S with 13462 die.

• 63148 — #1 CU or AL - wire bent double (hairpin)

For Smart Tool Installation

63110, 63118, 63125:

63140, 63148:

Use TBM8-750HG

Use TBM8-750BH

Tooling: pp. B76-B92

Die Selector Chart: pp. B93-B95

Interlocking Insulating Covers for H- and C-Type Compression Taps

Better covers for taps.

Soft Shell H-Tap/ C-Tap Covers

Thomas & Betts offers an improved design for one-piece covers of H-Tap and C-Tap connectors. The new design is more size-efficient and includes an easy latch mechanism. The new covers also contain flash barriers to help protect against electrical flashovers. The covers are molded from high impact polypropylene (UL94V-1) and are UL listed, CSA certified to 600V applications at 105° C.

Color-Keyed® Soft Shell Covers include these features:

- **Size-efficient design**
Won't take up as much room in the enclosure or vault, easier to store and carry to the job site
- **Easy Latch Mechanism**
Quick but sturdy cover latch for optimum insulation
- **Flash Barriers**
Provides protection from electrical flashovers
- **105° C Rating**
Offers maximum performance and higher than many competitor's temperature ratings
- **High-Impact Polypropylene**
Constructed from rugged materials for long-lasting protection

Also available in clear, impact-resistant and flame-retardant polycarbonate (UL94 V-0). The clear version includes an internal pocket for a visible identification label without opening the cover. Contact Customer Service for shipping and availability. See HTCVC2CLRFR-SD in table.



Smaller size requires less space in enclosure

High-impact polypropylene for rugged, dependable use

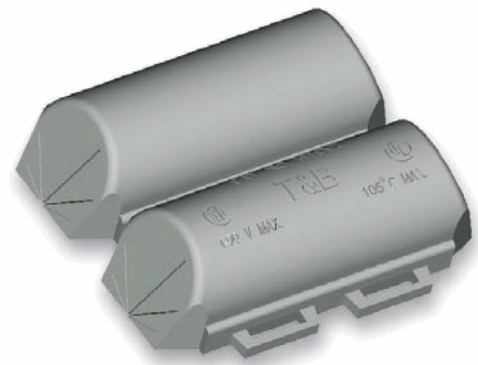

Easy latch mechanism



Clear, polycarbonate (UL94V-0) version available

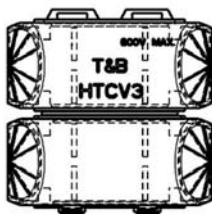

CAT. NO.	FOR H-TAPS	FOR C-TAPS	DIMENSIONS (IN.)			PKG. QTY.
			A	B	C	
HTCV1	CHT814-10	54705, 54710, 54715	1 3/4	7/8	5/8	5
HTCV2	CHT214-9, CHT250214-8, CHT25014-7, CHT2502-6	54770, 54775, 54780	3%	1 1/8	1	5
	CHT50010-5, CHT50040-4	54740, 54745, 54750, 54755, 54760, 54765	3 3/32	1%	1 1/8	5
HTCV4	CHT75010-3, CHT750350-2, CHT750350-1F, CHT75040-11	N/A	5%	2	1 1/8	5
HTCV2CLRFR	CHT214-9, CHT250214-8, CHT25014-7, CHT2502-6	N/A	3%	1 1/8	1	5

Interlocking Insulating Covers for H-Type Compression Taps

Quick and easy insulation for H-type compression taps.

Tap Insulating Covers (Soft Cover)

- Eliminates taping
- Provided with three positive locking latches and overlapping fringe for maximum cable insulation

Specifications

- Rating: 90° C, 600V. Made of flame-retardant, high-impact polypropylene.
- Material: Polypropylene
- Color: Black
- Voltage Rating: 600V max.
- Temperature: 90° C

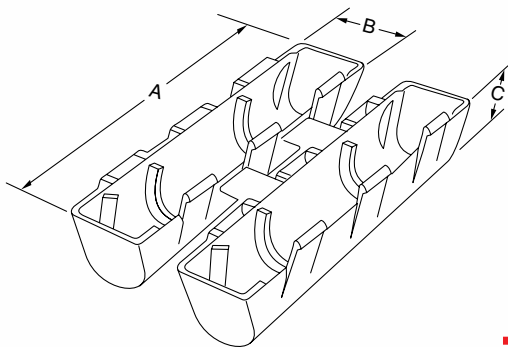

(C) Height — typical both halves



CAT. NO.	WIRE RANGE		AL H-TAPS	USE TO INSULATE	DIMENSIONS (IN.)			"A" DIM. "B" DIM.	
	MAX.	MIN.			A	B	C	"A" DIM.	"B" DIM.
HT20C	2/0	6	63110/63115 63125/63120	—	4½	1¼	1½	—	—
HT40C	4/0	6	63140 63148	—	5¾	1½	1¾	—	—
HT600C	500 MCM	2	63160	63169	6¾	2½	1¾	—	—
HT1000C	1000 MCM to 500 MCM	250 MCM to 1/0 AWG	63180	—	—	—	—	[184.15MM] 7.250	2.330 +.060
HT1000C-L	1000 MCM to 500 MCM	250 MCM to 250 MCM	63170	—	—	—	—	[263.40MM] 10.374	2.330 +.060

Interlocking Insulating Covers for H-Type Compression Taps

H-Tap Insulating Covers (Hard Covers)

- For use in splice boxes, indoors or in tray indoors
- Easy to use — simply place H-Tap in cover and snap cover closed
- Consult factory for available flame-retardant version
- Hard shell outer covers guard against impact... inner seal keeps out dust
- Installs quickly and easily without special tools — simply snaps together
- Eliminates time-consuming taping
- Provides high-quality, neat, uniform installations
- Range-taking design reduces inventory



CAT. NO.	DIMENSIONS (IN.)		
	A (LENGTH)	B (THICK)	C (WIDTH)
HTC2S	2	1 1/8	1 1/8
HTC2	3 1/2	1 1/8	1 1/8
HTC40	4 1/4	1 1/8	2
HTC40L2	5 1/4	1 1/8	2
HTC500	6	1 3/4	2 1/4
HTC1000	7	2 1/4	3 1/4
HTC1000L	10	2 1/4	3 1/4

Interlocking insulating covers for "H" type compression taps. For use in splice boxes, indoors or in tray indoors. Place the H-Tap in the cover. Snap the cover closed. Consult factory for flame-retardant version.

Technical Data:

HTC2 and HTC2S use insulation wrap instead of end cushions for inner seal.

Connector Cat. Nos. 54755 through 54790 and 63148 through 63180 require hydraulic crimping tools. Refer to instruction sheets.

Outer Hard Shell Covers — High Impact Black Thermoplastic (Noryl) Flammability Class, UL 94V-1

Inner seal — Black neoprene sponge soft closed cell, oxygen index 28% UL 94 HBF

Temperature Rating — 90° C Maximum

Voltage Rating — 600V maximum

Uses insulation wrap instead of end cushions for inner seal.

NOTE: Insulation covers are not reusable.

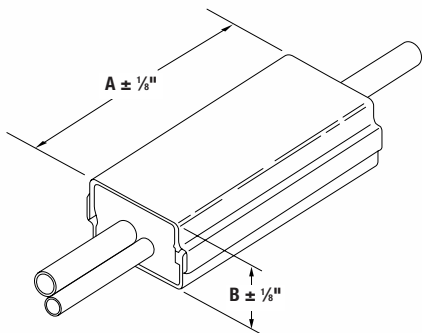

These insulating covers provide hard shell insulated protection for "H" type compression taps and splices, and because there is no taping required, you get uniform quality and appearance each time. The exclusive locking design provides the range taking capability. Only five H-tap insulating catalog cover numbers accommodate the range of 6 AWG — 1000 kcmil in the main, and 12 AWG — 500 kcmil in the branch.

For H-Tap Applications

CAT. NO.	AL	CU
	H-TAP	H-TAP
HTC2	63105	
HTC2S		CHT814-10
HTC40	63110	CHT214-9
	63118	CHT250214-8
	63125	CHT2514-7
	63140	CHT2502-6
HTC500	63148	CHT50010-5/CHT50040-4
	63160	CHT75010-3/CHT750350-2
HTC1000L	63170	
HTC1000	63180/63169	CHT750350-1F

For C-Tap Applications

CAT. NO.	C-TAP	COLOR
		CODE
HTC40	54720	BROWN
	54725	GREEN
	54730	PINK
	54755	BLUE
	54760	BROWN
HTC40L2	54735	BLACK
	54740	ORANGE
	54745	PURPLE
	54750	YELLOW
HTC500	54765	PINK
	54770	BLACK
	54775	YELLOW
	54780	WHITE
	54785	N/A
	54790	N/A

Wire Joints for Copper Conductor

All-around compression ensures high conductivity, low resistance and high pull-out values exceeding UL requirements.

Compression Wire Joints for Copper Conductor

- Ideal for pigtail, tapping multiple conductors or 2-way splicing
- Form a permanent installation in minimal space
- Easily insulated
- Offer lowest installed cost
- Made of high-conductivity copper and electro-tin-plated
- Colored-coded to dies for positive matching and compression

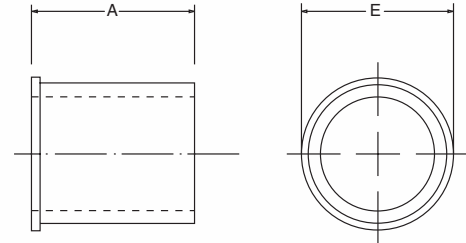

Color-Keyed® Compression



CAT. NO.	CIRCULAR MIL AREA		CONNECTOR RANGE				DIM. (IN.)	COLOR CODE	INSTALLING TOOLS				
	MIN.	MAX.	CABLE COMBINATION		A	E			HAND TOOLS			TBM6 & TBM6S	
			MIN.	MAX.					TBM25S/21E DIE CAT. NO.	TBM8/BS DIE CAT. NO.	TBM5/5S DIE CAT. NO.	UPPER	LOWER
54610	19,590	27,290	3 #12 sol. or str.	2 #10 w/1 #12 sol. or str.	.407	.370	BLUE	Included	—	—	13475	13477	
54615	31,140	43,400	3 #10 sol. or str.	4 #10 sol. or str.	.407	.430	GRAY	Included	13461	13454	13472	13476	
54620	49,530	65,560	3 #8 sol. or str.	1 #4 w/2 #10 sol. or str.	.417	.475	BROWN	Included	—	—	13474	—	
54625-TB	66,040	87,130	4 #8 sol. or str.	1 #2 str w/2 #12 sol. or str.	.479	.545	GREEN	—	—	—	—	—	
54630	83,480	99,990	2 #4 sol. or str.	2 #4 w/1 #10 sol. or str.	.479	.585	PINK	—	13462	13455	13475	13477	
54635	99,060	124,220	6 #8 str.	2 #4 w/2 #8 sol. or str.	.762	.620	BLACK	—	—	—	13474	—	
54640	125,220	166,120	3 #4 sol. or str.	3 #4 w/2 #10 sol. or str.	.762	.695	ORANGE	—	—	—	—	—	
54645-TB	166,960	193,630	4 #4 sol. or str.	2 #1 w/2 #10 sol. or str.	.824	.770	PURPLE	—	13463	13456	13475	—	
54650	189,190	244,020	3 #2 str.	2 #1/0 w/2 #8 str.	.887	.830	YELLOW	—	—	—	13473	13476	

Hand tools only.

UL Listed E9809 — code stranded

Tooling: pp. B76–B92

Die Selector Chart: pp. B93–B95

Cast Copper Bus Taps for Copper Conductor

Clamps onto bus bar — no drilling required.

Heavy-Duty Bus Bar Taps — Straight Barrel Angle for 600V to 35KV Applications

- For bus bars up to ¼" thick, 3-6" wide and code copper cable
- Takes up less than 1¼" of bus bar space
- Convex shape of connector tongue exerts great contact pressure on bus bar
- Installs with hydraulic tools and hex crimp dies

Material: High-Conductivity Cast Copper Alloy

Finish: Electro Tin Plate

Contact Material: Beryllium Copper

Finish: Silver

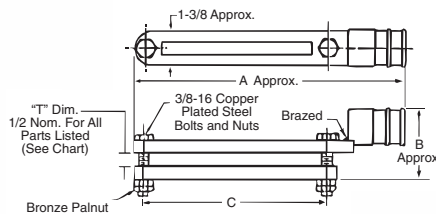

Figure 1

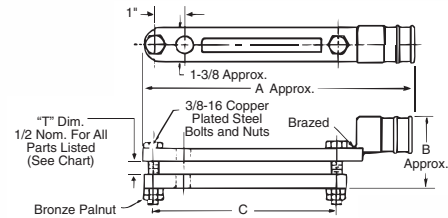

Figure 2

CAT. NO.	WIRE FLEX		FIG. NO.	BUSBAR WIDTH	DIMENSIONS (IN.)			DIE CODE
	CODE	FLEX			A	B	C	
251-31446-1			1	3	6 5/8	2 5/8	3 1/2	66H
251-31446-7	1/0	225/24	1	4	7 1/8	2 5/8	4 1/2	66H
251-31446-13			2	5 or 6	9 1/8	2 5/8	6 1/8	66H
251-31446-8	2/0	1/0	1	4	7 1/8	2 5/8	4 1/2	66H
251-31446-14		275/24	2	5 or 6	9 1/8	2 5/8	6 1/8	66H
251-31446-23			1	3	6 1/8	2 5/8	3 1/2	66H
251-31446-22	4/0	450/24	1	4	7 1/8	2 5/8	4 1/2	66H
251-31446-19			2	6	9 1/8	2 5/8	6 1/8	66H
251-31446-29	250	4/0	1	3	5 1/8	2 5/8	3 3/8	66H
251-31446-30	kcmil	550/24	1	4	7 1/8	2 5/8	4 1/2	66H
251-31446-31			1	5 or 6	9 1/8	2 5/8	6 1/8	66H
251-31446-3	350		1	3	6 1/8	2 1/8	3 1/2	99H
251-31446-9	kcmil		1	4	7 1/8	2 1/8	4 1/2	99H
251-31446-15			2	5 or 6	9 1/8	2 1/8	6 1/8	99H
251-31446-4	500	350	1	3	6 1/8	2 1/8	3 1/2	99H
251-31446-10	kcmil	925/24	1	4	7 1/8	2 1/8	4 1/2	99H
251-31446-16			2	5 or 6	9 1/8	2 1/8	6 1/8	99H
251-31446-17	600		2	5 or 6	9 1/8	2 1/8	6 1/8	112H
	kcmil							
251-31446-21	700		1	6	9 1/8	2 1/8	6 1/8	112H
	kcmil							
251-31446-6	750	500	1	3	6 1/8	2 1/8	3 1/2	112H
251-31446-12	kcmil	1325/24	2	4	7 1/8	2 1/8	4 1/2	112H
251-31446-18			2	5 or 6	9 1/8	2 1/8	6 1/8	112H
251-31446-36		750	2	5 or 6	9 1/8	2 1/8	6 1/8	112H
		1925/24						

Styles shown have cable tap on one portion of clamp assembly. Clamp assemblies with cable taps on both portions (top & bottom identical) are also available. These assemblies are identified by adding suffix "AD" to part numbers shown. **Example: 251-31446-1AD**

Only use hydraulic tools with hex crimp dies.

Tooling: pp. B76-B92

Die Selector Chart: pp. B93-B95

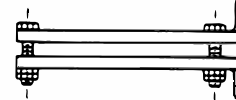

Motor Pigtail Connectors

Quick, reliable change-out of electric motors with no bolting, taping or loose connections.

Motor Lead Disconnects

- Complete line of motor lead disconnects for 600V and 5kv applications, covering wire range from #16 through 4/0 AWG
- Fast, snap-together assembly offers maximum labor savings
- No need for nuts, bolts and washers or insulating tape — simply slide on reusable boot
- Total assembly fits into tight motor housings
- Quick disconnect — no knife cutting of melted tape, eliminating the risk of accidental cutting of wire insulation, resulting motor downtime and installer exposure
- Meet or exceed electrical and mechanical performance of bolted connections
- Constructed of high-conductivity copper with tin-plating
- Female disconnects equipped with beryllium copper interface band for dependable connections



Color-Keyed Compression

Motor Pigtail Connector — One Line to One Load (2 Wire)

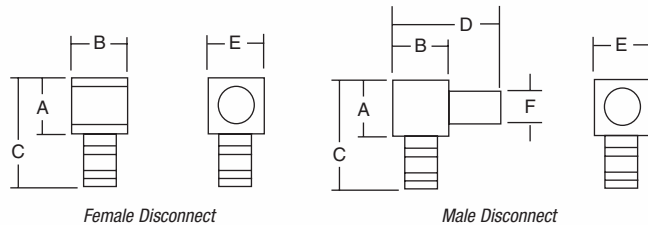

CAT. NO.		WIRE SIZE	BODY SIZE	COLOR CODE	BOOT INSULATION	DIMENSIONS (IN.)						STRIP LENGTH (IN.)
FEMALE DISCONNECT	MALE DISCONNECT					A	B	C	D	E	F	
MD1614F-0	MD1614M-0	16-14 AWG	0	BLUE	MDBOOT-0	.25	.25	.63	.52	.25	.125	3/8
MD1614F-1	MD1614M-1	16-14 AWG	1	BLUE	MDBOOT-1	.38	.38	.78	.75	.38	.250	3/8
MD1210F-1	MD1210M-1	12-10 AWG	1	YELLOW	MDBOOT-1	.38	.38	.78	.75	.38	.250	3/8
MD1210F-2	MD1210M-2	12-10 AWG	2	YELLOW	MDBOOT-2	.50	.50	.90	1.00	.50	.370	3/8
MD8F-1	MD8M-1	8 AWG	1	RED	MDBOOT-1	.38	.38	.82	.75	.38	.250	7/16
MD8F-2	MD8M-2	8 AWG	2	RED	MDBOOT-2	.50	.50	.95	1.00	.50	.370	7/16
MD6F-1	MD6M-1	6 AWG	1	BLUE	MDBOOT-1	.38	.38	.88	.75	.38	.250	1/2
MD6F-2	MD6M-2	6 AWG	2	BLUE	MDBOOT-2	.50	.50	1.02	1.00	.50	.370	1/2
MD4F-2	MD4M-2	4 AWG	2	GRAY	MDBOOT-2	.50	.50	1.06	1.00	.50	.370	1/2
MD2F-2	MD2M-2	2 AWG	2	BROWN	MDBOOT-2	.50	.50	1.09	1.00	.50	.370	17/32
MD2F-3	MD2M-3	2 AWG	3	BROWN	MDBOOT-3	.88	.88	1.46	1.75	.88	.500	17/32
MD1F-2	MD1M-2	1 AWG	2	GREEN	MDBOOT-2	.50	.50	1.23	1.00	.50	.370	9/16
MD1F-3	MD1M-3	1 AWG	3	GREEN	MDBOOT-3	.88	.88	1.56	1.75	.88	.500	9/16
MD10F-3	MD10M-3	1/0 AWG	3	PINK	MDBOOT-3	.88	.88	1.56	1.75	.88	.500	9/16
MD20F-3	MD20M-3	2/0 AWG	3	BLACK	MDBOOT-3	.88	.88	1.59	1.75	.88	.500	3/4
MD30F-3	MD30M-3	3/0 AWG	3	ORANGE	MDBOOT-3	.88	.88	1.71	1.75	.88	.500	11/16
MD40F-3	MD40M-3	4/0 AWG	3	PURPLE	MDBOOT-3	.88	.88	1.81	1.75	.88	.500	3/4
MD40F-4	MD40M-4	4/0 AWG	4	PURPLE	MDBOOT-4	1.25	1.25	2.89	2.69	1.25	.813	—
MD250F-4	MD250M-4	250 kcmil	4	YELLOW	MDBOOT-4	1.25	1.25	2.89	2.69	1.25	.813	—
MD350F-4	MD350M-4	350 kcmil	4	RED	MDBOOT-4	1.25	1.25	2.89	2.69	1.25	.813	—
MD500F-4	MD500M-4	500 kcmil	4	BROWN	MDBOOT-4	1.25	1.25	2.89	2.69	1.25	.813	—

Tooling: pp. B76–B92

Die Selector Chart: pp. B93–B95

United States
Tel: 901.252.8000
800.816.7809
Fax: 901.252.1354

Canada
Tel: 450.347.5318
Fax: 450.347.1976

Technical Services
Tel: 888.862.3289

Thomas & Betts

www.tnb.com

Motor Pigtail Connectors

Motor Pigtail Connector — One Line to One Load (2 Wire) (continued)

Quick, easy installation!

- 1 Choose appropriate Color-Keyed® disconnect for conductor size to be terminated. Note color of bands on disconnect barrel.
- 2 Select proper installing die by matching die color to disconnect barrel color bands.
- 3 Install die in T&B tool, insert stripped wire into barrel of disconnect and compress between color bands. Repeat for mating half.
- 4 Snap the two halves together and slip on insulator over mated connection. Secure insulator with TY-RAP® cable ties provided with the insulators.

Material: High-Conductivity Copper

Plating: Tin

Insulator: Thermoplastic Elastomer



600V Version



5KV Version



CAT. NO.		WT112M WT111M WT2000 ERG2002	TBM25S TBM20S	INSTALLING TOOLS				HYDRAULIC TOOLS & TBM50S HAND TOOL	
FEMALE DISCONNECT	MALE DISCONNECT			TBM6, TBM6S, TBM60RS		TBM5 TBM5S	TBM8 TBM8S	DIE CODE	COLOR
				UPPER DIE	LOWER DIE	DIE SET	DIE SET		
MD1614F-0	MD1614M-0	X	—	—	—	—	—	—	—
MD1614F-1	MD1614M-1	X	—	—	—	—	—	—	—
MD1210F-1	MD1210M-1	X	—	—	—	—	—	—	—
MD1210F-2	MD1210M-2	X	—	—	—	—	—	—	—
MD8F-1	MD8M-1	—	X	13475	13477	13454	13461	21	RED
MD8F-2	MD8M-2	—	X	13475	13477	13454	13461	21	RED
MD6F-1	MD6M-1	—	X	13475	13477	13454	13461	24	BLUE
MD6F-2	MD6M-2	—	X	13475	13477	13454	13461	24	BLUE
MD4F-2	MD4M-2	—	X	13472	13476	13454	13461	29	GRAY
MD2F-2	MD2M-2	—	X	13474	13477	13454	13461	33	BROWN
MD2F-3	MD2M-3	—	X	13474	13477	13454	13461	33	BROWN
MD1F-2	MD1M-2	—	—	13474	13477	13455	13462	37	GREEN
MD1F-3	MD1M-3	—	—	13474	13477	13455	13462	37	GREEN
MD10F-3	MD10M-3	—	—	13475	13477	13455	13462	42	PINK
MD20F-3	MD20M-3	—	—	13474	13477	13455	13462	45	BLACK
MD30F-3	MD30M-3	—	—	13474	13477	13455	13462	50	ORANGE
MD40F-3	MD40M-3	—	—	13475	13477	13456	13463	54	PURPLE

Specifications:

Wire range: No. 16 to 4/0 AWG

Rating: 600V, 90°C

Tooling: pp. B76–B92

Die Selector Chart: pp. B93–B95

Motor Pigtail Connectors

Motor Pigtail Connector — One Line to Two Load (3 Wire)

- KON-TOUR® louvered contact bands
- Color-coded to match installing dies

Material: High-Conductivity Wrought Copper

Finish: Electro-Tin Plate

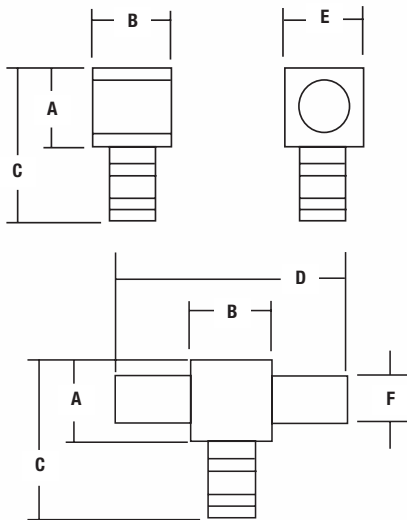

Color-Keyed Compression



CAT. NO.		WIRE SIZE	BODY SIZE	COLOR CODE	BOOT INSULATION	DIMENSIONS (IN.)						STRIP LENGTH (IN.)
FEMALE DISCONNECT	MALE DISCONNECT					A	B	C	D	E	F	
MD1614F-0	M2D1614M-0	16-14 AWG	0	BLUE	MDBOOT-1	.250	.250	.63	.77	.25	.12	3/8
MD1210F-1	M2D1210M-1	12-10 AWG	1	YELLOW	M2DBOOT-1	.380	.380	.780	.750	.380	.25	3/8
MD1210F-2	M2D1210M-2	12-10 AWG	2	YELLOW	M2DBOOT-2	.500	.500	.900	1.500	.500	.37	3/8
MD8F-1	M2D8M-1	8 AWG	1	RED	M2DBOOT-1	.380	.380	.820	1.125	.380	.25	7/16
MD8F-2	M2D8M-2	8 AWG	2	RED	M2DBOOT-2	.500	.500	.950	1.500	.500	.37	7/16
MD6F-1	M2D6M-1	6 AWG	1	BLUE	M2DBOOT-1	.380	.380	.875	1.125	.380	.25	1/2
MD6F-2	M2D6M-2	6 AWG	2	BLUE	M2DBOOT-2	.500	.500	1.020	1.500	.500	.37	1/2
MD4F-2	M2D4M-2	4 AWG	2	GRAY	M2DBOOT-2	.500	.500	1.060	1.500	.500	.37	1/2
MD2F-2	M2D2M-2	2 AWG	2	BROWN	M2DBOOT-2	.500	.500	1.090	1.500	.500	.37	17/32
MD2F-3	M2D2M-3	2 AWG	3	BROWN	M2DBOOT-3	.875	.875	1.460	2.630	.875	.50	17/32
MD1F-2	M2D1M-2	1 AWG	2	GREEN	M2DBOOT-2	.50	.50	1.230	1.500	.500	.37	9/16
MD1F-3	M2D1M-3	1 AWG	3	GREEN	M2DBOOT-3	.875	.875	1.560	2.630	.875	.50	9/16
MD10F-3	M2D10M-3	1/0 AWG	3	PINK	M2DBOOT-3	.875	.875	1.560	2.630	.875	.50	9/16
MD20F-3	M2D20M-3	2/0 AWG	3	BLACK	M2DBOOT-3	.875	.875	1.590	2.630	.875	.50	5/8
MD30F-3	M2D30M-3	3/0 AWG	3	ORANGE	M2DBOOT-3	.875	.875	1.710	2.630	.875	.50	11/16
MD40F-3	M2D40M-3	4/0 AWG	3	PURPLE	M2DBOOT-3	.875	.875	1.810	2.630	.875	.50	3/4

Operating Range: 600V max., 1000V max. in signs and fixtures.

Listing: UL Listed and CSA Certified for 12-8 AWG solid copper conductors and stranded copper conductors in the sizes shown.

Selection: Always use the same body size when selecting male and female disconnects. For example, to connect a 2 AWG male to an 8 AWG female, select Catalog Numbers M2D2M-2 and MD8F-2. Both have body size 2.

Insulation: Use insulating boots matching the disconnect body size as indicated in the chart. To protect the connection from moisture and dirt use sealing compound Catalog Number MDBOOT-SEAL.

Tooling: pp. B76-B92

Die Selector Chart: pp. B93-B95

United States
Tel: 901.252.8000
800.816.7809
Fax: 901.252.1354

Canada
Tel: 450.347.5318
Fax: 450.347.1976

Technical Services
Tel: 888.862.3289

Thomas & Betts

www.tnb.com

Motor Pigtail Connectors

Motor Pigtail Connector — One Line to Two Load (3 Wire) (continued)

- KON-TOUR louvered contact bands
- Color-coded to match installing dies

Material: High-Conductivity Wrought Copper

Finish: Electro-Tin Plate

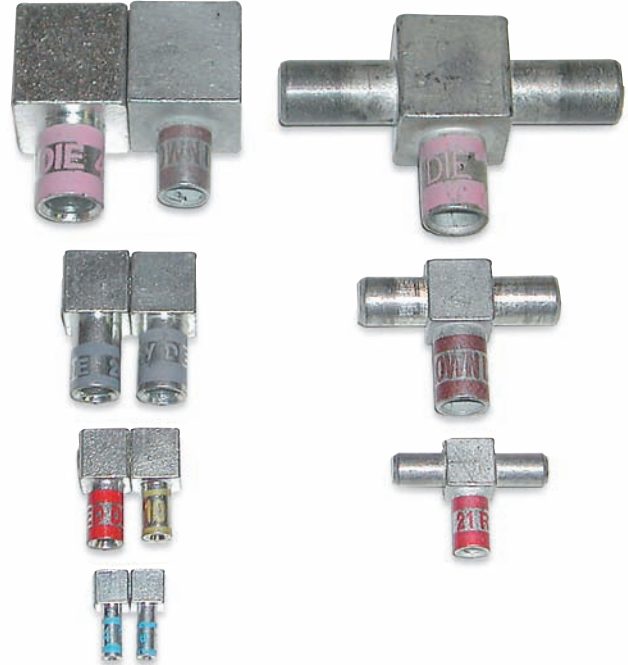
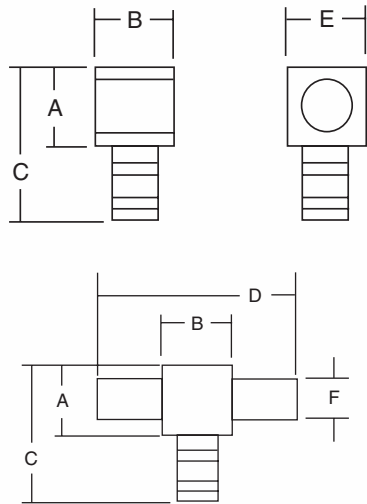

CAT. NO.		WT112M WT111M ERG 2002 WT2000	TBM25S	INSTALLING TOOLS				HYDRAULIC TOOLS		COLOR
FEMALE DISCONNECT	MALE DISCONNECT			TBM6, TBM6S, TBM60RS UPPER DIE	TBM5 TBM5S DIE SET	TBM8 TBM8S DIE SET	TBM5 TBM5S DIE SET	TBM8 TBM8S DIE SET	DIE CODE	
MD1614F-0	M2D1614M-0	X	—	—	—	—	—	—	—	BLUE
MD1210F-1	M2D1210M-1	X	—	—	—	—	—	—	—	YELLOW
MD1210F-2	M2D1210M-2	X	—	—	—	—	—	—	—	YELLOW
MD8F-1	M2D8M-1	—	X	13475	13477	13454	13461	21	—	RED
MD8F-2	M2D8M-2	—	X	13475	13477	13454	13461	21	—	RED
MD6F-1	M2D6M-1	—	X	13475	13477	13454	13461	24	—	BLUE
MD6F-2	M2D6M-2	—	X	13475	13477	13454	13461	24	—	BLUE
MD4F-2	M2D4M-2	—	X	13472	13476	13454	13461	29	—	GRAY
MD2F-2	M2D2M-2	—	X	13474	13477	13454	13461	33	—	BROWN
MD2F-3	M2D2M-3	—	X	13474	13477	13454	13461	33	—	BROWN
MD1F-2	M2D1M-2	—	—	13474	13477	13455	13462	37	—	GREEN
MD1F-3	M2D1M-3	—	—	13474	13477	13455	13462	37	—	GREEN
MD10F-3	M2D10M-3	—	—	13475	13477	13455	13462	42	—	PINK
MD20F-3	M2D20M-3	—	—	13474	13477	13455	13462	45	—	PINK
MD30F-3	M2D30M-3	—	—	13474	13477	13455	13462	50	—	ORANGE
MD40F-3	M2D40M-3	—	—	13475	13477	13456	13463	54	—	PURPLE

Tooling: pp. B76-B92

Die Selector Chart: pp. B93-B95

Motor Pigtail Connectors

5KV Motor Pigtail Connector Supplied with Boot, Pin, Silicon Gel (Two Female Connectors Required)

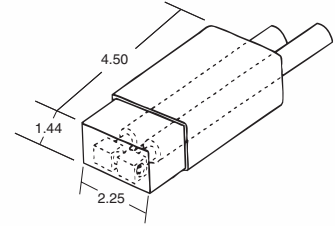
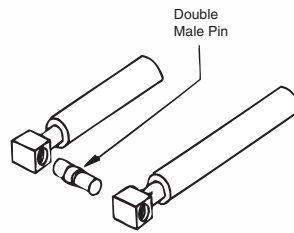

CAT. NO.	WIRE RANGE AWG.	FEMALE DISCONNECT CAT. NO.	COLOR CODE	DIMENSIONS (IN.)			BODY SIZE
				L	W	H	
5KVB00T-2L	#8	MD8F-2	RED	4.50	2.25	1.44	2
5KVB00T-2L	#6	MD6F-2	BLUE	4.50	2.25	1.44	2
5KVB00T-2L	#4	MD4F-2	GRAY	4.50	2.25	1.44	2
5KVB00T-2L	#2	MD2F-2	BROWN	4.50	2.25	1.44	2
5KVB00T-2L	#1	MD1F-2	GREEN	4.50	2.25	1.44	2
5KVB00T-3L	#2	MD2F-3	BROWN	4.50	2.25	1.44	3
5KVB00T-3L	#1	MD1F-3	GREEN	4.50	2.25	1.44	3
5KVB00T-3L	1/0	MD10F-3	PINK	4.50	2.25	1.44	3
5KVB00T-3L	2/0	MD20F-3	BLACK	4.50	2.25	1.44	3
5KVB00T-3L	3/0	MD30F-3	ORANGE	4.50	2.25	1.44	3
5KVB00T-3L	4/0	MD40F-3	PURPLE	4.50	2.25	1.44	3

Color-Keyed Compression

For easy, reliable sealing of motor-disconnect boots.

Sealant

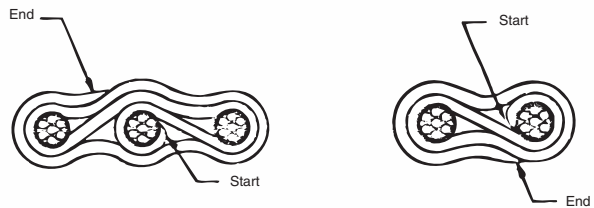

Sealant should be used with T&B MOTOR-DISCONNECT Boots: MDBOOT-0, MDBOOT-1, MDBOOT-2 and MDBOOT-3.

The cable should be clean and free of grease, and other foreign substances. Apply two layers around each cable at the same distance from the connector. Slide the assembly into boot, apply TY-RAP® cable ties and work sealant around wires at end of boot to eliminate voids.

Specifications

- Description: Polybutene Compound
- Application Temperature: 40° F to 100° F
- Service Temperature: -40° F to 180° F
- Dimensions: Width 1", Thickness 1/8", Length (Std. Roll) 10', wrapped on release liner
- Environmental Resistance: Resists normal aging process
- Chemical Resistance: Resists acids, bases and alcohols
- Dielectric Strength: 200 v/mil minimum
- Volume Resistivity: 1013 ohms/cm
- Flame Retardancy: Pass V0 Vertical Flame Test

CAT. NO.	DESCRIPTION
MDBOOT-SEAL	Sealant

For water-tight applications, contact technical services.

Tooling: pp. B76-B92

Die Selector Chart: pp. B93-B95

United States
Tel: 901.252.8000
800.816.7809
Fax: 901.252.1354

Canada
Tel: 450.347.5318
Fax: 450.347.1976

Technical Services
Tel: 888.862.3289

Thomas & Betts

www.tnb.com

KUBE™ Connectors

Make economical, field-constructible, UL Listed multiple-tap electrical connections!

KUBE™ Connectors Multi-Tap

Leave it to Color-Keyed® to bring you the most versatile, affordable solution for multiple-load installations from a single main conductor. The KUBE™ Multi-Tap system gangs multiple permanent, dependable compression taps mounted on a high-conductivity copper rod to achieve a space- and cost-efficient UL Listed multiple-tap connection you configure in the field. For even more flexibility, you can rotate connectors individually on the Multi-Tap rod to accommodate the bends and angles necessary to install equipment or complete circuitry – without the high cost of flexible-conductor cable.

- Lowest installed cost for the application – eliminates the need for expensive flexible-conductor cable
- Individual connectors can be rotated 360° on rod for multi-directional connections
- Versatile, modular design supports a myriad of connection possibilities
- UL 486AB Listed and CSA Certified for field installation
- Compression connections maintain integrity even under vibration and high temperatures
- Supports wire sizes from #16 to 4/0 AWG
- Suitable for applications up to 600 volts (1000 volts in signs and fixtures)
- Rods constructed of high-conductivity copper with corrosion-resistant tin plating
- Connectors constructed of electro-tin-plated high-conductivity copper with louvered contact bands for reliable connections and color coding for easy selection of crimping die
- Two-piece, UL94-V0-rated, polycarbonate insulators snap onto connectors easily for fast, safe installation

Typical Applications

- Commercial construction
- Specialized installations for entertainment applications
- Gutter taps for all applications
- Any other application requiring the running of multiple loads from a main conductor



This Multi-Tap installation connects 4/0, 1 and 2 AWG cables using MD40F-3, MD1F-3 and MD2F-3 connectors with REC-3 insulators on an R3-6 rod.

KUBE™ Connectors

KUBE™ Multi-Tap makes field installation fast and easy.



1. Crimp Multi-Tap connectors onto cables.



2. Snap Multi-Tap insulators over connectors.



3. Remove one end nut and spacers from Multi-Tap rod.



4. Slide connector/insulator assemblies onto rod.



5. If any rod positions remain empty, slide on appropriate number of spacers to fill rod.



6. Reapply end nut and tighten.

How to Order KUBE™ Multi-Tap

- Choose your connectors. Note that connectors to be mounted on a single Multi-Tap rod can be for different wire sizes but must be of the same body size.
- Choose insulators of the appropriate body size for the connectors. (One insulator required for each connector.)
- Choose a Multi-Tap rod that matches the body size of your connectors and that has enough positions for the number of connections you need.

KUBE™ Multi-Tap Connectors



CAT. NO.	WIRE SIZE	BODY SIZE	COLOR CODE
MD1614F-0	16-14 AWG	0	BLUE
MD1614F-1	16-14 AWG	1	BLUE
MD1210F-1	12-10 AWG	1	YELLOW
MD1210F-2	12-10 AWG	2	YELLOW
MD8F-1	8 AWG	1	RED
MD8F-2	8 AWG	2	RED
MD6F-1	6 AWG	1	BLUE
MD6F-2	6 AWG	2	BLUE
MD4F-2	4 AWG	2	GRAY
MD2F-2	2 AWG	2	BROWN
MD2F-3	2 AWG	3	BROWN
MD1F-2	1 AWG	2	GREEN
MD1F-3	1 AWG	3	GREEN
MD10F-3	1/0 AWG	3	PINK
MD20F-3	2/0 AWG	3	BLACK
MD30F-3	3/0 AWG	3	ORANGE
MD40F-3	4/0 AWG	3	PURPLE

Please note that these connectors are the same as our female motor pigtail connectors. For more information on dimensions, compression tool selection and required strip length, see pages B-53 to B-56.

KUBE™ Multi-Tap Insulators

One insulator required for each connector.



CAT. NO.	FOR CONNECTOR BODY SIZE
REC-0	0
REC-1	1
REC-2	2
REC-3	3

KUBE™ Multi-Tap Rods

Includes rod with spacers and end nuts. Rod positions indicate the maximum number of connectors the rod can hold. Spacers are provided to fill any unused positions left open for future connections. Body size of connectors, insulators and rod must match.

CAT. NO.	FOR CONNECTOR BODY SIZE	NO. OF ROD POSITIONS
R0-4	0	4
R0-6	0	6
R0-8	0	8
R0-10	0	10
R0-12	0	12
R1-4	1	4
R1-6	1	6
R1-8	1	8
R1-10	1	10
R1-12	1	12
R2-4	2	4
R2-6	2	6
R2-8	2	8
R2-10	2	10
R2-12	2	12
R3-4	3	4
R3-6	3	6
R3-8	3	8
R3-10	3	10
R3-12	3	12

Color-Keyed Compression

KUBE™ Connectors

A cost-saving breakthrough in 90° and T-connections.

KUBE™ Flag and Tee Connectors

Finally there's a fast, easy and affordable way to make those 90° and T electrical connections whenever and wherever you need them. Color-Keyed® Flags and Tees are designed — and UL/CSA approved — to be used with standard Color-Keyed® lugs and splices from #8 through 4/0 AWG in field-assembled configurations.

Now you don't need to use high-cost flexible conductor for connections requiring 90° bending radius or expensive brazed or welded connectors for T connections! Insulated with custom-fit, halogen-free polypropylene for safety and performance, Color-Keyed® Flags and Tees are available in bulk quantities for OEM applications and in a convenient kit for field use.

- Offers lowest installed cost for the application
- Versatile, modular design enables thousands of field-constructible connection possibilities, including multi-circuit configurations
- UL Listed and CSA Certified for field installation
- Insulated for fast, safe termination and installation
- Used with standard Color-Keyed® lugs and splices
- Color coded for easy selection of correct crimping die and easy verification of proper crimp
- Constructed from high-conductivity, low-resistance 99.9% pure wrought copper for optimum electrical performance
- Tin plated for corrosion resistance and excellent contact

..... Specifications

- Connector: Tin-plated copper
- Insulation: Halogen-free polypropylene
- Standards: UL 486, CSA 22.2 #65

Make on-site custom electrical connections in:

- 90° lugs (lugs can rotate 360°)
- 90° splices
- Countless connection possibilities using any straight or angled lug from 15° to 90° (lugs can rotate 360° for easy positioning)
- T-lugs
- T-splices



Flag & Tee Kit Contents:

- Steel carrying case
- TBM25S crimp tool
- 25 each #8, #6 and #4 AWG flag bodies
- 25 each #8, #6 and #4 AWG one-hole lugs
- 10 each #2, #1, 1/0, 2/0, 3/0 and 4/0 AWG flag bodies
- 10 each #2, #1, 1/0, 2/0, 3/0 and 4/0 AWG one-hole lugs
- 50 size 1 flag insulators
- 45 size 2 flag insulators
- 40 size 3 flag insulators
- 10 each #8 and #6 AWG tee bodies
- 20 each #8 and #6 AWG two-way splices
- 6 each #4, #2 and #1 AWG tee bodies
- 12 each #4, #2 and #1 AWG two-way splices
- 3 each 1/0, 2/0, 3/0 and 4/0 AWG tee bodies
- 6 each 1/0, 2/0, 3/0 and 4/0 AWG two-way splices

Flags

CAT. NO.	WIRE SIZE (AWG)	INSULATOR	STD. PKG. QTY.
Flags			
FLAG1614	#16-14	F-INSUL-0	20
FLAG1210	#12-10	F-INSUL-0	10
FLAG8	#8	F-INSUL-1	10
FLAG6	#6	F-INSUL-1	10
FLAG4	#4	F-INSUL-2	6
FLAG2	#2	F-INSUL-2	6
FLAG1	#1	F-INSUL-2	6
FLAG10	1/0	F-INSUL-3	3
FLAG20	2/0	F-INSUL-3	3
FLAG30	3/0	F-INSUL-3	3
FLAG40	4/0	F-INSUL-3	3

Tees

CAT. NO.	WIRE SIZE (AWG)	INSULATOR	STD. PKG. QTY.
Tees			
TEE1614	#16-14	—	20
TEE1210	#12-10	—	10
TEE8	#8	—	3
TEE6	#6	—	10
TEE4	#4	—	6
TEE2	#2	—	6
TEE1	#1	—	6
TEE10	1/0	—	3
TEE20	2/0	—	3
TEE30	3/0	—	3
TEE40	4/0	—	3

Flag Insulators

CAT. NO.	DESCRIPTION	STD. PKG. QTY.
F-INSUL-0	For #16-10 AWG	20/200
F-INSUL-1	For #8, #6 AWG	10/100
F-INSUL-2	For #4, #2, #1 AWG	6/60
F-INSUL-3	For 1/0, 2/0, 3/0, 4/0 AWG	3/30

Flag and Tee Kit

CAT. NO.	DESCRIPTION	STD. PKG. QTY.
FLAGTEEKIT	Flag and Tee Kit	1

Tooling: pp. B76-B92

Die Selector Chart: pp. B93-B95

Copper Disconnects

Making connections for high-amperage loads has never been easier!

High-Amperage Quick Power Disconnects

- Designed to be the fastest “off-load” connection possible, while maintaining system integrity
- Uses a multicontact approach to provide low insertion and extraction forces with low resistance and temperature rise
- Enables multiple connections and disconnection without changing or degrading performance characteristics
- Unique construction:
 - Made from 99.9% conductive copper, silver plated
 - Contact design features louvered band of beryllium copper
 - All raised edges of louvered band are deflected, producing a multitude of high-force contact points
 - Each contact point is typically in the force range of 8,000 to 10,000 psi
 - High currents, caused by short circuits or sudden surges, make contact interface even more efficient by increasing contact pressure

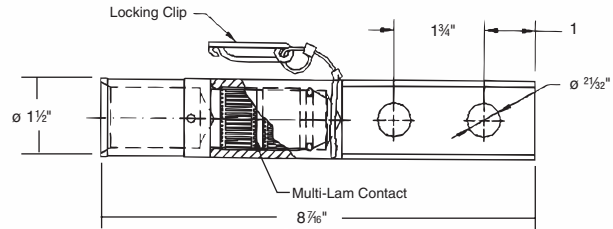
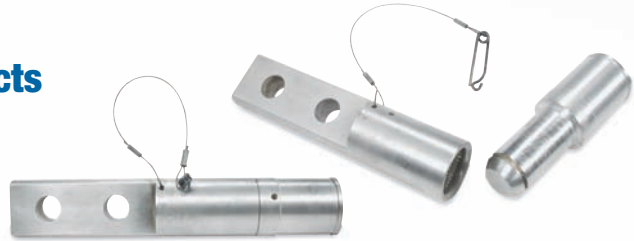

CAT. NO.		DIE CONDUCTOR	CODE
MALE	FEMALE		
272-32175M	272-32175F	777 MCM	115
Future Design	—	646 MCM	—
Future Design	—	535 MCM	—
Future Design	—	444MCM	—

Tooling: pp. B74–B90

Die Selector Chart: pp. B91–B93

T&B Method Traction Motor Disconnect Lugs for Diesel-Electric Locomotives

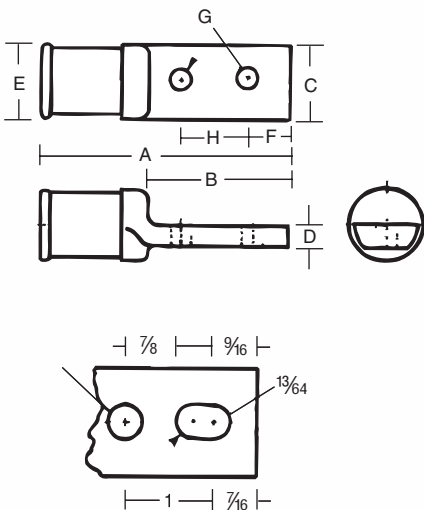

± Cat. No. MD 1925 Supplied with Elongated Bolt Hole.

CAT. NO.	CABLE SIZE	DIMENSIONS (IN.)				E APPROX. (IN.)	BOLT SIZE (IN.)			DIE CODE
		A	B	C	D		F	G	H	
MD37	37/24	2 ¹ / ₁₆	1 ³ / ₄	1 ⁹ / ₃₂	5 ¹ / ₃₂	3 ¹ / ₈	3 ¹ / ₈	5 ¹ / ₈	7 ¹ / ₈	26
MDD61	61/24	2 ¹ / ₁₆	1 ³ / ₄	1 ⁹ / ₃₂	5 ¹ / ₃₂	3 ¹ / ₈	3 ¹ / ₈	5 ¹ / ₈	7 ¹ / ₈	26
MD 105	105/24	2 ⁵ / ₁₆	1 ³ / ₄	1 ⁹ / ₃₂	5 ¹ / ₃₂	7 ¹ / ₁₆	3 ¹ / ₈	5 ¹ / ₈	7 ¹ / ₈	33
MD 105	91/24	2 ⁵ / ₁₆	1 ³ / ₄	1 ⁹ / ₃₂	5 ¹ / ₃₂	7 ¹ / ₁₆	3 ¹ / ₈	5 ¹ / ₈	7 ¹ / ₈	33
MD 125	125/24	2 ⁵ / ₁₆	1 ³ / ₄	1 ⁹ / ₃₂	5 ¹ / ₃₂	7 ¹ / ₁₆	3 ¹ / ₈	5 ¹ / ₈	7 ¹ / ₈	33
MD 150	150/24	2 ⁵ / ₁₆	1 ¹ / ₂	1 ⁹ / ₃₂	.203	3 ¹ / ₈	7 ¹ / ₁₆	5 ¹ / ₈	7 ¹ / ₈	45
MD 175	175/24	2 ⁵ / ₁₆	1 ¹ / ₂	1 ⁹ / ₃₂	.203	3 ¹ / ₈	7 ¹ / ₁₆	5 ¹ / ₈	7 ¹ / ₈	45
MD 225	225/24	3	1 ¹ / ₂	1 ¹ / ₁₆	.203	2 ³ / ₃₂	7 ¹ / ₁₆	5 ¹ / ₈	7 ¹ / ₈	60
MD 275	275/24	3	1 ¹ / ₂	1 ¹ / ₁₆	.203	2 ³ / ₃₂	7 ¹ / ₁₆	5 ¹ / ₈	7 ¹ / ₈	60
MD 325	325/24	3	1 ¹ / ₂	1 ¹ / ₁₆	.203	2 ³ / ₃₂	7 ¹ / ₁₆	5 ¹ / ₈	7 ¹ / ₈	60
MD 375	375/24	3 ¹ / ₈	2	2 ³ / ₃₂	.203	2 ³ / ₃₂	7 ¹ / ₁₆	5 ¹ / ₈	7 ¹ / ₈	60
MD 450	450/24	3 ¹ / ₈	2	2 ⁵ / ₃₂	.203	2 ³ / ₃₂	7 ¹ / ₁₆	5 ¹ / ₈	7 ¹ / ₈	60
MD 550	550/24	3 ³ / ₁₆	1 ¹ / ₂	1 ⁵ / ₁₆	.203	1	7 ¹ / ₁₆	5 ¹ / ₈	7 ¹ / ₈	76
MD 650	650/24	3 ³ / ₁₆	1 ¹ / ₂	1 ⁵ / ₁₆	.203	1	7 ¹ / ₁₆	5 ¹ / ₈	7 ¹ / ₈	76
MD 775	775/24	3 ³ / ₁₆	1 ¹ / ₂	1 ⁵ / ₁₆	.203	1	7 ¹ / ₁₆	5 ¹ / ₈	7 ¹ / ₈	76
MD 925	925/24	3 ³ / ₁₆	2 ¹ / ₁₆	1 ¹ / ₂	.375	1 ¹ / ₂	7 ¹ / ₁₆	3 ¹ / ₈	1	87
MD 1100	1100/24	3 ³ / ₁₆	2 ¹ / ₁₆	1 ¹ / ₂	.375	1 ¹ / ₂	7 ¹ / ₁₆	3 ¹ / ₈	1	107
MD 1325	1325/24	3 ⁵ / ₃₂	2 ³ / ₃₂	1 ¹ / ₃₂	.375	1 ¹ / ₂	7 ¹ / ₁₆	3 ¹ / ₈	1	107
MD 1600	1600/24	3 ³ / ₄	2 ¹ / ₁₆	1 ¹ / ₃₂	.375	1 ¹ / ₂	7 ¹ / ₁₆	3 ¹ / ₈	1	107
MD 1925	1925/24	4 ¹ / ₁₆	2 ³ / ₃₂	1 ¹ / ₃₂	.375	1 ¹ / ₂	7 ¹ / ₁₆	3 ¹ / ₈	1	115
MD 2300	2300/24	4 ¹ / ₈	2 ¹ / ₂	1 ¹ / ₃₂	.375	1 ² / ₃₂	7 ¹ / ₁₆	3 ¹ / ₈	1	130

NOTE: Some parts may not be current on the system. Contact Tech Services for information.

Tooling: pp. B76–B92

Die Selector Chart: pp. B93–B95

Color-Keyed Compression

Connector Kits

Color-Keyed® Connector Kit for Copper Cables

Color-Keyed® Compression

CAT. NO.	DESCRIPTION	STD. PKG.	WT. EACH
TBM2K-1	Color-Keyed® Connector Kit	1	12

The kit includes

CAT. NO.	ITEMS	CABLE SIZE		QTY.
54104	One hole lugs	#8		25
54105	One hole lugs	#6		25
54106	One hole lugs	#4		15
54107	One hole lugs	#2, #3		10
54504	2-way conn.	#8		15
54505	2-way conn.	#6		15
54506	2-way conn.	#4		10
54507	2-way conn.	#2		5
		Min.	Max.	
54610	Pigtails3-#12	4-#12	15	
54615	Pigtails	4-#12	4-#10	15
54620	Pigtails	3-#8	1-#4	15
		10	10	
54710	C-Tap	8	12	15
		6	10-12	
54615	C-Tap	8	8-10	15
		4 or 5	8-10-12	
54720	C-Tap	6	6-8	
TBM20S or TBM25S		#8	#2AWG	1

UL not applicable



Carrying Cases

MDPWK12 Case Contents

1 PWK1	10 MD1210F-1	6 MD8M-2	6 MD8F-2	30 BOOT-1
10 MD1210M-1	10 MD8F-1	6 MD6M-2	6 MD6F-2	6 MD1210M-2
10 MD8M-1	10 MD6F-1	6 MD4M-2	6 MD4F-2	6 MD1210F-2
10 MD6M-1	30 MDBOOT-2	6 MD2M-2	6 MD2F-2	

MDPWK23 Case Contents

1 PWK1	6 MD1210F-2	3 MD2M-3	3 MD2F-3	6 MD1M-2
6 MD1210M-2	6 MD8F-2	3 MD1M-3	3 MD1F-3	36 MDBOOT-2
6 MD8M-2	6 MD6F-2	3 MD10M-3	3 MD10F-3	18 MDBOOT-3
6 MD6M-2	6 MD4F-2	3 MD20M-3	3 MD20F-3	
6 MD4M-2	6 MD2F-2	3 MD30M-3	3 MD30F-3	
6 MD2M-2	6 MD1F-2	3 MD40M-3	3 MD40F-3	

MDKITL Case Contents

1 PWK1	1 TBM25S	24 MDBOOT-2	3 M2D2M-2	6 MD8M-1
3 M2D4M-2	3 M2D6M-2	3 M2D8M-2	12 M2DBOOT-2	6 MD8F-1
12 MDBOOT-1	12 MD2F-2	12 MD4F-2	12 MD6F-2	6 MD8M-2
12 M2D8F-2	6 MD2M-2	6 MD4M-2	6 MD6M-2	6 MD6M-1
6 MD6F-1				

CAT. NO.	DESCRIPTION
PWK1	Empty case — includes Color-Keyed® wall chart; make up your own selection of Color-Keyed® lugs, splices, taps or motor disconnects.
PWK4	Metal cabinet that holds four of the PWK1 shells slide out for easy removal of PWK1.
MDPWK12	Selection of size 1 and 2 male and female motor disconnects plus insulators; to connect 60 single line to single line load motor leads, #12 AWG through #2 AWG; tools not included.
MDPWK23	Selection of size 2 and 3 male and female motor disconnects plus insulators; to connect 54 single line to single line load motor leads, #12 AWG through #4/0 AWG; tools not included. 2 and 1 male and female motor disconnects plus insulators. To convert single to single line or single line to two line.
MDKITL	Includes Tool.

Connectors for Aluminum/Copper Code Conductor

Copper colloidal surface treatment protects, lubricates and enhances conductivity of all electrical connections.

Kopr-Shield® Joint Compound

- Unique, homogenized blend of pure, polished colloidal copper, rust and corrosion inhibitors
- Simultaneously protects, lubricates and enhances conductivity of mating surfaces
- Extremely adhesive compound flows smoothly into uneven contours and voids, ensuring easy application and complete, positive protection and lubrication
- Won't settle-out, thin, thicken, harden or dry out under the most severe environmental conditions
- Excellent temperature characteristics — can be brushed on at -50° F to 250° F (other compounds either turn solid or run like water at these extremes) and remains intact at short terms even at 1,800° F

Good connections are one of the most important aspects of electrical work. Mechanics know how much downtime is caused when fluids or oils leak into the raceway system or when they have to look for a weak link in a ground system caused by a high-resistance connection. Mechanics also know how much time is spent keeping contacts, switches, lugs and other connectors clean or replacing parts because of "green scourage" buildup. Thomas & Betts has the solution to improve connections made in thousands of electrical and raceway installations made each day by electricians everywhere. Kopr-Shield® Compound may be used to advantage in all electrical installations. When the environment is hostile to electrical and mechanical connections, Kopr-Shield® Compound is a must!



Use Kopr-Shield® Compound for battery lugs and cables to:

- Prevent "green scourage" corrosion
- Reduce resistance
- Ease terminal installation and removal

Use Kopr-Shield® Compound for raceways to:

- Lubricate for ease of assembly and disassembly
- Improve grounding continuity (exceeds code requirements)

Use Kopr-Shield® Compound for fuse clips to:

- Eliminate hot spots for even heat distribution
- Prevent oxidation by preventing carbon path formation
- Lubricate for easy installation and removal of fuses

Use Kopr-Shield® Compound for wiping contacts, drum switches and slip rings to:

- Prevent galling, burning, pitting and discoloration
- Suppress arcing and dissipation of coronas
- Lubricate for ease of operation



ALUMA-SHIELD® Aluminum Joint Compound



CAT. NO.	CONTAINS	DESCRIPTION
21059	Squeeze Bottle, Pt.	For aluminum cable connections; contains fine zinc particles which break through oxide film on cable strands upon compression of connection; ensures a low resistance contact and seals out air and moisture.
AP8	8 oz. Brush Cap Can	
M53	5 Gallon Can	

NOTE: UL Listed only for use on electrical cables in cable connector assemblies, or on bus bars rated for NEC® applications up to 8 KV and 90°C.

CAT. NO.	DESCRIPTION	STD. PKG.	WT. LBS./C
201-31879	1½ oz. Container with Brush	96	11.46
201-31879-1	4 oz. Container with Brush	24	38.54
CP8-TB	8 oz. Container with Brush	12	64.58
CP16	16 oz. Container with Brush	12	120.83
CP128	1 Gallon Can	4	952.00

United States
Tel: 901.252.8000
800.816.7809
Fax: 901.252.1354

Canada
Tel: 450.347.5318
Fax: 450.347.1976

Technical Services
Tel: 888.862.3289

Thomas & Betts

www.tnb.com

Connectors for Aluminum/Copper Code Conductor

For tight, secure bus-bar connections.

Bellelville Compression Washers

- Essential when bolting aluminum lugs and connectors to bus bars with steel or brass hardware
- Maintains constant pressure in heavy-duty, high-temperature applications
- Available with or without flat washer

When bolting aluminum lugs and connectors to bus bars with steel or brass hardware, the recommended practice to ensure a tight connection is to use a Bellelville spring washer on top of a flat washer under the bolt head or nut. For heavy-duty service where the heat rise is expected to exceed 30° C above ambient, this procedure maintains constant pressure as the connector metals expand and contract with temperature changes.

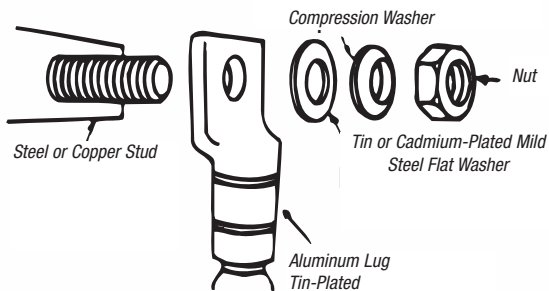

CAT. NO.	BOLT SIZES (IN.)	DIMENSIONS (IN.)			
		FLAT WASHER		BELLELVILLE WASHER	
		A	B	C	D
Bellelville Compression Washers Plus Flat Washer					
60800B	¼	¾	.067	1 ¹ / ₁₆	.055
60801B	5/16	¾	.074	1 ³ / ₁₆	.065
60802B	¾	1	.083	1 ⁵ / ₁₆	.075
60803B	½	1¼	.109	1 ³ / ₁₆	.095
Bellelville Compression Washer Only					
60800	¼	—	—	1 ¹ / ₁₆	.055
60801	5/16	—	—	1 ³ / ₁₆	.065
60802	¾	—	—	1 ⁵ / ₁₆	.075
60803	½	—	—	1 ³ / ₁₆	.095
60804	¾	—	—	1½	.110

NOTE: Ordering quantity must be in unit quantities and multiples thereof.

The Bellelville washer should be installed with a larger flat washer to spread the high stresses of the spring washer edges over a large area of the lug and/or bus bar.

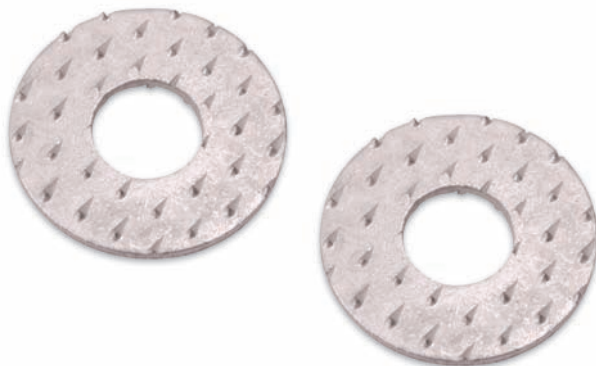

Quick, dependable and versatile.

Dragon Tooth® Transition Washers

- Connect copper-to-aluminum, copper-to-copper or aluminum-to-aluminum component
- Toothed surface penetrates aluminum and copper oxides
- Lower installed cost — no need to grind aluminum surfaces, apply compounds or use spring-type washers

CAT. NO.	SIZE (IN.)	BOLT TORQUE IN LBS.
DTW14	¼	50–80
DTW516	5/16	125–160
DTW38	¾	160–240
DTW12	½	390–540
DTW58	5/8	540–730

Connectors for Aluminum/Copper Code Conductor



Perform equally well on both aluminum and copper conductors.

One-Hole Lugs



- For 90°C, 600V to 35KV applications
- Easily matched to the correct Color-Keyed® installing die for positive compressions
- Hardened steel dies compress connector around cable, changing round strands to polygonal shapes and cold flowing strands and connector into a solid, homogenous mass
- Long compression areas ensure complete contact
- Multiple compressions prevent creep of aluminum conductors
- Filled with high-temperature oxide-inhibitor compound
- Electro-tin plating prevents electrolytic corrosion of copper to ensure lowest contact resistance

Material: High-Conductivity Wrought Aluminum

Finish: Electro-Tin Plated

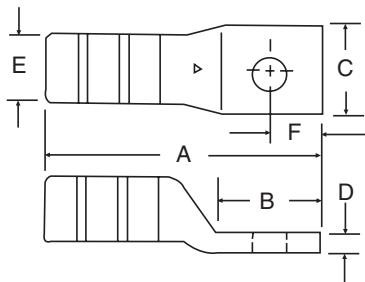

CAT. NO.	CABLE SIZE AL/CU	BOLT SIZE (IN.)	DIMENSIONS (IN.)						COLOR CODE	DIE CODE
			A	B	C	D	E	F		
60096	#10	#10	1.09	.56	.41	.06	.270	.22	21	RED
60097		¼	1.31	.72	.43	.07	.270	.34		
60099		⅜	1.53	.93	.58	.06	.270	.44		
60101	#8	#10	1.22	.56	.41	.09	.280	.22	24	BLUE
60102		¼	1.38	.71	.44	.09	.280	.34		
60103		⅝	1.56	.91	.60	.06	.280	.44		
60104-TB		⅜	1.60	.93	.60	.06	.280	.44		
60106	#6	#10	1.52	.59	.47	.13	.350	.22	29	GRAY
60107		¼	1.67	.75	.47	.13	.350	.34		
60108		⅝	1.83	.91	.63	.09	.350	.44		
60109		⅜	1.86	.93	.63	.09	.350	.44		
60112	#4	¼	1.81	.75	.64	.19	.460	.34	37	GREEN
60113		⅝	2.00	.91	.64	.19	.460	.44		
60114		⅜	2.03	.93	.64	.19	.460	.44		
60116	#2	¼	1.91	.75	.72	.19	.510	.34	42	PINK
60117		⅝	2.06	.91	.72	.19	.510	.44		
60118		⅜	2.09	.93	.72	.19	.510	.44		
60120		½	2.25	1.41	.88	.13	.510	.69		
60122	#1	¼	2.30	.81	.75	.19	.560	.34	45	GOLD
60123		⅝	2.39	.91	.75	.19	.560	.44		
60124		⅜	2.42	.93	.75	.19	.560	.44		
60126		½	2.89	1.41	.88	.16	.560	.69		
60128	1/0	¼	2.36	.81	.88	.19	.620	.34	50	TAN
60129		⅝	2.51	.97	.88	.19	.620	.44		
60130		⅜	2.51	.97	.88	.19	.620	.44		
60132		½	2.95	1.41	.94	.19	.620	.69		
60134	2/0	¼	2.48	.87	.97	.22	.700	.34	54	OLIVE
60135		⅝	2.64	1.03	.97	.22	.700	.44		
60136		⅜	2.64	1.03	.97	.22	.700	.44		
60138		½	3.10	1.41	1.03	.22	.700	.69		
60140	3/0	¼	2.58	.87	1.06	.22	.770	.34	60	RUBY
60141		⅝	2.83	1.09	1.06	.22	.770	.44		
60142		⅜	2.83	1.09	1.06	.22	.770	.44		
60144		½	3.15	1.41	1.06	.22	.770	.69		
60147	4/0	⅝	3.53	.88	1.21	.25	.857	.38	66	WHITE
60148		⅜	3.58	.93	1.21	.25	.857	.38		
60150		½	3.90	1.25	1.21	.25	.857	.50		
60151		⅝	4.65	2.00	1.21	.25	.857	.75		
60154		⅜	3.73	.93	1.29	.27	.917	.38		
60156	250 kcmil	½	4.05	1.25	1.29	.27	.917	.50	71	RED
60157		⅝	4.80	2.00	1.29	.27	.917	.75		
60159	300 kcmil	⅝	3.75	.88	1.39	.28	.990	.38	76	BLUE
60160		⅜	3.80	.93	1.39	.28	.990	.38		
60162		½	4.13	1.25	1.39	.28	.990	.50		
60165	350 kcmil	½	4.83	1.25	1.53	.33	1.090	.50	87	BROWN
60166		⅝	5.58	2.00	1.53	.33	1.090	.75		
60168	400 kcmil	½	4.95	1.25	1.65	.38	1.180	.50	94	GREEN
60171	500 kcmil	½	4.95	1.25	1.79	.38	1.280	.50	99	PINK
60172		⅝	5.70	2.00	1.79	.38	1.280	.75		
60174	600 kcmil	⅝	5.83	2.00	1.92	.37	1.360	.75	106	BLACK
60176	700 kcmil	⅝	5.95	2.00	2.04	.38	1.440	.75	112	PURPLE
60178	750 kcmil	⅝	6.03	2.00	2.13	.40	1.500	.75	115	YELLOW
60184	1000 kcmil	⅝	6.78	2.00	2.50	.50	1.770	.75	140	N/A

Tooling: pp. B76-B92

Die Selector Chart: pp. B93-B95

Color-Keyed® Compression

Connectors for Aluminum/Copper Code Conductor

Designed and approved for use with both aluminum and copper conductors.

Two-Hole Lugs



Color-Keyed® Compression



- For 90°C, 600V to 35KV applications
- For aluminum and copper concentric conductors and compact code aluminum strandings
- Filled with oxide-inhibitor compound

Material: High-Conductivity Wrought Aluminum

Finish: Electro-Tin Plated

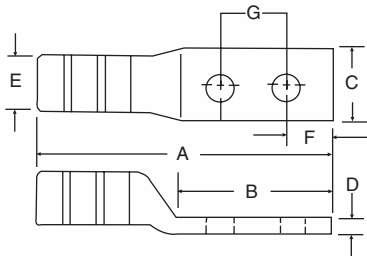

CAT. NO.	CABLE SIZE	BOLT SIZE (IN.)	DIMENSIONS (IN.)							DIE CODE	COLOR CODE
			A	B	C	D	E	F	G		
60230	1/0 AWG	3/8	3.50	1.90	.880	.19	.62	.38	1.00	50	TAN
60236	2/0 AWG	3/8	3.50	1.90	.970	.22	.70	.38	1.00	54	OLIVE
60238	2/0 AWG	1/2	5.03	3.41	.970	.22	.70	.75	1.75		
60242	3/0 AWG	1/2	3.66	1.18	1.063	.22	.77	.38	1.00	60	RUBY
60244	3/0 AWG	1/2	5.16	3.41	1.063	.22	.77	.75	1.75		
60248	4/0 AWG	3/4	4.58	1.93	1.210	.25	.86	.38	1.00	66	WHITE
60250	4/0 AWG	1/2	5.65	3.00	1.210	.25	.86	.50	1.75		
60254	250 kcmil	3/8	4.73	1.93	1.290	.27	.92	.38	1.00	71	RED
60256	250 kcmil	1/2	5.80	3.00	1.290	.27	.92	.50	1.75		
60260	300 kcmil	3/8	4.80	1.93	1.390	.28	.99	.38	1.00	76	BLUE
60262	300 kcmil	1/2	5.88	3.00	1.390	.28	.99	.50	1.75		
60265	350 kcmil	3/8	5.50	1.93	1.530	.33	1.09	.38	1.00	87	BROWN
60267	350 kcmil	1/2	6.58	3.00	1.530	.33	1.09	.50	1.75		
60268	400 kcmil	3/8	5.63	1.93	1.650	.38	1.18	.38	1.00	94	GREEN
60269	400 kcmil	1/2	6.70	3.00	1.650	.38	1.18	.50	1.75		
60271	500 kcmil	3/8	5.63	1.93	1.790	.38	1.28	.38	1.00	99	PINK
60273	500 kcmil	1/2	6.70	3.00	1.790	.38	1.28	.50	1.75		
60274	600 kcmil	3/8	5.75	1.93	1.920	.37	1.36	.38	1.00	106	BLACK
60275	600 kcmil	1/2	6.83	3.00	1.920	.37	1.36	.50	1.75		
60276	700 kcmil	3/8	5.88	1.93	2.040	.38	1.44	.38	1.00	112	PURPLE
60277	700 kcmil	1/2	6.95	3.00	2.040	.38	1.44	.50	1.75		
60278	750 kcmil	1/2	7.15	3.00	2.130	.40	1.50	.50	1.75	115	YELLOW
60284	1000 kcmil	1/2	7.78	3.00	2.500	.50	1.77	.50	1.75	140	N/A

NOTE: Bolt holes 3/8" on 1" centers, 1/2" on 1 1/4" centers.

Wire barrel factory-filled with oxide inhibiting compound.

Range-Taking Narrow-Tongue Single-Barrel Lugs

- For 90° C, 600V to 35KV applications
- 1 1/2" wide tongues
- Bolt holes on 1 1/4" centers

Material: Aluminum

Finish: Tin Plated

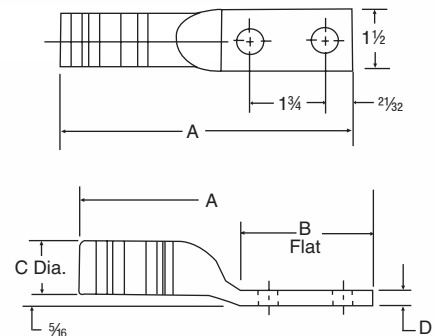

CAT. NO.	AL-CU CABLE RANGE	BOLT SIZE	NO. OF COMPRESSIONS		DIMENSIONS (IN.)				HEX DIE NO.	COLOR CODE
			TBM12M	13642, TBM15	A	B	C	D		
60273N	350-500 kcmil	1/2"	4	4	6 1/8	3 1/8	1 1/2	1 1/2	99H	PINK
60278N	500-750 kcmil	1/2"	—	4	7 1/8	3 1/8	1 1/2	1 1/2	115H	YELLOW

* 90° C, 600V to 35KV applications

All lugs have 1 1/2" wide tongues. Bolt holes on 1 1/4" centers.

Tooling: pp. B76-B92

Die Selector Chart: pp. B93-B95

Connectors for Aluminum Code Conductor

Much smaller than standard aluminum lugs for the same cable size.

One-Hole Aluminum Compact-Size Equipment Lug*

- For 90° C, 600V applications
- For use with aluminum cables only
- Can be directly substituted for equipment mechanical lugs in most applications
- Only 7 dies handle all 14 lug sizes
- Factory-filled with joint compound
- Electro-tin plated
- Supplied with Neoprene insulating covers

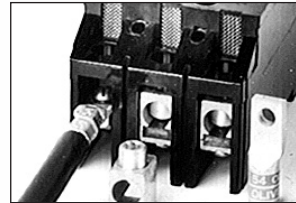

Color-Keyed® Compression

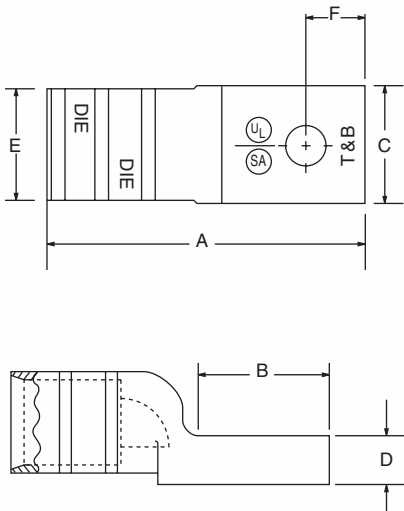

CAT. NO.	ALUMINUM CABLE SIZE	*ALUMINUM RANGE TAKING	BOLT HOLE (IN.)	DIMENSIONS (IN.)					
				A	B	C	D	E	F
61102	#8	—	¼	1.33	.54	.50	.14	.37	.25
61107	#6	—	¼	1.33	.54	.50	.14	.37	.25
61112	#4	—	¼	1.33	.54	.50	.14	.37	.25
61116	#2	—	¼	1.75	.68	.55	.20	.48	.25
61122	#1	—	¼	1.75	.68	.55	.20	.48	.25
61130	1/0	#8-1/0	⅜	2.00	.83	.64	.20	.57	.38
61136	2/0	#1-2/0	⅜	2.00	.83	.64	.20	.57	.38
61142	3/0	—	⅜	2.50	1.08	.78	.23	.70	.38
61148	4/0	2/0-4/0	⅜	2.50	1.08	.78	.23	.70	.38
61156	250 kcmil	—	½	2.50	1.23	.98	.25	.85	.50
61162	300 kcmil	#4-300	½	2.50	1.23	.98	.25	.85	.50
61165	350 kcmil	250-350	½	3.25	1.23	1.20	.41	1.04	.56
61171	500 kcmil	2/0-500	½	3.25	1.23	1.20	.41	1.04	.56
61178	750 kcmil	500-750	¾	3.75	1.54	1.49	.41	1.33	.81

600V, 90° C

This lug with insulating covers for aluminum cables only.

This lug is reduced in size as compared to an aluminum lug of the same cable size. It can be substituted for the equipment mechanical lugs in most cases. Factory filled with joint compound. Electro-tin plated. Cover is Neoprene.

**For range-taking capability, use TBM8-750/TBM8-750M1 Smart Tool.*

Tooling: **pp. B76-B92**

Die Selector Chart: **pp. B93-B95**

Splice Connectors for Aluminum/Copper Code Conductor

For aluminum-to-copper or aluminum-to-aluminum splicing.



Two-Way Splice Connectors



- For 90° C, 600V to 35KV applications
- For aluminum and copper concentric conductors and compact code aluminum strandings
- Permit aluminum conductors to be spliced to copper or aluminum conductors

Material: High-Conductivity Wrought Aluminum

Finish: Electro-Tin Plated

CAT. NO.	CONDUCTOR CODE	DIMENSIONS (IN.)		DIE CODE	COLOR CODE
		A	E		
60500	10 Str.	1.00	.27	21	RED
60501	8 Str.	1.19	.28	24	BLUE
60507	6 Str.	1.63	.35	29	GRAY
60512	4 Str.	1.81	.46	37	GREEN
60516	2 Str./3 Str.	1.81	.51	42	PINK
60522	1 Str.	2.38	.56	45	GOLD
60530	1/0	2.38	.62	50	TAN
60536	2/0	2.50	.70	54	OLIVE
60542	3/0	2.81	.77	60	RUBY
60548	4/0	3.66	.86	66	WHITE
60554	250 kcmil	3.91	.92	71	RED
60560	300 kcmil	3.97	.99	76	BLUE
60565	350 kcmil	4.97	1.09	87	BROWN
60568	400 kcmil	4.97	1.18	94	GREEN
60571	500 kcmil	4.97	1.28	99	PINK
60574	600 kcmil	5.22	1.36	106	BLACK
60576	700 kcmil	5.44	1.44	112	PURPLE
60578	750 kcmil	5.69	1.50	115	YELLOW
60584	1000 kcmil	6.69	1.77	140	—

Splice aluminum conductors to copper conductors of equal ampacities.

Aluminum Reducing Connectors

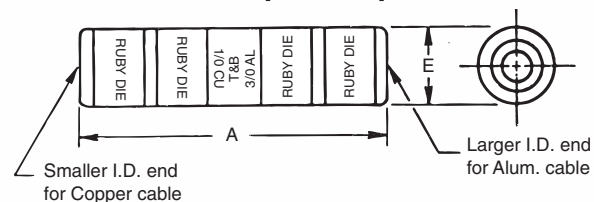

- For 90°C, 600V applications
- Filled with high-temperature oxide inhibiting compound
- Designed for the right combination of equivalent sizes (Example: 4/0 aluminum to 2/0 copper)
- Selection table gives aluminum/copper equivalents for all sizes

Material: High-Conductivity Wrought Aluminum

Finish: Electro-Tin Plated

CAT. NO.	CABLE SIZE		DIMENSIONS (IN.)		DIE CODE	COLOR KEY
	ALUMINUM	COPPER	A	E		
60905	8	10	1 ¹ / ₆	5 ¹ / ₂	24	BLUE
60910	6	8	1 ¹ / ₂	1 ¹ / ₂	29	GRAY
60915	4	6	1 ¹ / ₆	7 ¹ / ₆	37	GREEN
60925	1	3	2 ¹ / ₂	1 ¹ / ₂	45	GOLD
60930	1/0	2	2 ¹ / ₂	5 ¹ / ₆	50	TAN
60935	2/0	1	2 ¹ / ₂	1 ¹ / ₆	54	OLIVE
60940	3/0	1/0	2 ¹ / ₆	3 ¹ / ₄	60	RUBY
60945	4/0	2/0	3 ¹ / ₂	7 ¹ / ₆	66H	WHITE
60950	250 kcmil	3/0	4	1 ¹ / ₆	71H	RED
60955	300 kcmil	4/0	4 ¹ / ₆	1	76H	BLUE
60960	350 kcmil	4/0	5 ¹ / ₆	3 ¹ / ₂	87H	BROWN
60965	400 kcmil	250 kcmil	5 ¹ / ₆	1 ¹ / ₂	94H	GREEN
60970	500 kcmil	350 kcmil	5 ¹ / ₆	1 ¹ / ₆	99H	PINK
60975	600 kcmil	400 kcmil	5 ¹ / ₆	1 ¹ / ₂	106H	BLACK
60980	700 kcmil	500 kcmil	5 ¹ / ₆	1 ¹ / ₆	112H	PURPLE
60985	750 kcmil	500 kcmil	5 ¹ / ₆	1 ¹ / ₂	115H	YELLOW

Selection table gives aluminum/copper equivalents for all sizes. Connectors are filled with a high-temperature oxide inhibiting compound.

Tooling: pp. B76-B92

Die Selector Chart: pp. B93-B95

Installing Tools: TBM5(s) #10 → 4/0

TBM6(s) #10 → 350 kcmil

TBM8(s) #10 → 350 kcmil

Transformer Lug Kits for Aluminum Code Conductor

Everything you need to connect to a transformer in one convenient kit.

Transformer Lug Kits

- For 90° C, 600V applications
- For use with aluminum cables only
- Include all necessary range-taking compression or mechanical type lugs and bolting hardware to connect to designated transformers



Color-Keyed® Compression

TRANSFORMER KVA SIZES	KIT CAT. NO.	TERMINAL LUGS		KIT CONTENTS					STD. PKG.	
		AL CABLE RANGE*	QTY.	NUTS	QTY.	BOLTS	QTY.	WASHERS		
Compression										
15-37½ 1Ø	611CL-SK1	#8-1/OAL	8	¼-20	8	¼-20 x 1"	8	FLAT ¼"	8	1
15-45 3Ø		#4-300 kcmil	4					SPRING ¼"	8	
50-75 1Ø	611CL-SK2	#4-300 kcmil AL	12	¼-20	16	¼-20 x 1"	8	FLAT ¼"	16	1
75-112½ 3Ø						¼-20 x 2"	8	SPRING ¼"	16	
100-167 1Ø	611CL-SK3	#4-300 kcmil AL	3	¼-20	3	¼-20 x ¾"	3	FLAT ¼"	3	
150-300 3Ø								SPRING ¼"	3	1
		#2/0-500MM AL	22	¾-16	16	¾-16 x 2"	16	FLAT ¾"	16	
								SPRING ¾"	16	
100-167 1Ø	611CL-SK3	#4-300 kcmil AL	3	¼-20	3	¼-20 x 1"	3	FLAT ¼"	3	
150-300 3Ø	-500							SPRING ¼"	3	1
		#2/0-500 kcmil AL	22	¾-16	16	¾-16 x 2"	16	FLAT ¾"	16	
								SPRING ¾"	16	
500 3Ø	611CL-SK4	#500-750 kcmil AL	29	¾-16	18	¾-16 x 2"	18	FLAT ¾"	18	1
								SPRING ¾"	18	
Mechanical										
15-37½ 1Ø	622ML-SK1	#14-2	8	¼-20	8	¼-20 x ¾"	8	FLAT ¼"	8	1
15-45 3Ø		#6-250	4					SPRING ¼"	8	
50-75 1Ø	622ML-SK2	#6-250	12	¼-20	16	¼-20 x ¼"	8	FLAT ¼"	16	1
75-112½ 3Ø						¼-20 x 1¼"	8	SPRING ¼"	16	
100-167 1Ø		#6-250	3	¼-20	3	¼-20 x ¾"	3	FLAT ¼"	3	
150-300 3Ø	622ML-SK3							SPRING ¼"	3	1
		350-800	22	¾-16	16	¾-16 x 2"	16	FLAT ¾"	16	
								SPRING ¾"	16	
500 3Ø	622ML-SK4	350-800	29	¾-16	18	¾-16 x 2"	18	FLAT ¾"	18	1
								SPRING ¾"	18	

* To ensure proper range taking compression on Color-Keyed® equipment lugs, use Smart® Tool (Cat. No. TBM8-750/TBM8-750M-1).

** Largest cable in lug can be applied with standard hex or hand tool.

Tooling: pp. B76-B92

Die Selector Chart: pp. B93-B95

Pin Connectors for Aluminum/Copper Code Conductor

Converts an aluminum cable into a two-sizes-smaller copper pigtail.

Bi-Pin® Bi-Metal Pin Connectors with Insulating Covers*

- For 90° C, 600V applications
- Upgrades connection by eliminating cold flow and oxidation of aluminum
- Reduces oversized aluminum cable
- Enables termination of aluminum cable into a copper-only lug
- Barrel prefilled with joint compound



Color-Keyed® Compression

Material: Copper Wire/Aluminum Body

Finish: Electro-Tin Plated

Insulator: Neoprene (600V dielectric rating)

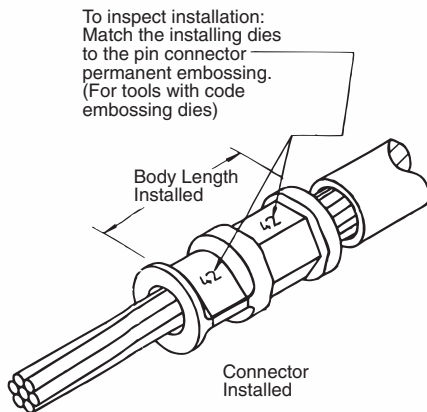
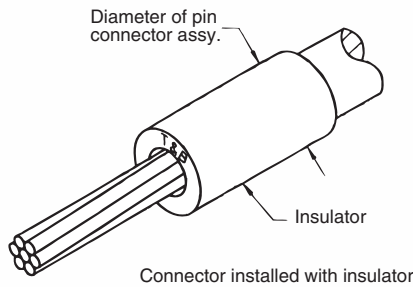
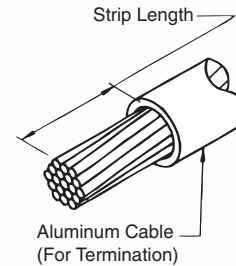
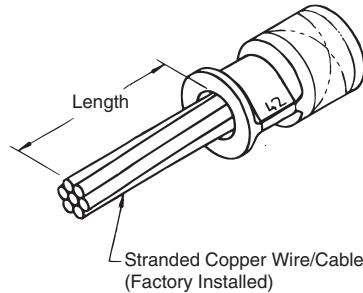

CAT. NO.	ALUM. CABLE SIZE	COPPER WIRE SIZE	BODY LENGTH AFTER INSTALLING (IN.)	DIE CODE NO.	COLOR KEY
61905A	8 AWG	10 AWG	1 $\frac{1}{2}$	24	BLUE
61910A	6 AWG	8 AWG	1 $\frac{1}{2}$	24	BLUE
61915A	4 AWG	6 AWG	1 $\frac{5}{8}$	45	GOLD
61920A	2 AWG	4 AWG	1 $\frac{5}{8}$	45	GOLD
61925A	1 AWG	3 AWG	1 $\frac{1}{2}$	50	ORANGE
61930A	1/0 AWG	2 AWG	1 $\frac{5}{8}$	50	ORANGE
61935	2/0 AWG	1 AWG	1 $\frac{5}{8}$	50	ORANGE
61940	3/0 AWG	1/0 AWG	2 $\frac{1}{2}$	60	RUBY
61945	4/0 AWG	2/0 AWG	2 $\frac{1}{2}$	60	RUBY
61950	250 kcmil	3/0 AWG	2 $\frac{3}{8}$	66	WHITE
61955	300 kcmil	4/0 AWG	2 $\frac{1}{2}$	71H	RED
61960	350 kcmil	250 kcmil	2 $\frac{1}{2}$	71H	RED
61963	400 kcmil	250 kcmil	3 $\frac{1}{8}$	87H	BROWN
61965	500 kcmil	350 kcmil	3 $\frac{1}{8}$	87H	BROWN
61970	600 kcmil	400 kcmil	3 $\frac{3}{8}$	107H	ORANGE
61975	700-750 kcmil	500 kcmil	3 $\frac{3}{8}$	107H	ORANGE

* 600V 90° C application

Hand Tools — Smart® Tool

Tooling: pp. B76-B92

Die Selector Chart: pp. B93-B95

Flag Lugs for Aluminum/Copper Code Conductor

90° Flag Lugs — 600V, 90° C

Material: Aluminum

Finish: Tin Plate

Insulation: PVC Dip Coated

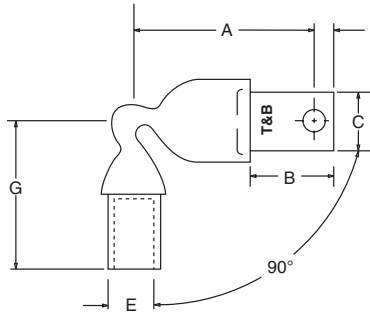
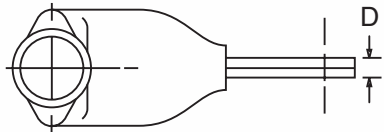

CAT. NO.	CU CABLE SIZE	STUD SIZE (IN.)	PHASE	DIMENSIONS (IN.)							DIE CODE	
				A	B	C	D	E	F	G		
10A-FT-14NTK	1/0	¼	1	1.38								
			2	2.13	.94	.64	.19	.62	.25	2.50	50	
			3	2.88								
20A-FT-14NTK	2/0	¼	1	1.93								
			2	2.93	1.14	.64	.22	.70	.25	2.50	54	
			3	3.93								
30A-FT-14NTK	3/0	¼	1	2.11								
			2	3.11	1.14	.78	.22	.77	.25	2.75	60	
			3	4.11								
40A-FT-14NTK	4/0	¼	1	2.04								
			2	3.04	1.14	.78	.25	.86	.25	3.13	66	
			3	4.04								

CAT. NO.	CU CABLE SIZE	STUD SIZE (IN.)	PHASE	DIMENSIONS (IN.)							DIE CODE	
				A	B	C	D	E	F	G		
250A-FT-14NTK	250 kcmil	¼	1	2.31								
			2	3.44	1.20	.98	.25	.92	.31	3.00	71	
			3	4.57								
350A-FT-12NTK	350 kcmil	¼	1	2.31								
			2	3.69	1.45	1.09	.31	1.09	.56	3.94	87	
			3	5.06								
500A-FT-12NTK	500 kcmil	¼	1	2.56								
			2	4.06	1.45	1.20	.38	1.28	.56	4.19	99	
			3	5.69								
750A-FT-58NTK	750 kcmil	¼	1	2.63								
			2	4.50	1.70	1.49	.38	1.50	.81	4.39	115	
			3	6.25								

* Each Cat. No. consists of three connectors, (1) connector per phase.
 Connectors supplied with Thomas & Betts oxide inhibitor compound in wire bore.
 Installation tooling: Hand or hydraulic tools.

Tooling: pp. B76–B92
 Die Selector Chart: pp. B93–B95

Heavy-Duty Battery Connectors

Color-Keyed Compression



BAC10SUBT

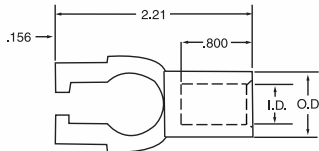

BAC10SPBT

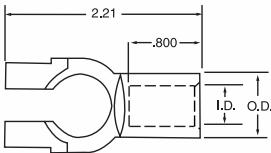

Tin-Plated Straight Battery Connectors

Material: High-Conductivity Copper

Finish: Electro-Tin Plated

Installing Tools: TBM5-SV, TBM5V, TBM8250, TBM8250S

CAT. NO.	BULK CAT. NO.	SAE CABLE SIZE AND COLOR	DESCRIPTION	I.D.	O.D.	PKG. QTY.	BULK PKG. QTY.	COLOR KEY
BAC4SUBT	BAC4SUBT-C	4 Gauge	Straight Universal	.261	.430	5	100	GRAY
BAC2SUBT	BAC2SUBT-C	2 Gauge	Straight Universal	.340	.550	5	100	GREEN
BAC1SUBT	BAC1SUBT-C	1 Gauge	Straight Universal	.340	.550	5	100	PINK
BAC10SUBT	BAC10SUBT-C	1/0 Gauge	Straight Universal	.455	.625	5	100	BLACK
BAC20SUBT	BAC20SUBT-C	2/0 Gauge	Straight Universal	.502	.676	5	100	ORANGE
BAC30SUBT	BAC30SUBT-C	3/0 Gauge	Straight Universal	.530	.730	5	100	PURPLE
BAC40SUBT	BAC40SUBT-C	4/0 Gauge	Straight Universal	.600	.844	5	100	YELLOW
BAC4SPBT	BAC4SPBT-C	4 Gauge	Straight Positive	.261	.430	5	100	GRAY
BAC4SNBT	BAC4SNBT-C	4 Gauge	Straight Negative	.261	.430	5	100	GRAY
BAC2SPBT	BAC2SPBT-C	2 Gauge	Straight Positive	.340	.550	5	100	GREEN
BAC2SNBT	BAC2SNBT-C	2 Gauge	Straight Negative	.340	.550	5	100	GREEN
BAC1SPBT	BAC1SPBT-C	1 Gauge	Straight Positive	.340	.550	5	100	PINK
BAC1SNBT	BAC1SNBT-C	1 Gauge	Straight Negative	.340	.550	5	100	PINK
BAC10SPBT	BAC10SPBT-C	1/0 Gauge	Straight Positive	.455	.625	5	100	BLACK
BAC10SNBT	BAC10SNBT-C	1/0 Gauge	Straight Negative	.455	.625	5	100	BLACK
BAC20SPBT	BAC20SPBT-C	2/0 Gauge	Straight Positive	.502	.676	5	100	ORANGE
BAC20SNBT	BAC20SNBT-C	2/0 Gauge	Straight Negative	.502	.676	5	100	ORANGE
BAC30SPBT	BAC30SPBT-C	3/0 Gauge	Straight Positive	.530	.730	5	100	PURPLE
BAC30SNBT	BAC30SNBT-C	3/0 Gauge	Straight Negative	.530	.730	5	100	PURPLE
BAC40SPBT	BAC40SPBT-C	4/0 Gauge	Straight Positive	.600	.844	5	100	YELLOW
BAC40SNBT	BAC40SNBT-C	4/0 Gauge	Straight Negative	.600	.844	5	100	YELLOW

Tin-Plated Flag Battery Connectors

Material: High-Conductivity Copper

Finish: Electro-Tin Plated

Installing Tools: TBM5-SV, TBM5V, TBM8250, TBM8250S



BAC10FNBT

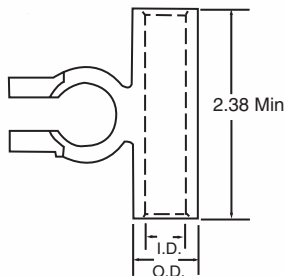

CAT. NO.	BULK CAT. NO.	SAE CABLE SIZE AND COLOR	DESCRIPTION	I.D.	O.D.	PKG. QTY.	BULK PKG. QTY.	COLOR KEY
BAC10FU	BAC10FNBL	1/0 Gauge	Flag Universal	.455	.625	5	100	BLACK
BAC20FU	BAC20FNBL	2/0 Gauge	Flag Universal	.502	.676	5	100	ORANGE
BAC30FU	BAC30FNBL	3/0 Gauge	Flag Universal	.530	.730	5	100	PURPLE
BAC40FU	BAC40FNBL	4/0 Gauge	Flag Universal	.600	.844	5	100	YELLOW
BAC10FPBT	BAC10FPBT-C	1/0 Gauge	Flag Positive	.455	.625	5	100	BLACK
BAC10FNBT	BAC10FNBT-C	1/0 Gauge	Flag Negative	.455	.625	5	100	BLACK
BAC20FPBT	BAC20FPBT-C	2/0 Gauge	Flag Positive	.502	.676	5	100	ORANGE
BAC20FNBT	BAC20FNBT-C	2/0 Gauge	Flag Negative	.502	.676	5	100	ORANGE
BAC30FPBT	BAC30FPBT-C	3/0 Gauge	Flag Positive	.530	.730	5	100	PURPLE
BAC30FNBT	BAC30FNBT-C	3/0 Gauge	Flag Negative	.530	.730	5	100	PURPLE
BAC40FPBT	BAC40FPBT-C	4/0 Gauge	Flag Positive	.600	.844	5	100	YELLOW
BAC40FNBT	BAC40FNBT-C	4/0 Gauge	Flag Negative	.600	.844	5	100	YELLOW

Heavy-Duty Battery Connectors

Tin-Plated Elbow Battery Connectors

Material: High-Conductivity Copper

Finish: Electro-Tin Plated

Installing Tools: TBM5-SV, TBM5V, TBM8250, TBM8250S



BAC10ERNBT



BAC10ELNBT

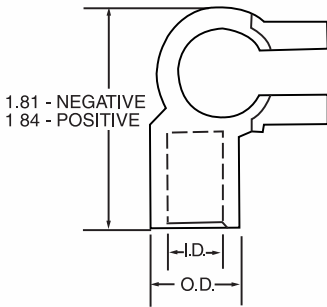

CAT. NO.	BULK CAT. NO.	SAE CABLE SIZE AND COLOR	DESCRIPTION	I.D.	O.D.	PKG. QTY.	BULK PKG. QTY.	COLOR KEY
BAC10ERNBT	BAC10ERNBT-C	1/0 Gauge	Right Elbow - Negative	.455	.625	5	100	BLACK
BAC10ERPBT	BAC10ERPBT-C	1/0 Gauge	Right Elbow - Positive	.455	.625	5	100	BLACK
BAC20ERNBT	BAC20ERNBT-C	2/0 Gauge	Right Elbow - Negative	.502	.676	5	100	ORANGE
BAC20ERPBT	BAC20ERPBT-C	2/0 Gauge	Right Elbow - Positive	.502	.676	5	100	ORANGE
BAC30ERNBT	BAC30ERNBT-C	3/0 Gauge	Right Elbow - Negative	.530	.730	5	100	PURPLE
BAC30ERPBT	BAC30ERPBT-C	3/0 Gauge	Right Elbow - Positive	.530	.730	5	100	PURPLE
BAC40ERNBT	BAC40ERNBT-C	4/0 Gauge	Right Elbow - Negative	.600	.844	5	100	YELLOW
BAC40ERPBT	BAC40ERPBT-C	4/0 Gauge	Right Elbow - Positive	.600	.844	5	100	YELLOW
BAC10ELNBT	BAC10ELNBT-C	1/0 Gauge	Left Elbow - Negative	.455	.625	5	100	BLACK
BAC10ELPBT	BAC10ELPBT-C	1/0 Gauge	Left Elbow - Positive	.455	.625	5	100	BLACK
BAC20ELNBT	BAC20ELNBT-C	2/0 Gauge	Left Elbow - Negative	.502	.676	5	100	ORANGE
BAC20ELPBT	BAC20ELPBT-C	2/0 Gauge	Left Elbow - Positive	.502	.676	5	100	ORANGE
BAC30ELNBT	BAC30ELNBT-C	3/0 Gauge	Left Elbow - Negative	.530	.730	5	100	PURPLE
BAC30ELPBT	BAC30ELPBT-C	3/0 Gauge	Left Elbow - Positive	.530	.730	5	100	PURPLE
BAC40ELNBT	BAC40ELNBT-C	4/0 Gauge	Left Elbow - Negative	.600	.844	5	100	YELLOW
BAC40ELPBT	BAC40ELPBT-C	4/0 Gauge	Left Elbow - Positive	.600	.844	5	100	YELLOW

Stackable Battery Connector — Lead-Plated

Material: High-Conductivity Copper

Finish: Electro-Tin Plated

Installing Tools: TBM5-SV or TBM5V



BAC1038

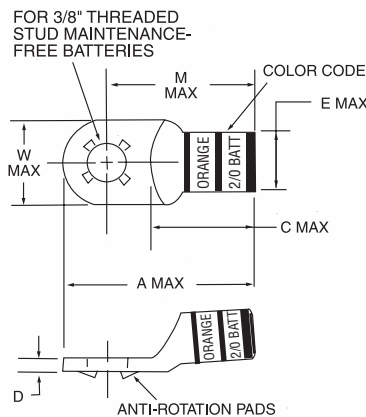

CAT. NO.	BULK CAT. NO.	SAE CABLE SIZE AND COLOR	A ±.040	M ±.020	W ±.020	C ±.020	E ±.010	STUD SIZE	PKG. QTY.	BULK PKG. QTY.	COLOR KEY
BAC438	273-31853-1	4 Gauge	1.455	1.143	.615	.750	.365	%	10	100	GRAY
BAC238	273-31853-2	2 Gauge	1.775	1.400	.675	.850	.467	%	10	100	GREEN
BAC138	273-31853-3	1 Gauge	1.875	1.500	.750	.950	.521	%	10	100	PINK
BAC1038	273-31853-4	1/0 Gauge	1.925	1.550	.825	1.000	.571	%	10	100	BLACK
BAC2038	273-31853-5	2/0 Gauge	2.110	1.645	.930	1.100	.632	%	10	100	ORANGE
BAC3038	273-31853-6	3/0 Gauge	2.025	1.650	1.025	1.100	.701	%	10	100	PURPLE
BAC4038	273-31853-7	4/0 Gauge	2.275	1.900	1.125	1.350	.766	%	10	100	YELLOW

Heavy-Duty Battery Connectors

Color-Keyed® Starter Lugs — Tin Plated

Color-Keyed® Compression



BAL414

Material: High-Conductivity Copper

Finish: Electro-Tin Plated

Installing Tools: TBM5-SV or TBM5V

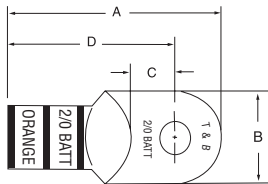

CAT. NO.	BULK CAT. NO.	SAE CABLE SIZE AND COLOR	STUD SIZE (IN.)	A ±04	B ±02	C ±02	D ±02	PKG. QTY.	BULK PKG. QTY.	COLOR KEY
BAL414	273-31852-1	4 Gauge	¼	140	52	40	115	10	100	GRAY
BAL4516	273-31852-2	4 Gauge	⅜	145	61	36	114	10	100	GRAY
BAL438	273-31852-3	4 Gauge	⅜	145	61	36	114	10	100	GRAY
BAL2516	—	2 Gauge	⅝	159	69	40	125	10	100	GREEN
BAL238	273-31852-4	2 Gauge	⅝	178	67	55	140	10	100	GREEN
BAL212	273-31852-5	2 Gauge	⅝	177	76	54	140	10	100	GREEN
BAL1516	—	1 Gauge	⅝	183	76	49	150	10	100	PINK
BAL138	273-31852-6	1 Gauge	⅝	185	75	55	150	10	100	PINK
BAL112	273-31852-7	1 Gauge	⅝	220	75	75	170	10	100	PINK
BAL10516	—	1/0 Gauge	⅝	192	83	50	150	10	100	BLACK
BAL1038	273-31852-8	1/0 Gauge	⅝	193	83	55	155	10	100	BLACK
BAL1012	273-31852-9	1/0 Gauge	⅝	197	88	53	153	10	100	BLACK
BAL20516	—	2/0 Gauge	⅝	206	93	50	160	10	100	ORANGE
BAL2038	273-31852-10	2/0 Gauge	⅝	211	93	55	165	10	100	ORANGE
BAL2012	273-31852-11	2/0 Gauge	⅝	211	93	55	165	10	100	ORANGE
BAL30516	—	3/0 Gauge	⅝	216	103	55	165	10	100	PURPLE
BAL3038	273-31852-12	3/0 Gauge	⅝	203	103	55	165	10	100	PURPLE
BAL3012	273-31852-13	3/0 Gauge	⅝	235	103	75	185	10	100	PURPLE
BAL40516	—	4/0 Gauge	⅝	240	113	59	184	10	100	YELLOW
BAL4038	273-31852-14	4/0 Gauge	⅝	228	112	55	190	10	100	YELLOW
BAL4012	273-31852-15	4/0 Gauge	⅝	260	112	75	210	10	100	YELLOW

Splices (Two-Way Connectors)



BAS4

Material: High-Conductivity Copper

Finish: Electro-Tin Plated

Installing Tools: TBM5-SV or TBM5V

CAT. NO.	BULK CAT. NO.	SAE CABLE SIZE AND COLOR	PKG. QTY.	BULK PKG. QTY.	COLOR KEY
BAS4	273-31852-16	4 Gauge	10	100	GRAY
BAS2	273-31852-17	2 Gauge	10	100	GREEN
BAS1	273-31852-18	1 Gauge	10	100	PINK
BAS10	273-31852-19	1/0 Gauge	10	100	BLACK
BAS20	273-31852-20	2/0 Gauge	10	100	ORANGE
BAS30	273-31852-21	3/0 Gauge	10	100	PURPLE
BAS40	273-31852-22	4/0 Gauge	10	100	YELLOW

“Y” Splices

Material: High-Conductivity Copper

Finish: Electro-Tin Plated

Installing Tools: TBM5-SV or TBM5V

Insulating Cover: AC5X3



BASY30

CAT. NO.	STRIP CABLE SIZE	SAE CABLE SIZE AND COLOR	LENGTH	COLOR KEY
BASY20	2/0-(2)2	2/0 Gauge	¾"	ORANGE
BASY30	3/0-(2)1	3/0 Gauge	¾"	PURPLE
BASY40	4/0-(2)1/0	4/0 Gauge	¾"	YELLOW

Battery Cables, Heavy-Duty Battery Cables

Abrasion-resistant and engineered for optimum performance at both high and low temperatures.

Color-Keyed® Battery/Starter Cables

- Fine flexible copper rope stranding PVC jacket conforms to SAE J1127 specifications
- Layer of paper separates insulation from copper, providing easy stripping with no stranding damage
- Temperature-rated for 80° C
- Flexibility ideal for tight spaces and cold environments
- Color-Keyed® markings for fast and accurate identification
- Marked in 1-ft. increments for easy measurement
- Available in red or black jacket color



BC10-25



BC10-25R

CAT. NO.	SAE CABLE SIZE	CABLE LENGTH	CABLE COLOR
BC4-100	4 Gauge	100 Ft. Coil	BLACK
BC2-100	2 Gauge	100 Ft. Coil	BLACK
BC1-100	1 Gauge	100 Ft. Coil	BLACK
BC10-100	1/0 Gauge	100 Ft. Coil	BLACK
BC20-100	2/0 Gauge	100 Ft. Coil	BLACK
BC30-100	3/0 Gauge	100 Ft. Coil	BLACK
BC40-100	4/0 Gauge	100 Ft. Coil	BLACK

BC4-1000	4 Gauge	1000 Ft. Coil	BLACK
BC2-500	2 Gauge	500 Ft. Coil	BLACK
BC1-500	1 Gauge	500 Ft. Coil	BLACK
BC10-500	1/0 Gauge	500 Ft. Coil	BLACK
BC20-500	2/0 Gauge	500 Ft. Coil	BLACK
BC30-500	3/0 Gauge	500 Ft. Coil	BLACK
BC40-500	4/0 Gauge	500 Ft. Coil	BLACK

BC4-1000R	4 Gauge	1000 Ft. Coil	RED
BC2-500R	2 Gauge	500 Ft. Coil	RED
BC1-500R	1 Gauge	500 Ft. Coil	RED
BC10-500R	1/0 Gauge	500 Ft. Coil	RED
BC20-500R	2/0 Gauge	500 Ft. Coil	RED
BC30-500R	3/0 Gauge	500 Ft. Coil	RED
BC40-500R	4/0 Gauge	500 Ft. Coil	RED



CAT. NO.	SAE CABLE SIZE	CABLE LENGTH	CABLE COLOR
BC4-25	4 Gauge	25 Ft. Coil	BLACK
BC2-25	2 Gauge	25 Ft. Coil	BLACK
BC1-25	1 Gauge	25 Ft. Coil	BLACK
BC10-25	1/0 Gauge	25 Ft. Coil	BLACK
BC20-25	2/0 Gauge	25 Ft. Coil	BLACK
BC30-25	3/0 Gauge	25 Ft. Coil	BLACK
BC40-25	4/0 Gauge	25 Ft. Coil	BLACK

BC4-25R	4 Gauge	25 Ft. Coil	RED
BC2-25R	2 Gauge	25 Ft. Coil	RED
BC1-25R	1 Gauge	25 Ft. Coil	RED
BC10-25R	1/0 Gauge	25 Ft. Coil	RED
BC20-25R	2/0 Gauge	25 Ft. Coil	RED
BC30-25R	3/0 Gauge	25 Ft. Coil	RED
BC40-25R	4/0 Gauge	25 Ft. Coil	RED

Material: High-Conductivity Copper

Finish: Electro-Tin Plated

Installing Tools: TBM5-SV or TBM5V

Specially designed for demanding industrial and OEM requirements.

Heavy-Duty Battery Cable

- 105°C temperature-rated and UL recognized
- Heavier PVC jacket conforms to SAE J1127 specifications
- Color-Keyed® markings for fast and accurate identification
- Marked in 1-ft. increments for easy measurement
- Layer of paper separates insulation from copper for easy stripping with no strand damage
- 600V rated available in bulk only
- Application-specific — call to order



Color-Keyed® Compression

Mechanical Compression Tools: #8 to 250 MCM

TBM25S Crimp Tool



Creates Diamond-style crimp

- Wide range of #8 to #2 for copper lugs and #10 to #6 for aluminum lugs
- Each die has die code embossing
- Shure-Stake® mechanism ensures a properly completed crimp each time
- Color-coded die wheel rotates into position for proper die nest
- Also installs up to green color-coded C-taps and MD2 Series motor disconnects
- Requires two crimps per connector



CAT. NO.	DESCRIPTION	PKG. QTY.
TBM25S	Crimp tool with Shure-Stake® mechanism for #8–#2 copper and #10–#6 aluminum	1

TBM4S Dieless Crimp Tool



Creates Indent-style crimp

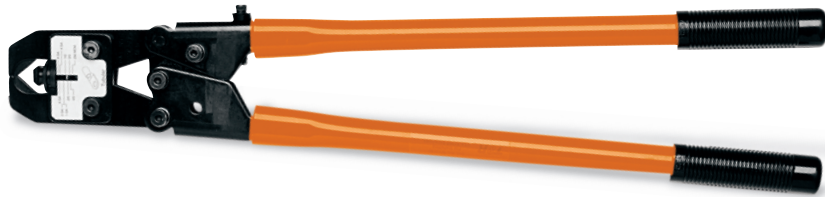

- Wide range of #8 to 250 kcmil for copper lugs and #8 to 4/0 for aluminum lugs
- Adjustable indenter eliminates the need to buy and maintain numerous individual dies
- Shure-Stake® mechanism ensures a properly completed crimp each time
- Easily adjusted by turning knurled adjusting wheel and aligning pointer with proper terminal size
- Dieless, adjustable crimper for Color-Keyed® compression connectors

CAT. NO.	DESCRIPTION	PKG. QTY.
TBM4S	Dieless crimp tool with Shure-Stake® mechanism for #8–250 kcmil copper and #8–4/0 aluminum	1

TBM5S Crimp Tool



Creates Diamond-style crimp



- Wide range of #8 to 250 kcmil for copper and #10 to 4/0 for aluminum lugs and splices
- Also installs C-taps from 54705 to 54750
- Shure-Stake® mechanism ensures a properly completed crimp each time
- Includes color-coded, die-code-embossed installation dies

CAT. NO.	Color Code	DIE CAT. NO.	PKG. QTY.
TBM5S	RED	13454	1
	BLUE		
	GRAY		
	BROWN	13455	
	GREEN		
	PINK		
	BLACK	13456	
	ORANGE		
	PURPLE		
	YELLOW	13457	
	GOLD		
	TAN		
	OLIVE	13458	
RUBY			
WHITE			

Mechanical Compression Tools: #8 to 500 MCM

TBM6S Crimp Tool



Creates Diamond-style crimp



- Wide ranges of #8 thru 500 kcmil for copper lugs, splices and taps and #10 thru 350 kcmil for aluminum lugs and splices
- Also installs 63105 through 63140 orange, green and blue H-taps
- Shure-Stake® mechanism ensures a properly completed crimp each time
- Comes complete with plastic carrying case and wire brush

CAT. NO.	COLOR CODE	CAT. NO. UPPER DIE	CAT. NO. LOWER DIE	PKG. QTY.
TBM6S	RED	13475	13477	1
	BLUE	13475	13477	
	GRAY	13472	13476	
	BROWN	13474	13477	
	GREEN	13474	13477	
	PINK	13475	13477	
	BLACK	13474	13477	
	ORANGE	13474	13477	
	PURPLE	13475	13477	
	YELLOW	13473	13476	
	GOLD	13474	13477	
	TAN	13474	13477	
	OLIVE	13475	13477	
	RUBY	13473	13476	
	WHITE	13473	13476	
RED	13472	13476		
BLUE	13472	13476		

Carrying Cases for TBM5S and TBM6S

CAT. NO.	DESCRIPTION	PKG. QTY.
295-31365M	Steel Carrying Case for TBM5S and TBM6S	1
295-31365	Plastic Carrying Case for TBM5S and TBM6S	1

TBM8S Crimp Tool



Creates Diamond-style crimp



- Installs code copper lugs and connectors #8 through 500 kcmil
- Installs aluminum lugs and connectors #10 through 350 kcmil
- Shure-Stake® mechanism ensures positive compression
- Included dies are color-coded and provide die-code embossing for easy installation and inspection
- Installs all code copper compression joints and small C-taps
- Comes complete with installing dies and wire brush in plastic carrying case

CAT. NO.	COLOR CODE	DIE CAT. NO.	PKG. QTY.
TBM8S	RED	13461	1
	BLUE		
	GRAY		
	BROWN	13462	
	GREEN		
	PINK		
	BLACK	13463	
	ORANGE		
	PURPLE		
	YELLOW	13464	
	GOLD		
	TAN		
	OLIVE	13465	
	RUBY		
	WHITE		
RED	13466		
BLUE	13467		
BROWN	13468		

Power-Assisted Compression Tools: #8 to 500 MCM

25000 Air-Operated Bench-Mount Crimp Tool

Color-Keyed® Compression



- Installs copper and aluminum connectors on wire sizes from 8 AWG to 500 kcmil
- Compact, heavy-duty air tool
- Simple to operate — just insert stripped wire into connector barrel, position it in crimping nest and depress foot pedal to actuate crimping dies
- Uses same crimping dies as TBM6S (see p. B-75)



Creates Diamond-style crimp

CAT. NO.	DESCRIPTION	PKG. QTY.
25000	Air-Operated Bench-Mount Crimp Tool	1

Battpac® LT BPLT62BSCR/BPLT62500BSCR 6-Ton Compression Tools



- Ergonomic design and reduced weight for operator comfort
- New double-speed feature decreases crimp time by doubling jaw speed until it reaches load
- New, more powerful Ni-MH battery has 50% more energy and less memory effect than old batteries
- Rotating head allows maximum flexibility for crimping
- Uses TBM62 Series dies



Creates Hex-style crimp

Specifications

- Installing Range:
 - Up to 500 mcm copper lugs & splices
 - Up to 350 mcm aluminum lugs & splices
 - 54705 to 54750 C-taps
- Output Force: 6 tons
- Dimensions (L x W x H): 11" x 3 3/4" x 11 1/2"
- Battery: Ni-MH 14.4V 3.0Ah
- Weight with Battery: 8 lbs.

CAT. NO.	DESCRIPTION	PKG. QTY.
BPLT62BSCR	Battpac® LT Tool Kit. Includes tool, two batteries, charger, shoulder strap, wrist strap, carrying case (no dies).	1
BPLT62500BSCR	Complete Battpac® LT Tool Kit with dies TBM6221 through TBM6287.	1

Power-Assisted Compression Tools: #8 to 600 MCM

Battpac® LT BPLT6BSCR 6-Ton Compression Tool

- Open yoke design allows for maximum crimping flexibility
- New double-speed feature decreases crimp time by doubling jaw speed until it reaches load
- New, more powerful Ni-MH battery has 50% more energy and less memory effect than old batteries
- Uses 6-TON Series dies and Blackburn “O” and “D” Series dies



Creates Hex-style crimp



NEW!

Color-Keyed® Compression

Specifications

- Installing Range:
 - Up to 600 mcm copper lugs & splices
 - Up to 400 mcm aluminum lugs & splices
 - CHT814-10 to CHT214-9 copper H-taps
 - 63105 to 63148 aluminum H-taps
 - 54705 to 54750 C-taps
- Output Force: 6 tons
- Dimensions (L x W x H): 11" x 3 3/4" x 11 7/8"
- Battery: Ni-MH 14.4V 3.0Ah
- Weight with Battery: 8 lbs.

CAT. NO.	DESCRIPTION	PKG. QTY.
BPLT6BSCR	Battpac® LT Tool Kit. Includes tool, two batteries, charger, shoulder strap, carrying case (no dies)	1

Battpac® TBM61520BSCR 6-Ton Compression Tool and Optional 61520CAT Cutting Head

- Supplied crimp head can be interchanged with optional cutter head — quick-release pins make the switch fast and simple
- Rapid-advance feature yields quicker compression cycles
- Optional cutting head cuts cable up to 500 kcmil
- 1.8" jaw opening
- D3 die nest comes standard with tool
- Accepts T&B® 6-TON SERIES, Blackburn® “O” dies and other manufacturers’ crimp dies



Creates Hex-style crimp



Specifications

- Installing Range:
 - Up to 600 mcm copper lugs & splices
 - Up to 400 mcm aluminum lugs & splices
 - CHT814-10 to CHT214-9 copper H-taps
 - 63105 to 63148 aluminum H-taps
- Max. Cutting Capacity (with 61520CAT cutting head):
 - Copper and aluminum cable to 500 kcmil
- Output Force: 6 tons
- Dimensions (L x W x H): 12" x 3" x 13"
- Battery: Ni-MH 14.4V 3.0Ah

CAT. NO.	DESCRIPTION	PKG. QTY.
TBM61520BSCR	Battpac® Crimp Tool Kit. Includes battery-powered crimp tool, battery, charger, shoulder strap, carrying case (no dies)	1
61520CAT	Interchangeable Cutting Head for TBM61520BSCR	1
TBM61520BSCR	Battpac® Crimp/Cut Tool Kit. Includes battery-powered crimp tool, interchangeable cutting head, battery, charger, shoulder strap, carrying case (no dies)	1

TBM6H 6-Ton Hydraulic Crimping Head

- Lightweight design — weighs less than 7 lbs., including dies
- Embosses die code on connection for easy inspection
- Uses 6-TON Series and Blackburn “O” and “D” Series dies color-coded for easy matching with Color-Keyed® connectors



Creates Hex-style crimp



Specifications

- Installing Range:
 - Up to 600 mcm copper lugs & splices
 - Up to 400 mcm aluminum lugs & splices
 - CHT814-10 to CHT214-9 copper H-taps
 - 63105 to 63148 aluminum H-taps
 - 54705 to 54750 C-taps
- Output Force: 6 tons
- Operating Pressure: 10,000 psi nominal
- Dimensions (L x W x H): 12" x 2 1/4" x 3 3/8"
- Weight without Dies: 6.5 lbs.

CAT. NO.	DESCRIPTION	PKG. QTY.
TBM6H	6-Ton Hydraulic Head with Steel Case	1
TBM6HD-1	Die Set for #8 thru 500 kcmil (6-TON21 thru 6-TON87)	1

Power-Assisted Compression Tools: #8 to 750 MCM, #8 to 900 MCM

TBM12 12-Ton Hydraulic Crimp Head

Color-Keyed® Compression



Creates Hex-style crimp



- Rugged steel construction is durable for most applications
- Includes five sets of multi-nested dies
- Dies emboss die code on connectors for easy inspection
- Closed yoke design yields maximum crimp performance
- Uses TBM12D style dies

Specifications

- Installing Range:
 - Up to 900 mcm copper lugs & splices
 - Up to 750 mcm aluminum lugs & splices
 - 54755 to 54775 C-taps
- Output Force: 12 tons
- Operating Pressure: 10,000 psi nominal
- Dimensions (L x W x H): 14½" x 2½" x 3⅝"
- Weight without Dies: 9 lbs.

CAT. NO.	DESCRIPTION	PKG. QTY.
TBM12	12-ton Hydraulic Head with Steel Case	1

If using old style 11700 Series Die Set, use adapter, Cat. No. TBM12D-AR (not included) for adaptation to the above tool. Order adapter separately.

13642M 12-Ton Hydraulic Crimping Head

- Rugged steel construction is durable for most applications
- Used for Color-Keyed® and Sta-Kon® connectors
- The only military-listed hydraulic head (Mil. Spec. MS25441-1)
- Uses 11700 Series dies for Color-Keyed® connectors; see Sta-Kon® section for Sta-Kon® dies

Specifications

- Installing Range:
 - Up to 900 mcm copper lugs & splices
 - Up to 750 mcm aluminum lugs & splices
 - 54755 to 54775 C-taps
- Output Force: 12 tons
- Operating Pressure: 10,000 psi nominal
- Dimensions (L x W x H): 14½" x 2½" x 3⅝"
- Weight without Dies: 9 lbs.



Creates Hex-style crimp

CAT. NO.	DESCRIPTION	PKG. QTY.
13642M	12-ton Hydraulic Head with Steel Case	1

Power-Assisted Compression Tools: #8 to 900 MCM

SMART® Tools

- Tool is “smart” because it requires no dies
- Automatically compresses to the correct depth based on size of connector in jaws
- C-type head swivels 90° for easy crimp positioning
- Forged steel construction is well suited for both field and bench work
- Installs both Color-Keyed® and non-insulated Sta-Kon® connectors

How the SMART® Tool Works

The SMART® Tool was engineered with built-in intelligence* that enables it to sense the connector barrel diameter and automatically apply just the right amount of compression force. This eliminates virtually all air spaces and forms the connector and conductor strands into a solid mass, resulting in a high-quality, low-resistance connection. In addition, the tool clearly embosses “T&B” with each compression for positive verification that the correct tool was used.

* System Novopress

Uniform, Dependable Connections

The SMART® Tool gives you consistent, high-quality compression connections over a wide range of connector sizes. Available in manual, battery-powered and air-operated versions, this tool easily installs lugs and splices from #8 AWG through 900 mcm copper or 750 mcm aluminum — without changing dies. For the specified wire range, all you need is one tool. You always have the right die size, eliminating die-selection mistakes.

Lower Installation Costs

Productivity will be greatly improved with the SMART® Tool, especially when installing a variety of connector sizes or types. Initial investment is low, requiring minimal tool inventory. These benefits add up to lower installed cost.

C-Type Yoke Offers Installation Convenience

The C-type yoke configuration and large die spacing enable the SMART® Tool to slip directly over the connector. This means added speed and convenience when installing two-way splice connectors, especially in confined spaces.

SMART® Tool Range Taking Features

The following size Color-Keyed® lugs and splice connectors, when crimped with the SMART® Tools, produce these range taking capabilities:

Copper		Aluminum	
Standard Wire Size	Range Taking	Standard Wire Size	Range Taking
1/0-AWG	#6-1/0 AWG	1/0-AWG	#6-1/0 AWG
2/0-AWG	#1-2/0 AWG	2/0-AWG	#1-2/0 AWG
4/0-AWG	#2-4/0 AWG	4/0-AWG	#2-4/0 AWG
300 kcmil	#2/0-300 kcmil	300 kcmil	#2/0-300 kcmil
350 kcmil	250-350 kcmil	350 kcmil	250-350 kcmil
500 kcmil	250-500 kcmil	500 kcmil	4/0-500 kcmil
750 kcmil	500-750 kcmil	750 kcmil	500-750 kcmil

TBM8-750M-1 12-Ton Dieless Manual Hydraulic Tool



Creates Indent-style crimp



Specifications

- Installing Range:
 - Up to 900 mcm copper lugs & splices
 - Up to 750 mcm aluminum lugs & splices
- Output Force: 12 tons
- Dimensions (L x W): 21½" x 4½"
- Weight: 13 lbs.

CAT. NO.	DESCRIPTION	PKG. QTY.
TBM8-750M-1	12-Ton Dieless Manual Hydraulic Compression Tool	1

Battpac® LT TBM8-750BSCR 12-Ton Dieless Battery-Powered Tool



Creates Indent-style crimp



Specifications

- Installing Range:
 - Up to 900 mcm copper lugs & splices
 - Up to 750 mcm aluminum lugs & splices
- Output Force: 12 tons
- Dimensions (L x W x H): 19½" x 3¾" x 8½"
- Battery: Ni-MH 14.4V 3.0Ah
- Weight with Battery: 9 lbs.

CAT. NO.	DESCRIPTION	PKG. QTY.
TBM8-750BSCR	Battpac® LT 12-Ton Dieless Battery-Powered Compression Tool. Includes carrying case, charger, two batteries and carry strap.	1

TBM8-750 12-Ton Dieless Hydraulic Head



Creates Indent-style crimp



Specifications

- Installing Range:
 - Up to 900 mcm copper lugs & splices
 - Up to 750 mcm aluminum lugs & splices
- Operating Pressure: 10,000 psi nominal
- Dimensions (L x W x H): 14½" x 4½" x 2½"
- Weight: 9 lbs.
- Output Force: 12 tons

CAT. NO.	DESCRIPTION	PKG. QTY.
TBM8-750	12-Ton Dieless Hydraulic Compression Head	1

Color-Keyed® Compression

Power-Assisted Compression Tools: #8 to 900 MCM

TBM14M 14-Ton Manual Hydraulic Crimp Tool

- Features short fiberglass handles for insulation and ease of use in tight spaces
- Two-stage pump provides rapid advance for fast installation
- Uses standard T&B Color-Keyed® 15500 Series dies

Specifications

- Installing Range: 63105 to 63148 aluminum H-taps
Up to 900 mcm copper lugs & splices 54755 to 54775 C-taps
- Output Force: 14 tons
- Length: 24"
- Weight without Dies: 15.4 lbs.
- Up to 750 mcm aluminum lugs & splices
- CHT814-10 to CHT2502-6 copper H-taps



Creates Hex-style crimp



CAT. NO.	DESCRIPTION	PKG. QTY.
TBM14M	14-ton manual hydraulic crimp tool with case	1

TBM14MC 14-Ton Compact Manual Hydraulic Crimp Tool



- Improved ergonomic design requires less force
- 180° rotating head for use in tight spaces
- 1.65" jaw opening accommodates large compression terminals and joints
- Dual-speed action pump offers fast advancing speed for approach of die to connector and slower, more powerful speed for crimping
- Built-in safety valve bypasses oil supply at maximum pressure
- Pressure-release system can be easy activated at any stage of compression
- Uses standard T&B Color-Keyed® 15500 Series dies



Creates Hex-style crimp



Specifications

- Installing Range: 63105 to 63148 aluminum H-taps
Up to 900 mcm copper lugs & splices 54755 to 54775 C-taps
- Output Force: 14 tons
- Length: 20½"
- Weight without Dies: 14 lbs.
- Up to 750 mcm aluminum lugs & splices
- CHT814-10 to CHT2502-6 copper H-taps

CAT. NO.	DESCRIPTION	PKG. QTY.
TBM14MC	14-ton compact hydraulic crimp tool	1

Battpac® TBM14BSCR Hermetically Sealed 14-Ton Battery-Powered Compression Tool



TBM14BSCR

- Weather-resistant, non-ventilated body for maximum protection from the elements
- Double-speed feature decreases crimp time by doubling jaw speed until it reaches load
- 180° rotating head
- 75kv live line rated
- Insulated crimping head
- 20-minute rapid battery charger
- Includes two batteries



Creates Hex-style crimp

Specifications

- Installing Range: 54755 to 54775 C-taps
Up to 900 mcm copper lugs & splices
- Output Force: 14 tons
- Dimensions (L x W x H): 19" x 3½" x 10½"
- Battery: 14.4V 3.0Ah Ni-Cd
- Weight with Battery: 20 lbs.
- Up to 750 mcm aluminum lugs & splices
- CHT814-10 to CHT2502-6 copper H-taps
- 63105 to 63148 aluminum H-taps

CAT. NO.	DESCRIPTION	PKG. QTY.
TBM14BSCR	Battpac® 14-Ton Compression Tool. Hermetically sealed unit. Includes carrying case, charger, two batteries, carry strap	1

Power-Assisted Compression Tools: #8 to 900 MCM and #8 to 1500 MCM

Battpac® LT BPLT14BSCR/BPLT14BSCRI 14-Ton Battery-Powered Compression Tools



BPLT14BSCR

- Reduced weight and ergonomic design
- Double-speed feature decreases crimp time by doubling jaw speed until it reaches load
- Rotating head allows maximum flexibility for crimping
- Includes two Makita 14.4V Ni-MH batteries (3.0 AMP Hrs.)
- Built-in LED battery power indicator
- On-tool DC power jack

Specifications

- Installing Range: 54755 to 54775 C-taps
- Up to 900 mcm copper lugs & splices
- Up to 750 mcm aluminum lugs & splices
- CHT814-10 to CHT2502-6 copper H-taps
- 63105 to 63148 aluminum H-taps
- Output Force: 14 tons
- Dimensions (L x W x H): 18 1/2" x 3 3/4" x 10"
- Battery: 14.4V 3.0Ah Ni-MH
- Weight with Battery: 18.1 lbs.

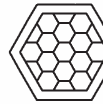

Creates Hex-style crimp

CAT. NO.	DESCRIPTION	PKG. QTY.
BPLT14BSCR	Battpac® LT 14-Ton Compression Tool. Includes carrying case, charger, two-batteries, carry strap	1
BPLT14BSCRI	Same as above, but fully insulated	

13100A 14-Ton Hydraulic Crimping Head

- Rugged design, made to last in field or on bench
- C-yoke provides maximum flexibility for crimping
- Uses standard T&B Color-Keyed® 15500 Series dies
- Operates on 10,000 psi hydraulic pumps

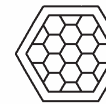

Creates Hex-style crimp



Specifications

- Installing Range: 54755 to 54775 C-taps
- Up to 900 mcm copper lugs & splices
- Up to 750 mcm aluminum lugs & splices
- CHT814-10 to CHT2502-6 copper H-taps
- 63105 to 63148 aluminum H-taps
- Output Force: 14 tons
- Operating Pressure: 10,000 psi nominal
- Dimensions (L x W x H): 11 1/2" x 2 1/2" x 4 1/4"
- Weight without Dies: 10 lbs.

CAT. NO.	DESCRIPTION	PKG. QTY.
13100A	14-ton hydraulic head with steel case	1

Battpac® TBM15BSCR Hermetically Sealed 15-Ton Battery-Powered Compression Tool

- Weather-resistant, non-ventilated body for use in the most corrosive environments
- High grade forged steel head rotates 180°
- Rapid jaw-advance feature allows the operator quicker compression cycles
- 75kv live line rated
- 20-minute rapid battery charger



Creates hex-style crimp



TBM15BSCR

Specifications

- Installing Range: 54755 to 54790 C-taps
- Up to 1500 mcm copper lugs & splices
- Up to 1000 mcm aluminum lugs & splices
- CHT814-10 to CHT750-350-1F copper H-taps
- 63105 to 63180 aluminum H-taps
- Output Force: 15 tons
- Dimensions (L x W x H): 21" x 3 1/2" x 11"
- Battery: 14.4V 3.0Ah Ni-Cd
- Weight with Battery: 23.75 lbs.

CAT. NO.	DESCRIPTION	PKG. QTY.
TBM15BSCR	Battpac® 15-Ton Battery-Powered Compression Tool. Hermetically sealed unit. Includes carrying case, charger, two batteries, carry strap	1

Power-Assisted Compression Tools: #8 to 1500 or 2000 MCM

Battpac® LT BPLT15BSCR 15-Ton Battery-Powered Compression Tool

- Rotating head allows maximum flexibility for crimping
- Double-speed feature decreases crimp time by doubling jaw speed until it reaches load
- Includes two Makita 14.4V Ni-MH batteries (3.0 AMP Hrs.)
- Built-in LED battery power indicator
- On-tool DC power jack



Creates hex-style crimp



BPLT15BSCR

Specifications

- Installing Range:
 - Up to 1500 mcm copper lugs & splices
 - Up to 1000 mcm aluminum lugs & splices
 - CHT814-10 to CHT750-350-1F copper H-taps
 - 63105 to 63180 aluminum H-taps
 - 54755 to 54790 C-taps
- Output Force: 15 tons
- Dimensions (L x W x H): 21" x 3½" x 11"
- Battery: 14.4V 3.0Ah Ni-MH
- Weight with Battery: 23.75 lbs.

CAT. NO.	DESCRIPTION	PKG. QTY.
BPLT15BSCR	Battpac® LT 15-Ton Compression Tool. Includes carrying case, charger, two batteries, and carry strap	1

TBM15I 15-Ton Hydraulic Crimping Head



Creates hex-style crimp

- Head made of forged steel and insulated with rubber boot
- Longer, slimmer design enables easier access into tight spaces, such as in cable tray and central office applications
- Wider jaw opening eases crimping of larger lugs, C-taps and H-taps
- Uses 15600 Series dies; can also use 15500 Series dies with 15500-TB adapter

Specifications

- Installing Range:
 - Up to 1500 mcm copper lugs & splices
 - Up to 1000 mcm aluminum lugs & splices
 - CHT814-10 to CHT750-350-1F copper H-taps
 - 63105 to 36180 aluminum H-taps
 - 54755 to 54790 C-taps
- Output Force: 15 tons
- Operating Pressure: 10,000 psi nominal
- Dimensions (L x W x H): 15½" x 2½" x 4¾"
- Weight without Dies: 16.5 lbs.

CAT. NO.	DESCRIPTION	PKG. QTY.
TBM15I	Insulated 15-Ton Hydraulic Head with Steel Case	1

15600 Series — Fits directly into tool for larger size connectors, 800 kcmil–1,500 kcmil
 15500 Series — Used in conjunction with 15500-TB Adapter, #8 AWG–750 kcmil

21940 40-Ton Hydraulic Crimping Head

- Compact design delivers maximum pressure for larger lugs and splices
- Ideal for applications requiring larger lugs up to 2000 mcm
- Uses 11300 and 11400 Series dies



Creates hex-style crimp

Specifications

- Installing Range:
 - Up to 2000 mcm copper lugs & splices
 - Up to 2000 mcm aluminum lugs & splices
- Output Force: 40 tons
- Operating Pressure: 10,000 psi nominal
- Dimensions (L x W x H): 12" x 4¾" x 7¾"
- Weight without Dies: 40 lbs.

CAT. NO.	DESCRIPTION	PKG. QTY.
21940	40-Ton Hydraulic Head with Steel Case	1

Hydraulic Pumps

13606 Foot-/Hand-Operated and 13604 Hand-Operated Hydraulic Pump

- 13606 operates with either foot or hand; 13604 is hand operated only
- Operates all T&B hydraulic heads
- Built-in safety bypass valve
- Factory set at 9,800 psi

Specifications

- Nominal Pressure: 9,800 psi
- Pumping Capacity: 2.6 cu. in./min. @ 200 psi
0.16 cu. in./min. @ 10,000 psi
- Reservoir Volume: 125 cu.in. (0.54 gal.)
- Max. Handle Force: 130 lbs.
- Dimensions (L x W x H): 23" x 5¼" x 6¾"
- Weight: 29 lbs.



13606 Foot-/Hand-Operated Hydraulic Pump

CAT. NO.	DESCRIPTION	PKG. QTY.
13606	Combination Hand or Foot-Operated Hydraulic Pump	1
13604	Hand-Operated Hydraulic Pump	1

Battpac® LT BPLT13970P2 Pump

- Small and lightweight
- 60 minutes full recharge
- Highly visible display indicates battery power level
- Socket for 24 VDC external connection
- Operation in any position: on its side or upright
- Separate operation/release buttons protect against accidental operation
- Energy consumption limited by automatic shut-off
- Easily accessible oil top-up inlet



Specifications

- Nominal Pressure: 10,000 psi
- Pumping Capacity: 30 cu.in./min.
- Reservoir Volume: 60 cu.in. (26 gal.)
- Dimensions (L x W x H): 13½" x 6½" x 12¾"
- Battery: Ni-MH 24V, 3 Ah
- Weight with Battery: 20.9 lbs.

Battery Performance Guide

In tests, the number of crimps obtained from a fully charged battery, using a remote crimping head, was:

- 102 crimps for Cu connectors on 250 kcmil HD Cu conductor
- 98 crimps for C-Tap connectors on #2 AWG HD Cu conductor
- 76 crimps for Cu sleeve connectors on 500 kcmil HD Cu conductor

CAT. NO.	DESCRIPTION	PKG. QTY.
BPLT13970P2	Battpac® LT Pump includes canvas accessories carrying bag, carrying strap, remote hand controller, two batteries, battery charger and non-drip couplings	1
BPLT13970RB	Ni-MH 24V Replacement battery	1
BPLT13970RP	Canvas backpack for pump	1
BPLT13970DC	Power connecting cable with clips	1
BPLT13970FS	Remote foot pedal controller	1

Hydraulic Pumps

13600 Electric Hydraulic Pump

- Designed for use with single-acting cylinders and tools rated for 10,000 psi operation
- Supplied with metal carrying case
- 13620 hand switch and 13619 hydraulic hose, both sold separately, required for operation

Specifications

- Motor: ½ hp, 115V 50–60 Hz 10 amps
- Pumping Capacity: 170 cu. in./min. at 100 psi
32 cu. in./min. at 1,000 psi
25 cu. in./min. at 5,000 psi
18 cu. in./min. at 10,000 psi
- Reservoir Volume: 104 cu. in. (.45 gal.)
- Basic Pump Dimension: 6" x 8" x 16"
- Weight: 25 lbs.

CAT. NO.	DESCRIPTION	PKG. QTY.
13600	Electric Hydraulic Pump — hand or foot switch and non-metallic hose (sold separately) required for operation	1

You may also need...

13620	Hand Switch — 10 ft.	1
13589A	Foot Switch — 10 ft.	1
13619	10 ft. Non-Metallic Hose	1
13618	20 ft. Non-Metallic Hose	1
13600S	"Sled" type stand for 13600 pump	1



13610A Electric Hydraulic Pump with Shure-Stake® Control

- Shure-Stake® control mechanism requires 9,800 psi pump pressure before recycling to prevent under-crimping
- Designed for use with single-acting cylinders and tools rated for 10,000 psi operation
- Supplied with metal carrying case

Specifications

- Motor Rating: ½ hp, 115V, 50–60 Hz, 12.5 amps
- Pumping Capacity: 170 cu. in./min. at 100 psi
32 cu. in./min. at 1,000 psi
25 cu. in./min. at 5,000 psi
18 cu. in./min. at 10,000 psi
- Reservoir Volume: 104 cu. in. (.45 gal.)
- Basic Pump Dimension: 8½" x 10½" x 16"
- Weight: 35 lbs.

CAT. NO.	DESCRIPTION	PKG. QTY.
13610A	Electric Hydraulic Pump with Shure-Stake® control — hand or foot switch and non-metallic hose (sold separately) required for operation	1

You may also need...

13611	Hand Switch — 10 ft.	1
13612	Foot Switch — 10 ft.	1
13619	10 ft. Non-Metallic Hose	1
13618	20 ft. Non-Metallic Hose	1



Hydraulic Pumps and Battery Connector Tools

13810 Heavy-Duty Electric Hydraulic Pump with Shure-Stake® Control

- Designed for perfect crimps every time in heavy-duty OEM applications
- Heavy-duty OEM two-stage pump with high flow rate
- Shure-Stake® control mechanism requires 9,800 psi pump pressure before recycling to prevent under-crimping
- Requires hand or foot control (sold separately)

Specifications

- Motor Rating: 1½ hp, 115V, 60 Hz, 23 amps
- Pumping Capacity: 235 cu.in./min. at 200 psi
61 cu.in./min. at 8,000 psi
- Reservoir Volume: 462 cu.in./2 gal.
- Dimensions (L x W x H): 10¾" x 15" x 20¾"
- Weight: 60 lbs.



CAT. NO.	DESCRIPTION	PKG. QTY.
13810	Heavy-duty electric hydraulic pump with Shure-Stake® control — hand or foot switch and non-metallic hose (sold separately) required for operation	1

You may also need...

13611	Hand switch — 10 ft.	1
13612	Foot switch — 10 ft.	1
13619	10 ft. Non-Metallic Hose	1
13618	20 ft. Non-Metallic Hose	1

Battery Connector Crimp Tools

- Adjustable die crimping tool for Color-Keyed® cast and tubular battery connectors
- Available with Shure-Stake® mechanism to ensure a complete crimp every time (BCT840S)
- Crimps casting and tubular battery connectors ranging from 4 AWG to 4/0
- Heavy-duty crimping tool including die for 8 AWG-4/0 battery connectors, lugs and splices
- The single die is an integral part of the tool; no dies to lose or misplace
- Available with Shure-Stake® mechanism to ensure a complete crimp every time (TBM5SV)

BCT840, BCT840S



TBM5SV, TBM5V



CAT. NO.	DESCRIPTION	PKG. QTY.
BCT840	Dieless Crimp Tool for cast and tubular battery connectors	1
BCT840S	Dieless Crimp Tool with Shure-Stake® mechanism for cast and tubular battery connectors	1
TBM5V	Ratchet Crimp Tool with die for 8 AWG to 4/0 battery connectors	1
TBM5SV	Ratchet Crimp Tool with Shure-Stake® mechanism and die for 8 AWG to 4/0 battery connectors	1

Miscellaneous Hydraulic Pump Accessories

CAT. NO.	DESCRIPTION	PKG. QTY.
21061	Hydraulic Oil	1
13798	Male Pioneer Quick Disconnect Coupler	1
13799	Female Pioneer Quick Disconnect Coupler	1
13614	Metallic Reinforced Hose for OEM operations — 10 ft.	1

Strippers, Cutters and Other Tools

BCS8-40 Cable Stripper



BCS8-40

CAT. NO.	DESCRIPTION	PKG. QTY.
BCS8-40	Cable stripper for 8 AWG-4/0 battery cable with replacement blade provided in the handle	1

368-CK Cable Stripper



CAT. NO.	DESCRIPTION	PKG. QTY.
368-CK	Cable stripper for #1 to 1,000 kcmil	1

364RF/366RF Cable Cutters with Fiberglass Handles



CAT. NO.	CABLE SIZE	PKG. QTY.
364RF	Cutter for up to 500 kcmil copper and aluminum	1
366RF	Cutter for up to 1,000 kcmil copper and aluminum	1

For copper and aluminum cable only. Not for steel.
Replacement blades are available through Tool Services.

TBM40HC Hand-Operated Hydraulic Cutting Tool

- Specifically designed to cut copper, aluminum and telecommunications cables up to 3.35" O.D.
- Offers dual-speed action: fast advancing speed for rapid approach of blades to cable and slower, more powerful speed for cutting
- Blades manufactured from high-strength, heat-treated steel to ensure long service life
- Head easily opens to enable cutting of existing run cables
- Head rotates 180°, enabling operator to position for easiest use
- Automatic safety valve bypasses oil when reaching maximum pressure
- Pressure release device can also be activated during any point of operation



Specifications

- Max. Cutting Capacity: 3.35" O.D.
- Weight: 14.55 lbs.
- Dimensions (L x W): 25.69" x 6.89"

CAT. NO.	DESCRIPTION	PKG. QTY.
TBM40HC	Hand-operated hydraulic cutting tool	1

Strippers, Cutters and Other Tools

CSR750 Cable Cutter



- Special advance stroke mechanism requires less handle force
- Cuts copper or aluminum cables up to 750 kcmil
- Short handles (only 10" long) enable use in tight spaces

CAT. NO.	DESCRIPTION	PKG. QTY.
CSR750	Cutter for up to 750 kcmil copper or aluminum	1

Battpac® LT BPLT54BSCT Fast-Cycle, Battery-Powered Cutting Tool



..... Specifications

- Max. Cutting Capacity: 2½" O.D. Aluminum; 750 kcmil Copper
- Recommended Cutting Range for Consistent Use: 250 kcmil
- Batteries: 6.0V
- Weight with battery: 4.8 lbs.

CAT. NO.	DESCRIPTION	PKG. QTY.
BPLT54BSCT	Battpac® LT Fast-Cycle Cutting Tool. Includes carrying case, charger, two batteries, carry strap	1

Battpac® TBM54BSCT and TBM54BSCTS Battery-Powered Cutters

- Removable battery — simply change for continuous use
- One-handed control of blade advancement and retraction
- TBM54BSCTS cuts up to 750 kcmil copper, 2½" O.D. aluminum and 636 kcmil ACSR
- TBM54BSCT cuts up to 1,500 kcmil copper and 2½" O.D. aluminum (not for use on ACSR)

Guide to Cutting Cycles

This guide indicates the number of cutting cycles that the TBM54BSCT and TBM54BSCTS can be expected to perform when the battery is fully charged. These figures are approximate and will vary according to the charging and other operating conditions, such as temperature, humidity and battery condition.

CAT. NO.	CONDUCTOR	APPROX. CUTTING CYCLES	
		CRCTBPI & CRCTBP	CRCTPBEI
TBM54BSCTS	750 kcmil Cu	35	105
	636 kcmil ACSR	50	150
TBM54BSCT	1,000 kcmil Cu	45	135
	1,500 kcmil Cu; 2½" Al	30	90

Battery Cartridge: (CRCTBP)

Battery Type: Sealed Nickel Cadmium

Voltage: 14.4V DC

Rated Current: 1.9Ah

Dimensions: 3.5"L x 2.7"W x 5.3"H

Weight: 1.6 lbs.

Battery Charger: (CRCTQC)

Input Voltage: 120V AC Single Phase

Charging Capacity: 20 VA

Charging Time: 15 min. CRCTBP & CRCTBPI
45 min. CRCTPBEI

Dimensions: 7.5"L x 3.7"W x 3.5"H

Weight: 4 lbs.

Optional Accessories:

Battery Pack: CRCTBPEI

Battery Cartridge: CRCTBPI or CRCTBP

DC Charger: CRCTDC

..... Specifications

- Motor: 14.4V DC
- Dimensions (L x W x H): 16" x 4" x 4.5"
- Weight with Battery: 7.2 lbs.



CAT. NO.	DESCRIPTION	PKG. QTY.
TBM54BSCTS	Battery-powered cutter for up to 750 kcmil Cu, 2½" O.D. Al and 636 kcmil ACSR	1
TBM54BSCT	Battery-powered cutter for up to 1,500 kcmil Cu, 2½" O.D. Al (not for use on ACSR)	1

Color-Keyed® Compression

Strippers, Cutters and Other Tools

Battpac® TBM58BSCT Battery-Powered Cutter

- Designed for one-handed operation
- Simply remove pin latch, place over cable, reinsert pin and cut
- Built-in bypass pops off if material is beyond cutter's capacity
- Cuts ACSR, aluminum and copper cables up to 1½", regular guy wires and ground rods up to ¾"

NOTE: Not recommended for use on hardened steel.

Standard Battpac® Kit Includes:

- 1 battery-powered tool
- 1 carrying strap
- 1 carrying case
- 2 CRCTBP batteries
- 1 CRCTQC 15-minute AC charger



Specifications

- Output Pressure: 6 tons
- Max Cutting Capacity: Soft steel bolts: 1⅞" (17mm)
Rebar & ground rod: ¾" (16mm) ACSR : 1½" (40mm)
CU & AL strands: 1½" (40mm) Standard guy wire:
¾" (16mm) Wire rope: ¾" (20mm)
- Dimensions (H x W x D): 17" x 12" x 3"
- Weight with Battery: 14 lbs.

CAT. NO.	DESCRIPTION	PKG. QTY.
TBM58BSCT	Battery-Powered Cutter	1

297-32136 Hydraulic Cutting Head

- Heavy-duty cutter with high strength steel blades
- Cuts both aluminum and copper wire to 1½" O.D.
- Cutter supplied with carrying case



Specifications

- Max. Cutting Capacity (aluminum and copper): 1½" O.D.
- Dimensions (L x W x H): 14½ x 2½ x 4"
- Weight: 8.5 lbs.

CAT. NO.	DESCRIPTION	PKG. QTY.
297-32136	Hydraulic Cutting Head	1

Battpac® LT BPLT58BSCT Battery-Powered Cutter

- Cuts copper, aluminum and ACSR up to 1½" O.D.
- Also cuts soft steel bolts, rebar and wire rope
- Forged steel head and cutting blades for strength and durability
- Dual forward speeds enhance productivity
- New, more powerful Ni-MH battery has 50% more energy and less memory effect than old batteries



Specifications

- Max. Cutting Capacity: Copper, aluminum & ACSR cable to 1½" O.D.
Rebar, ground rod & standard guy wire to ¾"
Wire rope to ¾"
- Dimensions (L x W x H): 19½" x 3⅞" x 9⅞"
- Battery: Ni-MH 14.4V 3.0Ah
- Weight with Battery: 16.7 lbs.

CAT. NO.	DESCRIPTION	PKG. QTY.
BPLT58BSCT	Battery-Powered Cutter with carrying case, charger, two batteries and carry strap.	1

TBM40HCRH Hydraulic Cutting Head

- Heat-treated, high-strength steel blades for clean cuts and long service life
- Quick automatic coupler speeds connection to hydraulic systems
- Comes with carrying case



Specifications

- Max. Cutting Capacity (copper, aluminum and telecommunications cable): Up to 3.35" O.D.*
- Hydraulic Operating Pressure: 10,000 psi (maximum)
- Dimensions (L x W): 15.94" x 5.63"
- Weight: 10.8 lbs.

* Not designed for cutting steel-reinforced conductors

CAT. NO.	DESCRIPTION	PKG. QTY.
TBM40HCRH	Hydraulic Cutting Head	1

Strippers, Cutters and Other Tools

Blackburn® JB12B 12-Ton Manual Hydraulic Crimp Tool

- Self-contained hydraulic crimping tool for copper, aluminum and ASCR connectors
- Two-stage, rapid-ram advance mechanism for fast installation
- 180° head rotation
- Accepts all U-type dies used for Alcoa®, Burndy®, Thomas & Betts® and Blackburn® tools of equivalent tonnage

Specifications

- Installing Range:
 - Up to 750 mcm copper lugs & splices
 - Up to 650 mcm aluminum lugs & splices
 - CHT814-10 to CHT2502-6 copper H-taps
 - 63105 to 63148 aluminum H-taps
 - 54755 to 54770 C-taps
- Output Force: 12 tons
- Dimensions (L x W x H): 22¾" x 2½" x 4¾"
- Weight without Dies: 13 lbs.



Creates Hex-style crimp

CAT. NO.	DESCRIPTION	PKG. QTY.
JB12B	12-Ton Manual Hydraulic Crimp Tool with Carrying Case	1

Blackburn® OD581 Mechanical Compression Tool

- Equipped with fixed 5/8" die in nose
- Also accepts standard insert "O," "D" and 840 dies
- Integral self-gauging system in tool head ensures proper adjustment before each crimp
- Improved lever-action design reduces force required to crimp by as much as 20%
- Fiberglass handles offer light weight, high strength and superior insulating properties
- Distribution of weight over tool length enhances balance for easier handling and positioning



CAT. NO.	DESCRIPTION	PKG. QTY.
OD581	Mechanical Compression Tool with Fixed 5/8" Nose Die, Insert Die Cavity for "O," "D" or 840 Die (sold separately) and 21" Fiberglass Handles	1

Blackburn® TBMODBSCR 6-Ton Battery-Powered Compression Tool

- Versatile battery-powered crimp tool combines the features of an open-yoke tool with the weight and balance of a closed-yoke tool
- Reduces stress for operator when crimping connectors
- Ideal for industrial, commercial, telecom and utility applications
- Accepts T&B® 6-TON and Blackburn® "O" and "D" dies*



Specifications

- Installing Range:
 - Up to 4/0 aluminum H-taps
 - Standard C-taps
- Output Force: 6 tons
- Dimensions (L x W x H): 12" x 3" x 13"
- Battery: Ni-MH 14.4V 3.0 Ah
- Weight with Battery: 8 lbs.

CAT. NO.	DESCRIPTION	PKG. QTY.
TBMODBSCR	Battery-Powered 6-TON Crimping Tool — Includes Shoulder Strap, Charger, Carrying Case, Battery Cartridge and Owners Manuals	1

*T&B® 6-TON and Blackburn® "O" and "D" dies sold separately.

Color-Keyed® Compression

Strippers, Cutters and Other Tools; Seals and Lubricants

Cable Slicing Die Sets

- Cuts copper and aluminum insulated cable sizes from #8 AWG through 500 kcmil
- Produces clean, squared-end cut, which eliminates extra trimming of conductor strands

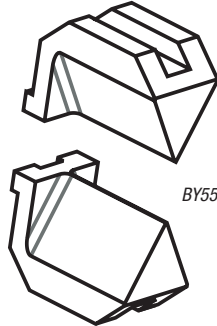

CAT. NO.	MAXIMUM CABLE SIZE	TOOLS	PKG. QTY.
BY55	2/0	TBM6H and TBM6BSCR	1
40C	4/0	TBM14M and 13100A and TBM14BSCR	1
156CS	500 kcmil	TBM15I and TBM15BSCR	1

Type DX Duct Seal

- Seals around junction boxes, flashings, service mast entries, service cable entries and countless other applications
- Easy to use — forms around irregular surfaces and configurations
- Highly resistant to cracking, drying and shrinking
- Cuts and trims easily
- Gray color can be left as is or painted immediately after application
- No unpleasant odor
- +20° F to 212° F workable temperature range
- 40° F to 250° F service temperature range
- Contains no asbestos



CAT. NO.	DESCRIPTION	PKG. QTY.
DX-1	1 lb. Slug	1
DX-5	5 – 1 lb. Slugs	1
DX-5S	5 lb. Slug	1

UL Classified R13335

21649 Cable Bender



CAT. NO.	DESCRIPTION	PKG. QTY.
21649	Bender for cable up to 750 kcmil	1

CTR-1 C-Tap Removal Tool



CAT. NO.	DESCRIPTION	PKG. QTY.
CTR-1	C-Tap Removal Tool	1

Type WW Wire Bristle Brush

- Removes oxides from conductor surfaces
- Easy-grip handle with guard to prevent rubber-glove puncture
- Replaceable long-life brushes can be rotated
- Handle and guard coated with durable, nonconductive plastic for safety



CAT. NO.	DESCRIPTION	PKG. QTY.
WWB1	Complete Brush with Handle	1
WRB1	Wire Element Only, Pair	1

Silicone Lubricant for High Voltage Electrical Work



CAT. NO.	DESCRIPTION	PKG. QTY.
2012	2 grams	250 tubes
2015	5 grams	100 tubes
SL5	5 oz./142 grams	12 tubes

Dies for Standard Lugs & Splices (TBM25S – TBM12)

CONNECTOR SIZE			COLOR-KEYED DIE COLOR	TBM8-750M-1 TBM8-750BSCR			TBM-8/8S	TBM-5/5S	TBM6/6S / 25000		13642M / 13400 HYDRAULIC HEAD		TBM12 HYDRAULIC HEAD	
CODE COPPER	FLEX/24	AL/CU		TBM25S	TBM4S	TBM8-750	TBM8 DIE CAT. NO.	TBM5 DIE CAT. NO.	CAT. NO. UPPER DIE	CAT. NO. LOWER DIE	DIE CAT. NO.	DIE CODE NO.	DIE CAT. NO.	DIE CODE NO.
8 AWG	37/24	10 AWG	RED	C-Taps Only				13475	13477	11732	21	TBM12D-1	21	
6 AWG	61/24	8 AWG	BLUE					13475	13477	11733	24	TBM12D-1	24	
4 AWG	91/24	6 AWG	GRAY					13472	13476	11734	29	TBM12D-2	29	
2 AWG	125/24		BROWN					13474	13477	11735	33	TBM12D-2	33	
1 AWG	150/24	4 AWG	GREEN					13474	13477	11736	37	TBM12D-3	37	
1/0	225/24	2 AWG	PINK					13475	13477	11737	42	TBM12D-3	42	
2/0	275/24		BLACK					13474	13477	11738	45	TBM12D-4	45	
3/0	325/24		ORANGE					13474	13477	11739	50	TBM12D-4	50	
4/0	450/24		PURPLE					13475	13477	11740	54	TBM12D-5	54	
250 kcmil	550/24		YELLOW					13473	13476	11771	62	TBM12D-5	62	
		1 AWG	GOLD					13474	13477	11738	45	TBM12D-4	45	
		1/0	TAN					13474	13477	11739	50	TBM12D-4	50	
		2/0	OLIVE					13475	13477	11740	54	TBM12D-5	54	
		3/0	RUBY					13473	13476	11741	60	TBM12D-5	60	
300 kcmil		4/0	WHITE					13465		11742	66H	TBM12D-5	66H	
350 kcmil	775/24(short)	250 kcmil	RED					13466		11743	71H	TBM12D-4	71H	
400 kcmil	775/24(long)	300 kcmil	BLUE					13467	4/0 only	11744	76H	TBM12D-4	76H	
	925/24*		N/A							11745	80H			
			N/A											
500 kcmil		350 kcmil	BROWN					13468		11746-TB	87H	TBM12D-3	87H	
600 kcmil	1100/24	400 kcmil	GREEN			11747	94H	TBM12D-3	94H					
			GREEN						94H					
	1325/24**		PINK											
700 kcmil		500 kcmil	PINK			11748	99H	TBM12D-2	99H					
750 kcmil		650 kcmil	BLACK			11749	106H	TBM12D-2	106H					
800 kcmil			ORANGE			11750	107H							
		700 kcmil	PURPLE			11751	112H	TBM12D-1	112H					
900 kcmil	1925/25	750 kcmil	YELLOW			11753	115H	TBM12D-1	115H					
1000 kcmil		800 kcmil												
		1000 kcmil												

* Standard barrel only. Long barrel requires Brown 87H.

** Standard barrel only. Long barrel requires Black 106H.

Dies for Standard Lugs & Splices (OD58)

CONNECTOR SIZE			COLOR-KEYED DIE COLOR	OD58	
CODE COPPER	FLEX/24	AL/CU		DIE CAT. NO.	DIE CODE NO.
8 AWG	37/24	10 AWG	RED	BY15C	21
6 AWG	61/24	8 AWG	BLUE	BY17C	24
4 AWG	91/24	6 AWG	GRAY	BY19C	29
2 AWG	125/24		BROWN	BY21C	33
1 AWG	150/24	4 AWG	GREEN	BY53C	37
1/0	225/24	2 AWG	PINK	BY23C	42
2/0	275/24		BLACK	BY28C	45
3/0	325/24		ORANGE	BY25C	50
4/0	450/24		PURPLE	BY27C	54
250 kcmil	550/24		YELLOW	BY31C	62
		1 AWG	GOLD	BY24C	45
		1/0	TAN	BY25C	50
		2/0	OLIVE	BY31C	54
		3/0	RUBY	BY32C	60

Color-Keyed Compression

Installing Dies

Dies for Standard Lugs & Splices (TBM6H – 21940)

Color-Keyed Compression

CONNECTOR SIZE			COLOR-KEYED DIE COLOR	BPLT6BSCR / TBM6H		BPLT62BSCR		BPLT14BSCR / TBM14M / TBM14MC / 13100A* / JB12B		BPLT15BSCR / TBM15I***		21940 (40 TON)	
CODE COPPER	FLEX/24	AL/CU		DIE CAT. NO.	DIE CODE NO.	DIE CAT. NO.	DIE CODE NO.	DIE CAT. NO.	DIE CODE NO.	DIE CAT. NO.	DIE CODE NO.	DIE CAT. NO.	DIE CODE NO.
8 AWG	37/24	10 AWG	RED	6TON21	21	TBM6221	21	15520	21	15520	21		
6 AWG	61/24	8 AWG	BLUE	6TON24	24	TBM6224	24	15522	24	15522	24		
4 AWG	91/24	6 AWG	GRAY	6TON29	29	TBM6229	29	15527-CK	29	15527-CK	29	11401	29
2 AWG	125/24		BROWN	6TON33	33	TBM6233	33	15528	33	15528	33	11402	33
1 AWG	140/24	4 AWG	GREEN	6TON37	37	TBM6237	37	15513-CK	37	15513-CK	37	11333	37
1/0	225/24	2 AWG	PINK	6TON42	42	TBM6242	42	15508	42	15508	42H	11334	42
2/0	275/24		BLACK	6TON45	45	TBM6245	45	15526	45	15526	45	11405	45
3/0	325/24		ORANGE	6TON50	50	TBM6250	50	15530	50	15530	50	11406	50
4/0	450/24		PURPLE	6TON54	54	TBM6254	54	15511	54	15511	54H	11407	54H
250 kcmil	550/24		YELLOW	6TON62	62	TBM6262	62	15510-CK	62	15510-CK	62	297-31669-7	62
		1 AWG	GOLD	6TON45	45	TBM6245	45	15526	45	15526	45	11405	45
		1/0	TAN	6TON50	50	TBM6250	50	15530	50	15530	50	11406	50
		2/0	OLIVE	6TON54	54	TBM6254	54	15511	54	15511	54H	11407	54
		3/0	RUBY	6TON60	60	TBM6260	60	15532-CK	60	15532-CK	60	11408	60
300 kcmil		4/0	WHITE	6TON66	66H	TBM6266	66	15534	66H	15534	66H	11409	66
350 kcmil	775/24(short)	250 kcmil	RED	6TON71	71H	TBM6271	71	15514-CK	71H	15514-CK	71H	11363	71
400 kcmil	775/24(long) 925/24*	300 kcmil	BLUE	6TON76	76H	TBM6276	76	15512	76H	15512	76H	11410	76
				6TON80	80H	TBM6280	80	15517	80H	15517	80H		
										15606	80		
500 kcmil		350 kcmil	BROWN	6TON87	87H	TBM6287	87	15506	87H	15506	87H	11423	87
600 kcmil	1100/24	400 kcmil	GREEN	6TON94	94H					15611	94H	11364	94
			GREEN					15536-CK	94H	15536-CK	94H		
	1325/24**		PINK										
700 kcmil		500 kcmil	PINK		99H			15505	99H	15505	99H	11424	99
750 kcmil		650 kcmil	BLACK		106H			15515-CK	106H	15515-CK	106H	74506	106
800 kcmil			ORANGE		107H					15608	107H	11425	107
			PURPLE		112H					15609	112H	11426	112
900 kcmil	1925/24	700 kcmil	YELLOW		115H			15504	115H	15504	115H	11308	115
1000 kcmil		750 kcmil	N/A							15603	125H	11416	125
		800 kcmil	N/A							15602	140H	11418	140
		1000 kcmil								15601	150H	11419	150

*Standard barrel only. Long barrel requires Brown 87H.

**Standard barrel only. Long barrel requires Black 106H.

***15500 Series dies require 15500-TB adapter. 15500F for full size die to fit TBM15I without adapter.

Dies for Standard C-Taps

CONNECTOR	COLOR CODE	TBM25S DIE NO.	TBM5/5S DIE NO.	TBM6/6S DIE NO.	TBM8/8S DIE NO.	BPLT62BSCR DIE NO.	TBM6H/BPLT6BSCR DIE NO.
54705	RED	Red Nest	13454	13475/13477	13461	TBM6221	6TON21
54710	BLUE	Blue Nest	13454	13475/13477	13461	TBM6224	6TON24
54715	GRAY	Grey Nest	13454	13472/13476	13461	TBM6229	6TON29
54720	BROWN	Brown Nest	13454	13474/13477	13461	TBM6233	6TON33
54725	GREEN	Green Nest	13455	13474/13477	13462	TBM6237	6TON37
54730	PINK	—	13455	13475/13477	13462	TBM6242	6TON42
54735	BLACK	—	13455	13474/13477	13462	TBM6245	6TON45
54740	ORANGE	—	13455	13474/13477	13462	TBM6250	6TON50
54745	PURPLE	—	13456	13475/13477	13463	TBM6254	6TON54
54750	YELLOW	—	13456	13473/13478	13463	TBM6262	6TON62

Installing Dies

Dies for Large C-Taps

CONNECTOR	COLOR CODE	13642M/13400 DIE NO.	TBM12 DIE NO.	13100A/JB12B/TBM14M/ BPLT14BSCR DIE NO.	TBM15/ BPLT15BSCR DIE NO.
54755	BLUE	11744	TBM12D-4	15512	15512
54760	BROWN	11746-TB	TBM12D-3	15506	15506
54765	PINK	11748	TBM12D-2	15505	15505
54770	BLACK	11749	TBM12D-2	15515-CK	15515-CK
54775	YELLOW	11753	TBM12D-1	15504	15504
54780	WHITE	—	—	—	15603
54785	N/A	—	—	—	15603
54790	N/A	—	—	—	15603

Dies for Aluminum H-Taps

CONNECTOR	COLOR CODE	TBM5/5S DIE NO.	TBM6/6S DIE NO.	TBM8/8S DIE NO.	TBM12 DIE NO.	TBM6H/BPLT6BSCR DIE NO.	13100A/JB12B/TBM14M/ BPLT14BSCR DIE NO.	TBM15/ BPLT15BSCR DIE NO.
63105	ORANGE	13455	13474/13477	13462	TBM12D-4	6TON50	15530	15530
63110	GREEN	—	13470	—	TBM12D-H	OJB	15501A	15501A
63118	GREEN	—	13470	—	TBM12D-H	OJB	15501A	15501A
63125	GREEN	—	13470	—	TBM12D-H	OJB	15501A	15501A
63140	BLUE	—	13471	—	TBM12D-H	DBL	15502	15502
63148	BLUE	—	13471	—	TBM12D-H	DBL	15502	15502
63160	RED	—	—	—	—	—	—	15612
63169	BLACK	—	—	—	—	—	—	15620
63170	BLACK	—	—	—	—	—	—	15620
63180	BLACK	—	—	—	—	—	—	15620

Dies for Copper H-Taps

CONNECTOR	COLOR CODE	TBM6H/BPLT6BSCR DIE NO.	13100A/JB12B/TBM14M/ BPLT14BSCR DIE NO.	TBM15/ BPLT15BSCR DIE NO.
CHT814-10	GREEN	6TON37R	15CA37RCH	15CA37RCH
CHT214-9	BROWN	6TON71R	15CA71RCH	15CA71RCH
CHT250214-8	PURPLE	—	15CA80RCH	15CA80RCH
CHT25014-7	PURPLE	—	15CA80RCH	15CA80RCH
CHT2502-6	PURPLE	—	15CA80RCH	15CA80RCH
CHT50010-5	BROWN	—	—	15612CH
CHT50040-4	BROWN	—	—	15612CH
CHT75010-3	YELLOW	—	—	15620CH
CHT750350-2	YELLOW	—	—	15620CH
CHT75040-11	YELLOW	—	—	15620CH
CHT750350-1F	WHITE	—	—	15620CHF

Dies for High-Voltage Connectors

DIE CODE NO.	TBM15I, TBM14M, 13100A	
	ADAPTER TYPE	NON-ADAPTER TYPE
29R	15CA29R	—
33R	15CA33R	—
37R	15CA37R	—
42R	15CA42R	—
45R	15CA45R	—
49R	15CA49R	—
54R	15CA54R	—
60R	15CA60R	—
66R	15CA66R	—
71R	15CA71R	—
76R	15CA76R	—
87R	15CA87R	—
94R	15CA94R [†]	—
106R	15CA106R [†]	—
125R	—	15C125R*

*To be used with TBM15I only.

**Use 15500-TB adapter with TBM15I tool.

†Not UL Listed in TBM14M/13100A tool.

Dies for Figure 6 & Figure 8 Ground Connectors

CONNECTOR	CABLE ELEMENT A	TO CABLE ELEMENT B	TO GROUND ROD ELEMENT B	TO REBAR ELEMENT B	DIE SELECTION	
					ELEMENT A	ELEMENT B
54855L	#6 Sol. - #2 Str.	#6 Sol. - #2 Str.	—	—	15501A	15501A
54865L	#1 Str. - 250 kcmil	#6 Sol. - #2 Str.	½" - ⅝" Rod	⅝" - ½" #3 - #4 Rebar	15G86R	15501A
54875L	#2 Str. - 250 kcmil	#2 Str. - 250 kcmil	½" - ⅝" Rod	⅝" - ½" #3 - #4 Rebar	15G86R	15G86R
54885L	250 kcmil - 500 kcmil	#6 Sol. - #2 Str.	⅝" - ¾" Rod	⅝" - ¾" #3 - #4 Rebar	15G126R	15501A
54895L	250 kcmil - 500 kcmil	#2 Str. - 250 kcmil	⅝" - ¾" Rod	⅝" - ¾" #3 - #4 Rebar	15G126R	15G86R
54900L	250 kcmil - 500 kcmil	#2 Str. - 250 kcmil	⅝" - ¾" Rod	⅝" - ¾" #3 - #4 Rebar	15G121R	15G121R

United States
Tel: 901.252.8000
800.816.7809
Fax: 901.252.1354

Canada
Tel: 450.347.5318
Fax: 450.347.1976

Technical Services
Tel: 888.862.3289

Thomas & Betts

www.tnb.com

Connectors for Copper Conductor

One-Hole Metric Lugs

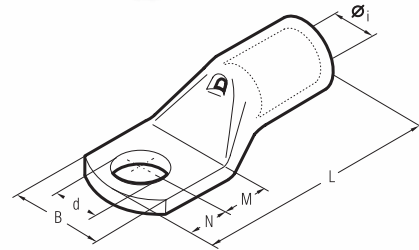

Color-Keyed® metric lugs are manufactured from electrolytic copper tube. The dimensions of the tube are designed to obtain the most efficient electrical conductivity and mechanical strength, resisting vibration and pull out.

Color-Keyed® metric lugs are annealed to guarantee optimum ductility, which is a necessity for compression connectors having to withstand severe deformation arising when compressed or bending of the tongue that may happen during installation.

Connectors have to perform adequately with vibration loads, and annealing is necessary to avoid material failure between the barrel and the tongue.

The presence of an inspection hole facilitates full insertion of the conductor, and the barrel length is designed to allow easy and accurate positioning of the dies during the crimping operation.

Lugs are electrolytically tin-plated to eliminate oxidation of the copper material. Color-Keyed® metric lugs complement our connector family and meet a growing need for customer's connector requirements. Details of the appropriate crimping tools and dies are included. Our Technical Services group is always available to provide any technical advice required. Please contact them if sizes are needed additional to those shown in this catalog.

Color-Keyed® Compression

CAT. NO.	COND. SIZE		Ø STUD MM	DIMENSIONS (MM)					STD. PKG.	6 TON TBM62BSCR (CRIMPS)	14 TON BPLT14BScri (CRIMPS)	26 TON TBM26MCC (CRIMPS)	60 TON TBM60MCC (CRIMPS)
	LOW STRANDED	FLEXIBLE		Ø1	B	M	N	L					
MCC6M4			4	3,6	8,0	5,0	4,0	21,5	4,3	100			
MCC6M5		4÷6	5	3,6	9,0	6,5	6,0	25,0	5,3	100			
MCC6M6			6	3,6	11,0	7,0	6,0	25,5	6,4	100			
MCC10M4			4	4,6	10,0	5,0	4,0	22,5	4,3	100			
MCC10M5*			5	4,6	10,0	6,5	6,0	26,0	5,3	100			
MCC10M6*		10	6	4,6	11,0	7,0	6,0	26,5	6,4	100	MCD10-6 (1)	MCD10-14 (1)	N/A
MCC10M8*			8	4,6	15,0	9,0	8,0	30,5	8,4	100			
MCC10M10*			10	4,6	18,0	11,0	10,0	34,5	10,5	100			
MCC16M4*			4	5,8	11,5	5,0	4,0	25,5	4,3	100			
MCC16M5*			5	5,8	11,5	6,5	6,0	29,0	5,3	100			
MCC16M6*		16	6	5,8	11,5	7,0	6,0	29,5	6,4	100	MCD16-6 (1)	MCD16-14 (1)	N/A
MCC16M8*			8	5,8	15,0	9,0	8,0	33,5	8,4	100			
MCC16M10*			10	5,8	18,0	11,0	10,0	37,5	10,5	100			
MCC25M5*			5	7,0	14,0	6,5	6,0	31,5	5,3	100			
MCC25M6*		25	6	7,0	14,0	7,0	6,0	32,0	6,4	100	MCD25-6 (1)	MCD25-14 (1)	N/A
MCC25M8*			8	7,0	15,0	9,0	8,0	36,0	8,4	100			
MCC25M10*			10	7,0	18,0	11,0	10,0	40,0	10,5	100			
MCC35M5*			5	8,9	17,0	6,5	6,0	34,0	5,3	100			
MCC35M6*		25	6	8,9	17,0	7,0	6,0	34,5	6,4	100			
MCC35M8*	35	35	8	8,9	17,0	9,0	8,0	38,5	8,4	100	MCD35-6 (1)	MCD35-14 (1)	N/A
MCC35M10*			10	8,9	19,0	11,0	10,0	42,5	10,5	100			
MCC35M12*			12	8,9	21,0	14,0	12,0	47,5	13,2	50			
MCC50M8*		35	8	10,0	19,0	9,0	8,0	42,5	8,4	50			
MCC50M10*	50	50	10	10,0	20,0	11,0	10,0	46,5	10,5	50	MCD50-6 (2)	MCD50-14 (1)	N/A
MCC50M12*			12	10,0	21,0	14,0	12,0	51,5	13,2	50			
MCC70M6*			6	11,3	21,0	8,0	7,0	44,0	6,4	50			
MCC70M8*		50	8	11,3	21,0	9,0	8,0	46,0	8,4	50			
MCC70M10*	70	70	10	11,3	21,0	11,0	10,0	50,0	10,5	50	MCD70-6 (2)	MCD70-14 (1)	N/A
MCC70M12*			12	11,3	22,0	14,0	12,0	55,0	13,2	50			
MCC70M16*			16	11,3	26,0	18,0	16,0	63,0	17,0	50			
MCC95M8*		70	8	13,5	25,0	9,0	8,0	52,5	8,4	25			
MCC95M10*	95	95	10	13,5	25,0	11,0	10,0	56,5	10,5	25	MCD95-6 (2)	MCD95-14 (1)	N/A
MCC95M12*			12	13,5	25,0	14,0	12,0	61,5	13,2	25			

Connectors for Copper Conductor

One-Hole Metric Lugs (continued)

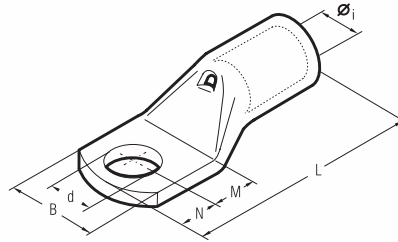

Color-Keyed Compression

CAT. NO.	COND. SIZE		Ø STUD MM	DIMENSIONS (MM)						STD. PKG.	6 TON TBM62BSCR (CRIMPS)	14 TON BPLT14BSERI (CRIMPS)	26 TON TBM26MCC (CRIMPS)	60 TON TBM60MCC (CRIMPS)
	LOW STRANDED	FLEXIBLE		ØI	B	M	N	L	D					
MCC120M6			8	—	—	—	—	—	6.4	25				
MCC120M8*			8	15,2	28,5	9,0	8,0	54,0	8,4	25				
MCC120M10*	120	95	10	15,2	28,5	11,0	10,0	58,0	10,5	25	MCD120-6 (2)	MCD120-14 (1)	N/A	
MCC120M12*		120	12	15,2	28,5	14,0	12,0	63,0	13,2	25				
MCC120M16*			16	15,2	28,5	18,0	16,0	71,0	17,0	25				
MCC150M12*	150	120	12	16,7	31,5	16,0	14,0	75,0	13,2	25	MCD150-6 (3)	MCD150-14 (1)	N/A	
MCC150M16*		150	16	16,7	31,5	19,0	17,0	81,0	17,0	25				
MCC185M10*	185	150	10	19,2	35,5	13,0	11,0	76,0	10,5	25	MCD185-6 (3)	MCD185-14 (1)	N/A	
MCC185M12*		185	12	19,2	35,5	16,0	14,0	82,0	13,2	25				
MCC185M16*		185	16	19,2	35,5	19,0	17,0	88,0	17,0	15				
MCC240M10*	240	185	10	21,1	39,0	13,0	11,0	82,0	10,5	15	MCD240-6 (3)	MCD240-14 (2)	N/A	
MCC240M12*		240	12	21,1	39,0	16,0	14,0	88,0	13,2	15				
MCC240M16*		240	16	21,1	39,0	19,0	17,0	94,0	17,0	15				
MCC300M10*	300	240	10	23,7	44,0	20,0	11,0	96,0	10,5	10	N/A	MCD300-14 (3)	N/A	
MCC300M12*		300	12	23,7	44,0	20,0	14,0	99,0	13,2	10				
MCC300M16*		300	16	23,7	44,0	22,0	19,0	10,0	17,0	10				
MCC400M10	400	300	12	27,0	51,0	22,0	19,0	113,0	13,2	5	N/A	MCD400-14 (3)	MCD400-26 (2)	MCD400-60 (2)
MCC400M12			12	27,0	51,0	22,0	19,0	113,0	13,2	5				
MCC400M16			16	27,0	51,0	22,0	19,0	113,0	17,0	5				
MCC500M10	500	400	16						13,2	5	N/A	N/A	MCD500-26 (2)	MCD500-60 (2)
MCC500M12			16						17,0	5				
MCC500M16			16	30,3	56,5	22,0	19,0	117,0	17,0	5				
MCC630M16	630	500	16	33,4	61,6	22,0	19,0	128,0	17,0	6	N/A	N/A	MCD630-26 (2)	MCD630-60 (2)
MCC630M20			20	33,4	61,6	24,0	23,0	134,0	21,0	6				
MCC800M16	800	630	16	38,0	72,0	24,0	19,0	141,0	17,0	3	N/A	N/A	N/A	MCD800-60 (2)
MCC800M20			20	38,0	72,0	24,0	23,0	145,0	21,0	3				
MCC1000M16	1000	800	16	44,0	80,0	24,0	19,0	158,0	17,0	2	N/A	N/A	N/A	MCD1000-60 (2)
MCC1000M20			20	44,0	80,0	24,0	23,0	162,0	21,0	2				

*UL Listed

Connectors for Copper Conductor

Narrow Tongue Metric Lugs



Color-Keyed® narrow tongue metric lugs feature a contained tongue width. Our lugs have been specifically developed for applications with L.V. circuit breakers with reduced space requirements. The tongue width allows a quicker and easier installation. Color-Keyed® narrow tongue metric lugs are manufactured from electrolytic copper tube. The specific design of the barrel and dimensions create the best combination of mechanical strength and electrical conductivity. Color-Keyed® narrow tongue metric lugs are annealed to guarantee optimum ductility and are electrolytically tinplated to avoid oxidation. The barrel is provided with an internal chamfer for easy insertion of the conductor. The length allows easy positioning of the dies for proper crimping.

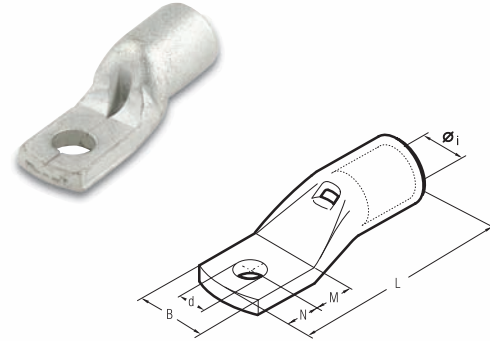

Color-Keyed® Compression

CAT. NO.	COND.SIZE FLEXIBLE SQMM	Ø STUD MM	DIMENSIONS (MM)						STD. PKG.	6 TON TBM62BSCR (CRIMPS)	14 TON BPLT14BSCRI (CRIMPS)
			Ø1	B	M	N	L	D			
MCCNT10M5	10	5	4,6	9,0	6,5	6,0	26,0	5,3	100	MCD10-6 (1)	MCD10-14 (1)
MCCNT16M5	16	5	5,8	9,0	6,5	6,0	29,0	5,3	100	MCD16-6 (1)	MCD16-14 (1)
MCCNT25M5	25	5	7,0	9,0	6,5	6,0	31,5	5,3	100	MCD25-6 (1)	MCD25-14 (1)
MCCNT35M6	35	6	8,9	11,5	8,0	7,0	36,5	6,4	100	MCD36-6 (1)	MCD35-14 (1)
MCCNT50M6	50	6	10,0	11,5	8,0	7,0	40,5	6,4	50	MCD50-6 (2)	MCD50-14 (1)
MCCNT70M6	70	6	11,3	11,5	8,0	7,0	44,0	6,4	50	MCD70-6 (2)	MCD70-14 (1)
MCCNT95M8	95	8	13,5	15,5	9,0	8,0	52,5	8,	25	MCD95-6 (2)	MCD95-14 (1)
MCCNT120M8	120	8	15,2	19,0	14,0	9,0	60,0	8,4	25	MCD120-6 (2)	MCD120-14 (1)
MCCNT120M10		10	15,2	19,0	14,0	9,0	60,0	10,5	25	MCD120-6 (2)	MCD120-14 (1)
MCCNT150M8	150	8	16,7	19,0	18,0	9,0	70,0	8,4	25	MCD150-6 (3)	MCD150-14 (1)
MCCNT150M10		10	16,7	19,0	18,0	9,0	70,0	10,5	25	MCD150-6 (3)	MCD150-14 (1)
MCCNT185M10	185	10	19,2	24,5	18,0	9,0	77,0	10,5	25	MCD185-6 (3)	MCD185-14 (1)
MCCNT240M10	240	10	21,1	31,0	13,0	9,0	80,0	10,5	15	MCD240-6 (3)	MCD240-14 (2)
MCCNT240M12		12	21,1	31,0	16,0	12,0	86,0	13,2	15	MCD240-6 (3)	MCD240-14 (2)
MCCNT240M16		16	21,1	31,0	19,0	17,0	94,0	17,0	15	MCD240-6 (3)	MCD240-14 (2)
MCCNT300M12	300	12	23,7	31,0	16,0	12,0	95,0	13,2	10	NA	MCD300-14 (3)

Connectors for Copper Conductor

Two-Way Metric Splice Connectors

Color-Keyed® metric splice connectors are designed for joining low voltage conductors.

Made of electrolytic copper tube having similar dimensions to the Color-Keyed® metric lugs, these connectors are also annealed and electrolytically tin plated.

They feature an internal chamfer at both ends. For easy insertion of the conductor, a center stop is provided to ensure correct positioning.

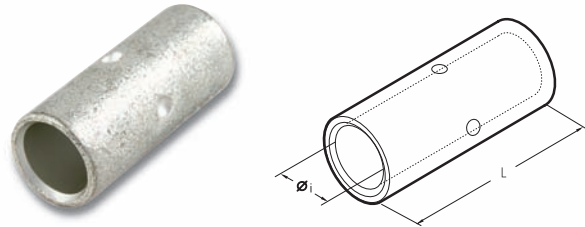

CAT. NO.	COND. SIZE		DIMENSIONS (MM)		STD. PKG.	6 TON TBM62BSCR (CRIMPS)	14 TON BPLT14BSCRI (CRIMPS)	26 TON TBM26MCC (CRIMPS)	60 TON TBM60MCC (CRIMPS)
	LOW STRANDED	FLEXIBLE	Ø1	L					
MCST1	0.25÷1.5	0.25÷1.5	1,8	15	100	N/A	N/A	N/A	N/A
MCST2	1.5÷2.5	1.5÷2.5	2,4	15	100	N/A	N/A	N/A	N/A
MCST6	4÷6	4÷6	3,6	22	100	MCD6-6 (1 + 1)	N/A	N/A	N/A
MCST10	10	10	4,6	25	100	MCD10-6 (1 + 1)	MCD10-14 (1 + 1)	N/A	N/A
MCST16	16	16	5,8	27	100	MCD16-6 (1 + 1)	MCD16-14 (1 + 1)	N/A	N/A
MCST25	25	25	7,0	29	100	MCD25-6 (1 + 1)	MCD25-14 (1 + 1)	N/A	N/A
MCST35	35	25÷35	8,9	33	100	MCD35-6 (1 + 1)	MCD35-14 (1 + 1)	N/A	N/A
MCST50	50	35÷50	10,0	37	50	MCD50-6 (2 + 2)	MCD50-14 (1 + 1)	N/A	N/A
MCST70	70	50÷70	11,3	39	50	MCD70-6 (2 + 2)	MCD70-14 (1 + 1)	N/A	N/A
MCST95	95	70÷95	13,5	43	25	MCD95-6 (2 + 2)	MCD95-14 (1 + 1)	N/A	N/A
MCST120	120	95÷120	15,2	47	25	MCD120-6 (2 + 2)	MCD120-14 (1 + 1)	N/A	N/A
MCST150	150	120÷150	16,7	58	25	MCD150-6 (3 + 3)	MCD150-14 (1 + 1)	N/A	N/A
MCST185	185	150÷185	19,2	64	25	MCD185-6 (3 + 3)	MCD185-14 (1 + 1)	N/A	N/A
MCST240	240	185÷240	21,1	75	15	MCD240-6 (3 + 3)	MCD240-14 (2 + 2)	N/A	N/A
MCST300	300	240	23,7	90	10	N/A	MCD300-14 (3 + 3)	N/A	N/A
MCST400	400	300	27,0	94	5	N/A	MCD400-14 (3 + 3)	MCD400-26 (2 + 2)	MCD400-60 (2 + 2)
MCST500	500	400	30,3	98	6	N/A	N/A	MCD500-26 (2 + 2)	MCD500-60 (2 + 2)
MCST630	600÷630	500	33,4	105	6	N/A	N/A	MCD630-26 (2 + 2)	MCD630-60 (2 + 2)
MCST800	800	600	38,0	112	3	N/A	N/A	N/A	MCD800-60 (2 + 2)
MCST1000	1,000	800	44,0	120	3	N/A	N/A	N/A	MCD1000-60 (2 + 2)

Metric Compression Tools

TBM25MCC Crimp Tool

- For non-insulated metric connectors
- High-precision treated steel jaws
- Ergonomically designed molded plastic grips
- Compact, lightweight and easy to use
- Toggle-action leverage reduces operator effort
- Shure-Stake® mechanism ensures a properly completed crimp each time
- Automatic handle opening after crimping operation

Specifications

- Wire Range: .25 – 10 sq. mm
- Weight: 1.15 lbs.
- Dimensions (L x W): 9.21" x 2.87"



CAT. NO.	DESCRIPTION	PKG. QTY.
TBM25MCC	Mechanical Crimp Tool	1

TBM26MCC 26-Ton Hydraulic Crimping Head

- Installs crimp-type electrical connectors on cables up to 1,000 MCM
- Includes male automatic coupler for connection to 10,000 psi hydraulic pump
- Optional adapter available for use with semicircular slotted dies common to most C-shaped heads (12-ton) available on the market
- Sturdy steel carrying case complete with die compartment for holding up to 10 sets of dies available on request

Specifications

- Output Force: 25.8 tons
- Dimensions (L x W): 12.4" x 4.7"
- Operating Pressure: 10,000 psi nominal
- Weight: 11.4 lbs.



CAT. NO.	DESCRIPTION	PKG. QTY.
TBM26MCC	26-Ton Hydraulic Presshead	1

TBM60MCC 60-Ton Hydraulic Crimping Head

- Installs crimp-type electrical connectors on cables up to 2,000 MCM
- Includes male automatic coupler for connection to 10,000 psi hydraulic pump
- Optional adapter available for use with semicircular slotted dies common to most C-shaped heads (12-ton) available on the market
- Sturdy steel carrying case complete with die compartment for holding up to 10 sets of dies available on request

Specifications

- Output Force: 58.4 tons
- Dimensions (L x W): 12" x 7.9"
- Operating Pressure: 10,000 psi nominal
- Weight: 39.6 lbs.



CAT. NO.	DESCRIPTION	PKG. QTY.
TBM60MCC	60-Ton Hydraulic Presshead	1

Tool Services

Count on Thomas & Betts for the Right Tools for the Right Job!

Since the 1930s, Thomas & Betts has been supplying tools, dies and connectors. Today, with more than 75 years experience in tools, dies and connectors, Thomas & Betts still sets the standard for innovation, quality and performance for application tooling. Rely on Thomas & Betts tools for labor-saving features, user comfort and convenience, long service life and extraordinary value.

Application Tooling Support — At Your Service

For more than 40 years, Thomas & Betts' highly trained, experienced and dedicated Tool Services staff has been supporting customers in every aspect of their tooling needs. With 100-plus years of combined experience, T&B application tool specialists are ready to assist you with:

- Tool recommendations based on your application and workload
- Demonstrations
- Rental and leasing programs
- On-site installation
- On-site training
- Technical support
- Calibration and certification (factory or on-site)
- Repair (both warranty and non-warranty)
- Loaners for temporary use during repairs
- Supplying components and technical documentation for customer-performed repairs

Tool Repair

Thomas & Betts Tool Services repairs all Thomas & Betts tools, from simple hand tools to hydraulic pumps and crimping heads. Tool Services performs all warranty repairs and can supply you with a temporary loaner tool when necessary. Tool Services can also perform non-warranty repairs, or, if you wish to repair your own tools, contact Tool Services to obtain any needed components, technical documentation and support.

Tool Rental Program

For short-term installation projects, sometimes it makes more sense to rent than buy power tools. Thomas & Betts Tool Services understands this and has created a Tool Rental Program, geared specifically for contractors and projects, to meet the need. Renting T&B tools is easy. A rental agreement is available on our web site, and you can pay the rental fee by credit card. Call Tool Services at **1-800-284-TOOL (8665)** for more details, including a list of Thomas & Betts tools available for rental.



Color-Keyed® Compression

Tool Leasing Program

For longer term use, many OEMs find that leasing high-end tools may be more financially attractive than purchasing. Call Tool Services at **1-800-284-TOOL (8665)** for more information and a list of Thomas & Betts tools available for lease.

Thomas & Betts Tool Warranty

You can choose Thomas & Betts tools with confidence, because we stand behind them with our warranty. The chart below shows the standard length of warranty for different types of tools. See below for additional warranty details.

1 Year

- Cable Tie Installation Tools
- Printers
- Cable Cutters & Strippers
- Dies

2 Years

- Mechanical Hand Tools with Shure-Stake® Mechanism
- Pneumatic Tools
- Hydraulic Pumps
- Battery-Operated Tools

5 Years

- Mechanical Hand Tools without Shure-Stake® Mechanism
- Hydraulic Tools (self-contained and remote heads)

Call Toll-Free **1-800-284-TOOL (8665)**

For more information about Thomas & Betts Tool Services:

E-Mail us at toolservice@tnb.com

Limited Warranty for Tools

Thomas & Betts sells tools with the understanding that the user will perform all necessary tests to determine the suitability of each tool for the user's intended application. Thomas & Betts warrants that its tools will be free from defects in materials and workmanship for the period of time specified above. Upon prompt notification of any warranted defect, Thomas & Betts will, at its option, repair or replace the defective product or refund the purchase price. Proof of purchase is required. Misuse or unauthorized modification of the product voids all warranties.

Limitations and Exclusions

The warranty above is the sole warranty concerning this product, and is in lieu of all other warranties express or implied, including but not limited to any implied warranty of merchantability or fitness for a particular purpose, which are specifically disclaimed. Liability for breach of the above warranty is limited to cost of repair or replacement of the product, and under no circumstances will Thomas & Betts be liable for any indirect, special, incidental or consequential damages.

Direct all warranty inquiries to: Thomas & Betts Tool Services **1-800-284-TOOL (8665)**.

United States
Tel: 901.252.8000
800.816.7809
Fax: 901.252.1354

Canada
Tel: 450.347.5318
Fax: 450.347.1976

Technical Services
Tel: 888.862.3289

Thomas & Betts

www.tnb.com

Tab Category Searches

Using the Product, Brand and/or Selector Guide tab searches enables you to view T&B's entire product offering so you can best determine those items of interest to you.

Quick Search Box

If you know the T&B item you are searching for or a competitive part number, this quick search box is the best place to begin your search.

- T&B Catalog/UPC Search...use this option when you know the exact T&B catalog number or its 11-digit UPC number.
- Competitor Part Number Search...use this option when you know the exact competitor's catalog number but need to view T&B's equivalent product offering.

NOTE: Users do NOT have to enter dashes, slashes and spaces when entering the part number...simply enter the alphanumeric characters you are searching for.

For the Latest Information, Visit Electrical World at tnb.com

The screenshot shows the Thomas & Betts website interface. At the top, there are navigation tabs for PRODUCTS, BRANDS, SELECTOR GUIDES, and SUPPORT. A banner for 'U.S. ELECTRICAL WORLD' and 'WELCOME' is visible. Below the banner is a 'CATALOG SEARCH' section with input fields for 'T&B Catalog Number', 'UPC - 11 Digits', 'Competitor Number', and 'Keyword', along with a 'Search' button. To the left of the search box is a 'Subject Index' menu with links like 'Application Support', 'Carrier Tracking', etc. To the right is a 'What's New ...' section listing various products and promotions. Below that is a 'Details ...' section for a hand tool, featuring an image of the tool and a 'Request CD' button. At the bottom, there are links for 'HOME | MY PROFILE | TNB.COM | HELP | POLICY' and a copyright notice for 2002, 2003, 2004, 2005.

In This Section...

Color-Keyed® Compression

Connection by CompressionB-2-B-5
 Color-Keyed® Connectors.....B-6-B-9
 Connectors for Copper Conductor.....B-10-B-42
 C-Tap Connectors for Copper Conductor.....B-43-B-44
 Copper H-Tap Connectors for Copper Conductor.....B-45-B-46
 Aluminum H-Tap Connectors.....B-47
 Interlocking Insulating Covers for H- and C-Type
 Compression Taps.....B-48-B-50
 Wire Joints for Copper Conductor.....B-51
 Cast Copper Bus Taps for Copper ConductorB-52
 Motor Pigtail ConnectorsB-53-B-57
 KUBE™ ConnectorsB-58-B-60
 Copper DisconnectsB-61
 Connector Kits.....B-62
 Connectors for Aluminum/Copper Code ConductorB-63-B-66
 Connectors for Aluminum Code ConductorB-67
 Splice Connectors for Aluminum/Copper Code Conductor.....B-68
 Transformer Lug Kits for Aluminum Code ConductorB-69
 Pin Connectors for Aluminum/Copper Code ConductorB-70
 Flag Lugs for Aluminum/Copper Code ConductorB-71
 Heavy-Duty Battery Connectors.....B-72-B-74
 Battery Cables, Heavy-Duty Battery CablesB-75
 Mechanical Compression Tools: #8 to 250 MCM
 and #8 to 500 MCM.....B-76-B-77
 Power-Assisted Compression Tools: #8 to 500 MCM
 #8 to 600 MCM; #8 to 750 MCM; #8 to 900 MCM;
 #8 to 1500 MCM; and #8 to 2000 MCMB-78-B-84
 Hydraulic PumpsB-85-B-87
 Battery Connector ToolsB-87
 Strippers, Cutters and Other Tools.....B-88-B92
 Seals and Lubricants.....B-92
 Installing Dies.....B-93-B-95
 Connectors for Copper Conductors (Metric)B-96-B-99
 Metric Compression ToolsB-100
 Tool Services.....B-101

Color-Keyed® Compression

Thomas & Betts

United States
 Tel: 901.252.8000
 Fax: 901.252.1354

Canada
 Tel: 450.347.5318
 Fax: 450.347.1976

Technical Services
 Tel: 888.862.3289

www.tnb.com

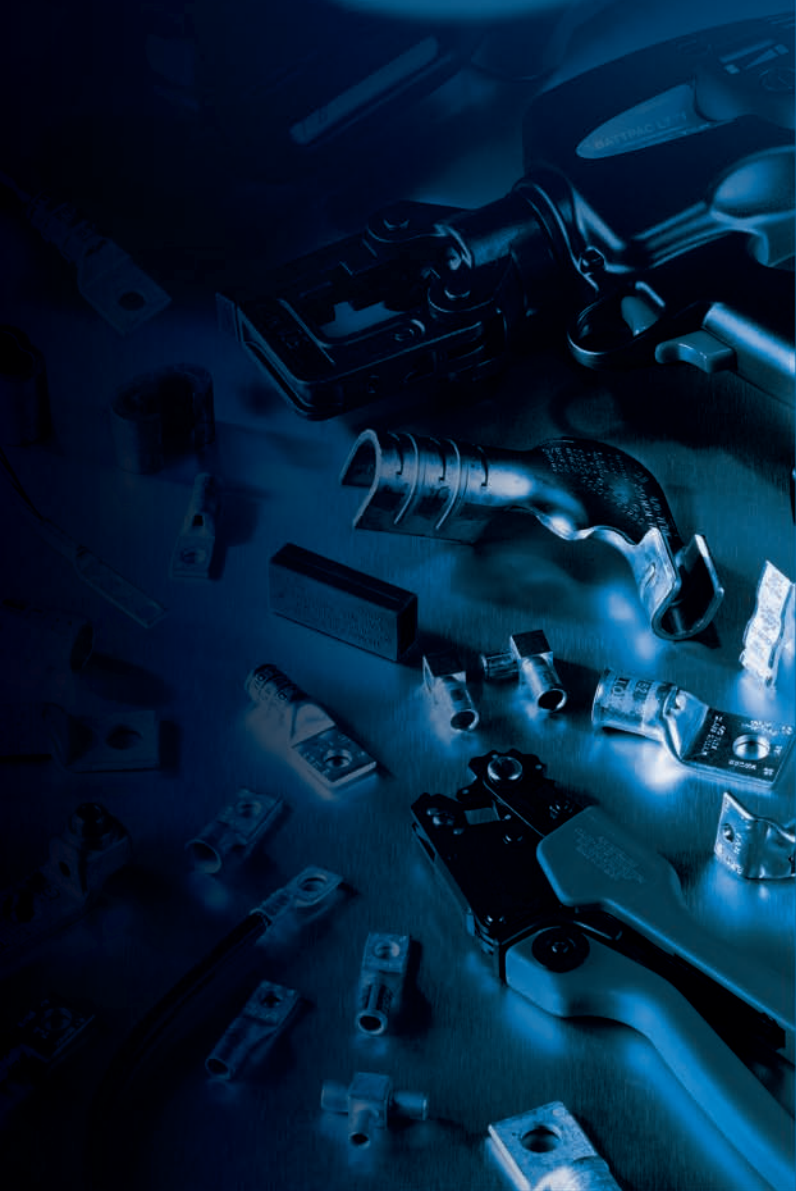

Connection by Compression

The Thomas & Betts Method is Better.

The Thomas & Betts method of installing compression connectors on power cables is designed to provide a high degree of reliability in electrical wiring. This method allows electrical workers to make installations with little effort and at a considerable savings in time. The benefit, of course, is a high quality connection at a low installed cost.

Just Four Easy Steps to a Perfect Connection!

Step 1

Strip the insulation carefully to avoid nicking or cutting conductors (wire brush if required).



Color-Keyed® Compression

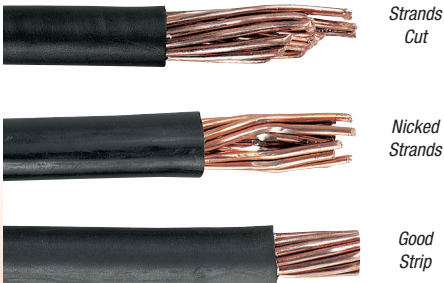

Strip the insulation to the proper length so that conductors can be fully inserted into the connector barrel.

Strip Length Too Long



Strip Length Too Short



Strip Length Just Right



Step 2

Determine the proper Color-Keyed® Connector for the cable size being used. Connectors are marked to show cable size.

- Connectors marked with just cable size or CU should be used on copper conductors only.
- Connectors marked "AL9"* with the cable size should be used on aluminum conductors only.
- Connectors marked "AL9CU" with the cable size may be used on the aluminum or copper conductors.

Cable Size



* Aluminum lugs with a "9" indicate 90°C rating.

Connection by Compression

Step 3

Select the proper installing die and appropriate tool.

Color-Keyed® Connectors have colored bands or colored dots that correspond to color markings on the dies.

Connectors and dies also have a die code number marked or stamped on them. Dies have a code number engraved in the crimp surface.



Step 4

Locate tool with correct die in proper position on connector and activate tool.

When making multiple crimps, make the first crimp nearest the tongue and work towards the barrel end.

When properly crimped, the die code number will be embossed on the connector for easy inspection to determine if correct die and connector combination were used.

Copper
Die located
BETWEEN bands



Aluminum
Die located
ON Bands



Die location for compression

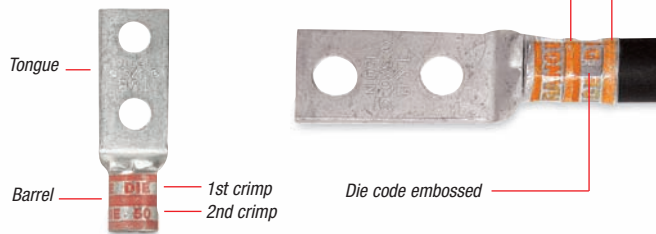

Color-Keyed® Connectors are banded by colored stripes or engraving to indicate location of die on connector for compression.

Thomas & Betts uses "full-width" and "half-width" dies dependent on connector size and tool used. "Half-width" dies are marked with the letter "H" after the die code number.

Refer to the instruction sheet supplied with the connectors for information regarding strip length, die selection and number of compressions required.

Connection by Compression

Color-Keyed® Compression

Precision Dies form a Solid Homogenous Mass...

The T&B method utilizing compression tools with matching dies forms the connector and conductor into a solid, homogenous mass to provide an optimum electrical bond between connector and conductor.

Thomas & Betts method dies are designed to produce a circumferential, hex- or diamond-shaped compression rather than a simple indent. Precision dies are an integral part of the Thomas & Betts method. The precision hardened steel dies exert tremendous, controlled pressure on the connector and conductor. The dies compress the connector around the cable, converting the round strands to hexagonal or diamond shapes and forming the strands and connector into a solid mass. Each die is designed so that all conductors receive the same amount of compression force.

The circumferential compression creates a large area of high pressure contact between cable and connector which, in turn, assures high conductivity, low resistance, and high pullout values which exceed UL requirements. These features result in a permanent, low installed cost connection. You can install it, and forget it.



Thomas & Betts' System Tells You Where to Place the Installing Die.



Before compression, a typical cross section of cable and connector consists of about 75% metal and 25% air.

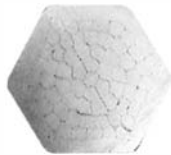

After air compression by the T&B Method, the cross section looks like this, 100% metal with virtually no air spaces.

Color-Keyed® connectors not only identify the correct installing die to be used for positive compressions, but also indicate the proper placement of the die on the connector. This is done by the bands of color on the connector which match the color on the dies. Compression is made between or on these color bands. The color name is also spelled on the connector as an added means of identification.

Thomas & Betts Dies Offer Inspection Capability.

Copper

Die located BETWEEN bands



Aluminum

Die located ON Bands



Color-Keyed® Connectors are banded by colored stripes or engraving to indicate location of die on connector for compression.

Dies that are used in Thomas & Betts hand and hydraulic tools contain the "die code" numbers which are engraved on the compression surface of the die. Under compression, this number becomes embossed on the completed connection for inspection purposes.

The inspector compares the die code number embossed on the connector with the die table to ensure that the proper connector was compressed with the correct die for that particular size conductor.



Connection by Compression

Quality Tooling with the Shure-Stake® Mechanism

T&B manual tools with the exclusive, Shure-Stake® mechanism take the guesswork out of making compression connections. The Shure-Stake® mechanism provides a full cycle compression stroke every time. Once the stroke has started, the tool will not release the connector until the proper amount of force has been applied. This is your assurance of a fully compressed connection. T&B compression tools develop uniform, controlled pressure to each connector within their size range. Thomas & Betts offers electric and battery-powered hydraulic pumps with a Shure-Stake® feature that guarantees a full cycle compression.



Color-Keyed® Compression



Battpac® LT Pump

The newest battery-powered hydraulic pump, rated for 10,000 PSI. Portable power for all T&B hydraulic heads, using just one Ni-MH 24V rechargeable battery.



TBM62BSCR

Single-handed battery-powered compression tool, features rotating head and comfortable balance. For connectors up to 500MCM CU, 350MCM AL.

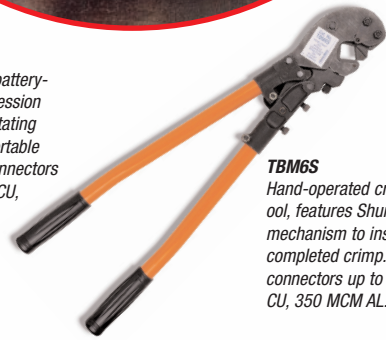

TBM6S

Hand-operated crimping tool, features Shure-Stake® mechanism to insure a completed crimp. For connectors up to 500 MCM CU, 350 MCM AL.

Thomas & Betts Method Components Meet Industry Standards.

Depending on the application, all Thomas & Betts copper connectors meet U.L. Std. 486A for code stranded and 24 gauge flex, CSA Std. C22.2, No. 65.600 V. requirements for power and U.L. Std. 467, CSA Std. 22.2 No. 0.4 requirements for direct buried grounding.

T&B method connectors are available in a range of sizes and styles to accommodate No. 8AWG through 1000 kcmil and larger copper or 2000 kcmil and larger aluminum cable. They may be compressed on cable with either manual or hydraulic tools. They are offered with standard length or long barrels, with one bolt or two bolt holes, or in two-way styles, for splicing applications. Two-way connectors are compact, providing high pullout values with low resistance.

Color-Keyed® two-hole lugs are ideal for bus bar applications that require two bolts to prevent lug rotation.

The T&B method is the most efficient, highest quality connection that has been engineered and delivers the best electrical performance and highest reliability.

T&B Compression Connectors eliminate risk of problems relating to loose connections when installed properly.

High Grade Materials Incorporated in Thomas & Betts Method

Low installed cost connections of superior quality can be achieved only through the use of high grade components. That is an important part of the T&B method — quality products you can depend on.

Copper Color-Keyed® connectors are made of high conductivity wrought copper, and are electro-tin plated to prevent corrosion and to improve conductivity. Thomas & Betts Color-Keyed® connectors offer the thickest tin-plating in the industry. Other copper connectors for heavy duty use and grid grounding applications are made of high conductivity cast copper, bright finished.

High conductivity cast aluminum connectors are available for heavy-duty application.

Color-Keyed® Connectors

Color-Keyed® Special Lugs for Special Problems — Angled, Shaped and Trimmed the Way You Need Them



Thomas & Betts can solve your difficult wire bending and terminating problems in confined power distribution panels, switchgear and motor control enclosures.

We have the design and production capability to deliver exactly the type lug you need, shaped the way you need.

- Straight, 45° and 90° angle
- Stacking or non-stacking
- Narrow tongue or standard
- Tin, silver, lead, nickel

Thomas & Betts offers an extensive line of copper Color-Keyed® lugs for #8 AWG through 1000 kcmil flex and code cables. The lug tongues are modified in several different configurations to meet your exact needs: 45° and 90° bend angles, narrow tongues to fit into circuit breakers, offset tongues to stack two cables, and special stud hole drilling. These special configurations let you:

- 1 run cable directly to the bus bar with no bending,
- 2 terminate into very narrow spaces, and
- 3 utilize minimal bus bar space.

The specially designed lugs help you “clean up” your cabling in crowded enclosures.

The photographs show some examples of how and where the lugs can be used.

Customized Color-Keyed® Connectors for Copper Cables

- Standard and special tongue angles, stacking and non-stacking, bolt holes sizes and centers, protective platings.
- Specially modified one and two hole copper Color-Keyed® compression lugs, Series 54100, 54200, 54850BE and 54930BE for flex and code copper stranded cables. Material high conductivity wrought copper.
- Minimum order quantity: Standard package quantity by cable size. Consult factory for price and delivery. All customized lugs are made to order. A.R.O. Non-cancelable.

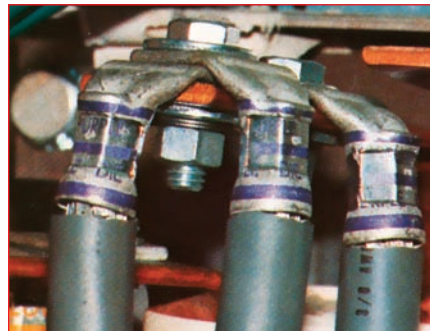

Color-Keyed® Connectors

Order Form

Catalog No. _____ Qty. _____

(For 54100, 54200, 54800 & 54900 Series Copper Lugs Only)

Design Controls and Requirements

All "MADE-UP" catalog numbers start with a standard or basic catalog number and are followed by the customer-required extra features: tongue shape, bolt hole size, distance between bolt holes, stacking, plating and inspection hole (peep hole). A code letter or a number has been assigned to each extra feature. See CODE TABLE.

NOTES: 1) Lack of any of the extra features on the "MADE-UP" catalog number means that the standard Cat. No. features are prevalent.

2) If either bolt hole size or distance between bolt holes needs to be changed from standard Cat. No., both code numbers will appear on the "MADE-UP" Cat. No. (See example below)

CAT. NO. 54212UB0416BSP

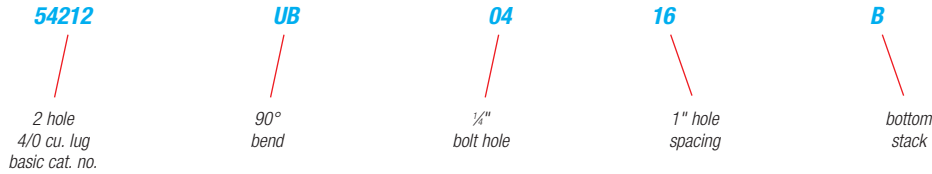

CODE TABLE

TONGUE SHAPE		BOLT HOLES			BOLT HOLE CENTERS		STACKING		FINISH (PLATING)		INSPECTION HOLE (LONG BARREL)		INSPECTION HOLE (SHORT BARREL)		
TYPE	CODE	SIZE	.020	CODE	DISTANCE	.015	CODE	TYPE	CODE	TYPE 1	CODE	I.D.	CODE	I.D.	CODE
45°	UF	#8	.173	02	1/2"	.08	08	Top	T**	Silver Plate	SP	Peep Hole	PH	Blind End	BE
90°	UB	#10	.204	03	5/8"	.10	10	Bottom	B	Lead Plate	LP				
Blank	BT	1/4"	.281	04	3/4"	.12	12			Nickel Plate	NP				
(No Bolt Hole)		5/16"	.344	05	7/8"	.14	14			Plain Finish	PF				
		3/8"	.406	06	1"	.16	16			No Marking	NM				
		1/2"	.531	08	1 1/8"	.18	18			Not QTP if					
		5/8"	.656	10	1 1/4"	.20	20			suffix other					
		3/4"	.812	12	1 3/8"	.22	22			than - PF or					
		7/8"	.937	14	1 1/2"	.24	24			standard					
		1"	1.062	16	1 5/8"	.26	26			tin plate					
					1 3/4"	.28	28								
					*1 7/8"	.30	30								
					*2"	.32	32								

* These bolt centers not available for bolt holes larger than 1 3/8".

** Not required for 45° & 90° Top Stacking.

Cable	Code <input type="checkbox"/>	
	Weld <input type="checkbox"/>	
<input type="checkbox"/> #8	<input type="checkbox"/> #6	<input type="checkbox"/> #4
<input type="checkbox"/> #2	<input type="checkbox"/> #1	<input type="checkbox"/> 1/0
<input type="checkbox"/> 2/0	<input type="checkbox"/> 3/0	<input type="checkbox"/> 4/0
<input type="checkbox"/> 250 kcmil & up (Code Only)		

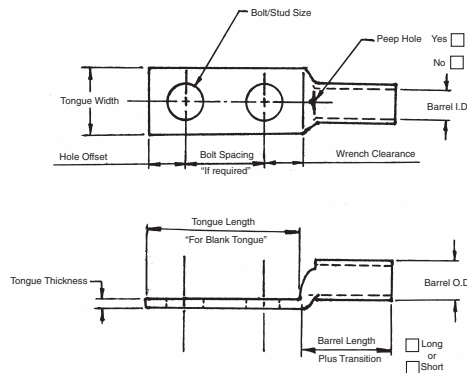

United States
Tel: 901.252.8000
800.816.7809
Fax: 901.252.1354

Canada
Tel: 450.347.5318
Fax: 450.347.1976

Technical Services
Tel: 888.862.3289

Thomas & Betts

www.tnb.com

Tongue Specifications — See Chart “A” For Dimensions

Stud Sizes		
<input type="checkbox"/> #8	<input type="checkbox"/> #10	<input type="checkbox"/> ¼"
<input type="checkbox"/> ⅝"	<input type="checkbox"/> ¾"	<input type="checkbox"/> ½"
<input type="checkbox"/> ⅜"	<input type="checkbox"/> ⅜"	<input type="checkbox"/> ⅜"
<input type="checkbox"/> 1"		

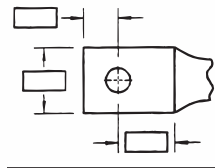

Single Hole

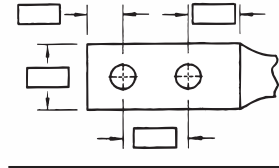

Double Hole

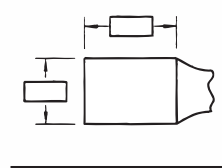

Blank

Chart A

NOMINAL BOLT HOLE SIZE .015	HOLE OFFSET .030	WRENCH CLEARANCE MIN.	TONGUE WIDTH CABLE SIZE										
			#8 CODE #8 WELD	#6 CODE #6 WELD	#4 CODE #4 WELD	#2 CODE #2 WELD	#1 CODE #1 WELD	1/0 CODE 1/0 WELD	2/0 CODE 2/0 WELD	3/0 CODE 3/0 WELD	4/0 CODE 4/0 WELD	250 CODE	
#8	.173	.200	.240	.406	.437	.562	.593	.672	.750	.825	.937	1.030	1.125
#10	.204	.218	.250	.406	.437	.562	.593	.672	.750	.825	.937	1.030	1.125
¼	.281	.250	.312	.469	.500	.562	.593	.672	.750	.825	.937	1.030	1.125
⅝	.344	.375	.406	.562	.562	.562	.675	.672	.750	.825	.937	1.030	1.125
⅜	.406	.375	.440	.578	.578	.594	.675	.672	.750	.825	.937	1.030	1.125
½	.531	.500	.562	—	—	—	.750	.750	.750	.825	.937	1.030	1.125
⅝	.656	.812	.875	—	—	—	—	—	—	—	.937	1.030	1.125
¾	.812	.750	.770	—	—	—	—	—	—	—	—	—	—
*⅞	.937	.875	.890	—	—	—	—	—	—	—	—	—	—
*1	1.062	.937	1.000	—	—	—	—	—	—	—	—	—	—

* These bolt holes available in one hole lug only.

Chart B

CABLE SIZE	TONGUE THICKNESS	STRAIGHT LUG BARREL LENGTH PLUS TRANSITION		BARREL		DIM "X" STACKED LUGS			DIM "Y"		DIM "H"	
		SHORT	LONG	O.D.	I.D.	STRAIGHT	45°	90°	SHORT	LONG	SHORT	LONG
#8	.080	.635	.935	.260	.180	.158	.478	.394	.595	.808	.779	1.079
#6	.081	.675	.975	.296	.215	.134	.544	.432	.587	.799	.767	1.067
#4	.099	.685	.985	.365	.266	.175	.622	.502	.637	.849	.838	1.138
#2	.108	.815	1.115	.410	.302	.216	.649	.535	.711	.923	.958	1.258
#1	.106	.825	1.275	.467	.361	.212	.731	.592	.710	1.028	.956	1.406
1/0	.125	.975	1.325	.520	.396	.250	.789	.646	.794	1.042	1.075	1.425
2/0	.125	.965	1.315	.571	.446	.250	.859	.696	.829	1.077	1.125	1.475
3/0	.125	1.085	1.435	.632	.507	.250	.946	.757	.900	1.148	1.225	1.575
4/0	.137	1.255	1.705	.701	.564	.274	1.031	.826	1.015	1.333	1.387	1.837
250	.137	1.375	1.925	.766	.629	.274	1.123	.891	1.085	1.474	1.487	2.037
300	.153	1.900	2.675	.850	.660	.459	1.226	.975	1.180	1.726	1.924	2.679
350	.177	2.090	2.896	.926	.720	.531	1.333	1.103	1.267	1.830	2.096	2.896
400	.173	2.460	2.980	.960	.757	.519	1.370	1.085	1.551	1.913	2.484	2.984
500	.218	2.670	3.610	1.100	.852	.654	1.514	1.225	1.629	2.266	2.669	3.619
600	.244	2.900	3.490	1.200	.926	.732	1.630	1.325	1.762	2.147	2.897	3.497
700	.228	2.784	-	1.255	.997	.684	1.662	1.375	1.780	—	3.011	—
750	.270	3.050	3.925	1.330	1.030	.810	1.745	1.455	1.827	2.434	3.050	3.925
800	.266	3.213	-	1.375	1.079	.800	1.728	1.625	1.952	2.787	3.213	4.554
900	.313	3.450	4.550	1.500	1.145	.940	1.900	1.650	2.065	—	1.387	—
1,000	.297	3.356	4.500	1.550	1.203	.890	2.070	1.675	2.031	2.787	1.487	4.506

NOTE: Stacking lugs are available for one bolt only.
 Consult Factory: Straight: 700 kcmil & up
 45°: 400 kcmil & up
 90°: 500 kcmil & up

Color-Keyed® Connectors

Tongue Specifications — See Chart “A” For Dimensions

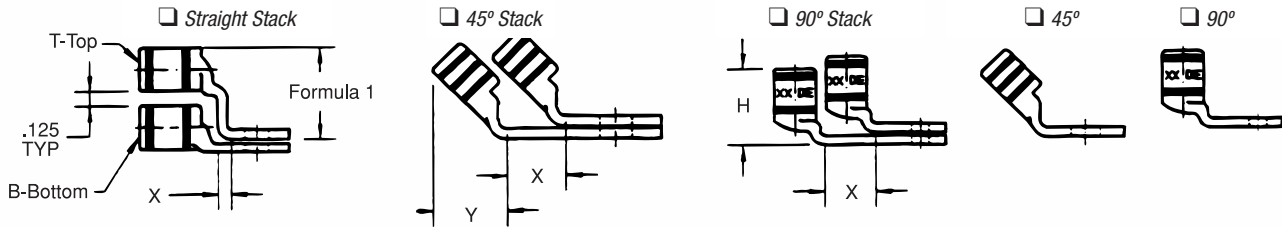

Formula 1 = (.125 + 2 (OD) + .037 – Tongue Thickness)

Chart C

BOLT HOLE SIZE	TONGUE WIDTH .030 CODE CABLE SIZE										
	300 KCMIL 4/0 WELD	350 KCMIL	400 KCMIL	500 KCMIL 400 WELD	600 KCMIL 500 WELD	1325/24	700 KCMIL	750 KCMIL	800 KCMIL	900 KCMIL	1000 KCMIL
#8	—	—	—	—	—	—	—	—	—	—	—
#10	—	—	—	—	—	—	—	—	—	—	—
¼	1.250	1.355	1.410	1.605	1.745	1.805	1.840	1.935	2.010	2.180	2.265
⅜	1.250	1.355	1.410	1.605	1.745	1.805	1.840	1.935	2.010	2.180	2.265
½	1.250	1.355	1.410	1.605	1.745	1.805	1.840	1.935	2.010	2.180	2.265
¾	1.250	1.355	1.410	1.605	1.745	1.805	1.840	1.935	2.010	2.180	2.265
¾	1.250	1.355	1.410	1.605	1.745	1.805	1.840	1.935	2.010	2.180	2.265
*¾	—	—	—	1.605	1.745	1.805	1.840	1.935	2.010	2.180	2.265
*1	—	—	—	—	1.745	1.805	1.840	1.935	2.010	2.180	2.265

Color-Keyed® Compression

Connectors for Copper Conductor

One-Hole Lugs — Standard Barrel 600V to 35KV

Material: High-Conductivity Wrought Copper

Finish: Electro Tin Plate

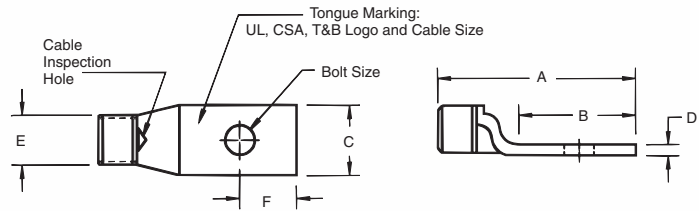

Color-Keyed® Compression

CAT. NO.	CODE	WIRE SIZE		DIMENSIONS (IN.)							DIE CODE	DIE COLOR
		FLEX CLASS G, H, I, K, M†	BOLT SIZE	A	B	C	D	E	F			
54101			¼	1.23	.56	.50	.05	.20	¼	ERG2002	YELLOW	
256-30695-1351	#14-10 AWG		#8	1.36	.68	.36	.05	.20	¼	ERG2002	YELLOW	
256-30695-1352			¼	1.36	.68	.41	.05	.20	¼	ERG2002	YELLOW	
256-30695-263			¼	1.69	.81	.50	.07	.20	¼	ERG2002	YELLOW	
54104			#10	1.16	.50	.39	.08	.25	⅜	21	RED	
54130	#8 AWG	23 Navy	¼	1.20	.61	.45	.07	.25	¼	21	RED	
54131		#8 Weld	⅝	1.33	.64	.56	.05	.25	⅝	21	RED	
54132		37/24 = 14.9 kcmil	⅝	1.33	.64	.56	.05	.25	⅝	21	RED	
256-30695-424			½	1.75	1.31	1.00	.13	.25	½	21	RED	
256-30695-1361			#12	1.23	.53	.44	.07	.31	⅜	24	BLUE	
54134	#6 AWG		#10	1.23	.53	.44	.07	.31	⅜	24	BLUE	
54105		#30 Navy	¼	1.23	.53	.44	.07	.31	⅜	24	BLUE	
54135		#6 Weld	⅝	1.41	.67	.60	.07	.31	⅝	24	BLUE	
54136		61/24 = 24.6 kcmil	⅝	1.41	.67	.60	.07	.31	⅝	24	BLUE	
256-30695-282		133/.014	⅝	1.41	.75	.56	.06	.31	⅝	24	BLUE	
256-30695-422			½	1.75	1.31	1.00	.13	.31	½	24	BLUE	
256-30695-1362			#12	1.38	.60	.55	.09	.37	¼	29	GRAY	
54138	#4 AWG		#10	1.38	.60	.55	.09	.37	¼	29	GRAY	
54106		40-50 Navy	¼	1.38	.60	.55	.09	.37	¼	29	GRAY	
54139		91/24 = 36.7 kcmil	⅝	1.42	.66	.61	.07	.37	⅝	29	GRAY	
54140		133/.0177	⅝	1.42	.66	.61	.07	.37	⅝	29	GRAY	
256-30695-233		49/.029	⅝	1.56	.75	.59	.06	.37	⅝	29	GRAY	
256-30695-264			½	2.20	1.40	1.00	.06	.37	½	29	GRAY	
54107	#2 AWG		¼	1.50	.65	.59	.11	.41	¼	33	BROWN	
54142-TB		#60 Navy	⅝	1.73	.88	.59	.11	.41	⅝	33	BROWN	
54143-TB		125/24 = 50.5 kcmil	⅝	1.65	.80	.59	.11	.41	⅝	33	BROWN	
54145-TB		#4 Weld	½	1.92	1.08	.75	.08	.41	½	33	BROWN	
54108	#1 AWG	75 Navy, #2 Weld	¼	1.50	.65	.68	.11	.47	¼	37	GREEN	
54147		150/24 = 60.5 kcmil	⅝	1.73	.93	.68	.11	.47	⅝	37	GREEN	
54148		175/24 = 70.6 kcmil	⅝	1.78	.98	.68	.11	.47	⅝	37	GREEN	
54150		133/.0223	½	2.10	1.25	.76	.11	.47	½	37	GREEN	
54152-TB			¼	1.60	.65	.75	.13	.52	¼	42	PINK	
54153-TB	1/0 AWG	#100 Navy	⅝	1.83	.88	.75	.13	.52	⅝	42	PINK	
54109		#1 Weld	⅝	1.88	.93	.75	.13	.52	⅝	42	PINK	
54155-TB		225/24 = 90.8 kcmil	½	2.20	1.25	.75	.13	.52	½	42	PINK	
256-30695-1383		133/.0254	⅝	2.54	1.50	.88	.13	.52	⅝	42	PINK	
54157	2/0 AWG	125 Navy	¼	1.65	.65	.83	.13	.57	¼	45	BLACK	
54158		1/0 Weld	⅝	1.88	.88	.83	.13	.57	⅝	45	BLACK	
54110		275/24 = 111 kcmil	⅝	1.93	.93	.83	.13	.57	⅝	45	BLACK	
54160		427/.0155	½	2.25	1.25	.83	.13	.57	½	45	BLACK	
256-30695-131		133/.0282	⅝	2.56	1.50	.83	.13	.57	⅝	45	BLACK	

† Contact Technical Services for specific stranding listings

Tooling: pp. B76-B92

Die Selector Chart: pp. B93-B95

Connectors for Copper Conductor

One-Hole Lugs — Standard Barrel 600V to 35KV (continued)

Material: High-Conductivity
Wrought Copper

Finish: Electro Tin Plate

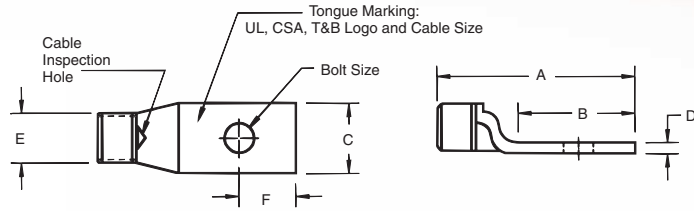

Color-Keyed Compression

CAT. NO.	CODE	WIRE SIZE		DIMENSIONS (IN.)						DIE CODE	DIE COLOR
		FLEX CLASS G, H, I, K, M†	BOLT SIZE	A	B	C	D	E	F		
54162-TB		150 Navy, 2/0 Weld	¼	1.75	.65	.92	.13	.63	¼	50	ORANGE
54163-TB		325/24 = 131 kcmil	⅝	1.98	.88	.92	.13	.63	⅝	50	ORANGE
54111	3/0 AWG	133/.0316, 259/.0227	¾	2.03	.93	.92	.13	.63	¾	50	ORANGE
54165-TB		427/.0177	½	2.35	1.25	.92	.13	.63	½	50	ORANGE
54167		200 Navy	¼	1.90	.65	1.03	.14	.70	¼	54	PURPLE
54168		3/0 Weld	⅝	2.13	.87	1.03	.14	.70	⅝	54	PURPLE
54112	4/0 AWG	450/24 = 182 kcmil	¾	2.18	.93	1.03	.14	.70	¾	54	PURPLE
54170		703/.0154	½	2.50	1.25	1.03	.14	.70	½	54	PURPLE
256-30695-1174		4/0 Weld	¾	2.86	1.56	1.03	.14	.70	¾	54	PURPLE
58161		550/24 = 222 kcmil	¼	2.23	.78	1.25	.15	.79	¾	62	YELLOW
58162		133/.0399	⅝	2.33	.88	1.25	.15	.79	¾	62	YELLOW
58163		259/.0286	¾	2.38	.93	1.25	.15	.79	¾	62	YELLOW
58165		637/.0183	½	2.76	1.25	1.25	.15	.79	½	62	YELLOW
58166			¾	3.03	1.58	1.25	.15	.79	¾	62	YELLOW
54172-TB		250 Navy	¼	2.00	.65	1.13	.14	.77	¼	62	YELLOW
54173	250 kcmil		⅝	2.23	.88	1.13	.14	.77	⅝	62	YELLOW
54174			¾	2.28	.93	1.13	.14	.77	¾	62	YELLOW
54113			½	2.60	1.25	1.13	.14	.77	½	62	YELLOW
58168		250 Weld, 650/24 = 262 kcmil, 259/.0311, 703/.0189	½	2.70	1.25	1.25	.15	.85	½	66	WHITE
54178			⅝	2.33	.88	1.25	.15	.85	¾	66	WHITE
54179	300 kcmil	300 Navy	¾	2.43	.93	1.25	.15	.85	¾	66	WHITE
54114			½	2.70	1.25	1.25	.15	.85	½	66	WHITE
54181			¾	3.03	1.58	1.25	.15	.85	¾	66	WHITE
58171		300 Weld, 259/.034, 427/.0265, 889/.0183 775/24 = 313 kcmil	½	2.85	1.25	1.36	.18	.93	½	71	RED
256-30695-112			¾	2.90	1.25	1.36	.18	.93	¾	71	RED
54115	350 kcmil	350 Navy	½	2.85	1.25	1.36	.18	.93	½	71	RED
54183			¾	3.21	1.58	1.36	.18	.93	¾	71	RED
58174		350 Weld, 259/.0368, 427/.0285, 703/.0224, 889/.0201	½	3.35	1.25	1.61	.22	1.09	½	76	BLUE
54116	400 kcmil	400 Navy	¼	3.20	1.25	1.41	.17	.96	¼	76	BLUE
54185			¾	3.53	1.58	1.41	.17	.96	¾	76	BLUE

† Contact Technical Services for specific stranding listings

Tooling: pp. B76-B92

Die Selector Chart: pp. B93-B95

Connectors for Copper Conductor

One-Hole Lugs — Standard Barrel 600V to 35KV (continued)

Material: High-Conductivity Wrought Copper

Finish: Electro Tin Plate

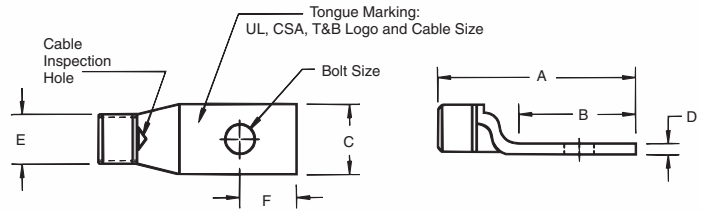

CAT. NO.	WIRE SIZE			DIMENSIONS (IN.)						DIE CODE	DIE COLOR	
	CODE	FLEX CLASS G, H, I, K, M†	BOLT SIZE	A	B	C	D	E	F			
256-30695-1403 58177		400 Weld										
		925/24 = 373 kcmil	3/8	3.31	1.31	1.61	.22	1.04	5/8	80	N/A	
		259/.0393 or 427/.0306	1/2	3.31	1.25	1.61	.22	1.04	1/2	80	N/A	
256-30695-339 54118 54187			3/8	3.10	1.00	1.61	.22	1.10	3/8	87	BROWN	
	500 kcmil	500 Navy	1/2	3.30	1.25	1.61	.22	1.10	1/2	87	BROWN	
			3/8	3.63	1.58	1.61	.22	1.10	5/8	87	BROWN	
58180		1100/24 = 444 kcmil, 500 Weld, 259/.0417, 427/.0325, 703/.0253	3/8	3.79	1.58	1.75	.24	1.20	5/8	94	GREEN	
	256-30695-1370 54120	600 kcmil	1/2	3.65	1.44	1.75	.24	1.20	3/4	94	GREEN	
54122-TB	700 kcmil		3/8	3.79	1.58	1.75	.24	1.20	5/8	94	GREEN	
256-30695-1404			3/8	3.68	1.58	1.84	.23	1.26	5/8	99	PINK	
256-30695-1405			3/8	3.29	1.29	1.81	.28	1.25	21/32	99	PINK	
256-30695-840		1325/24 = 535 kcmil	1/2	3.29	1.29	1.81	.28	1.25	21/32	99	PINK	
58182		427/.0342	1/2	4.00	1.69	1.81	.28	1.25	31/64	99	PINK	
256-30695-193	750 kcmil		3/8	3.83	1.58	1.81	.28	1.25	5/8	99	PINK	
54123-TB			1/2	4.00	1.69	1.94	.27	1.33	31/64	106	BLACK	
58184			3/8	3.87	1.58	1.94	.27	1.33	5/8	106	BLACK	
54124-TB	800 kcmil	1600/24 = 646 kcmil	3/8	3.80	1.58	1.94	.27	1.33	5/8	106	BLACK	
256-30695-843	900 kcmil	800 Navy	3/8	4.04	1.58	2.01	.27	1.38	5/8	107	ORANGE	
54126			3/8	4.31	1.81	2.17	.31	1.50	7/8	115	YELLOW	
54128			3/8	4.15	1.58	2.17	.31	1.50	5/8	115	YELLOW	
			3/8	4.09	1.58	2.27	.30	1.55	5/8	125	N/A	

† Contact Technical Services for specific stranding listings

Tooling: pp. B76-B92

Die Selector Chart: pp. B93-B95

NOTE: Angled Lugs can be readily available as: 15°, 30°, 45°, 60°, and 90°

Connectors for Copper Conductor

One-Hole Lugs — 45° Standard Barrel 600V to 35KV

Material: High-Conductivity
Wrought Copper

Finish: Electro Tin Plate

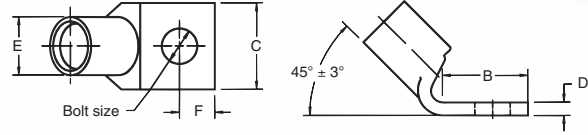

Color-Keyed Compression

CAT. NO.	CODE	WIRE SIZE		DIMENSIONS (IN.)							DIE CODE	DIE COLOR
		FLEX CLASS	G, H, I, K, M†	BOLT SIZE	B	C	D	E	F			
54104UF	#8 AWG	23 Navy		#10	.50	.39	.08	.25	1/2	21	RED	
54130UF		#8 Weld		1/4	.61	.45	.07	.25	1/4	21	RED	
54131UF				5/16	.64	.56	.05	.25	3/2	21	RED	
54132UF		37/24 = 14.9 kcmil		3/8	.64	.56	.05	.25	3/2	21	RED	
54134UF	#6 AWG	30 Navy		#10	.53	.44	.07	.31	1/2	24	BLUE	
54105UF		#6 Weld		1/4	.53	.44	.07	.31	1/2	24	BLUE	
54135UF		61/24 = 24.6 kcmil		5/16	.67	.60	.07	.31	3/16	24	BLUE	
54136UF		133/.014		3/8	.67	.60	.07	.31	3/16	24	BLUE	
54138UF	#4 AWG	40-50 Navy		#10	.60	.55	.09	.37	1/4	29	GRAY	
54106UF				1/4	.60	.55	.09	.37	1/4	29	GRAY	
54139UF		91/24 = 36.7 kcmil		5/16	.66	.61	.07	.37	3/16	29	GRAY	
54140UF		133/.0177		3/8	.66	.61	.07	.37	3/16	29	GRAY	
256-30695-264UF		49/.029		1/2	1.40	1.00	.06	.37	1/2	29	GRAY	
54107UF	#2 AWG	60 Navy		1/4	.65	.59	.11	.41	1/4	33	BROWN	
54142UF				5/16	.88	.59	.11	.41	3/8	33	BROWN	
54143UF		125/24 = 50.4 kcmil		3/8	.80	.59	.11	.41	3/8	33	BROWN	
54145UF		#4 Weld		1/2	1.08	.75	.08	.41	1/2	33	BROWN	
54108UF	#1 AWG	75 Navy, #2 Weld		1/4	.65	.68	.11	.47	1/4	37	GREEN	
54147UF				5/16	.93	.68	.11	.47	3/8	37	GREEN	
54148UF		150/24 = 60.5 kcmil		3/8	.98	.68	.11	.47	3/8	37	GREEN	
54150UF		175/24 = 70.6 kcmil		1/2	1.25	.76	.11	.47	1/2	37	GREEN	
54152UF	1/0 AWG	133/.0223		1/2	1.25	.76	.11	.47	1/2	37	GREEN	
54152UF		100 Navy		1/4	.65	.75	.13	.52	1/4	42	PINK	
54153UF		#1 Weld		5/16	.88	.75	.13	.52	3/8	42	PINK	
54109UF		225/24 = 90.8 kcmil		3/8	.93	.75	.13	.52	3/8	42	PINK	
54155UF		133/.0254		1/2	1.25	.75	.13	.52	1/2	42	PINK	
54157UF	2/0 AWG	125 Navy		1/4	.65	.83	.13	.57	1/4	45	BLACK	
54158UF				5/16	.88	.83	.13	.57	3/8	45	BLACK	
54110UF		1/0 Weld		3/8	.93	.83	.13	.57	3/8	45	BLACK	
54160UF		275/24 = 111 kcmil		1/2	1.25	.83	.13	.57	1/2	45	BLACK	
54162UF	3/0 AWG	427/.0155, 133/.0282		1/2	1.25	.83	.13	.57	1/2	45	BLACK	
54162UF		150 Navy, 2/0 Weld		1/4	.65	.92	.13	.63	1/4	50	ORANGE	
54163UF				5/16	.88	.92	.13	.63	3/8	50	ORANGE	
54111UF		325/24 = 131 kcmil		3/8	.93	.92	.13	.63	3/8	50	ORANGE	
54165UF		133/.0316, 259/.0227		1/2	1.25	.92	.13	.63	1/2	50	ORANGE	
54165UF		427/.0177		1/2	1.25	.92	.13	.63	1/2	50	ORANGE	
54167UF	4/0 AWG	200 Navy		1/4	.65	1.03	.14	.70	1/4	54	PURPLE	
54168UF				5/16	.87	1.03	.14	.70	3/8	54	PURPLE	
54112UF		3/0 Weld		3/8	.93	1.03	.14	.70	3/8	54	PURPLE	
54170UF		450/24 = 182 kcmil		1/2	1.25	1.03	.14	.70	1/2	54	PURPLE	
54167UF		703/.0154		1/2	1.25	1.03	.14	.70	1/2	54	PURPLE	
58161UF	4/0 AWG	4/0 Weld		1/4	.78	1.25	.15	.79	3/8	62	YELLOW	
58162UF				5/16	.88	1.25	.15	.79	3/8	62	YELLOW	
58163UF		550/24 = 222 kcmil		3/8	.93	1.25	.15	.79	3/8	62	YELLOW	
58163UF			133/.0399		3/8	.93	1.25	.15	.79	3/8	62	YELLOW
58165UF		259/.0286		1/2	1.25	1.25	.15	.79	1/2	62	YELLOW	
58166UF		637/.0183		3/8	1.58	1.25	.15	.79	3/8	62	YELLOW	

† Contact Technical Services for specific stranding listings

Tooling: pp. B76-B92 Die Selector Chart: pp. B93-B95

United States
Tel: 901.252.8000
800.816.7809
Fax: 901.252.1354

Canada
Tel: 450.347.5318
Fax: 450.347.1976

Technical Services
Tel: 888.862.3289

Thomas & Betts

www.tnb.com

Connectors for Copper Conductor

One-Hole Lugs — 45° Standard Barrel 600V to 35KV (continued)

Material: High-Conductivity
Wrought Copper

Finish: Electro Tin Plate

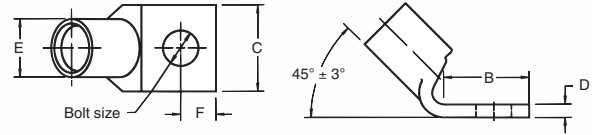

CAT. NO.	CODE	WIRE SIZE		BOLT SIZE	DIMENSIONS (IN.)					DIE CODE	DIE COLOR
		FLEX CLASS	G, H, I, K, M†		B	C	D	E	F		
54172UF				¼	.65	1.13	.14	.77	¼	62	YELLOW
54173UF				⅜	.88	1.13	.14	.77	⅜	62	YELLOW
54174UF	250 kcmil	250 Navy		⅜	.93	1.13	.14	.77	⅜	62	YELLOW
54113UF				½	1.25	1.13	.14	.77	½	62	YELLOW
58168UF		250 Weld, 650/24 = 262 kcmil, 259/.0311, 703/.0189		½	1.25	1.25	.15	.85	½	66	WHITE
54178UF				⅜	.88	1.25	.15	.85	⅜	66	WHITE
54179UF				⅜	.93	1.25	.15	.85	⅜	66	WHITE
54114UF	300 kcmil	300 Navy		½	1.25	1.25	.15	.85	½	66	WHITE
54181UF				⅝	1.58	1.25	.15	.85	⅝	66	WHITE
58171UF		300 Weld, 259/.034, 427/.0265, 889/.0183 775/24 = 313 kcmil		½	1.25	1.36	.18	.93	½	71	RED
256-30695-112UF				⅜	1.25	1.36	.18	.93	½	71	RED
54115UF	350 kcmil	350 Navy		½	1.25	1.36	.18	.93	½	71	RED
54183UF				⅝	1.58	1.36	.18	.93	⅝	71	RED
58174UF		350 Weld, 259/.0368, 427/.0285, 703/.0224, 889/.0201		½	1.25	1.61	.22	1.09	½	76	BLUE
54116UF				½	1.25	1.41	.17	.96	½	76	BLUE
54185UF	400 kcmil	400 Navy		⅝	1.58	1.41	.17	.96	⅝	76	BLUE
256-30695-1403UF		400 Weld		⅜	1.31	1.61	.22	1.04	⅜	80	N/A
58177UF		925/24 = 373 kcmil		½	1.25	1.61	.22	1.04	½	80	N/A
54118UF				½	1.25	1.61	.22	1.10	½	87	BROWN
54187UF	500 kcmil	500 Navy		⅝	1.58	1.61	.22	1.10	⅝	87	BROWN
58180UF		1100/24 = 444 kcmil, 500 Weld, 259/.0417, 427/.0325, 703/.0253		⅝	1.58	1.75	.24	1.20	½	94	GREEN
54120UF	600 kcmil			⅝	1.58	1.75	.24	1.20	½	94	GREEN
54122UF	700 kcmil			⅝	1.58	1.84	.23	1.26	½	99	PINK
256-30695-840UF		1325/24 = 535 kcmil		½	1.69	1.81	.28	1.25	⅝	99	PINK
58182UF		427/.0342		⅝	1.58	1.81	.28	1.25	⅝	99	PINK
54123UF	750 kcmil			⅝	1.58	1.94	.27	1.33	⅝	106	BLACK
58184UF		1600/24 = 646 kcmil		⅝	1.58	1.94	.27	1.33	⅝	106	BLACK
54124UF	800 kcmil	800 Navy		⅝	1.58	2.01	.27	1.38	⅝	107	ORANGE
54126UF	900 kcmil	1925/24 = 777 kcmil		⅝	1.58	2.17	.31	1.50	⅝	115	YELLOW
54128UF	1000 kcmil	1000 Navy		⅝	1.58	2.27	.30	1.55	⅝	125	N/A

† Contact Technical Services for specific stranding listings

Tooling: pp. B76–B92

Die Selector Chart: pp. B93–B95

Connectors for Copper Conductor

One-Hole Lugs — 90° Standard Barrel 600V to 35KV

Material: High-Conductivity
Wrought Copper

Finish: Electro Tin Plate

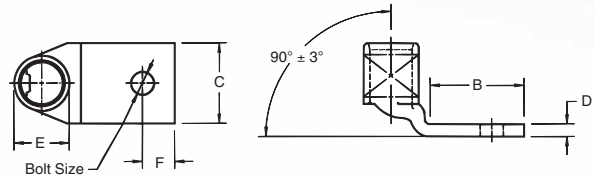

Color-Keyed Compression

CAT. NO.	CODE	WIRE SIZE		DIMENSIONS (IN.)					DIE CODE	DIE COLOR
		FLEX CLASS G, H, I, K, M†	BOLT SIZE	B	C	D	E	F		
54104UB			#10	.50	.39	.08	.25	1/2	21	RED
54130UB	#8 AWG	23 Navy	1/4	.61	.45	.07	.25	1/4	21	RED
54131UB		#8 Weld	5/16	.64	.56	.05	.25	1/2	21	RED
54132UB		37/24 = 14.9 kcmil	3/8	.64	.56	.05	.25	1/2	21	RED
54134UB	#6 AWG	30 Navy	#10	.53	.44	.07	.31	1/2	24	BLUE
54105UB		#6 Weld	1/4	.53	.44	.07	.31	1/2	24	BLUE
54135UB		61/24 = 24.6 kcmil	5/16	.67	.60	.07	.31	1/16	24	BLUE
54136UB		133/.014	3/8	.67	.60	.07	.31	1/16	24	BLUE
54138UB	#4 AWG	40-50 Navy	#10	.60	.55	.09	.37	1/4	29	GRAY
54106UB			1/4	.60	.55	.09	.37	1/4	29	GRAY
54139UB		91/24 = 36.7 kcmil	5/16	.66	.61	.07	.37	1/16	29	GRAY
54140UB		133/.0177	3/8	.66	.61	.07	.37	1/16	29	GRAY
256-30695-264UB		49/.029	1/2	1.40	1.00	.06	.37	1/2	29	GRAY
54107UB	#2 AWG	60 Navy	1/4	.65	.59	.11	.41	1/4	33	BROWN
54142UB		125/24 = 50.4 kcmil	5/16	.88	.59	.11	.41	1/8	33	BROWN
54143UB		#4 Weld	3/8	.80	.59	.11	.41	1/8	33	BROWN
54145UB			1/2	1.08	.75	.08	.41	1/2	33	BROWN
54108UB	#1 AWG	75 Navy, #2 Weld	1/4	.65	.68	.11	.47	1/4	37	GREEN
54147UB		150/24 = 60.5 kcmil	5/16	.93	.68	.11	.47	1/8	37	GREEN
54148UB		175/24 = 70.6 kcmil	3/8	.98	.68	.11	.47	1/8	37	GREEN
54150UB		133/.0223	1/2	1.25	.76	.11	.47	1/2	37	GREEN
54152UB	1/0 AWG	100 Navy	1/4	.65	.75	.13	.52	1/4	42	PINK
54153UB		#1 Weld	5/16	.88	.75	.13	.52	1/8	42	PINK
54109UB		225/24 = 90.8 kcmil	3/8	.93	.75	.13	.52	1/8	42	PINK
54155UB		133/.0254	1/2	1.25	.75	.13	.52	1/2	42	PINK
54157UB	2/0 AWG	125 Navy	1/4	.65	.83	.13	.57	1/4	45	BLACK
54158UB		1/0 Weld	5/16	.88	.83	.13	.57	1/8	45	BLACK
54110UB		275/24 = 111 kcmil	3/8	.93	.83	.13	.57	1/8	45	BLACK
54160UB		427/.0155, 133/.0282	1/2	1.25	.83	.13	.57	1/2	45	BLACK
54162UB	3/0 AWG	150 Navy, 2/0 Weld	1/4	.65	.92	.13	.63	1/4	50	ORANGE
54163UB		325/24 = 131 kcmil	5/16	.88	.92	.13	.63	1/8	50	ORANGE
54111UB		133/.0316, 259/.0227	3/8	.93	.92	.13	.63	1/8	50	ORANGE
54165UB		427/.0177	1/2	1.25	.92	.13	.63	1/2	50	ORANGE
54167UB	4/0 AWG	200 Navy	1/4	.65	1.03	.14	.70	1/4	54	PURPLE
54168UB		3/0 Weld	5/16	.87	1.03	.14	.70	1/8	54	PURPLE
54112UB		450/24 = 182 kcmil	3/8	.93	1.03	.14	.70	1/8	54	PURPLE
54170UB		703/.0154	1/2	1.25	1.03	.14	.70	1/2	54	PURPLE
58161UB	58162UB	4/0 Weld	1/4	.78	1.25	.15	.79	1/8	62	YELLOW
58162UB		550/24 = 222 kcmil	5/16	.88	1.25	.15	.79	1/8	62	YELLOW
58163UB		133/.0399	3/8	.93	1.25	.15	.79	1/8	62	YELLOW
58165UB		259/.0286	1/2	1.25	1.25	.15	.79	1/2	62	YELLOW
58166UB		637/.0183	3/4	1.58	1.25	.15	.79	1/2	62	YELLOW

† Contact Technical Services for specific stranding listings

Tooling: pp. B76-B92 Die Selector Chart: pp. B93-B95

United States
Tel: 901.252.8000
800.816.7809
Fax: 901.252.1354

Canada
Tel: 450.347.5318
Fax: 450.347.1976

Technical Services
Tel: 888.862.3289

Thomas & Betts

www.tnb.com

Connectors for Copper Conductor

One-Hole Lugs — 90° Standard Barrel 600V to 35KV (continued)

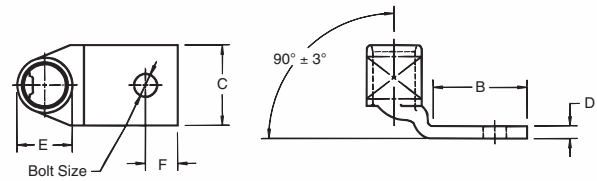

Material: High-Conductivity
Wrought Copper

Finish: Electro Tin Plate



CAT. NO.	WIRE SIZE		BOLT SIZE	DIMENSIONS (IN.)					DIE CODE	DIE COLOR
	CODE	FLEX CLASS G, H, I, K, M†		B	C	D	E	F		
54172UB	250 kcmil	250 Navy	¼	.65	1.13	.14	.77	¼	62	YELLOW
54173UB			⅝	.88	1.13	.14	.77	⅝	62	YELLOW
54174UB			¾	.93	1.13	.14	.77	¾	62	YELLOW
54113UB			1	1.25	1.13	.14	.77	1	62	YELLOW
58168UB		250 Weld, 650/24 = 262 kcmil, 259/.0311, 703/.0189	½	1.25	1.25	.15	.85	½	66	WHITE
54178UB	300 kcmil	300 Navy	⅝	.88	1.25	.15	.85	⅝	66	WHITE
54179UB			¾	.93	1.25	.15	.85	¾	66	WHITE
54114UB			1	1.25	1.25	.15	.85	1	66	WHITE
54181UB			1 ½	1.58	1.25	.15	.85	1 ½	66	WHITE
58171UB		300 Weld, 259/.034, 427/.0265, 889/.0183 775/24 = 313 kcmil	½	1.25	1.36	.18	.93	½	71	RED
256-30695-112UB	350 kcmil	350 Navy	¾	1.25	1.36	.18	.93	¾	71	RED
54115UB			1	1.25	1.36	.18	.93	1	71	RED
54183UB			1 ½	1.58	1.36	.18	.93	1 ½	71	RED
58174UB		350 Weld, 259/.0368, 427/.0285, 703/.0224, 889/.0201	½	1.25	1.61	.22	1.09	½	76	BLUE
54116UB	400 kcmil	400 Navy	¾	1.25	1.41	.17	.96	¾	76	BLUE
54185UB			1	1.58	1.41	.17	.96	1	76	BLUE
256-30695-1403UB	500 kcmil	400 Weld, 925/24 = 373 kcmil 259/.0393, 427/.0306	¾	1.31	1.61	.22	1.04	¾	80	N/A
58177UB			1	1.25	1.61	.22	1.04	1	80	N/A
54118UB	500 kcmil	500 Navy	¾	1.25	1.61	.22	1.10	¾	87	BROWN
54187UB			1	1.58	1.61	.22	1.10	1	87	BROWN
58180UB		1100/24 = 444 kcmil, 500 Weld, 259/.0417, 427/.0325, 703/.0253	¾	1.58	1.75	.24	1.20	¾	94	GREEN
54120UB	600 kcmil		¾	1.58	1.75	.24	1.20	¾	94	GREEN
54122UB	700 kcmil		¾	1.58	1.84	.23	1.26	¾	99	PINK
256-30695-840UB	750 kcmil	1325/24 = 535 kcmil 427/.0342	¾	1.69	1.81	.28	1.25	13⁄16	99	PINK
58182UB			1	1.58	1.81	.28	1.25	1	99	PINK
54123UB	750 kcmil	1600/24 = 646 kcmil	¾	1.58	1.94	.27	1.33	¾	106	BLACK
58184UB			1	1.58	1.94	.27	1.33	1	106	BLACK
54124UB	800 kcmil	800 Navy	¾	1.58	2.01	.27	1.38	¾	107	ORANGE
54126UB	900 kcmil	1925/24 = 777 kcmil	¾	1.58	2.17	.31	1.50	¾	115	YELLOW
54128UB	1000 kcmil	1000 Navy	¾	1.58	2.27	.30	1.55	¾	125	N/A

† Contact Technical Services for specific stranding listings

Tooling: pp. B76-B92

Die Selector Chart: pp. B93-B95

Connectors for Copper Conductor

Two-Hole Lugs — Standard Barrel 600V to 35KV

Material: High-Conductivity Wrought Copper

Finish: Electro Tin Plate

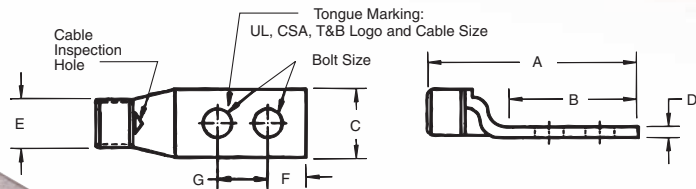

CAT. NO.	CODE	WIRE SIZE		DIMENSIONS (IN.)								DIE CODE	DIE COLOR
		FLEX CLASS G, H, I, K, M†	BOLT SIZE	A	B	C	D	E	F	G			
54201	#14-10 AWG		¼	1.86	1.19	.50	.05	.20	¼	¾	ERG2002	YELLOW	
256-30695-1302			¾	2.48	1.81	.56	.04	.22	¾	1	ERG2002	YELLOW	
54204	8 AWG		#10	1.88	1.18	.42	.08	.26	¼	¾	21	RED	
256-31426-33*			#10	1.88	1.18	.41	.06	.26	½	¾	21	RED	
256-31426-33PH		23 Navy	#10	1.88	1.18	.41	.06	.26	½	¾	21	RED	
542040410		#8 Weld	¼	2.01	1.31	.42	.08	.26	¼	¾	21	RED	
542040416		37/24 = 14.9 kcmil	¼	2.38	1.68	.42	.08	.26	¼	1	21	RED	
256-30695-1094			¼	2.50	1.81	.56	.05	.26	¼	¾	21	RED	
256-30695-251			¾	2.50	1.81	.56	.05	.26	¾	1	21	RED	
256-30695-1070			#12	1.81	1.19	.44	.11	.30	¼	½-¾	24	BLUE	
256-30695-1153	#6 AWG		#10	1.98	1.28	.44	.08	.30	¼	½	24	BLUE	
256-30695-1183			#10	1.98	1.19	.44	.08	.30	½	¾-¾	24	BLUE	
54205		30 Navy	¼	1.98	1.28	.44	.08	.30	¼	¾	24	BLUE	
256-30695-1095		#6 Weld	¼	2.13	1.31	.43	.08	.30	¼	¾	24	BLUE	
256-30695-252		61/24 = 24.6 kcmil	¼	2.38	1.63	.43	.08	.30	¼	1	24	BLUE	
256-30695-372		133/.014	¼	2.13	1.43	.43	.08	.30	¼	¾	24	BLUE	
256-30695-913			¼	2.38	1.75	.43	.08	.30	¼	1	24	BLUE	
256-30695-253			¾	2.58	1.81	.55	.08	.30	¾	1	24	BLUE	
54206	#4 AWG	40-50 Navy	¼	2.03	1.28	.52	.10	.37	¼	¾	29	GRAY	
256-30695-1184		91/24 = 36.7 kcmil	⅝	2.31	1.63	.52	.10	.37	⅝	1	29	GRAY	
256-30695-255		133/.0177, 49/.029	¾	2.56	1.81	.59	.09	.37	¾	1	29	GRAY	
54207	#2 AWG		¼	2.13	1.28	.59	.11	.41	¼	¾	33	BROWN	
256-30695-1355		60 Navy	¼	2.15	1.31	.59	.13	.41	¼	¾	33	BROWN	
256-30695-1185		125/24 = 50.4 kcmil	¼	2.38	1.53	.59	.11	.41	¼	1	33	BROWN	
256-30695-257		#4 Weld	¾	2.67	1.81	.60	.1	.41	¾	1	33	BROWN	
256-30695-1049			½	3.75	2.88	.75	.09	.41	⅝	1¼	33	BROWN	
54208	#1 AWG	75 Navy	¼	2.13	1.28	.68	.11	.47	¼	¾	37	GREEN	
256-30695-1233		150/24 = 60.5 kcmil	⅝	2.69	1.62	.69	.13	.47	½	1	37	GREEN	
256-30695-1236		175/24 = 70.6 kcmil, 133/.0223	¾	2.75	1.81	.68	.11	.47	¾	1	37	GREEN	
256-30695-329	1/0 AWG		¼	2.75	1.81	.75	.14	.52	¾	¾	42	PINK	
54255		100 Navy	⅝	2.56	1.56	.75	.14	.52	¾	¾	42	PINK	
256-30695-1234		#1 Weld	⅝	2.75	1.78	.75	.14	.52	¾	1	42	PINK	
54209		225/24 = 90.8 kcmil	¾	2.88	1.93	.75	.13	.52	¾	1	42	PINK	
256-30695-1265		133/.0254	¾	3.50	2.57	.75	.14	.52	¾	1¼	42	PINK	
256-30695-886		½	3.78	2.83	.75	.13	.52	½	1¼	42	PINK		
256-30695-1175	2/0 AWG	125 Navy	¼	2.45	1.44	.83	.14	.57	¼	¾	45	BLACK	
54261		1/0 Weld	⅝	2.70	1.63	.83	.14	.57	½	¾	45	BLACK	
256-30695-832		275/24 = 111 kcmil	⅝	2.88	1.81	.81	.14	.57	¾	1	45	BLACK	
54210		133/.0282	¾	2.93	1.93	.83	.13	.57	¾	1	45	BLACK	
54260			½	3.83	2.81	.83	.14	.57	¾	1¼	45	BLACK	
54266	3/0 AWG	150 Navy, 2/0 Weld	⅝	2.88	1.75	.94	.14	.63	½	1	50	ORANGE	
54211		325/24 = 131 kcmil	¾	2.94	1.81	.94	.14	.63	¾	1	50	ORANGE	
54265		133/.0316, 259/.0227, 427/.0177	½	3.94	2.81	.94	.14	.63	½	1¼	50	ORANGE	

† Contact Technical Services for specific stranding listings

Tooling: pp. B76-B92

Die Selector Chart: pp. B93-B95

* Blind End

Color-Keyed Compression

United States
Tel: 901.252.8000
800.816.7809
Fax: 901.252.1354

Canada
Tel: 450.347.5318
Fax: 450.347.1976

Technical Services
Tel: 888.862.3289

Thomas & Betts

www.tnb.com

Connectors for Copper Conductor

Two-Hole Lugs — Standard Barrel 600V to 35KV (continued)

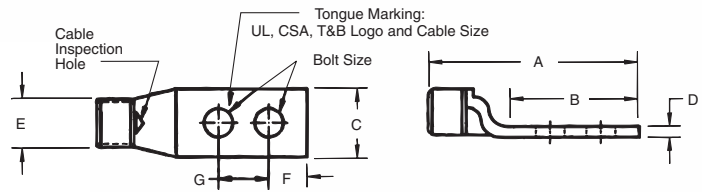

Material: High-Conductivity Wrought Copper

Finish: Electro Tin Plate



CAT. NO.	WIRE SIZE		BOLT SIZE	DIMENSIONS (IN.)								DIE CODE	DIE COLOR
	CODE	FLEX CLASS G, H, I, K, M†		A	B	C	D	E	F	G			
54212			3/8	3.18	1.93	1.03	.14	.70	3/8	1	54	PURPLE	
54270		200 Navy	1/2	4.25	3.00	1.03	.14	.70	1/2	1 1/4	54	PURPLE	
256-30695-1247	4/0 AWG	3/0 Weld	1/4	3.06	1.44	1.03	.16	.70	3/8	3/8	54	PURPLE	
256-30695-331		450/24 = 182 kcmil	1/4	3.06	1.81	1.03	.14	.70	3/8	3/8	54	PURPLE	
256-30695-1261		703/.0154	5/16	3.18	1.93	1.03	.14	.70	3/8	1	54	PURPLE	
54213		250 kcmil	3/8	3.28	1.93	1.13	.14	.77	3/8	1	62	YELLOW	
54275		250 Navy	1/2	4.19	2.81	1.13	.18	.77	1/2	1 1/4	62	YELLOW	
256-30695-345		4/0 Weld	3/8	3.25	1.69	1.25	.15	.79	3/8	7/8	62	YELLOW	
256-30695-835		550/24 = 222 kcmil	3/8	4.25	2.80	1.25	.15	.79	3/8	1	62	YELLOW	
256-30695-452		133/.0399	3/8	3.13	1.88	1.25	.16	.79	3/8	7/8	62	YELLOW	
58265		259/.0286, 637/.018	1/2	3.94	2.81	.94	.14	.79	1/2	1 1/4	62	YELLOW	
54214		300 kcmil	3/8	3.45	1.93	1.25	.15	.85	3/8	1	66	WHITE	
54280		300 Navy	1/2	4.45	3.00	1.25	.15	.85	1/2	1 1/4	66	WHITE	
256-30695-332			1/4	3.40	1.81	1.36	.18	.93	3/8	3/4	71	RED	
256-30695-1240			5/16	4.18	2.63	1.36	.18	.93	3/8	1 1/4	71	RED	
54215		350 kcmil	3/8	3.51	1.93	1.36	.18	.93	3/8	1	71	RED	
54282		350 Navy	1/2	4.60	3.00	1.36	.18	.93	1/2	1 1/4	71	RED	
54216		400 kcmil	3/8	3.93	1.93	1.41	.17	.96	3/8	1	76	BLUE	
54283			3/8	3.88	1.93	1.41	.17	.96	3/8	1 1/8	76	BLUE	
256-30695-439		400 Weld	3/8	4.35	2.25	1.61	.22	1.04	3/8	1	80	N/A	
58277		925/24 = 373 kcmil	1/2	5.06	3.00	1.61	.22	1.04	1/2	1 1/4	80	N/A	
256-30695-839		259/.0393, 427/.0306	3/8	4.09	2.06	1.61	.22	1.04	3/8	1	80	N/A	
54218			3/8	3.96	1.93	1.61	.22	1.10	3/8	1	87	BROWN	
54286		500 kcmil	1/2	5.07	3.00	1.61	.22	1.10	1/2	1 1/4	87	BROWN	
256-30695-188		500 Navy	1/2	4.06	2.31	1.63	.22	1.10	3/8	1 1/4	87	BROWN	
54220			3/8	4.13	1.93	1.75	.24	1.20	3/8	1	94	GREEN	
54289		600 kcmil	1/2	5.23	3.00	1.75	.24	1.20	1/2	1 1/4	94	GREEN	
256-30695-1406			3/8	4.05	2.11	1.78	.24	1.25	3/8	1	99	PINK	
256-30695-842			3/8	4.30	2.06	1.80	.28	1.25	3/8	1	99	PINK	
256-30695-898		700 kcmil	3/8	4.30	2.06	1.80	.28	1.25	3/8	1	99	PINK	
54291			1/2	5.18	3.00	1.84	.23	1.25	1/2	1 1/4	99	PINK	
58281		535, 1325/24	1/2	5.23	3.00	1.80	.28	1.25	3/8	1 1/4	99	PINK	
256-30695-237			3/8	5.10	2.80	1.94	.27	1.33	3/8	1	106	BLACK	
54223		750 kcmil	1/2	5.32	3.00	1.94	.27	1.33	1/2	1 1/4	106	BLACK	
256-30695-1376			3/8	4.78	2.28	2.01	.27	1.38	7/16	1 1/8	107	ORANGE	
54224		800 kcmil	1/2	5.50	3.00	2.01	.27	1.38	1/2	1 1/4	107	ORANGE	
256-30695-694			3/8	4.65	2.06	2.18	.31	1.50	3/8	1	115	YELLOW	
54226			1/2	5.59	3.00	2.18	.31	1.50	1/2	1 1/4	115	YELLOW	
256-30695-846		900 kcmil	3/8	4.60	2.06	2.12	.31	1.50	3/8	1	115	YELLOW	
256-30695-844		1925/24 = 777 kcmil	3/8	5.00	2.63	2.18	.31	1.50	3/8	1 1/2	115	YELLOW	
54228		1000 kcmil	1/2	5.45	3.00	2.27	.30	1.55	1/2	1 1/4	125	N/A	

† Contact Technical Services for specific stranding listings

Tooling: pp. B76-B92 Die Selector Chart: pp. B93-B95

Connectors for Copper Conductor

Two-Hole Lugs — 45° Standard Barrel 600V to 35KV

Material: High-Conductivity
Wrought Copper

Finish: Electro Tin Plate

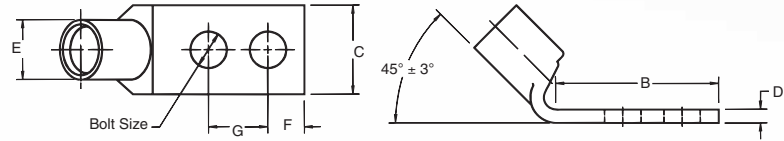

CAT. NO.	WIRE SIZE			DIMENSIONS (IN.)						DIE CODE	DIE COLOR	
	CODE	FLEX CLASS G, H, I, K, M†	BOLT SIZE	B	C	D	E	F	G			
256-31426-9	#14-10 AWG		#10	1.22	.37	.05	.200	¼	⅝	N/A	N/A	
54204UF	#8 AWG	23 Navy	#8 Weld	#10	1.18	.42	.08	.26	¼	⅝	21	RED
		37/24 = 14.9 kcmil										
256-30695-1183UF	#6 AWG	30 Navy, #6 Weld	#6 Weld	#10	1.19	.44	.08	.30	⅜	⅝-¾	24	BLUE
54205UF		61/24 = 24.6 kcmil										
54205UF0416		133/.014		¼	1.56	.43	.08	.30	¼	1	24	BLUE
54206UF	#4 AWG	40-50 Navy	#4 Weld	¼	1.28	.52	.10	.37	¼	⅝	29	GRAY
		91/24 = 36.7 kcmil										
54207UF		133/.0177, 49/.029		¼	1.28	.59	.11	.41	¼	⅝	33	BROWN
256-30695-257UF	#2 AWG	60 Navy, #4 Weld	#2 Weld	⅝	1.81	.60	.1?	.41	⅝	1	33	BROWN
54208UF		125/24 = 50.4 kcmil										
54208UF	#1 AWG	75 Navy	#1 Weld	¼	1.28	.68	.11	.47	¼	⅝	37	GREEN
		150/24 = 60.5 kcmil										
54209UF		175/24 = 70.6 kcmil, 133/.0223		¼	1.93	.75	.13	.52	⅝	1	42	PINK
54209UF0412	1/0 AWG	100 Navy	#1 Weld	¼	1.55	.75	.13	.52	¼	⅜	42	PINK
54261UF	2/0 AWG	225/24 = 90.8 kcmil	#2 Weld	¼	1.63	.83	.14	.57	⅝	⅞	45	BLACK
54210UF		133/.0254										
54260UF		125 Navy, 1/0 Weld	#2 Weld	¼	1.93	.83	.13	.57	⅝	1	45	BLACK
54266UF	3/0 AWG	275/24 = 111 kcmil	#3 Weld	½	2.81	.83	.14	.57	⅝	1 ¼	45	BLACK
		133/.0282										
54266UF		150 Navy, 2/0 Weld	#3 Weld	½	1.75	.94	.14	.63	⅝	1	50	ORANGE
54211UF		325/24 = 131 kcmil	#3 Weld	½	1.81	.94	.14	.63	⅝	1	50	ORANGE
54265UF		133/.0316	#3 Weld	½	2.81	.94	.14	.63	⅝	1 ¼	50	ORANGE
		259/.0227	#3 Weld	½	2.81	.94	.14	.63	⅝	1 ¼	50	ORANGE
		427/.0177	#3 Weld	½	1.93	1.03	.14	.70	⅝	1	54	PURPLE
54212UF	4/0 AWG	200 Navy	#3 Weld	½	3.00	1.03	.14	.70	½	1 ¼	54	PURPLE
54270UF		450/24 = 182 kcmil	#3 Weld	½	1.93	1.13	.14	.77	⅝	1	62	YELLOW
54213UF		703/.0154	#3 Weld	½	2.81	1.13	.18	.77	½	1 ¼	62	YELLOW
54275UF	250 kcmil	250 Navy	#3 Weld	½	2.80	1.25	.15	.79	⅝	1	62	YELLOW
256-30695-399UF		4/0 Weld	#3 Weld	½	2.81	.94	.14	.79	⅝	1 ¼	62	YELLOW
58265UF		550/24 = 222 kcmil	#3 Weld	½	2.81	.94	.14	.79	⅝	1 ¼	62	YELLOW
		133/.0399, 259/.0286	#3 Weld	½	2.81	.94	.14	.79	⅝	1 ¼	62	YELLOW
		637/.018	#3 Weld	½	2.81	.94	.14	.79	⅝	1 ¼	62	YELLOW

† Contact Technical Services for specific stranding listings

Tooling: pp. B76–B92

Die Selector Chart: pp. B93–B95

Color-Keyed Compression

Connectors for Copper Conductor

Two-Hole Lugs — 45° Standard Barrel

600V to 35KV
(continued)

Material: High-Conductivity Wrought Copper

Finish: Electro Tin Plate

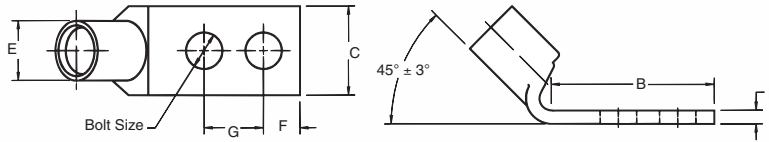

CAT. NO.	WIRE SIZE			DIMENSIONS (IN.)						DIE CODE	DIE COLOR
	CODE	FLEX CLASS G, H, I, K, M†	BOLT SIZE	B	C	D	E	F	G		
54214UF	300 kcmil	300 Navy	3/8	1.93	1.25	.15	.85	3/8	1	66	WHITE
54280UF			1/2	3.00	1.25	.15	.85	1/2	1 1/4	66	WHITE
54215UF	350 kcmil	350 Navy	3/8	1.93	1.36	.18	.93	3/8	1	71	RED
54282UF			1/2	3.00	1.36	.18	.93	1/2	1 1/4	71	RED
54216UF	400 kcmil		3/8	1.93	1.41	.17	.96	3/8	1	76	BLUE
54283UF			1/2	1.93	1.41	.17	.96	3/8	1 1/16	76	BLUE
58277UF		400 Weld 925/24 = 373 kcmil 259/.0393, 427/.0306	1/2	3.00	1.61	.22	1.04	1/2	1 1/4	80	N/A
54218UF	500 kcmil	500 Navy	3/8	1.93	1.61	.22	1.10	3/8	1	87	BROWN
54286UF			1/2	3.00	1.61	.22	1.10	1/2	1 1/4	87	BROWN
54220UF	600 kcmil	1100/24 = 444 kcmil	3/8	1.93	1.75	.24	1.20	3/8	1	94	GREEN
54289UF			1/2	3.00	1.75	.24	1.20	1/2	1 1/4	94	GREEN
54291UF	700 kcmil	1325/24 = 535 kcmil	1/2	3.00	1.84	.23	1.25	1/2	1 1/4	99	PINK
58281UF			1/2	3.00	1.8	.28	1.25	1/2	1 1/4	99	PINK
256-30695-237UF	750 kcmil		3/8	2.80	1.94	.27	1.33	3/8	1	106	BLACK
54223UF			1/2	3.00	1.94	.27	1.33	1/2	1 1/4	106	BLACK
54224UF	800 kcmil		1/2	3.00	2.01	.27	1.38	1/2	1 1/4	106	BLACK
54226UF	900 kcmil	1925/24 = 777 kcmil	1/2	3.00	2.18	.31	1.50	1/2	1 1/4	115	YELLOW
54228UF	1000 kcmil	1000 Navy	1/2	3.00	2.27	.30	1.55	1/2	1 1/4	125	N/A

† Contact Technical Services for specific stranding listings

Tooling: pp. B76-B92

Die Selector Chart: pp. B93-B95

NOTE: Angled Lugs can be readily available as: 15°, 30°, 45°, 60°, and 90°

Connectors for Copper Conductor

Two-Hole Lugs — 90° Standard Barrel 600V to 35KV Applications

Material: High-Conductivity Wrought Copper

Finish: Electro Tin Plate

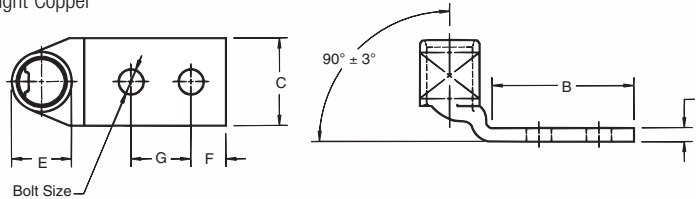

Color-Keyed Compression

CAT. NO.	CODE	WIRE SIZE		DIMENSIONS (IN.)						DIE CODE	DIE COLOR	
		FLEX CLASS	G, H, I, K, M†	BOLT SIZE	B	C	D	E	F			G
256-31426-141	#14-10 AWG			#10	1.25	.37	.07	.20	7/32	3/8	ERG2002	YELLOW
256-31426-6SPH				#10	1.30	.37	.07	.20	7/32	5/8-3/4	ERG2002	YELLOW
256-31426-6				#10	1.30	.37	.07	.20	7/32	3/8	ERG2002	YELLOW
256-31426-6S				#10	1.30	.37	.07	.20	7/32	5/8-3/4	ERG2002	YELLOW
256-30695-1409	#8 AWG			#10	1.19	.41	.06	.26	7/32	5/8-3/4	21	RED
54204UB		23 Navy, #8 Weld	#10	1.25	.42	.08	.26	1/4	3/8	21	RED	
256-31426-33UB*		37/24 = 14.9 kcmil	#10	1.19	.41	.06	.26	7/32	5/8-3/4	21	RED	
256-31426-33UBPH			#10	1.19	.41	.06	.26	7/32	5/8-3/4	21	RED	
256-30695-1411	#6 AWG			#10	1.19	.44	.08	.30	7/32	5/8-3/4	24	BLUE
256-30695-1183B		30 Navy	#10	1.19	.44	.08	.30	7/32	5/8-3/4	24	BLUE	
256-30695-1356		#6 Weld	#10	1.19	.43	.08	.30	7/32	3/8	24	BLUE	
54205UB		133/.014	1/4	1.28	.44	.08	.30	1/4	3/8	24	BLUE	
256-30695-252UB		1/4	1.56	.43	.08	.30	1/4	1	24	BLUE		
54206UB	#4 AWG	40-50 Navy 91/24 = 36.7 kcmil 133/.0177, 49/.029	1/4	1.28	.52	.10	.37	1/4	3/8	29	GRAY	
54207UB	#2 AWG	60 Navy #4 Weld 125/24 = 50.4 kcmil	1/4	1.28	.59	.11	.41	1/4	3/8	33	BROWN	
54208UB	#1 AWG	75 Navy 150/24 = 60.5 kcmil 175/24 = 70.6 kcmil, 133/.0223	1/4	1.28	.68	.11	.47	1/4	3/8	37	GREEN	
54209UB	1/0 AWG	100 Navy, #1 Weld										
54209UB0412		225/24 = 90.8 kcmil, 133/.0254	3/8	1.93	.75	.13	.52	3/8	1	42	PINK	
54261UB	2/0 AWG	225/24 = 90.8 kcmil, 133/.0254	1/4	1.55	.75	.13	.52	1/4	3/4	42	PINK	
54210UB		125 Navy, 1/0 Weld	5/16	1.63	.83	.14	.57	1/2	3/8	45	BLACK	
54260UB		275/24 = 111 kcmil	3/8	1.93	.83	.13	.57	3/8	1	45	BLACK	
54266UB		133/.0282	1/2	2.81	.83	.14	.57	3/8	1 1/4	45	BLACK	
54211UB	3/0 AWG	150 Navy, 2/0 Weld	5/16	1.75	.94	.14	.63	1/2	1	50	ORANGE	
54265UB		325/24 = 131 kcmil	3/8	1.81	.94	.14	.63	3/8	1	50	ORANGE	
54212UB	4/0 AWG	133/.0316, 259/.0227, 427/.0177	1/2	2.81	.94	.14	.63	3/8	1 1/4	50	ORANGE	
54270UB		200 Navy, 3/0 Weld	3/8	1.93	1.03	.14	.70	3/8	1	54	PURPLE	
54213UB	250 kcmil	450/24 = 182 kcmil, 703/.0154	1/2	3.00	1.03	.14	.70	1/2	1 1/4	54	PURPLE	
54275UB		250 Navy	3/8	1.93	1.13	.14	.77	3/8	1	62	YELLOW	
256-30695-399UB		4/0 Weld, 550/24 = 222 kcmil	3/8	2.80	1.25	.15	.79	3/8	1	62	YELLOW	
58265UB		133/.0399, 259/.0286, 637/.018	1/2	2.81	.94	.14	.79	1/2	1 1/4	62	YELLOW	

† Contact Technical Services for specific stranding listings

Tooling: pp. B76-B92

Die Selector Chart: pp. B93-B95

* Blind End

Connectors for Copper Conductor

Two-Hole Lugs — 90° Standard Barrel 600V to 35KV Applications (continued)

Material: High-Conductivity Wrought Copper

Finish: Electro Tin Plate

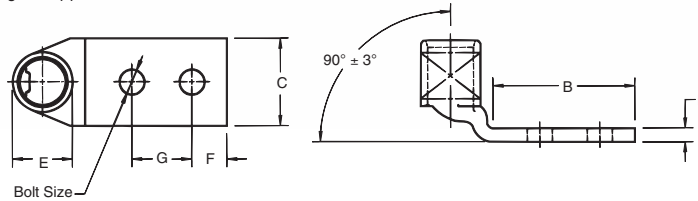

CAT. NO.	CODE	WIRE SIZE		DIMENSIONS (IN.)							DIE CODE	DIE COLOR
		FLEX CLASS G, H, I, K, M†	BOLT SIZE	B	C	D	E	F	G			
54214UB			3/8	1.93	1.25	.15	.85	3/8	1	66	WHITE	
54280UB	300 kcmil	300 Navy	1/2	3.00	1.25	.15	.85	1/2	1 1/4	66	WHITE	
54215UB			3/8	1.93	1.36	.18	.93	3/8	1	71	RED	
54282UB	350 kcmil	350 Navy	1/2	3.00	1.36	.18	.93	1/2	1 1/4	71	RED	
54216UB			3/8	1.93	1.41	.17	.96	3/8	1	76	BLUE	
54283UB	400 kcmil		3/8	1.93	1.41	.17	.96	3/8	1 1/6	76	BLUE	
58277UB		400 Weld, 925/24 = 373 kcmil 259/.0393, 427/.0306	1/2	3.00	1.61	.22	1.04	1/2	1 1/4	80	N/A	
54218UB	500 kcmil	500 Navy	3/8	1.93	1.61	.22	1.10	3/8	1	87	BROWN	
54286UB			1/2	3.00	1.61	.22	1.10	1/2	1 1/4	87	BROWN	
256-30695-1221B			3/8		1.61	.22	1.10	3/8	1	87	BROWN	
54220UB	600 kcmil	1100/24 = 444 kcmil	3/8	1.93	1.75	.24	1.20	3/8	1	94	GREEN	
54289UB			1/2	3.00	1.75	.24	1.20	1/2	1 1/4	94	GREEN	
54291UB	700 kcmil	1325/24 = 535 kcmil	1/2	3.00	1.84	.23	1.25	1/2	1 1/4	99	PINK	
58281UB			1/2	3.00	1.80	.28	1.25	1/2	1 1/4	99	PINK	
54223UB	750 kcmil		1/2	3.00	1.94	.27	1.33	1/2	1 1/4	106	BLACK	
54224UB	800 kcmil		1/2	3.00	2.01	.27	1.38	1/2	1 1/4	106	BLACK	
54226UB	900 kcmil	1925/24 = 777 kcmil	1/2	3.00	2.18	.31	1.50	1/2	1 1/4	115	YELLOW	
54228UB	1000 kcmil	1000 Navy	1/2	3.00	2.27	.30	1.55	1/2	1 1/4	125	N/A	

† Contact Technical Services for specific stranding listings

Tooling: pp. B76–B92

Die Selector Chart: pp. B93–B95

Connectors for Copper Conductor

Ideal for confined-space terminations.

Narrow-Tongue Lugs — One-Hole, Standard Barrel 600V Applications

To meet increasing demand for smaller components in today's panels and switchgear, Thomas & Betts introduces a new line of Color-Keyed® Narrow-Tongue Lugs. These improved lugs have been precision engineered for consistency in width the entire length of the connector, from barrel to tongue, ensuring a reliable fit in confined-space applications.

- Narrow-width tongue and barrel, engineered for dimensional consistency the entire length of the lug
- Perfect for connections in limited-space applications
- High-conductivity copper alloy construction
- Electro-tin-plated finish resists corrosion
- T&B Color-Keyed® marking system makes connections and verification easy
- Double-chamfered barrel eases insertion of wire
- Available in one-hole versions now — two-hole and angled lugs coming soon

..... **Specifications**

- Material: 99% pure high conductivity seamless wrought copper
- Finish: Electro-tin plated
- Standards: UL Listed, CSA Certified, RoHS compliant

NEW!

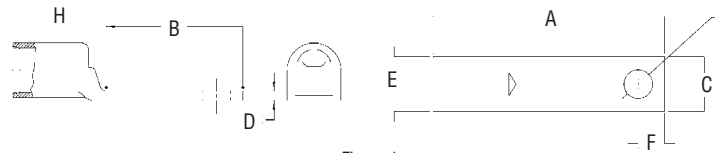

Figure 1

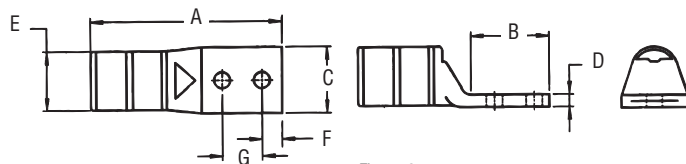

Figure 2



CAT. NO.	CODE	WIRE SIZE FLEX CLASS G, H, I, K, M†	BOLT SIZE	DIMENSIONS (IN.)						DIE CODE	STD. PKG. QTY.	DIE COLOR
				A	B	C	D	E	F			
54138NT	#4 AWG	91/24	#10	1.312	.562	.365	.099	.365	.250	29	50/500	GRAY
54107NT	#2-3 AWG	125/24	¼	1.500	.650	.410	.070	.410	.250	33	25/250	BROWN
54108NT	#1 AWG	150,175/24	¼	1.500	.650	.467	.106	.467	.250	37	20/200	GREEN
54152NT	1/0 AWG	225/24	¼	1.600	.650	.521	.125	.521	.250	42	10/100	PINK
54157NT	2/0 AWG	275/24	¼	1.600	.650	.571	.125	.571	.250	45	10/100	BLACK
54162NT	3/0 AWG	325/24	¼	1.680	.650	.632	.125	.632	.250	50	10/100	ORANGE
54167NT	4/0 AWG	450/24	¼	1.900	.650	.701	.137	.701	.250	54	10/100	PURPLE
54172NT	250 kcmil	550/24	¼	2.000	.650	.766	.140	.766	.250	62	10/100	YELLOW
54178NT04	300 kcmil	775/24	¼	2.325	.875	.850	.153	.850	.250	66	10/100	WHITE
54115NT	350 kcmil	—	½	2.750	1.250	.926	.177	.926	.500	71	10/100	RED
54115NT06	350 kcmil	—	¾	2.500	1.000	.926	.177	.926	.375	71	10/100	RED
54118NT	500 kcmil	925/24	½	3.250	1.250	1.100	.218	1.100	.500	87	6/60	BROWN
54123NT08	750 kcmil	1325/24	½	3.475	1.250	1.330	.270	1.330	.500	106	6/60	BLACK
54123NT	750 kcmil	1325/24	¾	3.800	1.575	1.330	.270	1.330	.625	106	6/60	BLACK
54879NT	750 kcmil	—	¾	5.00	2.02	1.66	.27	1.33	½	1	106	BLACK
58825NT	900 kcmil	—	¾	5.00	2.13	1.66	.31	1.50	½	1	115	YELLOW
58825NT0828	900 kcmil	1925/24 = 777 kcmil	¾	5.75	2.88	1.66	.31	1.50	½	1½	115	YELLOW

† Contact Technical Services for specific stranding listings

Tooling: pp. B76-B92 Die Selector Chart: pp. B93-B95

United States
Tel: 901.252.8000
800.816.7809
Fax: 901.252.1354

Canada
Tel: 450.347.5318
Fax: 450.347.1976

Technical Services
Tel: 888.862.3289

Thomas & Betts

www.tnb.com

Connectors for Copper Conductor

One-Hole Lugs — Long Barrel 600V to 35KV

Material: High-Conductivity
Wrought Copper

Finish: Electro Tin Plate

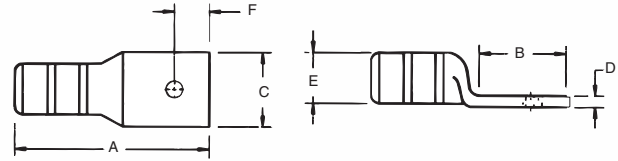

Peep Holes Available!
Add suffix **-PH**



Color-Keyed® Compression

CAT. NO.	CODE	WIRE SIZE		DIMENSIONS (IN.)						DIE CODE	DIE COLOR
		FLEX CLASS G, H, I, K, M†	BOLT SIZE	A	B	C	D	E	F		
54901BE	#14-10 AWG		¼	1.23	.56	.50	.05	.20	¼	ERG2002	N/A
54929BE			#10	1.65	.65	.42	.08	.26	¼	21	RED
54930BE	#8 AWG	37/24 = 14.9 kcmil	¼	1.65	.65	.42	.08	.26	¼	21	RED
54904BE	#6 AWG	61/24 = 24.6 kcmil	#10	1.65	.65	.44	.08	.30	¼	24	BLUE
54905BE			¼	1.65	.65	.44	.08	.30	¼	24	BLUE
54908BE			#10	1.70	.65	.52	.10	.37	¼	29	GRAY
54906BE	#4 AWG	91/24 = 36.7 kcmil	¼	1.70	.65	.52	.10	.37	¼	29	GRAY
54933BE	#2-3 AWG	125/24 = 50.4 kcmil	#10	1.88	.65	.59	.11	.41	¼	33	BROWN
54942BE			⅝	2.03	.88	.59	.11	.41	⅝	33	BROWN
54945BE			#10	1.95	.65	.68	.11	.47	¼	37	GREEN
54947BE	#1 AWG	150/24 = 60.5 kcmil	⅝	2.18	.88	.68	.11	.47	⅝	37	GREEN
54946BE			#10	1.95	.65	.75	.13	.52	¼	42	PINK
54949BE			⅝	2.18	.88	.75	.13	.52	⅝	42	PINK
54909BE	1/0 AWG	225/24 = 90.8 kcmil	¾	2.23	.93	.75	.13	.52	¾	42	PINK
54950BE			½	2.55	1.25	.75	.13	.52	½	42	PINK
54910BE			¾	2.28	.93	.83	.13	.57	¾	45	BLACK
54951BE	2/0 AWG	275/24 = 111 kcmil	¾	2.60	1.25	.83	.13	.57	¾	45	BLACK
54965BE	3/0 AWG	325/24 = 131 kcmil	½	2.70	1.25	.92	.13	.63	½	50	ORANGE
256-30695-1252			¼	2.35	.65	1.03	.14	.70	¼	54	PURPLE
256-30695-1253	4/0 AWG	450/24 = 182 kcmil	¾	2.95	1.25	1.03	.14	.70	¾	54	PURPLE
54970BE		3/0 Weld	¾	2.95	1.25	1.03	.14	.70	¾	54	PURPLE
54913BE	250 kcmil	550/24 = 222 kcmil, 4/0 Weld	½	3.15	1.25	1.13	.14	.77	½	62	YELLOW
54914BE	300 kcmil	250	½	3.50	1.25	1.25	.15	.85	½	66	WHITE
54915BE	350 kcmil	650/24 = 262 kcmil	½	3.68	1.25	1.36	.18	.93	½	71	RED
54916BE			½	3.75	1.25	1.41	.17	.96	½	76	BLUE
54917BE	400 kcmil	775/24 = 313 kcmil	¾	4.03	1.58	1.41	.17	.96	¾	76	BLUE
54918BE	500 kcmil	925/24 = 373 kcmil	½	4.25	1.25	1.61	.22	1.10	½	87	BROWN
54919BE			¾	4.57	1.58	1.61	.22	1.10	¾	87	BROWN
54921BE			¾	4.10	1.25	1.75	.24	1.20	¾	94	GREEN
54920BE	600 kcmil	1100/24 = 444 kcmil	¾	4.39	1.58	1.75	.24	1.20	¾	94	GREEN
54979BE		1325/24 = 535 kcmil	½	4.40	1.25	1.80	.24	1.25	½	99	PINK
54922BE	750 kcmil	1325/24 = 535 kcmil	¾	4.40	1.25	1.94	.27	1.33	¾	106	BLACK
54923BE			¾	4.72	1.58	1.94	.27	1.33	¾	106	BLACK
58984BE		1600/24 = 646 kcmil	¾	4.73	1.58	1.94	.27	1.33	¾	106	BLACK
58926BE	900 kcmil	1925/24 = 777 kcmil	¾	5.23	1.58	2.17	.310	1.50	¾	115	YELLOW
54928BE			¾	5.24	1.58	2.27	.30	1.55	¾	125	N/A
256-30695-918	1000 kcmil		¾	5.42	1.82	2.37	.30	1.55	¾	125	N/A

† Contact Technical Services for specific stranding listings

Tooling: pp. B76-B92

Die Selector Chart: pp. B93-B95

Connectors for Copper Conductor

One-Hole Lugs — 45° Long Barrel 600V to 35KV

Material: High-Conductivity
Wrought Copper

Finish: Electro Tin Plate

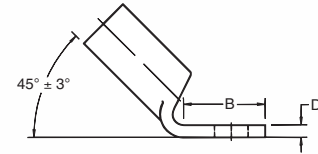
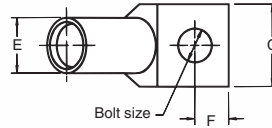

Peep Holes Available!
Add suffix -PH



Color-Keyed Compression

CAT. NO.	WIRE SIZE			DIMENSIONS (IN.)					DIE CODE	DIE COLOR
	CODE	FLEX CLASS G, H, I, K, M†	BOLT SIZE	B	C	D	E	F		
54929BEUF			#10	.65	.42	.08	.26	¼	21	RED
54930BEUF	#8 AWG	37/24 = 14.9 kcmil	¼	.65	.42	.08	.26	¼	21	RED
54904BEUF	#6 AWG	61/24 = 24.6 kcmil	#10	.65	.44	.08	.30	¼	24	BLUE
54905BEUF			¼	.65	.44	.08	.30	¼	24	BLUE
54908BEUF			#10	.65	.52	.10	.37	¼	29	GRAY
54906BEUF	#4 AWG	91/24 = 36.7 kcmil	¼	.65	.52	.10	.37	¼	29	GRAY
54933BEUF	#2-3 AWG	125/24 = 50.4 kcmil	#10	.65	.59	.11	.41	¼	33	BROWN
54942BEUF			⅝	.88	.59	.11	.41	⅝	33	BROWN
54945BEUF			#10	.65	.68	.11	.47	¼	37	GREEN
54947BEUF	#1 AWG	150/24 = 60.5 kcmil	⅝	.88	.68	.11	.47	⅝	37	GREEN
54946BEUF			#10	.65	.75	.13	.52	¼	42	PINK
54949BEUF			⅝	.88	.75	.13	.52	⅝	42	PINK
54909BEUF	1/0 AWG	225/24 = 90.8 kcmil	⅝	.93	.75	.13	.52	⅝	42	PINK
54950BEUF			½	1.25	.75	.13	.52	½	42	PINK
54910BEUF			⅝	.93	.83	.13	.57	⅝	45	BLACK
54951BEUF	2/0 AWG	275/24 = 111 kcmil	½	1.25	.83	.13	.57	½	45	BLACK
54965BEUF	3/0 AWG	325/24 = 131 kcmil	½	1.25	.92	.13	.63	½	50	ORANGE
54970BEUF04			¼	1.00	1.03	.14	.70	¼	54	PURPLE
54970BEUF06	4/0 AWG	450/24 = 182 kcmil	⅝	1.13	1.03	.14	.70	⅝	54	PURPLE
54970BEUF		3/0 Weld	½	1.25	1.03	.14	.70	½	54	PURPLE
54913BEUF	250 kcmil	550/24 = 222 kcmil, 4/0 Weld	½	1.25	1.13	.14	.77	½	62	YELLOW
54914BEUF	300 kcmil	250	½	1.25	1.25	.15	.85	½	66	WHITE
54915BEUF	350 kcmil	650/24 = 262 kcmil	½	1.25	1.36	.18	.93	½	71	RED
54916BEUF			½	1.25	1.41	.17	.96	½	76	BLUE
54917BEUF	400 kcmil	775/24 = 313 kcmil	⅝	1.58	1.41	.17	.96	⅝	76	BLUE
54918BEUF	500 kcmil	925/24 = 373 kcmil	½	1.25	1.61	.22	1.10	½	87	BROWN
54919BEUF			⅝	1.58	1.61	.22	1.10	⅝	87	BROWN
54921BEUF			½	1.25	1.75	.24	1.20	½	94	GREEN
54920BEUF	600 kcmil	1100/24 = 444 kcmil	⅝	1.58	1.75	.24	1.20	⅝	94	GREEN
54922BEUF	750 kcmil	1325/24 = 535 kcmil	½	1.25	1.94	.27	1.33	½	106	BLACK
54923BEUF			⅝	1.58	1.94	.27	1.33	⅝	106	BLACK
58984BEUF		1600/24 = 646 kcmil	⅝	1.58	1.94	.27	1.33	⅝	106	BLACK
58926BEUF	900 kcmil	1925/24 = 777 kcmil	⅝	1.58	2.17	.31	1.50	⅝	115	YELLOW
54928BEUF			⅝	1.58	2.27	.30	1.55	⅝	125	N/A
54928BEUF12	1000 kcmil		⅝	1.83	2.37	.30	1.55	⅝	125	N/A

† Contact Technical Services for specific stranding listings

Tooling: pp. B76–B92

Die Selector Chart: pp. B93–B95

Connectors for Copper Conductor

One-Hole Lugs — 90° Long Barrel 600V to 35KV

Material: High-Conductivity
Wrought Copper

Finish: Electro Tin Plate

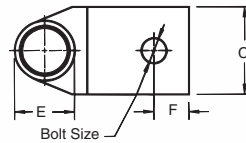

Peep Holes Available!
Add suffix -PH

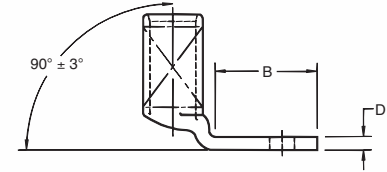

Color-Keyed® Compression

CAT. NO.	CODE	WIRE SIZE		DIMENSIONS (IN.)					DIE CODE	DIE COLOR	
		FLEX CLASS	G, H, I, K, M†	BOLT SIZE	B	C	D	E			F
549298EUB				#10	.65	.42	.08	.26	¼	21	RED
549308EUB	#8 AWG	37/24 = 14.9	kcmil	¼	.65	.42	.08	.26	¼	21	RED
549048EUB	#6 AWG	61/24 = 24.6	kcmil	#10	.65	.44	.08	.30	¼	24	BLUE
549058EUB				¼	.65	.44	.08	.30	¼	24	BLUE
549088EUB				#10	.65	.52	.10	.37	¼	29	GRAY
549068EUB	#4 AWG	91/24 = 36.7	kcmil	¼	.65	.52	.10	.37	¼	29	GRAY
549338EUB	#2-3 AWG	125/24 = 50.4	kcmil	#10	.65	.59	.11	.41	¼	33	BROWN
549428EUB				⅝	.88	.59	.11	.41	⅝	33	BROWN
549458EUB				#10	.65	.68	.11	.47	¼	37	GREEN
549478EUB	#1 AWG	150/24 = 60.5	kcmil	⅝	.88	.68	.11	.47	⅝	37	GREEN
549468EUB				#10	.65	.75	.13	.52	¼	42	PINK
549498EUB	1/0 AWG	225/24 = 90.8	kcmil	⅝	.88	.75	.13	.52	⅝	42	PINK
549098EUB				¾	.93	.75	.13	.52	¾	42	PINK
549508EUB				½	1.25	.75	.13	.52	½	42	PINK
549108EUB				¾	.93	.83	.13	.57	¾	45	BLACK
549518EUB	2/0 AWG	275/24 = 111	kcmil	½	1.25	.83	.13	.57	½	45	BLACK
549658EUB	3/0 AWG	325/24 = 131	kcmil	½	1.25	.92	.13	.63	½	50	ORANGE
549708EUB04				¼	1.00	1.03	.14	.70	¼	54	BLACK
549708EUB06	4/0 AWG	450/24 = 182	kcmil	¾	1.13	1.03	.14	.70	¾	54	BLACK
549708EUB		3/0 Weld		½	1.25	1.03	.14	.70	½	54	BLACK
549138EUB	250 kcmil	550/24 = 222	kcmil, 4/0 Weld	½	1.25	1.13	.14	.77	½	62	YELLOW
549148EUB	300 kcmil	250		½	1.25	1.25	.15	.85	½	66	WHITE
549158EUB	350 kcmil	650/24 = 262	kcmil	½	1.25	1.36	.18	.93	½	71	RED
549168EUB				½	1.25	1.41	.17	.96	½	76	BLUE
549178EUB	400 kcmil	775/24 = 313	kcmil	¾	1.58	1.41	.17	.96	¾	76	BLUE
549188EUB	500 kcmil	925/24 = 373	kcmil	½	1.25	1.61	.22	1.10	½	87	BROWN
549198EUB				¾	1.58	1.61	.22	1.10	¾	87	BROWN
549218EUB				½	1.25	1.75	.24	1.20	½	94	GREEN
549208EUB	600 kcmil	1100/24 = 444	kcmil	¾	1.58	1.75	.24	1.20	¾	94	GREEN
549228EUB	750 kcmil	1325/24 = 535	kcmil	½	1.25	1.94	.27	1.33	½	106	BLACK
549238EUB				¾	1.58	1.94	.27	1.33	¾	106	BLACK
589848EUB		1600/24 = 646	kcmil	¾	1.58	1.94	.27	1.33	¾	106	BLACK
589268EUB	900 kcmil	1925/24 = 777	kcmil	¾	1.58	2.17	.31	1.50	¾	115	YELLOW
549288EUB				¾	1.58	2.27	.30	1.55	¾	125	N/A
549288EUB12	1000 kcmil			¾	1.83	2.37	.30	1.55	¾	125	N/A

† Contact Technical Services for specific stranding listings

Tooling: pp. B76-B92

Die Selector Chart: pp. B93-B95

Connectors for Copper Conductor

Two-Hole Lugs — Long Barrel 600V to 35KV

Material: High-Conductivity
Wrought Copper

Finish: Electro Tin Plate

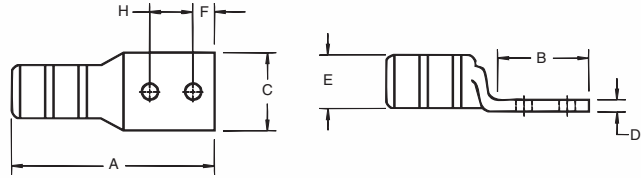

Peep Holes Available!
Add suffix -PH



Color-Keyed Compression

CAT. NO.	WIRE SIZE			DIMENSIONS (IN.)								DIE CODE	DIE COLOR
	CODE	FLEX CLASS	G, H, I, K, M†	BOLT SIZE	A	B	C	D	E	F	H		
54801BE	#14-10 AWG			¼	1.86	1.19	.50	.05	.20	¼	¾	ERG2002	YELLOW
256-31426-3	#14-10 AWG			#10	2.00	1.25	.37	.07	.20	¼	¾	ERG2002	YELLOW
256-31426-3SPH	#14-10 AWG			#10	2.00	1.25	.37	.07	.20	½	¾	ERG2002	YELLOW
256-30695-1298	#14-10 AWG			¼	1.89	1.22	.50	.05	.20	¼	¾	ERG2002	YELLOW
256-30695-1730	#14-10 AWG			¼	1.98	1.31	.50	.05	.20	¼	¾	ERG2002	YELLOW
54850BE	#8 AWG	37/24 = 14.9 kcmil		¼	2.19	1.89	.42	.07	.26	¼	¾	21	RED
54851BE	#8 AWG	#8 Weld		¼	2.31	1.29	.47	.06	.26	¼	¾	21	RED
256-30695-1157	#8 AWG			¼	3.00	2.10	.56	.06	.26	¾	1	21	RED
54852BE	#6 AWG			¼	2.28	1.28	.44	.08	.30	¼	¾	24	BLUE
256-30695-1014	#6 AWG			¼	2.63	1.63	.43	.08	.30	¼	1	24	BLUE
256-30695-1225	#6 AWG	61/24 = 24.6 kcmil		¼	2.43	1.43	.43	.08	.30	¼	¾	24	BLUE
256-30695-1158	#6 AWG	#6 Weld		¾	2.93	1.93	.59	.06	.30	¾	1	24	BLUE
256-30695-868	#6 AWG			½	4.18	3.00	.88	.11	.30	½	1¾	24	BLUE
54854BE	#4 AWG			¼	2.31	1.19	.52	.10	.37	¼	¾	29	GRAY
256-30695-1246	#4 AWG			¼	2.31	1.31	.56	.09	.37	¼	¾	29	GRAY
256-30695-1015	#4 AWG	91/24 = 36.7 kcmil		¼	2.88	1.88	.58	.09	.37	¾	1	29	GRAY
256-30695-1337	#4 AWG	#4 Weld		⅝	2.75	1.75	.56	.10	.37	1½	1	29	GRAY
256-30695-1159	#4 AWG			¾	3.13	1.98	.59	.09	.37	¾	1	29	GRAY
256-30695-733	#4 AWG			½	4.18	3.00	.88	.09	.37	½	1¾	29	GRAY
256-30695-1016	#2-3 AWG			¼	3.06	1.88	.67	.09	.41	¾	1	33	BROWN
54855BE	#2-3 AWG			¼	2.43	1.28	.59	.11	.41	¼	¾	33	BROWN
256-30695-1300	#2-3 AWG			¼	2.63	1.35	.68	.11	.41	¼	¾	33	BROWN
54856BE	#2-3 AWG			⅝	2.78	1.63	.59	.11	.41	¾	¾	33	BROWN
54810BE	#2-3 AWG	125/24 = 50.4 kcmil		¾	3.80	2.57	.59	.11	.41	¾	1¾	33	BROWN
256-30695-1160	#2-3 AWG			¾	3.08	1.94	.59	.11	.41	¾	1	33	BROWN
256-30695-869	#2-3 AWG			½	4.02	2.88	.75	.09	.41	¾	1¾	33	BROWN
54811BE	#2-3 AWG			½	4.28	3.00	.88	.11	.41	½	1¾	33	BROWN
54809BE	#1 AWG			¼	2.88	1.19	.67	.11	.47	¼	¾	37	GREEN
54812BE	#1 AWG	150/24 = 60.5 kcmil		¼	2.75	1.40	.67	.11	.47	¼	¾	37	GREEN
54858BE	#1 AWG	175/24 = 70.6 kcmil,		⅝	2.97	1.63	.67	.11	.47	¾	¾	37	GREEN
256-30695-1161	#1 AWG	#2 Weld		¾	3.30	1.98	.67	.11	.47	¾	1	37	GREEN
54857BE	#1 AWG			½	4.43	3.00	.88	.11	.47	½	1¾	37	GREEN
256-30695-1018	1/0 AWG			¼	3.63	1.88	.75	.13	.52	¾	1	42	PINK
256-30695-1018P	1/0 AWG			¼	3.63	1.88	.75	.13	.52	¾	1	42	PINK
54859BE	1/0 AWG			¼	2.63	1.19	.75	.13	.52	¼	¾	42	PINK
54813BE	1/0 AWG			¼	2.71	1.38	.75	.13	.52	¼	¾	42	PINK
54860BE	1/0 AWG	225/24 = 90.8 kcmil		⅝	2.97	1.63	.75	.13	.52	¾	¾	42	PINK
256-30695-1162P	1/0 AWG			¾	3.25	1.98	.75	.13	.52	¾	1	42	PINK
256-30695-1162	1/0 AWG			¾	3.23	1.93	.75	.13	.52	¾	1	42	PINK
256-30695-593	1/0 AWG			¾	4.33	3.00	.75	.13	.52	¾	1¾	42	PINK

† Contact Technical Services for specific stranding listings

Tooling: pp. B76-B92 Die Selector Chart: pp. B93-B95

United States
Tel: 901.252.8000
800.816.7809
Fax: 901.252.1354

Canada
Tel: 450.347.5318
Fax: 450.347.1976

Technical Services
Tel: 888.862.3289

Thomas & Betts

www.tnb.com

Connectors for Copper Conductor

Two-Hole Lugs — Long Barrel 600V to 35KV (continued)

Material: High-Conductivity
Wrought Copper

Finish: Electro Tin Plate

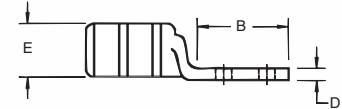
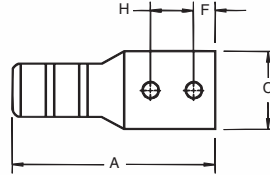

Peep Holes Available!
Add suffix **-PH**



CAT. NO.	CODE	WIRE SIZE		BOLT SIZE	DIMENSIONS (IN.)							DIE CODE	DIE COLOR
		FLEX CLASS	G, H, I, K, M†		A	B	C	D	E	F	H		
548148E	2/0 AWG			¼	2.62	1.25	.83	.13	.57	¼	¾	45	BLACK
256-30695-1299	2/0 AWG			¼	2.69	1.31	.81	.13	.57	¼	¾	45	BLACK
256-30695-1116	2/0 AWG	275/24 = 111	kcmil	¾	3.19	1.81	.83	.13	.57	¾	1	45	BLACK
256-30695-1116P	2/0 AWG	1/0	Weld	¾	3.19	1.81	.83	.13	.57	¾	1	45	BLACK
548628E	2/0 AWG			½	4.20	2.81	.83	.13	.57	½	1¼	45	BLACK
548158E	3/0 AWG	2/0	Weld	¼	2.89	1.45	.92	.13	.63	¼	¾	50	ORANGE
548168E	3/0 AWG	325/24 = 131	kcmil	¾	3.25	1.63	.92	.13	.63	¾	1	50	ORANGE
548648E	3/0 AWG			½	4.48	3.00	.94	.13	.63	½	1¼	50	ORANGE
548178E	4/0 AWG			¼	3.15	1.38	1.03	.14	.70	¼	¾	54	PURPLE
548188E	4/0 AWG			¾	4.38	2.63	1.03	.14	.70	¾	1¼	54	PURPLE
256-30695-1117	4/0 AWG	450/24 = 182	kcmil	¾	3.35	1.81	1.03	.14	.70	¾	1	54	PURPLE
256-30695-1117P	4/0 AWG	3/0	Weld	¾	3.50	1.88	1.03	.14	.70	¾	1	54	PURPLE
548668E	4/0 AWG			½	4.70	3.00	1.03	.14	.70	½	1¼	54	PURPLE
256-30695-1245	250 kcmil			¾	3.83	1.93	1.13	.14	.77	¾	1	62	YELLOW
256-30695-1245P	250 kcmil	550/24 = 222	kcmil,	¾	3.83	1.93	1.13	.14	.77	¾	1	62	YELLOW
548688E	250 kcmil	4/0	Weld	½	4.92	3.00	1.13	.14	.77	½	1¼	62	YELLOW
548198E	300 kcmil			¾	5.04	2.80	1.25	.15	.85	¾	1	66	WHITE
548708E	300 kcmil	250		½	5.23	3.00	1.25	.15	.85	½	1¼	66	WHITE
548208E	350 kcmil			¼	4.29	1.93	1.36	.18	.93	¼	¾	71	RED
256-30695-1118	350 kcmil	650/24 = 262	kcmil	¾	4.33	1.93	1.36	.18	.93	¾	1	71	RED
256-30695-1118P	350 kcmil			¾	4.33	1.93	1.36	.18	.93	¾	1	71	RED
548728E	350 kcmil			½	5.40	3.00	1.36	.18	.93	½	1¼	71	RED
548228E	400 kcmil			¼	4.38	1.93	1.41	.17	.96	¼	¾	76	BLUE
548218E	400 kcmil	775/24 = 313	kcmil	¾	4.43	1.93	1.41	.17	.96	¾	1	76	BLUE
548748E	400 kcmil			½	5.51	3.00	1.41	.17	.96	½	1¼	76	BLUE
548238E	500 kcmil			¼	4.93	1.94	1.61	.22	1.10	¼	¾	87	BROWN
256-30695-1119	500 kcmil			¾	5.00	1.93	1.61	.22	1.10	¾	1	87	BROWN
256-30695-1119P	500 kcmil	925/24 = 373	kcmil	¾	5.00	1.93	1.61	.22	1.10	¾	1	87	BROWN
548768E	500 kcmil			½	6.00	3.00	1.61	.22	1.10	½	1¼	87	BROWN
548248E	600 kcmil			¾	5.70	2.80	1.75	.24	1.20	¾	1	94	GREEN
548788E	600 kcmil	1100/24 = 444	kcmil	½	5.83	3.00	1.75	.24	1.20	½	1¼	94	GREEN
548798E	700 kcmil	1325/24 = 535	kcmil	½	5.83	3.00	1.80	.24	1.25	½	1¼	99	PINK
256-30695-1222	750 kcmil			¾	5.25	2.06	1.94	.27	1.33	¾	1	106	BLACK
256-30695-1222P	750 kcmil	1325/24 = 535	kcmil	¾	5.25	2.06	1.94	.27	1.33	¾	1	106	BLACK
548808E	750 kcmil			½	6.20	3.00	1.94	.27	1.33	½	1¼	106	BLACK
588848E		1600/24 = 646	kcmil	¾	6.16	3.00	1.94	.27	1.33	¾	1¼	106	BLACK
588268E	900 kcmil	1925/24 = 777	kcmil	½	6.74	3.00	2.18	.31	1.50	½	1¼	115	YELLOW
548268E	1000 kcmil			¾	6.49	2.80	2.27	.30	1.55	¾	1	125	N/A
548828E	1000 kcmil			½	6.66	3.00	2.27	.30	1.55	½	1¼	125	N/A
548888E	1250 kcmil			½	7.88	3.00	2.42	.35	1.67	¾	1¼	140	N/A

† Contact Technical Services for specific stranding listings

Tooling: pp. B76–B92

Die Selector Chart: pp. B93–B95

Connectors for Copper Conductor

Two-Hole Lugs — 45° Long Barrel 600V to 35KV

Material: High-Conductivity
Wrought Copper

Finish: Electro Tin Plate

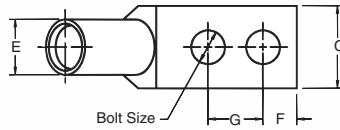
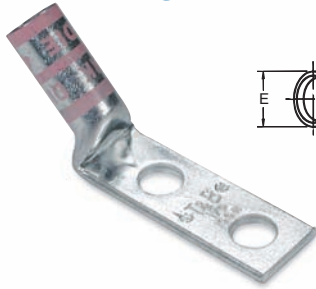

Peep Holes Available!
Add suffix -PH

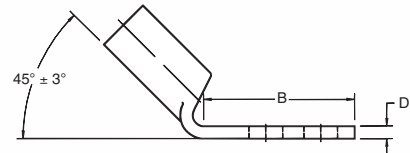

Color-Keyed Compression

CAT. NO.	CODE	WIRE SIZE		DIMENSIONS (IN.)							DIE CODE	DIE COLOR
		FLEX CLASS	G, H, I, K, M†	BOLT SIZE	B	C	D	E	F	G		
256-31426-3SPHUF	#14-10 AWG			#10	1.25	.37	.07	.20	3/32	5/8-3/4	ERG2002	YELLOW
256-30695-1298UF	#14-10 AWG			1/4	1.22	.50	.05	.20	1/4	5/8	ERG2002	YELLOW
256-30695-1055UF	#14-10 AWG			1/4	1.31	.50	.13	.36	1/4	5/8-3/4	ERG2002	YELLOW
54850BEUF	#8 AWG	37/24 = 14.9	kcmil	1/4	1.89	.42	.07	.26	1/4	5/8	21	RED
54851BEUF	#8 AWG		#8 Weld	1/4	1.29	.47	.06	.26	1/4	3/4	21	RED
54851BEUF0612	#8 AWG			3/8	1.42	.47	.06	.26	3/8	3/4	21	RED
54852BEUF	#6 AWG			1/4	1.28	.44	.08	.30	1/4	5/8	24	BLUE
54852BEUF0416	#6 AWG			1/4	1.63	.43	.08	.30	1/4	1	24	BLUE
54852BEUF0412	#6 AWG	61/24 = 24.6	kcmil	1/4	1.43	.43	.08	.30	1/4	3/4	24	BLUE
54852BEUF0616	#6 AWG		#6 Weld	3/8	1.93	.59	.06	.30	3/8	1	24	BLUE
54852BEUF0828	#6 AWG			1/2	3.00	.88	.11	.30	1/2	1 1/4	24	BLUE
54854BEUF	#4 AWG			1/4	1.19	.52	.10	.37	1/4	5/8	29	GRAY
54854BEUF0412	#4 AWG			1/4	1.31	.56	.09	.37	1/4	3/4	29	GRAY
54854BEUF0416	#4 AWG	91/24 = 36.7	kcmil	1/4	1.88	.58	.09	.37	3/8	1	29	GRAY
54854BEUF0516	#4 AWG		#4 Weld	5/16	1.75	.56	.10	.37	1 1/2	1	29	GRAY
54854BEUF0616	#4 AWG			3/8	1.98	.59	.09	.37	3/8	1	29	GRAY
54854BEUF0828	#4 AWG			1/2	3.00	.88	.09	.37	1/2	1 1/4	29	GRAY
54855BEUF0416	#2-3 AWG			1/4	1.88	.67	.09	.41	3/8	1	33	BROWN
54855BEUF	#2-3 AWG			1/4	1.28	.59	.11	.41	1/4	5/8	33	BROWN
54855BEUF0412	#2-3 AWG			1/4	1.35	.68	.11	.41	1/4	3/4	33	BROWN
54856BEUF	#2-3 AWG	125/24 = 50.4	kcmil	5/16	1.63	.59	.11	.41	3/8	3/4	33	BROWN
54810BEUF	#2-3 AWG			3/8	2.57	.59	.11	.41	3/8	1 1/4	33	BROWN
54810BEUF0616	#2-3 AWG			3/8	1.94	.59	.11	.41	3/8	1	33	BROWN
54811BEUF	#2-3 AWG			1/2	3.00	.88	.11	.41	1/2	1 1/4	33	BROWN
54809BEUF	#1 AWG			1/4	1.19	.67	.11	.47	1/4	5/8	37	GREEN
54812BEUF	#1 AWG	150/24 = 60.5	kcmil	1/4	1.40	.67	.11	.47	1/4	3/4	37	GREEN
54858BEUF	#1 AWG	175/24 = 70.6	kcmil,	5/16	1.63	.67	.11	.47	3/8	3/8	37	GREEN
54857BEUF0616	#1 AWG		#2 Weld	3/8	1.98	.67	.11	.47	3/8	1	37	GREEN
54857BEUF	#1 AWG			1/2	3.00	.88	.11	.47	1/2	1 1/4	37	GREEN
54859BEUF0416	1/0 AWG			1/4	1.88	.75	.13	.52	3/8	1	42	PINK
54859BEUF0416PH	1/0 AWG			1/4	1.88	.75	.13	.52	3/8	1	42	PINK
54859BEUF	1/0 AWG			1/4	1.19	.75	.13	.52	1/4	5/8	42	PINK
54813BEUF	1/0 AWG			1/4	1.38	.75	.13	.52	1/4	3/4	42	PINK
54860BEUF	1/0 AWG	225/24 = 90.8	kcmil	5/16	1.63	.75	.13	.52	3/8	3/8	42	PINK
54860BEUF0616	1/0 AWG			3/8	1.98	.75	.13	.52	3/8	1	42	PINK
54860BEUF0616PH	1/0 AWG			3/8	1.93	.75	.13	.52	3/8	1	42	PINK
54860BEUF0828	1/0 AWG			1/2	3.00	.75	.13	.52	3/8	1 1/4	42	PINK
54814BEUF	2/0 AWG			1/4	1.25	.83	.13	.57	1/4	5/8	45	BLACK
54814BEUF0412	2/0 AWG			1/4	1.31	.81	.13	.57	1/4	3/4	45	BLACK
54862BEUF0616	2/0 AWG	275/24 = 111	kcmil	3/8	1.81	.83	.13	.57	3/8	1	45	BLACK
54862BEUF0616PH	2/0 AWG		1/0 Weld	3/8	1.81	.83	.13	.57	3/8	1	45	BLACK
54862BEUF	2/0 AWG			1/2	2.81	.83	.13	.57	1/2	1 1/4	45	BLACK

† Contact Technical Services for specific stranding listings

Tooling: pp. B76-B92 Die Selector Chart: pp. B93-B95

United States
Tel: 901.252.8000
800.816.7809
Fax: 901.252.1354

Canada
Tel: 450.347.5318
Fax: 450.347.1976

Technical Services
Tel: 888.862.3289

Thomas&Betts

www.tnb.com

Connectors for Copper Conductor

Two-Hole Lugs — 45° Long Barrel 600V to 35KV (continued)

Material: High-Conductivity
Wrought Copper

Finish: Electro Tin Plate

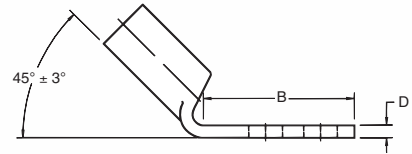
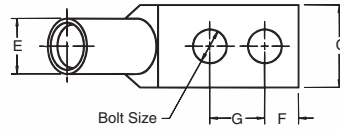
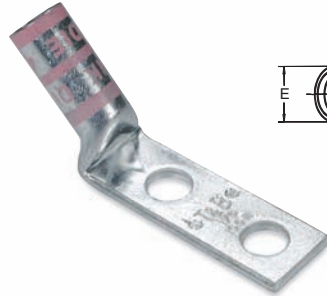

Peep Holes Available!
Add suffix **-PH**



CAT. NO.	CODE	WIRE SIZE		DIMENSIONS (IN.)							DIE CODE	DIE COLOR
		FLEX CLASS G, H, I, K, M†	BOLT SIZE	B	C	D	E	F	G			
54815BEUF	3/0 AWG	2/0 Weld	¼	1.45	.92	.13	.63	¼	¾	50	ORANGE	
54816BEUF	3/0 AWG	325/24 = 131 kcmil	¾	1.63	.92	.13	.63	¾	1	50	ORANGE	
54864BEUF	3/0 AWG		½	3.00	.94	.13	.63	½	1¾	50	ORANGE	
54817BEUF	4/0 AWG		¼	1.38	1.03	.14	.70	¼	¾	54	PURPLE	
54818BEUF	4/0 AWG		¾	2.63	1.03	.14	.70	¾	1¾	54	PURPLE	
54818BEUF0616	4/0 AWG	450/24 = 182 kcmil	¾	1.81	1.03	.14	.70	¾	1	54	PURPLE	
54818BEUF0616PH	4/0 AWG	3/0 Weld	¾	1.88	1.03	.14	.70	¾	1	54	PURPLE	
54866BEUF	4/0 AWG		½	3.00	1.03	.14	.70	½	1¾	54	PURPLE	
54868BEUF0616	250 kcmil		¾	1.93	1.13	.14	.77	¾	1	62	YELLOW	
54868BEUF0616PH	250 kcmil	550/24 = 222 kcmil	¾	1.93	1.13	.14	.77	¾	1	62	YELLOW	
54868BEUF	250 kcmil	4/0 Weld	½	3.00	1.13	.14	.77	½	1¾	62	YELLOW	
54819BEUF	300 kcmil		¾	2.80	1.25	.15	.85	¾	1	66	WHITE	
54870BEUF	300 kcmil	250	½	3.00	1.25	.15	.85	½	1¾	66	WHITE	
54820BEUF	350 kcmil		¼	1.93	1.36	.18	.93	¼	¾	71	RED	
54872BEUF0616	350 kcmil		¾	1.93	1.36	.18	.93	¾	1	71	RED	
54872BEUF0616PH	350 kcmil	650/24 = 262 kcmil	¾	1.93	1.36	.18	.93	¾	1	71	RED	
54872BEUF	350 kcmil		½	3.00	1.36	.18	.93	½	1¾	71	RED	
54822BEUF	400 kcmil		¼	1.93	1.41	.17	.96	¼	¾	76	BLUE	
54821BEUF	400 kcmil	775/24 = 313 kcmil	¾	1.93	1.41	.17	.96	¾	1	76	BLUE	
54874BEUF	400 kcmil		½	3.00	1.41	.17	.96	½	1¾	76	BLUE	
54823BEUF	500 kcmil		¼	1.94	1.61	.22	1.10	¼	¾	87	BROWN	
54876BEUF0616	500 kcmil		¾	1.93	1.61	.22	1.10	¾	1	87	BROWN	
54876BEUF0616PH	500 kcmil	925/24 = 373 kcmil	¾	1.93	1.61	.22	1.10	¾	1	87	BROWN	
54876BEUF	500 kcmil		½	3.00	1.61	.22	1.10	½	1¾	87	BROWN	
54824BEUF	600 kcmil		¾	2.80	1.75	.24	1.20	¾	1	94	GREEN	
54878BEUF	600 kcmil	1100/24 = 444 kcmil	¾	3.00	1.75	.24	1.20	¾	1¾	94	GREEN	
54880BEUF0616	750 kcmil		¾	2.06	1.94	.27	1.33	¾	1	106	BLACK	
54880BEUF0616PH	750 kcmil	1325/24 = 535 kcmil	¾	2.06	1.94	.27	1.33	¾	1	106	BLACK	
54880BEUF	750 kcmil		½	3.00	1.94	.27	1.33	½	1¾	106	BLACK	
58884BEUF		1600/24 = 646 kcmil	¾	3.00	1.94	.27	1.33	¾	1¾	106	BLACK	
58826BEUF	900 kcmil	1925/24 = 777 kcmil	¾	3.00	2.18	.31	1.50	¾	1¾	115	YELLOW	
54826BEUF	1000 kcmil		¾	2.80	2.27	.30	1.55	¾	1	125	N/A	
54882BEUF	1000 kcmil		¾	3.00	2.27	.30	1.55	¾	1¾	125	N/A	

† Contact Technical Services for specific stranding listings

Tooling: pp. B76–B92

Die Selector Chart: pp. B93–B95

Connectors for Copper Conductor

Two-Hole Lugs — 90° Long Barrel 600V to 35KV Applications

Material: High-Conductivity
Wrought Copper

Finish: Electro Tin Plate

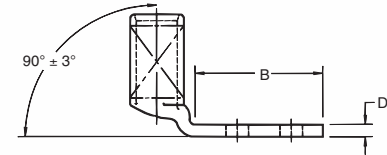
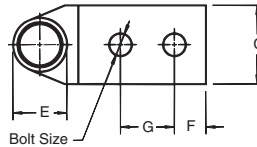

Peep Holes Available!
Add suffix **-PH**



Color-Keyed Compression

CAT. NO.	CODE	WIRE SIZE			DIMENSIONS (IN.)						DIE CODE	DIE COLOR
		FLEX CLASS	G, H, I, K, M*	BOLT SIZE	B	C	D	E	F	G		
256-31426-3SPHUB	#14-10 AWG			#10	1.25	.37	.07	.20	3/32	5/16	ERG2002	YELLOW
256-30695-1298UB	#14-10 AWG			1/4	1.22	.50	.05	.20	1/4	3/8	ERG2002	YELLOW
256-30695-1055UB	#14-10 AWG			1/4	1.31	.50	.13	.36	1/4	5/8-3/4	ERG2002	YELLOW
54850BEUB	#8 AWG	37/24 = 14.9 kcmil		1/4	1.89	.42	.07	.26	1/4	1 1/16	21	RED
54851BEUB	#8 AWG	#8 Weld		1/4	1.29	.47	.06	.26	1/4	3/4	21	RED
54851BEUB0616	#8 AWG			3/8	2.10	.56	.06	.26	3/8	1	21	RED
54852BEUB	#6 AWG			1/4	1.28	.44	.08	.30	1/4	5/8	24	BLUE
256306951014B	#6 AWG			1/4	1.63	.43	.08	.30	1/4	1	24	BLUE
54852BEUB0412	#6 AWG	61/24 = 24.6 kcmil		1/4	1.43	.43	.08	.30	1/4	3/4	24	BLUE
54852BEUB0616	#6 AWG	#6 Weld		3/8	1.93	.59	.06	.30	3/8	1	24	BLUE
54852BEUB0828	#6 AWG			1/2	3.00	.88	.11	.30	1/2	1 1/4	24	BLUE
54854BEUB	#4 AWG			1/4	1.19	.52	.10	.37	1/4	3/8	29	GRAY
54854BEUB0412	#4 AWG			1/4	1.31	.56	.09	.37	1/4	3/4	29	GRAY
54854BEUB0416	#4 AWG	91/24 = 36.7 kcmil		1/4	1.88	.58	.09	.37	3/8	1	29	GRAY
54854BEUB0516	#4 AWG	#4 Weld		5/16	1.75	.56	.10	.37	1 1/32	1	29	GRAY
54854BEUB0616	#4 AWG			3/8	1.98	.59	.09	.37	3/8	1	29	GRAY
54854BEUB0828	#4 AWG			1/2	3.00	.88	.09	.37	1/2	1 1/4	29	GRAY
54858BEUB0416	#2-3 AWG			1/4	1.88	.67	.09	.41	3/8	1	33	BROWN
54855BEUB	#2-3 AWG			1/4	1.28	.59	.11	.41	1/4	5/8	33	BROWN
54855BEUB0412	#2-3 AWG			1/4	1.35	.68	.11	.41	1/4	3/4	33	BROWN
54856BEUB	#2-3 AWG	125/24 = 50.4 kcmil		5/16	1.63	.59	.11	.41	3/8	3/4	33	BROWN
54810BEUB	#2-3 AWG			3/8	2.57	.59	.11	.41	3/8	1 1/4	33	BROWN
54810BEUB0616	#2-3 AWG			3/8	1.94	.59	.11	.41	3/8	1	33	BROWN
54811BEUB	#2-3 AWG			1/2	3.00	.88	.11	.41	1/2	1 1/4	33	BROWN
54809BEUB	#1 AWG			1/4	1.19	.67	.11	.47	1/4	3/8	37	GREEN
54812BEUB	#1 AWG	150/24 = 60.5 kcmil		1/4	1.40	.67	.11	.47	1/4	3/4	37	GREEN
54858BEUB	#1 AWG	175/24 = 70.6 kcmil		5/16	1.63	.67	.11	.47	3/8	3/8	37	GREEN
54857BEUB0616	#1 AWG	#2 Weld		3/8	1.98	.67	.11	.47	3/8	1	37	GREEN
54857BEUB	#1 AWG			1/2	3.00	.88	.11	.47	1/2	1 1/4	37	GREEN
54859BEUB0416	1/0 AWG			1/4	1.88	.75	.13	.52	3/8	1	42	PINK
54859BEUB0416PH	1/0 AWG			1/4	1.88	.75	.13	.52	3/8	1	42	PINK
54859BEUB	1/0 AWG			1/4	1.19	.75	.13	.52	1/4	5/8	42	PINK
54813BEUB	1/0 AWG	225/24 = 90.8 kcmil		1/4	1.38	.75	.13	.52	1/4	3/4	42	PINK
54860BEUB	1/0 AWG			5/16	1.63	.75	.13	.52	3/8	3/4	42	PINK
54860BEUB0616	1/0 AWG			3/8	1.98	.75	.13	.52	3/8	1	42	PINK
54860BEUB0828	1/0 AWG			1/2	3.00	.75	.13	.52	3/8	1 1/4	42	PINK
54814BEUB	2/0 AWG			1/4	1.25	.83	.13	.57	1/4	3/8	45	BLACK
54814BEUB0412	2/0 AWG			1/4	1.31	.81	.13	.57	1/4	3/4	45	BLACK
54862BEUB0616	2/0 AWG	275/24 = 111 kcmil		3/8	1.81	.83	.13	.57	3/8	1	45	BLACK
54862BEUB0616PH	2/0 AWG	1/0 Weld		3/8	1.81	.83	.13	.57	3/8	1	45	BLACK
54862BEUB	2/0 AWG			1/2	2.81	.83	.13	.57	1/2	1 1/4	45	BLACK

† Contact Technical Services for specific stranding listings

Tooling: pp. B76-B92 Die Selector Chart: pp. B93-B95

United States
Tel: 901.252.8000
800.816.7809
Fax: 901.252.1354

Canada
Tel: 450.347.5318
Fax: 450.347.1976

Technical Services
Tel: 888.862.3289

Thomas&Betts

www.tnb.com

Connectors for Copper Conductor

Two-Hole Lugs — 90° Long Barrel 600V to 35KV Applications (continued)

Material: High-Conductivity
Wrought Copper

Finish: Electro Tin Plate

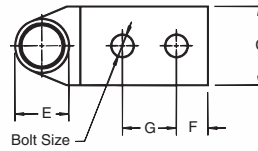

Peep Holes Available!
Add suffix **-PH**

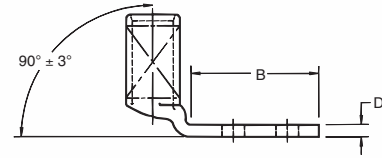

Color-Keyed[®] Compression

CAT. NO.	CODE	WIRE SIZE		DIMENSIONS (IN.)						DIE CODE	DIE COLOR	
		FLEX CLASS	G, H, I, K, M [†]	BOLT SIZE	B	C	D	E	F			G
54815BEUB	3/0 AWG	2/0 Weld		¼	1.45	.92	.13	.63	¼	¾	50	ORANGE
54816BEUB	3/0 AWG	325/24 = 131 kcmil		¾	1.63	.92	.13	.63	¾	¾	50	ORANGE
54864BEUB	3/0 AWG			½	3.00	.94	.13	.63	½	1¼	50	ORANGE
54817BEUB	4/0 AWG			¼	1.38	1.03	.14	.70	¼	¾	54	PURPLE
54818BEUB	4/0 AWG			¾	2.63	1.03	.14	.70	¾	1¼	54	PURPLE
54818BEUB0616	4/0 AWG	450/24 = 182 kcmil		¾	1.81	1.03	.14	.70	¾	1	54	PURPLE
54818BEUB0616PH	4/0 AWG	3/0 Weld		¾	1.88	1.03	.14	.70	¾	1	54	PURPLE
54866BEUB	4/0 AWG			½	3.00	1.03	.14	.70	½	1¼	54	PURPLE
54868BEUB0616	250 kcmil			¾	1.93	1.13	.14	.77	¾	1	62	YELLOW
54868BEUB0616PH	250 kcmil	550/24 = 222 kcmil		¾	1.93	1.13	.14	.77	¾	1	62	YELLOW
54868BEUB	250 kcmil	4/0 Weld		½	3.00	1.13	.14	.77	½	1¼	62	YELLOW
54819BEUB	300 kcmil			¾	2.80	1.25	.15	.85	¾	1	66	WHITE
54870BEUB	300 kcmil	250		½	3.00	1.25	.15	.85	½	1¼	66	WHITE
54820BEUB	350 kcmil			¼	1.93	1.36	.18	.93	¼	¾	71	RED
54872BEUB0616	350 kcmil			¾	1.93	1.36	.18	.93	¾	1	71	RED
54872BEUB0616PH	350 kcmil	650/24 = 262 kcmil		¾	1.93	1.36	.18	.93	¾	1	71	RED
54872BEUB	350 kcmil			½	3.00	1.36	.18	.93	½	1¼	71	RED
54822BEUB	400 kcmil			¼	1.93	1.41	.17	.96	¼	¾	76	BLUE
54821BEUB	400 kcmil	775/24 = 313 kcmil		¾	1.93	1.41	.17	.96	¾	1	76	BLUE
54874BEUB	400 kcmil			½	3.00	1.41	.17	.96	½	1¼	76	BLUE
54823BEUB	500 kcmil			¼	1.94	1.61	.22	1.10	¼	¾	87	BROWN
54823BEUB0616	500 kcmil			¾	1.93	1.61	.22	1.10	¾	1	87	BROWN
54876BEUB0616PH	500 kcmil	925/24 = 373 kcmil		¾	1.93	1.61	.22	1.10	¾	1	87	BROWN
54876BEUB	500 kcmil			½	3.00	1.61	.22	1.10	½	1¼	87	BROWN
54824BEUB	600 kcmil			¾	2.80	1.75	.24	1.20	¾	1	94	GREEN
54878BEUB	600 kcmil	1100/24 = 444 kcmil		½	3.00	1.75	.24	1.20	½	1¼	94	GREEN
54880BEUB0616	750 kcmil			¾	2.06	1.94	.27	1.33	¾	1	106	BLACK
54880BEUB0616PH	750 kcmil	1325/24 = 535 kcmil		¾	2.06	1.94	.27	1.33	¾	1	106	BLACK
54880BEUB	750 kcmil			½	3.00	1.94	.27	1.33	½	1¼	106	BLACK
58884BEUB		1600/24 = 646 kcmil		½	3.00	1.94	.27	1.33	½	1¼	106	BLACK
58826BEUB	900 kcmil	1925/24 = 777 kcmil		½	3.00	2.18	.31	1.50	½	1¼	115	YELLOW
54826BEUB	1000 kcmil			¾	2.80	2.27	.30	1.55	¾	1	125	N/A
54882BEUB	1000 kcmil			¾	3.00	2.27	.30	1.55	¾	1¼	125	N/A

† Contact Technical Services for specific stranding listings

Tooling: pp. B76–B92

Die Selector Chart: pp. B93–B95

Connectors for Copper Conductor

Copper One-Hole Lugs for 600V to 35KV Applications

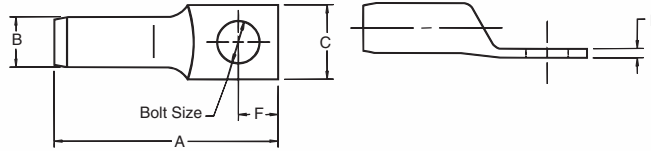

These Color-Keyed® Connectors are recommended for up to 15 KV applications. Installed with standard T&B Cat. No. TBM15I, 13100A, TBM14M hydraulic compression tools with special rounding dies. The compression forms the connector and conductor into a solid mass to provide an optimum electrical bond between connector and conductor. The rounding die overlapped compressions provide a smooth round surface. This, combined with the tapered barrel ends, addresses the controlling of potentially damaging electrical stresses of high voltages.

CAT. NO.	CABLE SIZE†		DIMENSIONS (IN.)						INSTALLING TOOLS		
	STUD SIZE (IN.)		A	B	C	D	E	F	DIE SET CAT. NO.	STRIP LENGTH (IN.)	COLOR CODE
54440	#4 AWG	3/8	2.08	.81	.58	.08	3/8	1/2	15CA29R	1/16	GRAY
54443	#2 AWG	3/8	2.25	.81	.66	.09	3/8	1/2	15CA33R	1/16	BROWN
54448	#1 AWG	3/8	2.36	.81	.69	.10	3/8	1/2	15CA37R	1 1/2	GREEN
54409	1/0 AWG	3/8	2.38	.81	.75	.12	3/8	1/2	15CA42R	1 1/2	PINK
54460	2/0 AWG	1/2	2.73	1.06	.83	.12	1/2	1/2	15CA45R	1 1/2	BLACK
54465	3/0 AWG	1/2	2.81	1.06	.94	.12	1/2	1/2	15CA49R	1 1/2	ORANGE
54470	4/0 AWG	1/2	2.78	1.06	1.00	.13	1/2	1/2	15CA54R	1 1/2	PURPLE
54413	250 kcmil	1/2	3.19	1.06	1.07	.14	1/2	1/2	15CA60R	2 1/2	RUBY

† Cable size: Concentric and compact strandings

* Cat. No. TB15500 Die Adaptor required for TBM15I

Tooling: pp. B76–B92

Die Selector Chart: pp. B93–B95

Copper Two-Hole Lugs for 600V to 35KV Application

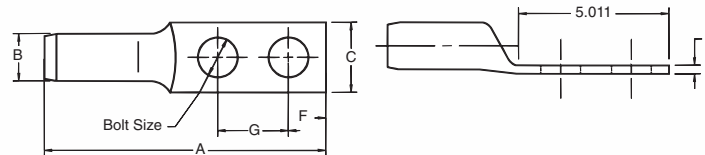

CAT. NO.	CABLE SIZE†		DIMENSIONS (IN.)							INSTALLING TOOLS		
	STUD SIZE (IN.)		A	B	C	D	E	F	G	DIE SET CAT. NO.	STRIP LENGTH (IN.)	COLOR CODE
54475	1/0 AWG	3/8	3.56	1 1/2	.77	.12	3/8	3/8	1.00	15CA42R	1 1/2	PINK
54476	2/0 AWG	1/2	4.67	3/8	.83	.12	1/2	1/2	1.75	15CA45R	1 1/2	BLACK
54478	3/0 AWG	1/2	4.75	3/8	.94	.12	1/2	1/2	1.75	15CA49R	1 1/2	ORANGE
54479	4/0 AWG	1/2	4.64	1 1/8	1.00	.13	1/2	1/2	1.75	15CA54R	1 1/2	PURPLE
54480	250 kcmil	1/2	5.17	3/4	1.08	.14	1/2	1/2	1.75	15CA60R	2 1/2	RUBY
54481	300 kcmil	1/2	5.16	1 1/8	1.19	.16	1/2	1/2	1.75	15CA66R	2 1/2	WHITE
54482	350 kcmil	1/2	5.35	3/8	1.29	.19	1/2	1/2	1.75	15CA71R	2 1/2	RED
54483	400 kcmil	1/2	5.35	5 16	1.36	.18	1/2	1/2	1.75	15CA76R	2 1/2	BLUE
54484	500 kcmil	1/2	5.60	1 1/8	1.54	.23	1/2	1/2	1.75	15CA87R	2 1/2	BROWN
54485	600 kcmil	1/2	5.83	1 1 16	1.70	.24	1/2	1/2	1.75	15CA94R	2 1/2	GREEN
54487	750 kcmil	1/2	6.13	1 1 4	1.89	.27	1/2	1/2	1.75	15CA106R	2 1/2	BLACK
54490	1000 kcmil	1/2	6.60	1 1/2	2.18	.31	1/2	1/2	1.75	•15C125R	2 3/4	-

• No adaptor required – TBM15I only

† Cable size: Concentric and compact strandings

TBM14M and 13100A UL Listing limited to 1/0 AWG 500 kcmil cable sizes

* Cat. No. TB15500 Die Adaptor required for TBM15I

Tooling: pp. B76–B92

Die Selector Chart: pp. B93–B95

Connectors for Copper Conductor

Bell-Ended Lugs — Standard Barrel

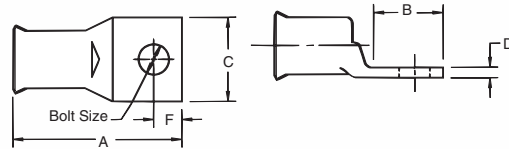

Bell-Shaped Barrel



CAT. NO.	WIRE SIZE*			CLASS G	CLASS H	CLASS I	CLASS K	CLASS M	BOLT SIZE (IN.)	DIMENSIONS (IN.)					DIE CODE	DIE COLOR
	CODE	NAVY	FLEX							A	B	C	D	F		
54104BS	8	23	37/24	8	8	—	8	8	#10	1 1/16	1 5/32	1 1/2	5/4	7/32	21	RED
54105BS	6	30	61/24	5	5	5	5	5	1/4	1 1/16	9/16	7/16	7/64	1/4	24	BLUE
54106BS	4	40-50	91/24	5	5	5	5	5	1/4	1 1/32	9/16	9/16	7/64	1/4	29	GRAY
54139BS	3 & 4	40-50	91/24	4	4	4	4	4	5/16	1 1/16	2 5/32	1 5/32	5/4	1 1/32	29	GRAY
54142BS	2	60	125/24	3	3	3	3	3	5/16	1 1/32	2 3/32	2 1/32	5/4	1 1/32	37	BROWN
54147BS	1	75	150, 175/24	2	2	2	2	2	5/16	1 21/32	2 3/32	4 3/64	1/2	3/8	37	GREEN
54153BS	1/0	100	225/24	1	1	1	1	1	5/16	1 3/8	2 3/32	3/4	5/4	3/8	42	PINK
54110BS	2/0	125	275/24	1/0	1/0	1/0	1/0	1/0	3/8	1 3/8	1 3/16	1 3/16	5/4	3/8	45	BLACK
54165BS	3/0	150	325/24	2/0	2/0	2/0	2/0	2/0	1/2	2 1/32	1 1/16	1 5/16	5/4	1/2	50	ORANGE
54170BS	4/0	200	450/24	3/0	3/0	3/0	3/0	3/0	1/2	2 3/16	1 1/16	1 1/2	5/2	1/2	54	PURPLE
58165BS	250	—	550/24	4/0	4/0	—	—	—	1/2	2 15/32	1 1/8	1 1/4	3/6	1/2	62	YELLOW
54114BS	300	300	650/24	250	250	250	250	—	1/2	2 15/32	1 1/8	1 1/4	3/6	1/2	66	WHITE
5411440BS	300	300	—	250	250	4/0	4/0	4/0	1/2	2 3/8	1 1/8	1 1/4	3/6	1/2	66	WHITE
54115260BS	350	350	650/24	—	—	250	250	250	1/2	2 5/8	1 1/8	1 3/8	1 3/4	9/16	66	WHITE
54185BS	400	400	775/24	300	300	300	300	300	5/8	3 1/16	1 11/16	1 13/32	7/32	1 3/16	76	BLUE
58177BS	500	—	925/24	400	400	400	350	350	5/8	3	1 5/16	1 3/8	1/4	1 3/16	80	N/A
58180BS	600	—	1100/24	—	—	450	450	450	5/8	3 5/8	1 11/16	1 25/32	1 7/64	1 3/16	94	GREEN
54122BS	700	—	1325/24	500	500	500	500	500	5/8	3 5/8	1 11/16	1 25/32	5/32	1 3/16	99	PINK
54123BS	750	—	—	600	—	—	—	550	5/8	3 5/8	1 11/16	1 15/16	3/16	1 3/16	106	BLACK
54124BS	800	800	—	—	—	—	600	—	5/8	3 7/16	1 1/16	2	5/16	5/8	107	ORANGE
54126BS	900	—	1925/24	—	—	—	—	v	5/8	4 1/8	1 13/16	2 3/16	1 1/32	7/8	115	YELLOW

Tooling: pp. B76–B92

Die Selector Chart: pp. B93–B95

Connectors for Copper Conductor

Bell-Ended Lugs — Long Barrel

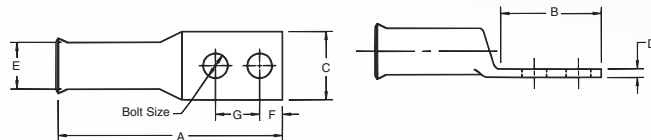

Bell-Shaped Copper Lugs with Two Bolt Holes



CAT. NO.	WIRE SIZE*			CLASS G	CLASS H	CLASS I	CLASS K	CLASS M	BOLT SIZE (IN.)	DIMENSIONS (IN.)							DIE CODE	DIE COLOR
	CODE	NAVY	FLEX							A	B	C	D	E	F	G		
54850BEBS	8	23	8	8	8	—	8	—	¼	2.19	1.88	.42	.07	.26	.25	.63	21	RED
54851BEBS	8	23	8	8	8	—	8	—	¼	2.31	1.29	.47	.06	.26	.25	.75	21	RED
54851BE0616BS	8	23	8	8	8	—	8	—	¾	3.00	2.10	.56	.06	.26	.38	1.00	21	RED
54852BE0616BS	6	30	6	5	5	5	5	—	¾	2.93	1.93	.59	.06	.30	.38	1.00	24	BLUE
54852BEBS	6	30	6	5	5	5	5	—	¼	2.28	1.28	.44	.08	.30	.25	.63	24	BLUE
54852BE0412BS	6	30	6	5	5	5	5	—	¼	2.43	1.43	.43	.07	.30	.25	.75	24	BLUE
54854BEBS	4-3	40-50	5	5	5	5	5	—	¼	2.31	1.19	.52	.10	.37	.25	.63	29	GRAY
54854BE0412BS	4-3	40-50	5	5	5	5	5	—	¼	2.31	1.31	.56	.09	.37	.25	.75	29	GRAY
54854BE0616BS	4-3	40-50	5	5	5	5	5	—	¾	3.13	1.98	.59	.09	.37	.38	1.00	29	GRAY
54855BE0412BS	2	60	3	3	3	3	3	3	¾	2.63	1.35	.68	.11	.41	.25	.75	33	BROWN
54855BEBS	2	60	3	3	3	3	3	3	¼	2.43	1.28	.59	.11	.41	.25	.63	33	BROWN
54856BEBS	2	60	3	3	3	3	3	3	¾	2.78	1.63	.59	.11	.41	.38	.75	33	BROWN
54810BE0616BS	2	60	3	3	3	3	3	3	¾	3.08	1.94	.59	.11	.41	.38	1.00	33	BROWN
54811BEBS	2	60	3	3	3	3	3	3	¾	4.28	3.00	.88	.09	.41	.50	1.75	33	BROWN
54809BEBS	1	75	2	2	2	2	2	2	¼	2.88	1.19	.67	.11	.47	.25	.63	37	GREEN
54812BEBS	1	75	2	2	2	2	2	2	¼	2.75	1.40	.67	.11	.47	.25	.75	37	GREEN
54858BEBS	1	75	2	2	2	2	2	2	¾	2.97	1.63	.67	.11	.47	.38	.88	37	GREEN
54857BEBS	1	75	2	2	2	2	2	2	¼	4.43	3.00	.88	.10	.47	.50	1.75	37	GREEN
54859BEBS	1/0	100	1	1	1	1	1	1	¼	2.63	1.19	.75	.13	.52	.25	.63	42	PINK
54813BEBS	1/0	100	1	1	1	1	1	1	¼	2.71	1.38	.75	.13	.52	.25	.75	42	PINK
54860BEBS	1/0	100	1	1	1	1	1	1	¾	2.97	1.63	.75	.13	.52	.38	.88	42	PINK
54860BE0616BS	1/0	100	1	1	1	1	1	1	¾	3.23	1.93	.75	.13	.52	.38	1.00	42	PINK
5414BEBS	2/0	125	1/0	1/0	1/0	1/0	1/0	1/0	¼	2.62	1.25	.83	.13	.57	.25	.63	45	BLACK
54814BE0412BS	2/0	125	1/0	1/0	1/0	1/0	1/0	1/0	¼	2.69	1.31	.81	.13	.57	.25	.75	45	BLACK
54862BE0616BS	2/0	125	1/0	1/0	1/0	1/0	1/0	1/0	¾	3.19	1.81	.83	.13	.57	.38	1.00	45	BLACK
54862BEBS	2/0	125	1/0	1/0	1/0	1/0	1/0	1/0	¼	4.20	2.81	.83	.13	.57	.50	1.75	45	BLACK
54815BEBS	3/0	150	2/0	2/0	2/0	2/0	2/0	2/0	¼	2.89	1.45	.92	.13	.63	.25	.75	50	ORANGE
54816BEBS	3/0	150	2/0	2/0	2/0	2/0	2/0	2/0	¾	3.25	1.63	.92	.13	.63	.38	1.00	50	ORANGE
54864BEBS	3/0	150	2/0	2/0	2/0	2/0	2/0	2/0	¼	4.45	3.00	.92	.13	.63	.50	1.75	50	ORANGE
54817BEBS	4/0	200	3/0	3/0	3/0	3/0	3/0	3/0	¼	3.15	1.38	1.03	.14	.70	.50	.75	54	PURPLE
54818BE0616BS	4/0	200	3/0	3/0	3/0	3/0	3/0	3/0	¾	3.35	1.81	1.03	.14	.70	.25	1.00	54	PURPLE
54818BEBS	4/0	200	3/0	3/0	3/0	3/0	3/0	3/0	¾	4.38	2.63	1.03	.14	.70	.38	1.75	54	PURPLE
54866BEBS	4/0	200	3/0	3/0	3/0	3/0	3/0	3/0	¼	4.70	3.00	1.03	.14	.70	.50	1.75	54	PURPLE
54868BE0616BS	250	—	4/0	4/0	4/0	4/0	4/0	4/0	¾	3.83	1.93	1.13	.14	.77	.50	1.00	62	YELLOW
54868BEBS	250	—	4/0	4/0	4/0	4/0	4/0	4/0	¼	4.92	3.00	1.13	.14	.77	.50	1.75	62	YELLOW
54819BEBS	300	300	262 kcmil	250 kcmil	250	250	250	—	¾	5.04	2.80	1.25	.15	.85	.50	1.00	66	WHITE
54870BEBS	300	300	262 kcmil	250 kcmil	250	250	250	—	½	5.23	3.00	1.25	.15	.85	.50	1.75	66	WHITE
54822BEBS	400	400	313 kcmil	300 kcmil	300	300	300	—	¼	4.38	1.93	1.41	.17	.96	.63	.75	76	BLUE
54821BEBS	400	400	313 kcmil	300 kcmil	300	300	300	—	¾	4.43	1.93	1.41	.17	.96	.63	1.00	76	BLUE
54874BEBS	400	400	313 kcmil	300 kcmil	300	300	300	—	½	5.51	3.00	1.41	.17	.96	.63	1.75	76	BLUE
54823BEBS	500	—	373 kcmil	400 kcmil	400	400	350	—	¼	4.93	1.94	1.61	.22	1.10	.50	.75	87	BROWN
54876BE0616BS	500	—	373 kcmil	400 kcmil	400	400	350	—	¾	5.00	1.93	1.61	.22	1.10	.50	1.00	87	BROWN
54876BEBS	500	—	373 kcmil	400 kcmil	400	400	350	—	½	6.00	3.00	1.61	.22	1.10	.50	1.75	87	BROWN
54824BEBS	—	—	444 kcmil	—	—	450	450	—	¾	5.70	2.80	1.75	.24	1.20	.63	1.00	94	GREEN
54878BEBS	—	—	444 kcmil	—	—	450	450	—	½	5.83	3.00	1.75	.24	1.20	.63	1.75	94	GREEN
54880BEBS	700	—	535 kcmil	500 kcmil	500	500	500	—	¼	6.20	3.00	1.94	.27	1.33	.63	1.75	106	BLACK
58826BEBS	900	—	777 kcmil	—	—	—	—	—	¾	6.49	2.80	2.27	.30	1.50	.63	1.00	115	YELLOW

* = Cat 58180 is made of the same tubing as Cat. 54120. Cat. 54120 is listed for 600 mcm.

Tooling: pp. B76-B92

Die Selector Chart: pp. B93-B95

Color-Keyed Compression

United States
Tel: 901.252.8000
800.816.7809
Fax: 901.252.1354

Canada
Tel: 450.347.5318
Fax: 450.347.1976

Technical Services
Tel: 888.862.3289

Thomas&Betts

www.tnb.com

Connectors for Copper Conductor

Two-Barrel Lugs 600V to 35KV Applications

Material: High-Conductivity
Wrought Copper

Finish: Electro Tin Plate

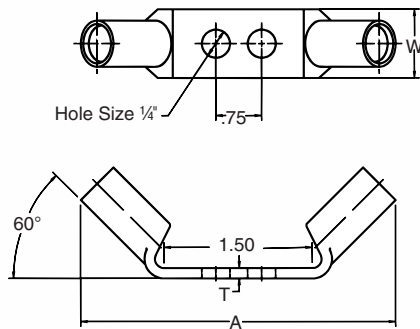

Figure 1

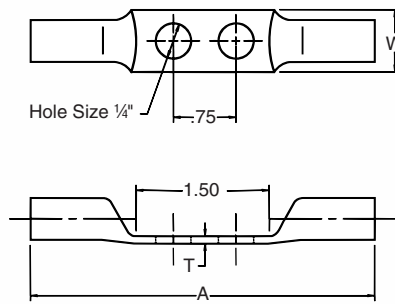

Figure 2



CAT. NO.	WIRE SIZE		HOLE SIZE (IN.)	FIG. NO.	DIMENSIONS (IN.)			DIE CODE	COLOR KEY
	CODE	FLEX			A	W	T		
256-30695-828	6	61/24	1/4	1	2 5/16	7/16	1/16	24	BLUE
256-30695-1227	6	61/24	1/4	2	3	7/16	1/16	24	BLUE

Tooling: pp. B76-B92

Die Selector Chart: pp. B93-B95

Connectors for Copper Conductor

Cast Copper One-Hole Lugs 600V to 35KV Applications — Heavy-Duty

Material: Cast Copper

Finish: Electro Tin Plate

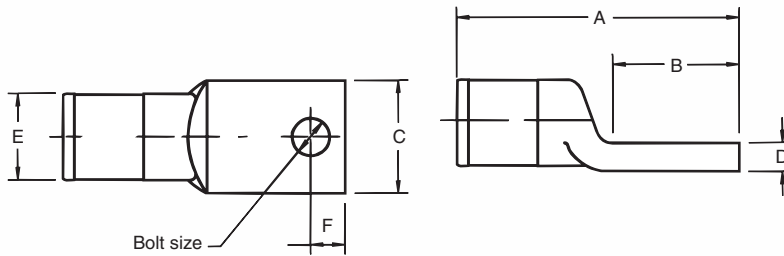

Color-Keyed® Compression



CAT. NO.	CABLE SIZE	DIMENSIONS (IN.)					BOLT SIZE (IN.)	DIE CODE
		A	B	C	D	F		
53104	8	1 ¹ / ₆	3 ⁴ / ₄	1 ¹ / ₂	1 ¹ / ₆	9 ¹ / ₃₂	#10	29
53105	6	1 ¹ / ₆	3 ⁴ / ₄	1 ¹ / ₂	1 ¹ / ₆	9 ¹ / ₃₂	1 ¹ / ₄	29
53106	4	1 ¹ / ₆	3 ⁴ / ₄	1 ¹ / ₂	1 ¹ / ₆	9 ¹ / ₃₂	1 ¹ / ₄	29
53107	2	2	1	3 ⁴ / ₄	1 ¹ / ₄	7 ¹ / ₁₆	1 ¹ / ₄	45
53108	1	2	1	3 ⁴ / ₄	1 ¹ / ₄	7 ¹ / ₁₆	1 ¹ / ₄	45
53109	1/0	2	1	3 ⁴ / ₄	1 ¹ / ₄	7 ¹ / ₁₆	3 ⁸ / ₈	45
53161**	325/24	2 ¹ / ₆	3 ⁴ / ₄	1 ³ / ₁₆	7 ¹ / ₃₂	7 ¹ / ₁₆	3 ⁸ / ₈	54
53110	2/0	2 ⁵ / ₈	1 ¹ / ₄	1	9 ¹ / ₃₂	11 ¹ / ₃₂	3 ⁸ / ₈	66
53111	3/0	2 ⁵ / ₈	1 ¹ / ₄	1	9 ¹ / ₃₂	11 ¹ / ₃₂	3 ⁸ / ₈	66
53112	4/0	2 ⁵ / ₈	1 ¹ / ₄	1	9 ¹ / ₃₂	11 ¹ / ₃₂	3 ⁸ / ₈	66
53165**	650/24	3 ³ / ₁₆	1 ³ / ₈	1 ³ / ₁₆	5 ¹ / ₁₆	3 ⁴ / ₄	1 ¹ / ₂	76
53113	250 kcmil	3 ³ / ₁₆	1 ¹ / ₂	1 ³ / ₁₆	5 ¹ / ₁₆	3 ⁴ / ₄	1 ¹ / ₂	76
53114	300 kcmil	3 ³ / ₁₆	1 ¹ / ₂	1 ³ / ₁₆	5 ¹ / ₁₆	3 ⁴ / ₄	1 ¹ / ₂	76
53115	350 kcmil	3 ¹³ / ₁₆	2	1 ¹ / ₈	3 ⁸ / ₈	13 ¹ / ₁₆	1 ¹ / ₂	99
53116	400 kcmil	3 ¹³ / ₁₆	2	1 ¹ / ₈	3 ⁸ / ₈	13 ¹ / ₁₆	1 ¹ / ₂	99
53118	500 kcmil	3 ³ / ₁₆	2	1 ¹ / ₈	3 ⁸ / ₈	13 ¹ / ₁₆	1 ¹ / ₂	99
53168**	1100/24	3 ³ / ₁₆	1 ¹ / ₈	1 ¹ / ₈	13 ¹ / ₃₂	7 ¹ / ₈	1 ¹ / ₂	107
53169**	1325/24	3 ³ / ₁₆	1 ¹ / ₈	1 ¹ / ₈	13 ¹ / ₃₂	7 ¹ / ₈	1 ¹ / ₂	107
53123	750 kcmil	4 ³ / ₁₆	2 ¹ / ₈	1 ¹ / ₈	7 ¹ / ₁₆	1	1 ¹ / ₂	112
53173**	2750/24*	5 ¹ / ₆	1 ¹ / ₈	2 ¹ / ₈	9 ¹ / ₁₆	1 ¹ / ₁₆	1 ¹ / ₂	150

All other Cat Nos.: Use hydraulic tools with hex dies.

** No UL/CSA

Tooling: pp. B76–B92

Die Selector Chart: pp. B93–B95

United States
Tel: 901.252.8000
800.816.7809
Fax: 901.252.1354

Canada
Tel: 450.347.5318
Fax: 450.347.1976

Technical Services
Tel: 888.862.3289

Thomas & Betts

www.tnb.com

Connectors for Copper Conductor

Cast Copper Two-Hole Lugs for Code Copper Cable 600V to 35KV

Material: Cast Copper

Finish: Electro Tin Plate

Details: 53273 2750/24 (1250 kcmil)
251-30485-1275

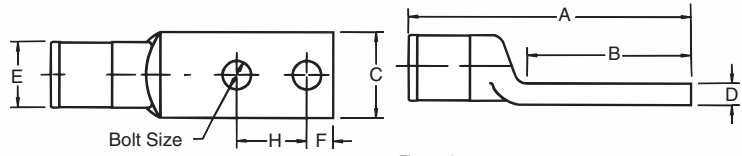
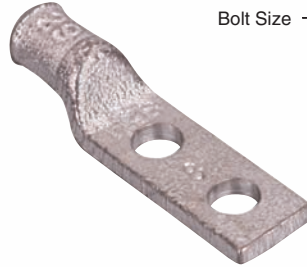

Figure 1

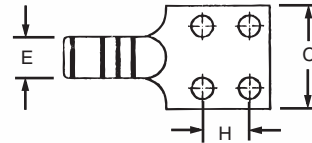

Figure 2



CAT. NO.	CODE CABLE SIZE	BOLT G SIZE (IN.)	DIMENSIONS (IN.)							DIE CODE	NO. OF CRIMPS		
			A APPROX. (IN.)	B	C	D	E	F	H		12 TON	15 TON	40 TON
256-30695-1055	#14-10	¼	2	1½	½	¾	¾	¼	¾ - ¾	29	1	1	1
53204	#8	¼	2	1½	½	¾*	¾	¼	¾	29	1	1	1
53205	#8	¼	2	1½	½	¾	¾	¼	¾	29	1	1	1
53206	#4	¼	2	1½	½	¾	¾	¼	¾	29	1	1	1
53207	#2	¼	3	2	¾	1½*	1½	½	¾	45	1	1	1
53208	#1	¼	3	2	¾	1½	1½	½	1	45	1	1	1
53209	1/0	¾	3	2	¾	1½	1½	½	1	45	1	1	1
53210	2/0	¾	4½	3	¾	1½*	2½	¾	1½	66	1	1	1
53211	3/0	½	4½	3	1	¾	2½	¾	1½	66	1	1	1
53212	4/0	½	4½	3	1	¾	2½	¾	1½	66	1	1	1
53213	250 kcmil	½	4½	3	1½	¾*	1½	¾	1½	76	1	1	1
53214	300 kcmil	½	4½	3	1½	¾	1½	¾	1½	76	1	1	1
53215	350 kcmil	½	5½	3½	1½	1½*	1½	¾	1½	99	2	1	1
53216	400 kcmil	½	5½	3½	1½	¾	1½	¾	1½	99	2	1	1
53218	500 kcmil	½	5½	3½	1½	¾	1½	¾	1½	99	2	1	1
53220M	600 kcmil	½	5½	3½	1½	1½	1½	¾	1½	112	2	1	1
53222M	700 kcmil	½	5½	3½	1½	±½	1½	¾	1½	112	2	1	1
53223M	750 kcmil	½	5½	3½	1½	±½	1½	¾	1½	112	2	1	1
53269	1325/24	½	5½	3½	1½	1½	1½	¾	1½	107	2	1	1
53224	800 kcmil	½	6	3½	1½	¾*	1½	¾	1½	130	—	1	1
53226	900 kcmil	½	6	3½	1½	1½	1½	¾	1½	130	—	1	1
53228	1000 kcmil	½	6	3½	1½	1½	1½	¾	1½	130	—	1	1
53273	1100 kcmil 2750/24	½	6½	3½	2½	¾	1½	¾	1½	—	—	—	—
53233	1500 kcmil	½	6½	3½	2½	½*	1½	¾	1½	150	—	1	1
53233L	1500 kcmil	½	7½	3½	2	½	1½	¾	1½	150	—	1	—
53432L**	1500 kcmil	½	7½	3½	3	½	1½	¾	1½	150	—	1	—
251-30485-1275	1250 kcmil	¾	6½	3½	2½	¾	1½	¾	1½	150	—	—	—
251-30485-1211	1750 kcmil	—	6½	3½	3	½	2½	—	—	175	—	—	2 (Fig. 2)
251-30485-1212	1750 kcmil	—	6½	3½	2½	½	2½	—	—	175	—	—	2 (Fig. 1)
53239	2000 kcmil 169/110	½	6½	3½	2½	½	2½	¾	1½	175	—	—	—
53239L	178/.104 2000 kcmil	½	7½	3½	2½	½	2½	¾	1½	175	—	—	—
53439L**	169/.110 178/.104 2000 kcmil	½	7½	3½	3	½	2½	¾	1½	175	—	—	11421 Die

* Denotes tongue thickness of alternate construction (Brazed wrought copper tongue).

** Figure 2. All others Figure 1.

Tooling: pp. B76-B92

Die Selector Chart: pp. B93-B95

Connectors for Copper Conductor

Two-Way Splice Connectors — Standard Barrel 600V to 35KV

Material: High-Conductivity Wrought Copper
Finish: Electro Tin Plate

Two-way connectors provide high pullout values, are easy to insulate and provide a low-resistance connection of high quality and low installed cost.

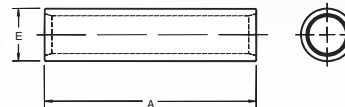

CAT. NO.	CODE	WIRE SIZE	DIMENSIONS (IN.)		DIE CODE	DIE COLOR
		FLEX CLASS G, H, I, K, M†	A	E		
54504	#8 AWG	37/24 = 14.9 kcmil, #8 Weld	1.00	.27	21	RED
54505	#6 AWG	61/24 = 24.6 kcmil, #6 Weld, 133/.014	1.00	.30	24	BLUE
54506	#4 AWG	91/24 = 36.7 kcmil, 133/.0177, 49/.029	1.00	.37	29	GRAY
54507	#2 AWG	125/24 = 50.4 kcmil, #4 Weld	1.25	.41	33	BROWN
54508	#1 AWG	150/24 = 60.5 kcmil, 175/24 = 70.6 kcmil, #2 Weld, 133/.0223	1.50	.47	37	GREEN
54509	1/0 AWG	225/24 = 90.8 kcmil, #1 Weld, 133/.0254	1.63	.52	42	PINK
54510	2/0 AWG	275/24 = 111 kcmil, 1/0 Weld, 427/.0155, 133/.0282	1.75	.57	45	BLACK
54511	3/0 AWG	325/24 = 131 kcmil, 2/0 Weld, 133/.0316, 259/.0227, 427/.0177	1.75	.63	50	ORANGE
53962		375/24 = 179 kcmil, 133/.0355, 259/.0255, 427/.0199	1.81	.70	50	ORANGE
54512	4/0 AWG	450/24 = 182 kcmil, 3/0 Weld, 703/.0154	1.88	.70	54	PURPLE
54513	250 kcmil		2.25	.77	62	YELLOW
53964		550/24 = 222 kcmil, 4/0 Weld, 133/.0399, 259/.0286, 637/.0183	2.13	.79	62	YELLOW
54514	300 kcmil	—	2.13	.83	66	WHITE
54515	350 kcmil	—	2.25	.90	71	RED
54516	400 kcmil	—	2.75	.93	76	BLUE
53968		1100/24 = 444 kcmil, 500 Weld, 259/.0417, 427/.0325, 703/.0253	3.00	1.13	87	BROWN
54518	500 kcmil	—	2.75	1.11	87	BROWN
54520	600 kcmil	—	3.00	1.18	94	GREEN
54522-TB	700 kcmil	—	3.25	1.23	99	PINK
53969		1325/24 = 535 kcmil, 427/.0342	3.00	1.24	99	PINK
54523-TB	750 kcmil	—	3.00	1.30	106	BLACK
54528	1000 kcmil	—	3.63	1.50	125	N/A
54530	1250 kcmil	—	4.13	1.67	140	N/A

† Contact Technical Services for specific stranding listings

Tooling: pp. B76-B92 Die Selector Chart: pp. B93-B95

Two-Way Splice Connectors — Long Barrel 600V to 35KV Applications

Material: High-Conductivity Wrought Copper
Finish: Electro Tin Plate

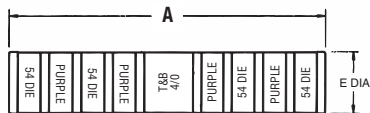

CAT. NO.	CODE	WIRE SIZE	DIMENSIONS (IN.)		DIE CODE	DIE COLOR
		FLEX CLASS G, H, I, K, M†	A	E		
54804	#8 AWG	37/24 = 14.9 kcmil	1.75	.27	21	RED
54805	#6 AWG	61/24 = 24.6 kcmil	1.75	.31	24	BLUE
54806	#4 AWG	91/24 = 36.7 kcmil	1.75	.39	29	GRAY
54807	#2 AWG	125/24 = 50.4 kcmil	1.88	.43	33	BROWN
54808	#1 AWG	150/24 = 60.5 kcmil, 175/24 = 70.6 kcmil	2.00	.49	37	GREEN
54809	1/0 AWG	225/24 = 90.8 kcmil	2.00	.54	42	PINK
54810	2/0 AWG	275/24 = 111 kcmil	2.13	.59	45	BLACK
54811	3/0 AWG	325/24 = 131 kcmil	2.25	.65	50	ORANGE
54812	4/0 AWG	450/24 = 182 kcmil	2.75	.72	54	PURPLE
54813	250 kcmil	550/24 = 222 kcmil	3.38	.79	62	YELLOW

CAT. NO.	CODE	WIRE SIZE	DIMENSIONS (IN.)		DIE CODE	DIE COLOR
		FLEX	A	E		
54814	300 kcmil	—	3.50	.87	66	WHITE
54815	350 kcmil	650/24 = 262 kcmil	3.75	.95	71	RED
54816	400 kcmil	775/24 = 313 kcmil	3.75	.98	76	BLUE
54818	500 kcmil	925/24 = 373 kcmil	4.75	1.11	87	BROWN
54820	600 kcmil	1100/24 = 444 kcmil	4.25	1.21	94	GREEN
54823	750 kcmil	1325/24 = 535 kcmil	4.75	1.34	106	BLACK
58524		1600/24 = 646 kcmil	5.00	1.39	106	BLACK
58526	900 kcmil	1925/24 = 777 kcmil	5.50	1.51	115	YELLOW
54828	1000 kcmil	—	5.63	1.56	125	N/A
54833	1500 kcmil	—	5.63	1.56	125	N/A
54839	2000 kcmil	—	7.06	2.125	—	N/A

† Contact Technical Services for specific stranding listings

Tooling: pp. B76-B92
 Die Selector Chart: pp. B93-B95

United States
 Tel: 901.252.8000
 800.816.7809
 Fax: 901.252.1354

Canada
 Tel: 450.347.5318
 Fax: 450.347.1976

Technical Services
 Tel: 888.862.3289

Thomas&Betts

www.tnb.com

Connectors for Copper Conductor

Copper Two-Way Splicers for 600V to 35KV Applications

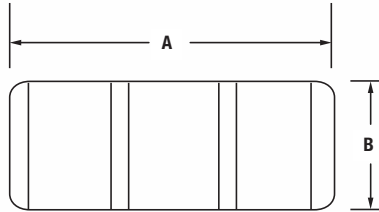

Color-Keyed® Compression

CAT. NO.	CABLE+ SIZE	DIMENSIONS (IN.)		INSTALLING TOOLS		
		A	B	DIE SET CAT. NO.	STRIP LENGTH (IN.)	COLOR CODE
54006	#4 AWG	2.00	.37	15CA29R	1½	GRAY
54007	#2 AWG	2.13	.41	15CA33R	1¾	BROWN
54008	#1 AWG	2.25	.47	15CA37R	1¾	GREEN
54009	1/0 AWG	2.38	.52	15CA42R	1¾	PINK
54010	2/0 AWG	2.38	.57	15CA45R	1¾	BLACK
54011	3/0 AWG	2.63	.63	15CA49R	1⅞	ORANGE
54012	4/0 AWG	2.69	.69	15CA54R	1⅞	PURPLE
54013	250 kcmil	3.19	.74	15CA60R	2¼	RUBY
54015	350 kcmil	4.13	.89	15CA71R	2¾	RED
54018	500 kcmil	4.13	1.06	15CA87R	2¾	BROWN
54023	750 kcmil	4.75	1.30	15CA106R	2¾	BLACK

* Cat. No. 15500-TB Die Adaptor required for TBM15I

+ Cable Size: Concentric and Compact strandings

Tooling: pp. B76-B92

Die Selector Chart: pp. B93-B95

Cast-Copper Two-Way Splice Connectors for 600V to 35KV Applications — Heavy-Duty



Material: Cast Copper

Finish: Electro Tin Plate

Satisfies requirements of NEC250-81 and 250-91 for connecting to the grounding electrode system.

AT. NO.	CABLE SIZE	DIE CODE
3504	8 AWG	29
53505	6 AWG	29
53506	4 AWG	29
53507	2 AWG	45
53508	1 AWG	45
53509	1/0 AWG	45
53510	2/0 AWG	66
53511	3/0 AWG	66
53512	4/0 AWG	66
53513	250 kcmil	76
53515	350 kcmil	99
53518	500 kcmil	99
53523	750 kcmil	112

Use hydraulic tools with hex dies.

Tooling: pp. B76-B92

Die Selector Chart: pp. B93-B95

Connectors for Copper Conductor

Compact design for low-profile installation.

Copper Reducing Splices

Thomas & Betts copper reducing splices are the most recent addition to the telecom line of copper compression lugs and connectors. They are designed for use in Central Office Equipment Installations in place of H-Taps in applications where the main cable is stepped down. When space is at a premium and standard H-Tap splicing options are too cumbersome, the Thomas & Betts reducing splices can be the right choice. These splices are available for a range of cables from 750 Flex to 6 Code.

- Requires less “real estate” in a Central Office
- Does not require a cover other than clear heat shrink
- One-person installation. Each side crimped separately
- Utilizes standard lug crimping dies. More standard tooling options. Lower tonnage tools can now install even the largest splice
- Hand tools can be used on splices for 500 Code/350 Flex and smaller
- Inspection holes verify cable is fully inserted into each barrel

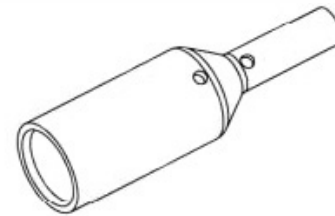

Splices for the following cable combinations are available. Appropriate quantities of pre-cut lengths of UL listed clear heat shrink are provided with each splice:

CAT. NO.	MAIN	COLOR CODE	BRANCH	COLOR CODE
TBRS75F-75C50FHS	750 Flex	YELLOW	750 Code/500 Flex	BLACK
TBRS75F-50C35FHS	750 Flex	YELLOW	500 Code/350 Flex	BROWN
TBRS75F-25C4/0FHS	750 Flex	YELLOW	250 Code/4/0 Flex	YELLOW
TBRS75C50F-75C50FHS	750 Code/500 Flex	BLACK	750 Code/500 Flex	BLACK
TBRS75C50F-50C35FHS	750 Code/500 Flex	BLACK	500 Code/350 Flex	BROWN
TBRS75C50F-25C4/0FHS	750 Code/500 Flex	BLACK	250 Code/4/0 Flex	YELLOW
TBRS75C50F-4/0CHS	750 Code/500 Flex	BLACK	4/0 Code	PURPLE
TBRS4/0C-2CHS	4/0 Code	PURPLE	2 Code	BROWN
TBRS4/0C-6CHS	4/0 Code	PURPLE	6 Code	BLUE
TBRS2/0C1/0F-2CHS	2/0 Code/1/0 Flex	BLACK	2 Code	BROWN
TBRS2/0C1/0F-6CHS	2/0 Code/1/0 Flex	BLACK	6 Code	BLUE
TBRS1/0C1F-2CHS	1/0 Code/1 Flex	PINK	2 Code	BROWN
TBRS1/0C1F-6CHS	1/0 Code/1 Flex	PINK	6 Code	BLUE
TBRS2C-6CHS	2 Code	BROWN	6 Code	BLUE

Tooling: pp. B76–B92

Die Selector Chart: pp. B93–B95

Connectors for Copper Conductor

Constant O.D. enables faster, easier installation than contoured design.

Cast-Copper Reducing Splices



Color-Keyed® Compression



Thomas & Betts takes the splicing of different-sized conductors to a new level of economy and efficiency with Color-Keyed Cast-Copper Reducing Splices. In addition to a lower cost, the key benefit to these splices is in their constant outer diameter. Unlike screw-machined, externally contoured splices, Cast-Copper Reducing Splices require no change of tool or die between crimping each end. Just slide

each wire easily into the chamfered barrel, and use the same Color-Keyed tool and die to crimp both ends. The consistent O.D. also makes these splices faster and easier to insulate with clear heat-shrink wrap than a contoured splice. Sand-cast construction ensures high tensile strength for heavy-duty applications, and tin-plated copper material provides high conductivity and superior corrosion-resistance.

- Ideal for telecom (inside office/outside plant), commercial, industrial MRO, and any other 600V-35KV applications requiring splicing of different-sized conductors
- Tin-plated, sand-cast copper construction provides superior tensile strength, high conductivity, and excellent corrosion-resistance
- Easier to install and insulate than screw-machined, contour-designed reducing splices
- Constant O.D. saves time on installation by eliminating the need for crimp-tool/die change
- Fast and simple to insulate with clear or colored heat-shrink wrap
- Chamfered barrel facilitates easy wire insertion
- Compact, low-profile design takes up minimal space in cable tray or wire run
- Simple installation with Color-Keyed® crimp tools

CAT. NO.	COND. 1 SIZE	COND. 2 SIZE	DIM. A	DIM. E	DIE CODE	DIE COLOR
251-30485-19	4/0 Str.	2 Str.	2 1/4"	1 1/16"	66	WHITE
251-30485-91	500mcm Str.	300mcm Str.	3 1/16"	1 1/16"	99	PINK
251-30485-229	2/0 Str.	250mcm Str.	2 3/8"	1 5/16"	76	BLUE
251-30485-247	2 Str.	8 Str.	1 9/16"	1 9/32"	45	BLACK
251-30485-294	4 Str.	2/0 Str.	2 1/4"	2 1/32"	66	WHITE
251-30485-295	4/0 Str.	4 Str.	2 1/4"	1 1/16"	66	WHITE
251-30485-331	4/0 Str.	350mcm Str.	3 5/16"	1 7/32"	99	PINK
251-30485-445	4/0 Str.	2/0 Str.	2 1/4"	1 3/16"	66	WHITE
251-30485-495	1/0 Str.	2 Str.	1 1/16"	1 1/32"	45	BLACK
251-30485-610	6 Str.	8 Str.	1 1/32"	3/4"	29	GRAY
251-30485-611	4 Str.	8 Str.	1 1/32"	3/4"	29	GRAY
251-30485-612	4 Str.	6 Str.	1 1/32"	3/4"	29	GRAY
251-30485-613	2 Str.	6 Str.	1 1/16"	1 9/32"	45	BLACK
251-30485-640	4/0 Str.	1/0 Str.	2 1/4"	1 3/16"	66	WHITE
251-30485-653	2 Str.	250mcm Str.	2 3/8"	1 5/16"	76	BLUE
251-30485-739	1/0 Str.	250mcm Str.	2 3/8"	1 5/16"	76	BLUE
251-30485-882	400mcm Str.	350mcm Str.	3 5/16"	1 7/32"	99	PINK
251-30485-950	1/0 Str.	6 Str.	1 1/16"	1 9/32"	45	BLACK
251-30485-951	6 Str.	2/0 Str.	2 1/4"	2 1/32"	66	WHITE
251-30485-1027	1/0 Str.	4 Str.	1 1/16"	1 9/32"	45	BLACK
251-30485-1029	1/0 Str.	#12 Str.	1 1/16"	2 3/64"	45	BLACK
251-30485-1030	10 Str.	4 Str.	1 1/32"	3/4"	29	GRAY
251-30485-1031	12 Str.	4 Str.	1 1/32"	3/4"	29	GRAY
251-30485-1032	#6 Str.	#10 Str.	1 1/32"	3/4"	29	GRAY
251-30485-1033	12 Str.	6 Str.	1 1/32"	3/4"	29	GRAY
251-30485-1034	14 Str.	8 Str.	1 1/32"	3/4"	29	GRAY
251-30485-1035	1 Str.	1/0 Str.	1 1/16"	1 9/32"	45	BLACK
251-30485-1044	10 Str.	8 Str.	1 1/32"	3/4"	29	GRAY
251-30485-1045	12 Str.	8 Str.	1 1/32"	3/4"	29	GRAY
251-30485-1085	10 Str.	1/0 Str.	1 1/16"	1 9/32"	45	BLACK
251-30485-1086	10 Str.	2/0 Str.	2 1/4"	2 1/32"	66	WHITE
251-30485-1087	4 Str.	250mcm Str.	2 3/8"	1 5/16"	76	BLUE
251-30485-1088	400mcm Str.	250mcm Str.	3 5/16"	1 7/32"	99	PINK
251-30485-1089	14 Str.	8 Sol.	1 1/32"	3/4"	29	GRAY
251-30485-1090	12 Str.	8 Sol.	1 1/32"	3/4"	29	GRAY
251-30485-1091	10 Str.	8 Sol.	1 1/32"	3/4"	29	GRAY
251-30485-1092	12 Str.	6 Sol.	1 1/32"	3/4"	29	GRAY
251-30485-1093	8 Str.	6 Sol.	1 1/32"	3/4"	29	GRAY
251-30485-1094	4 Str.	6 Sol.	1 1/32"	3/4"	29	GRAY
251-30485-1095	2 Str.	6 Sol.	1 1/16"	1 9/32"	45	BLACK
251-30485-1096	12 Str.	4 Sol.	1 1/32"	3/4"	29	GRAY
251-30485-1097	10 Str.	4 Sol.	1 1/32"	3/4"	29	GRAY
251-30485-1098	8 Str.	4 Sol.	1 1/32"	3/4"	29	GRAY
251-30485-1099	6 Str.	4 Sol.	1 1/32"	3/4"	29	GRAY
251-30485-1100	1/0 Str.	4 Sol.	1 1/16"	1 9/32"	45	BLACK
251-30485-1130	Cast Solid*	12-4 Str.	1 3/8"	3/4"	29 1	BLACK
251-30485-1245	1/0 Flex	#4 Flex	2 1/4"	1 1/16"	66	WHITE
251-30485-1246	#4 Flex	#8 Flex	1 1/16"	3 3/64"	45	BLACK

*Cast Solid — Field Modifiable Special

C-Tap Connectors for Copper Conductor

Positive, all-around compression with low resistance and high pull-out values.

C-Taps for 600V Applications

- Ideal for pigtail, 2-way splicing or tapping to an unbroken continuous main
- Heavy reinforcing ribs help locate compression dies and strengthen compressed joint

Material: High-Conductivity Wrought Copper

Finish: Plain

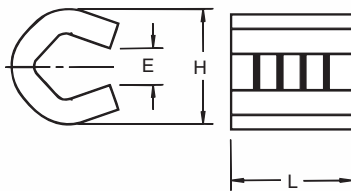

Figure 1

"E" represents gap in side

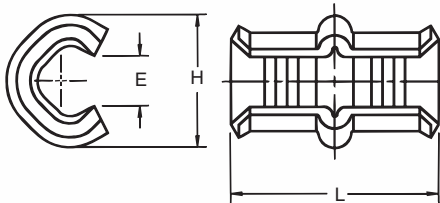

Figure 2

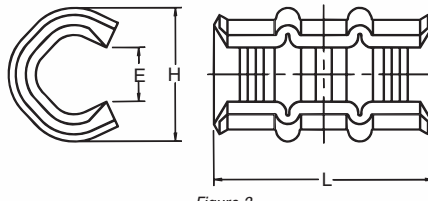

Figure 3



Cat. No.	FIG. NO.	DIMENSIONS (IN.)			COLOR KEY
		L	H	E	
54705	1	5/16	5/16	7/64	RED
54710	1	9/16	7/16	9/64	BLUE
54715	1	9/16	5/8	1/64	GRAY
54720	2	1 1/2	1 1/16	7/32	BROWN
54725	2	1 5/8	13/16	1/4	GREEN
54730	2	1 5/8	27/32	9/32	PINK
54735	3	1 11/16	7/8	23/64	BLACK
54740	3	1 11/16	31/32	23/64	ORANGE
54745	3	1 11/16	1 1/16	13/32	PURPLE
54750	3	1 11/16	1 1/8	13/32	YELLOW

UL approved for direct burial.

For covers see **page B48**.

Taps can be supplied tin-plated. Add suffix "TP" to any catalog number (i.e., 54725TP).

Typical Cable Combinations

MAIN	BRANCH							
	#12 SOL. OR STR.	#10 SOL. OR STR.	#8 SOL. OR STR.	#6 SOL. OR STR.	#4 STR.	#2 STR.	#1 STR.	1/0 STR.
#10 Sol. or Str.	54705	54710	54715	54715	54720	54730	54735	54740
#8 Sol. or Str.	54710	54715	54715	54720	54720	54730	54735	54740
#6 Sol. or Str.	54715	54715	54720	54720	54725	54730	54735	54740
#4 Str.	54720	54720	54720	54725	54730	54735	54740	54740
#2 Str.	54730	54730	54730	54730	54735	54740	54745	54745
#1 Str.	54735	54735	54735	54735	54740	54745	54745	54750
1/0 Str.	54740	54740	54740	54740	54740	54745	54750	54750
2/0 Str.	54745	54745	54745	54745	54745	54750	54750	
3/0 Str.	54750	54750	54750	54750	54750	54750		

Tooling: **pp. B76–B92**

Die Selector Chart: **pp. B93–B95**

United States
Tel: 901.252.8000
800.816.7809
Fax: 901.252.1354

Canada
Tel: 450.347.5318
Fax: 450.347.1976

Technical Services
Tel: 888.862.3289

Thomas & Betts

www.tnb.com

C-Tap Connectors for Copper Conductor

Easy to work with in tight spaces.

C-Taps — Large Size for 600V Applications

- More economical than other taps and split bolts in terms of purchase, inventory, installation time, insulation and maintenance
- Color-coded for easy matching with proper die
- Barely larger than conductor insulation once installed

Material: High-Conductivity Wrought Copper

Finish: Plain

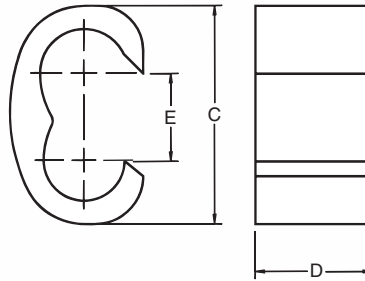

CAT. NO.	WIRE SIZE		DIMENSIONS (IN.)			INSTALLING DIE		DIE CODE	NO. OF CRIMPS	COLOR KEY
	MAIN	BRANCH	C	D	E	TOOL	CAT NO.			
54755	#1	#1								BLUE
	1/0	1/0-#2				TBM14M	15512	76	1	
	2/0	2/0-#4	1 ¹ / ₁₆	3/4	1 ¹ / ₂	TBM15I	15512*	76		
	3/0	1/0-#6				TBM12	TBM12D-4	76		
4/0	#1-#8				13100A	15512	76			
54760	2/0	2/0-#1				TBM14M	15506	87H	2	BROWN
	3/0	3/0-#3	1 ¹ / ₁₆	3/4	1 ¹ / ₂	TBM15I	15506*	87H		
	4/0	4/0-#4				TBM12	TBM12D-3	87H		
	250 kcmil	#1-#8				13100A	15506	87H		
54765	2/0	2/0-#1				TBM14M	15505	99H	2	PINK
	3/0	3/0-#2				TBM15I	15505*	99H		
	4/0	4/0-#4	1 ¹ / ₁₆	1	4 ¹ / ₄	TBM12	TBM12D-2	99H		
	250 kcmil	3/0-#6				13100A	15505	99H		
54770	4/0	4/0-2/0				TBM14M	15515	106H	2	BLACK
	250 kcmil	250-#1	1 ¹ / ₁₆	1	1 ¹ / ₁₆	TBM15I	15515*	106H		
	300 kcmil	4/0-#4				TBM12	TBM12D-2	106H		
	350 kcmil	3/0-#6				13100A	15515	106H		
54775**	250 kcmil	250 kcmil				TBM14M	15504	115H	2	YELLOW
	300 kcmil	300-3/0				TBM15I	15504*	115H		
	350 kcmil	350-1/0	1 ¹ / ₁₆	1 ¹ / ₄	1 ¹ / ₁₆	TBM12	TBM12D-1	115H		
	400 kcmil	300-#2				13100A	15504	115H		
	450 kcmil	250-#4								
500 kcmil	250-#6									
54780	350 kcmil	350-4/0				TBM15I	15603	125H	2	N/A
	400 kcmil	400-2/0	2 ³ / ₁₆	1 ¹ / ₄	5 ³ / ₄					
	450 kcmil	450-#1								
	500 kcmil	500-#2								
54785	750 kcmil	4/0-#6	2 ¹ / ₁₆	2	1	TBM15I	15603	125H	3	N/A
54790	750 kcmil	750-4/0	2 ¹ / ₁₆	2	1 ¹ / ₁₆	TBM15I	15603	125H	3	N/A

UL approved for direct burial.

For covers see page B48.

Taps can be supplied tin-plated. Add suffix "TP" to any catalog number (i.e., 54725TP).

* Cat. No. 15500-TB adapter required if using TBM15I and 155XX series dies.

** #6 AWG branch must be doubled.

Tooling: pp. B76-B92

Die Selector Chart: pp. B93-B95

Copper H-Tap Connectors for Copper Conductor

Copper H-Taps — 600V Application

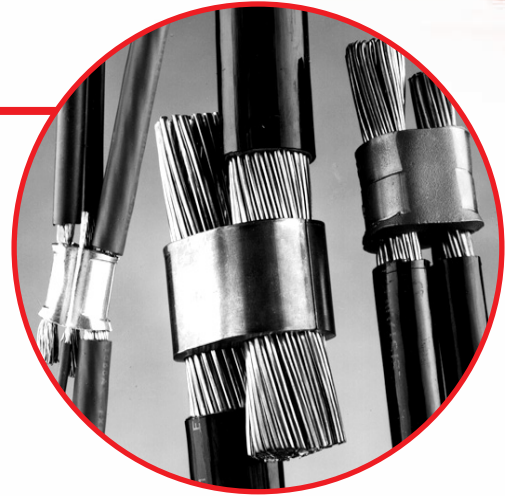
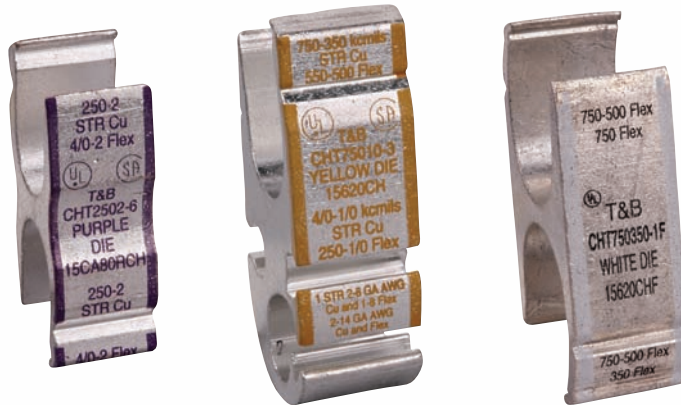

Color-Keyed Compression



CAT. NO.	FIG. NO.	COLOR CODE	CONDUCTOR SIZE CODE (FLEX CABLE)				CRIMPING INFORMATION						
			MAIN	BRANCH 1	BRANCH 2	BRANCH 3	HYDRAULIC HEAD	INSTALLING DIE	# OF CRIMPS	COLOR CODE	DIE CODE	STRIP LENGTH	INSULATING COVERS
CHT750350-1F	1	WHITE	(750-500) (750) Flex Only	(750-500) (350) Flex Only	—	—	TBM15I	15620CHF	1	WHITE	F	1 1/8"	HTC1000
CHT750350-2	2	YELLOW	750-500 (550-500)	750-500 (550-350)	—	—	TBM15I	15620CH	1	YELLOW	Z	1 1/8"	HTC500
CHT75010-3	9	YELLOW	750-350 (550-500)	4/0-1/0 (250-1/0)	1 Str. 2-6 AWG (1-8)	2-14 (2-14)	TBM15I	15620CH	1	YELLOW	Z	1 1/8"	
CHT50040-4	2	BROWN	500-250 (350-4/0)	500-4/0 (350-4/0)	—	—	TBM15I	15612CH	2	BROWN	N	1 1/8"	HTC40
CHT50010-5	3	BROWN	500-4/0 (350-4/0)	250-1/0 (4/0-1/0)	1 Str. 2-6 AWG (1-8)	8-14 (8-14)	TBM15I	15612CH	2	BROWN	N	1 1/8"	
CHT2502-6	2	PURPLE	250-2 (4/0-2)	250-2 (4/0-2)	—	—	•TBM15I TBM14M	15CA80RCH	1	PURPLE	80R	3/8"	HTC40
CHT25014-7	4	PURPLE	250-2 (4/0-2)	2-6 Str/Sol (2-8)	8-14 (8-14)	—	•TBM15I TBM14M	15CA80RCH	1	PURPLE	80R	1 1/8"	
CHT250214-8	5	PURPLE	250-2 (4/0-2)	8-14 (8-14)	8-14 (8-14)	—	•TBM15I TBM14M	15CA80RCH	1	PURPLE	80R	1 1/8"	
CHT214-9	6	BROWN	2-6 Str/Sol (2-8)	2-6 Str/Sol (2-8)	8-14 (8-14)	8-14 (8-14)	•TBM15I TBM14M 13100A	15CA71RCH	3	BROWN	71R	7/8"	HTC2S
CHT814-10	7	GREEN	8-14 (8-14)	8-14 (8-14)	—	—	•TBM15I TBM14M 13100A	15CA37RCH	1	GREEN	37R	1/2"	
CHT75040-11	8	YELLOW	750 Str. (750-500)	350-4/0 Str. Cu. & Flex	—	—	TBM15I	15620CH	1	YELLOW	Z	1 1/8"	HTC500

• Requires adapter Cat. No. 15500-TB when used with hydraulic head TBM15I.
 Material: Copper per ASTM designation
 B-124-55 Alloy 12
 Available packaged with HTC series covers Add "WC" to standard catalog number.
 Tooling: pp. B76-B92
 Die Selector Chart: pp. B93-B95

United States
 Tel: 901.252.8000
 800.816.7809
 Fax: 901.252.1354

Canada
 Tel: 450.347.5318
 Fax: 450.347.1976

Technical Services
 Tel: 888.862.3289

Thomas & Betts

www.tnb.com

Copper H-Tap Connectors for Copper Conductor

Copper H-Taps — 600V Application (continued)

Material: High-Conductivity Extruded Copper

Finish: Electro Tin Plate

Color-Keyed Compression

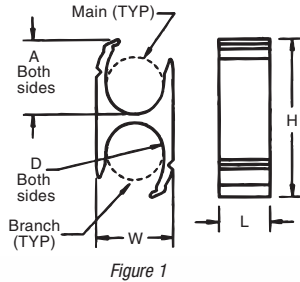

Figure 1

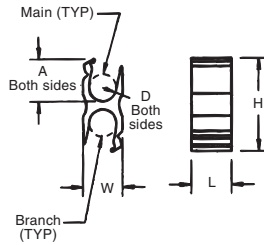

Figure 2

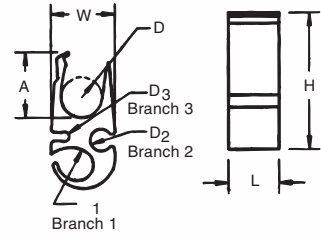

Figure 3

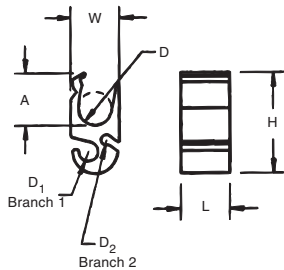

Figure 4

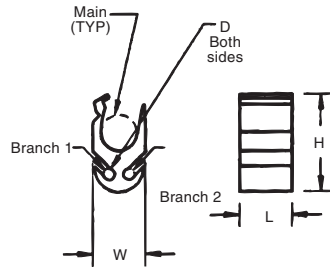

Figure 5

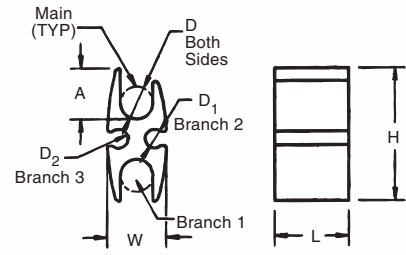

Figure 6

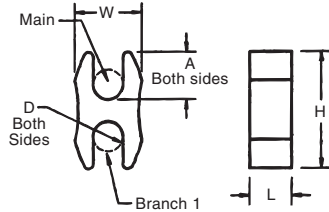

Figure 7

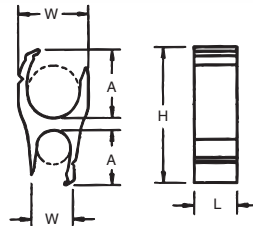

Figure 8

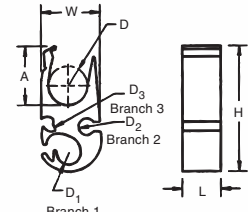

Figure 9



CAT. NO.	FIG. NO.	DIMENSIONS (IN.)							STRIP LENGTH (IN.)	INSULATING COVERS	
		H	W	L	A	D	D1	D2			D3
CHT750350-1F	1	3.46	1.66	1.10	1.73	1.23	—	—	—	1½	HTC1000
CHT750350-2	2	3.24	1.50	1.25	1.62	1.02	—	—	—	1½	
CHT75010-3	9	3.13	1.50	1.00	1.54	1.00	.40	0.35	0.41	1½	
CHT75040-11	8	3.19	(1) 1.65	1.00	(1) 1.61	(1) 1.24	—	—	—	1½	HTC500
				(2) 1.05		(2) 1.29	(2).80				
CHT50040-4	2	2.64	1.18	1.00	1.32	.80	—	—	—	1½	HTC40
CHT50010-5	3	2.28	1.30	1.00	1.20	.80	.67	.19	0.43	1½	
CHT2502-6	2	1.99	0.90	0.66	1.00	0.62	—	—	—	¾	
CHT25014-7	4	1.63	.90	.90	.96	.52	0.35	0.19	—	1½	HTC2S
CHT250214-8	5	1.63	.90	.90	.96	0.62	0.19	0.19	—	¾	
CHT214-9	6	1.35	.60	0.75	0.50	0.33	0.19	0.19	—	¾	
CHT814-10	7	.62	0.60	0.37	0.25	0.16	—	—	—	¾	

Aluminum H-Tap Connectors

Exclusive FILLERLOK tab design.

Compression Taps for 600V — 90° C Applications

- H-type compression taps
- For aluminum-to-aluminum, aluminum-to-copper and copper-to-copper stranded-conductor applications
- Concentric and compact code strandings

Material: High-Conductivity Wrought Aluminum



Color-Keyed® Compression



CAT. NO.	COMBINATIONS		SIDE TAP	LENGTH (IN.)	COLOR KEY	DIE CODE CAT. NO.			
	MAIN	BRANCH				TBM6-TBM6S TBM6ORS	HYDRAULIC TBM14M 13100A	TBM12 12-TON HEAD	TBM15I 15-TON HEAD
63105†	2-6	8-14	—	¾	ORANGE	13474 upper 13477 lower	15530	TBM12D-4	15530*
63110	4-6	4-6	—	1½	GREEN	13470	15501A	TBM12D-H	15001A*
63118	2/0-2	8-14	—	¾	GREEN	13470	15501A	TBM12D-H	15501A*
63125	2/0-2	1/0-6	—	1½	GREEN	13470	15501A	TBM12D-H	15501A*
63140	4/0-2/0	2-10	—	1½	BLUE	13471	15502	TBM12D-H	15502*
63148•	4/0-2/0	3/0-1	8-14	3	BLUE	—	15502	TBM12D-H	15502
63160	500-4/0	4/0-2	2-6	2¾	RED	—	—	—	15612
63169	750-4/0	750-4/0	—	3	BLACK	—	—	—	15620
63170	1000-500	1000-1/0	—	6	BLACK	—	—	—	15620
63180	750-350	350-1/0	1-6	3	BLACK	—	—	—	15620

* Use with adaptor Cat. No. 15500-TB

† 63105 also installed by TBM5/TBM5S with 13455 die or TBM8/TBM8S with 13462 die.

• 63148 — #1 CU or AL - wire bent double (hairpin)

For Smart Tool Installation

63110, 63118, 63125:

63140, 63148:

Use TBM8-750HG

Use TBM8-750BH

Tooling: pp. B76-B92

Die Selector Chart: pp. B93-B95

Interlocking Insulating Covers for H- and C-Type Compression Taps

Better covers for taps.

Soft Shell H-Tap/ C-Tap Covers

Thomas & Betts offers an improved design for one-piece covers of H-Tap and C-Tap connectors. The new design is more size-efficient and includes an easy latch mechanism. The new covers also contain flash barriers to help protect against electrical flashovers. The covers are molded from high impact polypropylene (UL94V-1) and are UL listed, CSA certified to 600V applications at 105° C.

Color-Keyed® Soft Shell Covers include these features:

- **Size-efficient design**
Won't take up as much room in the enclosure or vault, easier to store and carry to the job site
- **Easy Latch Mechanism**
Quick but sturdy cover latch for optimum insulation
- **Flash Barriers**
Provides protection from electrical flashovers
- **105° C Rating**
Offers maximum performance and higher than many competitor's temperature ratings
- **High-Impact Polypropylene**
Constructed from rugged materials for long-lasting protection

Also available in clear, impact-resistant and flame-retardant polycarbonate (UL94 V-0). The clear version includes an internal pocket for a visible identification label without opening the cover. Contact Customer Service for shipping and availability. See HTCVC2CLRFR-SD in table.



Smaller size requires less space in enclosure

High-impact polypropylene for rugged, dependable use

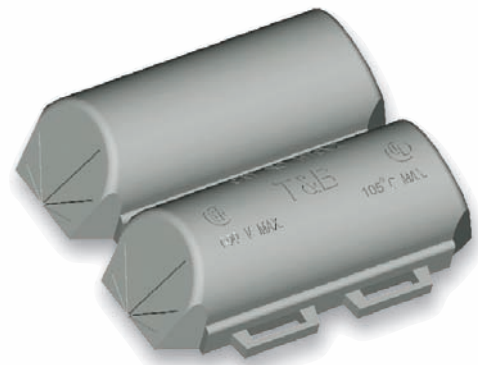

Easy latch mechanism



Clear, polycarbonate (UL94V-0) version available

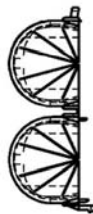
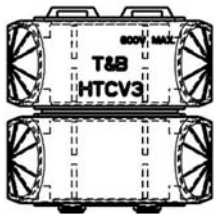
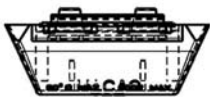

CAT. NO.	FOR H-TAPS	FOR C-TAPS	DIMENSIONS (IN.)			PKG. QTY.
			A	B	C	
HTCV1	CHT814-10	54705, 54710, 54715	1 3/4	7/8	5/8	5
HTCV2	CHT214-9, CHT250214-8, CHT25014-7, CHT2502-6	54770, 54775, 54780	3%	1 1/8	1	5
	CHT50010-5, CHT50040-4	54740, 54745, 54750, 54755, 54760, 54765	3 3/32	1%	1 1/8	5
HTCV4	CHT75010-3, CHT750350-2, CHT750350-1F, CHT75040-11	N/A	5%	2	1 1/8	5
HTCV2CLRFR	CHT214-9, CHT250214-8, CHT25014-7, CHT2502-6	N/A	3%	1 1/8	1	5

Interlocking Insulating Covers for H-Type Compression Taps

Quick and easy insulation for H-type compression taps.

Tap Insulating Covers (Soft Cover)

- Eliminates taping
- Provided with three positive locking latches and overlapping fringe for maximum cable insulation

Specifications

- Rating: 90° C, 600V. Made of flame-retardant, high-impact polypropylene.
- Material: Polypropylene
- Color: Black
- Voltage Rating: 600V max.
- Temperature: 90° C

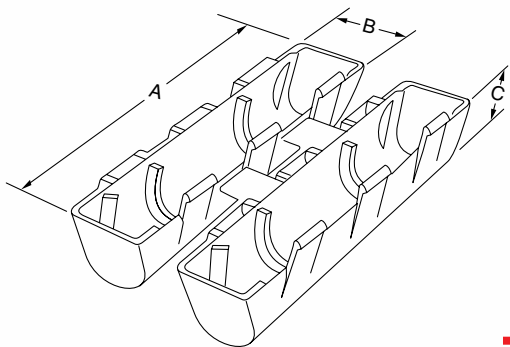

(C) Height — typical both halves



CAT. NO.	WIRE RANGE		AL H-TAPS	USE TO INSULATE	DIMENSIONS (IN.)			"A" DIM. "B" DIM.	
	MAX.	MIN.			A	B	C		
HT20C	2/0	6	63110/63115 63125/63120	—	4½	1¼	1½	—	—
HT40C	4/0	6	63140 63148	—	5¾	1½	1¾	—	—
HT600C	500 MCM	2	63160	63169	6¾	2½	1¾	—	—
HT1000C	1000 MCM to 500 MCM	250 MCM to 1/0 AWG	63180	—	—	—	—	[184.15MM] 7.250	2.330 +.060
HT1000C-L	1000 MCM to 500 MCM	250 MCM to 250 MCM	63170	—	—	—	—	1263.40MM 10.374	2.330 +.060

Interlocking Insulating Covers for H-Type Compression Taps

H-Tap Insulating Covers (Hard Covers)

- For use in splice boxes, indoors or in tray indoors
- Easy to use — simply place H-Tap in cover and snap cover closed
- Consult factory for available flame-retardant version
- Hard shell outer covers guard against impact... inner seal keeps out dust
- Installs quickly and easily without special tools — simply snaps together
- Eliminates time-consuming taping
- Provides high-quality, neat, uniform installations
- Range-taking design reduces inventory



CAT. NO.	DIMENSIONS (IN.)		
	A (LENGTH)	B (THICK)	C (WIDTH)
HTC2S	2	1 1/8	1 1/8
HTC2	3 1/2	1 1/8	1 1/8
HTC40	4 1/4	1 1/8	2
HTC40L2	5 1/4	1 1/8	2
HTC500	6	1 3/4	2 1/4
HTC1000	7	2 1/2	3 1/4
HTC1000L	10	2 1/2	3 1/4

Interlocking insulating covers for "H" type compression taps. For use in splice boxes, indoors or in tray indoors. Place the H-Tap in the cover. Snap the cover closed. Consult factory for flame-retardant version.

Technical Data:

HTC2 and HTC2S use insulation wrap instead of end cushions for inner seal.

Connector Cat. Nos. 54755 through 54790 and 63148 through 63180 require hydraulic crimping tools. Refer to instruction sheets.

Outer Hard Shell Covers — High Impact Black Thermoplastic (Noryl) Flammability Class, UL 94V-1

Inner seal — Black neoprene sponge soft closed cell, oxygen index 28% UL 94 HBF

Temperature Rating — 90° C Maximum

Voltage Rating — 600V maximum

Uses insulation wrap instead of end cushions for inner seal.

NOTE: Insulation covers are not reusable.

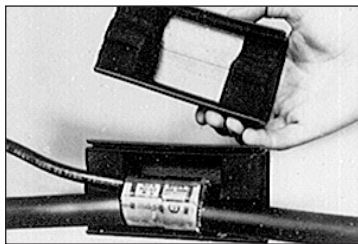
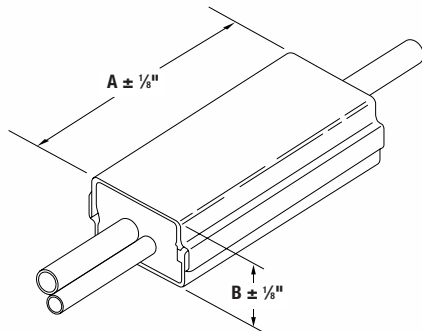

These insulating covers provide hard shell insulated protection for "H" type compression taps and splices, and because there is no taping required, you get uniform quality and appearance each time. The exclusive locking design provides the range taking capability. Only five H-tap insulating catalog cover numbers accommodate the range of 6 AWG — 1000 kcmil in the main, and 12 AWG — 500 kcmil in the branch.

For H-Tap Applications

CAT. NO.	AL	CU
	H-TAP	H-TAP
HTC2	63105	
HTC2S		CHT814-10
HTC40	63110	CHT214-9
	63118	CHT250214-8
	63125	CHT2514-7
	63140	CHT2502-6
HTC500	63148	CHT50010-5/CHT50040-4
	63160	CHT75010-3/CHT750350-2
HTC1000L	63170	
HTC1000	63180/63169	CHT750350-1F

For C-Tap Applications

CAT. NO.	C-TAP	COLOR
		CODE
HTC40	54720	BROWN
	54725	GREEN
	54730	PINK
	54755	BLUE
	54760	BROWN
HTC40L2	54735	BLACK
	54740	ORANGE
	54745	PURPLE
	54750	YELLOW
HTC500	54765	PINK
	54770	BLACK
	54775	YELLOW
	54780	WHITE
	54785	N/A
	54790	N/A

Wire Joints for Copper Conductor

All-around compression ensures high conductivity, low resistance and high pull-out values exceeding UL requirements.

Compression Wire Joints for Copper Conductor

- Ideal for pigtail, tapping multiple conductors or 2-way splicing
- Form a permanent installation in minimal space
- Easily insulated
- Offer lowest installed cost
- Made of high-conductivity copper and electro-tin-plated
- Colored-coded to dies for positive matching and compression

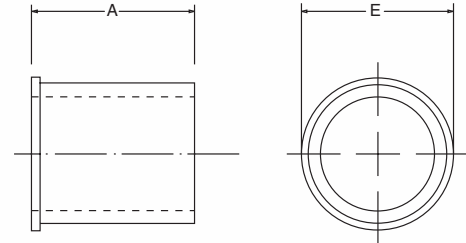

Color-Keyed® Compression



CAT. NO.	CIRCULAR MIL AREA		CONNECTOR RANGE				DIM. (IN.)	COLOR CODE	INSTALLING TOOLS				
	MIN.	MAX.	CABLE COMBINATION		A	E			HAND TOOLS			TBM6 & TBM6S	
			MIN.	MAX.					TBM25S/21E DIE CAT. NO.	TBM8/BS DIE CAT. NO.	TBM5/5S DIE CAT. NO.	UPPER	LOWER
54610	19,590	27,290	3 #12 sol. or str.	2 #10 w/1 #12 sol. or str.	.407	.370	BLUE	Included	—	—	13475	13477	
54615	31,140	43,400	3 #10 sol. or str.	4 #10 sol. or str.	.407	.430	GRAY	Included	13461	13454	13472	13476	
54620	49,530	65,560	3 #8 sol. or str.	1 #4 w/2 #10 sol. or str.	.417	.475	BROWN	Included	—	—	13474	—	
54625-TB	66,040	87,130	4 #8 sol. or str.	1 #2 str w/2 #12 sol. or str.	.479	.545	GREEN	—	—	—	—	—	
54630	83,480	99,990	2 #4 sol. or str.	2 #4 w/1 #10 sol. or str.	.479	.585	PINK	—	13462	13455	13475	13477	
54635	99,060	124,220	6 #8 str.	2 #4 w/2 #8 sol. or str.	.762	.620	BLACK	—	—	—	13474	—	
54640	125,220	166,120	3 #4 sol. or str.	3 #4 w/2 #10 sol. or str.	.762	.695	ORANGE	—	—	—	—	—	
54645-TB	166,960	193,630	4 #4 sol. or str.	2 #1 w/2 #10 sol. or str.	.824	.770	PURPLE	—	13463	13456	13475	—	
54650	189,190	244,020	3 #2 str.	2 #1/0 w/2 #8 str.	.887	.830	YELLOW	—	—	—	13473	13476	

Hand tools only.

UL Listed E9809 — code stranded

Tooling: pp. B76–B92

Die Selector Chart: pp. B93–B95

Cast Copper Bus Taps for Copper Conductor

Clamps onto bus bar — no drilling required.

Heavy-Duty Bus Bar Taps — Straight Barrel Angle for 600V to 35KV Applications

- For bus bars up to ¼" thick, 3-6" wide and code copper cable
- Takes up less than 1¼" of bus bar space
- Convex shape of connector tongue exerts great contact pressure on bus bar
- Installs with hydraulic tools and hex crimp dies

Material: High-Conductivity Cast Copper Alloy

Finish: Electro Tin Plate

Contact Material: Beryllium Copper

Finish: Silver

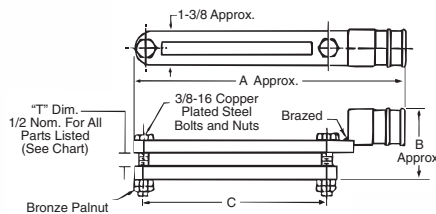

Figure 1

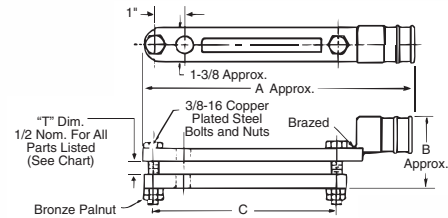

Figure 2

CAT. NO.	WIRE FLEX		FIG. NO.	BUSBAR WIDTH	DIMENSIONS (IN.)			DIE CODE
	CODE	FLEX			A	B	C	
251-31446-1			1	3	6 ¹ / ₂	2 ¹ / ₂	3 ¹ / ₂	66H
251-31446-7	1/0	225/24	1	4	7 ¹ / ₂	2 ¹ / ₂	4 ¹ / ₂	66H
251-31446-13			2	5 or 6	9 ¹ / ₂	2 ¹ / ₂	6 ¹ / ₂	66H
251-31446-8	2/0	1/0	1	4	7 ¹ / ₂	2 ¹ / ₂	4 ¹ / ₂	66H
251-31446-14		275/24	2	5 or 6	9 ¹ / ₂	2 ¹ / ₂	6 ¹ / ₂	66H
251-31446-23			1	3	6 ¹ / ₂	2 ¹ / ₂	3 ¹ / ₂	66H
251-31446-22	4/0	450/24	1	4	7 ¹ / ₂	2 ¹ / ₂	4 ¹ / ₂	66H
251-31446-19			2	6	9 ¹ / ₂	2 ¹ / ₂	6 ¹ / ₂	66H
251-31446-29	250	4/0	1	3	5 ¹ / ₁₆	2 ¹ / ₂	3 ¹ / ₂	66H
251-31446-30	kcmil	550/24	1	4	7 ¹ / ₂	2 ¹ / ₂	4 ¹ / ₂	66H
251-31446-31			1	5 or 6	9 ¹ / ₂	2 ¹ / ₂	6 ¹ / ₁₆	66H
251-31446-3	350		1	3	6 ¹ / ₂	2 ¹ / ₁₆	3 ¹ / ₂	99H
251-31446-9	kcmil		1	4	7 ¹ / ₂	2 ¹ / ₁₆	4 ¹ / ₂	99H
251-31446-15			2	5 or 6	9 ¹ / ₂	2 ¹ / ₁₆	6 ¹ / ₂	99H
251-31446-4	500	350	1	3	6 ¹ / ₂	2 ¹ / ₁₆	3 ¹ / ₂	99H
251-31446-10	kcmil	925/24	1	4	7 ¹ / ₂	2 ¹ / ₁₆	4 ¹ / ₂	99H
251-31446-16			2	5 or 6	9 ¹ / ₂	2 ¹ / ₁₆	6 ¹ / ₂	99H
251-31446-17	600		2	5 or 6	9 ¹ / ₂	2 ¹ / ₂	6 ¹ / ₂	112H
	kcmil							
251-31446-21	700		1	6	9 ¹ / ₂	2 ¹ / ₂	6 ¹ / ₁₆	112H
	kcmil							
251-31446-6	750	500	1	3	6 ¹ / ₂	2 ¹ / ₂	3 ¹ / ₂	112H
251-31446-12	kcmil	1325/24	2	4	7 ¹ / ₂	2 ¹ / ₂	4 ¹ / ₂	112H
251-31446-18			2	5 or 6	9 ¹ / ₂	2 ¹ / ₂	6 ¹ / ₂	112H
251-31446-36		750	2	5 or 6	9 ¹ / ₂	2 ¹ / ₂	6 ¹ / ₁₆	112H
		1925/24						

Styles shown have cable tap on one portion of clamp assembly. Clamp assemblies with cable taps on both portions (top & bottom identical) are also available. These assemblies are identified by adding suffix "AD" to part numbers shown. **Example: 251-31446-1AD**

Only use hydraulic tools with hex crimp dies.

Tooling: pp. B76-B92

Die Selector Chart: pp. B93-B95

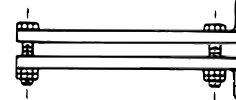

Double Cable—Use AD Suffix

Motor Pigtail Connectors

Quick, reliable change-out of electric motors with no bolting, taping or loose connections.

Motor Lead Disconnects

- Complete line of motor lead disconnects for 600V and 5kv applications, covering wire range from #16 through 4/0 AWG
- Fast, snap-together assembly offers maximum labor savings
- No need for nuts, bolts and washers or insulating tape — simply slide on reusable boot
- Total assembly fits into tight motor housings
- Quick disconnect — no knife cutting of melted tape, eliminating the risk of accidental cutting of wire insulation, resulting motor downtime and installer exposure
- Meet or exceed electrical and mechanical performance of bolted connections
- Constructed of high-conductivity copper with tin-plating
- Female disconnects equipped with beryllium copper interface band for dependable connections



Color-Keyed Compression

Motor Pigtail Connector — One Line to One Load (2 Wire)

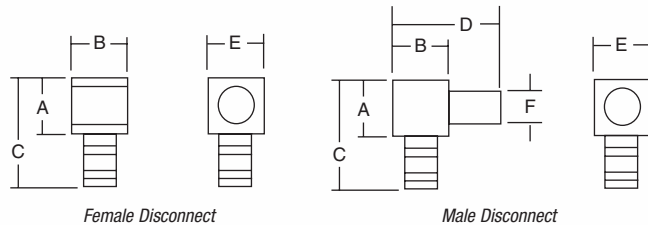

CAT. NO.		WIRE SIZE	BODY SIZE	COLOR CODE	BOOT INSULATION	DIMENSIONS (IN.)						STRIP LENGTH (IN.)
FEMALE DISCONNECT	MALE DISCONNECT					A	B	C	D	E	F	
MD1614F-0	MD1614M-0	16-14 AWG	0	BLUE	MDBOOT-0	.25	.25	.63	.52	.25	.125	3/8
MD1614F-1	MD1614M-1	16-14 AWG	1	BLUE	MDBOOT-1	.38	.38	.78	.75	.38	.250	3/8
MD1210F-1	MD1210M-1	12-10 AWG	1	YELLOW	MDBOOT-1	.38	.38	.78	.75	.38	.250	3/8
MD1210F-2	MD1210M-2	12-10 AWG	2	YELLOW	MDBOOT-2	.50	.50	.90	1.00	.50	.370	3/8
MD8F-1	MD8M-1	8 AWG	1	RED	MDBOOT-1	.38	.38	.82	.75	.38	.250	7/16
MD8F-2	MD8M-2	8 AWG	2	RED	MDBOOT-2	.50	.50	.95	1.00	.50	.370	7/16
MD6F-1	MD6M-1	6 AWG	1	BLUE	MDBOOT-1	.38	.38	.88	.75	.38	.250	1/2
MD6F-2	MD6M-2	6 AWG	2	BLUE	MDBOOT-2	.50	.50	1.02	1.00	.50	.370	1/2
MD4F-2	MD4M-2	4 AWG	2	GRAY	MDBOOT-2	.50	.50	1.06	1.00	.50	.370	1/2
MD2F-2	MD2M-2	2 AWG	2	BROWN	MDBOOT-2	.50	.50	1.09	1.00	.50	.370	17/32
MD2F-3	MD2M-3	2 AWG	3	BROWN	MDBOOT-3	.88	.88	1.46	1.75	.88	.500	17/32
MD1F-2	MD1M-2	1 AWG	2	GREEN	MDBOOT-2	.50	.50	1.23	1.00	.50	.370	9/16
MD1F-3	MD1M-3	1 AWG	3	GREEN	MDBOOT-3	.88	.88	1.56	1.75	.88	.500	9/16
MD10F-3	MD10M-3	1/0 AWG	3	PINK	MDBOOT-3	.88	.88	1.56	1.75	.88	.500	9/16
MD20F-3	MD20M-3	2/0 AWG	3	BLACK	MDBOOT-3	.88	.88	1.59	1.75	.88	.500	3/4
MD30F-3	MD30M-3	3/0 AWG	3	ORANGE	MDBOOT-3	.88	.88	1.71	1.75	.88	.500	11/16
MD40F-3	MD40M-3	4/0 AWG	3	PURPLE	MDBOOT-3	.88	.88	1.81	1.75	.88	.500	3/4
MD40F-4	MD40M-4	4/0 AWG	4	PURPLE	MDBOOT-4	1.25	1.25	2.89	2.69	1.25	.813	—
MD250F-4	MD250M-4	250 kcmil	4	YELLOW	MDBOOT-4	1.25	1.25	2.89	2.69	1.25	.813	—
MD350F-4	MD350M-4	350 kcmil	4	RED	MDBOOT-4	1.25	1.25	2.89	2.69	1.25	.813	—
MD500F-4	MD500M-4	500 kcmil	4	BROWN	MDBOOT-4	1.25	1.25	2.89	2.69	1.25	.813	—

Tooling: pp. B76–B92

Die Selector Chart: pp. B93–B95

United States
Tel: 901.252.8000
800.816.7809
Fax: 901.252.1354

Canada
Tel: 450.347.5318
Fax: 450.347.1976

Technical Services
Tel: 888.862.3289

Thomas & Betts

www.tnb.com

Motor Pigtail Connectors

Motor Pigtail Connector — One Line to One Load (2 Wire) (continued)

Quick, easy installation!

- 1 Choose appropriate Color-Keyed® disconnect for conductor size to be terminated. Note color of bands on disconnect barrel.
- 2 Select proper installing die by matching die color to disconnect barrel color bands.
- 3 Install die in T&B tool, insert stripped wire into barrel of disconnect and compress between color bands. Repeat for mating half.
- 4 Snap the two halves together and slip on insulator over mated connection. Secure insulator with TY-RAP® cable ties provided with the insulators.



600V Version



5KV Version

Material: High-Conductivity Copper

Plating: Tin

Insulator: Thermoplastic Elastomer



CAT. NO.	FEMALE DISCONNECT	MALE DISCONNECT	WT112M WT111M WT2000 ERG2002	TBM25S TBM20S	INSTALLING TOOLS				HYDRAULIC TOOLS & TBM50S HAND TOOL	
					TBM6, TBM6S, TBM60RS		TBM5	TBM8	DIE CODE	COLOR
					UPPER DIE	LOWER DIE	TBM5S DIE SET	TBM8S DIE SET		
MD1614F-0	MD1614M-0		X	—	—	—	—	—	—	—
MD1614F-1	MD1614M-1		X	—	—	—	—	—	—	—
MD1210F-1	MD1210M-1		X	—	—	—	—	—	—	—
MD1210F-2	MD1210M-2		X	—	—	—	—	—	—	—
MD8F-1	MD8M-1		—	X	13475	13477	13454	13461	21	RED
MD8F-2	MD8M-2		—	X	13475	13477	13454	13461	21	RED
MD6F-1	MD6M-1		—	X	13475	13477	13454	13461	24	BLUE
MD6F-2	MD6M-2		—	X	13475	13477	13454	13461	24	BLUE
MD4F-2	MD4M-2		—	X	13472	13476	13454	13461	29	GRAY
MD2F-2	MD2M-2		—	X	13474	13477	13454	13461	33	BROWN
MD2F-3	MD2M-3		—	X	13474	13477	13454	13461	33	BROWN
MD1F-2	MD1M-2		—	—	13474	13477	13455	13462	37	GREEN
MD1F-3	MD1M-3		—	—	13474	13477	13455	13462	37	GREEN
MD10F-3	MD10M-3		—	—	13475	13477	13455	13462	42	PINK
MD20F-3	MD20M-3		—	—	13474	13477	13455	13462	45	BLACK
MD30F-3	MD30M-3		—	—	13474	13477	13455	13462	50	ORANGE
MD40F-3	MD40M-3		—	—	13475	13477	13456	13463	54	PURPLE

Specifications:

Wire range: No. 16 to 4/0 AWG

Rating: 600V, 90°C

Tooling: pp. B76–B92

Die Selector Chart: pp. B93–B95

Motor Pigtail Connectors

Motor Pigtail Connector — One Line to Two Load (3 Wire)

- KON-TOUR® louvered contact bands
- Color-coded to match installing dies

Material: High-Conductivity Wrought Copper

Finish: Electro-Tin Plate

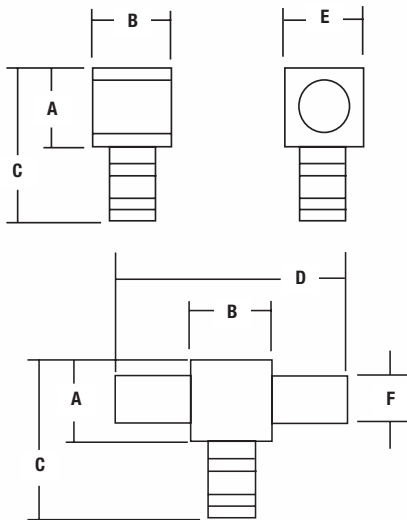

Color-Keyed Compression



CAT. NO.		WIRE SIZE	BODY SIZE	COLOR CODE	BOOT INSULATION	DIMENSIONS (IN.)					STRIP LENGTH (IN.)	
FEMALE DISCONNECT	MALE DISCONNECT					A	B	C	D	E		F
MD1614F-0	M2D1614M-0	16-14 AWG	0	BLUE	MDBOOT-1	.250	.250	.63	.77	.25	.12	3/8
MD1210F-1	M2D1210M-1	12-10 AWG	1	YELLOW	M2DBOOT-1	.380	.380	.780	.750	.380	.25	3/8
MD1210F-2	M2D1210M-2	12-10 AWG	2	YELLOW	M2DBOOT-2	.500	.500	.900	1.500	.500	.37	3/8
MD8F-1	M2D8M-1	8 AWG	1	RED	M2DBOOT-1	.380	.380	.820	1.125	.380	.25	7/16
MD8F-2	M2D8M-2	8 AWG	2	RED	M2DBOOT-2	.500	.500	.950	1.500	.500	.37	7/16
MD6F-1	M2D6M-1	6 AWG	1	BLUE	M2DBOOT-1	.380	.380	.875	1.125	.380	.25	1/2
MD6F-2	M2D6M-2	6 AWG	2	BLUE	M2DBOOT-2	.500	.500	1.020	1.500	.500	.37	1/2
MD4F-2	M2D4M-2	4 AWG	2	GRAY	M2DBOOT-2	.500	.500	1.060	1.500	.500	.37	1/2
MD2F-2	M2D2M-2	2 AWG	2	BROWN	M2DBOOT-2	.500	.500	1.090	1.500	.500	.37	17/32
MD2F-3	M2D2M-3	2 AWG	3	BROWN	M2DBOOT-3	.875	.875	1.460	2.630	.875	.50	17/32
MD1F-2	M2D1M-2	1 AWG	2	GREEN	M2DBOOT-2	.50	.50	1.230	1.500	.500	.37	9/16
MD1F-3	M2D1M-3	1 AWG	3	GREEN	M2DBOOT-3	.875	.875	1.560	2.630	.875	.50	9/16
MD10F-3	M2D10M-3	1/0 AWG	3	PINK	M2DBOOT-3	.875	.875	1.560	2.630	.875	.50	9/16
MD20F-3	M2D20M-3	2/0 AWG	3	BLACK	M2DBOOT-3	.875	.875	1.590	2.630	.875	.50	5/8
MD30F-3	M2D30M-3	3/0 AWG	3	ORANGE	M2DBOOT-3	.875	.875	1.710	2.630	.875	.50	11/16
MD40F-3	M2D40M-3	4/0 AWG	3	PURPLE	M2DBOOT-3	.875	.875	1.810	2.630	.875	.50	3/4

Operating Range: 600V max., 1000V max. in signs and fixtures.

Listing: UL Listed and CSA Certified for 12-8 AWG solid copper conductors and stranded copper conductors in the sizes shown.

Selection: Always use the same body size when selecting male and female disconnects. For example, to connect a 2 AWG male to an 8 AWG female, select Catalog Numbers M2D2M-2 and MD8F-2. Both have body size 2.

Insulation: Use insulating boots matching the disconnect body size as indicated in the chart. To protect the connection from moisture and dirt use sealing compound Catalog Number MDBOOT-SEAL.

Tooling: pp. B76-B92

Die Selector Chart: pp. B93-B95

United States
Tel: 901.252.8000
800.816.7809
Fax: 901.252.1354

Canada
Tel: 450.347.5318
Fax: 450.347.1976

Technical Services
Tel: 888.862.3289

Thomas & Betts

www.tnb.com

Motor Pigtail Connectors

Motor Pigtail Connector — One Line to Two Load (3 Wire) (continued)

- KON-TOUR louvered contact bands
- Color-coded to match installing dies

Material: High-Conductivity Wrought Copper

Finish: Electro-Tin Plate

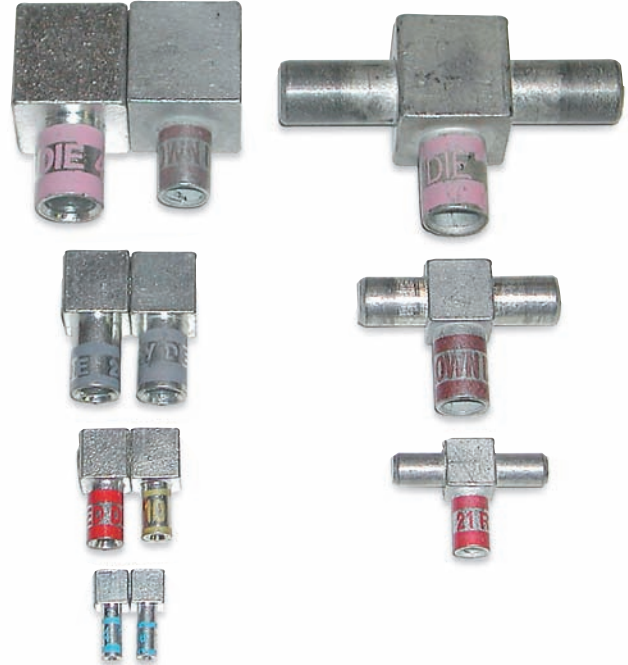
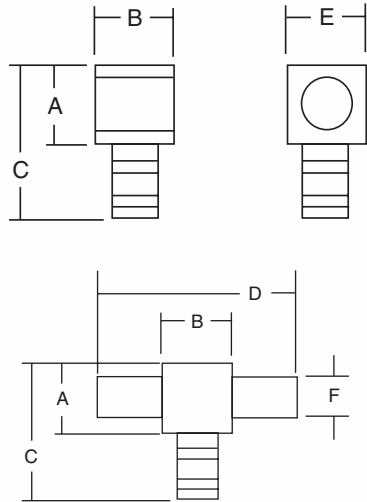

CAT. NO.		WT112M WT111M ERG 2002 WT2000	TBM25S	INSTALLING TOOLS				HYDRAULIC TOOLS	
FEMALE DISCONNECT	MALE DISCONNECT			TBM6, TBM6S, TBM60RS UPPER DIE	TBM5 TBM5S LOWER DIE	TBM8 TBM8S DIE SET	DIE SET	DIE CODE	COLOR
MD1614F-0	M2D1614M-0	X	—	—	—	—	—	—	BLUE
MD1210F-1	M2D1210M-1	X	—	—	—	—	—	—	YELLOW
MD1210F-2	M2D1210M-2	X	—	—	—	—	—	—	YELLOW
MD8F-1	M2D8M-1	—	X	13475	13477	13454	13461	21	RED
MD8F-2	M2D8M-2	—	X	13475	13477	13454	13461	21	RED
MD6F-1	M2D6M-1	—	X	13475	13477	13454	13461	24	BLUE
MD6F-2	M2D6M-2	—	X	13475	13477	13454	13461	24	BLUE
MD4F-2	M2D4M-2	—	X	13472	13476	13454	13461	29	GRAY
MD2F-2	M2D2M-2	—	X	13474	13477	13454	13461	33	BROWN
MD2F-3	M2D2M-3	—	X	13474	13477	13454	13461	33	BROWN
MD1F-2	M2D1M-2	—	—	13474	13477	13455	13462	37	GREEN
MD1F-3	M2D1M-3	—	—	13474	13477	13455	13462	37	GREEN
MD10F-3	M2D10M-3	—	—	13475	13477	13455	13462	42	PINK
MD20F-3	M2D20M-3	—	—	13474	13477	13455	13462	45	PINK
MD30F-3	M2D30M-3	—	—	13474	13477	13455	13462	50	ORANGE
MD40F-3	M2D40M-3	—	—	13475	13477	13456	13463	54	PURPLE

Tooling: pp. B76-B92

Die Selector Chart: pp. B93-B95

Motor Pigtail Connectors

5KV Motor Pigtail Connector Supplied with Boot, Pin, Silicon Gel (Two Female Connectors Required)

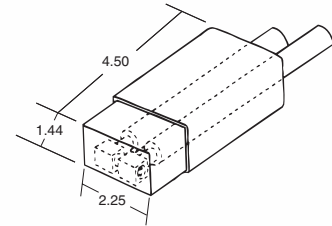
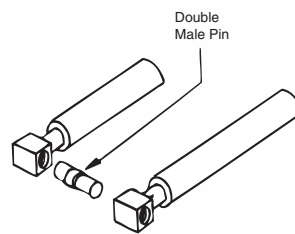

CAT. NO.	WIRE RANGE AWG.	FEMALE DISCONNECT CAT. NO.	COLOR CODE	DIMENSIONS (IN.)			BODY SIZE
				L	W	H	
5KVB00T-2L	#8	MD8F-2	RED	4.50	2.25	1.44	2
5KVB00T-2L	#6	MD6F-2	BLUE	4.50	2.25	1.44	2
5KVB00T-2L	#4	MD4F-2	GRAY	4.50	2.25	1.44	2
5KVB00T-2L	#2	MD2F-2	BROWN	4.50	2.25	1.44	2
5KVB00T-2L	#1	MD1F-2	GREEN	4.50	2.25	1.44	2
5KVB00T-3L	#2	MD2F-3	BROWN	4.50	2.25	1.44	3
5KVB00T-3L	#1	MD1F-3	GREEN	4.50	2.25	1.44	3
5KVB00T-3L	1/0	MD10F-3	PINK	4.50	2.25	1.44	3
5KVB00T-3L	2/0	MD20F-3	BLACK	4.50	2.25	1.44	3
5KVB00T-3L	3/0	MD30F-3	ORANGE	4.50	2.25	1.44	3
5KVB00T-3L	4/0	MD40F-3	PURPLE	4.50	2.25	1.44	3

Color-Keyed Compression

For easy, reliable sealing of motor-disconnect boots.

Sealant

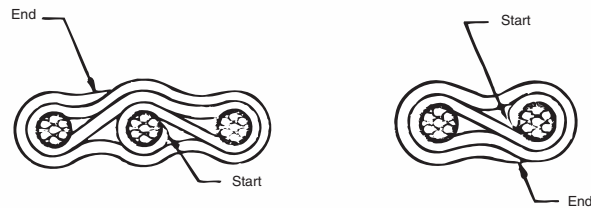

Sealant should be used with T&B MOTOR-DISCONNECT Boots: MDBOOT-0, MDBOOT-1, MDBOOT-2 and MDBOOT-3.

The cable should be clean and free of grease, and other foreign substances.

Apply two layers around each cable at the same distance from the connector.

Slide the assembly into boot, apply TY-RAP® cable ties and work sealant around wires at end of boot to eliminate voids.

Specifications

- Description: Polybutene Compound
- Application Temperature: 40° F to 100° F
- Service Temperature: -40° F to 180° F
- Dimensions: Width 1", Thickness 1/8", Length (Std. Roll) 10', wrapped on release liner
- Environmental Resistance: Resists normal aging process
- Chemical Resistance: Resists acids, bases and alcohols
- Dielectric Strength: 200 v/mil minimum
- Volume Resistivity: 1013 ohms/cm
- Flame Retardancy: Pass V0 Vertical Flame Test

CAT. NO.	DESCRIPTION
MDBOOT-SEAL	Sealant

For water-tight applications, contact technical services.

Tooling: pp. B76-B92

Die Selector Chart: pp. B93-B95

United States
Tel: 901.252.8000
800.816.7809
Fax: 901.252.1354

Canada
Tel: 450.347.5318
Fax: 450.347.1976

Technical Services
Tel: 888.862.3289

Thomas & Betts

www.tnb.com

KUBE™ Connectors

Make economical, field-constructible, UL Listed multiple-tap electrical connections!

KUBE™ Connectors Multi-Tap

Leave it to Color-Keyed® to bring you the most versatile, affordable solution for multiple-load installations from a single main conductor. The KUBE™ Multi-Tap system gangs multiple permanent, dependable compression taps mounted on a high-conductivity copper rod to achieve a space- and cost-efficient UL Listed multiple-tap connection you configure in the field. For even more flexibility, you can rotate connectors individually on the Multi-Tap rod to accommodate the bends and angles necessary to install equipment or complete circuitry – without the high cost of flexible-conductor cable.

- Lowest installed cost for the application – eliminates the need for expensive flexible-conductor cable
- Individual connectors can be rotated 360° on rod for multi-directional connections
- Versatile, modular design supports a myriad of connection possibilities
- UL 486AB Listed and CSA Certified for field installation
- Compression connections maintain integrity even under vibration and high temperatures
- Supports wire sizes from #16 to 4/0 AWG
- Suitable for applications up to 600 volts (1000 volts in signs and fixtures)
- Rods constructed of high-conductivity copper with corrosion-resistant tin plating
- Connectors constructed of electro-tin-plated high-conductivity copper with louvered contact bands for reliable connections and color coding for easy selection of crimping die
- Two-piece, UL94-V0-rated, polycarbonate insulators snap onto connectors easily for fast, safe installation

Typical Applications

- Commercial construction
- Specialized installations for entertainment applications
- Gutter taps for all applications
- Any other application requiring the running of multiple loads from a main conductor



This Multi-Tap installation connects 4/0, 1 and 2 AWG cables using MD40F-3, MD1F-3 and MD2F-3 connectors with REC-3 insulators on an R3-6 rod.

KUBE™ Connectors

KUBE™ Multi-Tap makes field installation fast and easy.



1. Crimp Multi-Tap connectors onto cables.



2. Snap Multi-Tap insulators over connectors.



3. Remove one end nut and spacers from Multi-Tap rod.



4. Slide connector/insulator assemblies onto rod.



5. If any rod positions remain empty, slide on appropriate number of spacers to fill rod.



6. Reapply end nut and tighten.

How to Order KUBE™ Multi-Tap

- Choose your connectors. Note that connectors to be mounted on a single Multi-Tap rod can be for different wire sizes but must be of the same body size.
- Choose insulators of the appropriate body size for the connectors. (One insulator required for each connector.)
- Choose a Multi-Tap rod that matches the body size of your connectors and that has enough positions for the number of connections you need.

KUBE™ Multi-Tap Connectors



CAT. NO.	WIRE SIZE	BODY SIZE	COLOR CODE
MD1614F-0	16-14 AWG	0	BLUE
MD1614F-1	16-14 AWG	1	BLUE
MD1210F-1	12-10 AWG	1	YELLOW
MD1210F-2	12-10 AWG	2	YELLOW
MD8F-1	8 AWG	1	RED
MD8F-2	8 AWG	2	RED
MD6F-1	6 AWG	1	BLUE
MD6F-2	6 AWG	2	BLUE
MD4F-2	4 AWG	2	GRAY
MD2F-2	2 AWG	2	BROWN
MD2F-3	2 AWG	3	BROWN
MD1F-2	1 AWG	2	GREEN
MD1F-3	1 AWG	3	GREEN
MD10F-3	1/0 AWG	3	PINK
MD20F-3	2/0 AWG	3	BLACK
MD30F-3	3/0 AWG	3	ORANGE
MD40F-3	4/0 AWG	3	PURPLE

Please note that these connectors are the same as our female motor pigtail connectors. For more information on dimensions, compression tool selection and required strip length, see pages B-53 to B-56.

KUBE™ Multi-Tap Insulators

One insulator required for each connector.



CAT. NO.	FOR CONNECTOR BODY SIZE
REC-0	0
REC-1	1
REC-2	2
REC-3	3

KUBE™ Multi-Tap Rods

Includes rod with spacers and end nuts. Rod positions indicate the maximum number of connectors the rod can hold. Spacers are provided to fill any unused positions left open for future connections. Body size of connectors, insulators and rod must match.

CAT. NO.	FOR CONNECTOR BODY SIZE	NO. OF ROD POSITIONS
R0-4	0	4
R0-6	0	6
R0-8	0	8
R0-10	0	10
R0-12	0	12
R1-4	1	4
R1-6	1	6
R1-8	1	8
R1-10	1	10
R1-12	1	12
R2-4	2	4
R2-6	2	6
R2-8	2	8
R2-10	2	10
R2-12	2	12
R3-4	3	4
R3-6	3	6
R3-8	3	8
R3-10	3	10
R3-12	3	12

Color-Keyed Compression

KUBE™ Connectors

A cost-saving breakthrough in 90° and T-connections.

KUBE™ Flag and Tee Connectors

Finally there's a fast, easy and affordable way to make those 90° and T electrical connections whenever and wherever you need them. Color-Keyed® Flags and Tees are designed — and UL/CSA approved — to be used with standard Color-Keyed® lugs and splices from #8 through 4/0 AWG in field-assembled configurations.

Now you don't need to use high-cost flexible conductor for connections requiring 90° bending radius or expensive brazed or welded connectors for T connections! Insulated with custom-fit, halogen-free polypropylene for safety and performance, Color-Keyed® Flags and Tees are available in bulk quantities for OEM applications and in a convenient kit for field use.

- Offers lowest installed cost for the application
- Versatile, modular design enables thousands of field-constructible connection possibilities, including multi-circuit configurations
- UL Listed and CSA Certified for field installation
- Insulated for fast, safe termination and installation
- Used with standard Color-Keyed® lugs and splices
- Color coded for easy selection of correct crimping die and easy verification of proper crimp
- Constructed from high-conductivity, low-resistance 99.9% pure wrought copper for optimum electrical performance
- Tin plated for corrosion resistance and excellent contact

..... Specifications

- Connector: Tin-plated copper
- Insulation: Halogen-free polypropylene
- Standards: UL 486, CSA 22.2 #65

Make on-site custom electrical connections in:

- 90° lugs (lugs can rotate 360°)
- 90° splices
- Countless connection possibilities using any straight or angled lug from 15° to 90° (lugs can rotate 360° for easy positioning)
- T-lugs
- T-splices



Flag & Tee Kit Contents:

- Steel carrying case
- TBM25S crimp tool
- 25 each #8, #6 and #4 AWG flag bodies
- 25 each #8, #6 and #4 AWG one-hole lugs
- 10 each #2, #1, 1/0, 2/0, 3/0 and 4/0 AWG flag bodies
- 10 each #2, #1, 1/0, 2/0, 3/0 and 4/0 AWG one-hole lugs
- 50 size 1 flag insulators
- 45 size 2 flag insulators
- 40 size 3 flag insulators
- 10 each #8 and #6 AWG tee bodies
- 20 each #8 and #6 AWG two-way splices
- 6 each #4, #2 and #1 AWG tee bodies
- 12 each #4, #2 and #1 AWG two-way splices
- 3 each 1/0, 2/0, 3/0 and 4/0 AWG tee bodies
- 6 each 1/0, 2/0, 3/0 and 4/0 AWG two-way splices

Flags

CAT. NO.	WIRE SIZE (AWG)	INSULATOR	STD. PKG. QTY.
Flags			
FLAG1614	#16-14	F-INSUL-0	20
FLAG1210	#12-10	F-INSUL-0	10
FLAG8	#8	F-INSUL-1	10
FLAG6	#6	F-INSUL-1	10
FLAG4	#4	F-INSUL-2	6
FLAG2	#2	F-INSUL-2	6
FLAG1	#1	F-INSUL-2	6
FLAG10	1/0	F-INSUL-3	3
FLAG20	2/0	F-INSUL-3	3
FLAG30	3/0	F-INSUL-3	3
FLAG40	4/0	F-INSUL-3	3

Tees

CAT. NO.	WIRE SIZE (AWG)	INSULATOR	STD. PKG. QTY.
Tees			
TEE1614	#16-14	—	20
TEE1210	#12-10	—	10
TEE8	#8	—	3
TEE6	#6	—	10
TEE4	#4	—	6
TEE2	#2	—	6
TEE1	#1	—	6
TEE10	1/0	—	3
TEE20	2/0	—	3
TEE30	3/0	—	3
TEE40	4/0	—	3

Flag Insulators

CAT. NO.	DESCRIPTION	STD. PKG. QTY.
F-INSUL-0	For #16-10 AWG	20/200
F-INSUL-1	For #8, #6 AWG	10/100
F-INSUL-2	For #4, #2, #1 AWG	6/60
F-INSUL-3	For 1/0, 2/0, 3/0, 4/0 AWG	3/30

Flag and Tee Kit

CAT. NO.	DESCRIPTION	STD. PKG. QTY.
FLAGTEEKIT	Flag and Tee Kit	1

Tooling: pp. B76-B92

Die Selector Chart: pp. B93-B95

Copper Disconnects

Making connections for high-amperage loads has never been easier!

High-Amperage Quick Power Disconnects

- Designed to be the fastest “off-load” connection possible, while maintaining system integrity
- Uses a multicontact approach to provide low insertion and extraction forces with low resistance and temperature rise
- Enables multiple connections and disconnection without changing or degrading performance characteristics
- Unique construction:
 - Made from 99.9% conductive copper, silver plated
 - Contact design features louvered band of beryllium copper
 - All raised edges of louvered band are deflected, producing a multitude of high-force contact points
 - Each contact point is typically in the force range of 8,000 to 10,000 psi
 - High currents, caused by short circuits or sudden surges, make contact interface even more efficient by increasing contact pressure

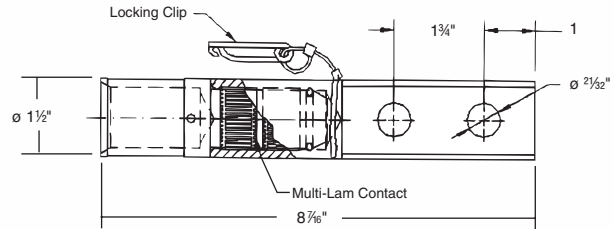

CAT. NO.		DIE CONDUCTOR	CODE
MALE	FEMALE		
272-32175M	272-32175F	777 MCM	115
Future Design	—	646 MCM	—
Future Design	—	535 MCM	—
Future Design	—	444MCM	—

Tooling: pp. B74–B90

Die Selector Chart: pp. B91–B93

T&B Method Traction Motor Disconnect Lugs for Diesel-Electric Locomotives

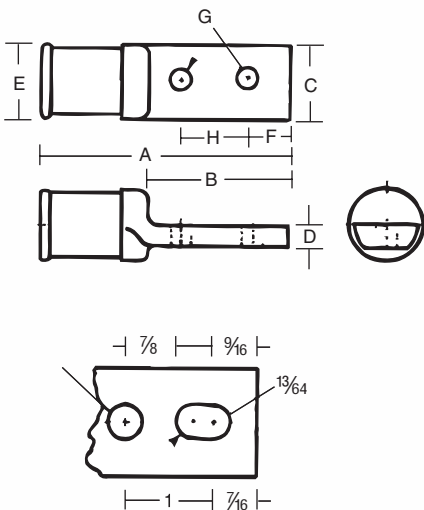

± Cat. No. MD 1925 Supplied with Elongated Bolt Hole.

CAT. NO.	CABLE SIZE	DIMENSIONS (IN.)				E APPROX. (IN.)	BOLT SIZE (IN.)			DIE CODE
		A	B	C	D		F	G	H	
MD37	37/24	2 ¹ / ₁₆	1 ³ / ₄	1 ⁹ / ₃₂	5 ¹ / ₃₂	3 ¹ / ₈	3 ¹ / ₈	5 ¹ / ₁₆	7 ¹ / ₈	26
MDD61	61/24	2 ¹ / ₁₆	1 ³ / ₄	1 ⁹ / ₃₂	5 ¹ / ₃₂	3 ¹ / ₈	3 ¹ / ₈	5 ¹ / ₁₆	7 ¹ / ₈	26
MD 105	105/24	2 ⁵ / ₁₆	1 ³ / ₄	1 ⁹ / ₃₂	5 ¹ / ₃₂	7 ¹ / ₁₆	3 ¹ / ₈	5 ¹ / ₁₆	7 ¹ / ₈	33
MD 105	91/24	2 ⁵ / ₁₆	1 ³ / ₄	1 ⁹ / ₃₂	5 ¹ / ₃₂	7 ¹ / ₁₆	3 ¹ / ₈	5 ¹ / ₁₆	7 ¹ / ₈	33
MD 125	125/24	2 ⁵ / ₁₆	1 ³ / ₄	1 ⁹ / ₃₂	5 ¹ / ₃₂	7 ¹ / ₁₆	3 ¹ / ₈	5 ¹ / ₁₆	7 ¹ / ₈	33
MD 150	150/24	2 ⁵ / ₁₆	1 ¹ / ₈	1 ⁹ / ₃₂	.203	3 ¹ / ₈	7 ¹ / ₁₆	5 ¹ / ₁₆	7 ¹ / ₈	45
MD 175	175/24	2 ⁵ / ₁₆	1 ¹ / ₈	1 ⁹ / ₃₂	.203	3 ¹ / ₈	7 ¹ / ₁₆	5 ¹ / ₁₆	7 ¹ / ₈	45
MD 225	225/24	3	1 ¹ / ₈	1 ¹ / ₁₆	.203	2 ³ / ₃₂	7 ¹ / ₁₆	5 ¹ / ₁₆	7 ¹ / ₈	60
MD 275	275/24	3	1 ¹ / ₈	1 ¹ / ₁₆	.203	2 ³ / ₃₂	7 ¹ / ₁₆	5 ¹ / ₁₆	7 ¹ / ₈	60
MD 325	325/24	3	1 ¹ / ₈	1 ¹ / ₁₆	.203	2 ³ / ₃₂	7 ¹ / ₁₆	5 ¹ / ₁₆	7 ¹ / ₈	60
MD 375	375/24	3 ¹ / ₈	2	2 ⁵ / ₃₂	.203	2 ³ / ₃₂	7 ¹ / ₁₆	5 ¹ / ₁₆	7 ¹ / ₈	60
MD 450	450/24	3 ¹ / ₈	2	2 ⁵ / ₃₂	.203	2 ³ / ₃₂	7 ¹ / ₁₆	5 ¹ / ₁₆	7 ¹ / ₈	60
MD 550	550/24	3 ¹ / ₈	1 ¹ / ₈	1 ⁵ / ₁₆	.203	1	7 ¹ / ₁₆	5 ¹ / ₁₆	7 ¹ / ₈	76
MD 650	650/24	3 ¹ / ₈	1 ¹ / ₈	1 ⁵ / ₁₆	.203	1	7 ¹ / ₁₆	5 ¹ / ₁₆	7 ¹ / ₈	76
MD 775	775/24	3 ¹ / ₈	1 ¹ / ₈	1 ⁵ / ₁₆	.203	1	7 ¹ / ₁₆	5 ¹ / ₁₆	7 ¹ / ₈	76
MD 925	925/24	3 ¹ / ₈	2 ¹ / ₁₆	1 ¹ / ₈	.375	1 ¹ / ₃₂	7 ¹ / ₁₆	3 ¹ / ₈	1	87
MD 1100	1100/24	3 ¹ / ₈	2 ¹ / ₁₆	1 ¹ / ₃₂	.375	1 ¹ / ₈	7 ¹ / ₁₆	3 ¹ / ₈	1	107
MD 1325	1325/24	3 ⁵ / ₃₂	2 ³ / ₃₂	1 ¹ / ₃₂	.375	1 ¹ / ₈	7 ¹ / ₁₆	3 ¹ / ₈	1	107
MD 1600	1600/24	3 ¹ / ₈	2 ¹ / ₁₆	1 ¹ / ₃₂	.375	1 ¹ / ₈	7 ¹ / ₁₆	3 ¹ / ₈	1	107
MD 1925	1925/24	4 ¹ / ₁₆	2 ³ / ₃₂	1 ¹ / ₃₂	.375	1 ¹ / ₈	7 ¹ / ₁₆	3 ¹ / ₈	1	115
MD 2300	2300/24	4 ¹ / ₈	2 ¹ / ₈	1 ⁹ / ₃₂	.375	1 ¹ / ₃₂	7 ¹ / ₁₆	3 ¹ / ₈	1	130

NOTE: Some parts may not be current on the system. Contact Tech Services for information.

Tooling: pp. B76–B92

Die Selector Chart: pp. B93–B95

Color-Keyed Compression

Connector Kits

Color-Keyed® Connector Kit for Copper Cables

Color-Keyed® Compression

CAT. NO.	DESCRIPTION	STD. PKG.	WT. EACH
TBM2K-1	Color-Keyed® Connector Kit	1	12

The kit includes

CAT. NO.	ITEMS	CABLE SIZE		QTY.
54104	One hole lugs	#8		25
54105	One hole lugs	#6		25
54106	One hole lugs	#4		15
54107	One hole lugs	#2, #3		10
54504	2-way conn.	#8		15
54505	2-way conn.	#6		15
54506	2-way conn.	#4		10
54507	2-way conn.	#2		5
		Min.	Max.	
54610	Pigtails-#12	4-#12	15	
54615	Pigtails	4-#12	4-#10	15
54620	Pigtails	3-#8	1-#4	15
		10	10	
54710	C-Tap	8	12	15
		6	10-12	
54615	C-Tap	8	8-10	15
		4 or 5	8-10-12	
54720	C-Tap	6	6-8	
TBM20S or TBM25S		#8	#2AWG	1

UL not applicable



Carrying Cases

MDPWK12 Case Contents

1 PWK1	10 MD1210F-1	6 MD8M-2	6 MD8F-2	30 BOOT-1
10 MD1210M-1	10 MD8F-1	6 MD6M-2	6 MD6F-2	6 MD1210M-2
10 MD8M-1	10 MD6F-1	6 MD4M-2	6 MD4F-2	6 MD1210F-2
10 MD6M-1	30 MDBOOT-2	6 MD2M-2	6 MD2F-2	

MDPWK23 Case Contents

1 PWK1	6 MD1210F-2	3 MD2M-3	3 MD2F-3	6 MD1M-2
6 MD1210M-2	6 MD8F-2	3 MD1M-3	3 MD1F-3	36 MDBOOT-2
6 MD8M-2	6 MD6F-2	3 MD10M-3	3 MD10F-3	18 MDBOOT-3
6 MD6M-2	6 MD4F-2	3 MD20M-3	3 MD20F-3	
6 MD4M-2	6 MD2F-2	3 MD30M-3	3 MD30F-3	
6 MD2M-2	6 MD1F-2	3 MD40M-3	3 MD40F-3	

MDKITL Case Contents

1 PWK1	1 TBM25S	24 MDBOOT-2	3 M2D2M-2	6 MD8M-1
3 M2D4M-2	3 M2D6M-2	3 M2D8M-2	12 M2DBOOT-2	6 MD8F-1
12 MDBOOT-1	12 MD2F-2	12 MD4F-2	12 MD6F-2	6 MD8M-2
12 M2D8F-2	6 MD2M-2	6 MD4M-2	6 MD6M-2	6 MD6M-1
6 MD6F-1				

CAT. NO.	DESCRIPTION
PWK1	Empty case — includes Color-Keyed® wall chart; make up your own selection of Color-Keyed® lugs, splices, taps or motor disconnects.
PWK4	Metal cabinet that holds four of the PWK1 shells slide out for easy removal of PWK1.
MDPWK12	Selection of size 1 and 2 male and female motor disconnects plus insulators; to connect 60 single line to single line load motor leads, #12 AWG through #2 AWG; tools not included.
MDPWK23	Selection of size 2 and 3 male and female motor disconnects plus insulators; to connect 54 single line to single line load motor leads, #12 AWG through #4/0 AWG; tools not included. 2 and 1 male and female motor disconnects plus insulators. To convert single to single line or single line to two line.
MDKITL	Includes Tool.

Connectors for Aluminum/Copper Code Conductor

Copper colloidal surface treatment protects, lubricates and enhances conductivity of all electrical connections.

Kopr-Shield® Joint Compound

- Unique, homogenized blend of pure, polished colloidal copper, rust and corrosion inhibitors
- Simultaneously protects, lubricates and enhances conductivity of mating surfaces
- Extremely adhesive compound flows smoothly into uneven contours and voids, ensuring easy application and complete, positive protection and lubrication
- Won't settle-out, thin, thicken, harden or dry out under the most severe environmental conditions
- Excellent temperature characteristics — can be brushed on at -50° F to 250° F (other compounds either turn solid or run like water at these extremes) and remains intact at short terms even at 1,800° F

Good connections are one of the most important aspects of electrical work. Mechanics know how much downtime is caused when fluids or oils leak into the raceway system or when they have to look for a weak link in a ground system caused by a high-resistance connection. Mechanics also know how much time is spent keeping contacts, switches, lugs and other connectors clean or replacing parts because of "green scourage" buildup. Thomas & Betts has the solution to improve connections made in thousands of electrical and raceway installations made each day by electricians everywhere. Kopr-Shield® Compound may be used to advantage in all electrical installations. When the environment is hostile to electrical and mechanical connections, Kopr-Shield® Compound is a must!



Use Kopr-Shield® Compound for battery lugs and cables to:

- Prevent "green scourage" corrosion
- Reduce resistance
- Ease terminal installation and removal

Use Kopr-Shield® Compound for raceways to:

- Lubricate for ease of assembly and disassembly
- Improve grounding continuity (exceeds code requirements)

Use Kopr-Shield® Compound for fuse clips to:

- Eliminate hot spots for even heat distribution
- Prevent oxidation by preventing carbon path formation
- Lubricate for easy installation and removal of fuses

Use Kopr-Shield® Compound for wiping contacts, drum switches and slip rings to:

- Prevent galling, burning, pitting and discoloration
- Suppress arcing and dissipation of coronas
- Lubricate for ease of operation



ALUMA-SHIELD® Aluminum Joint Compound



CAT. NO.	CONTAINS	DESCRIPTION
21059	Squeeze Bottle, Pt.	For aluminum cable connections; contains fine zinc particles which break through oxide film on cable strands upon compression of connection; ensures a low resistance contact and seals out air and moisture.
AP8	8 oz. Brush Cap Can	
M53	5 Gallon Can	

NOTE: UL Listed only for use on electrical cables in cable connector assemblies, or on bus bars rated for NEC® applications up to 8 KV and 90°C.

CAT. NO.	DESCRIPTION	STD. PKG.	WT. LBS./C
201-31879	1½ oz. Container with Brush	96	11.46
201-31879-1	4 oz. Container with Brush	24	38.54
CP8-TB	8 oz. Container with Brush	12	64.58
CP16	16 oz. Container with Brush	12	120.83
CP128	1 Gallon Can	4	952.00

United States
Tel: 901.252.8000
800.816.7809
Fax: 901.252.1354

Canada
Tel: 450.347.5318
Fax: 450.347.1976

Technical Services
Tel: 888.862.3289

Thomas & Betts

www.tnb.com

Connectors for Aluminum/Copper Code Conductor

For tight, secure bus-bar connections.

Belleville Compression Washers

- Essential when bolting aluminum lugs and connectors to bus bars with steel or brass hardware
- Maintains constant pressure in heavy-duty, high-temperature applications
- Available with or without flat washer

When bolting aluminum lugs and connectors to bus bars with steel or brass hardware, the recommended practice to ensure a tight connection is to use a Belleville spring washer on top of a flat washer under the bolt head or nut. For heavy-duty service where the heat rise is expected to exceed 30° C above ambient, this procedure maintains constant pressure as the connector metals expand and contract with temperature changes.

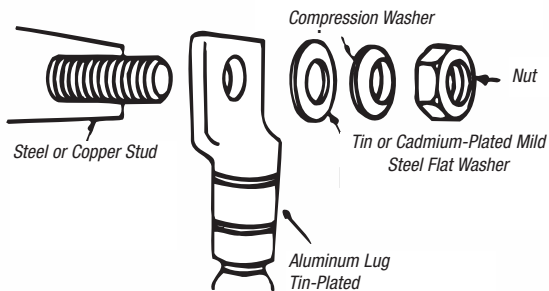

CAT. NO.	BOLT SIZES (IN.)	DIMENSIONS (IN.)			
		FLAT WASHER		BELLEVILLE WASHER	
		A	B	C	D
Belleville Compression Washers Plus Flat Washer					
60800B	¼	¾	.067	1 ¹ / ₁₆	.055
60801B	⅜	1	.074	1 ³ / ₁₆	.065
60802B	½	1 1/8	.083	1 ⁵ / ₁₆	.075
60803B	⅝	1 1/4	.109	1 ³ / ₈	.095
Belleville Compression Washer Only					
60800	¼	—	—	1 ¹ / ₁₆	.055
60801	⅜	—	—	1 ³ / ₁₆	.065
60802	½	—	—	1 ⁵ / ₁₆	.075
60803	⅝	—	—	1 ³ / ₈	.095
60804	¾	—	—	1 1/2	.110

NOTE: Ordering quantity must be in unit quantities and multiples thereof.

The Belleville washer should be installed with a larger flat washer to spread the high stresses of the spring washer edges over a large area of the lug and/or bus bar.

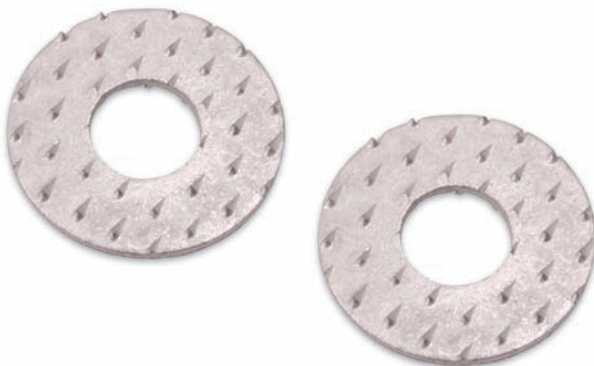

Quick, dependable and versatile.

Dragon Tooth® Transition Washers

- Connect copper-to-aluminum, copper-to-copper or aluminum-to-aluminum component
- Toothed surface penetrates aluminum and copper oxides
- Lower installed cost — no need to grind aluminum surfaces, apply compounds or use spring-type washers

CAT NO.	SIZE (IN.)	BOLT TORQUE IN LBS.
DTW14	¼	50–80
DTW516	⅜	125–160
DTW38	½	160–240
DTW12	⅝	390–540
DTW58	¾	540–730

Connectors for Aluminum/Copper Code Conductor



Perform equally well on both aluminum and copper conductors.

One-Hole Lugs



- For 90°C, 600V to 35KV applications
- Easily matched to the correct Color-Keyed® installing die for positive compressions
- Hardened steel dies compress connector around cable, changing round strands to polygonal shapes and cold flowing strands and connector into a solid, homogenous mass
- Long compression areas ensure complete contact
- Multiple compressions prevent creep of aluminum conductors
- Filled with high-temperature oxide-inhibitor compound
- Electro-tin plating prevents electrolytic corrosion of copper to ensure lowest contact resistance

Material: High-Conductivity Wrought Aluminum

Finish: Electro-Tin Plated

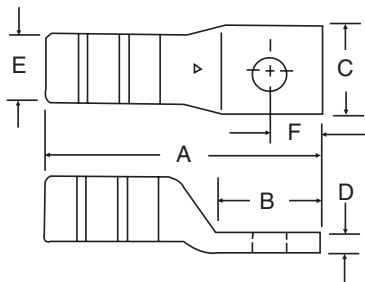

CAT. NO.	CABLE SIZE AL/CU	BOLT SIZE (IN.)	DIMENSIONS (IN.)						COLOR CODE	DIE CODE
			A	B	C	D	E	F		
60096	#10	#10	1.09	.56	.41	.06	.270	.22	21	RED
60097		¼	1.31	.72	.43	.07	.270	.34		
60099		⅜	1.53	.93	.58	.06	.270	.44		
60101	#8	#10	1.22	.56	.41	.09	.280	.22	24	BLUE
60102		¼	1.38	.71	.44	.09	.280	.34		
60103		⅝	1.56	.91	.60	.06	.280	.44		
60104-TB		¾	1.60	.93	.60	.06	.280	.44		
60106	#6	#10	1.52	.59	.47	.13	.350	.22	29	GRAY
60107		¼	1.67	.75	.47	.13	.350	.34		
60108		⅝	1.83	.91	.63	.09	.350	.44		
60109		¾	1.86	.93	.63	.09	.350	.44		
60112		1	1.81	.75	.64	.19	.460	.34		
60113	#4	⅝	2.00	.91	.64	.19	.460	.44	37	GREEN
60114		¾	2.03	.93	.64	.19	.460	.44		
60116	#2	¼	1.91	.75	.72	.19	.510	.34	42	PINK
60117		⅝	2.06	.91	.72	.19	.510	.44		
60118		¾	2.09	.93	.72	.19	.510	.44		
60120		1	2.25	1.41	.88	.13	.510	.69		
60122	#1	¼	2.30	.81	.75	.19	.560	.34	45	GOLD
60123		⅝	2.39	.91	.75	.19	.560	.44		
60124		¾	2.42	.93	.75	.19	.560	.44		
60126		1	2.89	1.41	.88	.16	.560	.69		
60128		1 ½	2.36	.81	.88	.19	.620	.34		
60129	1/0	⅝	2.51	.97	.88	.19	.620	.44	50	TAN
60130		¾	2.51	.97	.88	.19	.620	.44		
60132		1	2.95	1.41	.94	.19	.620	.69		
60134	2/0	¼	2.48	.87	.97	.22	.700	.34	54	OLIVE
60135		⅝	2.64	1.03	.97	.22	.700	.44		
60136		¾	2.64	1.03	.97	.22	.700	.44		
60138		1	3.10	1.41	1.03	.22	.700	.69		
60140	3/0	¼	2.58	.87	1.06	.22	.770	.34	60	RUBY
60141		⅝	2.83	1.09	1.06	.22	.770	.44		
60142		¾	2.83	1.09	1.06	.22	.770	.44		
60144		1	3.15	1.41	1.06	.22	.770	.69		
60147	4/0	⅝	3.53	.88	1.21	.25	.857	.38	66	WHITE
60148		¾	3.58	.93	1.21	.25	.857	.38		
60150		1	3.90	1.25	1.21	.25	.857	.50		
60151		1 ½	4.65	2.00	1.21	.25	.857	.75		
60154		2	3.73	.93	1.29	.27	.917	.38		
60156	250 kcmil	¼	4.05	1.25	1.29	.27	.917	.50	71	RED
60157		⅝	4.80	2.00	1.29	.27	.917	.75		
60159	300 kcmil	⅝	3.75	.88	1.39	.28	.990	.38	76	BLUE
60160		¾	3.80	.93	1.39	.28	.990	.38		
60162		1	4.13	1.25	1.39	.28	.990	.50		
60165	350 kcmil	¼	4.83	1.25	1.53	.33	1.090	.50	87	BROWN
60166		⅝	5.58	2.00	1.53	.33	1.090	.75		
60168	400 kcmil	¼	4.95	1.25	1.65	.38	1.180	.50	94	GREEN
60171	500 kcmil	¼	4.95	1.25	1.79	.38	1.280	.50	99	PINK
60172	600 kcmil	⅝	5.70	2.00	1.79	.38	1.280	.75	106	BLACK
60174		¾	5.83	2.00	1.92	.37	1.360	.75		
60176	700 kcmil	⅝	5.95	2.00	2.04	.38	1.440	.75	112	PURPLE
60178	750 kcmil	⅝	6.03	2.00	2.13	.40	1.500	.75	115	YELLOW
60184	1000 kcmil	⅝	6.78	2.00	2.50	.50	1.770	.75	140	N/A

Tooling: pp. B76-B92

Die Selector Chart: pp. B93-B95

Color-Keyed® Compression

Connectors for Aluminum/Copper Code Conductor

Designed and approved for use with both aluminum and copper conductors.

Two-Hole Lugs



Color-Keyed® Compression



- For 90°C, 600V to 35KV applications
- For aluminum and copper concentric conductors and compact code aluminum strandings
- Filled with oxide-inhibitor compound

Material: High-Conductivity Wrought Aluminum

Finish: Electro-Tin Plated

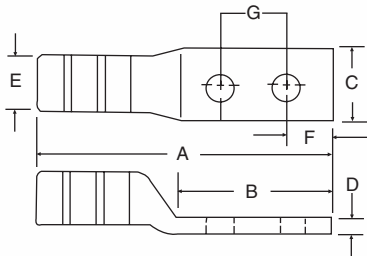

CAT. NO.	CABLE SIZE	BOLT SIZE (IN.)	DIMENSIONS (IN.)							DIE CODE	COLOR CODE
			A	B	C	D	E	F	G		
60230	1/0 AWG	3/8	3.50	1.90	.880	.19	.62	.38	1.00	50	TAN
60236	2/0 AWG	3/8	3.50	1.90	.970	.22	.70	.38	1.00	54	OLIVE
60238	2/0 AWG	1/2	5.03	3.41	.970	.22	.70	.75	1.75		
60242	3/0 AWG	1/2	3.66	1.18	1.063	.22	.77	.38	1.00	60	RUBY
60244	3/0 AWG	1/2	5.16	3.41	1.063	.22	.77	.75	1.75		
60248	4/0 AWG	3/4	4.58	1.93	1.210	.25	.86	.38	1.00	66	WHITE
60250	4/0 AWG	1/2	5.65	3.00	1.210	.25	.86	.50	1.75		
60254	250 kcmil	3/8	4.73	1.93	1.290	.27	.92	.38	1.00	71	RED
60256	250 kcmil	1/2	5.80	3.00	1.290	.27	.92	.50	1.75		
60260	300 kcmil	3/8	4.80	1.93	1.390	.28	.99	.38	1.00	76	BLUE
60262	300 kcmil	1/2	5.88	3.00	1.390	.28	.99	.50	1.75		
60265	350 kcmil	3/8	5.50	1.93	1.530	.33	1.09	.38	1.00	87	BROWN
60267	350 kcmil	1/2	6.58	3.00	1.530	.33	1.09	.50	1.75		
60268	400 kcmil	3/8	5.63	1.93	1.650	.38	1.18	.38	1.00	94	GREEN
60269	400 kcmil	1/2	6.70	3.00	1.650	.38	1.18	.50	1.75		
60271	500 kcmil	3/8	5.63	1.93	1.790	.38	1.28	.38	1.00	99	PINK
60273	500 kcmil	1/2	6.70	3.00	1.790	.38	1.28	.50	1.75		
60274	600 kcmil	3/8	5.75	1.93	1.920	.37	1.36	.38	1.00	106	BLACK
60275	600 kcmil	1/2	6.83	3.00	1.920	.37	1.36	.50	1.75		
60276	700 kcmil	3/8	5.88	1.93	2.040	.38	1.44	.38	1.00	112	PURPLE
60277	700 kcmil	1/2	6.95	3.00	2.040	.38	1.44	.50	1.75		
60278	750 kcmil	1/2	7.15	3.00	2.130	.40	1.50	.50	1.75	115	YELLOW
60284	1000 kcmil	1/2	7.78	3.00	2.500	.50	1.77	.50	1.75	140	N/A

NOTE: Bolt holes 3/8" on 1" centers, 1/2" on 1 1/4" centers.

Wire barrel factory-filled with oxide inhibiting compound.

Range-Taking Narrow-Tongue Single-Barrel Lugs

- For 90° C, 600V to 35KV applications
- 1 1/2" wide tongues
- Bolt holes on 1 1/4" centers

Material: Aluminum

Finish: Tin Plated

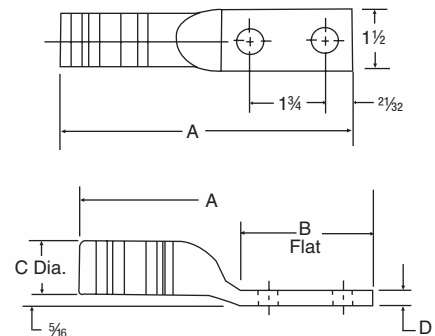

CAT. NO.	AL-CU CABLE RANGE	BOLT SIZE	NO. OF COMPRESSIONS		DIMENSIONS (IN.)				HEX DIE NO.	COLOR CODE
			TBM12M	13642, TBM15	A	B	C	D		
60273N	350-500 kcmil	1/2"	4	4	6 1/8	3 1/8	1 1/2	1 1/2	99H	PINK
60278N	500-750 kcmil	1/2"	—	4	7 1/8	3 1/8	1 1/2	1 1/2	115H	YELLOW

* 90° C, 600V to 35KV applications

All lugs have 1 1/2" wide tongues. Bolt holes on 1 1/4" centers.

Tooling: pp. B76-B92

Die Selector Chart: pp. B93-B95

Connectors for Aluminum Code Conductor

Much smaller than standard aluminum lugs for the same cable size.

One-Hole Aluminum Compact-Size Equipment Lug*

- For 90° C, 600V applications
- For use with aluminum cables only
- Can be directly substituted for equipment mechanical lugs in most applications
- Only 7 dies handle all 14 lug sizes
- Factory-filled with joint compound
- Electro-tin plated
- Supplied with Neoprene insulating covers

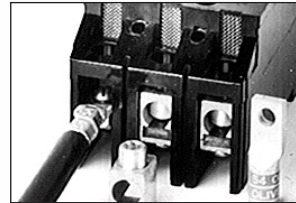

Color-Keyed® Compression

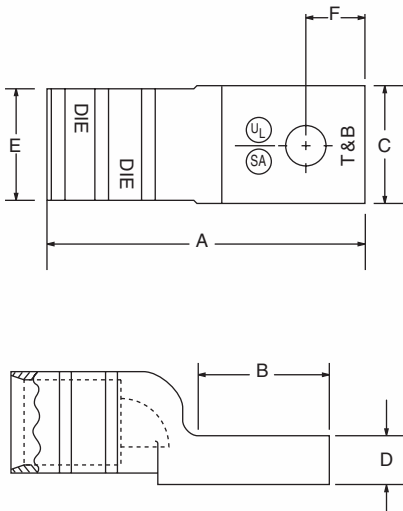

CAT. NO.	ALUMINUM CABLE SIZE	*ALUMINUM RANGE TAKING	BOLT HOLE (IN.)	DIMENSIONS (IN.)					
				A	B	C	D	E	F
61102	#8	—	¼	1.33	.54	.50	.14	.37	.25
61107	#6	—	¼	1.33	.54	.50	.14	.37	.25
61112	#4	—	¼	1.33	.54	.50	.14	.37	.25
61116	#2	—	¼	1.75	.68	.55	.20	.48	.25
61122	#1	—	¼	1.75	.68	.55	.20	.48	.25
61130	1/0	#8-1/0	¾	2.00	.83	.64	.20	.57	.38
61136	2/0	#1-2/0	¾	2.00	.83	.64	.20	.57	.38
61142	3/0	—	¾	2.50	1.08	.78	.23	.70	.38
61148	4/0	2/0-4/0	¾	2.50	1.08	.78	.23	.70	.38
61156	250 kcmil	—	½	2.50	1.23	.98	.25	.85	.50
61162	300 kcmil	#4-300	½	2.50	1.23	.98	.25	.85	.50
61165	350 kcmil	250-350	½	3.25	1.23	1.20	.41	1.04	.56
61171	500 kcmil	2/0-500	½	3.25	1.23	1.20	.41	1.04	.56
61178	750 kcmil	500-750	¾	3.75	1.54	1.49	.41	1.33	.81

600V, 90° C

This lug with insulating covers for aluminum cables only.

This lug is reduced in size as compared to an aluminum lug of the same cable size. It can be substituted for the equipment mechanical lugs in most cases. Factory filled with joint compound. Electro-tin plated. Cover is Neoprene.

*For range-taking capability, use TBM8-750/TBM8-750M1 Smart Tool.

Tooling: pp. B76-B92

Die Selector Chart: pp. B93-B95

Splice Connectors for Aluminum/Copper Code Conductor

For aluminum-to-copper or aluminum-to-aluminum splicing.



Two-Way Splice Connectors



- For 90° C, 600V to 35KV applications
- For aluminum and copper concentric conductors and compact code aluminum strandings
- Permit aluminum conductors to be spliced to copper or aluminum conductors

Material: High-Conductivity Wrought Aluminum

Finish: Electro-Tin Plated

CAT. NO.	CONDUCTOR CODE	DIMENSIONS (IN.)		DIE CODE	COLOR CODE
		A	E		
60500	10 Str.	1.00	.27	21	RED
60501	8 Str.	1.19	.28	24	BLUE
60507	6 Str.	1.63	.35	29	GRAY
60512	4 Str.	1.81	.46	37	GREEN
60516	2 Str./3 Str.	1.81	.51	42	PINK
60522	1 Str.	2.38	.56	45	GOLD
60530	1/0	2.38	.62	50	TAN
60536	2/0	2.50	.70	54	OLIVE
60542	3/0	2.81	.77	60	RUBY
60548	4/0	3.66	.86	66	WHITE
60554	250 kcmil	3.91	.92	71	RED
60560	300 kcmil	3.97	.99	76	BLUE
60565	350 kcmil	4.97	1.09	87	BROWN
60568	400 kcmil	4.97	1.18	94	GREEN
60571	500 kcmil	4.97	1.28	99	PINK
60574	600 kcmil	5.22	1.36	106	BLACK
60576	700 kcmil	5.44	1.44	112	PURPLE
60578	750 kcmil	5.69	1.50	115	YELLOW
60584	1000 kcmil	6.69	1.77	140	—

Splice aluminum conductors to copper conductors of equal ampacities.

Aluminum Reducing Connectors

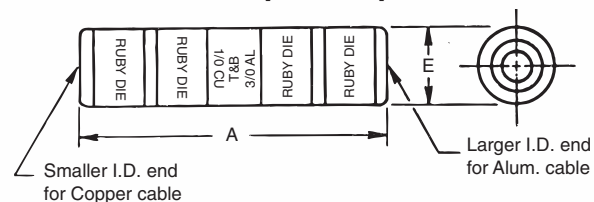

- For 90°C, 600V applications
- Filled with high-temperature oxide inhibiting compound
- Designed for the right combination of equivalent sizes (Example: 4/0 aluminum to 2/0 copper)
- Selection table gives aluminum/copper equivalents for all sizes

Material: High-Conductivity Wrought Aluminum

Finish: Electro-Tin Plated

CAT. NO.	CABLE SIZE		DIMENSIONS (IN.)		DIE CODE	COLOR KEY
	ALUMINUM	COPPER	A	E		
60905	8	10	1 ¹ / ₁₆	5 ¹ / ₁₆	24	BLUE
60910	6	8	1 ¹ / ₈	1 ¹ / ₁₆	29	GRAY
60915	4	6	1 ¹ / ₄	7 ¹ / ₁₆	37	GREEN
60925	1	3	2 ¹ / ₈	1 ¹ / ₁₆	45	GOLD
60930	1/0	2	2 ¹ / ₄	5 ¹ / ₁₆	50	TAN
60935	2/0	1	2 ¹ / ₂	1 ¹ / ₈	54	OLIVE
60940	3/0	1/0	2 ³ / ₁₆	3 ¹ / ₁₆	60	RUBY
60945	4/0	2/0	3 ¹ / ₈	7 ¹ / ₁₆	66H	WHITE
60950	250 kcmil	3/0	4	1 ¹ / ₈	71H	RED
60955	300 kcmil	4/0	4 ¹ / ₈	1	76H	BLUE
60960	350 kcmil	4/0	5 ¹ / ₈	3 ¹ / ₁₆	87H	BROWN
60965	400 kcmil	250 kcmil	5 ¹ / ₈	1 ¹ / ₂	94H	GREEN
60970	500 kcmil	350 kcmil	5 ¹ / ₈	1 ³ / ₁₆	99H	PINK
60975	600 kcmil	400 kcmil	5 ¹ / ₈	1 ¹ / ₂	106H	BLACK
60980	700 kcmil	500 kcmil	5 ¹ / ₈	1 ¹ / ₈	112H	PURPLE
60985	750 kcmil	500 kcmil	5 ¹ / ₈	1 ¹ / ₂	115H	YELLOW

Selection table gives aluminum/copper equivalents for all sizes. Connectors are filled with a high-temperature oxide inhibiting compound.

Tooling: pp. B76-B92

Die Selector Chart: pp. B93-B95

Installing Tools: TBM5(s) #10 → 4/0

TBM6(s) #10 → 350 kcmil

TBM8(s) #10 → 350 kcmil

Transformer Lug Kits for Aluminum Code Conductor

Everything you need to connect to a transformer in one convenient kit.

Transformer Lug Kits

- For 90° C, 600V applications
- For use with aluminum cables only
- Include all necessary range-taking compression or mechanical type lugs and bolting hardware to connect to designated transformers



Color-Keyed® Compression

TRANSFORMER KVA SIZES	KIT CAT. NO.	TERMINAL LUGS		KIT CONTENTS					STD. PKG.	
		AL CABLE RANGE*	QTY.	NUTS	QTY.	BOLTS	QTY.	WASHERS		
Compression										
15-37½ 1Ø	611CL-SK1	#8-1/OAL	8	¼-20	8	¼-20 x 1"	8	FLAT ¼"	8	1
15-45 3Ø		#4-300 kcmil	4					SPRING ¼"	8	
50-75 1Ø	611CL-SK2	#4-300 kcmil AL	12	¼-20	16	¼-20 x 1"	8	FLAT ¼"	16	1
75-112½ 3Ø						¼-20 x 2"	8	SPRING ¼"	16	
100-167 1Ø	611CL-SK3	#4-300 kcmil AL	3	¼-20	3	¼-20 x ¾"	3	FLAT ¼"	3	
150-300 3Ø								SPRING ¼"	3	1
		#2/0-500MM AL	22	¾-16	16	¾-16 x 2"	16	FLAT ¾"	16	
								SPRING ¾"	16	
100-167 1Ø	611CL-SK3	#4-300 kcmil AL	3	¼-20	3	¼-20 x 1"	3	FLAT ¼"	3	
150-300 3Ø	-500							SPRING ¼"	3	1
		#2/0-500 kcmil AL	22	¾-16	16	¾-16 x 2"	16	FLAT ¾"	16	
								SPRING ¾"	16	
500 3Ø	611CL-SK4	#500-750 kcmil AL	29	¾-16	18	¾-16 x 2"	18	FLAT ¾"	18	1
								SPRING ¾"	18	
Mechanical										
15-37½ 1Ø	622ML-SK1	#14-2	8	¼-20	8	¼-20 x ¾"	8	FLAT ¼"	8	1
15-45 3Ø		#6-250	4					SPRING ¼"	8	
50-75 1Ø	622ML-SK2	#6-250	12	¼-20	16	¼-20 x ¼"	8	FLAT ¼"	16	1
75-112½ 3Ø						¼-20 x 1¼"	8	SPRING ¼"	16	
100-167 1Ø		#6-250	3	¼-20	3	¼-20 x ¾"	3	FLAT ¼"	3	
150-300 3Ø	622ML-SK3							SPRING ¼"	3	1
		350-800	22	¾-16	16	¾-16 x 2"	16	FLAT ¾"	16	
								SPRING ¾"	16	
500 3Ø	622ML-SK4	350-800	29	¾-16	18	¾-16 x 2"	18	FLAT ¾"	18	1
								SPRING ¾"	18	

* To ensure proper range taking compression on Color-Keyed® equipment lugs, use Smart® Tool (Cat. No. TBMS-750/TBMS-750M-1).

** Largest cable in lug can be applied with standard hex or hand tool.

Tooling: pp. B76-B92

Die Selector Chart: pp. B93-B95

Pin Connectors for Aluminum/Copper Code Conductor

Converts an aluminum cable into a two-sizes-smaller copper pigtail.

Bi-Pin® Bi-Metal Pin Connectors with Insulating Covers*

- For 90° C, 600V applications
- Upgrades connection by eliminating cold flow and oxidation of aluminum
- Reduces oversized aluminum cable
- Enables termination of aluminum cable into a copper-only lug
- Barrel prefilled with joint compound



Color-Keyed® Compression

Material: Copper Wire/Aluminum Body

Finish: Electro-Tin Plated

Insulator: Neoprene (600V dielectric rating)

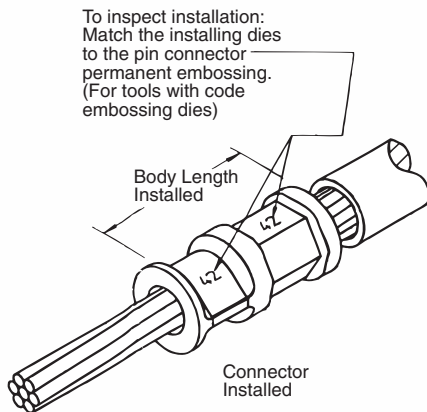
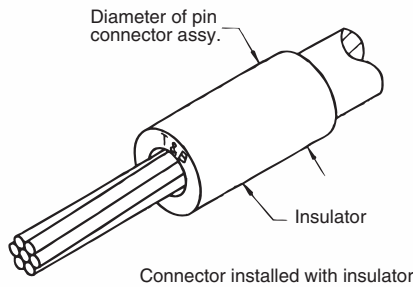
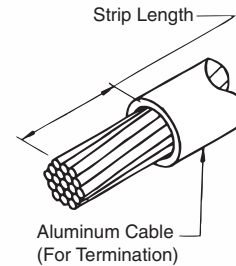
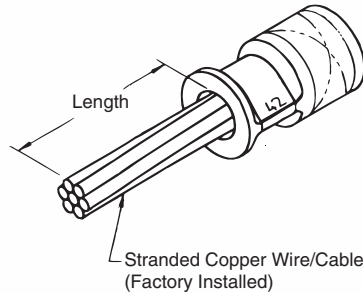

CAT. NO.	ALUM. CABLE SIZE	COPPER WIRE SIZE	BODY LENGTH AFTER INSTALLING (IN.)	DIE CODE NO.	COLOR KEY
61905A	8 AWG	10 AWG	1 1/8	24	BLUE
61910A	6 AWG	8 AWG	1 1/8	24	BLUE
61915A	4 AWG	6 AWG	1 1/8	45	GOLD
61920A	2 AWG	4 AWG	1 1/8	45	GOLD
61925A	1 AWG	3 AWG	1 1/8	50	ORANGE
61930A	1/0 AWG	2 AWG	1 1/8	50	ORANGE
61935	2/0 AWG	1 AWG	1 1/8	50	ORANGE
61940	3/0 AWG	1/0 AWG	2 1/8	60	RUBY
61945	4/0 AWG	2/0 AWG	2 1/8	60	RUBY
61950	250 kcmil	3/0 AWG	2 1/8	66	WHITE
61955	300 kcmil	4/0 AWG	2 1/8	71H	RED
61960	350 kcmil	250 kcmil	2 1/8	71H	RED
61963	400 kcmil	250 kcmil	3 1/8	87H	BROWN
61965	500 kcmil	350 kcmil	3 1/8	87H	BROWN
61970	600 kcmil	400 kcmil	3 1/8	107H	ORANGE
61975	700-750 kcmil	500 kcmil	3 1/8	107H	ORANGE

* 600V 90° C application

Hand Tools — Smart® Tool

Tooling: pp. B76-B92

Die Selector Chart: pp. B93-B95

Flag Lugs for Aluminum/Copper Code Conductor

90° Flag Lugs — 600V, 90° C

Material: Aluminum

Finish: Tin Plate

Insulation: PVC Dip Coated

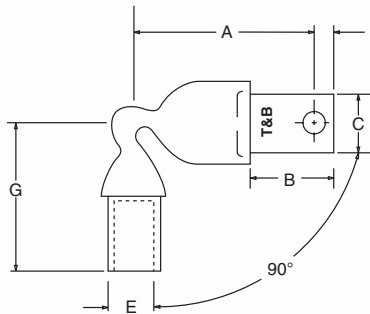
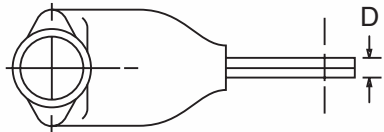

CAT. NO.	CU CABLE SIZE	STUD SIZE (IN.)	PHASE	DIMENSIONS (IN.)							DIE CODE	
				A	B	C	D	E	F	G		
10A-FT-14NTK	1/0	¼	1	1.38								
			2	2.13	.94	.64	.19	.62	.25	2.50	50	
			3	2.88								
20A-FT-14NTK	2/0	¼	1	1.93								
			2	2.93	1.14	.64	.22	.70	.25	2.50	54	
			3	3.93								
30A-FT-14NTK	3/0	¼	1	2.11								
			2	3.11	1.14	.78	.22	.77	.25	2.75	60	
			3	4.11								
40A-FT-14NTK	4/0	¼	1	2.04								
			2	3.04	1.14	.78	.25	.86	.25	3.13	66	
			3	4.04								

CAT. NO.	CU CABLE SIZE	STUD SIZE (IN.)	PHASE	DIMENSIONS (IN.)							DIE CODE	
				A	B	C	D	E	F	G		
250A-FT-14NTK	250 kcmil	¼	1	2.31								
			2	3.44	1.20	.98	.25	.92	.31	3.00	71	
			3	4.57								
350A-FT-12NTK	350 kcmil	¼	1	2.31								
			2	3.69	1.45	1.09	.31	1.09	.56	3.94	87	
			3	5.06								
500A-FT-12NTK	500 kcmil	¼	1	2.56								
			2	4.06	1.45	1.20	.38	1.28	.56	4.19	99	
			3	5.69								
750A-FT-58NTK	750 kcmil	¼	1	2.63								
			2	4.50	1.70	1.49	.38	1.50	.81	4.39	115	
			3	6.25								

* Each Cat. No. consists of three connectors, (1) connector per phase.
 Connectors supplied with Thomas & Betts oxide inhibitor compound in wire bore.
 Installation tooling: Hand or hydraulic tools.

Tooling: pp. B76–B92
 Die Selector Chart: pp. B93–B95

Heavy-Duty Battery Connectors

Color-Keyed® Compression



BAC10SUBT

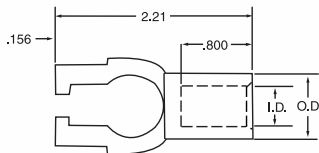

BAC10SPBT

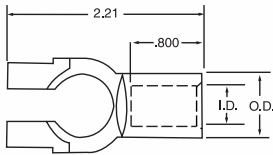

Tin-Plated Straight Battery Connectors

Material: High-Conductivity Copper

Finish: Electro-Tin Plated

Installing Tools: TBM5-SV, TBM5V, TBM8250, TBM8250S

CAT. NO.	BULK CAT. NO.	SAE CABLE SIZE AND COLOR	DESCRIPTION	I.D.	O.D.	PKG. QTY.	BULK PKG. QTY.	COLOR KEY
BAC4SUBT	BAC4SUBT-C	4 Gauge	Straight Universal	.261	.430	5	100	GRAY
BAC2SUBT	BAC2SUBT-C	2 Gauge	Straight Universal	.340	.550	5	100	GREEN
BAC1SUBT	BAC1SUBT-C	1 Gauge	Straight Universal	.340	.550	5	100	PINK
BAC10SUBT	BAC10SUBT-C	1/0 Gauge	Straight Universal	.455	.625	5	100	BLACK
BAC20SUBT	BAC20SUBT-C	2/0 Gauge	Straight Universal	.502	.676	5	100	ORANGE
BAC30SUBT	BAC30SUBT-C	3/0 Gauge	Straight Universal	.530	.730	5	100	PURPLE
BAC40SUBT	BAC40SUBT-C	4/0 Gauge	Straight Universal	.600	.844	5	100	YELLOW
BAC4SPBT	BAC4SPBT-C	4 Gauge	Straight Positive	.261	.430	5	100	GRAY
BAC4SNBT	BAC4SNBT-C	4 Gauge	Straight Negative	.261	.430	5	100	GRAY
BAC2SPBT	BAC2SPBT-C	2 Gauge	Straight Positive	.340	.550	5	100	GREEN
BAC2SNBT	BAC2SNBT-C	2 Gauge	Straight Negative	.340	.550	5	100	GREEN
BAC1SPBT	BAC1SPBT-C	1 Gauge	Straight Positive	.340	.550	5	100	PINK
BAC1SNBT	BAC1SNBT-C	1 Gauge	Straight Negative	.340	.550	5	100	PINK
BAC10SPBT	BAC10SPBT-C	1/0 Gauge	Straight Positive	.455	.625	5	100	BLACK
BAC10SNBT	BAC10SNBT-C	1/0 Gauge	Straight Negative	.455	.625	5	100	BLACK
BAC20SPBT	BAC20SPBT-C	2/0 Gauge	Straight Positive	.502	.676	5	100	ORANGE
BAC20SNBT	BAC20SNBT-C	2/0 Gauge	Straight Negative	.502	.676	5	100	ORANGE
BAC30SPBT	BAC30SPBT-C	3/0 Gauge	Straight Positive	.530	.730	5	100	PURPLE
BAC30SNBT	BAC30SNBT-C	3/0 Gauge	Straight Negative	.530	.730	5	100	PURPLE
BAC40SPBT	BAC40SPBT-C	4/0 Gauge	Straight Positive	.600	.844	5	100	YELLOW
BAC40SNBT	BAC40SNBT-C	4/0 Gauge	Straight Negative	.600	.844	5	100	YELLOW

Tin-Plated Flag Battery Connectors

Material: High-Conductivity Copper

Finish: Electro-Tin Plated

Installing Tools: TBM5-SV, TBM5V, TBM8250, TBM8250S



BAC10FNBT

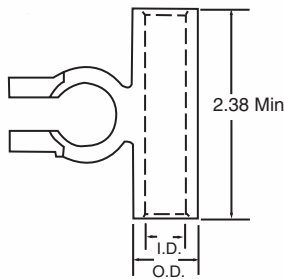

CAT. NO.	BULK CAT. NO.	SAE CABLE SIZE AND COLOR	DESCRIPTION	I.D.	O.D.	PKG. QTY.	BULK PKG. QTY.	COLOR KEY
BAC10FU	BAC10FNBL	1/0 Gauge	Flag Universal	.455	.625	5	100	BLACK
BAC20FU	BAC20FNBL	2/0 Gauge	Flag Universal	.502	.676	5	100	ORANGE
BAC30FU	BAC30FNBL	3/0 Gauge	Flag Universal	.530	.730	5	100	PURPLE
BAC40FU	BAC40FNBL	4/0 Gauge	Flag Universal	.600	.844	5	100	YELLOW
BAC10FPBT	BAC10FPBT-C	1/0 Gauge	Flag Positive	.455	.625	5	100	BLACK
BAC10FNBT	BAC10FNBT-C	1/0 Gauge	Flag Negative	.455	.625	5	100	BLACK
BAC20FPBT	BAC20FPBT-C	2/0 Gauge	Flag Positive	.502	.676	5	100	ORANGE
BAC20FNBT	BAC20FNBT-C	2/0 Gauge	Flag Negative	.502	.676	5	100	ORANGE
BAC30FPBT	BAC30FPBT-C	3/0 Gauge	Flag Positive	.530	.730	5	100	PURPLE
BAC30FNBT	BAC30FNBT-C	3/0 Gauge	Flag Negative	.530	.730	5	100	PURPLE
BAC40FPBT	BAC40FPBT-C	4/0 Gauge	Flag Positive	.600	.844	5	100	YELLOW
BAC40FNBT	BAC40FNBT-C	4/0 Gauge	Flag Negative	.600	.844	5	100	YELLOW

Heavy-Duty Battery Connectors

Tin-Plated Elbow Battery Connectors

Material: High-Conductivity Copper

Finish: Electro-Tin Plated

Installing Tools: TBM5-SV, TBM5V, TBM8250, TBM8250S



BAC10ERNBT



BAC10ELNBT

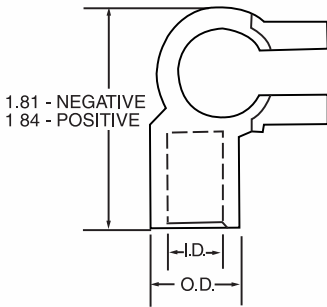

CAT. NO.	BULK CAT. NO.	SAE CABLE SIZE AND COLOR	DESCRIPTION	I.D.	O.D.	PKG. QTY.	BULK PKG. QTY.	COLOR KEY
BAC10ERNBT	BAC10ERNBT-C	1/0 Gauge	Right Elbow - Negative	.455	.625	5	100	BLACK
BAC10ERPBT	BAC10ERPBT-C	1/0 Gauge	Right Elbow - Positive	.455	.625	5	100	BLACK
BAC20ERNBT	BAC20ERNBT-C	2/0 Gauge	Right Elbow - Negative	.502	.676	5	100	ORANGE
BAC20ERPBT	BAC20ERPBT-C	2/0 Gauge	Right Elbow - Positive	.502	.676	5	100	ORANGE
BAC30ERNBT	BAC30ERNBT-C	3/0 Gauge	Right Elbow - Negative	.530	.730	5	100	PURPLE
BAC30ERPBT	BAC30ERPBT-C	3/0 Gauge	Right Elbow - Positive	.530	.730	5	100	PURPLE
BAC40ERNBT	BAC40ERNBT-C	4/0 Gauge	Right Elbow - Negative	.600	.844	5	100	YELLOW
BAC40ERPBT	BAC40ERPBT-C	4/0 Gauge	Right Elbow - Positive	.600	.844	5	100	YELLOW
BAC10ELNBT	BAC10ELNBT-C	1/0 Gauge	Left Elbow - Negative	.455	.625	5	100	BLACK
BAC10ELPBT	BAC10ELPBT-C	1/0 Gauge	Left Elbow - Positive	.455	.625	5	100	BLACK
BAC20ELNBT	BAC20ELNBT-C	2/0 Gauge	Left Elbow - Negative	.502	.676	5	100	ORANGE
BAC20ELPBT	BAC20ELPBT-C	2/0 Gauge	Left Elbow - Positive	.502	.676	5	100	ORANGE
BAC30ELNBT	BAC30ELNBT-C	3/0 Gauge	Left Elbow - Negative	.530	.730	5	100	PURPLE
BAC30ELPBT	BAC30ELPBT-C	3/0 Gauge	Left Elbow - Positive	.530	.730	5	100	PURPLE
BAC40ELNBT	BAC40ELNBT-C	4/0 Gauge	Left Elbow - Negative	.600	.844	5	100	YELLOW
BAC40ELPBT	BAC40ELPBT-C	4/0 Gauge	Left Elbow - Positive	.600	.844	5	100	YELLOW

Stackable Battery Connector — Lead-Plated

Material: High-Conductivity Copper

Finish: Electro-Tin Plated

Installing Tools: TBM5-SV or TBM5V



BAC1038

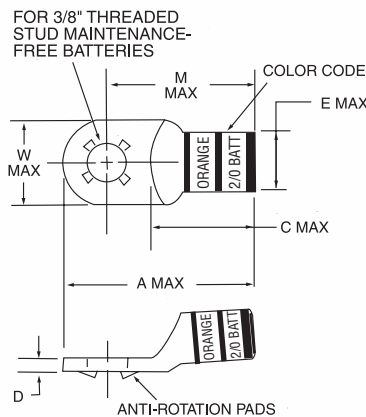

CAT. NO.	BULK CAT. NO.	SAE CABLE SIZE AND COLOR	A ±.040	M ±.020	W ±.020	C ±.020	E ±.010	STUD SIZE	PKG. QTY.	BULK PKG. QTY.	COLOR KEY
BAC438	273-31853-1	4 Gauge	1.455	1.143	.615	.750	.365	%	10	100	GRAY
BAC238	273-31853-2	2 Gauge	1.775	1.400	.675	.850	.467	%	10	100	GREEN
BAC138	273-31853-3	1 Gauge	1.875	1.500	.750	.950	.521	%	10	100	PINK
BAC1038	273-31853-4	1/0 Gauge	1.925	1.550	.825	1.000	.571	%	10	100	BLACK
BAC2038	273-31853-5	2/0 Gauge	2.110	1.645	.930	1.100	.632	%	10	100	ORANGE
BAC3038	273-31853-6	3/0 Gauge	2.025	1.650	1.025	1.100	.701	%	10	100	PURPLE
BAC4038	273-31853-7	4/0 Gauge	2.275	1.900	1.125	1.350	.766	%	10	100	YELLOW

Heavy-Duty Battery Connectors

Color-Keyed® Starter Lugs — Tin Plated

Color-Keyed® Compression



BAL414

Material: High-Conductivity Copper

Finish: Electro-Tin Plated

Installing Tools: TBM5-SV or TBM5V

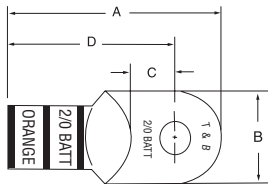

CAT. NO.	BULK CAT. NO.	SAE CABLE SIZE AND COLOR	STUD SIZE (IN.)	A ±04	B ±02	C ±02	D ±02	PKG. QTY.	BULK PKG. QTY.	COLOR KEY
BAL414	273-31852-1	4 Gauge	¼	140	52	40	115	10	100	GRAY
BAL4516	273-31852-2	4 Gauge	⅜	145	61	36	114	10	100	GRAY
BAL438	273-31852-3	4 Gauge	⅜	145	61	36	114	10	100	GRAY
BAL2516	—	2 Gauge	⅜	159	69	40	125	10	100	GREEN
BAL238	273-31852-4	2 Gauge	⅜	178	67	55	140	10	100	GREEN
BAL212	273-31852-5	2 Gauge	½	177	76	54	140	10	100	GREEN
BAL1516	—	1 Gauge	⅜	183	76	49	150	10	100	PINK
BAL138	273-31852-6	1 Gauge	⅜	185	75	55	150	10	100	PINK
BAL112	273-31852-7	1 Gauge	½	220	75	75	170	10	100	PINK
BAL10516	—	1/0 Gauge	⅜	192	83	50	150	10	100	BLACK
BAL1038	273-31852-8	1/0 Gauge	⅜	193	83	55	155	10	100	BLACK
BAL1012	273-31852-9	1/0 Gauge	½	197	88	53	153	10	100	BLACK
BAL20516	—	2/0 Gauge	⅜	206	93	50	160	10	100	ORANGE
BAL2038	273-31852-10	2/0 Gauge	⅜	211	93	55	165	10	100	ORANGE
BAL2012	273-31852-11	2/0 Gauge	½	211	93	55	165	10	100	ORANGE
BAL30516	—	3/0 Gauge	⅜	216	103	55	165	10	100	PURPLE
BAL3038	273-31852-12	3/0 Gauge	⅜	203	103	55	165	10	100	PURPLE
BAL3012	273-31852-13	3/0 Gauge	½	235	103	75	185	10	100	PURPLE
BAL40516	—	4/0 Gauge	⅜	240	113	59	184	10	100	YELLOW
BAL4038	273-31852-14	4/0 Gauge	⅜	228	112	55	190	10	100	YELLOW
BAL4012	273-31852-15	4/0 Gauge	½	260	112	75	210	10	100	YELLOW

Splices (Two-Way Connectors)



BAS4

Material: High-Conductivity Copper

Finish: Electro-Tin Plated

Installing Tools: TBM5-SV or TBM5V

CAT. NO.	BULK CAT. NO.	SAE CABLE SIZE AND COLOR	PKG. QTY.	BULK PKG. QTY.	COLOR KEY
BAS4	273-31852-16	4 Gauge	10	100	GRAY
BAS2	273-31852-17	2 Gauge	10	100	GREEN
BAS1	273-31852-18	1 Gauge	10	100	PINK
BAS10	273-31852-19	1/0 Gauge	10	100	BLACK
BAS20	273-31852-20	2/0 Gauge	10	100	ORANGE
BAS30	273-31852-21	3/0 Gauge	10	100	PURPLE
BAS40	273-31852-22	4/0 Gauge	10	100	YELLOW

“Y” Splices

Material: High-Conductivity Copper

Finish: Electro-Tin Plated

Installing Tools: TBM5-SV or TBM5V

Insulating Cover: AC5X3



BASY30

CAT. NO.	STRIP CABLE SIZE	SAE CABLE SIZE AND COLOR	LENGTH	COLOR KEY
BASY20	2/0-(2)2	2/0 Gauge	¾"	ORANGE
BASY30	3/0-(2)1	3/0 Gauge	¾"	PURPLE
BASY40	4/0-(2)1/0	4/0 Gauge	¾"	YELLOW

Battery Cables, Heavy-Duty Battery Cables

Abrasion-resistant and engineered for optimum performance at both high and low temperatures.

Color-Keyed® Battery/Starter Cables

- Fine flexible copper rope stranding PVC jacket conforms to SAE J1127 specifications
- Layer of paper separates insulation from copper, providing easy stripping with no stranding damage
- Temperature-rated for 80° C
- Flexibility ideal for tight spaces and cold environments
- Color-Keyed® markings for fast and accurate identification
- Marked in 1-ft. increments for easy measurement
- Available in red or black jacket color



BC10-25



BC10-25R

CAT. NO.	SAE CABLE SIZE	CABLE LENGTH	CABLE COLOR
BC4-100	4 Gauge	100 Ft. Coil	BLACK
BC2-100	2 Gauge	100 Ft. Coil	BLACK
BC1-100	1 Gauge	100 Ft. Coil	BLACK
BC10-100	1/0 Gauge	100 Ft. Coil	BLACK
BC20-100	2/0 Gauge	100 Ft. Coil	BLACK
BC30-100	3/0 Gauge	100 Ft. Coil	BLACK
BC40-100	4/0 Gauge	100 Ft. Coil	BLACK

BC4-1000	4 Gauge	1000 Ft. Coil	BLACK
BC2-500	2 Gauge	500 Ft. Coil	BLACK
BC1-500	1 Gauge	500 Ft. Coil	BLACK
BC10-500	1/0 Gauge	500 Ft. Coil	BLACK
BC20-500	2/0 Gauge	500 Ft. Coil	BLACK
BC30-500	3/0 Gauge	500 Ft. Coil	BLACK
BC40-500	4/0 Gauge	500 Ft. Coil	BLACK

BC4-1000R	4 Gauge	1000 Ft. Coil	RED
BC2-500R	2 Gauge	500 Ft. Coil	RED
BC1-500R	1 Gauge	500 Ft. Coil	RED
BC10-500R	1/0 Gauge	500 Ft. Coil	RED
BC20-500R	2/0 Gauge	500 Ft. Coil	RED
BC30-500R	3/0 Gauge	500 Ft. Coil	RED
BC40-500R	4/0 Gauge	500 Ft. Coil	RED



CAT. NO.	SAE CABLE SIZE	CABLE LENGTH	CABLE COLOR
BC4-25	4 Gauge	25 Ft. Coil	BLACK
BC2-25	2 Gauge	25 Ft. Coil	BLACK
BC1-25	1 Gauge	25 Ft. Coil	BLACK
BC10-25	1/0 Gauge	25 Ft. Coil	BLACK
BC20-25	2/0 Gauge	25 Ft. Coil	BLACK
BC30-25	3/0 Gauge	25 Ft. Coil	BLACK
BC40-25	4/0 Gauge	25 Ft. Coil	BLACK

BC4-25R	4 Gauge	25 Ft. Coil	RED
BC2-25R	2 Gauge	25 Ft. Coil	RED
BC1-25R	1 Gauge	25 Ft. Coil	RED
BC10-25R	1/0 Gauge	25 Ft. Coil	RED
BC20-25R	2/0 Gauge	25 Ft. Coil	RED
BC30-25R	3/0 Gauge	25 Ft. Coil	RED
BC40-25R	4/0 Gauge	25 Ft. Coil	RED

Material: High-Conductivity Copper

Finish: Electro-Tin Plated

Installing Tools: TBM5-SV or TBM5V

Specially designed for demanding industrial and OEM requirements.

Heavy-Duty Battery Cable

- 105°C temperature-rated and UL recognized
- Heavier PVC jacket conforms to SAE J1127 specifications
- Color-Keyed® markings for fast and accurate identification
- Marked in 1-ft. increments for easy measurement
- Layer of paper separates insulation from copper for easy stripping with no strand damage
- 600V rated available in bulk only
- Application-specific — call to order



Color-Keyed® Compression

Mechanical Compression Tools: #8 to 250 MCM

TBM25S Crimp Tool



Creates Diamond-style crimp

- Wide range of #8 to #2 for copper lugs and #10 to #6 for aluminum lugs
- Each die has die code embossing
- Shure-Stake® mechanism ensures a properly completed crimp each time
- Color-coded die wheel rotates into position for proper die nest
- Also installs up to green color-coded C-taps and MD2 Series motor disconnects
- Requires two crimps per connector



CAT. NO.	DESCRIPTION	PKG. QTY.
TBM25S	Crimp tool with Shure-Stake® mechanism for #8–#2 copper and #10–#6 aluminum	1

TBM4S Dieless Crimp Tool



Creates Indent-style crimp

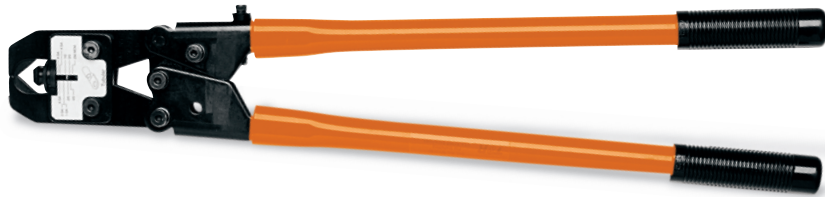

- Wide range of #8 to 250 kcmil for copper lugs and #8 to 4/0 for aluminum lugs
- Adjustable indenter eliminates the need to buy and maintain numerous individual dies
- Shure-Stake® mechanism ensures a properly completed crimp each time
- Easily adjusted by turning knurled adjusting wheel and aligning pointer with proper terminal size
- Dieless, adjustable crimper for Color-Keyed® compression connectors

CAT. NO.	DESCRIPTION	PKG. QTY.
TBM4S	Dieless crimp tool with Shure-Stake® mechanism for #8–250 kcmil copper and #8–4/0 aluminum	1

TBM5S Crimp Tool



Creates Diamond-style crimp



- Wide range of #8 to 250 kcmil for copper and #10 to 4/0 for aluminum lugs and splices
- Also installs C-taps from 54705 to 54750
- Shure-Stake® mechanism ensures a properly completed crimp each time
- Includes color-coded, die-code-embossed installation dies

CAT. NO.	Color Code	DIE CAT. NO.	PKG. QTY.
TBM5S	RED	13454	1
	BLUE		
	GRAY		
	BROWN	13455	
	GREEN		
	PINK		
	BLACK	13456	
	ORANGE		
	PURPLE		
	YELLOW	13457	
	GOLD		
	TAN		
	OLIVE	13458	
RUBY			
WHITE			

Mechanical Compression Tools: #8 to 500 MCM

TBM6S Crimp Tool



Creates Diamond-style crimp



- Wide ranges of #8 thru 500 kcmil for copper lugs, splices and taps and #10 thru 350 kcmil for aluminum lugs and splices
- Also installs 63105 through 63140 orange, green and blue H-taps
- Shure-Stake® mechanism ensures a properly completed crimp each time
- Comes complete with plastic carrying case and wire brush

CAT. NO.	COLOR CODE	CAT. NO. UPPER DIE	CAT. NO. LOWER DIE	PKG. QTY.
TBM6S	RED	13475	13477	1
	BLUE	13475	13477	
	GRAY	13472	13476	
	BROWN	13474	13477	
	GREEN	13474	13477	
	PINK	13475	13477	
	BLACK	13474	13477	
	ORANGE	13474	13477	
	PURPLE	13475	13477	
	YELLOW	13473	13476	
	GOLD	13474	13477	
	TAN	13474	13477	
	OLIVE	13475	13477	
	RUBY	13473	13476	
	WHITE	13473	13476	
	RED	13472	13476	
BLUE	13472	13476		

Carrying Cases for TBM5S and TBM6S

CAT. NO.	DESCRIPTION	PKG. QTY.
295-31365M	Steel Carrying Case for TBM5S and TBM6S	1
295-31365	Plastic Carrying Case for TBM5S and TBM6S	1

TBM8S Crimp Tool



Creates Diamond-style crimp

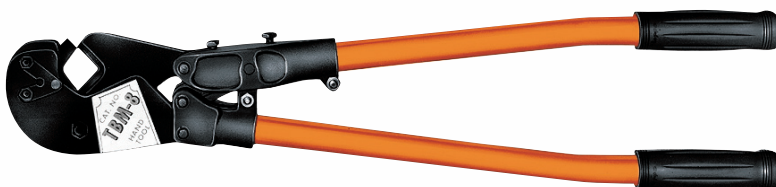

- Installs code copper lugs and connectors #8 through 500 kcmil
- Installs aluminum lugs and connectors #10 through 350 kcmil
- Shure-Stake® mechanism ensures positive compression
- Included dies are color-coded and provide die-code embossing for easy installation and inspection
- Installs all code copper compression joints and small C-taps
- Comes complete with installing dies and wire brush in plastic carrying case

CAT. NO.	COLOR CODE	DIE CAT. NO.	PKG. QTY.
TBM8S	RED	13461	1
	BLUE		
	GRAY		
	BROWN	13462	
	GREEN		
	PINK		
	BLACK	13463	
	ORANGE		
	PURPLE		
	YELLOW	13464	
	GOLD		
	TAN		
	OLIVE	13465	
	RUBY		
	WHITE		
	RED	13466	
BLUE	13467		
BROWN	13468		

Power-Assisted Compression Tools: #8 to 500 MCM

25000 Air-Operated Bench-Mount Crimp Tool

Color-Keyed® Compression



- Installs copper and aluminum connectors on wire sizes from 8 AWG to 500 kcmil
- Compact, heavy-duty air tool
- Simple to operate — just insert stripped wire into connector barrel, position it in crimping nest and depress foot pedal to actuate crimping dies
- Uses same crimping dies as TBM6S (see p. B-75)



Creates Diamond-style crimp

CAT. NO.	DESCRIPTION	PKG. QTY.
25000	Air-Operated Bench-Mount Crimp Tool	1

Battpac® LT BPLT62BSCR/BPLT62500BSCR 6-Ton Compression Tools



- Ergonomic design and reduced weight for operator comfort
- New double-speed feature decreases crimp time by doubling jaw speed until it reaches load
- New, more powerful Ni-MH battery has 50% more energy and less memory effect than old batteries
- Rotating head allows maximum flexibility for crimping
- Uses TBM62 Series dies



Creates Hex-style crimp

Specifications

- Installing Range:
 - Up to 500 mcm copper lugs & splices
 - Up to 350 mcm aluminum lugs & splices
 - 54705 to 54750 C-taps
- Output Force: 6 tons
- Dimensions (L x W x H): 11" x 3 3/4" x 11 1/2"
- Battery: Ni-MH 14.4V 3.0Ah
- Weight with Battery: 8 lbs.

CAT. NO.	DESCRIPTION	PKG. QTY.
BPLT62BSCR	Battpac® LT Tool Kit. Includes tool, two batteries, charger, shoulder strap, wrist strap, carrying case (no dies).	1
BPLT62500BSCR	Complete Battpac® LT Tool Kit with dies TBM6221 through TBM6287.	1

Power-Assisted Compression Tools: #8 to 600 MCM

Battpac® LT BPLT6BSCR 6-Ton Compression Tool

- Open yoke design allows for maximum crimping flexibility
- New double-speed feature decreases crimp time by doubling jaw speed until it reaches load
- New, more powerful Ni-MH battery has 50% more energy and less memory effect than old batteries
- Uses 6-TON Series dies and Blackburn “O” and “D” Series dies



Creates Hex-style crimp



NEW!

Color-Keyed® Compression

Specifications

- Installing Range:
 - Up to 600 mcm copper lugs & splices
 - Up to 400 mcm aluminum lugs & splices
 - CHT814-10 to CHT214-9 copper H-taps
 - 63105 to 63148 aluminum H-taps
 - 54705 to 54750 C-taps
- Output Force: 6 tons
- Dimensions (L x W x H): 11" x 3 3/4" x 11 7/8"
- Battery: Ni-MH 14.4V 3.0Ah
- Weight with Battery: 8 lbs.

CAT. NO.	DESCRIPTION	PKG. QTY.
BPLT6BSCR	Battpac® LT Tool Kit. Includes tool, two batteries, charger, shoulder strap, carrying case (no dies)	1

Battpac® TBM61520BSCR 6-Ton Compression Tool and Optional 61520CAT Cutting Head

- Supplied crimp head can be interchanged with optional cutter head — quick-release pins make the switch fast and simple
- Rapid-advance feature yields quicker compression cycles
- Optional cutting head cuts cable up to 500 kcmil
- 1.8" jaw opening
- D3 die nest comes standard with tool
- Accepts T&B® 6-TON SERIES, Blackburn® “O” dies and other manufacturers’ crimp dies



Creates Hex-style crimp



Specifications

- Installing Range:
 - Up to 600 mcm copper lugs & splices
 - Up to 400 mcm aluminum lugs & splices
 - CHT814-10 to CHT214-9 copper H-taps
 - 63105 to 63148 aluminum H-taps
- Max. Cutting Capacity (with 61520CAT cutting head):
 - Copper and aluminum cable to 500 kcmil
- Output Force: 6 tons
- Dimensions (L x W x H): 12" x 3" x 13"
- Battery: Ni-MH 14.4V 3.0Ah

CAT. NO.	DESCRIPTION	PKG. QTY.
TBM61520BSCR	Battpac® Crimp Tool Kit. Includes battery-powered crimp tool, battery, charger, shoulder strap, carrying case (no dies)	1
61520CAT	Interchangeable Cutting Head for TBM61520BSCR	1
TBM61520BSCR	Battpac® Crimp/Cut Tool Kit. Includes battery-powered crimp tool, interchangeable cutting head, battery, charger, shoulder strap, carrying case (no dies)	1

TBM6H 6-Ton Hydraulic Crimping Head

- Lightweight design — weighs less than 7 lbs., including dies
- Embosses die code on connection for easy inspection
- Uses 6-TON Series and Blackburn “O” and “D” Series dies color-coded for easy matching with Color-Keyed® connectors



Creates Hex-style crimp



Specifications

- Installing Range:
 - Up to 600 mcm copper lugs & splices
 - Up to 400 mcm aluminum lugs & splices
 - CHT814-10 to CHT214-9 copper H-taps
 - 63105 to 63148 aluminum H-taps
 - 54705 to 54750 C-taps
- Output Force: 6 tons
- Operating Pressure: 10,000 psi nominal
- Dimensions (L x W x H): 12" x 2 1/4" x 3 3/8"
- Weight without Dies: 6.5 lbs.

CAT. NO.	DESCRIPTION	PKG. QTY.
TBM6H	6-Ton Hydraulic Head with Steel Case	1
TBM6HD-1	Die Set for #8 thru 500 kcmil (6-TON21 thru 6-TON87)	1

Power-Assisted Compression Tools: #8 to 750 MCM, #8 to 900 MCM

TBM12 12-Ton Hydraulic Crimp Head

Color-Keyed® Compression



Creates Hex-style crimp



- Rugged steel construction is durable for most applications
- Includes five sets of multi-nested dies
- Dies emboss die code on connectors for easy inspection
- Closed yoke design yields maximum crimp performance
- Uses TBM12D style dies

Specifications

- Installing Range:
 - Up to 900 mcm copper lugs & splices
 - Up to 750 mcm aluminum lugs & splices
 - 54755 to 54775 C-taps
- Output Force: 12 tons
- Operating Pressure: 10,000 psi nominal
- Dimensions (L x W x H): 14½" x 2½" x 3⅝"
- Weight without Dies: 9 lbs.

CAT. NO.	DESCRIPTION	PKG. QTY.
TBM12	12-ton Hydraulic Head with Steel Case	1

If using old style 11700 Series Die Set, use adapter, Cat. No. TBM12D-AR (not included) for adaptation to the above tool. Order adapter separately.

13642M 12-Ton Hydraulic Crimping Head

- Rugged steel construction is durable for most applications
- Used for Color-Keyed® and Sta-Kon® connectors
- The only military-listed hydraulic head (Mil. Spec. MS25441-1)
- Uses 11700 Series dies for Color-Keyed® connectors; see Sta-Kon® section for Sta-Kon® dies

Specifications

- Installing Range:
 - Up to 900 mcm copper lugs & splices
 - Up to 750 mcm aluminum lugs & splices
 - 54755 to 54775 C-taps
- Output Force: 12 tons
- Operating Pressure: 10,000 psi nominal
- Dimensions (L x W x H): 14½" x 2½" x 3⅝"
- Weight without Dies: 9 lbs.

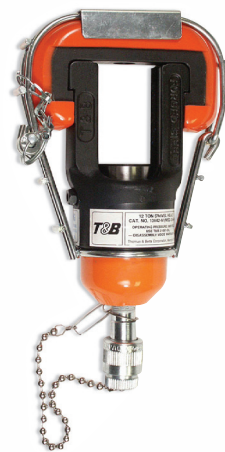

Creates Hex-style crimp

CAT. NO.	DESCRIPTION	PKG. QTY.
13642M	12-ton Hydraulic Head with Steel Case	1

Power-Assisted Compression Tools: #8 to 900 MCM

SMART® Tools

- Tool is “smart” because it requires no dies
- Automatically compresses to the correct depth based on size of connector in jaws
- C-type head swivels 90° for easy crimp positioning
- Forged steel construction is well suited for both field and bench work
- Installs both Color-Keyed® and non-insulated Sta-Kon® connectors

How the SMART® Tool Works

The SMART® Tool was engineered with built-in intelligence* that enables it to sense the connector barrel diameter and automatically apply just the right amount of compression force. This eliminates virtually all air spaces and forms the connector and conductor strands into a solid mass, resulting in a high-quality, low-resistance connection. In addition, the tool clearly embosses “T&B” with each compression for positive verification that the correct tool was used.

* System Novopress

Uniform, Dependable Connections

The SMART® Tool gives you consistent, high-quality compression connections over a wide range of connector sizes. Available in manual, battery-powered and air-operated versions, this tool easily installs lugs and splices from #8 AWG through 900 mcm copper or 750 mcm aluminum — without changing dies. For the specified wire range, all you need is one tool. You always have the right die size, eliminating die-selection mistakes.

Lower Installation Costs

Productivity will be greatly improved with the SMART® Tool, especially when installing a variety of connector sizes or types. Initial investment is low, requiring minimal tool inventory. These benefits add up to lower installed cost.

C-Type Yoke Offers Installation Convenience

The C-type yoke configuration and large die spacing enable the SMART® Tool to slip directly over the connector. This means added speed and convenience when installing two-way splice connectors, especially in confined spaces.

SMART® Tool Range Taking Features

The following size Color-Keyed® lugs and splice connectors, when crimped with the SMART® Tools, produce these range taking capabilities:

Copper		Aluminum	
Standard Wire Size	Range Taking	Standard Wire Size	Range Taking
1/0-AWG	#6-1/0 AWG	1/0-AWG	#6-1/0 AWG
2/0-AWG	#1-2/0 AWG	2/0-AWG	#1-2/0 AWG
4/0-AWG	#2-4/0 AWG	4/0-AWG	#2-4/0 AWG
300 kcmil	#2/0-300 kcmil	300 kcmil	#2/0-300 kcmil
350 kcmil	250-350 kcmil	350 kcmil	250-350 kcmil
500 kcmil	250-500 kcmil	500 kcmil	4/0-500 kcmil
750 kcmil	500-750 kcmil	750 kcmil	500-750 kcmil

TBM8-750M-1 12-Ton Dieless Manual Hydraulic Tool



Creates Indent-style crimp



Specifications

- Installing Range:
 - Up to 900 mcm copper lugs & splices
 - Up to 750 mcm aluminum lugs & splices
- Output Force: 12 tons
- Dimensions (L x W): 21½" x 4½"
- Weight: 13 lbs.

CAT. NO.	DESCRIPTION	PKG. QTY.
TBM8-750M-1	12-Ton Dieless Manual Hydraulic Compression Tool	1

Battpac® LT TBM8-750BSCR 12-Ton Dieless Battery-Powered Tool



Creates Indent-style crimp



Specifications

- Installing Range:
 - Up to 900 mcm copper lugs & splices
 - Up to 750 mcm aluminum lugs & splices
- Output Force: 12 tons
- Dimensions (L x W x H): 19½" x 3¾" x 8½"
- Battery: Ni-MH 14.4V 3.0Ah
- Weight with Battery: 9 lbs.

CAT. NO.	DESCRIPTION	PKG. QTY.
TBM8-750BSCR	Battpac® LT 12-Ton Dieless Battery-Powered Compression Tool. Includes carrying case, charger, two batteries and carry strap.	1

TBM8-750 12-Ton Dieless Hydraulic Head



Creates Indent-style crimp



Specifications

- Installing Range:
 - Up to 900 mcm copper lugs & splices
 - Up to 750 mcm aluminum lugs & splices
- Operating Pressure: 10,000 psi nominal
- Dimensions (L x W x H): 14½" x 4½" x 2½"
- Weight: 9 lbs.
- Output Force: 12 tons

CAT. NO.	DESCRIPTION	PKG. QTY.
TBM8-750	12-Ton Dieless Hydraulic Compression Head	1

Color-Keyed® Compression

Power-Assisted Compression Tools: #8 to 900 MCM

TBM14M 14-Ton Manual Hydraulic Crimp Tool

- Features short fiberglass handles for insulation and ease of use in tight spaces
- Two-stage pump provides rapid advance for fast installation
- Uses standard T&B Color-Keyed® 15500 Series dies

Specifications

- Installing Range: 63105 to 63148 aluminum H-taps
Up to 900 mcm copper lugs & splices 54755 to 54775 C-taps
- Output Force: 14 tons
- Length: 24"
- Weight without Dies: 15.4 lbs.
- Up to 750 mcm aluminum lugs & splices
- CHT814-10 to CHT2502-6 copper H-taps



Creates Hex-style crimp



CAT. NO.	DESCRIPTION	PKG. QTY.
TBM14M	14-ton manual hydraulic crimp tool with case	1

TBM14MC 14-Ton Compact Manual Hydraulic Crimp Tool



- Improved ergonomic design requires less force
- 180° rotating head for use in tight spaces
- 1.65" jaw opening accommodates large compression terminals and joints
- Dual-speed action pump offers fast advancing speed for approach of die to connector and slower, more powerful speed for crimping
- Built-in safety valve bypasses oil supply at maximum pressure
- Pressure-release system can be easy activated at any stage of compression
- Uses standard T&B Color-Keyed® 15500 Series dies

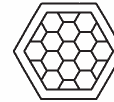

Creates Hex-style crimp



Specifications

- Installing Range: 63105 to 63148 aluminum H-taps
Up to 900 mcm copper lugs & splices 54755 to 54775 C-taps
- Output Force: 14 tons
- Length: 20½"
- Weight without Dies: 14 lbs.
- Up to 750 mcm aluminum lugs & splices
- CHT814-10 to CHT2502-6 copper H-taps

CAT. NO.	DESCRIPTION	PKG. QTY.
TBM14MC	14-ton compact hydraulic crimp tool	1

Battpac® TBM14BSCR Hermetically Sealed 14-Ton Battery-Powered Compression Tool



TBM14BSCR

- Weather-resistant, non-ventilated body for maximum protection from the elements
- Double-speed feature decreases crimp time by doubling jaw speed until it reaches load
- 180° rotating head
- 75kv live line rated
- Insulated crimping head
- 20-minute rapid battery charger
- Includes two batteries



Creates Hex-style crimp

Specifications

- Installing Range: 54755 to 54775 C-taps
Up to 900 mcm copper lugs & splices
- Output Force: 14 tons
- Dimensions (L x W x H): 19" x 3½" x 10½"
- Battery: 14.4V 3.0Ah Ni-Cd
- Weight with Battery: 20 lbs.
- Up to 750 mcm aluminum lugs & splices
- CHT814-10 to CHT2502-6 copper H-taps
- 63105 to 63148 aluminum H-taps

CAT. NO.	DESCRIPTION	PKG. QTY.
TBM14BSCR	Battpac® 14-Ton Compression Tool. Hermetically sealed unit. Includes carrying case, charger, two batteries, carry strap	1

Power-Assisted Compression Tools: #8 to 900 MCM and #8 to 1500 MCM

Battpac® LT BPLT14BSCR/BPLT14BSCRI 14-Ton Battery-Powered Compression Tools



BPLT14BSCR

- Reduced weight and ergonomic design
- Double-speed feature decreases crimp time by doubling jaw speed until it reaches load
- Rotating head allows maximum flexibility for crimping
- Includes two Makita 14.4V Ni-MH batteries (3.0 AMP Hrs.)
- Built-in LED battery power indicator
- On-tool DC power jack

Specifications

- Installing Range: 54755 to 54775 C-taps
- Up to 900 mcm copper lugs & splices
- Up to 750 mcm aluminum lugs & splices
- CHT814-10 to CHT2502-6 copper H-taps
- 63105 to 63148 aluminum H-taps
- Output Force: 14 tons
- Dimensions (L x W x H): 18 1/2" x 3 3/4" x 10"
- Battery: 14.4V 3.0Ah Ni-MH
- Weight with Battery: 18.1 lbs.

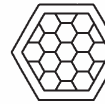

Creates Hex-style crimp

CAT. NO.	DESCRIPTION	PKG. QTY.
BPLT14BSCR	Battpac® LT 14-Ton Compression Tool. Includes carrying case, charger, two-batteries, carry strap	1
BPLT14BSCRI	Same as above, but fully insulated	

13100A 14-Ton Hydraulic Crimping Head

- Rugged design, made to last in field or on bench
- C-yoke provides maximum flexibility for crimping
- Uses standard T&B Color-Keyed® 15500 Series dies
- Operates on 10,000 psi hydraulic pumps



Creates Hex-style crimp



Specifications

- Installing Range: 54755 to 54775 C-taps
- Up to 900 mcm copper lugs & splices
- Up to 750 mcm aluminum lugs & splices
- CHT814-10 to CHT2502-6 copper H-taps
- 63105 to 63148 aluminum H-taps
- Output Force: 14 tons
- Operating Pressure: 10,000 psi nominal
- Dimensions (L x W x H): 11 1/2" x 2 1/2" x 4 1/4"
- Weight without Dies: 10 lbs.

CAT. NO.	DESCRIPTION	PKG. QTY.
13100A	14-ton hydraulic head with steel case	1

Battpac® TBM15BSCR Hermetically Sealed 15-Ton Battery-Powered Compression Tool

- Weather-resistant, non-ventilated body for use in the most corrosive environments
- High grade forged steel head rotates 180°
- Rapid jaw-advance feature allows the operator quicker compression cycles
- 75kv live line rated
- 20-minute rapid battery charger



Creates hex-style crimp



TBM15BSCR

Specifications

- Installing Range: 54755 to 54790 C-taps
- Up to 1500 mcm copper lugs & splices
- Up to 1000 mcm aluminum lugs & splices
- CHT814-10 to CHT750-350-1F copper H-taps
- 63105 to 63180 aluminum H-taps
- Output Force: 15 tons
- Dimensions (L x W x H): 21" x 3 1/2" x 11"
- Battery: 14.4V 3.0Ah Ni-Cd
- Weight with Battery: 23.75 lbs.

CAT. NO.	DESCRIPTION	PKG. QTY.
TBM15BSCR	Battpac® 15-Ton Battery-Powered Compression Tool. Hermetically sealed unit. Includes carrying case, charger, two batteries, carry strap	1

Power-Assisted Compression Tools: #8 to 1500 or 2000 MCM

Battpac® LT BPLT15BSCR 15-Ton Battery-Powered Compression Tool

- Rotating head allows maximum flexibility for crimping
- Double-speed feature decreases crimp time by doubling jaw speed until it reaches load
- Includes two Makita 14.4V Ni-MH batteries (3.0 AMP Hrs.)
- Built-in LED battery power indicator
- On-tool DC power jack



Creates hex-style crimp



BPLT15BSCR

Specifications

- Installing Range:
 - Up to 1500 mcm copper lugs & splices
 - Up to 1000 mcm aluminum lugs & splices
 - CHT814-10 to CHT750-350-1F copper H-taps
 - 63105 to 63180 aluminum H-taps
 - 54755 to 54790 C-taps
- Output Force: 15 tons
- Dimensions (L x W x H): 21" x 3½" x 11"
- Battery: 14.4V 3.0Ah Ni-MH
- Weight with Battery: 23.75 lbs.

CAT. NO.	DESCRIPTION	PKG. QTY.
BPLT15BSCR	Battpac® LT 15-Ton Compression Tool. Includes carrying case, charger, two batteries, and carry strap	1

TBM15I 15-Ton Hydraulic Crimping Head



Creates hex-style crimp

- Head made of forged steel and insulated with rubber boot
- Longer, slimmer design enables easier access into tight spaces, such as in cable tray and central office applications
- Wider jaw opening eases crimping of larger lugs, C-taps and H-taps
- Uses 15600 Series dies; can also use 15500 Series dies with 15500-TB adapter

Specifications

- Installing Range:
 - Up to 1500 mcm copper lugs & splices
 - Up to 1000 mcm aluminum lugs & splices
 - CHT814-10 to CHT750-350-1F copper H-taps
 - 63105 to 36180 aluminum H-taps
 - 54755 to 54790 C-taps
- Output Force: 15 tons
- Operating Pressure: 10,000 psi nominal
- Dimensions (L x W x H): 15½" x 2½" x 4¾"
- Weight without Dies: 16.5 lbs.

CAT. NO.	DESCRIPTION	PKG. QTY.
TBM15I	Insulated 15-Ton Hydraulic Head with Steel Case	1

15600 Series — Fits directly into tool for larger size connectors, 800 kcmil–1,500 kcmil
 15500 Series — Used in conjunction with 15500-TB Adapter, #8 AWG–750 kcmil

21940 40-Ton Hydraulic Crimping Head

- Compact design delivers maximum pressure for larger lugs and splices
- Ideal for applications requiring larger lugs up to 2000 mcm
- Uses 11300 and 11400 Series dies

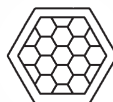

Creates hex-style crimp

Specifications

- Installing Range:
 - Up to 2000 mcm copper lugs & splices
 - Up to 2000 mcm aluminum lugs & splices
- Output Force: 40 tons
- Operating Pressure: 10,000 psi nominal
- Dimensions (L x W x H): 12" x 4¾" x 7¾"
- Weight without Dies: 40 lbs.

CAT. NO.	DESCRIPTION	PKG. QTY.
21940	40-Ton Hydraulic Head with Steel Case	1

Hydraulic Pumps

13606 Foot-/Hand-Operated and 13604 Hand-Operated Hydraulic Pump

- 13606 operates with either foot or hand; 13604 is hand operated only
- Operates all T&B hydraulic heads
- Built-in safety bypass valve
- Factory set at 9,800 psi

Specifications

- Nominal Pressure: 9,800 psi
- Pumping Capacity: 2.6 cu. in./min. @ 200 psi
0.16 cu. in./min. @ 10,000 psi
- Reservoir Volume: 125 cu.in. (0.54 gal.)
- Max. Handle Force: 130 lbs.
- Dimensions (L x W x H): 23" x 5¾" x 6¾"
- Weight: 29 lbs.



13606 Foot-/Hand-Operated Hydraulic Pump

CAT. NO.	DESCRIPTION	PKG. QTY.
13606	Combination Hand or Foot-Operated Hydraulic Pump	1
13604	Hand-Operated Hydraulic Pump	1

Battpac® LT BPLT13970P2 Pump

- Small and lightweight
- 60 minutes full recharge
- Highly visible display indicates battery power level
- Socket for 24 VDC external connection
- Operation in any position: on its side or upright
- Separate operation/release buttons protect against accidental operation
- Energy consumption limited by automatic shut-off
- Easily accessible oil top-up inlet



Specifications

- Nominal Pressure: 10,000 psi
- Pumping Capacity: 30 cu.in./min.
- Reservoir Volume: 60 cu.in. (26 gal.)
- Dimensions (L x W x H): 13½" x 6½" x 12¾"
- Battery: Ni-MH 24V, 3 Ah
- Weight with Battery: 20.9 lbs.

Battery Performance Guide

In tests, the number of crimps obtained from a fully charged battery, using a remote crimping head, was:

- 102 crimps for Cu connectors on 250 kcmil HD Cu conductor
- 98 crimps for C-Tap connectors on #2 AWG HD Cu conductor
- 76 crimps for Cu sleeve connectors on 500 kcmil HD Cu conductor

CAT. NO.	DESCRIPTION	PKG. QTY.
BPLT13970P2	Battpac® LT Pump includes canvas accessories carrying bag, carrying strap, remote hand controller, two batteries, battery charger and non-drip couplings	1
BPLT13970RB	Ni-MH 24V Replacement battery	1
BPLT13970RP	Canvas backpack for pump	1
BPLT13970DC	Power connecting cable with clips	1
BPLT13970FS	Remote foot pedal controller	1

Hydraulic Pumps

13600 Electric Hydraulic Pump

- Designed for use with single-acting cylinders and tools rated for 10,000 psi operation
- Supplied with metal carrying case
- 13620 hand switch and 13619 hydraulic hose, both sold separately, required for operation

Specifications

- Motor: ½ hp, 115V 50–60 Hz 10 amps
- Pumping Capacity: 170 cu. in./min. at 100 psi
32 cu. in./min. at 1,000 psi
25 cu. in./min. at 5,000 psi
18 cu. in./min. at 10,000 psi
- Reservoir Volume: 104 cu. in. (.45 gal.)
- Basic Pump Dimension: 6" x 8" x 16"
- Weight: 25 lbs.

CAT. NO.	DESCRIPTION	PKG. QTY.
13600	Electric Hydraulic Pump — hand or foot switch and non-metallic hose (sold separately) required for operation	1

You may also need...

13620	Hand Switch — 10 ft.	1
13589A	Foot Switch — 10 ft.	1
13619	10 ft. Non-Metallic Hose	1
13618	20 ft. Non-Metallic Hose	1
13600S	"Sled" type stand for 13600 pump	1



13610A Electric Hydraulic Pump with Shure-Stake® Control

- Shure-Stake® control mechanism requires 9,800 psi pump pressure before recycling to prevent under-crimping
- Designed for use with single-acting cylinders and tools rated for 10,000 psi operation
- Supplied with metal carrying case

Specifications

- Motor Rating: ½ hp, 115V, 50–60 Hz, 12.5 amps
- Pumping Capacity: 170 cu. in./min. at 100 psi
32 cu. in./min. at 1,000 psi
25 cu. in./min. at 5,000 psi
18 cu. in./min. at 10,000 psi
- Reservoir Volume: 104 cu. in. (.45 gal.)
- Basic Pump Dimension: 8½" x 10½" x 16"
- Weight: 35 lbs.

CAT. NO.	DESCRIPTION	PKG. QTY.
13610A	Electric Hydraulic Pump with Shure-Stake® control — hand or foot switch and non-metallic hose (sold separately) required for operation	1

You may also need...

13611	Hand Switch — 10 ft.	1
13612	Foot Switch — 10 ft.	1
13619	10 ft. Non-Metallic Hose	1
13618	20 ft. Non-Metallic Hose	1



Hydraulic Pumps and Battery Connector Tools

13810 Heavy-Duty Electric Hydraulic Pump with Shure-Stake® Control

- Designed for perfect crimps every time in heavy-duty OEM applications
- Heavy-duty OEM two-stage pump with high flow rate
- Shure-Stake® control mechanism requires 9,800 psi pump pressure before recycling to prevent under-crimping
- Requires hand or foot control (sold separately)

Specifications

- Motor Rating: 1½ hp, 115V, 60 Hz, 23 amps
- Pumping Capacity: 235 cu.in./min. at 200 psi
61 cu.in./min. at 8,000 psi
- Reservoir Volume: 462 cu.in./2 gal.
- Dimensions (L x W x H): 10¾" x 15" x 20¾"
- Weight: 60 lbs.



CAT. NO.	DESCRIPTION	PKG. QTY.
13810	Heavy-duty electric hydraulic pump with Shure-Stake® control — hand or foot switch and non-metallic hose (sold separately) required for operation	1

You may also need...

13611	Hand switch — 10 ft.	1
13612	Foot switch — 10 ft.	1
13619	10 ft. Non-Metallic Hose	1
13618	20 ft. Non-Metallic Hose	1

Battery Connector Crimp Tools

- Adjustable die crimping tool for Color-Keyed® cast and tubular battery connectors
- Available with Shure-Stake® mechanism to ensure a complete crimp every time (BCT840S)
- Crimps casting and tubular battery connectors ranging from 4 AWG to 4/0
- Heavy-duty crimping tool including die for 8 AWG-4/0 battery connectors, lugs and splices
- The single die is an integral part of the tool; no dies to lose or misplace
- Available with Shure-Stake® mechanism to ensure a complete crimp every time (TBM5SV)

BCT840, BCT840S



TBM5SV, TBM5V



CAT. NO.	DESCRIPTION	PKG. QTY.
BCT840	Dieless Crimp Tool for cast and tubular battery connectors	1
BCT840S	Dieless Crimp Tool with Shure-Stake® mechanism for cast and tubular battery connectors	1
TBM5V	Ratchet Crimp Tool with die for 8 AWG to 4/0 battery connectors	1
TBM5SV	Ratchet Crimp Tool with Shure-Stake® mechanism and die for 8 AWG to 4/0 battery connectors	1

Miscellaneous Hydraulic Pump Accessories

CAT. NO.	DESCRIPTION	PKG. QTY.
21061	Hydraulic Oil	1
13798	Male Pioneer Quick Disconnect Coupler	1
13799	Female Pioneer Quick Disconnect Coupler	1
13614	Metallic Reinforced Hose for OEM operations — 10 ft.	1

Strippers, Cutters and Other Tools

BCS8-40 Cable Stripper



BCS8-40

CAT. NO.	DESCRIPTION	PKG. QTY.
BCS8-40	Cable stripper for 8 AWG-4/0 battery cable with replacement blade provided in the handle	1

368-CK Cable Stripper



CAT. NO.	DESCRIPTION	PKG. QTY.
368-CK	Cable stripper for #1 to 1,000 kcmil	1

364RF/366RF Cable Cutters with Fiberglass Handles



CAT. NO.	CABLE SIZE	PKG. QTY.
364RF	Cutter for up to 500 kcmil copper and aluminum	1
366RF	Cutter for up to 1,000 kcmil copper and aluminum	1

For copper and aluminum cable only. Not for steel.
Replacement blades are available through Tool Services.

TBM40HC Hand-Operated Hydraulic Cutting Tool

- Specifically designed to cut copper, aluminum and telecommunications cables up to 3.35" O.D.
- Offers dual-speed action: fast advancing speed for rapid approach of blades to cable and slower, more powerful speed for cutting
- Blades manufactured from high-strength, heat-treated steel to ensure long service life
- Head easily opens to enable cutting of existing run cables
- Head rotates 180°, enabling operator to position for easiest use
- Automatic safety valve bypasses oil when reaching maximum pressure
- Pressure release device can also be activated during any point of operation



Specifications

- Max. Cutting Capacity: 3.35" O.D.
- Weight: 14.55 lbs.
- Dimensions (L x W): 25.69" x 6.89"

CAT. NO.	DESCRIPTION	PKG. QTY.
TBM40HC	Hand-operated hydraulic cutting tool	1

Strippers, Cutters and Other Tools

CSR750 Cable Cutter



- Special advance stroke mechanism requires less handle force
- Cuts copper or aluminum cables up to 750 kcmil
- Short handles (only 10" long) enable use in tight spaces

CAT. NO.	DESCRIPTION	PKG. QTY.
CSR750	Cutter for up to 750 kcmil copper or aluminum	1

Battpac® LT BPLT54BSCT Fast-Cycle, Battery-Powered Cutting Tool



..... Specifications

- Max. Cutting Capacity: 2½" O.D. Aluminum; 750 kcmil Copper
- Recommended Cutting Range for Consistent Use: 250 kcmil
- Batteries: 6.0V
- Weight with battery: 4.8 lbs.

CAT. NO.	DESCRIPTION	PKG. QTY.
BPLT54BSCT	Battpac® LT Fast-Cycle Cutting Tool. Includes carrying case, charger, two batteries, carry strap	1

Battpac® TBM54BSCT and TBM54BSCTS Battery-Powered Cutters

- Removable battery — simply change for continuous use
- One-handed control of blade advancement and retraction
- TBM54BSCTS cuts up to 750 kcmil copper, 2½" O.D. aluminum and 636 kcmil ACSR
- TBM54BSCT cuts up to 1,500 kcmil copper and 2½" O.D. aluminum (not for use on ACSR)

Guide to Cutting Cycles

This guide indicates the number of cutting cycles that the TBM54BSCT and TBM54BSCTS can be expected to perform when the battery is fully charged. These figures are approximate and will vary according to the charging and other operating conditions, such as temperature, humidity and battery condition.

CAT. NO.	CONDUCTOR	APPROX. CUTTING CYCLES	
		CRCTBPI & CRCTBP	CRCTPBEI
TBM54BSCTS	750 kcmil Cu	35	105
	636 kcmil ACSR	50	150
TBM54BSCT	1,000 kcmil Cu	45	135
	1,500 kcmil Cu; 2½" Al	30	90

Battery Cartridge: (CRCTBP)

Battery Type: Sealed Nickel Cadmium

Voltage: 14.4V DC

Rated Current: 1.9Ah

Dimensions: 3.5"L x 2.7"W x 5.3"H

Weight: 1.6 lbs.

Battery Charger: (CRCTQC)

Input Voltage: 120V AC Single Phase

Charging Capacity: 20 VA

Charging Time: 15 min. CRCTBP & CRCTBPI
45 min. CRCTPBEI

Dimensions: 7.5"L x 3.7"W x 3.5"H

Weight: 4 lbs.

Optional Accessories:

Battery Pack: CRCTBPEI

Battery Cartridge: CRCTBPI or CRCTBP

DC Charger: CRCTDC



..... Specifications

- Motor: 14.4V DC
- Dimensions (L x W x H): 16" x 4" x 4.5"
- Weight with Battery: 7.2 lbs.

CAT. NO.	DESCRIPTION	PKG. QTY.
TBM54BSCTS	Battery-powered cutter for up to 750 kcmil Cu, 2½" O.D. Al and 636 kcmil ACSR	1
TBM54BSCT	Battery-powered cutter for up to 1,500 kcmil Cu, 2½" O.D. Al (not for use on ACSR)	1

Color-Keyed® Compression

Strippers, Cutters and Other Tools

Battpac® TBM58BSCT Battery-Powered Cutter

- Designed for one-handed operation
- Simply remove pin latch, place over cable, reinsert pin and cut
- Built-in bypass pops off if material is beyond cutter's capacity
- Cuts ACSR, aluminum and copper cables up to 1½", regular guy wires and ground rods up to ¾"

NOTE: Not recommended for use on hardened steel.

Standard Battpac® Kit Includes:

- 1 battery-powered tool
- 1 carrying strap
- 1 carrying case
- 2 CRCTBP batteries
- 1 CRCTQC 15-minute AC charger



Specifications

- Output Pressure: 6 tons
- Max Cutting Capacity: Soft steel bolts: 1⅞" (17mm)
Rebar & ground rod: ¾" (16mm) ACSR : 1½" (40mm)
CU & AL strands: 1½" (40mm) Standard guy wire:
¾" (16mm) Wire rope: ¾" (20mm)
- Dimensions (H x W x D): 17" x 12" x 3"
- Weight with Battery: 14 lbs.

CAT. NO.	DESCRIPTION	PKG. QTY.
TBM58BSCT	Battery-Powered Cutter	1

297-32136 Hydraulic Cutting Head

- Heavy-duty cutter with high strength steel blades
- Cuts both aluminum and copper wire to 1½" O.D.
- Cutter supplied with carrying case



Specifications

- Max. Cutting Capacity (aluminum and copper): 1½" O.D.
- Dimensions (L x W x H): 14½ x 2½ x 4"
- Weight: 8.5 lbs.

CAT. NO.	DESCRIPTION	PKG. QTY.
297-32136	Hydraulic Cutting Head	1

Battpac® LT BPLT58BSCT Battery-Powered Cutter

- Cuts copper, aluminum and ACSR up to 1½" O.D.
- Also cuts soft steel bolts, rebar and wire rope
- Forged steel head and cutting blades for strength and durability
- Dual forward speeds enhance productivity
- New, more powerful Ni-MH battery has 50% more energy and less memory effect than old batteries



Specifications

- Max. Cutting Capacity: Copper, aluminum & ACSR cable to 1½" O.D.
Rebar, ground rod & standard guy wire to ¾"
Soft steel bolts to 1⅞"
Wire rope to ¾"
- Dimensions (L x W x H): 19½" x 3⅞" x 9⅞"
- Battery: Ni-MH 14.4V 3.0Ah
- Weight with Battery: 16.7 lbs.

CAT. NO.	DESCRIPTION	PKG. QTY.
BPLT58BSCT	Battery-Powered Cutter with carrying case, charger, two batteries and carry strap.	1

TBM40HCRH Hydraulic Cutting Head

- Heat-treated, high-strength steel blades for clean cuts and long service life
- Quick automatic coupler speeds connection to hydraulic systems
- Comes with carrying case



Specifications

- Max. Cutting Capacity (copper, aluminum and telecommunications cable): Up to 3.35" O.D.*
- Hydraulic Operating Pressure: 10,000 psi (maximum)
- Dimensions (L x W): 15.94" x 5.63"
- Weight: 10.8 lbs.

* Not designed for cutting steel-reinforced conductors

CAT. NO.	DESCRIPTION	PKG. QTY.
TBM40HCRH	Hydraulic Cutting Head	1

Strippers, Cutters and Other Tools

Blackburn® JB12B 12-Ton Manual Hydraulic Crimp Tool

- Self-contained hydraulic crimping tool for copper, aluminum and ASCR connectors
- Two-stage, rapid-ram advance mechanism for fast installation
- 180° head rotation
- Accepts all U-type dies used for Alcoa®, Burndy®, Thomas & Betts® and Blackburn® tools of equivalent tonnage

Specifications

- Installing Range:
 - Up to 750 mcm copper lugs & splices
 - Up to 650 mcm aluminum lugs & splices
 - CHT814-10 to CHT2502-6 copper H-taps
 - 63105 to 63148 aluminum H-taps
 - 54755 to 54770 C-taps
- Output Force: 12 tons
- Dimensions (L x W x H): 22¾" x 2½" x 4¾"
- Weight without Dies: 13 lbs.



Creates Hex-style crimp

CAT. NO.	DESCRIPTION	PKG. QTY.
JB12B	12-Ton Manual Hydraulic Crimp Tool with Carrying Case	1

Blackburn® OD581 Mechanical Compression Tool

- Equipped with fixed ⅝" die in nose
- Also accepts standard insert "O," "D" and 840 dies
- Integral self-gauging system in tool head ensures proper adjustment before each crimp
- Improved lever-action design reduces force required to crimp by as much as 20%
- Fiberglass handles offer light weight, high strength and superior insulating properties
- Distribution of weight over tool length enhances balance for easier handling and positioning



CAT. NO.	DESCRIPTION	PKG. QTY.
OD581	Mechanical Compression Tool with Fixed ⅝" Nose Die, Insert Die Cavity for "O," "D" or 840 Die (sold separately) and 21" Fiberglass Handles	1

Blackburn® TBMODBSCR 6-Ton Battery-Powered Compression Tool

- Versatile battery-powered crimp tool combines the features of an open-yoke tool with the weight and balance of a closed-yoke tool
- Reduces stress for operator when crimping connectors
- Ideal for industrial, commercial, telecom and utility applications
- Accepts T&B® 6-TON and Blackburn® "O" and "D" dies*



Specifications

- Installing Range:
 - Up to 4/0 aluminum H-taps
 - Standard C-taps
- Output Force: 6 tons
- Dimensions (L x W x H): 12" x 3" x 13"
- Battery: Ni-MH 14.4V 3.0 Ah
- Weight with Battery: 8 lbs.

CAT. NO.	DESCRIPTION	PKG. QTY.
TBMODBSCR	Battery-Powered 6-TON Crimping Tool — Includes Shoulder Strap, Charger, Carrying Case, Battery Cartridge and Owners Manuals	1

*T&B® 6-TON and Blackburn® "O" and "D" dies sold separately.

Strippers, Cutters and Other Tools; Seals and Lubricants

Cable Slicing Die Sets

- Cuts copper and aluminum insulated cable sizes from #8 AWG through 500 kcmil
- Produces clean, squared-end cut, which eliminates extra trimming of conductor strands

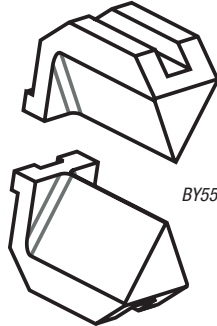

CAT. NO.	MAXIMUM CABLE SIZE	TOOLS	PKG. QTY.
BY55	2/0	TBM6H and TBM6BSCR	1
40C	4/0	TBM14M and 13100A and TBM14BSCR	1
156CS	500 kcmil	TBM15I and TBM15BSCR	1

Type DX Duct Seal

- Seals around junction boxes, flashings, service mast entries, service cable entries and countless other applications
- Easy to use — forms around irregular surfaces and configurations
- Highly resistant to cracking, drying and shrinking
- Cuts and trims easily
- Gray color can be left as is or painted immediately after application
- No unpleasant odor
- +20° F to 212° F workable temperature range
- 40° F to 250° F service temperature range
- Contains no asbestos



CAT. NO.	DESCRIPTION	PKG. QTY.
DX-1	1 lb. Slug	1
DX-5	5 – 1 lb. Slugs	1
DX-5S	5 lb. Slug	1

UL Classified R13335

21649 Cable Bender



CAT. NO.	DESCRIPTION	PKG. QTY.
21649	Bender for cable up to 750 kcmil	1

CTR-1 C-Tap Removal Tool



CAT. NO.	DESCRIPTION	PKG. QTY.
CTR-1	C-Tap Removal Tool	1

Type WW Wire Bristle Brush

- Removes oxides from conductor surfaces
- Easy-grip handle with guard to prevent rubber-glove puncture
- Replaceable long-life brushes can be rotated
- Handle and guard coated with durable, nonconductive plastic for safety



CAT. NO.	DESCRIPTION	PKG. QTY.
WWB1	Complete Brush with Handle	1
WRB1	Wire Element Only, Pair	1

Silicone Lubricant for High Voltage Electrical Work



CAT. NO.	DESCRIPTION	PKG. QTY.
2012	2 grams	250 tubes
2015	5 grams	100 tubes
SL5	5 oz./142 grams	12 tubes

Dies for Standard Lugs & Splices (TBM25S – TBM12)

CONNECTOR SIZE			COLOR-KEYED DIE COLOR	TBM8-750M-1 TBM8-750BSCR			TBM-8/8S	TBM-5/5S	TBM6/6S / 25000		13642M / 13400 HYDRAULIC HEAD		TBM12 HYDRAULIC HEAD	
CODE COPPER	FLEX/24	AL/CU		TBM25S	TBM4S	TBM8-750	TBM8 DIE CAT. NO.	TBM5 DIE CAT. NO.	CAT. NO. UPPER DIE	CAT. NO. LOWER DIE	DIE CAT. NO.	DIE CODE NO.	DIE CAT. NO.	DIE CODE NO.
8 AWG	37/24	10 AWG	RED	C-Taps Only				13475	13477	11732	21	TBM12D-1	21	
6 AWG	61/24	8 AWG	BLUE					13475	13477	11733	24	TBM12D-1	24	
4 AWG	91/24	6 AWG	GRAY					13472	13476	11734	29	TBM12D-2	29	
2 AWG	125/24		BROWN					13474	13477	11735	33	TBM12D-2	33	
1 AWG	150/24	4 AWG	GREEN					13474	13477	11736	37	TBM12D-3	37	
1/0	225/24	2 AWG	PINK					13475	13477	11737	42	TBM12D-3	42	
2/0	275/24		BLACK					13474	13477	11738	45	TBM12D-4	45	
3/0	325/24		ORANGE					13474	13477	11739	50	TBM12D-4	50	
4/0	450/24		PURPLE					13475	13477	11740	54	TBM12D-5	54	
250 kcmil	550/24		YELLOW					13473	13476	11771	62	TBM12D-5	62	
		1 AWG	GOLD			13474	13477	11738	45	TBM12D-4	45			
		1/0	TAN			13474	13477	11739	50	TBM12D-4	50			
		2/0	OLIVE			13475	13477	11740	54	TBM12D-5	54			
		3/0	RUBY			13473	13476	11741	60	TBM12D-5	60			
300 kcmil		4/0	WHITE			13465		13473	13476	11742	66H	TBM12D-5	66H	
350 kcmil	775/24(short)	250 kcmil	RED			13466		13472	13476	11743	71H	TBM12D-4	71H	
400 kcmil	775/24(long)	300 kcmil	BLUE			13467	4/0 only	13472	13476	11744	76H	TBM12D-4	76H	
	925/24*		N/A					13479	13476	11745	80H			
			N/A											
500 kcmil		350 kcmil	BROWN			13468		13478	13478	11746-TB	87H	TBM12D-3	87H	
600 kcmil	1100/24	400 kcmil	GREEN							11747	94H	TBM12D-3	94H	
			GREEN								94H			
	1325/24**		PINK							11748	99H	TBM12D-2	99H	
700 kcmil		500 kcmil	PINK							11749	106H	TBM12D-2	106H	
750 kcmil		650 kcmil	BLACK							11750	107H			
800 kcmil			ORANGE							11751	112H	TBM12D-1	112H	
		700 kcmil	PURPLE							11753	115H	TBM12D-1	115H	
900 kcmil	1925/25	750 kcmil	YELLOW											
1000 kcmil		800 kcmil												
		1000 kcmil												

* Standard barrel only. Long barrel requires Brown 87H.

** Standard barrel only. Long barrel requires Black 106H.

Dies for Standard Lugs & Splices (OD58)

CONNECTOR SIZE			COLOR-KEYED DIE COLOR	OD58	
CODE COPPER	FLEX/24	AL/CU		DIE CAT. NO.	DIE CODE NO.
8 AWG	37/24	10 AWG	RED	BY15C	21
6 AWG	61/24	8 AWG	BLUE	BY17C	24
4 AWG	91/24	6 AWG	GRAY	BY19C	29
2 AWG	125/24		BROWN	BY21C	33
1 AWG	150/24	4 AWG	GREEN	BY53C	37
1/0	225/24	2 AWG	PINK	BY23C	42
2/0	275/24		BLACK	BY28C	45
3/0	325/24		ORANGE	BY25C	50
4/0	450/24		PURPLE	BY27C	54
250 kcmil	550/24		YELLOW	BY31C	62
		1 AWG	GOLD	BY24C	45
		1/0	TAN	BY25C	50
		2/0	OLIVE	BY31C	54
		3/0	RUBY	BY32C	60

Color-Keyed Compression

Installing Dies

Dies for Standard Lugs & Splices (TBM6H – 21940)

Color-Keyed Compression

CONNECTOR SIZE			COLOR-KEYED DIE COLOR	BPLT6BSCR / TBM6H		BPLT62BSCR		BPLT14BSCR / TBM14M / TBM14MC / 13100A* / JB12B		BPLT15BSCR / TBM15I***		21940 (40 TON)	
CODE COPPER	FLEX/24	AL/CU		DIE CAT. NO.	DIE CODE NO.	DIE CAT. NO.	DIE CODE NO.	DIE CAT. NO.	DIE CODE NO.	DIE CAT. NO.	DIE CODE NO.	DIE CAT. NO.	DIE CODE NO.
8 AWG	37/24	10 AWG	RED	6TON21	21	TBM6221	21	15520	21	15520	21		
6 AWG	61/24	8 AWG	BLUE	6TON24	24	TBM6224	24	15522	24	15522	24		
4 AWG	91/24	6 AWG	GRAY	6TON29	29	TBM6229	29	15527-CK	29	15527-CK	29	11401	29
2 AWG	125/24		BROWN	6TON33	33	TBM6233	33	15528	33	15528	33	11402	33
1 AWG	140/24	4 AWG	GREEN	6TON37	37	TBM6237	37	15513-CK	37	15513-CK	37	11333	37
1/0	225/24	2 AWG	PINK	6TON42	42	TBM6242	42	15508	42	15508	42H	11334	42
2/0	275/24		BLACK	6TON45	45	TBM6245	45	15526	45	15526	45	11405	45
3/0	325/24		ORANGE	6TON50	50	TBM6250	50	15530	50	15530	50	11406	50
4/0	450/24		PURPLE	6TON54	54	TBM6254	54	15511	54	15511	54H	11407	54H
250 kcmil	550/24		YELLOW	6TON62	62	TBM6262	62	15510-CK	62	15510-CK	62	297-31669-7	62
		1 AWG	GOLD	6TON45	45	TBM6245	45	15526	45	15526	45	11405	45
		1/0	TAN	6TON50	50	TBM6250	50	15530	50	15530	50	11406	50
		2/0	OLIVE	6TON54	54	TBM6254	54	15511	54	15511	54H	11407	54
		3/0	RUBY	6TON60	60	TBM6260	60	15532-CK	60	15532-CK	60	11408	60
300 kcmil		4/0	WHITE	6TON66	66H	TBM6266	66	15534	66H	15534	66H	11409	66
350 kcmil	775/24(short)	250 kcmil	RED	6TON71	71H	TBM6271	71	15514-CK	71H	15514-CK	71H	11363	71
400 kcmil	775/24(long) 925/24*	300 kcmil	BLUE	6TON76	76H	TBM6276	76	15512	76H	15512	76H	11410	76
				6TON80	80H	TBM6280	80	15517	80H	15517	80H		
										15606	80		
500 kcmil		350 kcmil	BROWN	6TON87	87H	TBM6287	87	15506	87H	15506	87H	11423	87
600 kcmil	1100/24	400 kcmil	GREEN	6TON94	94H					15611	94H	11364	94
			GREEN					15536-CK	94H	15536-CK	94H		
			PINK										
700 kcmil	1325/24**	500 kcmil	PINK		99H			15505	99H	15505	99H	11424	99
750 kcmil		650 kcmil	BLACK		106H			15515-CK	106H	15515-CK	106H	74506	106
800 kcmil			ORANGE		107H					15608	107H	11425	107
			PURPLE		112H					15609	112H	11426	112
900 kcmil	1925/24	700 kcmil	YELLOW		115H			15504	115H	15504	115H	11308	115
1000 kcmil		750 kcmil	N/A							15603	125H	11416	125
		800 kcmil	N/A							15602	140H	11418	140
		1000 kcmil	N/A							15601	150H	11419	150

*Standard barrel only. Long barrel requires Brown 87H.

**Standard barrel only. Long barrel requires Black 106H.

***15500 Series dies require 15500-TB adapter. 15500F for full size die to fit TBM15I without adapter.

Dies for Standard C-Taps

CONNECTOR	COLOR CODE	TBM25S DIE NO.	TBM5/5S DIE NO.	TBM6/6S DIE NO.	TBM8/8S DIE NO.	BPLT62BSCR DIE NO.	TBM6H/BPLT6BSCR DIE NO.
54705	RED	Red Nest	13454	13475/13477	13461	TBM6221	6TON21
54710	BLUE	Blue Nest	13454	13475/13477	13461	TBM6224	6TON24
54715	GRAY	Grey Nest	13454	13472/13476	13461	TBM6229	6TON29
54720	BROWN	Brown Nest	13454	13474/13477	13461	TBM6233	6TON33
54725	GREEN	Green Nest	13455	13474/13477	13462	TBM6237	6TON37
54730	PINK	—	13455	13475/13477	13462	TBM6242	6TON42
54735	BLACK	—	13455	13474/13477	13462	TBM6245	6TON45
54740	ORANGE	—	13455	13474/13477	13462	TBM6250	6TON50
54745	PURPLE	—	13456	13475/13477	13463	TBM6254	6TON54
54750	YELLOW	—	13456	13473/13478	13463	TBM6262	6TON62

Installing Dies

Dies for Large C-Taps

CONNECTOR	COLOR CODE	13642M/13400 DIE NO.	TBM12 DIE NO.	13100A/JB12B/TBM14M/ BPLT14BSCR DIE NO.	TBM15/ BPLT15BSCR DIE NO.
54755	BLUE	11744	TBM12D-4	15512	15512
54760	BROWN	11746-TB	TBM12D-3	15506	15506
54765	PINK	11748	TBM12D-2	15505	15505
54770	BLACK	11749	TBM12D-2	15515-CK	15515-CK
54775	YELLOW	11753	TBM12D-1	15504	15504
54780	WHITE	—	—	—	15603
54785	N/A	—	—	—	15603
54790	N/A	—	—	—	15603

Dies for Aluminum H-Taps

CONNECTOR	COLOR CODE	TBM5/5S DIE NO.	TBM6/6S DIE NO.	TBM8/8S DIE NO.	TBM12 DIE NO.	TBM6H/BPLT6BSCR DIE NO.	13100A/JB12B/TBM14M/ BPLT14BSCR DIE NO.	TBM15/ BPLT15BSCR DIE NO.
63105	ORANGE	13455	13474/13477	13462	TBM12D-4	6TON50	15530	15530
63110	GREEN	—	13470	—	TBM12D-H	OJB	15501A	15501A
63118	GREEN	—	13470	—	TBM12D-H	OJB	15501A	15501A
63125	GREEN	—	13470	—	TBM12D-H	OJB	15501A	15501A
63140	BLUE	—	13471	—	TBM12D-H	DBL	15502	15502
63148	BLUE	—	13471	—	TBM12D-H	DBL	15502	15502
63160	RED	—	—	—	—	—	—	15612
63169	BLACK	—	—	—	—	—	—	15620
63170	BLACK	—	—	—	—	—	—	15620
63180	BLACK	—	—	—	—	—	—	15620

Dies for Copper H-Taps

CONNECTOR	COLOR CODE	TBM6H/BPLT6BSCR DIE NO.	13100A/JB12B/TBM14M/ BPLT14BSCR DIE NO.	TBM15/ BPLT15BSCR DIE NO.
CHT814-10	GREEN	6TON37R	15CA37RCH	15CA37RCH
CHT214-9	BROWN	6TON71R	15CA71RCH	15CA71RCH
CHT250214-8	PURPLE	—	15CA80RCH	15CA80RCH
CHT25014-7	PURPLE	—	15CA80RCH	15CA80RCH
CHT2502-6	PURPLE	—	15CA80RCH	15CA80RCH
CHT50010-5	BROWN	—	—	15612CH
CHT50040-4	BROWN	—	—	15612CH
CHT75010-3	YELLOW	—	—	15620CH
CHT750350-2	YELLOW	—	—	15620CH
CHT75040-11	YELLOW	—	—	15620CH
CHT750350-1F	WHITE	—	—	15620CHF

Dies for High-Voltage Connectors

DIE CODE NO.	TBM15I, TBM14M, 13100A	
	ADAPTER TYPE	NON-ADAPTER TYPE
29R	15CA29R	—
33R	15CA33R	—
37R	15CA37R	—
42R	15CA42R	—
45R	15CA45R	—
49R	15CA49R	—
54R	15CA54R	—
60R	15CA60R	—
66R	15CA66R	—
71R	15CA71R	—
76R	15CA76R	—
87R	15CA87R	—
94R	15CA94R [†]	—
106R	15CA106R [†]	—
125R	—	15C125R*

*To be used with TBM15I only.

**Use 15500-TB adapter with TBM15I tool.

†Not UL Listed in TBM14M/13100A tool.

Dies for Figure 6 & Figure 8 Ground Connectors

CONNECTOR	CABLE ELEMENT A	TO CABLE ELEMENT B	TO GROUND ROD ELEMENT B	TO REBAR ELEMENT B	DIE SELECTION	
					ELEMENT A	ELEMENT B
54855L	#6 Sol. - #2 Str.	#6 Sol. - #2 Str.	—	—	15501A	15501A
54865L	#1 Str. - 250 kcmil	#6 Sol. - #2 Str.	½" - ⅝" Rod	⅝" - ½" #3 - #4 Rebar	15G86R	15501A
54875L	#2 Str. - 250 kcmil	#2 Str. - 250 kcmil	½" - ⅝" Rod	⅝" - ½" #3 - #4 Rebar	15G86R	15G86R
54885L	250 kcmil - 500 kcmil	#6 Sol. - #2 Str.	⅝" - ¾" Rod	⅝" - ¾" #3 - #4 Rebar	15G126R	15501A
54895L	250 kcmil - 500 kcmil	#2 Str. - 250 kcmil	⅝" - ¾" Rod	⅝" - ¾" #3 - #4 Rebar	15G126R	15G86R
54900L	250 kcmil - 500 kcmil	#2 Str. - 250 kcmil	⅝" - ¾" Rod	⅝" - ¾" #3 - #4 Rebar	15G121R	15G121R

United States
Tel: 901.252.8000
800.816.7809
Fax: 901.252.1354

Canada
Tel: 450.347.5318
Fax: 450.347.1976

Technical Services
Tel: 888.862.3289

Thomas & Betts

www.tnb.com

Connectors for Copper Conductor

One-Hole Metric Lugs

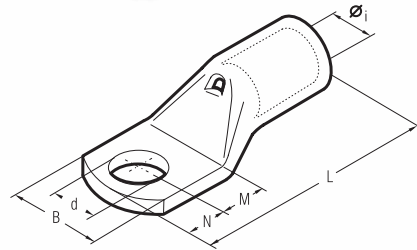

Color-Keyed® metric lugs are manufactured from electrolytic copper tube. The dimensions of the tube are designed to obtain the most efficient electrical conductivity and mechanical strength, resisting vibration and pull out.

Color-Keyed® metric lugs are annealed to guarantee optimum ductility, which is a necessity for compression connectors having to withstand severe deformation arising when compressed or bending of the tongue that may happen during installation.

Connectors have to perform adequately with vibration loads, and annealing is necessary to avoid material failure between the barrel and the tongue.

The presence of an inspection hole facilitates full insertion of the conductor, and the barrel length is designed to allow easy and accurate positioning of the dies during the crimping operation.

Lugs are electrolytically tin-plated to eliminate oxidation of the copper material. Color-Keyed® metric lugs complement our connector family and meet a growing need for customer's connector requirements. Details of the appropriate crimping tools and dies are included. Our Technical Services group is always available to provide any technical advice required. Please contact them if sizes are needed additional to those shown in this catalog.

Color-Keyed® Compression

CAT. NO.	COND. SIZE		Ø STUD MM	DIMENSIONS (MM)					STD. PKG.	6 TON TBM62BSCR (CRIMPS)	14 TON BPLT14BScri (CRIMPS)	26 TON TBM26MCC (CRIMPS)	60 TON TBM60MCC (CRIMPS)
	LOW STRANDED	FLEXIBLE		Ø1	B	M	N	L					
MCC6M4			4	3,6	8,0	5,0	4,0	21,5	4,3	100			
MCC6M5		4÷6	5	3,6	9,0	6,5	6,0	25,0	5,3	100	MCD6-6 (1)	N/A	N/A
MCC6M6			6	3,6	11,0	7,0	6,0	25,5	6,4	100			
MCC10M4			4	4,6	10,0	5,0	4,0	22,5	4,3	100			
MCC10M5*			5	4,6	10,0	6,5	6,0	26,0	5,3	100			
MCC10M6*		10	6	4,6	11,0	7,0	6,0	26,5	6,4	100	MCD10-6 (1)	MCD10-14 (1)	N/A
MCC10M8*			8	4,6	15,0	9,0	8,0	30,5	8,4	100			
MCC10M10*			10	4,6	18,0	11,0	10,0	34,5	10,5	100			
MCC16M4*			4	5,8	11,5	5,0	4,0	25,5	4,3	100			
MCC16M5*			5	5,8	11,5	6,5	6,0	29,0	5,3	100			
MCC16M6*		16	6	5,8	11,5	7,0	6,0	29,5	6,4	100	MCD16-6 (1)	MCD16-14 (1)	N/A
MCC16M8*			8	5,8	15,0	9,0	8,0	33,5	8,4	100			
MCC16M10*			10	5,8	18,0	11,0	10,0	37,5	10,5	100			
MCC25M5*			5	7,0	14,0	6,5	6,0	31,5	5,3	100			
MCC25M6*		25	6	7,0	14,0	7,0	6,0	32,0	6,4	100	MCD25-6 (1)	MCD25-14 (1)	N/A
MCC25M8*			8	7,0	15,0	9,0	8,0	36,0	8,4	100			
MCC25M10*			10	7,0	18,0	11,0	10,0	40,0	10,5	100			
MCC35M5*			5	8,9	17,0	6,5	6,0	34,0	5,3	100			
MCC35M6*		25	6	8,9	17,0	7,0	6,0	34,5	6,4	100			
MCC35M8*	35	35	8	8,9	17,0	9,0	8,0	38,5	8,4	100	MCD35-6 (1)	MCD35-14 (1)	N/A
MCC35M10*			10	8,9	19,0	11,0	10,0	42,5	10,5	100			
MCC35M12*			12	8,9	21,0	14,0	12,0	47,5	13,2	50			
MCC50M8*		35	8	10,0	19,0	9,0	8,0	42,5	8,4	50			
MCC50M10*	50	50	10	10,0	20,0	11,0	10,0	46,5	10,5	50	MCD50-6 (2)	MCD50-14 (1)	N/A
MCC50M12*			12	10,0	21,0	14,0	12,0	51,5	13,2	50			
MCC70M6*			6	11,3	21,0	8,0	7,0	44,0	6,4	50			
MCC70M8*		50	8	11,3	21,0	9,0	8,0	46,0	8,4	50			
MCC70M10*	70	70	10	11,3	21,0	11,0	10,0	50,0	10,5	50	MCD70-6 (2)	MCD70-14 (1)	N/A
MCC70M12*			12	11,3	22,0	14,0	12,0	55,0	13,2	50			
MCC70M16*			16	11,3	26,0	18,0	16,0	63,0	17,0	50			
MCC95M8*		70	8	13,5	25,0	9,0	8,0	52,5	8,4	25			
MCC95M10*	95	95	10	13,5	25,0	11,0	10,0	56,5	10,5	25	MCD95-6 (2)	MCD95-14 (1)	N/A
MCC95M12*			12	13,5	25,0	14,0	12,0	61,5	13,2	25			

Connectors for Copper Conductor

One-Hole Metric Lugs (continued)

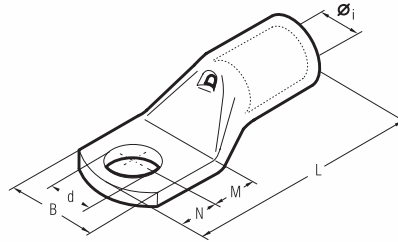

Color-Keyed Compression

CAT. NO.	COND. SIZE		Ø STUD MM	DIMENSIONS (MM)						STD. PKG.	6 TON TBM62BSCR (CRIMPS)	14 TON BPLT14BSERI (CRIMPS)	26 TON TBM26MCC (CRIMPS)	60 TON TBM60MCC (CRIMPS)	
	LOW STRANDED	FLEXIBLE		ØI	B	M	N	L	D						
MCC120M6			8	—	—	—	—	—	6.4	25					
MCC120M8*			8	15,2	28,5	9,0	8,0	54,0	8,4	25					
MCC120M10*	120	95	10	15,2	28,5	11,0	10,0	58,0	10,5	25	MCD120-6 (2)	MCD120-14 (1)	N/A		
MCC120M12*		120	12	15,2	28,5	14,0	12,0	63,0	13,2	25					
MCC120M16*			16	15,2	28,5	18,0	16,0	71,0	17,0	25					
MCC150M12*	150	120	12	16,7	31,5	16,0	14,0	75,0	13,2	25	MCD150-6 (3)	MCD150-14 (1)	N/A		
MCC150M16*		150	16	16,7	31,5	19,0	17,0	81,0	17,0	25					
MCC185M10*	185	150	10	19,2	35,5	13,0	11,0	76,0	10,5	25	MCD185-6 (3)	MCD185-14 (1)	N/A		
MCC185M12*		185	12	19,2	35,5	16,0	14,0	82,0	13,2	25					
MCC185M16*		185	16	19,2	35,5	19,0	17,0	88,0	17,0	15					
MCC240M10*	240	185	10	21,1	39,0	13,0	11,0	82,0	10,5	15	MCD240-6 (3)	MCD240-14 (2)	N/A		
MCC240M12*		240	12	21,1	39,0	16,0	14,0	88,0	13,2	15					
MCC240M16*		240	16	21,1	39,0	19,0	17,0	94,0	17,0	15					
MCC300M10*	300	240	10	23,7	44,0	20,0	11,0	96,0	10,5	10	N/A	MCD300-14 (3)	N/A		
MCC300M12*		300	12	23,7	44,0	20,0	14,0	99,0	13,2	10					
MCC300M16*		300	16	23,7	44,0	22,0	19,0	10,0	17,0	10					
MCC400M10	400	300	12	27,0	51,0	22,0	19,0	113,0	13,2	5	N/A	MCD400-14 (3)	MCD400-26 (2)	MCD400-60 (2)	
MCC400M12			12	27,0	51,0	22,0	19,0	113,0	13,2	5					
MCC400M16			16	27,0	51,0	22,0	19,0	113,0	17,0	5					
MCC500M10	500	400							13,2	5	N/A	N/A	MCD500-26 (2)	MCD500-60 (2)	
MCC500M12			16							17,0					5
MCC500M16			16	30,3	56,5	22,0	19,0	117,0	17,0	5					
MCC630M16	630	500	16	33,4	61,6	22,0	19,0	128,0	17,0	6	N/A	N/A	MCD630-26 (2)	MCD630-60 (2)	
MCC630M20			20	33,4	61,6	24,0	23,0	134,0	21,0	6					
MCC800M16	800	630	16	38,0	72,0	24,0	19,0	141,0	17,0	3	N/A	N/A	N/A	MCD800-60 (2)	
MCC800M20			20	38,0	72,0	24,0	23,0	145,0	21,0	3					
MCC1000M16	1000	800	16	44,0	80,0	24,0	19,0	158,0	17,0	2	N/A	N/A	N/A	MCD1000-60 (2)	
MCC1000M20			20	44,0	80,0	24,0	23,0	162,0	21,0	2					

*UL Listed

Connectors for Copper Conductor

Narrow Tongue Metric Lugs



Color-Keyed® narrow tongue metric lugs feature a contained tongue width. Our lugs have been specifically developed for applications with L.V. circuit breakers with reduced space requirements. The tongue width allows a quicker and easier installation. Color-Keyed® narrow tongue metric lugs are manufactured from electrolytic copper tube. The specific design of the barrel and dimensions create the best combination of mechanical strength and electrical conductivity. Color-Keyed® narrow tongue metric lugs are annealed to guarantee optimum ductility and are electrolytically tinplated to avoid oxidation. The barrel is provided with an internal chamfer for easy insertion of the conductor. The length allows easy positioning of the dies for proper crimping.

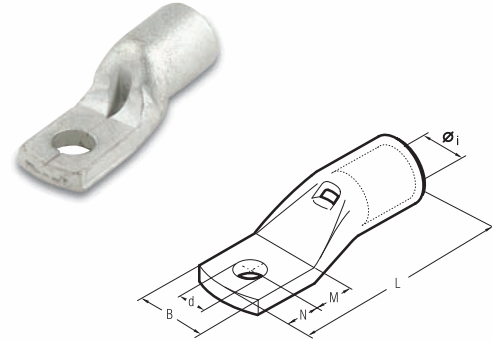

Color-Keyed® Compression

CAT. NO.	COND.SIZE FLEXIBLE SQMM	Ø STUD MM	DIMENSIONS (MM)						STD. PKG.	6 TON TBM62BSCR (CRIMPS)	14 TON BPLT14BSCRI (CRIMPS)
			Ø1	B	M	N	L	D			
MCCNT10M5	10	5	4,6	9,0	6,5	6,0	26,0	5,3	100	MCD10-6 (1)	MCD10-14 (1)
MCCNT16M5	16	5	5,8	9,0	6,5	6,0	29,0	5,3	100	MCD16-6 (1)	MCD16-14 (1)
MCCNT25M5	25	5	7,0	9,0	6,5	6,0	31,5	5,3	100	MCD25-6 (1)	MCD25-14 (1)
MCCNT35M6	35	6	8,9	11,5	8,0	7,0	36,5	6,4	100	MCD36-6 (1)	MCD35-14 (1)
MCCNT50M6	50	6	10,0	11,5	8,0	7,0	40,5	6,4	50	MCD50-6 (2)	MCD50-14 (1)
MCCNT70M6	70	6	11,3	11,5	8,0	7,0	44,0	6,4	50	MCD70-6 (2)	MCD70-14 (1)
MCCNT95M8	95	8	13,5	15,5	9,0	8,0	52,5	8,	25	MCD95-6 (2)	MCD95-14 (1)
MCCNT120M8	120	8	15,2	19,0	14,0	9,0	60,0	8,4	25	MCD120-6 (2)	MCD120-14 (1)
MCCNT120M10		10	15,2	19,0	14,0	9,0	60,0	10,5	25	MCD120-6 (2)	MCD120-14 (1)
MCCNT150M8	150	8	16,7	19,0	18,0	9,0	70,0	8,4	25	MCD150-6 (3)	MCD150-14 (1)
MCCNT150M10		10	16,7	19,0	18,0	9,0	70,0	10,5	25	MCD150-6 (3)	MCD150-14 (1)
MCCNT185M10	185	10	19,2	24,5	18,0	9,0	77,0	10,5	25	MCD185-6 (3)	MCD185-14 (1)
MCCNT240M10	240	10	21,1	31,0	13,0	9,0	80,0	10,5	15	MCD240-6 (3)	MCD240-14 (2)
MCCNT240M12		12	21,1	31,0	16,0	12,0	86,0	13,2	15	MCD240-6 (3)	MCD240-14 (2)
MCCNT240M16		16	21,1	31,0	19,0	17,0	94,0	17,0	15	MCD240-6 (3)	MCD240-14 (2)
MCCNT300M12	300	12	23,7	31,0	16,0	12,0	95,0	13,2	10	NA	MCD300-14 (3)

Connectors for Copper Conductor

Two-Way Metric Splice Connectors

Color-Keyed® metric splice connectors are designed for joining low voltage conductors.

Made of electrolytic copper tube having similar dimensions to the Color-Keyed® metric lugs, these connectors are also annealed and electrolytically tin plated.

They feature an internal chamfer at both ends. For easy insertion of the conductor, a center stop is provided to ensure correct positioning.

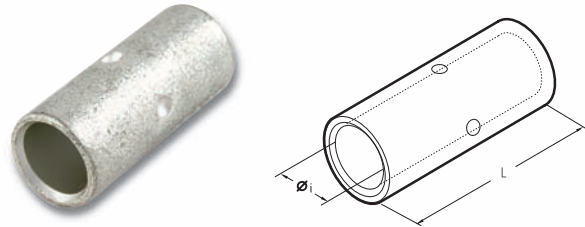

Color-Keyed® Compression

CAT. NO.	COND. SIZE		DIMENSIONS (MM)		STD. PKG.	6 TON TBM62BSCR (CRIMPS)	14 TON BPLT14BSCRI (CRIMPS)	26 TON TBM26MCC (CRIMPS)	60 TON TBM60MCC (CRIMPS)
	LOW STRANDED	FLEXIBLE	Ø1	L					
MCST1	0.25÷1.5	0.25÷1.5	1,8	15	100	N/A	N/A	N/A	N/A
MCST2	1.5÷2.5	1.5÷2.5	2,4	15	100	N/A	N/A	N/A	N/A
MCST6	4÷6	4÷6	3,6	22	100	MCD6-6 (1 + 1)	N/A	N/A	N/A
MCST10	10	10	4,6	25	100	MCD10-6 (1 + 1)	MCD10-14 (1 + 1)	N/A	N/A
MCST16	16	16	5,8	27	100	MCD16-6 (1 + 1)	MCD16-14 (1 + 1)	N/A	N/A
MCST25	25	25	7,0	29	100	MCD25-6 (1 + 1)	MCD25-14 (1 + 1)	N/A	N/A
MCST35	35	25÷35	8,9	33	100	MCD35-6 (1 + 1)	MCD35-14 (1 + 1)	N/A	N/A
MCST50	50	35÷50	10,0	37	50	MCD50-6 (2 + 2)	MCD50-14 (1 + 1)	N/A	N/A
MCST70	70	50÷70	11,3	39	50	MCD70-6 (2 + 2)	MCD70-14 (1 + 1)	N/A	N/A
MCST95	95	70÷95	13,5	43	25	MCD95-6 (2 + 2)	MCD95-14 (1 + 1)	N/A	N/A
MCST120	120	95÷120	15,2	47	25	MCD120-6 (2 + 2)	MCD120-14 (1 + 1)	N/A	N/A
MCST150	150	120÷150	16,7	58	25	MCD150-6 (3 + 3)	MCD150-14 (1 + 1)	N/A	N/A
MCST185	185	150÷185	19,2	64	25	MCD185-6 (3 + 3)	MCD185-14 (1 + 1)	N/A	N/A
MCST240	240	185÷240	21,1	75	15	MCD240-6 (3 + 3)	MCD240-14 (2 + 2)	N/A	N/A
MCST300	300	240	23,7	90	10	N/A	MCD300-14 (3 + 3)	N/A	N/A
MCST400	400	300	27,0	94	5	N/A	MCD400-14 (3 + 3)	MCD400-26 (2 + 2)	MCD400-60 (2 + 2)
MCST500	500	400	30,3	98	6	N/A	N/A	MCD500-26 (2 + 2)	MCD500-60 (2 + 2)
MCST630	600÷630	500	33,4	105	6	N/A	N/A	MCD630-26 (2 + 2)	MCD630-60 (2 + 2)
MCST800	800	600	38,0	112	3	N/A	N/A	N/A	MCD800-60 (2 + 2)
MCST1000	1,000	800	44,0	120	3	N/A	N/A	N/A	MCD1000-60 (2 + 2)

Metric Compression Tools

TBM25MCC Crimp Tool

- For non-insulated metric connectors
- High-precision treated steel jaws
- Ergonomically designed molded plastic grips
- Compact, lightweight and easy to use
- Toggle-action leverage reduces operator effort
- Shure-Stake® mechanism ensures a properly completed crimp each time
- Automatic handle opening after crimping operation

Specifications

- Wire Range: .25 – 10 sq. mm
- Weight: 1.15 lbs.
- Dimensions (L x W): 9.21" x 2.87"



CAT. NO.	DESCRIPTION	PKG. QTY.
TBM25MCC	Mechanical Crimp Tool	1

TBM26MCC 26-Ton Hydraulic Crimping Head

- Installs crimp-type electrical connectors on cables up to 1,000 MCM
- Includes male automatic coupler for connection to 10,000 psi hydraulic pump
- Optional adapter available for use with semicircular slotted dies common to most C-shaped heads (12-ton) available on the market
- Sturdy steel carrying case complete with die compartment for holding up to 10 sets of dies available on request

Specifications

- Output Force: 25.8 tons
- Dimensions (L x W): 12.4" x 4.7"
- Operating Pressure: 10,000 psi nominal
- Weight: 11.4 lbs.



CAT. NO.	DESCRIPTION	PKG. QTY.
TBM26MCC	26-Ton Hydraulic Presshead	1

TBM60MCC 60-Ton Hydraulic Crimping Head

- Installs crimp-type electrical connectors on cables up to 2,000 MCM
- Includes male automatic coupler for connection to 10,000 psi hydraulic pump
- Optional adapter available for use with semicircular slotted dies common to most C-shaped heads (12-ton) available on the market
- Sturdy steel carrying case complete with die compartment for holding up to 10 sets of dies available on request

Specifications

- Output Force: 58.4 tons
- Dimensions (L x W): 12" x 7.9"
- Operating Pressure: 10,000 psi nominal
- Weight: 39.6 lbs.



CAT. NO.	DESCRIPTION	PKG. QTY.
TBM60MCC	60-Ton Hydraulic Presshead	1

Tool Services

Count on Thomas & Betts for the Right Tools for the Right Job!

Since the 1930s, Thomas & Betts has been supplying tools, dies and connectors. Today, with more than 75 years experience in tools, dies and connectors, Thomas & Betts still sets the standard for innovation, quality and performance for application tooling. Rely on Thomas & Betts tools for labor-saving features, user comfort and convenience, long service life and extraordinary value.

Application Tooling Support — At Your Service

For more than 40 years, Thomas & Betts' highly trained, experienced and dedicated Tool Services staff has been supporting customers in every aspect of their tooling needs. With 100-plus years of combined experience, T&B application tool specialists are ready to assist you with:

- Tool recommendations based on your application and workload
- Demonstrations
- Rental and leasing programs
- On-site installation
- On-site training
- Technical support
- Calibration and certification (factory or on-site)
- Repair (both warranty and non-warranty)
- Loaners for temporary use during repairs
- Supplying components and technical documentation for customer-performed repairs

Tool Repair

Thomas & Betts Tool Services repairs all Thomas & Betts tools, from simple hand tools to hydraulic pumps and crimping heads. Tool Services performs all warranty repairs and can supply you with a temporary loaner tool when necessary. Tool Services can also perform non-warranty repairs, or, if you wish to repair your own tools, contact Tool Services to obtain any needed components, technical documentation and support.

Tool Rental Program

For short-term installation projects, sometimes it makes more sense to rent than buy power tools. Thomas & Betts Tool Services understands this and has created a Tool Rental Program, geared specifically for contractors and projects, to meet the need. Renting T&B tools is easy. A rental agreement is available on our web site, and you can pay the rental fee by credit card. Call Tool Services at **1-800-284-TOOL (8665)** for more details, including a list of Thomas & Betts tools available for rental.



Color-Keyed® Compression

Tool Leasing Program

For longer term use, many OEMs find that leasing high-end tools may be more financially attractive than purchasing. Call Tool Services at **1-800-284-TOOL (8665)** for more information and a list of Thomas & Betts tools available for lease.

Thomas & Betts Tool Warranty

You can choose Thomas & Betts tools with confidence, because we stand behind them with our warranty. The chart below shows the standard length of warranty for different types of tools. See below for additional warranty details.

1 Year

- Cable Tie Installation Tools
- Printers
- Cable Cutters & Strippers
- Dies

2 Years

- Mechanical Hand Tools with Shure-Stake® Mechanism
- Pneumatic Tools
- Hydraulic Pumps
- Battery-Operated Tools

5 Years

- Mechanical Hand Tools without Shure-Stake® Mechanism
- Hydraulic Tools (self-contained and remote heads)

Call Toll-Free **1-800-284-TOOL (8665)**

For more information about Thomas & Betts Tool Services:

E-Mail us at toolservice@tnb.com

Limited Warranty for Tools

Thomas & Betts sells tools with the understanding that the user will perform all necessary tests to determine the suitability of each tool for the user's intended application. Thomas & Betts warrants that its tools will be free from defects in materials and workmanship for the period of time specified above. Upon prompt notification of any warranted defect, Thomas & Betts will, at its option, repair or replace the defective product or refund the purchase price. Proof of purchase is required. Misuse or unauthorized modification of the product voids all warranties.

Limitations and Exclusions

The warranty above is the sole warranty concerning this product, and is in lieu of all other warranties express or implied, including but not limited to any implied warranty of merchantability or fitness for a particular purpose, which are specifically disclaimed. Liability for breach of the above warranty is limited to cost of repair or replacement of the product, and under no circumstances will Thomas & Betts be liable for any indirect, special, incidental or consequential damages.

Direct all warranty inquiries to: Thomas & Betts Tool Services **1-800-284-TOOL (8665)**.

United States
Tel: 901.252.8000
800.816.7809
Fax: 901.252.1354

Canada
Tel: 450.347.5318
Fax: 450.347.1976

Technical Services
Tel: 888.862.3289

Thomas & Betts

www.tnb.com

Tab Category Searches

Using the Product, Brand and/or Selector Guide tab searches enables you to view T&B's entire product offering so you can best determine those items of interest to you.

Quick Search Box

If you know the T&B item you are searching for or a competitive part number, this quick search box is the best place to begin your search.

- T&B Catalog/UPC Search...use this option when you know the exact T&B catalog number or its 11-digit UPC number.
- Competitor Part Number Search...use this option when you know the exact competitor's catalog number but need to view T&B's equivalent product offering.

NOTE: Users do NOT have to enter dashes, slashes and spaces when entering the part number...simply enter the alphanumeric characters you are searching for.

For the Latest Information, Visit Electrical World at tnb.com

The screenshot shows the Thomas & Betts website interface. At the top, there are navigation tabs for PRODUCTS, BRANDS, SELECTOR GUIDES, and SUPPORT. A banner for 'U.S. ELECTRICAL WORLD' and 'WELCOME' is visible. Below this is a 'CATALOG SEARCH' section with input fields for 'T&B Catalog Number', 'UPC - 11 Digits', 'Competitor Number', and 'Keyword', along with a 'Search' button. To the left of the search box is a 'Subject Index' with various links like 'Application Support', 'Carrier Tracking', etc. To the right is a 'What's New ...' section listing several product updates with bullet points and links. Below that is a 'Details ...' section for a hand tool, featuring an image of the tool and a 'Request CD' button. At the bottom, there are navigation links for HOME, MY PROFILE, TNB.COM, HELP, and POLICY, along with a copyright notice for 2002, 2003, 2004, and 2005.