

Ceiling Fan Boxes and Accessories

Extra Heavy-Duty New-Work Bar Hangers

Ceiling Fan and Light Fixture Bar Hangers

This innovative extruded-aluminum bar hanger was designed for strength. It is UL Listed for up to 70 lbs. for fan support and an industry-leading 200 lbs. for fixture support

- Gold end plates easily identify the hanger as meeting UL and NEC® requirements for fan support
- Screwed-on end plates are consistently strong and avoid unsightly welds
- End plates feature temporary fixing spikes for hands-free installation
- Expandable for joists spaced from 16 to 24 inches



56111CFB-BHL



54151CFB-BHL



4070CFB-BHL



CFB-BHL



CAT. NO.	CAPACITY CU. IN.	DESCRIPTION	MAX. REC. LOAD		NEW/OLD WORK	STD. CTN.
			FAN	FIXTURE		
56111CFB-BHL	6.0	New-work bar hanger with 1/2" pan-type ceiling fan box with 3 x 1/2" KOs and non-metallic sheathed cable connector	70 lbs.	200 lbs.	New	10
54151CFB-BHL	15.8	New-work bar hanger with 1 1/2" deep ceiling fan box with 3 x 1/2" KOs and clamps for non-metallic sheathed cable	70 lbs.	200 lbs.	New	10
4070CFB-BHL	21.5	New-work bar hanger with non-metallic ceiling fan box with clamps for non-metallic sheathed cable	35 lbs.	50 lbs.	New	10
CFB-BHL	*	New-work bar hanger without outlet box. Mounting bracket for outlet box included	—	*	New	10

* Dependent on box used.

NEC and National Electrical Code are registered trademarks of the National Fire Protection Association, Inc.

Square Boxes and Accessories

Easy to identify and install!

Fire Alarm Boxes and Fittings

Steel City® Fire Alarm Boxes and Fittings can meet all of your visual identification requirements for fire alarm systems — and make installation and upgrades faster and easier than ever before! Available in a variety of sizes to accommodate new or old work configurations, these boxes are simple to install with high-quality Thomas & Betts fittings. Plus, the bright red finish eliminates time-consuming painting of existing fixtures and provides long-lasting identification in even the harshest environments.



52171-1234RD



72171-1234RD



52171-EXTRD



52-C-1RD



52151-1234RD



52171-CV-1234RD



52171-EXTOWRD



53171-1234RD

Fire Alarm Boxes



CAT. NO.	DESCRIPTION	EARS	BRACKETS	EACH SIDE CONDUIT	EACH END CONDUIT	BOTTOM CONDUIT	CU. IN. CAPACITY	STD. CTN.
52171-1234RD	2½"-deep 4"-square red box	—	—	2½", 1½" & ¾"E	2½", 1½" & ¾"E	3½", 2½" & ¾"E	30.3	50
52151-1234RD	1½"-deep 4"-square drawn red box	—	—	2½", 1¼"	2½", 1¼"	3½", 2¾"	21.0	50
72171-1234RD	2½"-deep 4⅞" red box	—	—	3½" & ¾"E	3½" & ¾"E	3½", 2½" & ¾"E	42.0	20
52171-CV-1234RD	2½"-deep 4"-square red box with CV bracket	—	CV	2½", 1½" & ¾"E	2½", 1½" & ¾"E	3½", 2½" & ¾"E	30.3	50
52171-EXTRD	2½"-deep 4"-square red box with ext. ring	—	—	4½", 2½" & ¾"E	4½", 2½" & ¾"E	3½", 2½" & ¾"E	60.6	25
52171-EXTOWRD	2½"-deep 4"-square red box with ext. ring and old work ears	Yes	—	4½", 2½" & ¾"E	4½", 2½" & ¾"E	3½", 2½" & ¾"E	60.6	25
52 C 1RD	Flat 4"-square red cover	—	—	—	—	—	—	100
53171-1234RD	2½"-deep 4"-square red extension ring	—	—	2½", 1½" & ¾"E	2½", 1½" & ¾"E	—	30.3	25
521911234RD	3½"-deep 4"-square red box	—	—	4 x ½" & ¾" Combo	2 x ½" & ¾" Combo	4 x ½" & ¾" Combo	46	24
521911234CVRD	3½"-deep 4"-square red box w/side mounting bracket	—	CV	4 x ½" & ¾" Combo	2 x ½" & ¾" Combo	4 x ½" & ¾" Combo	46	10

Fire Alarm Fittings



CAT. NO.	DESCRIPTION	STD. CTN.
TC121A-FA	½" Red Steel EMT Set Screw Connector	50
TC122A-FA	¾" Red Steel EMT Set Screw Connector	50
TC123A-FA	1" Red Steel EMT Set Screw Connector	25
TC721A-FA	½" Red Insulated Steel EMT Set Screw Connector	50
TC722A-FA	¾" Red Insulated Steel EMT Set Screw Connector	50
TC723A-FA	1" Red Insulated Steel EMT Set Screw Connector	25
TK121A-FA	½" Red Steel EMT Set Screw Coupling	50
TK122A-FA	¾" Red Steel EMT Set Screw Coupling	50
TK123A-FA	1" Red Steel EMT Set Screw Coupling	25



TK122A-FA



TK121A-FA



TC122A-FA



TC121A-FA

Square Boxes and Accessories

4" Square Old-Work Box with Swing Ears

CAT. NO.	DESCRIPTION	STD. CTN.
52171-OW	Metallic 4"-Sq. x 2½"D Old-Work Box with factory-mounted swing ears	25
OW SWING EAR	Swing Ears only (for field installation) with self-threading screws	50 (25 pair)



52171-OW



OW Swing Ears

4" Square Boxes

CAT. NO.	DEPTH (IN.)	CU. IN. CAPACITY	CLAMPS	BRKTS.	KNOCKOUTS (IN.)			STD. CTN.
					EA. SIDE CONDUIT	EA. END CONDUIT	BOTTOM CONDUIT	
With Non-Metallic Sheathed Cable Clamps								
52151 N	1½	21.0	C-5	—	2-½, 1-½, ¾E	2	1-½	50
52151 MS N*	1½	21.0	C-5	MS	2-½, 1-½, ¾E	2	1-½	25
52151 BN*	1½	21.0	C-5	B	2-½, 1-½, ¾E	2	1-½	25
52151 VN*	1½	21.0	C-5	SV	2-½, 1-½, ¾E	2	1-½	25
52151 CVN*	1½	21.0	C-5	CV	2-½, 1-½, ¾E	2	1-½	25
52151CVNP*	1½	21.0	C-5	CV	2-½, 1-½, ¾E	2	1-½	25
52171 N	2½	30.3	C-5	—	2-½, 1-½, ¾E	2	1-½	25
52171-VN*	2½	30.3	C-5	SV	2-½, 1-½, ¾E	2	1-½	25
With Conduit KOs								
52141-1/2	1¼	18.0	—	—	2-½, 1-¼, ¾E	3-½, 1-¼, ¾E	5-½	50
52151 1/2	1½	21.0	—	—	2-½, 1-¼, ¾E	2-¾, 1-¼, ¾E	3-½, 2-¾	50
52151-3/4	1½	21.0	—	—	2-½, 1-¼, ¾E	2-¾, 1-¼, ¾E	3-½, 2-¾	50
52151 1/2 3/4	1½	21.0	—	—	2-½, 1-¼, ¾E	2-½, 1-¼, ¾E	3-½, 2-¾	50
521511234P	1½	21.0	—	—	2-½, 1-¼, ¾E	2-½, 1-¼, ¾E	3-½, 2-¾	50
52151-3/4-W	1½	21.0	—	—	2-½, 1-¼, ¾E	2-¾, 1-¼, ¾E	3-½, 2-¾	50
52151B1234*	1½	21.0	—	B	2-½, 1-½, ¾E	2-½, 1-¼, ¾E	3-½, 2-½	25
52151-1/2 & 3/4-EW	1½	21.0	—	—	2-½, 1-½, ¾E	2-½, 1-¼, ¾E	3-½, 2-½	50
521511234EWGB (Ground bump)	1½	21.0	—	—	2-½, 1-½, ¾E	2-½, 1-¼, ¾E	2-½, 2-½	50
521511234EWGBP (Ground bump with 10½" ground wire)	1½	21.0	—	—	2-½, 1-½, ¾E	2-½, 1-¼, ¾E	2-½, 2-½	50

* All Bracketed boxes come complete with eccentric knockouts.
Per UL 514A, suitable for use without a bonding jumper in circuits above or below 250 volts. Pigtail wire is #12 AWG insulated, 10½" long.

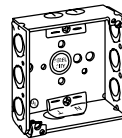

52151 N

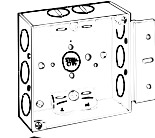

52151 MS N*
MS bracket for
1½", 2½", 3½", 4"

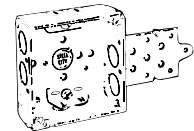

52151 BN*
B bracket
mounted flush

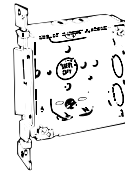

52151 VN*
SV bracket
mounted flush

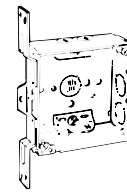

52151 CVN*
CV bracket
mounted flush

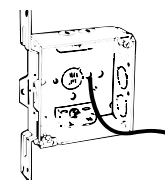

52151 CVNP



52171 N

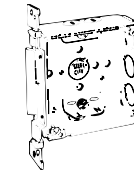

52171-VN*
SV bracket
mounted flush



52141-1/2



52151 1/2



52151-3/4



52151 1/2 3/4

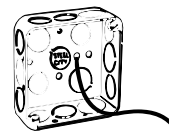

521511234P

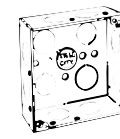

52151-3/4-W

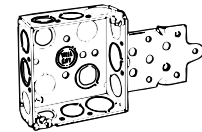

52151B1234
B Bracket mounted flush



52151-1/2 & 3/4-EW

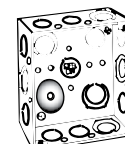

521511234EWGB

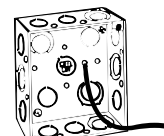

521511234EWGBP

Square Boxes and Accessories

4" Square Boxes (continued)

CAT. NO.	DEPTH (IN.)	CU. IN. CAPACITY	CLAMPS	BRKTS.	KNOCKOUTS (IN.)			STD. CTN.
					EA. SIDE CONDUIT	EA. END CONDUIT	BOTTOM CONDUIT	
<i>With Conduit KOs (continued)</i>								
521511234EWP*	1½	21.0	—	—	2-½, ¼E	2-½, ¼E	3-½, ¼E	50
52151 MS 1/2 & 3/4*	1½	21.0	—	MS	2-½, ¼E	2-½, ¼E	3-½, ¼E	25
52151-V-1/2 & 3/4*	1½	21.0	—	SV	2-½, ¼E	2-½, ¼E	3-½, ¼E	25
52151 CV 3/4*	1½	21.0	—	CV	2-½, ¼E	2-¾	3-½	25
52151 CV 1/2 3/4*	1½	21.0	—	CV	2-½, ¼E	2-¾	3-½	25
52151DV12*	1½	21.0	—	DV	2-½, ¼E	3-½, ¼E	3-½, ¼E	25
521711234E	2½	30.3	—	—	2-½, ¼E	2-½, ¼E	3-½, ¼E	50
521711234EP (With 10½" ground wire)	2½	30.3	—	—	2-½, ¼E	2-½, ¼E	2-½, ¼E	50
52171 MS 1/2 3/4*	2½	30.3	—	MS	2-½, ¼E	2-½, ¼E	3-½, ¼E	25
52171MSP* (With 10½" ground wire)	2½	30.3	—	MS	2-½, ¼E	2-½, ¼E	3-½, ¼E	25
52171 3/4	2½	30.03	—	—	2-¾	2-¾	3-½, 2-¾	50
52171 1	2½	30.03	—	—	2-1	2-1	3-½, 2-¾	50
52171 V 1/2 & 3/4*	2½	30.03	—	SV	2-½, ¼E	2-½, ¼E	3-½, ¼E	25
52171-CV-1/2 & 3/4*	2½	30.03	—	CV	2-½, ¼E	2-½, ¼E	3-½, ¼E	25
52171-EW-SSX*	2½	30.03	—	SSX	—	—	—	—
521711234EP*	2½	30.03	—	v	2-½, ¼E	2-½, ¼E	3-½, ¼E	25
52171-B-1/2 & 3/4	2½	30.03	—	—	2-½, ¼E	2-½, ¼E	3-½, ¼E	25

* All bracketed boxes come complete with eccentric knockouts.
Per UL514A, suitable for use without a bonding jumper in circuits above or below 250 volts. Pigtail wire is #12 AWG insulated, 10½" long.



521511234EWP

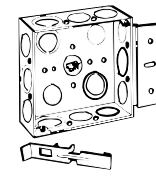

52151 MS 1/2 & 3/4
For use on 1½", 2½", 3½", 4" studs

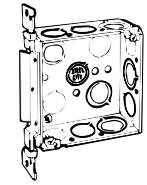

52151-V-1/2 & 3/4
SV Bracket mounted flush

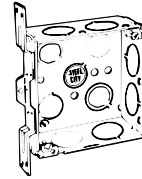

52151 CV 3/4
CV Bracket mounted flush



52151 CV 1/2 3/4
CV Bracket mounted flush

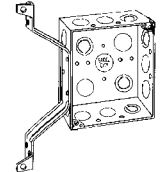

52151DV1/2
DV Bracket provides offset



521711234E



521711234EP



52171 MS 1/2 3/4*
MS bracket for 1½", 2½", 3½", 4", 6" metal studs

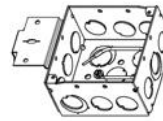

52171MSP

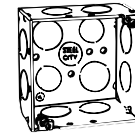

52171 3/4



52171 1



52171 V 1/2 & 3/4
SV bracket mounted flush



52171-CV-1/2 & 3/4
CV bracket mounted flush

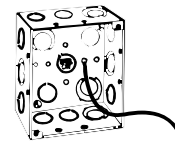

521711234EP

CAT. NO.	DESCRIPTION	EARS	BRACKETS	EACH SIDE KO	EACH END KO	BOTTOM KO	CU. IN. CAPACITY	STD. CTN.
521911234	3½"-deep 4"-square red box	—	—	4 x ½" & ¾" Combo	2 x ½" & ¾" Combo	4 x ½" & ¾" Combo	46	24
521911234CV	3½"-deep 4"-square red box w/side mounting bracket	—	CV	4 x ½" & ¾" Combo	2 x ½" & ¾" Combo	4 x ½" & ¾" Combo	46	10

Square Boxes and Accessories

4" Square Boxes (continued)

CAT. NO.	DEPTH (IN.)	CU. IN. CAPACITY	CLAMPS	BRKTS.	KNOCKOUTS (IN.)				STD. CONDUIT CTN.
					EA. SIDE	EA. END	BOTTOM	STD.	
With Armored Cable/Metal-Clad Clamps									
52151 X	1¼	21.0	C-3	—	2-½, 1-½, ¾E	2	1-½	50	
52151XP	1¼	21.0	C-3	—	2-½, 1-½, ¾E	2	1-½	50	
52151 BX*	1¼	21.0	C-3	B	2-½, 1-½, ¾E	2	1-½	25	
52151 VX*	1¼	21.0	C-3	SV	2-½, 1-½, ¾E	2	1-½	25	
52151 CVX*	1¼	21.0	C-3	CV	2-½, 1-½, ¾E	2	1-½	25	
52151 MS X*	1¼	21.0	C-3	MS	2-½, 1-½, ¾E	2	1-½	25	
For Armored Cable and Metal-Clad Cable Clamps									
52171 X*	2½	30.3	C-3	—	2-½, 1-½, ¾E	2	1-½	25	
52171 MSX*	2½	30.3	C-3	MS	2-½, 1-½, ¾E	2	1-½	25	
52171MSXP (With 10½" ground wire)	2½	30.3	C-3	MS	2-½, 1-½, ¾E	2	1-½	25	
52171-CVX*	2½	30.3	C-3	CV-2	½-¾	—	—	25	

* All bracketed boxes come complete with eccentric knockouts. Per UL514A, suitable for use without a bonding jumper in circuits above or below 250 volts. Pigtail wire is #12 AWG insulated, 10½" long. All 52171 series boxes have a raised ground bump.



52151 X

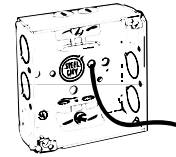

52151XP

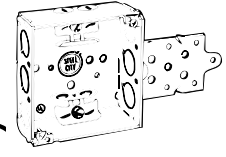

52151 BX*
B bracket
mounted flush

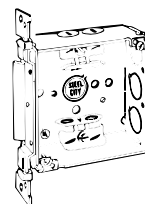

52151 VX*
SV bracket
mounted flush

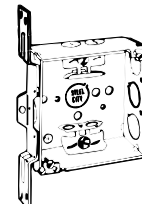

52151 CVX*
CV bracket
mounted flush

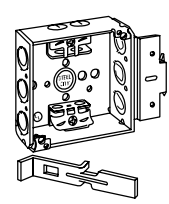

52151 MS X*
MS bracket for 1½",
2½", 3¾", 4" metal studs

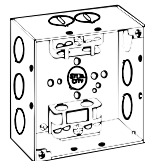

52171 X

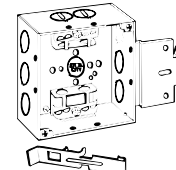

52171 MSX*
MS bracket for 1½",
2½", 3¾", 4" metal studs

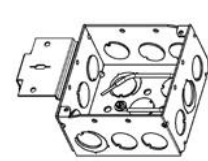

52171MSXP*

CAT. NO.	DESCRIPTION	CLAMPS	EACH SIDE CONDUIT	EACH END CONDUIT	BOTTOM CONDUIT	CU. IN. CAPACITY	STD. PACK.
52171-EW-SSX	2½"-deep with conduit KOs	—	1½", 1½" & ¾"E	2½", 1½" & ¾"E	2½", 2½" & ¾"E	30	20
52151-EF-SSX	1½"-deep with conduit KOs	—	1½", 1½" & ¾"E	2½", 1½" & ¾"E	2½", 2½" & ¾"E	21	20
52171-X-SSX	2½"-deep with armored cable clamps	C3	1½", 1½" & ¾"E	2 Cable	1½"	30	20
52151-X-SSX	1½"-deep with armored cable clamps	C3	1½", 1½" & ¾"E	2 Cable	1½"	21	20
CXLESSX	3½"-deep with armored cable clamps	C3	2½"	1½" & 2 Cable	1½"	15	20

Vapor Tite Boxes

- All K.O.'s pressed flush but still easy to remove
- No holes anywhere
- Top edge of boxes are flush at ears so gasket seals out all air

CAT. NO.	DESCRIPTION	DEPTH	STD. PKG.
52151-SVT	4" Sq. Box, ½" and ¾" K.O. Side and Bottom	1½"	50
52C1-VT	4" Sq. Blank Cover with Gasket	Flat	50
52171-SVT	4" Sq. Box, ½" and ¾" K.O. Side and Bottom	2½"	25
72C1-VT	4½" Sq. Blank Cover with Gasket	Flat	50
72171-SVT	4½" Sq. Box, ½" and ¾" K.O. Side and Bottom	2½"	25
54151-VT	4" Sq. Box, ½" K.O. Side and Bottom	1½"	50
54C1-VT	4" Oct. and Round Box Blank Cover	Flat	50

Square Boxes and Accessories

4" Square Boxes

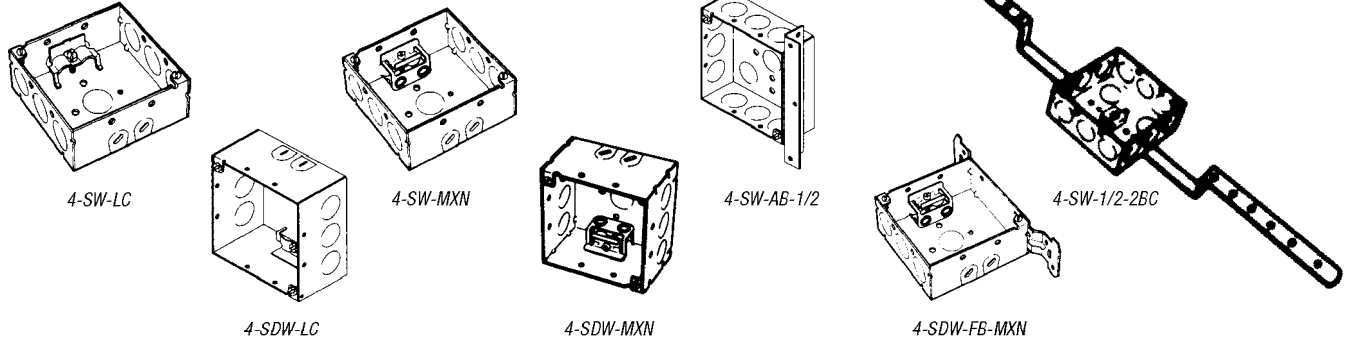

CAT. NO.	DEPTH (IN.)	CU. IN. CAPACITY	DESCRIPTION	CONSTRUCTION TYPE	STD. CTN.
4-SW-LC	1½	21.0	For Non-Metallic Sheathed Cable Two Loom KOs in each of two opposite sides, three ½" KOs in other two sides and one ½" KO in bottom. Two Loom clamps for use on non-metallic sheathed cable with 10/32 deep-slotted screws assembled*	Welded	50
4-SW-MXN	1½	21.0	For Metal-Clad Cable Two Loom KOs in each of two opposite sides, three ½" KOs in other two sides and one ½" KO in bottom. Two MXN clamps for MC, AC/BX and non-metallic sheathed cable (NM) included with 10/32 deep-slotted screws. Clamps are UL Listed for use with cable sizes 14/2 through 10/3 with ground*	Welded	50
4-SW-AB-1/2	1½	21.0	Three KOs in each of three sides, angle bracket on other side, and five ½" KOs in bottom. Angle bracket offset ¾" from top of box*	Welded	50
4-SW-1/2-2BC	1½	21.0	Three ½" KOs in each side and four ½" KOs in bottom. Mounted with clip on 2-BC bar hanger. Hanger is offset correct depth to set box flush with ceiling joist*	Welded	25
4-SDW-LC	2½	30.3	For Non-Metallic Sheathed Cable Two Loom KOs in each of two opposite sides, three ½" KOs in other two sides and one ½" KO in bottom. Two Loom clamps for use on non-metallic sheathed cable with 10/32 deep-slotted screws assembled*	Welded	25
4-SDW-MXN	2½	30.3	For Metal-Clad Cable Two Loom KOs in each of two opposite sides, three ½" KOs in other two sides and one ½" KO in bottom. Two MXN clamps for MC, AC/BX and non-metallic sheathed cable (NM) included with 10/32 deep-slotted screws. Clamps are UL Listed for use with cable sizes 14/2 through 10/3 with ground*	Welded	25
4-SDW-FB-MXN	2½	30.3	For Metal-Clad Cable Two Loom KOs in each of two opposite sides, three ½" KOs in side opposite flat bracket and one ½" KO in bottom. Two MXN clamps for MC, AC/BX and non-metallic sheathed cable (NM) included with 10/32 deep-slotted screws. Clamps are UL Listed for use with cable sizes 14/2 through 10/3 with ground*	Welded	25

*Uses Steel City® 4" square extension rings and 400 series rings and covers.

4" Square Thru-Wall Box



CAT. NO.	DEPTH (IN.)	CU. IN. CAPACITY	KNOCKOUT (IN.)			STD. CTN.
			EA. SIDE CONDUIT	EA. END CONDUIT		
With Conduit KOs						
X1-1/2 & 3/4	1½	21.0	2-½, 1-¾	2-½, 1-¾		25

4" Square Two-Device Boxes



CAT. NO.	DEPTH (IN.)	CU. IN. CAPACITY	BRACKETS	KNOCKOUTS (IN.)			STD. CTN.
				EA. SIDE CONDUIT	EA. END CONDUIT	BOTTOM CONDUIT	
With Conduit KOs							
2G4D 1/2 & 3/4	2½	30.3	—	2-½, 1-¾	2-½, 1-¾	3-½, 2-¾	25
2G4DV 1/2 & 3/4	2½	30.3	CV	2-½, 1-¾	2-½, 1-¾	3-½, 2-¾	25

Square Boxes and Accessories

4" Square Box Partitions

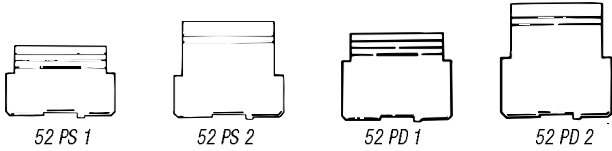

CAT. NO.	DESCRIPTION	STD. CTN.
For 1½" Deep Box with Square-Cut Tile Wall Two-Device Covers		
52 PS 1	For ½", ¾" and 1" raised covers	25
52 PS 2	For 1¼", 1½" and 2" raised covers	25
For 2½" Deep Box with Square-Cut Tile Wall Two-Device Covers		
52 PD 1	For ½", ¾" and 1" raised covers	25
52 PD 2	For 1¼", 1½" and 2" raised covers	25

4" Square Wall Rings

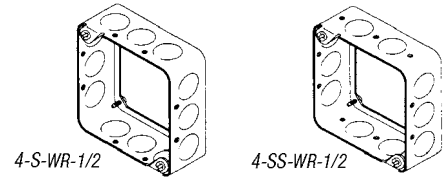

CAT. NO.	DEPTH (IN.)	CU. IN. CAPACITY	DESCRIPTION	CONSTRUCTION TYPE	STD. CTN.
4-S-WR-1/2	1½	21.0	Wall Ring Three ½" KOs in each side. Four 8/32 screws furnished (two in top and two in bottom)*	Drawn	50
4-SS-WR-1/2	1½	18.0	Wall Ring Three ½" KOs in each of two opposite sides, two ½" KOs in other two sides. Four 8/32 screws furnished (two in top and two in bottom)**	Drawn	50

*For use with two Steel City® 403-0 rings for back to back devices in 2" partitions.
**For use with two Steel City® 403-0 rings for back to back devices in 1¾" partitions

4" Square Rings and Covers

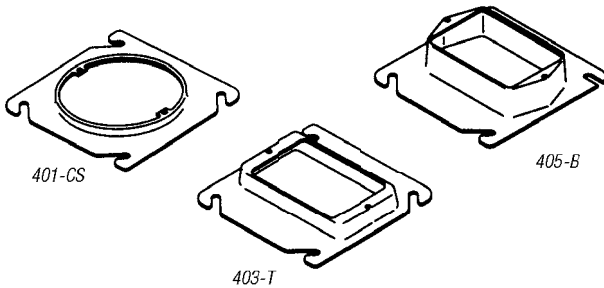

CAT. NO.	CU. IN. CAPACITY	DESCRIPTION	STD. CTN.
401-CS	1.0	¼" raised — 4" square Open plaster ring with ears. Ears tapped 8/32–2 ² / _{32"} on centers. Special screw lock feature in slots*	25
403-T	3.5	Tile Ring, ½" raised — 4" square For single switch or receptacle. Ears tapped 8/32–2 ² / _{32"} on centers*	50
405-B	5.0	⅙" raised — 4" square For single switch or receptacle*	25

*Fits any Steel City® 4" square outlet box or extension ring.

4" Square Industrial Device Covers

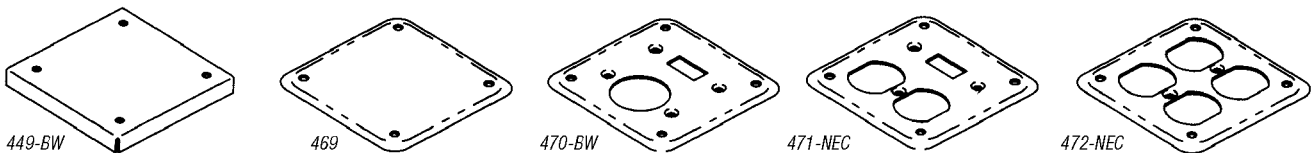

CAT. NO.	DESCRIPTION	STD. CTN.
449-BW	½" raised — 4" square Surface blank. Each cover individually packaged with the necessary screws for mounting*	25
469	⅙" raised — 4" square Surface blank. Each cover individually packaged with the necessary mounting screws*	25
470-BW	⅙" raised — 4" square For one toggle switch and one single receptacle. Opening 1.4" diameter. Each cover individually packaged with the necessary mounting screws*	25
471-NEC	⅙" raised — 4" square For one toggle switch and one duplex receptacle. Each cover individually packaged with the necessary mounting screws*	25
472-NEC	⅙" raised — 4" square For two duplex receptacles. Each cover individually packaged with the necessary mounting screws*	25

*Fits any Steel City® 4" square outlet box or extension ring.

Square Boxes and Accessories

4" Square Industrial Device Covers (continued)

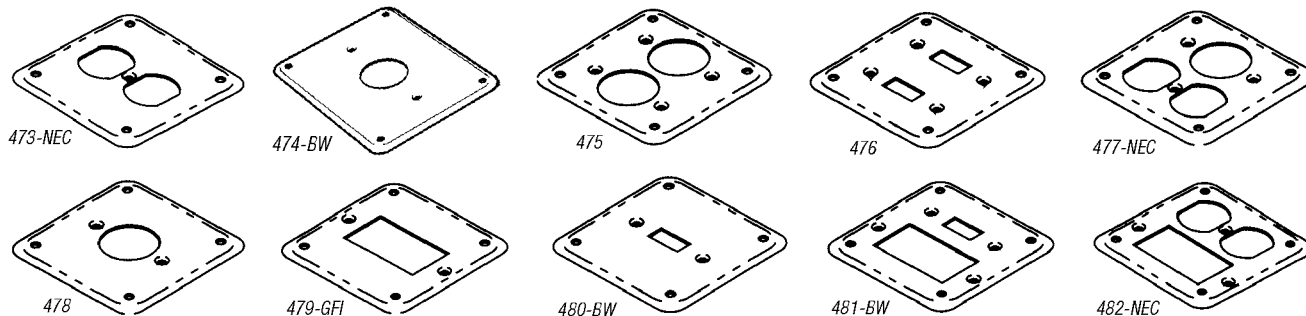

CAT. NO.	DESCRIPTION	STD. CTN.
473-NEC	1/8" raised — 4" square For one duplex receptacle in center. Each cover individually packaged with the necessary mounting screws*	25
474-BW	1/8" raised — 4" square For one single receptacle in center. Opening 1.4" diameter. Each cover individually packaged with the necessary mounting screws*	25
475	1/8" raised — 4" square For two single receptacles. Openings 1.4" diameter. Each cover individually packaged with the necessary mounting screws*	25
476	1/8" raised — 4" square For two toggle switches. Each cover individually packaged with the necessary mounting screws*	25
477-NEC	1/8" raised — 4" square For one duplex and one single receptacle. Opening 1.4" diameter. Each cover individually packaged with the necessary mounting screws*	25
478	1/8" raised — 4" square For one four-wire twist lock receptacle in center. Opening 1.594" diameter. Each cover individually packaged with the necessary mounting screws*	25
479-GFI	1/8" raised — 4" square For one GFI receptacle in center. Each cover individually packaged with the necessary mounting screws*	25
480-BW	1/8" raised — 4" square For one toggle switch in center. Each cover individually packaged with the necessary mounting screws*	25
481-BW	1/8" raised — 4" square For one GFI receptacle and one toggle switch. Each cover individually packaged with the necessary mounting screws*	25
482-NEC	1/8" raised — 4" square For one GFI and one duplex receptacle. Each cover individually packaged with the necessary mounting screws*	25

*Fits any Steel City® 4" square outlet box or extension ring.

4" Square Extension Rings



CAT. NO.	KNOCKOUTS (IN.)		STD. CTN.
	EA. SIDE CONDUIT	EA. END CONDUIT	
1 1/2" Deep — with Conduit KOs — 21.0 Cubic Inch Capacity			
53151 1/2	3-1/2	3-1/2	50
53151 3/4	2-3/4	2-3/4	25
53151 1/2 3/4	2-1/2, 1-3/4	2-1/2, 1-3/4	50
531511234UB**	2-1/2, 1-1/2, 3/4E	2-1/2	50
2 1/8" Deep — with Conduit KOs — 30.3 Cubic Inch Capacity			
531711234*	2-1/2, 1-1/2, 3/4E	2-1/2, 1-3/4	25
53171 1	2-1	2-1	25

* Per UL 514-A, suitable for use without a bonding jumper in circuits above or below 250 volts.

** ECC, KOs on sides.

Square Boxes and Accessories

4" Square-Cut Tile Wall Covers

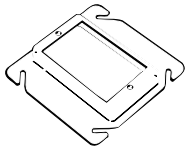

52 C 49 1/2

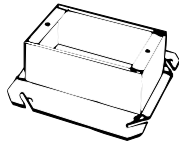

52C5011/2-25

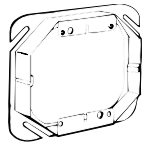

52 C 52 1/2

CAT. NO.	RAISED (IN.)	DESCRIPTION	CU. IN. CAP.	STD. CTN.
For Single Device — Steel				
52 C 49 1/2*	1/2	—	3.5	50
52-C-49-3/4*	3/4	—	5.3	50
52-C-49-1*	1	—	7.0	10
52-C-49-1-1/4	1 1/4	—	9.3	10
52C5011/2-25	1 1/2	—	11.0	25
52C512-25	2	—	14.8	25
For Two Devices — Steel				
52 C 52 1/2	1/2	—	6.0	10
52-C-52-3/4	3/4	—	9.0	10
52-C-52-1	1	Square corners	12.5	10
52-C-52-1-1/4	1 1/4	facilitate tile installation	15.5	10
52 C 53 1 1/2	1 1/2	—	19.0	10
52 C 54 2	2 3/4	—	25.5	10

* Drawn style.

4" Square Covers



52 C 1



52 C 3 1



52 C 6



CAT. NO.	RAISED (IN.)	DESCRIPTION	CU. IN. CAP.	STD. CTN.
52 C 1	—	Flat, blank	—	100
52-C-3-25	3/8	Center blanked with tapped	4.3	25
52-C-3-1/2-25	1/2	ears on 2 3/4" centers	3.5	25
52-C-3-3/4	3/4	Center blanked with	4.3	25
52 C 3 1	1	tapped ears on	5.8	25
52-C-3-1-1/4	1 1/4	2 5/8" centers	7.3	25
52 C 6	—	Flat, with 1/2" KD	—	100

4" Square Device Covers



52 C 16



52 C 19



52 C 21



52 C 0

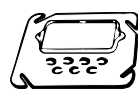

52 C 10



52 C 14



52-C-36



52 C 00



52-C-17-25

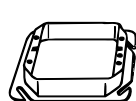

52 C 21

CAT. NO.	RAISED (IN.)	DESCRIPTION	CU. IN. CAP.	STD. CTN.
For Single Device — Steel				
52 C 0	—	Flat	—	25
52 C 62	1/4	Keyed for plaster	1.5	25
52 C 10	1/4	Offset, keyed for plaster	1.0	25
52 C 13	1/2	—	3.0	50
52 C 14	3/4	—	5.0	50
52 C 14 5/8	5/8	—	4.0	50
52 C 15	1	—	7.0	25
52 C 16	1 1/4	—	8.3	25
52-C-36	1/4	For drywall construction	1.0	25
For Two Devices				
52 C 00	—	Flat	—	25
52C20-25	1/4	—	2.3	25
52-C-17-25	1/2	—	6.3	25
52 C 18	3/4	—	9.0	25
52-C-18-5/8-25	5/8	For drywall construction	7.3	25
52 C 19	1	—	12.0	25
52 C 21	1 1/4	—	15.0	25
52 C 37	1/8	—	2.3	25

Square Boxes and Accessories

Box Support Covers

Steel City® Box Support Covers combine a box-to-stud mounting bracket with a device cover in one, easy-to-use product. Designed for use with 4" square boxes, Steel City® Box Support Covers can be used with both steel and wood studs.

- Combines cover and bracket in one component
- Available in one- and two-device versions
- 1/2", 5/8" and 3/4" raised covers
- Speeds installation time
- Needs no far side support
- Can be used with both steel and wood stud
- Can be used without a box as a low voltage device support
- UL and CSA Listed (UL File #E2969, CSA File #LR5043)



52CM13



52CMD17



CAT. NO.	RAISED (IN.)	# OF DEVICES	CU. IN. CAPACITY	STD. CTN.
52CM13	1/2	1	3.0	25
52CM14-5/8	5/8	1	4.0	25
52CM14	3/4	1	5.0	25
52CMD17	1/2	2	6.3	25
52CMD18-5/8	5/8	2	7.3	25
52CMD18	3/4	2	9.0	25

4" Square Surface Covers



RS 4

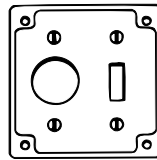

RS 1

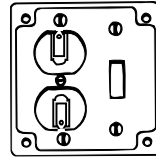

RS 2

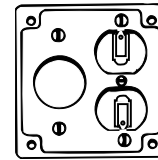

RS 3

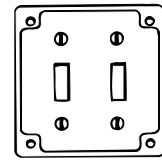

RS 5

CAT. NO.	DEPTH (IN.)	CU. IN. CAPACITY	DIA. HOLE (IN.)	DESCRIPTION	STD. CTN.
RS 1	1/2	5.0	1 1/2	For one toggle switch and one single flush receptacle	50
RS 2*	1/2	5.0	—	For one toggle switch and one duplex flush receptacle	50
RS 3*	1/2	5.0	1 1/2	For one single and one duplex flush receptacle	50
RS 4	1/2	5.0	1 5/8	For one 4-wire twist-lock single receptacle	50
RS 5	1/2	5.0	—	For two toggle switches	50
RS 8*	1/2	5.0	—	For two duplex, flush receptacles	50
RS 9	1/2	5.0	—	For one toggle switch	50
RS 10	1/2	5.0	1 1/2	For two single, flush receptacles	50
RS 11	1/2	5.0	1 1/2	For one single, flush receptacle	50
RS 12*	1/2	5.0	—	For one duplex, flush receptacle	50
RS 13	1/2	5.0	2 3/32	For one 30 or 50 amp. dryer or range receptacle	50
RS 14	1/2	5.0	2 1/2	—	50
RS 15	1/2	5.0	1 3/4	For #3330-30A 250 V twist-lock receptacle	50
RS-16-CC	1/2	5.0	—	For one ground fault receptacle	25
RS-17-CC	1/2	5.0	—	For two ground fault receptacles	25
RS-18-CC	1/2	5.0	—	For one ground fault receptacle and one toggle switch	25
RS-19-CC*	1/2	5.0	—	For one ground fault receptacle and one duplex receptacle	25

Remove portion of G.F.I. receptacle ear to mount receptacle to cover. Screws captivated.

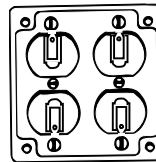

RS 8

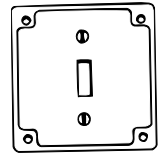

RS 9

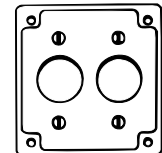

RS 10

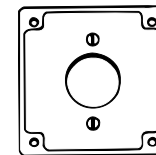

RS 11

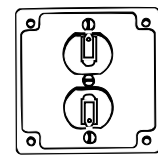

RS 12

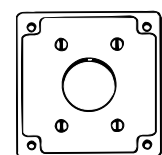

RS 13

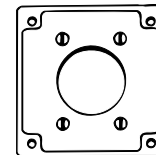

RS 14

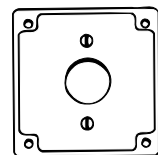

RS 15



RS-16-CC

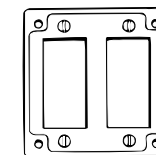

RS-17-CC

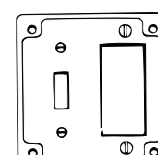

RS-18-CC

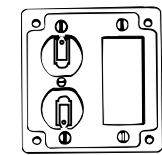

RS-19-CC

Square Boxes and Accessories

UL® Listed Adjustable Mud Ring now available in both single- and two-gang.

Adjustable Mud Rings

Mud Rings feature an inner ring that adjusts from 1/2" to 1 1/2" in depth to accommodate various drywall thicknesses. Marked with a measured rule and equipped with two adjustment screws, the inner ring can be set to the anticipated depth prior to installation and then easily adjusted after drywall installation to accommodate any variation in depth (1/2" to 1 1/2").

NEW!



Boxes & Covers — Steel City® Metallic Boxes

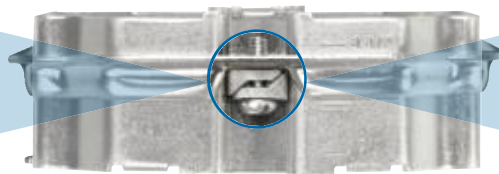

Wedge Locking Blocks
Designed to ensure grounding continuity

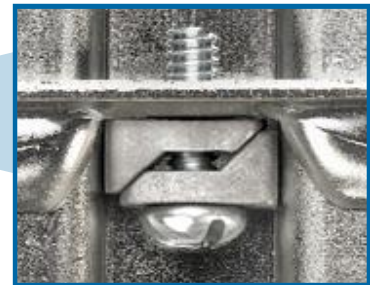

Adjustable Mud Ring Installation/Adjustment Steps:



Loosen...
The two adjustment screws located on opposing corners of the mud ring.



Adjust...
Inner ring to be flush with wall surface.



Re-tighten...
Adjustment screws.



CAT. NO.	DESCRIPTION	STD. CTN.
52-C-ADJ	Single-Gang Adjustable Mud Ring, 1/2" to 1 1/2"	25
52-C-ADJ2	Two-Gang Adjustable Mud Ring, 1/2" to 1 1/2"	20

Square Boxes and Accessories

Steel City® Hands-Free Swivel Hanger

The new Steel City® Hands-Free Swivel Hanger allows you to quickly install high- and low-bay lighting fixtures without the need for an extra set of hands. The hanger design enables the fixture to be set in place, giving users access to the conductors while wiring is being completed. The Hands-Free Swivel Hanger can support a fixture up to 50 pounds and is ideal for gyms or other commercial sites.

- Fits standard 3½" or 4" octagon (SHHFR1234)
- Fits 4" square (SHHF1234) boxes
- A single installer can complete the installation — saving time, labor and cost
- Fixtures can be set in place before wiring is completed
- Design enables users to access the conductors after the fixture has been mounted onto the box
- Accommodates ½" or ¾" threaded fixture pipes
- Permits 20° swing from vertical
- Ideal for gyms or other commercial sites

Material: Zinc-plated sheet-metal hanger and malleable iron swivel connector.

Listing: UL and CSA Listed.

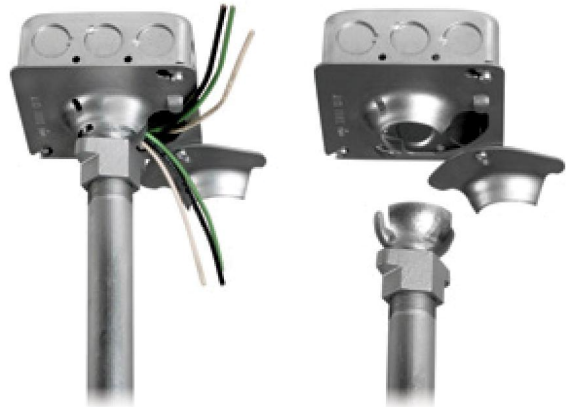

CAT. NO.	DESCRIPTION	STD. CTN.
SHHF 1/2 3/4	Hands-free Swivel Hanger	25
SHHFR 1/2 3/4	Hands-free Swivel Hanger (round)	25

Swivel Hangers



SHR 1/2 & 3/4



CAT. NO.	DESCRIPTION	STD. CTN.
SHR 1/2 & 3/4	Swivel hanger for 4" octagonal boxes	25

UL Listed for 50 lb. fixture support.

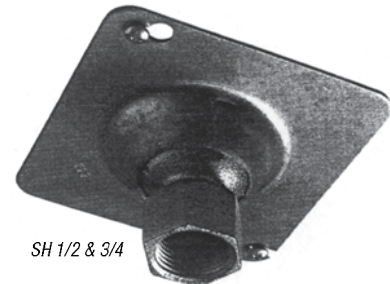

SH 1/2 & 3/4



CAT. NO.	DESCRIPTION	STD. CTN.
SH 1/2 & 3/4	Swivel hanger for 4" square boxes	25

UL Listed for 50 lb. fixture support.

Square Boxes and Accessories

4¹/₁₆" Square Boxes

CAT. NO.	DEPTH (IN.)	CU. IN. CAPACITY	EA. SIDE CONDUIT	EA. END CONDUIT	BOTTOM CONDUIT	STD. CTN.
With Conduit KOs						
72151-1/2 & 3/4-E*	1½	29.5	3-½", ¾- ³³ / ₆₄ "	2-½", ¾- ³³ / ₆₄ "	2-½", ¾"-E, 4-½"	20
72171-1/2 & 3/4-E*	2½	42.0	3-½" & ¾"-E	3-½" & ¾"-E	2-½", ¾"-E, 3-½"	20
72171 1	2½	42.0	*2-1"	2-1"	3-½", 2-¾"	20
72171 3/4 1*	2½	42.0	1-¾", 1-1"	1-¾", 1-1"	3-½", 3-¾", 2-1"	20
72171 1 1/4*	2½	42.0	2-1¼"	1-1¼"	3-½", 2-¾"	20
72171CV 1/2 3/4*	2½	42.0	2-½", 1-¾"	2-½", 1-¾"	3-½", 2-¾"	25
72151 MS 1/2 3/4*	2½	42.0	3-½", ¾- ³³ / ₆₄ "	3-½", ¾- ³³ / ₆₄ "	2-½", ¾- ³³ / ₆₄ ", 3-½"	20
72151 MS 1/2 3/4	2½	42.0	3-½", ¾- ³³ / ₆₄ "	2-½", ¾- ³³ / ₆₄ "	2-½", 2-¾- ³³ / ₆₄ ", 4-½"	25
72171 MS 1/2 3/4*	2½	42.0	3-½", ¾- ³³ / ₆₄ "	3-½", ¾- ³³ / ₆₄ "	2-½", ¾- ³³ / ₆₄ ", 3-½"	25
72151MSX	2½	42.0	3-½", ¾- ³³ / ₆₄ "	2-½", ¾- ³³ / ₆₄ "	2-½", 2-¾- ³³ / ₆₄ ", 4-½"	25
72151MSXP	2½	42.0	3-½", ¾- ³³ / ₆₄ "	2-½", ¾- ³³ / ₆₄ "	2-½", 2-¾- ³³ / ₆₄ ", 4-½"	25
72151MSP	2½	42.0	3-½", ¾- ³³ / ₆₄ "	3-½", ¾- ³³ / ₆₄ "	3-½", 2-½", ¾- ³³ / ₆₄ "	25
72171MSX	2½	42.0	3-½", ¾- ³³ / ₆₄ "	3-½", ¾- ³³ / ₆₄ "	3-½", 2-½", ¾- ³³ / ₆₄ "	25
72171MSXP	2½	42.0	3-½", ¾- ³³ / ₆₄ "	3-½", ¾- ³³ / ₆₄ "	3-½", 2-½", ¾- ³³ / ₆₄ "	25



72171 MS ½ & ¾
MS bracket for 1½", 2½", 3¾", 4" metal studs

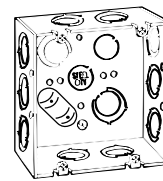

72151-1/2 & 3/4-E



72171-1/2 & 3/4-E

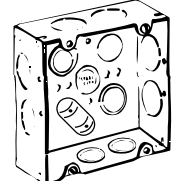

72171 1

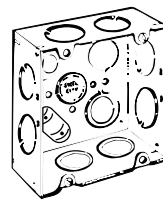

72171 3/4 1

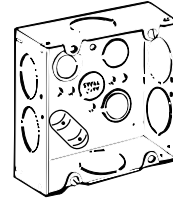

72171 1 1/4

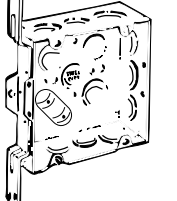

72171CV 1/2 & 3/4

* Per UL 514-A, suitable for use without a bonding jumper in circuits above or below 250 volts.

4¹/₁₆" Square Boxes

CAT. NO.	DEPTH (IN.)	CU. IN. CAPACITY	DESCRIPTION	CONSTRUCTION TYPE	STD. CTN.
5-SDW-FB-1	2½	42.0	Two 1" KOs in each of three sides, flat bracket on other side and three ½" KOs in a line in bottom with two ¾" KOs at opposite ends in bottom. Four tapped ears*	Welded	25

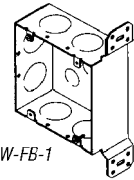

5-SDW-FB-1

4¹/₁₆" Square Box Extension Rings

CAT. NO.	DEPTH (IN.)	CU. IN. CAPACITY	KNOCKOUT (IN.)		STD. CTN.
			EA. SIDE CONDUIT	EA. END CONDUIT	
With Conduit KOs					
73151 1/2 3/4*	1½	29.5	2-½", 1¼"	2-½", 1¼"	20
73171 1/2 3/4*	2½	42.0	2-½", 1¼"	2-½", 1¼"	20
73171 1	2½	42.0	2-1"	2-1"	20

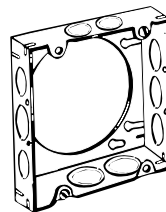

73151 1/2 & 3/4

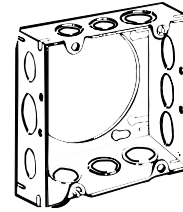

73171 1/2 & 3/4

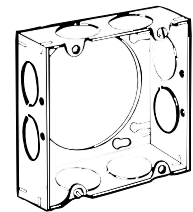

73171 1

4¹/₁₆" Square Covers

CAT. NO.	CU. IN. CAPACITY	RAISED (IN.)	DESCRIPTION	STD. CTN.
72 C 1	—	—	Flat blank	50
72 C 6	—	—	Flat with ½" KO	25
72 C 3	3.5	¾	Center blanked with tapped ears	10
72-C-3-1/2	3.0	½	Center blanked with tapped ears on 2 ³ / ₁₆ " centers	25
72-C-3-3/4	4.3	¾	Center blanked with tapped ears on 2 ³ / ₁₆ " centers	10
72-C-3-1	5.8	1	Center blanked with tapped ears on 2 ³ / ₁₆ " centers	25



72 C 1



72 C 6

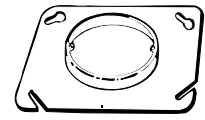

72 C 3

Square Boxes and Accessories

4¹¹/₁₆" Square Rings and Covers

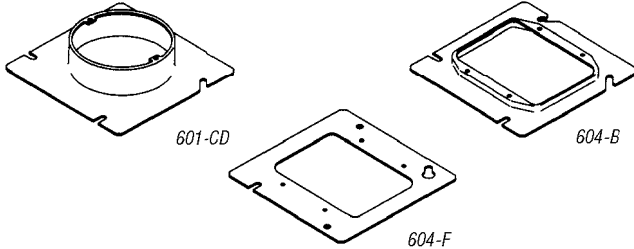

CAT. NO.	CU. IN. CAPACITY	DESCRIPTION	STD. CTN.
601-CD	8.8	1 ¹ / ₄ " raised — 4 ¹¹ / ₁₆ " square Open plaster ring with ears. Ears tapped 8/32—2 ⁹ / ₃₂ " on centers. Special screw lock feature in slots*	25
604-F	—	Flat — 4 ¹¹ / ₁₆ " square For two switches or receptacles*	25
604-B	2.8	1 ¹ / ₄ " raised — 4 ¹¹ / ₁₆ " square For two switches or receptacles*	25

*Fits any Steel City® 4¹¹/₁₆" square outlet box or extension ring.

4¹¹/₁₆" Square Tile Rings

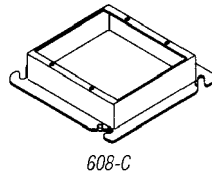

CAT. NO.	CU. IN. CAPACITY	DESCRIPTION	STD. CTN.
608-C	12.5	1" raised — 4 ¹¹ / ₁₆ " square For two switches or receptacles*	10

*Fits any Steel City® 4¹¹/₁₆" square outlet box or extension ring.

4¹¹/₁₆" Square Box Partitions

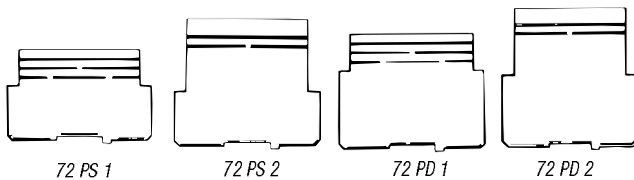

CAT. NO.	DESCRIPTION	STD. CTN.
For 1¹/₂" Deep Box with Square-Cut Tile Wall — Two-Device Covers		
72 PS 1	For 1/2", 3/4" and 1" raised covers	25
72 PS 2	For 1 1/4", 1 1/2" and 2" raised covers	25
For 2 1/4" Deep Box with Square-Cut Tile Wall — Two-Device Covers		
72 PD 1	For 1/2", 3/4" and 1" raised covers	25
72 PD 2	For 1 1/4", 1 1/2" and 2" raised covers	25

4¹¹/₁₆" Square Surface Covers

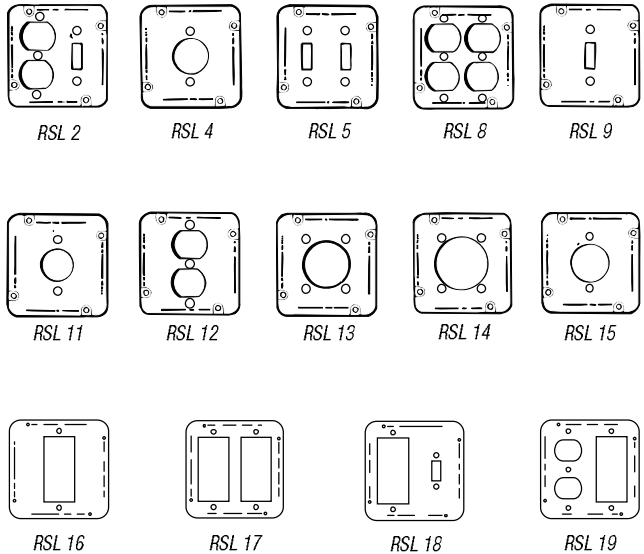

CAT. NO.	DEPTH (IN.)	CU. IN. CAPACITY	DIA. HOLE (IN.)	DESCRIPTION	STD. CTN.
RSL 2	1/2	7.5	—	For one toggle switch and one duplex flush receptacle	10
RSL 4	1/2	7.5	1 1/32	For one 4-wire twist-lock single receptacle	10
RSL 5	1/2	7.5	—	For two toggle switches	10
RSL 8	1/2	7.5	—	For two duplex, flush receptacles	10
RSL 9	1/2	7.5	1 5/32	For one toggle switch	10
RSL 11	1/2	7.5	1 3/64	For one single, flush receptacle	10
RSL 12	1/2	7.5	—	For one duplex, flush receptacle	10
RSL 13	1/2	7.5	2 3/32	For one 30A to 50A dryer or range receptacle	10
RSL 14	1/2	7.5	2 1/32	—	10
RSL 15	1/2	7.5	1 3/4	For #3330—30A 250 V twist-lock receptacle	10
RSL 16	1/2	7.5	—	For one ground fault receptacle	10
RSL 17	1/2	7.5	—	For two ground fault receptacles	10
RSL 18	1/2	7.5	—	For one ground fault receptacle and one toggle switch	10
RSL 19	1/2	7.5	—	For one ground fault receptacle and one duplex receptacle	10

Square Boxes and Accessories

4¹¹/₁₆" Square Device Covers

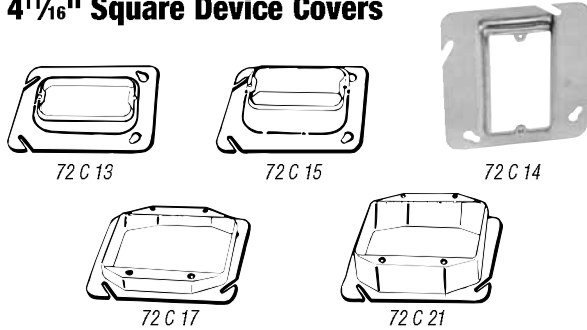

CAT. NO.	RAISED (IN.)	CU. IN. CAPACITY	STD. CTN.
For Single Device			
72 C 62	¼	1.0	25
72 C 13	½	3.0	25
72 C 14	¾	5.0	25
72 C 14 5/8	¾	4.0	25
72 C 15	1	7.0	10
72 C 16	1¼	8.3	10
For Two Devices			
72 C 17	½	6.3	25
72 C 18	¾	9.0	25
72 C 18 5/8	¾	7.5	25
72 C 19	1	12.0	25
72 C 21	1¼	15.0	25

4¹¹/₁₆" Square-Cut Tile Wall Covers

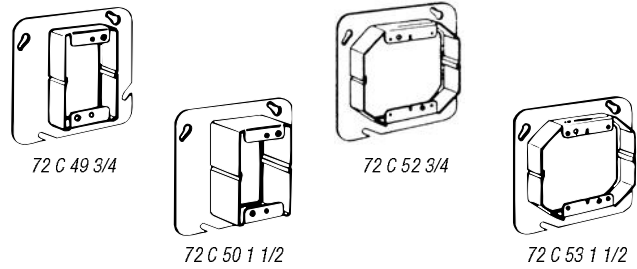

CAT. NO.	RAISED (IN.)	CU. IN. CAPACITY	STD. CTN.
For Single Device — Steel			
72-C-49-1/2	½	3.5	10
72 C 49 3/4	¾	5.3	10
72-C-49-1	1	7.0	10
72-C-49-1-1/4	1¼	7.0	10
72 C 50 1 1/2	1½	9.0	10
72 C 51 2	2	14.5	20
For Two Devices — Steel			
72-C-52-1/2	½	6.0	10
72 C 52 3/4	¾	9.0	10
72-C-52-1	1	12.5	25
72-C-52-1-1/4	1¼	15.5	25
72 C 53 1 1/2	1½	19.0	10
72 C 54 2	2	25.5	10

4¹¹/₁₆" Square Industrial Device Covers

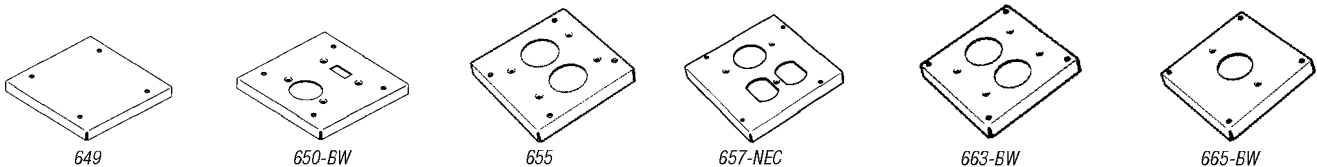

CAT. NO.	CU. IN. CAPACITY	DESCRIPTION	STD. CTN.
649	7.5	½" raised — 4 ¹¹ / ₁₆ " square Surface blank. Each cover individually packaged with the necessary screws for mounting*	10
650-BW	7.5	½" raised — 4 ¹¹ / ₁₆ " square For one toggle switch and one single receptacle. Opening 1.4" diameter. Each cover individually packaged with the necessary screws for mounting*	10
655	7.5	½" raised — 4 ¹¹ / ₁₆ " square For two single receptacles. Opening 1.4" diameter. Each cover individually packaged with the necessary screws for mounting*	10
657-NEC	7.5	½" raised — 4 ¹¹ / ₁₆ " square For one duplex and one single receptacle. Opening 1.4" diameter. Each cover individually packaged with the necessary screws for mounting*	10
663-BW	7.5	½" raised — 4 ¹¹ / ₁₆ " square For two three-wire twist lock receptacles. 1 ¹ / ₁₆ " spacing between 1.4" diameter openings. Each cover individually packaged with the necessary screws for mounting*	10
665-BW	7.5	½" raised — 4 ¹¹ / ₁₆ " square Opening to accommodate Hubbell 3330 receptacle in center. Opening 1.75" diameter. Each cover individually packaged with the necessary screws for mounting*	10

*Fits any Steel City® 4¹¹/₁₆" square outlet box or extension ring.

Ceiling Fan Boxes and Accessories

Extra Heavy-Duty New-Work Bar Hangers

Ceiling Fan and Light Fixture Bar Hangers

This innovative extruded-aluminum bar hanger was designed for strength. It is UL Listed for up to 70 lbs. for fan support and an industry-leading 200 lbs. for fixture support

- Gold end plates easily identify the hanger as meeting UL and NEC® requirements for fan support
- Screwed-on end plates are consistently strong and avoid unsightly welds
- End plates feature temporary fixing spikes for hands-free installation
- Expandable for joists spaced from 16 to 24 inches



56111CFB-BHL



54151CFB-BHL



4070CFB-BHL



CFB-BHL



CAT. NO.	CAPACITY CU. IN.	DESCRIPTION	MAX. REC. LOAD		NEW/OLD WORK	STD. CTN.
			FAN	FIXTURE		
56111CFB-BHL	6.0	New-work bar hanger with 1/2" pan-type ceiling fan box with 3 x 1/2" KOs and non-metallic sheathed cable connector	70 lbs.	200 lbs.	New	10
54151CFB-BHL	15.8	New-work bar hanger with 1 1/2" deep ceiling fan box with 3 x 1/2" KOs and clamps for non-metallic sheathed cable	70 lbs.	200 lbs.	New	10
4070CFB-BHL	21.5	New-work bar hanger with non-metallic ceiling fan box with clamps for non-metallic sheathed cable	35 lbs.	50 lbs.	New	10
CFB-BHL	*	New-work bar hanger without outlet box. Mounting bracket for outlet box included	—	*	New	10

* Dependent on box used.

NEC and National Electrical Code are registered trademarks of the National Fire Protection Association, Inc.

Square Boxes and Accessories

Easy to identify and install!

Fire Alarm Boxes and Fittings

Steel City® Fire Alarm Boxes and Fittings can meet all of your visual identification requirements for fire alarm systems — and make installation and upgrades faster and easier than ever before! Available in a variety of sizes to accommodate new or old work configurations, these boxes are simple to install with high-quality Thomas & Betts fittings. Plus, the bright red finish eliminates time-consuming painting of existing fixtures and provides long-lasting identification in even the harshest environments.



52171-1234RD



72171-1234RD



52171-EXTRD



52-C-1RD



52151-1234RD



52171-CV-1234RD



52171-EXTOWRD



53171-1234RD

Fire Alarm Boxes



CAT. NO.	DESCRIPTION	EARS	BRACKETS	EACH SIDE CONDUIT	EACH END CONDUIT	BOTTOM CONDUIT	CU. IN.	STD. CAPACITY CTN.
52171-1234RD	2½"-deep 4"-square red box	—	—	2½", 1½" & ¾"E	2½", 1½" & ¾"E	3½", 2½" & ¾"E	30.3	50
52151-1234RD	1½"-deep 4"-square drawn red box	—	—	2½", 1¼"	2½", 1¼"	3½", 2¾"	21.0	50
72171-1234RD	2½"-deep 4⅞" red box	—	—	3½" & ¾"E	3½" & ¾"E	3½", 2½" & ¾"E	42.0	20
52171-CV-1234RD	2½"-deep 4"-square red box with CV bracket	—	CV	2½", 1½" & ¾"E	2½", 1½" & ¾"E	3½", 2½" & ¾"E	30.3	50
52171-EXTRD	2½"-deep 4"-square red box with ext. ring	—	—	4½", 2½" & ¾"E	4½", 2½" & ¾"E	3½", 2½" & ¾"E	60.6	25
52171-EXTOWRD	2½"-deep 4"-square red box with ext. ring and old work ears	Yes	—	4½", 2½" & ¾"E	4½", 2½" & ¾"E	3½", 2½" & ¾"E	60.6	25
52 C 1RD	Flat 4"-square red cover	—	—	—	—	—	—	100
53171-1234RD	2½"-deep 4"-square red extension ring	—	—	2½", 1½" & ¾"E	2½", 1½" & ¾"E	—	30.3	25
521911234RD	3½"-deep 4"-square red box	—	—	4 x ½" & ¾" Combo	2 x ½" & ¾" Combo	4 x ½" & ¾" Combo	46	24
521911234CVRD	3½"-deep 4"-square red box w/side mounting bracket	—	CV	4 x ½" & ¾" Combo	2 x ½" & ¾" Combo	4 x ½" & ¾" Combo	46	10

Fire Alarm Fittings



CAT. NO.	DESCRIPTION	STD. CTN.
TC121A-FA	½" Red Steel EMT Set Screw Connector	50
TC122A-FA	¾" Red Steel EMT Set Screw Connector	50
TC123A-FA	1" Red Steel EMT Set Screw Connector	25
TC721A-FA	½" Red Insulated Steel EMT Set Screw Connector	50
TC722A-FA	¾" Red Insulated Steel EMT Set Screw Connector	50
TC723A-FA	1" Red Insulated Steel EMT Set Screw Connector	25
TK121A-FA	½" Red Steel EMT Set Screw Coupling	50
TK122A-FA	¾" Red Steel EMT Set Screw Coupling	50
TK123A-FA	1" Red Steel EMT Set Screw Coupling	25



TK122A-FA



TK121A-FA



TC122A-FA



TC121A-FA

Square Boxes and Accessories

4" Square Old-Work Box with Swing Ears

CAT. NO.	DESCRIPTION	STD. CTN.
52171-OW	Metallic 4"-Sq. x 2½"D Old-Work Box with factory-mounted swing ears	25
OW SWING EAR	Swing Ears only (for field installation) with self-threading screws	50 (25 pair)



52171-OW



OW Swing Ears

4" Square Boxes

CAT. NO.	DEPTH (IN.)	CU. IN. CAPACITY	CLAMPS	BRKTS.	KNOCKOUTS (IN.)			STD. CTN.
					EA. SIDE CONDUIT	EA. END CONDUIT	BOTTOM CONDUIT	
With Non-Metallic Sheathed Cable Clamps								
52151 N	1½	21.0	C-5	—	2-½, 1-½, ¾E	2	1-½	50
52151 MS N*	1½	21.0	C-5	MS	2-½, 1-½, ¾E	2	1-½	25
52151 BN*	1½	21.0	C-5	B	2-½, 1-½, ¾E	2	1-½	25
52151 VN*	1½	21.0	C-5	SV	2-½, 1-½, ¾E	2	1-½	25
52151 CVN*	1½	21.0	C-5	CV	2-½, 1-½, ¾E	2	1-½	25
52151CVNP*	1½	21.0	C-5	CV	2-½, 1-½, ¾E	2	1-½	25
52171 N	2½	30.3	C-5	—	2-½, 1-½, ¾E	2	1-½	25
52171-VN*	2½	30.3	C-5	SV	2-½, 1-½, ¾E	2	1-½	25
With Conduit KOs								
52141-1/2	1¼	18.0	—	—	2-½, 1-¼, ¾E	3-½, 1-¼, ¾E	5-½	50
52151 1/2	1½	21.0	—	—	2-½, 1-¼, ¾E	2-¼, 1-¼, ¾E	3-½, 2-¼	50
52151-3/4	1½	21.0	—	—	2-½, 1-¼, ¾E	2-¼, 1-¼, ¾E	3-½, 2-¼	50
52151 1/2 3/4	1½	21.0	—	—	2-½, 1-¼, ¾E	2-¼, 1-¼, ¾E	3-½, 2-¼	50
521511234P	1½	21.0	—	—	2-½, 1-¼, ¾E	2-¼, 1-¼, ¾E	3-½, 2-¼	50
52151-3/4-W	1½	21.0	—	—	2-½, 1-¼, ¾E	2-¼, 1-¼, ¾E	3-½, 2-¼	50
52151B1234*	1½	21.0	—	B	2-½, 1-¼, ¾E	2-¼, 1-¼, ¾E	3-½, 2-¼	25
52151-1/2 & 3/4-EW	1½	21.0	—	—	2-½, 1-¼, ¾E	2-¼, 1-¼, ¾E	3-½, 2-¼	50
521511234EWGB (Ground bump)	1½	21.0	—	—	2-½, 1-¼, ¾E	2-¼, 1-¼, ¾E	2-½, 2-¼	50
521511234EWGBP (Ground bump with 10½" ground wire)	1½	21.0	—	—	2-½, 1-¼, ¾E	2-¼, 1-¼, ¾E	2-½, 2-¼	50

* All Bracketed boxes come complete with eccentric knockouts.
Per UL 514A, suitable for use without a bonding jumper in circuits above or below 250 volts. Pigtail wire is #12 AWG insulated, 10½" long.

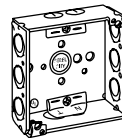

52151 N

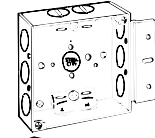

52151 MS N*
MS bracket for
1½", 2½", 3½", 4"

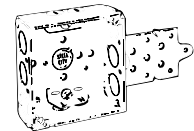

52151 BN*
B bracket
mounted flush

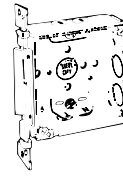

52151 VN*
SV bracket
mounted flush

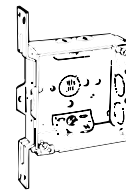

52151 CVN*
CV bracket
mounted flush

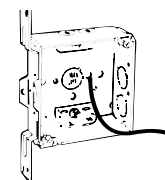

52151 CVNP



52171 N

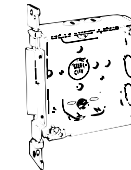

52171-VN*
SV bracket
mounted flush



52141-1/2



52151 1/2



52151-3/4



52151 1/2 3/4

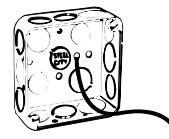

521511234P

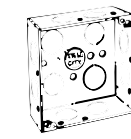

52151-3/4-W

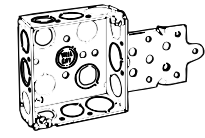

52151B1234
B Bracket mounted flush



52151-1/2 & 3/4-EW

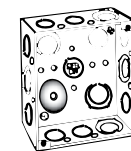

521511234EWGB

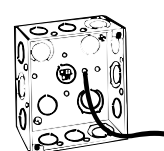

521511234EWGBP

Square Boxes and Accessories

4" Square Boxes (continued)

CAT. NO.	DEPTH (IN.)	CU. IN. CAPACITY	CLAMPS	BRKTS.	KNOCKOUTS (IN.)			STD. CTN.
					EA. SIDE CONDUIT	EA. END CONDUIT	BOTTOM CONDUIT	
<i>With Conduit KOs (continued)</i>								
521511234EWP*	1½	21.0	—	—	2-½, ¼E	2-½, ¼E	3-½, ¼E	50
52151 MS 1/2 & 3/4*	1½	21.0	—	MS	2-½, ¼E	2-½, ¼E	3-½, ¼E	25
52151-V-1/2 & 3/4*	1½	21.0	—	SV	2-½, ¼E	2-½, ¼E	3-½, ¼E	25
52151 CV 3/4*	1½	21.0	—	CV	2-½, ¼E	2-¾	3-½	25
52151 CV 1/2 3/4*	1½	21.0	—	CV	2-½, ¼E	2-¾	3-½	25
52151DV12*	1½	21.0	—	DV	2-½, ¼E	3-½, ¼E	3-½, ¼E	25
521711234E	2½	30.3	—	—	2-½, ¼E	2-½, ¼E	3-½, ¼E	50
521711234EP (With 10½" ground wire)	2½	30.3	—	—	2-½, ¼E	2-½, ¼E	2-½, ¼E	50
52171 MS 1/2 3/4*	2½	30.3	—	MS	2-½, ¼E	2-½, ¼E	3-½, ¼E	25
52171MSP* (With 10½" ground wire)	2½	30.3	—	MS	2-½, ¼E	2-½, ¼E	3-½, ¼E	25
52171 3/4	2½	30.03	—	—	2-¾	2-¾	3-½, 2-¾	50
52171 1	2½	30.03	—	—	2-1	2-1	3-½, 2-¾	50
52171 V 1/2 & 3/4*	2½	30.03	—	SV	2-½, ¼E	2-½, ¼E	3-½, ¼E	25
52171-CV-1/2 & 3/4*	2½	30.03	—	CV	2-½, ¼E	2-½, ¼E	3-½, ¼E	25
52171-EW-SSX*	2½	30.03	—	SSX	—	—	—	—
521711234EP*	2½	30.03	—	v	2-½, ¼E	2-½, ¼E	3-½, ¼E	25
52171-B-1/2 & 3/4	2½	30.03	—	—	2-½, ¼E	2-½, ¼E	3-½, ¼E	25

* All bracketed boxes come complete with eccentric knockouts.
Per UL514A, suitable for use without a bonding jumper in circuits above or below 250 volts. Pigtail wire is #12 AWG insulated, 10½" long.

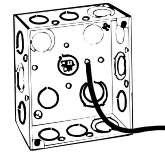

521511234EWP

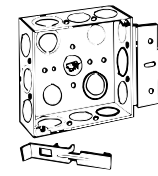

52151 MS 1/2 & 3/4
For use on 1½", 2½", 3½", 4" studs

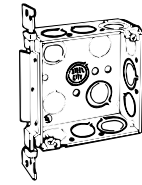

52151-V-1/2 & 3/4
SV Bracket mounted flush

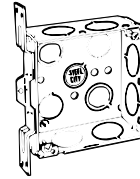

52151 CV 3/4
CV Bracket mounted flush



52151 CV 1/2 3/4
CV Bracket mounted flush

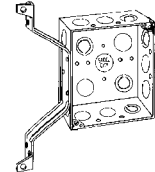

52151DV1/2
DV Bracket provides offset



521711234E



521711234EP



52171 MS 1/2 3/4*
MS bracket for 1½", 2½", 3½", 4", 6" metal studs

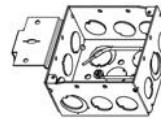

52171MSP

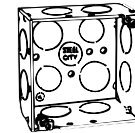

52171 3/4



52171 1



52171 V 1/2 & 3/4
SV bracket mounted flush



52171-CV-1/2 & 3/4
CV bracket mounted flush

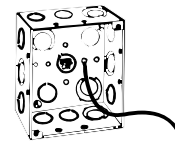

521711234EP

CAT. NO.	DESCRIPTION	EARS	BRACKETS	EACH SIDE KO	EACH END KO	BOTTOM KO	CU. IN. CAPACITY	STD. CTN.
521911234	3½"-deep 4"-square red box	—	—	4 x ½" & ¾" Combo	2 x ½" & ¾" Combo	4 x ½" & ¾" Combo	46	24
521911234CV	3½"-deep 4"-square red box w/side mounting bracket	—	CV	4 x ½" & ¾" Combo	2 x ½" & ¾" Combo	4 x ½" & ¾" Combo	46	10

Square Boxes and Accessories

4" Square Boxes (continued)

CAT. NO.	DEPTH (IN.)	CU. IN. CAPACITY	CLAMPS	BRKTS.	KNOCKOUTS (IN.)				STD. CONDUIT CTN.
					EA. SIDE	EA. END	BOTTOM	STD.	
With Armored Cable/Metal-Clad Clamps									
52151 X	1¼	21.0	C-3	—	2-½, 1-½, ¾E	2	1-½	50	
52151XP	1¼	21.0	C-3	—	2-½, 1-½, ¾E	2	1-½	50	
52151 BX*	1¼	21.0	C-3	B	2-½, 1-½, ¾E	2	1-½	25	
52151 VX*	1¼	21.0	C-3	SV	2-½, 1-½, ¾E	2	1-½	25	
52151 CVX*	1¼	21.0	C-3	CV	2-½, 1-½, ¾E	2	1-½	25	
52151 MS X*	1¼	21.0	C-3	MS	2-½, 1-½, ¾E	2	1-½	25	
For Armored Cable and Metal-Clad Cable Clamps									
52171 X*	2½	30.3	C-3	—	2-½, 1-½, ¾E	2	1-½	25	
52171 MSX*	2½	30.3	C-3	MS	2-½, 1-½, ¾E	2	1-½	25	
52171MSXP (With 10½" ground wire)	2½	30.3	C-3	MS	2-½, 1-½, ¾E	2	1-½	25	
52171-CVX*	2½	30.3	C-3	CV-2	½-¾	—	—	25	

* All bracketed boxes come complete with eccentric knockouts. Per UL514A, suitable for use without a bonding jumper in circuits above or below 250 volts. Pigtail wire is #12 AWG insulated, 10½" long. All 52171 series boxes have a raised ground bump.



52151 X

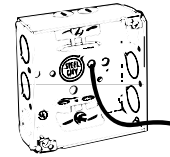

52151XP

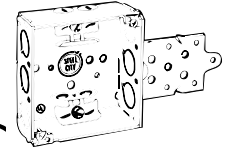

52151 BX*
B bracket
mounted flush

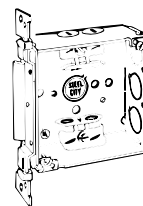

52151 VX*
SV bracket
mounted flush

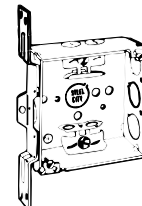

52151 CVX*
CV bracket
mounted flush

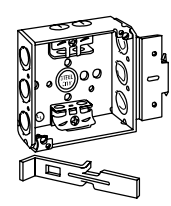

52151 MS X*
MS bracket for 1½",
2½", 3¾", 4" metal studs

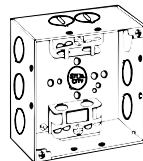

52171 X

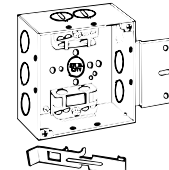

52171 MSX*
MS bracket for 1½",
2½", 3¾", 4" metal studs

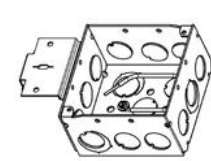

52171MSXP*

CAT. NO.	DESCRIPTION	CLAMPS	EACH SIDE CONDUIT	EACH END CONDUIT	BOTTOM CONDUIT	CU. IN. CAPACITY	STD. PACK.
52171-EW-SSX	2½"-deep with conduit KOs	—	1½", 1½" & ¾"E	2½", 1½" & ¾"E	2½", 2½" & ¾"E	30	20
52151-EF-SSX	1½"-deep with conduit KOs	—	1½", 1½" & ¾"E	2½", 1½" & ¾"E	2½", 2½" & ¾"E	21	20
52171-X-SSX	2½"-deep with armored cable clamps	C3	1½", 1½" & ¾"E	2 Cable	1½"	30	20
52151-X-SSX	1½"-deep with armored cable clamps	C3	1½", 1½" & ¾"E	2 Cable	1½"	21	20
CXLESSX	3½"-deep with armored cable clamps	C3	2½"	1½" & 2 Cable	1½"	15	20

Vapor Tite Boxes

- All K.O.'s pressed flush but still easy to remove
- No holes anywhere
- Top edge of boxes are flush at ears so gasket seals out all air

CAT. NO.	DESCRIPTION	DEPTH	STD. PKG.
52151-SVT	4" Sq. Box, ½" and ¾" K.O. Side and Bottom	1½"	50
52C1-VT	4" Sq. Blank Cover with Gasket	Flat	50
52171-SVT	4" Sq. Box, ½" and ¾" K.O. Side and Bottom	2½"	25
72C1-VT	4½" Sq. Blank Cover with Gasket	Flat	50
72171-SVT	4½" Sq. Box, ½" and ¾" K.O. Side and Bottom	2½"	25
54151-VT	4" Sq. Box, ½" K.O. Side and Bottom	1½"	50
54C1-VT	4" Oct. and Round Box Blank Cover	Flat	50

Square Boxes and Accessories

4" Square Boxes

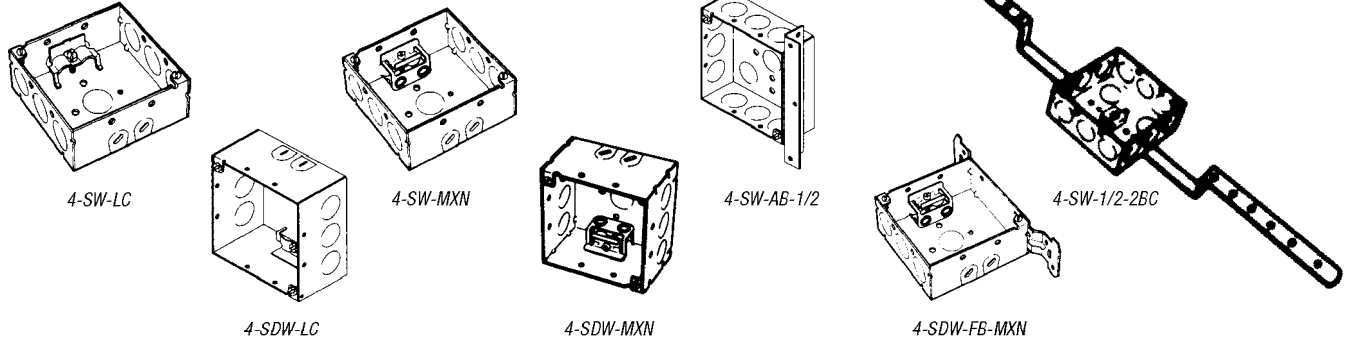

CAT. NO.	DEPTH (IN.)	CU. IN. CAPACITY	DESCRIPTION	CONSTRUCTION TYPE	STD. CTN.
4-SW-LC	1½	21.0	For Non-Metallic Sheathed Cable Two Loom KOs in each of two opposite sides, three ½" KOs in other two sides and one ½" KO in bottom. Two Loom clamps for use on non-metallic sheathed cable with 10/32 deep-slotted screws assembled*	Welded	50
4-SW-MXN	1½	21.0	For Metal-Clad Cable Two Loom KOs in each of two opposite sides, three ½" KOs in other two sides and one ½" KO in bottom. Two MXN clamps for MC, AC/BX and non-metallic sheathed cable (NM) included with 10/32 deep-slotted screws. Clamps are UL Listed for use with cable sizes 14/2 through 10/3 with ground*	Welded	50
4-SW-AB-1/2	1½	21.0	Three KOs in each of three sides, angle bracket on other side, and five ½" KOs in bottom. Angle bracket offset ¾" from top of box*	Welded	50
4-SW-1/2-2BC	1½	21.0	Three ½" KOs in each side and four ½" KOs in bottom. Mounted with clip on 2-BC bar hanger. Hanger is offset correct depth to set box flush with ceiling joist*	Welded	25
4-SDW-LC	2½	30.3	For Non-Metallic Sheathed Cable Two Loom KOs in each of two opposite sides, three ½" KOs in other two sides and one ½" KO in bottom. Two Loom clamps for use on non-metallic sheathed cable with 10/32 deep-slotted screws assembled*	Welded	25
4-SDW-MXN	2½	30.3	For Metal-Clad Cable Two Loom KOs in each of two opposite sides, three ½" KOs in other two sides and one ½" KO in bottom. Two MXN clamps for MC, AC/BX and non-metallic sheathed cable (NM) included with 10/32 deep-slotted screws. Clamps are UL Listed for use with cable sizes 14/2 through 10/3 with ground*	Welded	25
4-SDW-FB-MXN	2½	30.3	For Metal-Clad Cable Two Loom KOs in each of two opposite sides, three ½" KOs in side opposite flat bracket and one ½" KO in bottom. Two MXN clamps for MC, AC/BX and non-metallic sheathed cable (NM) included with 10/32 deep-slotted screws. Clamps are UL Listed for use with cable sizes 14/2 through 10/3 with ground*	Welded	25

*Uses Steel City® 4" square extension rings and 400 series rings and covers.

4" Square Thru-Wall Box



CAT. NO.	DEPTH (IN.)	CU. IN. CAPACITY	KNOCKOUT (IN.)			STD. CTN.
			EA. SIDE CONDUIT	EA. END CONDUIT		
With Conduit KOs						
X1-1/2 & 3/4	1½	21.0	2-½, 1-¾	2-½, 1-¾		25

4" Square Two-Device Boxes

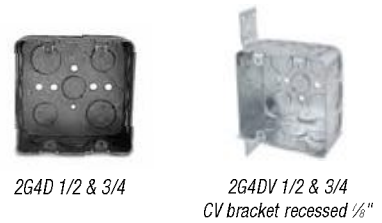

CAT. NO.	DEPTH (IN.)	CU. IN. CAPACITY	BRACKETS	KNOCKOUTS (IN.)			STD. CTN.
				EA. SIDE CONDUIT	EA. END CONDUIT	BOTTOM CONDUIT	
With Conduit KOs							
2G4D 1/2 & 3/4	2½	30.3	—	2-½, 1-¾	2-½, 1-¾	3-½, 2-¾	25
2G4DV 1/2 & 3/4	2½	30.3	CV	2-½, 1-¾	2-½, 1-¾	3-½, 2-¾	25

Square Boxes and Accessories

4" Square Box Partitions

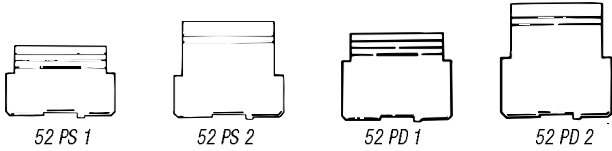

CAT. NO.	DESCRIPTION	STD. CTN.
For 1½" Deep Box with Square-Cut Tile Wall Two-Device Covers		
52 PS 1	For ½", ¾" and 1" raised covers	25
52 PS 2	For 1¼", 1½" and 2" raised covers	25
For 2½" Deep Box with Square-Cut Tile Wall Two-Device Covers		
52 PD 1	For ½", ¾" and 1" raised covers	25
52 PD 2	For 1¼", 1½" and 2" raised covers	25

4" Square Wall Rings

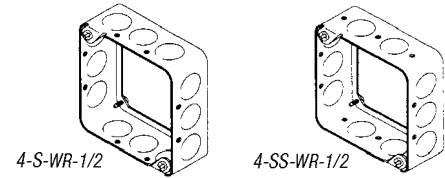

CAT. NO.	DEPTH (IN.)	CU. IN. CAPACITY	DESCRIPTION	CONSTRUCTION TYPE	STD. CTN.
4-S-WR-1/2	1½	21.0	Wall Ring Three ½" KOs in each side. Four 8/32 screws furnished (two in top and two in bottom)*	Drawn	50
4-SS-WR-1/2	1½	18.0	Wall Ring Three ½" KOs in each of two opposite sides, two ½" KOs in other two sides. Four 8/32 screws furnished (two in top and two in bottom)**	Drawn	50

*For use with two Steel City® 403-0 rings for back to back devices in 2" partitions.
**For use with two Steel City® 403-0 rings for back to back devices in 1¾" partitions

4" Square Rings and Covers

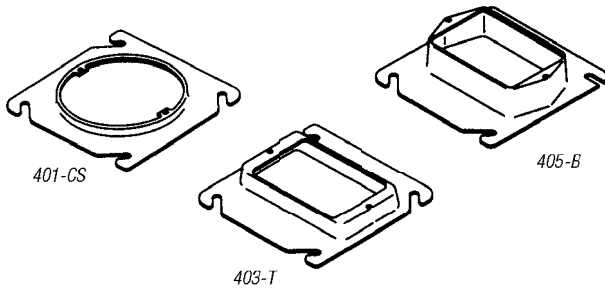

CAT. NO.	CU. IN. CAPACITY	DESCRIPTION	STD. CTN.
401-CS	1.0	¼" raised — 4" square Open plaster ring with ears. Ears tapped 8/32–2 ² / _{32"} on centers. Special screw lock feature in slots*	25
403-T	3.5	Tile Ring, ½" raised — 4" square For single switch or receptacle. Ears tapped 8/32–2 ² / _{32"} on centers*	50
405-B	5.0	⅙" raised — 4" square For single switch or receptacle*	25

*Fits any Steel City® 4" square outlet box or extension ring.

4" Square Industrial Device Covers

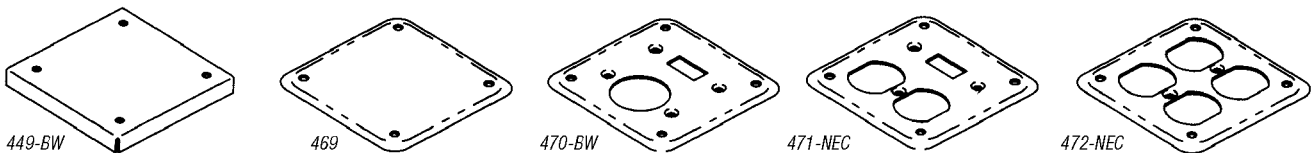

CAT. NO.	DESCRIPTION	STD. CTN.
449-BW	½" raised — 4" square Surface blank. Each cover individually packaged with the necessary screws for mounting*	25
469	⅙" raised — 4" square Surface blank. Each cover individually packaged with the necessary mounting screws*	25
470-BW	⅙" raised — 4" square For one toggle switch and one single receptacle. Opening 1.4" diameter. Each cover individually packaged with the necessary mounting screws*	25
471-NEC	⅙" raised — 4" square For one toggle switch and one duplex receptacle. Each cover individually packaged with the necessary mounting screws*	25
472-NEC	⅙" raised — 4" square For two duplex receptacles. Each cover individually packaged with the necessary mounting screws*	25

*Fits any Steel City® 4" square outlet box or extension ring.

Square Boxes and Accessories

4" Square Industrial Device Covers (continued)

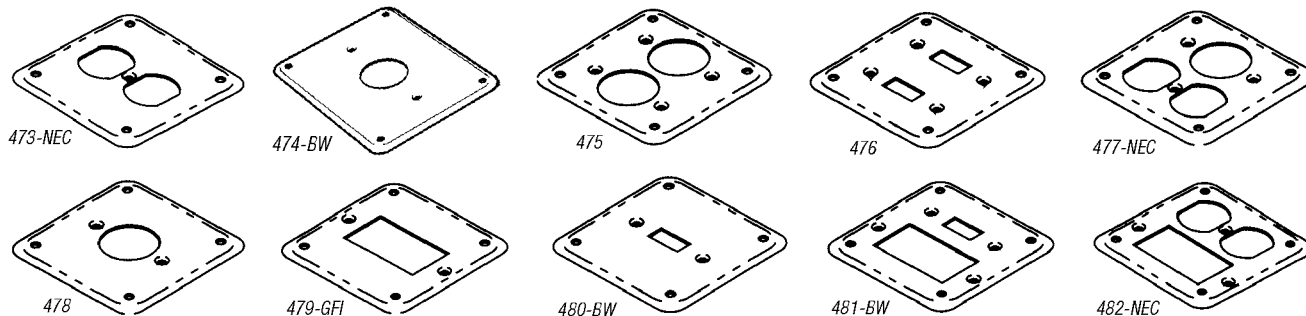

CAT. NO.	DESCRIPTION	STD. CTN.
473-NEC	1/8" raised — 4" square For one duplex receptacle in center. Each cover individually packaged with the necessary mounting screws*	25
474-BW	1/8" raised — 4" square For one single receptacle in center. Opening 1.4" diameter. Each cover individually packaged with the necessary mounting screws*	25
475	1/8" raised — 4" square For two single receptacles. Openings 1.4" diameter. Each cover individually packaged with the necessary mounting screws*	25
476	1/8" raised — 4" square For two toggle switches. Each cover individually packaged with the necessary mounting screws*	25
477-NEC	1/8" raised — 4" square For one duplex and one single receptacle. Opening 1.4" diameter. Each cover individually packaged with the necessary mounting screws*	25
478	1/8" raised — 4" square For one four-wire twist lock receptacle in center. Opening 1.594" diameter. Each cover individually packaged with the necessary mounting screws*	25
479-GFI	1/8" raised — 4" square For one GFI receptacle in center. Each cover individually packaged with the necessary mounting screws*	25
480-BW	1/8" raised — 4" square For one toggle switch in center. Each cover individually packaged with the necessary mounting screws*	25
481-BW	1/8" raised — 4" square For one GFI receptacle and one toggle switch. Each cover individually packaged with the necessary mounting screws*	25
482-NEC	1/8" raised — 4" square For one GFI and one duplex receptacle. Each cover individually packaged with the necessary mounting screws*	25

*Fits any Steel City® 4" square outlet box or extension ring.

4" Square Extension Rings



CAT. NO.	KNOCKOUTS (IN.)		STD. CTN.
	EA. SIDE CONDUIT	EA. END CONDUIT	
1 1/2" Deep — with Conduit KOs — 21.0 Cubic Inch Capacity			
53151 1/2	3-1/2	3-1/2	50
53151 3/4	2-3/4	2-3/4	25
53151 1/2 3/4	2-1/2, 1-3/4	2-1/2, 1-3/4	50
531511234UB**	2-1/2, 1-1/2, 3/4E	2-1/2	50
2 1/8" Deep — with Conduit KOs — 30.3 Cubic Inch Capacity			
531711234*	2-1/2, 1-1/2, 3/4E	2-1/2, 1-3/4	25
53171 1	2-1	2-1	25

* Per UL 514-A, suitable for use without a bonding jumper in circuits above or below 250 volts.

** ECC, KOs on sides.

Square Boxes and Accessories

4" Square-Cut Tile Wall Covers

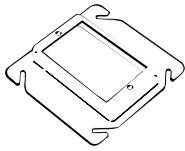

52 C 49 1/2

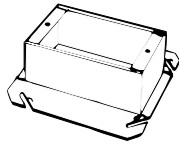

52C5011/2-25

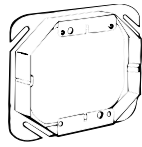

52 C 52 1/2

CAT. NO.	RAISED (IN.)	DESCRIPTION	CU. IN. CAP.	STD. CTN.
For Single Device — Steel				
52 C 49 1/2*	1/2	—	3.5	50
52-C-49-3/4*	3/4	—	5.3	50
52-C-49-1*	1	—	7.0	10
52-C-49-1-1/4	1 1/4	—	9.3	10
52C5011/2-25	1 1/2	—	11.0	25
52C512-25	2	—	14.8	25
For Two Devices — Steel				
52 C 52 1/2	1/2	—	6.0	10
52-C-52-3/4	3/4	—	9.0	10
52-C-52-1	1	Square corners	12.5	10
52-C-52-1-1/4	1 1/4	facilitate tile installation	15.5	10
52 C 53 1 1/2	1 1/2	—	19.0	10
52 C 54 2	2 3/4	—	25.5	10

* Drawn style.

4" Square Covers



52 C 1



52 C 3 1



52 C 6



CAT. NO.	RAISED (IN.)	DESCRIPTION	CU. IN. CAP.	STD. CTN.
52 C 1	—	Flat, blank	—	100
52-C-3-25	3/8	Center blanked with tapped	4.3	25
52-C-3-1/2-25	1/2	ears on 2 3/4" centers	3.5	25
52-C-3-3/4	3/4	Center blanked with	4.3	25
52 C 3 1	1	tapped ears on	5.8	25
52-C-3-1-1/4	1 1/4	2 5/8" centers	7.3	25
52 C 6	—	Flat, with 1/2" KO	—	100

4" Square Device Covers



52 C 16



52 C 19



52 C 21



52 C 0

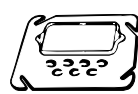

52 C 10



52 C 14



52-C-36

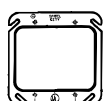

52 C 00



52-C-17-25

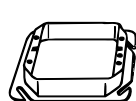

52 C 21

CAT. NO.	RAISED (IN.)	DESCRIPTION	CU. IN. CAP.	STD. CTN.
For Single Device — Steel				
52 C 0	—	Flat	—	25
52 C 62	1/4	Keyed for plaster	1.5	25
52 C 10	1/4	Offset, keyed for plaster	1.0	25
52 C 13	1/2	—	3.0	50
52 C 14	3/4	—	5.0	50
52 C 14 5/8	5/8	—	4.0	50
52 C 15	1	—	7.0	25
52 C 16	1 1/4	—	8.3	25
52-C-36	1/4	For drywall construction	1.0	25
For Two Devices				
52 C 00	—	Flat	—	25
52C20-25	1/4	—	2.3	25
52-C-17-25	1/2	—	6.3	25
52 C 18	3/4	—	9.0	25
52-C-18-5/8-25	5/8	For drywall construction	7.3	25
52 C 19	1	—	12.0	25
52 C 21	1 1/4	—	15.0	25
52 C 37	1/8	—	2.3	25

Square Boxes and Accessories

Box Support Covers

Steel City® Box Support Covers combine a box-to-stud mounting bracket with a device cover in one, easy-to-use product. Designed for use with 4" square boxes, Steel City® Box Support Covers can be used with both steel and wood studs.

- Combines cover and bracket in one component
- Available in one- and two-device versions
- 1/2", 5/8" and 3/4" raised covers
- Speeds installation time
- Needs no far side support
- Can be used with both steel and wood stud
- Can be used without a box as a low voltage device support
- UL and CSA Listed (UL File #E2969, CSA File #LR5043)



52CM13



52CMD17



CAT. NO.	RAISED (IN.)	# OF DEVICES	CU. IN. CAPACITY	STD. CTN.
52CM13	1/2	1	3.0	25
52CM14-5/8	5/8	1	4.0	25
52CM14	3/4	1	5.0	25
52CMD17	1/2	2	6.3	25
52CMD18-5/8	5/8	2	7.3	25
52CMD18	3/4	2	9.0	25

4" Square Surface Covers



RS 4

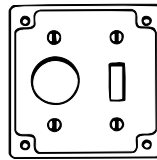

RS 1

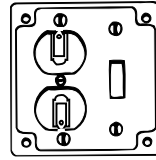

RS 2

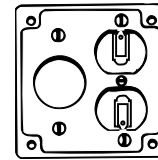

RS 3

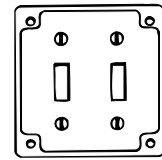

RS 5

CAT. NO.	DEPTH (IN.)	CU. IN. CAPACITY	DIA. HOLE (IN.)	DESCRIPTION	STD. CTN.
RS 1	1/2	5.0	1 1/2	For one toggle switch and one single flush receptacle	50
RS 2*	1/2	5.0	—	For one toggle switch and one duplex flush receptacle	50
RS 3*	1/2	5.0	1 1/2	For one single and one duplex flush receptacle	50
RS 4	1/2	5.0	1 5/8	For one 4-wire twist-lock single receptacle	50
RS 5	1/2	5.0	—	For two toggle switches	50
RS 8*	1/2	5.0	—	For two duplex, flush receptacles	50
RS 9	1/2	5.0	—	For one toggle switch	50
RS 10	1/2	5.0	1 1/2	For two single, flush receptacles	50
RS 11	1/2	5.0	1 1/2	For one single, flush receptacle	50
RS 12*	1/2	5.0	—	For one duplex, flush receptacle	50
RS 13	1/2	5.0	2 3/32	For one 30 or 50 amp. dryer or range receptacle	50
RS 14	1/2	5.0	2 1/2	—	50
RS 15	1/2	5.0	1 3/4	For #3330-30A 250 V twist-lock receptacle	50
RS-16-CC	1/2	5.0	—	For one ground fault receptacle	25
RS-17-CC	1/2	5.0	—	For two ground fault receptacles	25
RS-18-CC	1/2	5.0	—	For one ground fault receptacle and one toggle switch	25
RS-19-CC*	1/2	5.0	—	For one ground fault receptacle and one duplex receptacle	25

Remove portion of G.F.I. receptacle ear to mount receptacle to cover. Screws captivated.

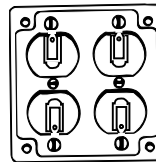

RS 8

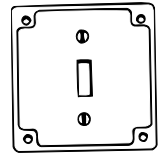

RS 9

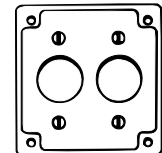

RS 10

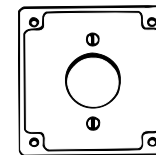

RS 11

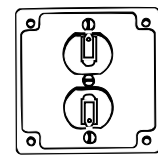

RS 12

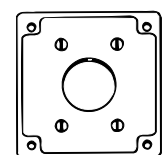

RS 13

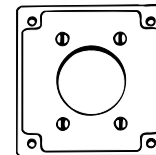

RS 14

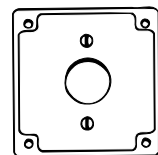

RS 15



RS-16-CC

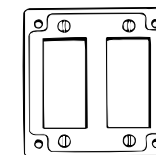

RS-17-CC

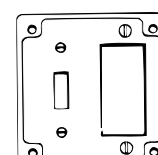

RS-18-CC

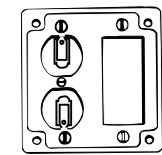

RS-19-CC

Square Boxes and Accessories

UL® Listed Adjustable Mud Ring now available in both single- and two-gang.

Adjustable Mud Rings

Mud Rings feature an inner ring that adjusts from ½" to 1½" in depth to accommodate various drywall thicknesses. Marked with a measured rule and equipped with two adjustment screws, the inner ring can be set to the anticipated depth prior to installation and then easily adjusted after drywall installation to accommodate any variation in depth (½" to 1½").

NEW!



Boxes & Covers — Steel City® Metallic Boxes

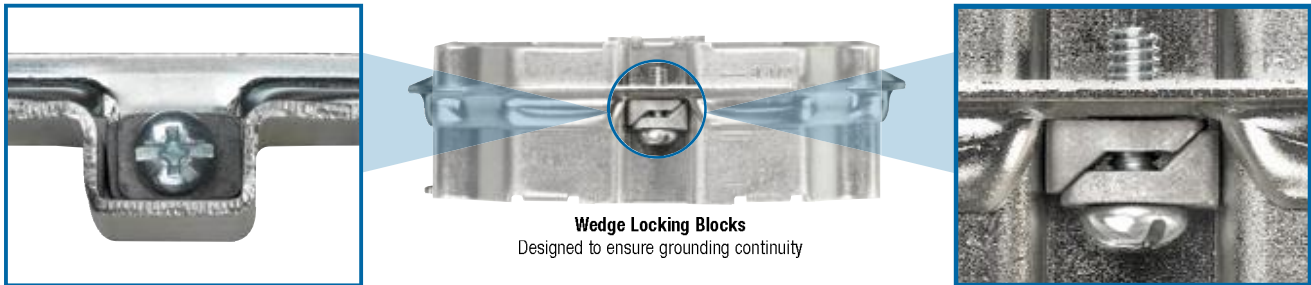

Adjustable Mud Ring Installation/Adjustment Steps:



Loosen...
The two adjustment screws located on opposing corners of the mud ring.



Adjust...
Inner ring to be flush with wall surface.



Re-tighten...
Adjustment screws.



CAT. NO.	DESCRIPTION	STD. CTN.
52-C-ADJ	Single-Gang Adjustable Mud Ring, ½" to 1½"	25
52-C-ADJ2	Two-Gang Adjustable Mud Ring, ½" to 1½"	20

Square Boxes and Accessories

Steel City® Hands-Free Swivel Hanger

The new Steel City® Hands-Free Swivel Hanger allows you to quickly install high- and low-bay lighting fixtures without the need for an extra set of hands. The hanger design enables the fixture to be set in place, giving users access to the conductors while wiring is being completed. The Hands-Free Swivel Hanger can support a fixture up to 50 pounds and is ideal for gyms or other commercial sites.

- Fits standard 3½" or 4" octagon (SHHFR1234)
- Fits 4" square (SHHF1234) boxes
- A single installer can complete the installation — saving time, labor and cost
- Fixtures can be set in place before wiring is completed
- Design enables users to access the conductors after the fixture has been mounted onto the box
- Accommodates ½" or ¾" threaded fixture pipes
- Permits 20° swing from vertical
- Ideal for gyms or other commercial sites

Material: Zinc-plated sheet-metal hanger and malleable iron swivel connector.

Listing: UL and CSA Listed.

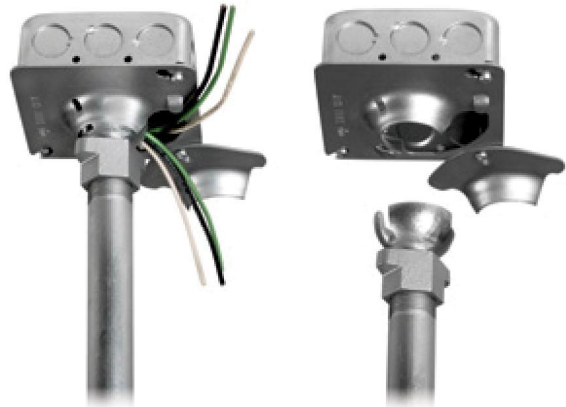

CAT. NO.	DESCRIPTION	STD. CTN.
SHHF 1/2 3/4	Hands-free Swivel Hanger	25
SHHFR 1/2 3/4	Hands-free Swivel Hanger (round)	25

Swivel Hangers



SHR 1/2 & 3/4



CAT. NO.	DESCRIPTION	STD. CTN.
SHR 1/2 & 3/4	Swivel hanger for 4" octagonal boxes	25

UL Listed for 50 lb. fixture support.

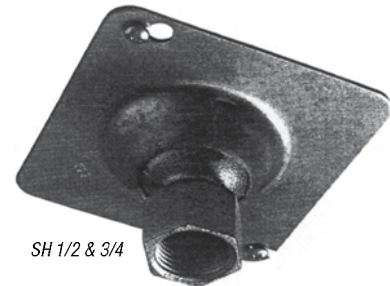

SH 1/2 & 3/4



CAT. NO.	DESCRIPTION	STD. CTN.
SH 1/2 & 3/4	Swivel hanger for 4" square boxes	25

UL Listed for 50 lb. fixture support.

Square Boxes and Accessories

4¹/₁₆" Square Boxes

CAT. NO.	DEPTH (IN.)	CU. IN. CAPACITY	EA. SIDE CONDUIT	EA. END CONDUIT	BOTTOM CONDUIT	STD. CTN.
With Conduit KOs						
72151-1/2 & 3/4-E*	1½	29.5	3-½", ¾- ³³ / ₆₄ "	2-½", ¾- ³³ / ₆₄ "	2-½", ¾"-E, 4-½"	20
72171-1/2 & 3/4-E*	2½	42.0	3-½" & ¾"-E	3-½" & ¾"-E	2-½", ¾"-E, 3-½"	20
72171 1	2½	42.0	*2-1"	2-1"	3-½", 2-¾"	20
72171 3/4 1*	2½	42.0	1-¾", 1-1"	1-¾", 1-1"	3-½", 3-¾", 2-1"	20
72171 1 1/4*	2½	42.0	2-1¼"	1-1¼"	3-½", 2-¾"	20
72171CV 1/2 3/4*	2½	42.0	2-½", 1-¾"	2-½", 1-¾"	3-½", 2-¾"	25
72151 MS 1/2 3/4*	2½	42.0	3-½", ¾- ³³ / ₆₄ "	3-½", ¾- ³³ / ₆₄ "	2-½", ¾- ³³ / ₆₄ ", 3-½"	20
72151 MS 1/2 3/4	2½	42.0	3-½", ¾- ³³ / ₆₄ "	2-½", ¾- ³³ / ₆₄ "	2-½", 2-¾- ³³ / ₆₄ ", 4-½"	25
72171 MS 1/2 3/4*	2½	42.0	3-½", ¾- ³³ / ₆₄ "	3-½", ¾- ³³ / ₆₄ "	2-½", ¾- ³³ / ₆₄ ", 3-½"	25
72151MSX	2½	42.0	3-½", ¾- ³³ / ₆₄ "	2-½", ¾- ³³ / ₆₄ "	2-½", 2-¾- ³³ / ₆₄ ", 4-½"	25
72151MSXP	2½	42.0	3-½", ¾- ³³ / ₆₄ "	2-½", ¾- ³³ / ₆₄ "	2-½", 2-¾- ³³ / ₆₄ ", 4-½"	25
72151MSP	2½	42.0	3-½", ¾- ³³ / ₆₄ "	3-½", ¾- ³³ / ₆₄ "	3-½", 2-½", ¾- ³³ / ₆₄ "	25
72171MSX	2½	42.0	3-½", ¾- ³³ / ₆₄ "	3-½", ¾- ³³ / ₆₄ "	3-½", 2-½", ¾- ³³ / ₆₄ "	25
72171MSXP	2½	42.0	3-½", ¾- ³³ / ₆₄ "	3-½", ¾- ³³ / ₆₄ "	3-½", 2-½", ¾- ³³ / ₆₄ "	25



72171 MS ½ & ¾
MS bracket for 1½", 2½", 3½", 4" metal studs

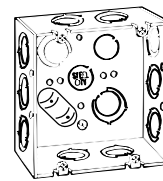

72151-1/2 & 3/4-E



72171-1/2 & 3/4-E

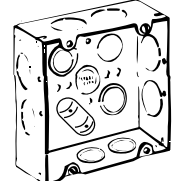

72171 1

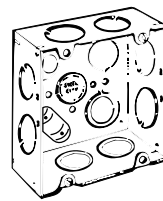

72171 3/4 1

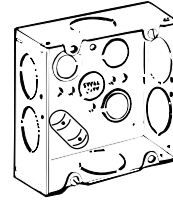

72171 1 1/4

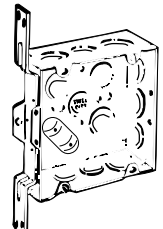

72171CV 1/2 & 3/4

* Per UL 514-A, suitable for use without a bonding jumper in circuits above or below 250 volts.

4¹/₁₆" Square Boxes

CAT. NO.	DEPTH (IN.)	CU. IN. CAPACITY	DESCRIPTION	CONSTRUCTION TYPE	STD. CTN.
5-SDW-FB-1	2½	42.0	Two 1" KOs in each of three sides, flat bracket on other side and three ½" KOs in a line in bottom with two ¾" KOs at opposite ends in bottom. Four tapped ears*	Welded	25

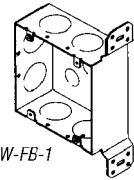

5-SDW-FB-1

4¹/₁₆" Square Box Extension Rings

CAT. NO.	DEPTH (IN.)	CU. IN. CAPACITY	KNOCKOUT (IN.)		STD. CTN.
			EA. SIDE CONDUIT	EA. END CONDUIT	
With Conduit KOs					
73151 1/2 3/4*	1½	29.5	2-½", 1¼"	2-½", 1¼"	20
73171 1/2 3/4*	2½	42.0	2-½", 1¼"	2-½", 1¼"	20
73171 1	2½	42.0	2-1"	2-1"	20

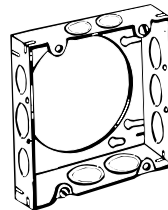

73151 1/2 & 3/4

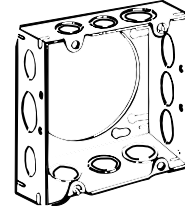

73171 1/2 & 3/4

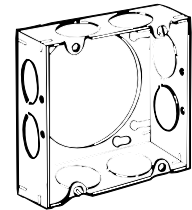

73171 1

4¹/₁₆" Square Covers

CAT. NO.	CU. IN. CAPACITY	RAISED (IN.)	DESCRIPTION	STD. CTN.
72 C 1	—	—	Flat blank	50
72 C 6	—	—	Flat with ½" KO	25
72 C 3	3.5	¾	Center blanked with tapped ears	10
72-C-3-1/2	3.0	½	Center blanked with tapped ears on 2 ³ / ₁₆ " centers	25
72-C-3-3/4	4.3	¾	Center blanked with tapped ears on 2 ³ / ₁₆ " centers	10
72-C-3-1	5.8	1	Center blanked with tapped ears on 2 ³ / ₁₆ " centers	25



72 C 1



72 C 6

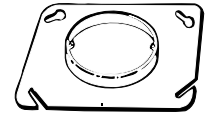

72 C 3

Square Boxes and Accessories

4¹¹/₁₆" Square Rings and Covers

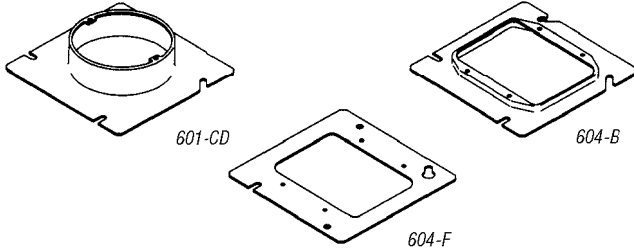

CAT. NO.	CU. IN. CAPACITY	DESCRIPTION	STD. CTN.
601-CD	8.8	1 ¹ / ₄ " raised — 4 ¹¹ / ₁₆ " square Open plaster ring with ears. Ears tapped 8/32—2 ⁹ / ₃₂ " on centers. Special screw lock feature in slots*	25
604-F	—	Flat — 4 ¹¹ / ₁₆ " square For two switches or receptacles*	25
604-B	2.8	1 ¹ / ₄ " raised — 4 ¹¹ / ₁₆ " square For two switches or receptacles*	25

*Fits any Steel City® 4¹¹/₁₆" square outlet box or extension ring.

4¹¹/₁₆" Square Tile Rings

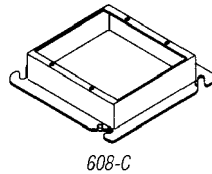

CAT. NO.	CU. IN. CAPACITY	DESCRIPTION	STD. CTN.
608-C	12.5	1" raised — 4 ¹¹ / ₁₆ " square For two switches or receptacles*	10

*Fits any Steel City® 4¹¹/₁₆" square outlet box or extension ring.

4¹¹/₁₆" Square Box Partitions

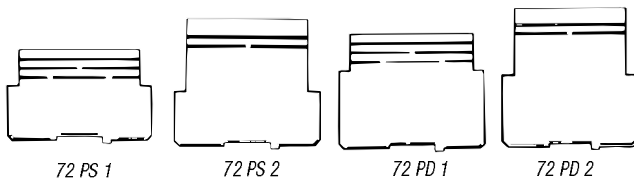

CAT. NO.	DESCRIPTION	STD. CTN.
For 1¹/₂" Deep Box with Square-Cut Tile Wall — Two-Device Covers		
72 PS 1	For 1/2", 3/4" and 1" raised covers	25
72 PS 2	For 1 1/4", 1 1/2" and 2" raised covers	25
For 2 1/4" Deep Box with Square-Cut Tile Wall — Two-Device Covers		
72 PD 1	For 1/2", 3/4" and 1" raised covers	25
72 PD 2	For 1 1/4", 1 1/2" and 2" raised covers	25

4¹¹/₁₆" Square Surface Covers

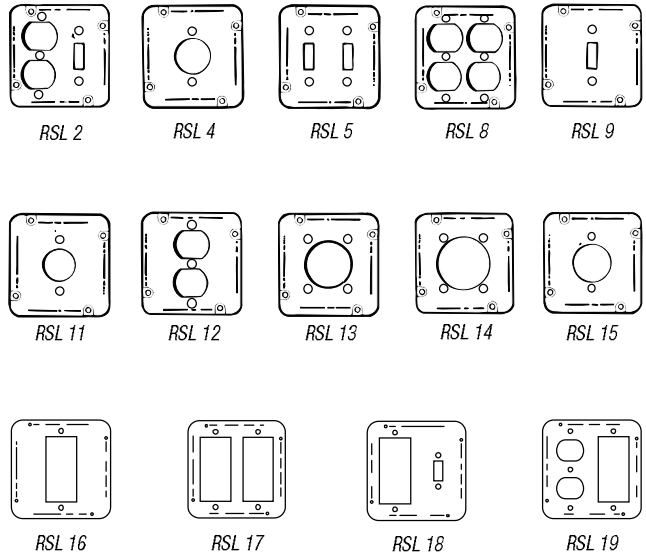

CAT. NO.	DEPTH (IN.)	CU. IN. CAPACITY	DIA. HOLE (IN.)	DESCRIPTION	STD. CTN.
RSL 2	1/2	7.5	—	For one toggle switch and one duplex flush receptacle	10
RSL 4	1/2	7.5	1 1/32	For one 4-wire twist-lock single receptacle	10
RSL 5	1/2	7.5	—	For two toggle switches	10
RSL 8	1/2	7.5	—	For two duplex, flush receptacles	10
RSL 9	1/2	7.5	1 5/32	For one toggle switch	10
RSL 11	1/2	7.5	1 5/64	For one single, flush receptacle	10
RSL 12	1/2	7.5	—	For one duplex, flush receptacle	10
RSL 13	1/2	7.5	2 3/32	For one 30A to 50A dryer or range receptacle	10
RSL 14	1/2	7.5	2 13/32	—	10
RSL 15	1/2	7.5	1 3/4	For #3330—30A 250 V twist-lock receptacle	10
RSL 16	1/2	7.5	—	For one ground fault receptacle	10
RSL 17	1/2	7.5	—	For two ground fault receptacles	10
RSL 18	1/2	7.5	—	For one ground fault receptacle and one toggle switch	10
RSL 19	1/2	7.5	—	For one ground fault receptacle and one duplex receptacle	10

Square Boxes and Accessories

4¹¹/₁₆" Square Device Covers

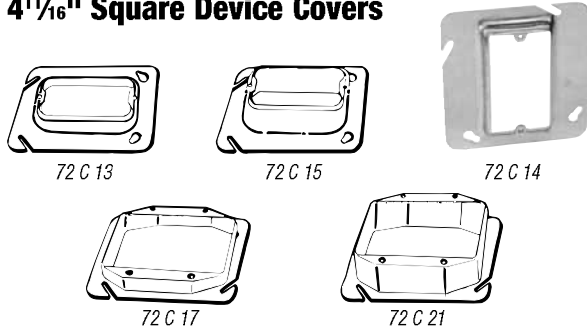

CAT. NO.	RAISED (IN.)	CU. IN. CAPACITY	STD. CTN.
For Single Device			
72 C 62	¼	1.0	25
72 C 13	½	3.0	25
72 C 14	¾	5.0	25
72 C 14 5/8	¾	4.0	25
72 C 15	1	7.0	10
72 C 16	1¼	8.3	10
For Two Devices			
72 C 17	½	6.3	25
72 C 18	¾	9.0	25
72 C 18 5/8	¾	7.5	25
72 C 19	1	12.0	25
72 C 21	1¼	15.0	25

4¹¹/₁₆" Square-Cut Tile Wall Covers

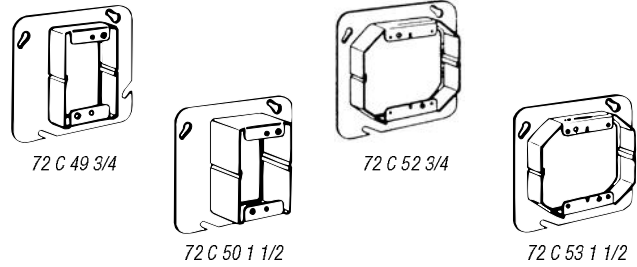

CAT. NO.	RAISED (IN.)	CU. IN. CAPACITY	STD. CTN.
For Single Device — Steel			
72-C-49-1/2	½	3.5	10
72 C 49 3/4	¾	5.3	10
72-C-49-1	1	7.0	10
72-C-49-1-1/4	1¼	7.0	10
72 C 50 1 1/2	1½	9.0	10
72 C 51 2	2	14.5	20
For Two Devices — Steel			
72-C-52-1/2	½	6.0	10
72 C 52 3/4	¾	9.0	10
72-C-52-1	1	12.5	25
72-C-52-1-1/4	1¼	15.5	25
72 C 53 1 1/2	1½	19.0	10
72 C 54 2	2	25.5	10

4¹¹/₁₆" Square Industrial Device Covers

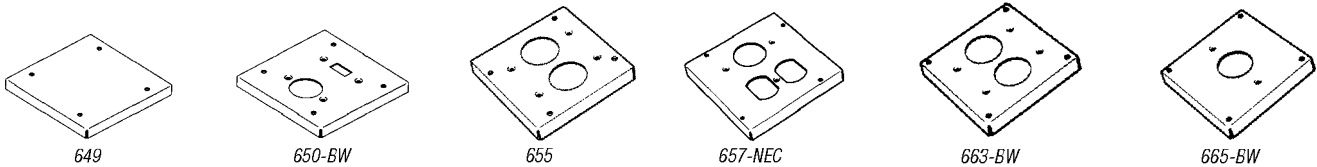

CAT. NO.	CU. IN. CAPACITY	DESCRIPTION	STD. CTN.
649	7.5	½" raised — 4 ¹¹ / ₁₆ " square Surface blank. Each cover individually packaged with the necessary screws for mounting*	10
650-BW	7.5	½" raised — 4 ¹¹ / ₁₆ " square For one toggle switch and one single receptacle. Opening 1.4" diameter. Each cover individually packaged with the necessary screws for mounting*	10
655	7.5	½" raised — 4 ¹¹ / ₁₆ " square For two single receptacles. Opening 1.4" diameter. Each cover individually packaged with the necessary screws for mounting*	10
657-NEC	7.5	½" raised — 4 ¹¹ / ₁₆ " square For one duplex and one single receptacle. Opening 1.4" diameter. Each cover individually packaged with the necessary screws for mounting*	10
663-BW	7.5	½" raised — 4 ¹¹ / ₁₆ " square For two three-wire twist lock receptacles. 1 ¹ / ₁₆ " spacing between 1.4" diameter openings. Each cover individually packaged with the necessary screws for mounting*	10
665-BW	7.5	½" raised — 4 ¹¹ / ₁₆ " square Opening to accommodate Hubbell 3330 receptacle in center. Opening 1.75" diameter. Each cover individually packaged with the necessary screws for mounting*	10

*Fits any Steel City® 4¹¹/₁₆" square outlet box or extension ring.