

## DESCRIPTION

The Vaportite LED Series is an energy efficient industrial Vaportite fixture that features rugged and durable construction. The Vaportite LED incorporates a full metal fixture liner inside a reinforced fiberglass housing with a high impact diffuser. This Vaportite series is suitable for interior and exterior applications and can be surface or chain mounted.

The Vaportite LED Series has been designed for maximum operation in commercial institutional and industrial environments and can operate in a wide range of temperatures (-20°C to 25°C) and is ideal for cold storage environments.

## SPECIFICATION FEATURES

### Construction

Fiberglass housing is reinforced polyester and self-extinguishing (ASTM-D635-74) plastic of a permanent pearl gray color. A watertite hub for 1/2" conduit entry is provided at each end of housing (standard) for continuous feed. Polyurethane gasketing is formed in the housing providing a continuous seamless seal for the diffuser. Four sturdy cam latches clamp diffuser tightly for a positive seal between housing, gasketing and diffuser. Electrical components and fixtures are UL/ cUL listed for Wet Locations.

### Electrical

Long-Life LED system coupled with electrical driver to deliver optimal performance. LED's available in 3500, 4000 and 5000K with a CRI  $\geq$  85. Projected life is 60,000 hours at 91% lumen output. cULus listed. Electronic drivers are available for 120-277V applications. A 0-10V dimming control is available (standard). IP65 rated and NSF certified (4' only).

### Lens

DR=Internal Prismatic Lens/15% DR High Impact Additive.  
DR100=Internal Prismatic Lens/100% DR High Impact Additive.

### Warranty

Vaportite LED features a five year limited warranty.

### Compliance

UL/cUL listed for Wet location. RoHS compliant, and LED modules comply with IESNA LM-79 and LM-80 standards. DesignLights Consortium™ Qualified and classified for DLC Standard, refer to [www.designlights.org](http://www.designlights.org) for details.

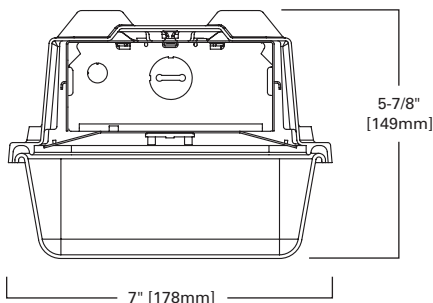

## MOUNTING DATA

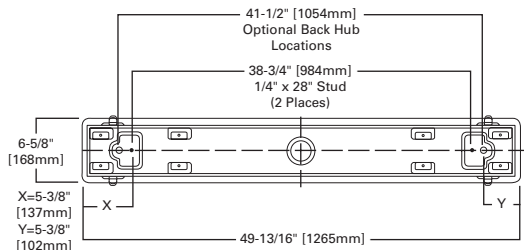

## INSTALLATION DATA

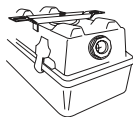

**MOUNTING BRACKETS**  
Furnished  
Two per 2' and 4' Unit  
Four per 8' Unit

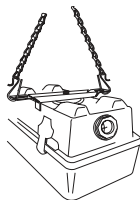

**OPTIONAL CHAN HANGING SET**  
(VT2-CHAIN/SET-U)  
Includes 6 ft. of chain, 4 large S-Hooks and 4 small S-Hooks  
Order One (1) Kit for each 2' or 4' Fixture

Catalog #		Type
Project		
Comments		Date
Prepared by		



## VAPORTITE LED

### 4' INDUSTRIAL LED LAMP

Vaportite Industrial Refrigerated Case



## ENERGY DATA

Input Watts:  
4VT2-LD4-4 (4,000 lumens)=38W  
4VT2-LD4-6 (6,000 lumens)=57.3W  
4VT2-LD4-8 (8,000 lumens)=81.1W

## LINEAR DISCONNECT

Safe and convenient means of disconnecting power



PHOTOMETRICS

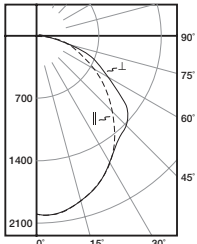

**4VT2-LD4-6-DR-UNV-L835-CD1-U**

Electronic Driver  
 Linear LED 3500K  
 Spacing criterion:  
 (H) 1.2 x mounting  
 height, (L) 1.2 x  
 mounting height  
 Lumens: 5882  
 Input Watts: 56W  
 Efficacy: 104.7 lm/W  
 Test Report:  
 4VT2-LD4-6-DR-  
 UNV-L835-CD1-U.  
 IES

**Candlepower**

Angle	Along H	45°	Across L
0	2000	2000	2000
5	2007	1979	1980
10	1981	1951	1956
15	1930	1900	1903
20	1857	1836	1844
25	1764	1748	1765
30	1645	1646	1660
35	1511	1522	1534
40	1375	1393	1468
45	1221	1271	1438
50	1062	1207	1343
55	903	1175	1148
60	749	1048	933
65	600	1151	771
70	461	591	600
75	332	398	426
80	206	249	255
85	94	137	127
90	34	75	63

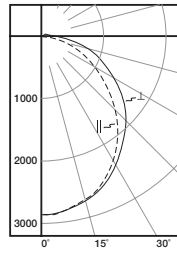

**4VT2-LD4-8-FR50-UNV-L835-CD1-WL-U**

Electronic Driver  
 Linear LED 3500K  
 Spacing criterion:  
 (H) 1.2 x mounting  
 height, (L) 1.3 x  
 mounting height  
 Lumens: 8553  
 Input Watts: 81W  
 Efficacy: 105.5 lm/W  
 Test Report:  
 4VT2-LD4-8-FR50-  
 UNV-L835-CD1-WL-  
 U.IES

**Candlepower**

Angle	Along H	45°	Across L
0	2854	2854	2854
5	2857	2829	2842
10	2811	2790	2804
15	2733	2723	2742
20	2626	2629	2658
25	2484	2508	2545
30	2316	2365	2408
35	2120	2195	2253
40	1904	2011	2086
45	1678	1819	1914
50	1451	1622	1736
55	1222	1422	1558
60	1009	1229	1368
65	810	1034	1171
70	622	843	959
75	446	659	748
80	287	487	555
85	148	341	392
90	45	228	271

**Coefficients of Utilization**

rc rw RCR	Effective floor cavity reflectance 20%																							
	80%				70%				50%				30%				10%				0%			
	70	50	30	10	70	50	30	10	50	30	10	50	30	10	50	30	10	50	30	10	50	30	10	0
0	119	119	119	119	116	116	116	116	110	110	110	105	105	105	101	101	101	99						
1	108	103	98	94	105	101	96	93	96	93	90	92	89	87	88	86	84	82						
2	98	89	82	76	95	87	81	75	84	78	73	80	75	71	77	73	70	67						
3	89	78	70	63	86	76	69	62	73	67	61	70	65	60	68	63	59	56						
4	81	69	60	53	79	68	59	53	65	58	52	62	56	51	60	55	50	48						
5	75	62	52	46	73	60	52	45	58	51	45	56	49	44	54	48	44	41						
6	69	55	46	40	67	54	46	40	52	45	39	51	44	39	49	43	38	36						
7	64	50	41	35	62	49	41	35	48	40	35	46	39	34	45	38	34	32						
8	59	46	37	31	58	45	37	31	44	36	31	42	35	31	41	35	30	28						
9	56	42	34	28	54	41	33	28	40	33	28	39	32	28	38	32	27	25						
10	52	39	31	25	51	38	31	25	37	30	25	36	30	25	35	29	25	23						

**Zonal Lumen Summary**

Zone	Lumens	% Fixture
0-30	1536	26.1
0-40	2490	42.3
0-60	4463	75.9
0-90	5804	98.7
0-180	5882	100.0

**Coefficients of Utilization**

rc rw RCR	Effective floor cavity reflectance 20%																							
	80%				70%				50%				30%				10%				0%			
	70	50	30	10	70	50	30	10	50	30	10	50	30	10	50	30	10	50	30	10	50	30	10	0
0	118	118	118	118	115	115	115	115	109	109	109	104	104	104	99	99	99	96						
1	107	102	97	93	104	99	95	91	94	91	87	90	87	84	85	83	81	79						
2	97	88	81	75	94	86	79	74	82	76	72	78	73	69	74	71	67	65						
3	88	77	69	62	85	75	68	61	72	65	60	69	63	58	66	61	57	54						
4	81	68	59	53	78	67	58	52	64	57	51	61	55	50	59	53	49	46						
5	74	61	52	45	72	60	51	45	57	50	44	55	48	43	53	47	42	40						
6	69	55	46	39	66	54	45	39	52	44	38	50	43	38	48	42	37	35						
7	64	50	41	35	62	49	41	35	47	40	34	45	39	34	44	38	33	31						
8	59	46	37	31	57	45	37	31	43	36	30	42	35	30	40	34	30	28						
9	55	42	34	28	54	41	33	28	40	32	27	38	32	27	37	31	27	25						
10	52	39	31	25	50	38	30	25	37	30	25	36	29	25	34	29	24	23						

**Zonal Lumen Summary**

Zone	Lumens	% Fixture
0-30	2200	25.7
0-40	3573	41.8
0-60	6232	96.4
0-90	8248	100.0
0-180	8553	100.0

**LUMEN MAINTENANCE**

Ambient Temperature	TM-21 Lumen Maintenance (60,000 hours)	Theoretical L70 (Hours)
25°C	> 91%	> 247,000

**ORDERING INFORMATION**

SAMPLE NUMBER: 4VT2-LD4-4-DR-UNV-L840-CD1-WL-U

<p><b>Series</b><sup>(2)</sup> 4VT2=4' Vaportite</p>	<p><b>Distribution</b> [Blank]=Medium (Standard) W=Wide Distribution</p>	<p><b>Lamps</b> L835=3500K, LED L840=4000K, LED L850=5000K, LED</p>	<p><b>WL</b>=Wet Location Label</p>	<p><b>Options</b> SSL=Stainless Steel Latches TH=(2) Top Watertite Hubs TEH=(2) Top and (2) End Watertite Hubs (all Watertite Hubs have 1/2" Conduit Entry)</p>	<p><b>Packaging</b> U=Unit Pack</p>
<p><b>Lamp Type</b> LD4=LED 4.0</p>	<p><b>Voltage</b> UNV=Universal Voltage 120-277</p>	<p><b>Driver Type</b> CD1=1 Dimming Driver 5LTD1=Fifth Light DALI</p>			
<p><b>LED Lumens Output</b> 4=4000 Lumens 6=6000 Lumens 8=8000 Lumens</p>	<p><b>EL10W</b>=10-watt, 120-277V emergency battery pack installed<sup>(3)</sup> <b>VT-REM-EL</b>=Remote Emergency Installed, 700 lumens<sup>(3)</sup></p>				
<p><b>Lens</b> DR=Internal Prismatic Lens/15% DR High Impact Additive DR100=Internal Prismatic Lens/100% DR High Impact Additive FR50=Frosted Lens/15% DR High Impact Additive<sup>(1)</sup></p>					

**Accessories (order separately)**  
**VT2-Chain/Set-U**=Chain Hanging Set  
 Includes 6 ft. of chain, 4 large S-Hooks and 4 small S-Hooks  
 Order One (1) Kit for each 2' or 4' Fixture  
**VT2-SS-MBK**=Stainless Steel Mounting Bracket

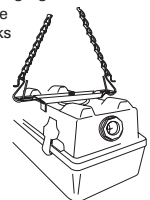

NOTES: <sup>(1)</sup> Not available in wide distribution. <sup>(2)</sup> DesignLights Consortium™ Qualified and classified for DLC Standard (some models are not DLC qualified), refer to www.designlights.org for details. <sup>(3)</sup> EL must specify 120 or 277V only.

Specifications & dimensions subject to change without notice. Consult your Eaton Representative for availability and ordering information.

**SHIPPING DATA**

Catalog No.	Wt.
4VT2-LD4	18 lbs.

## DESCRIPTION

The Vaportite LED Series is an energy efficient industrial Vaportite fixture that features rugged and durable construction. The Vaportite LED incorporates a full metal fixture liner inside a reinforced fiberglass housing with a high impact diffuser. This Vaportite series is suitable for interior and exterior applications and can be surface or chain mounted.

The Vaportite LED Series has been designed for maximum operation in commercial institutional and industrial environments and can operate in a wide range of temperatures (-20°C to 25°C) and is ideal for cold storage environments.

## SPECIFICATION FEATURES

### Construction

Fiberglass housing is reinforced polyester and self-extinguishing (ASTM-D635-74) plastic of a permanent pearl gray color. A watertite hub for 1/2" conduit entry is provided at each end of housing (standard) for continuous feed. Polyurethane gasketing is formed in the housing providing a continuous seamless seal for the diffuser. Four sturdy cam latches clamp diffuser tightly for a positive seal between housing, gasketing and diffuser. Electrical components and fixtures are UL/ cUL listed for Wet Locations.

### Electrical

Long-Life LED system coupled with electrical driver to deliver optimal performance. LED's available in 3500, 4000 and 5000K with a CRI  $\geq$  85. Projected life is 60,000 hours at 91% lumen output. cULus listed. Electronic drivers are available for 120-277V applications. A 0-10V dimming control is available (standard). IP65 rated and NSF certified (4' only).

### Lens

DR=Internal Prismatic Lens/15% DR High Impact Additive.  
DR100=Internal Prismatic Lens/100% DR High Impact Additive.

### Warranty

Vaportite LED features a five year limited warranty.

### Compliance

UL/cUL listed for Wet location. RoHS compliant, and LED modules comply with IESNA LM-79 and LM-80 standards. DesignLights Consortium™ Qualified and classified for DLC Standard, refer to [www.designlights.org](http://www.designlights.org) for details.



## VAPORTITE LED

### 4' INDUSTRIAL LED LAMP

Vaportite Industrial Refrigerated Case

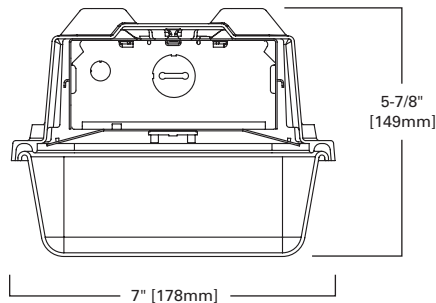

## MOUNTING DATA

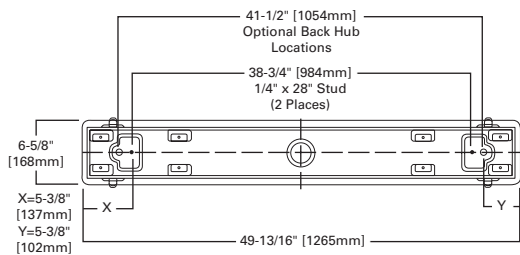

## INSTALLATION DATA

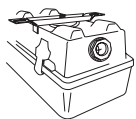

**MOUNTING BRACKETS**  
Furnished  
Two per 2' and 4' Unit  
Four per 8' Unit

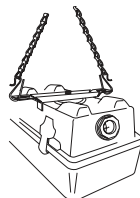

**OPTIONAL CHAN HANGING SET**  
(VT2-CHAIN/SET-U)  
Includes 6 ft. of chain, 4 large S-Hooks and 4 small S-Hooks  
Order One (1) Kit for each 2' or 4' Fixture

## ENERGY DATA

Input Watts:  
4VT2-LD4-4 (4,000 lumens)=38W  
4VT2-LD4-6 (6,000 lumens)=57.3W  
4VT2-LD4-8 (8,000 lumens)=81.1W

## LINEAR DISCONNECT

Safe and convenient means of disconnecting power



PHOTOMETRICS

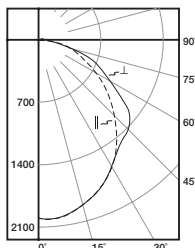

**4VT2-LD4-6-DR-UNV-L835-CD1-U**

Electronic Driver  
 Linear LED 3500K  
 Spacing criterion:  
 (H) 1.2 x mounting  
 height, (L) 1.2 x  
 mounting height  
 Lumens: 5882  
 Input Watts: 56W  
 Efficacy: 104.7 lm/W  
 Test Report:  
 4VT2-LD4-6-DR-  
 UNV-L835-CD1-U.  
 IES

**Candlepower**

Angle	Along H	45°	Across L
0	2000	2000	2000
5	2007	1979	1980
10	1981	1951	1956
15	1930	1900	1903
20	1857	1836	1844
25	1764	1748	1765
30	1645	1646	1660
35	1511	1522	1534
40	1375	1393	1468
45	1221	1271	1438
50	1062	1207	1343
55	903	1175	1148
60	749	1048	933
65	600	1151	771
70	461	591	600
75	332	398	426
80	206	249	255
85	94	137	127
90	34	75	63

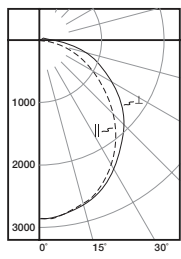

**4VT2-LD4-8-FR50-UNV-L835-CD1-WL-U**

Electronic Driver  
 Linear LED 3500K  
 Spacing criterion:  
 (H) 1.2 x mounting  
 height, (L) 1.3 x  
 mounting height  
 Lumens: 8553  
 Input Watts: 81W  
 Efficacy: 105.5 lm/W  
 Test Report:  
 4VT2-LD4-8-FR50-  
 UNV-L835-CD1-WL-  
 U.IES

**Candlepower**

Angle	Along H	45°	Across L
0	2854	2854	2854
5	2857	2829	2842
10	2811	2790	2804
15	2733	2723	2742
20	2626	2629	2658
25	2484	2508	2545
30	2316	2365	2408
35	2120	2195	2253
40	1904	2011	2086
45	1678	1819	1914
50	1451	1622	1736
55	1222	1422	1558
60	1009	1229	1368
65	810	1034	1171
70	622	843	959
75	446	659	748
80	287	487	555
85	148	341	392
90	45	228	271

**Coefficients of Utilization**

rc rw RCR	Effective floor cavity reflectance 20%																	
	80%			70%			50%			30%			10%			0%		
	70	50	30	70	50	30	70	50	30	70	50	30	70	50	30	0		
0	119	119	119	116	116	116	116	110	110	110	105	105	105	101	101	101	99	
1	108	103	98	94	105	101	96	93	96	93	90	92	89	87	88	86	84	82
2	98	89	82	76	95	87	81	75	84	78	73	80	75	71	77	73	70	67
3	89	78	70	63	86	76	69	62	73	67	61	70	65	60	68	63	59	56
4	81	69	60	53	79	68	59	53	65	58	52	62	56	51	60	55	50	48
5	75	62	52	46	73	60	52	45	58	51	45	56	49	44	54	48	44	41
6	69	55	46	40	67	54	46	40	52	45	39	51	44	39	49	43	38	36
7	64	50	41	35	62	49	41	35	48	40	35	46	39	34	45	38	34	32
8	59	46	37	31	58	45	37	31	44	36	31	42	35	31	41	35	30	28
9	56	42	34	28	54	41	33	28	40	33	28	39	32	28	38	32	27	25
10	52	39	31	25	51	38	31	25	37	30	25	36	30	25	35	29	25	23

**Zonal Lumen Summary**

Zone	Lumens	% Fixture
0-30	1536	26.1
0-40	2490	42.3
0-60	4463	75.9
0-90	5804	98.7
0-180	5882	100.0

**Coefficients of Utilization**

rc rw RCR	Effective floor cavity reflectance 20%																	
	80%			70%			50%			30%			10%			0%		
	70	50	30	70	50	30	70	50	30	70	50	30	70	50	30	0		
0	118	118	118	115	115	115	115	109	109	109	104	104	104	99	99	99	96	
1	107	102	97	93	104	99	95	91	94	91	87	90	87	84	85	83	81	79
2	97	88	81	75	94	86	79	74	82	76	72	78	73	69	74	71	67	65
3	88	77	69	62	85	75	68	61	72	65	60	69	63	58	66	61	57	54
4	81	68	59	53	78	67	58	52	64	57	51	61	55	50	59	53	49	46
5	74	61	52	45	72	60	51	45	57	50	44	55	48	43	53	47	42	40
6	69	55	46	39	66	54	45	39	52	44	38	50	43	38	48	42	37	35
7	64	50	41	35	62	49	41	35	47	40	34	45	39	34	44	38	33	31
8	59	46	37	31	57	45	37	31	43	36	30	42	35	30	40	34	30	28
9	55	42	34	28	54	41	33	28	40	32	27	38	32	27	37	31	27	25
10	52	39	31	25	50	38	30	25	37	30	25	36	29	25	34	29	24	23

**Zonal Lumen Summary**

Zone	Lumens	% Fixture
0-30	2200	25.7
0-40	3573	41.8
0-60	6232	96.4
0-90	8248	100.0
0-180	8553	100.0

**LUMEN MAINTENANCE**

Ambient Temperature	TM-21 Lumen Maintenance (60,000 hours)	Theoretical L70 (Hours)
25°C	> 91%	> 247,000

**ORDERING INFORMATION**

SAMPLE NUMBER: 4VT2-LD4-4-DR-UNV-L840-CD1-WL-U

<p><b>Series</b> <sup>(2)</sup> 4VT2=4' Vaportite</p>	<p><b>Distribution</b> [Blank]=Medium (Standard) W=Wide Distribution</p>	<p><b>Lamps</b> L835=3500K, LED L840=4000K, LED L850=5000K, LED</p>	<p><b>WL</b>=Wet Location Label</p>	<p><b>Options</b> SSL=Stainless Steel Latches TH=(2) Top Watertite Hubs TEH=(2) Top and (2) End Watertite Hubs (all Watertite Hubs have 1/2" Conduit Entry)</p>	<p><b>Packaging</b> U=Unit Pack</p>
<p><b>Lamp Type</b> LD4=LED 4.0</p>	<p><b>Voltage</b> UNV=Universal Voltage 120-277</p>	<p><b>Driver Type</b> CD1=1 Dimming Driver 5LTD1=Fifth Light DALI</p>			
<p><b>LED Lumens Output</b> 4=4000 Lumens 6=6000 Lumens 8=8000 Lumens</p>	<p><b>EL10W</b>=10-watt, 120-277V emergency battery pack installed <sup>(3)</sup> <b>VT-REM-EL</b>=Remote Emergency Installed, 700 lumens <sup>(3)</sup></p>				
<p><b>Lens</b> DR=Internal Prismatic Lens/15% DR High Impact Additive DR100=Internal Prismatic Lens/100% DR High Impact Additive FR50=Frosted Lens/15% DR High Impact Additive <sup>(1)</sup></p>					

**Accessories** (order separately)  
**VT2-Chain/Set-U**=Chain Hanging Set  
 Includes 6 ft. of chain, 4 large S-Hooks and 4 small S-Hooks  
 Order One (1) Kit for each 2' or 4' Fixture  
**VT2-SS-MBK**=Stainless Steel Mounting Bracket

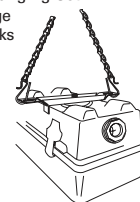

NOTES: <sup>(1)</sup> Not available in wide distribution. <sup>(2)</sup> DesignLights Consortium™ Qualified and classified for DLC Standard (some models are not DLC qualified), refer to www.designlights.org for details. <sup>(3)</sup> EL must specify 120 or 277V only.

Specifications & dimensions subject to change without notice. Consult your Eaton Representative for availability and ordering information.

**SHIPPING DATA**

Catalog No.	Wt.
4VT2-LD4	18 lbs.