

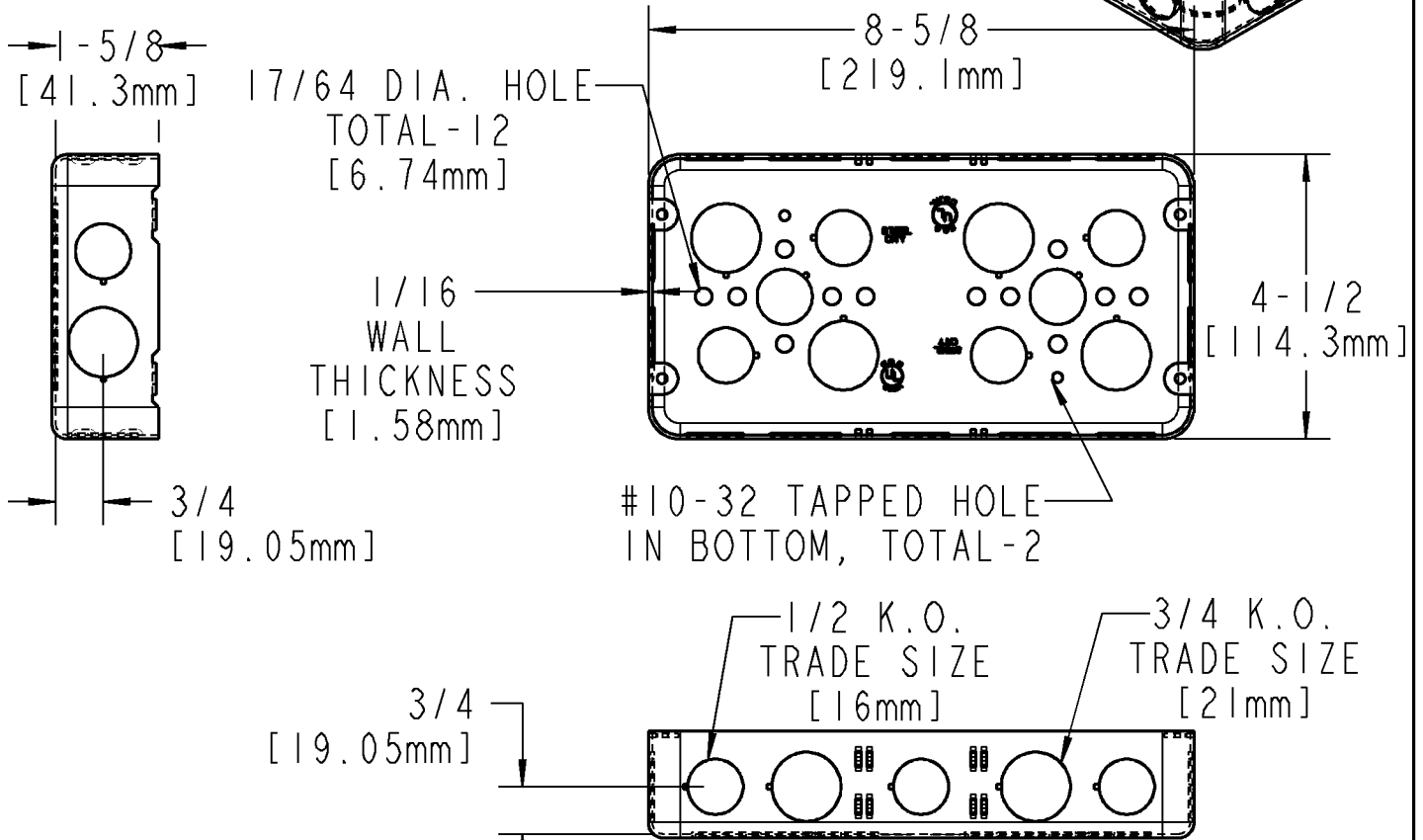

# Thomas & Betts

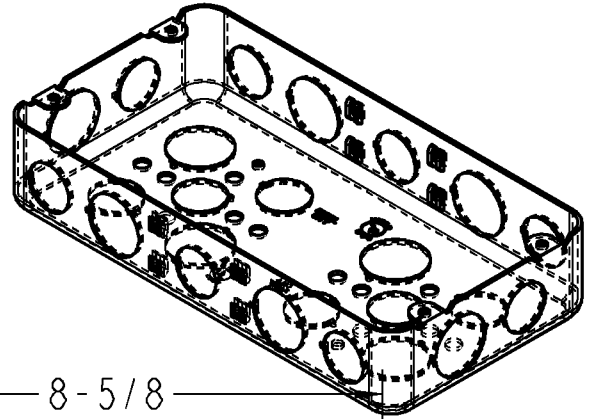

58.0 CU. IN  
[950.4 CU. CM]

**CAT. NO. 3G 1/2 3/4**

TYPE OF K.O.	SIDES	ENDS	BOTTOM	TOTAL
NO. OF 1/2 K.O.'S	6	2	6	14
NO. OF 3/4 K.O.'S	4	2	4	10

**GENERAL NOTES**

- ALL DIMENSIONS ARE FOR REFERENCE ONLY.
- DIMENSIONS IN BRACKETS [ ] ARE IN METRIC UNITS.

www.tnb.com

**Thomas & Betts**  
A Member of the ABB Group

**REVISIONS**

0 SEE ERN (\*\*\*\*) FOR APPROVAL SIGNATURES & RELEASE DATE.  
PROJECT NO: \*\*\*\*

DESCRIPTION:

**3G 1/2 3/4  
GANG BOX**

ORIGINAL PROJECT NO / ( ERN NO )

**NM400367 / ( 2015599 )**

SHEET NO:

**1 OF 1**

REV. NO:

**0**

DRAWING NO:

**WSD-001288**



# Thomas & Betts

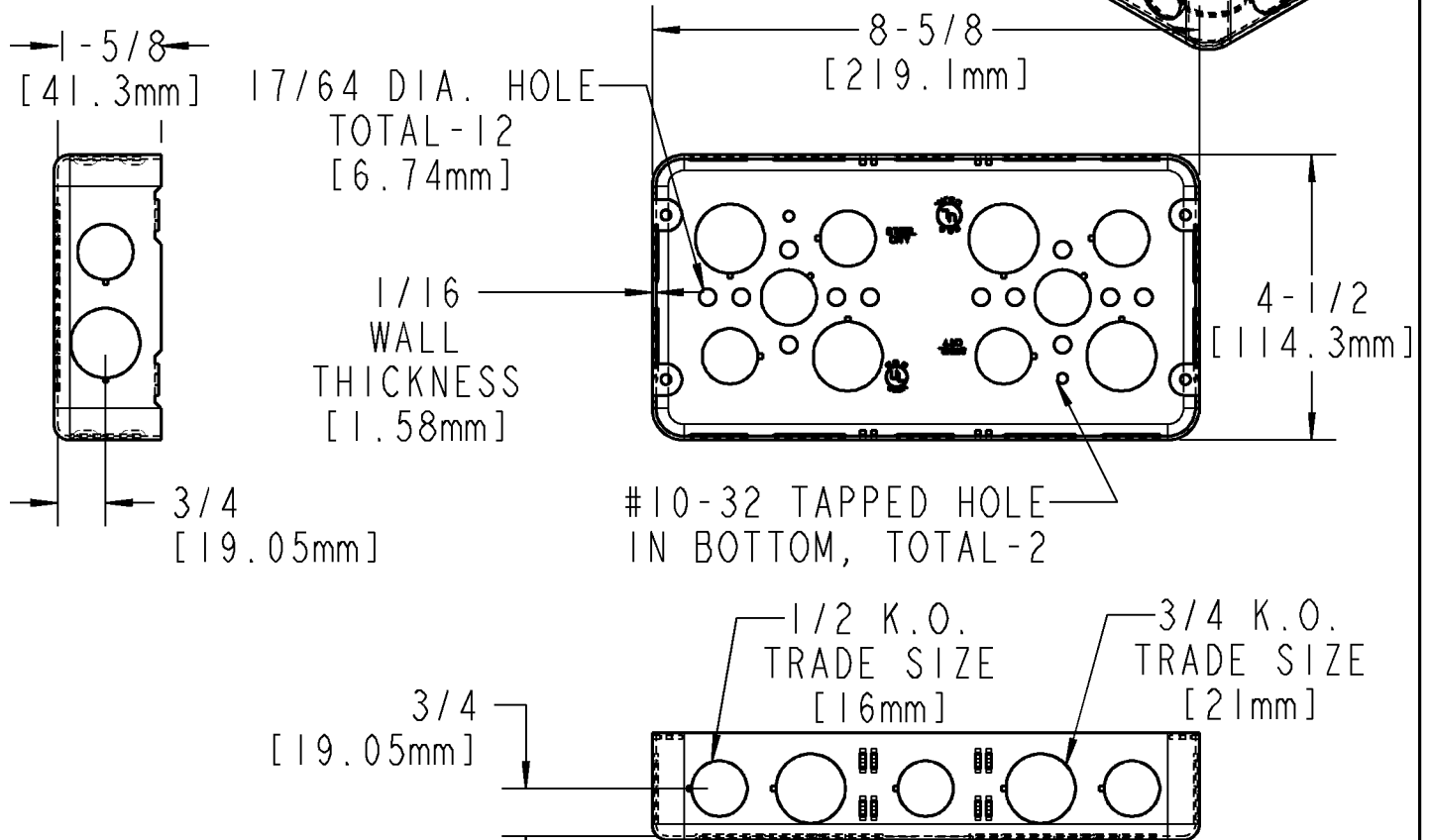
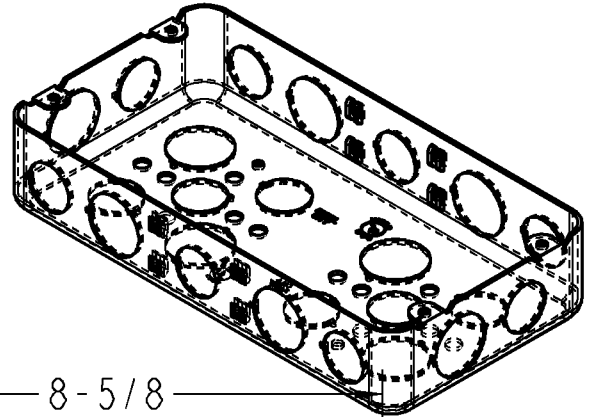

58.0 CU. IN  
[950.4 CU. CM]

**CAT. NO. 3G 1/2 3/4**

TYPE OF K.O.	SIDES	ENDS	BOTTOM	TOTAL
NO. OF 1/2 K.O.'S	6	2	6	14
NO. OF 3/4 K.O.'S	4	2	4	10

**GENERAL NOTES**

- ALL DIMENSIONS ARE FOR REFERENCE ONLY.
- DIMENSIONS IN BRACKETS [ ] ARE IN METRIC UNITS.

www.tnb.com

**Thomas & Betts**  
A Member of the ABB Group

**REVISIONS**

0 SEE ERN (\*\*\*\*) FOR APPROVAL SIGNATURES & RELEASE DATE. PROJECT NO: \*\*\*\*

DESCRIPTION:

**3G 1/2 3/4  
GANG BOX**

ORIGINAL PROJECT NO / ( ERN NO )

**NM400367 / ( 2015599 )**

SHEET NO:

**1 OF 1**

REV. NO:

**0**

DRAWING NO:

**WSD-001288**