

# Metalux AP Series

## DESCRIPTION

The SLSTP is a low profile, high quality luminaire offering the latest solid state lighting and electronic driver technology that optimizes performance and energy efficiency. With the SLSTP's low profile design, this series is an ideal solution for restricted spaces and meets traditional requirements for single or continuous row applications.

The SLSTP is an excellent solution for commercial, industrial, retail or residential applications. Ideal for new construction or simple fluorescent retrofit replacement.

<b>Catalog #</b>		<b>Type</b>
<b>Project</b>		
<b>Comments</b>		<b>Date</b>
<b>Prepared by</b>		

## SPECIFICATION FEATURES

### Construction

Fixture channel, cover and end plates are formed from cold rolled steel and offers all of the features needed for installation including multiple KO, a round J-box cover, wiring connectors and decorative end caps. The SLSTP is post painted for ease of handling. Decorative end caps snap-on for an improved aesthetic finish. The SLSTP is suitable for either single or continuous row applications.

### Controls

Combine with energy saving products like occupancy sensors, daylighting controls, and lighting relay panels to maximize energy savings. Standard 0-10V continuous dimming driver works with any standard 0-10V control/dimmer. Dimming range is 10% to 100% and varies by control device. 120V drivers work with standard 120V phase cut dimmers.

See dimming compatibility chart posted on website. Optional simple occupancy sensors enable code compliance all in a simple package.

### Electrical

Long-Life LED system with an energy-efficient electronic driver comes in UNV (120-277V) or 120V versions. Both drivers offer smooth dimming with a number of residential and commercial dimmers. LED's CCT are 3500K and 4000K with a CRI ≥ 80. Projected life is 50,000 hours at 70% lumen output.

### Finish

Post painted with high reflective paint – standard.

### Shielding

SLSTP offers a frost lens with decorative end caps for single and end of the row applications.

### Installation

Fixture may be surface, suspended, or wall mounted. Multiple 7/8" K.O. on back and one on each end. See accessories below for ordering information.

### Compliance

cULus listed for damp location rated. LED's comply with IESNA LM-79 and LM-80 standards. Under 4", ADA Compliant. DesignLights Consortium® Qualified and classified for DLC Standard, refer to [www.designlights.org](http://www.designlights.org) for details. RoHS compliant. Suitable for use in clothes closets when installed in accordance with the NEC 410.16 spacing requirements.

### Warranty

Five-year warranty.



## SLSTP LENSED LED

Lensed LED Striplight

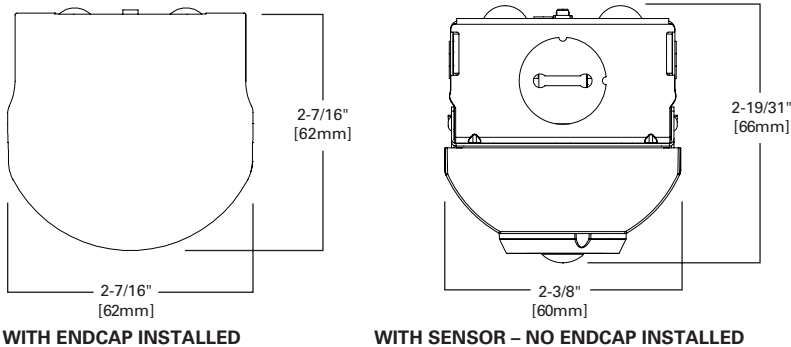

## MOUNTING DATA (SHOWN WITH ENDCAPS)

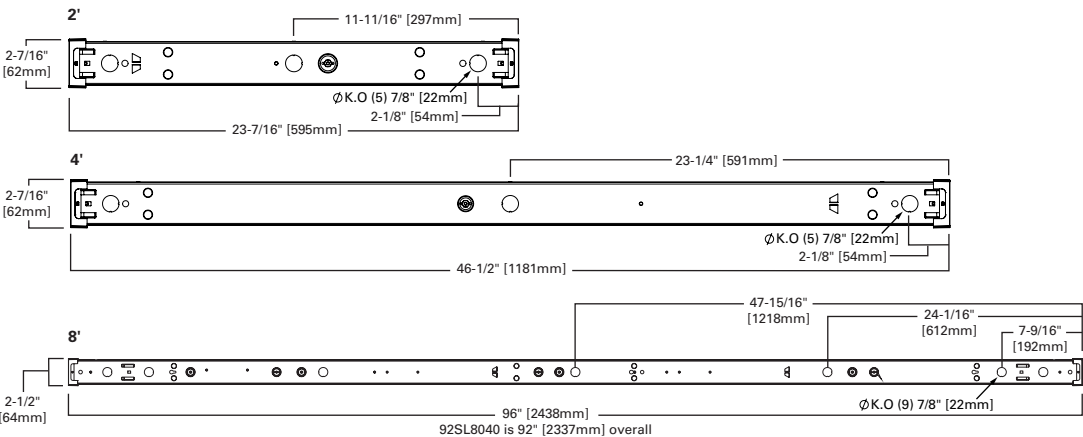

## LOAD DATA

	2'	4'	8'
PF	0.99	0.99	0.98
THD%	13.6	12.9	< 20
Weight	2.8	4.6	9
Low Temp Start	-20C	-20C	-20C

## LINEAR DISCONNECT

Safe and convenient means of disconnecting power



PS519206EN  
 May 29, 2018 3:57 PM



ORDERING INFORMATION

Catalog #	UPC	Master Carton (2 units) UPC	Length	CCT (K)	Delivered Lumens	Watts	Efficacy (lm/W)	Controls	Input Current (A)	
									120V	277V
2SLSTP1040DD-120V	80083705771	80083713363	2	4000	1250	11	113	Phase Cut Dim to 10%	0.09	-
2SLSTP2040DD-120V	80083705788	80083713370	2	4000	2510	23	111	Phase Cut Dim to 10%	0.19	-
4SLSTP2040DD-120V	80083705795	80083713387	4	4000	2579	23	114	Phase Cut Dim to 10%	0.19	-
4SLSTP4040DD-120V	80083705801	80083713394	4	4000	4474	40	112	Phase Cut Dim to 10%	0.33	-
2SLSTP2035DD-UNV	80083814763	80083814770	2	3500	2498	23	110	0-10V Dim to 10%	0.19	0.08
2SLSTP2040DD-UNV	80083807826	80083807833	2	4000	2510	23	111	0-10V Dim to 10%	0.19	0.08
4SLSTP2040DD-UNV	80083705818	80083713400	4	4000	2410	21	113	0-10V Dim to 10%	0.18	0.08
4SLSTP4035DD-UNV	80083807765	80083807772	4	3500	4695	41	115	0-10V Dim to 10%	0.34	0.15
4SLSTP4040DD-UNV	80083705825	80083713417	4	4000	4760	44	109	0-10V Dim to 10%	0.36	0.16
4SLSTP535DD-UNV	80083807802	80083807819	4	3500	5620	49	114	0-10V Dim to 10%	0.41	0.18
4SLSTP5540DD-UNV	80083807789	80083807796	4	4000	5845	49	119	0-10V Dim to 10%	0.41	0.18
8SLSTP11035DD-UNV	80083807703	80083807710	8	3500	10322	83	124	0-10V Dim to 10%	0.7	0.3
8SLSTP11040DD-UNV	80083807680	80083807697	8	4000	10464	83	125	0-10V Dim to 10%	0.7	0.3
8SLSTP8035DD-UNV	80083804368	80083804375	8	3500	8064	71	114	0-10V Dim to 10%	0.59	0.26
8SLSTP8040DD-UNV	80083814787	80083814794	8	4000	8176	71	115	0-10V Dim to 10%	0.59	0.26
4SLSTP4040CS	80083807741	80083807758	4	4000	4835	41	118	0-10V Dim to 10% and simple occupancy sensor	0.34	0.15
8SLSTP8040CS	80083807727	80083807734	8	4000	8304	72	115	0-10V Dim to 10% and simple occupancy sensor	0.6	0.26
8SL8040	80083807925	80083807932	8	4000	8176	71	115	0-10V Dim to 10%	0.62	0.27
92SL8040	80083807956	80083802876	92"	4000	7866	74	106	0-10V Dim to 10%	0.62	0.27

ACCESSORIES (ORDER SEPARATELY) NOT FOR USE WITH 92SL8040

ROW ALIGNER 8' - 8'

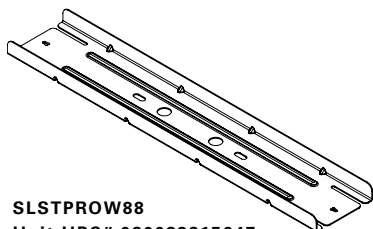

**SLSTPROW88**  
 Unit UPC# 080083815647  
 Master Carton UPC# 080083815654  
 (50 per Master)

ROW ALIGNER 8' - 4'

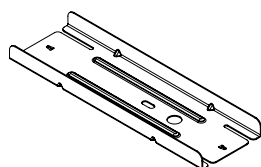

**SLSTPROW842**  
 Unit UPC# 080083815661  
 Master Carton UPC# 080083815678  
 (100 per Master)

**AYC-CHAIN/SET=36"** Hanging Chain Set w/V Hooks  
**TOGGLE-10=10'** Suspension Aircraft Cable Kit (specify if another length needed)  
**SCF-12-B=12"** Fixed Stem Set (specify if another length needed)  
**2SLSTPLNS=2 ft.** Replacement Lens  
**4SLSTPLNS=4 ft.** Replacement Lens  
**8SLSTPLNS=8 ft.** Replacement Lens

SENSOR COVERAGE ("CS" SKU DESIGNATION)

SENSOR COVERAGE PATTERN TOP VIEW

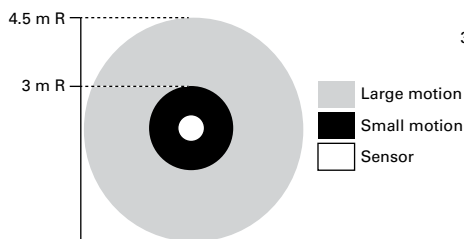

SENSOR COVERAGE PATTERN SIDE VIEW

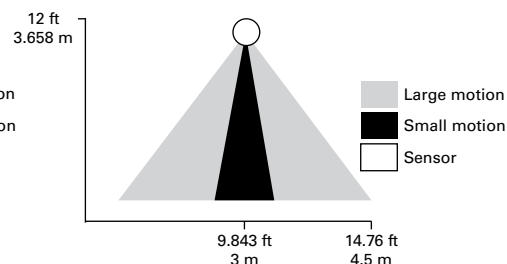

LIGHT OUTPUT VERSUS TIME

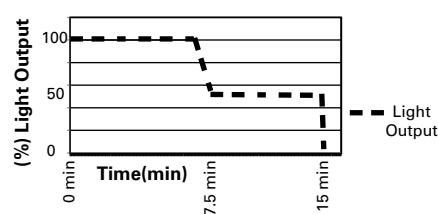

SHIPPING DATA

Catalog Base	Wt.	Units per Pallet
2SLSTP	2.8 lbs.	144
4SLSTP	4.6 lbs.	72
8SLSTP	9 lbs.	45

# Metalux AP Series

## DESCRIPTION

The SLSTP is a low profile, high quality luminaire offering the latest solid state lighting and electronic driver technology that optimizes performance and energy efficiency. With the SLSTP's low profile design, this series is an ideal solution for restricted spaces and meets traditional requirements for single or continuous row applications.

The SLSTP is an excellent solution for commercial, industrial, retail or residential applications. Ideal for new construction or simple fluorescent retrofit replacement.

<b>Catalog #</b>		<b>Type</b>
<b>Project</b>		
<b>Comments</b>		<b>Date</b>
<b>Prepared by</b>		

## SPECIFICATION FEATURES

### Construction

Fixture channel, cover and end plates are formed from cold rolled steel and offers all of the features needed for installation including multiple KO, a round J-box cover, wiring connectors and decorative end caps. The SLSTP is post painted for ease of handling. Decorative end caps snap-on for an improved aesthetic finish. The SLSTP is suitable for either single or continuous row applications.

### Controls

Combine with energy saving products like occupancy sensors, daylighting controls, and lighting relay panels to maximize energy savings. Standard 0-10V continuous dimming driver works with any standard 0-10V control/dimmer. Dimming range is 10% to 100% and varies by control device. 120V drivers work with standard 120V phase cut dimmers.

See dimming compatibility chart posted on website. Optional simple occupancy sensors enable code compliance all in a simple package.

### Electrical

Long-Life LED system with an energy-efficient electronic driver comes in UNV (120-277V) or 120V versions. Both drivers offer smooth dimming with a number of residential and commercial dimmers. LED's CCT are 3500K and 4000K with a CRI ≥ 80. Projected life is 50,000 hours at 70% lumen output.

### Finish

Post painted with high reflective paint – standard.

### Shielding

SLSTP offers a frost lens with decorative end caps for single and end of the row applications.

### Installation

Fixture may be surface, suspended, or wall mounted. Multiple 7/8" K.O. on back and one on each end. See accessories below for ordering information.

### Compliance

cULus listed for damp location rated. LED's comply with IESNA LM-79 and LM-80 standards. Under 4", ADA Compliant. DesignLights Consortium® Qualified and classified for DLC Standard, refer to [www.designlights.org](http://www.designlights.org) for details. RoHS compliant. Suitable for use in clothes closets when installed in accordance with the NEC 410.16 spacing requirements.

### Warranty

Five-year warranty.



## SLSTP LENSED LED

Lensed LED Striplight

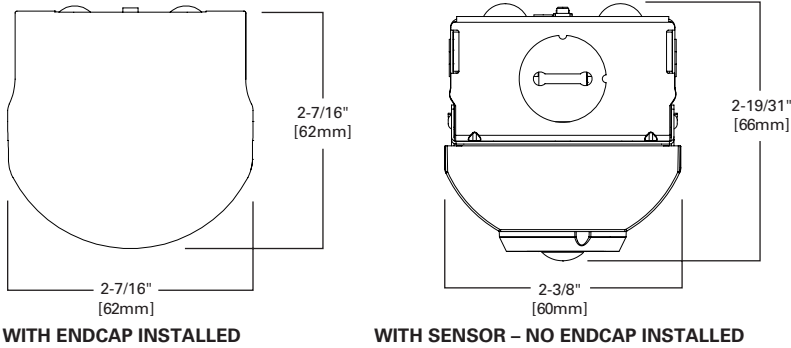

## MOUNTING DATA (SHOWN WITH ENDCAPS)

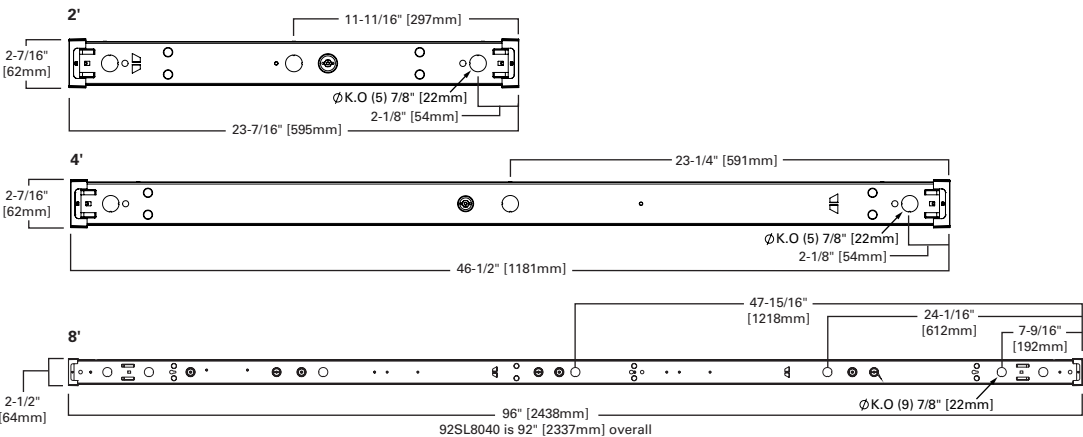

## LOAD DATA

	2'	4'	8'
PF	0.99	0.99	0.98
THD%	13.6	12.9	< 20
Weight	2.8	4.6	9
Low Temp Start	-20C	-20C	-20C

## LINEAR DISCONNECT

Safe and convenient means of disconnecting power



PHOTOMETRICS

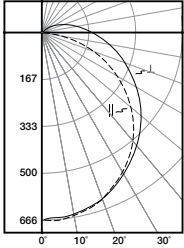

4SLSTP2040DD-UNV

Electronic Driver
Linear LED 4000K
Spacing criterion: (II) 1.26 x mounting height, (L) 1.29 x mounting height
Lumens: 2410
Input Watts: 21.3W
Efficacy:113.1 lm/W
Test Report: 4SLSTP2040DD-UNV.IES

Candlepower

Table with columns: Angle, Along II, 45°, Across ⊥. Rows 0-90 degrees.

Coefficients of Utilization

Table showing effective floor cavity reflectance (80%, 70%, 20%, 50%, 30%, 10%, 0%) and RCR values for various zones.

Zonal Lumen Summary

Table with columns: Zone, Lumens, % Fixture. Rows 0-30, 0-40, 0-60, 0-90, 0-180.

Luminance Data

Table with columns: Angle in Deg, Average 0-Deg cd/sm, Average 45-Deg cd/sm, Average 90-Deg cd/sm. Rows 45, 55, 65, 75, 85.

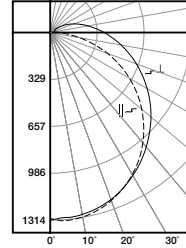

4SLSTP4040DD-UNV

Electronic Driver
Linear LED 4000K
Spacing criterion: (II) 1.27 x mounting height, (L) 1.29 x mounting height
Lumens: 4760
Input Watts: 43.5W
Efficacy: 109.4 lm/W
Test Report: 4SLSTP4040DD-UNV.IES

Candlepower

Table with columns: Angle, Along II, 45°, Across ⊥. Rows 0-90 degrees.

Coefficients of Utilization

Table showing effective floor cavity reflectance (80%, 70%, 20%, 50%, 30%, 10%, 0%) and RCR values for various zones.

Zonal Lumen Summary

Table with columns: Zone, Lumens, % Fixture. Rows 0-30, 0-40, 0-60, 0-90, 0-180.

Luminance Data

Table with columns: Angle in Deg, Average 0-Deg cd/sm, Average 45-Deg cd/sm, Average 90-Deg cd/sm. Rows 45, 55, 65, 75, 85.

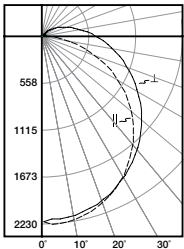

8SLSTP8040DD-UNV

Electronic Driver
Linear LED 4000K
Spacing criterion: (II) 1.28 x mounting height, (L) 1.30 x mounting height
Lumens: 8176
Input Watts: 71W
Efficacy:115 lm/W
Test Report: 8SLSTP8040DD-UNV.IES

Candlepower

Table with columns: Angle, Along II, 45°, Across ⊥. Rows 0-90 degrees.

Coefficients of Utilization

Table showing effective floor cavity reflectance (80%, 70%, 20%, 50%, 30%, 10%, 0%) and RCR values for various zones.

Zonal Lumen Summary

Table with columns: Zone, Lumens, % Fixture. Rows 0-30, 0-40, 0-60, 0-90, 0-180.

Luminance Data

Table with columns: Angle in Deg, Average 0-Deg cd/sm, Average 45-Deg cd/sm, Average 90-Deg cd/sm. Rows 45, 55, 65, 75, 85.

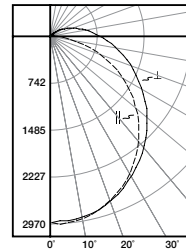

8SLSTP11040DD-UNV

Electronic Driver
Linear LED 4000K
Spacing criterion: (II) 1.26 x mounting height, (L) 1.28 x mounting height
Lumens: 10476
Input Watts: 83.4W
Efficacy: 126 lm/W
Test Report: 8SLSTP11040DD-UNV.IES

Candlepower

Table with columns: Angle, Along II, 45°, Across ⊥. Rows 0-90 degrees.

Coefficients of Utilization

Table showing effective floor cavity reflectance (80%, 70%, 20%, 50%, 30%, 10%, 0%) and RCR values for various zones.

Zonal Lumen Summary

Table with columns: Zone, Lumens, % Fixture. Rows 0-30, 0-40, 0-60, 0-90, 0-180.

Luminance Data

Table with columns: Angle in Deg, Average 0-Deg cd/sm, Average 45-Deg cd/sm, Average 90-Deg cd/sm. Rows 45, 55, 65, 75, 85.

ORDERING INFORMATION

Catalog #	UPC	Master Carton (2 units) UPC	Length	CCT (K)	Delivered Lumens	Watts	Efficacy (lm/W)	Controls	Input Current (A)	
									120V	277V
2SLSTP1040DD-120V	80083705771	80083713363	2	4000	1250	11	113	Phase Cut Dim to 10%	0.09	-
2SLSTP2040DD-120V	80083705788	80083713370	2	4000	2510	23	111	Phase Cut Dim to 10%	0.19	-
4SLSTP2040DD-120V	80083705795	80083713387	4	4000	2579	23	114	Phase Cut Dim to 10%	0.19	-
4SLSTP4040DD-120V	80083705801	80083713394	4	4000	4474	40	112	Phase Cut Dim to 10%	0.33	-
2SLSTP2035DD-UNV	80083814763	80083814770	2	3500	2498	23	110	0-10V Dim to 10%	0.19	0.08
2SLSTP2040DD-UNV	80083807826	80083807833	2	4000	2510	23	111	0-10V Dim to 10%	0.19	0.08
4SLSTP2040DD-UNV	80083705818	80083713400	4	4000	2410	21	113	0-10V Dim to 10%	0.18	0.08
4SLSTP4035DD-UNV	80083807765	80083807772	4	3500	4695	41	115	0-10V Dim to 10%	0.34	0.15
4SLSTP4040DD-UNV	80083705825	80083713417	4	4000	4760	44	109	0-10V Dim to 10%	0.36	0.16
4SLSTP535DD-UNV	80083807802	80083807819	4	3500	5620	49	114	0-10V Dim to 10%	0.41	0.18
4SLSTP5540DD-UNV	80083807789	80083807796	4	4000	5845	49	119	0-10V Dim to 10%	0.41	0.18
8SLSTP11035DD-UNV	80083807703	80083807710	8	3500	10322	83	124	0-10V Dim to 10%	0.7	0.3
8SLSTP11040DD-UNV	80083807680	80083807697	8	4000	10464	83	125	0-10V Dim to 10%	0.7	0.3
8SLSTP8035DD-UNV	80083804368	80083804375	8	3500	8064	71	114	0-10V Dim to 10%	0.59	0.26
8SLSTP8040DD-UNV	80083814787	80083814794	8	4000	8176	71	115	0-10V Dim to 10%	0.59	0.26
4SLSTP4040CS	80083807741	80083807758	4	4000	4835	41	118	0-10V Dim to 10% and simple occupancy sensor	0.34	0.15
8SLSTP8040CS	80083807727	80083807734	8	4000	8304	72	115	0-10V Dim to 10% and simple occupancy sensor	0.6	0.26
8SL8040	80083807925	80083807932	8	4000	8176	71	115	0-10V Dim to 10%	0.62	0.27
92SL8040	80083807956	80083802876	92"	4000	7866	74	106	0-10V Dim to 10%	0.62	0.27

ACCESSORIES (ORDER SEPARATELY) NOT FOR USE WITH 92SL8040

ROW ALIGNER 8' - 8'

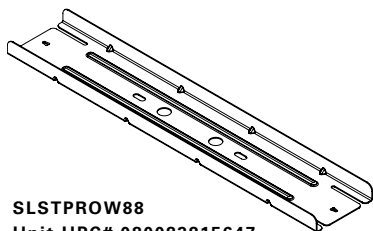

**SLSTPROW88**  
 Unit UPC# 080083815647  
 Master Carton UPC# 080083815654  
 (50 per Master)

ROW ALIGNER 8' - 4'

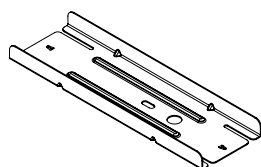

**SLSTPROW842**  
 Unit UPC# 080083815661  
 Master Carton UPC# 080083815678  
 (100 per Master)

**AYC-CHAIN/SET=36"** Hanging Chain Set w/V Hooks  
**TOGGLE-10=10'** Suspension Aircraft Cable Kit (specify if another length needed)  
**SCF-12-B=12"** Fixed Stem Set (specify if another length needed)  
**2SLSTPLNS=2 ft.** Replacement Lens  
**4SLSTPLNS=4 ft.** Replacement Lens  
**8SLSTPLNS=8 ft.** Replacement Lens

SENSOR COVERAGE ("CS" SKU DESIGNATION)

SENSOR COVERAGE PATTERN TOP VIEW

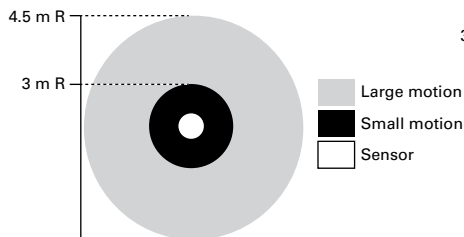

SENSOR COVERAGE PATTERN SIDE VIEW

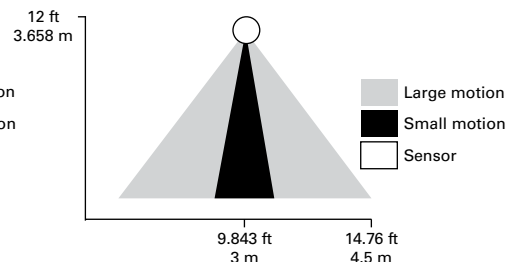

LIGHT OUTPUT VERSUS TIME

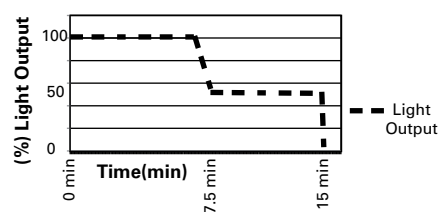

SHIPPING DATA

Catalog Base	Wt.	Units per Pallet
2SLSTP	2.8 lbs.	144
4SLSTP	4.6 lbs.	72
8SLSTP	9 lbs.	45



Eaton  
 1121 Highway 74 South  
 Peachtree City, GA 30269  
 P: 770-486-4800  
 www.eaton.com/lighting

Specifications and dimensions subject to change without notice.