

## Red•Dot® metallic weatherproof covers

### Technical Specifications



#### Applications :

- Protects receptacles, switches, and plugs for single gang and two gang configurations in dry and wet locations
- Provides a lockable cover that complies with OSHA lockout/tagout requirements
- Prevents accidental equipment disconnects, reduces tampering, and deters theft and equipment removal

#### Features/Benefits :

- Alloy A360 copper-free (less than 0.004 copper content) aluminum provides increased corrosion resistance
- Die cast, metal construction provides long lasting durability
- NEMA 3R rating ensures protection against falling rain, sleet, and external ice formation when used with appropriate device boxes
- Clear UL and CSA markings speed approval by inspectors
- Wide range of cover depths and receptacle configurations accommodate almost every common plug and cord size
- Combination box or device mounting design provides flexibility in installation

#### Standard Materials :

- Covers and Plates: Die cast aluminum alloy A360
- Gaskets: Closed-cell foam

#### Standard Finish :

- Powder coated finish

#### Compliances :

Compliances as noted on each page of the catalogue in clude:

- CSA Certified
- UL Listed

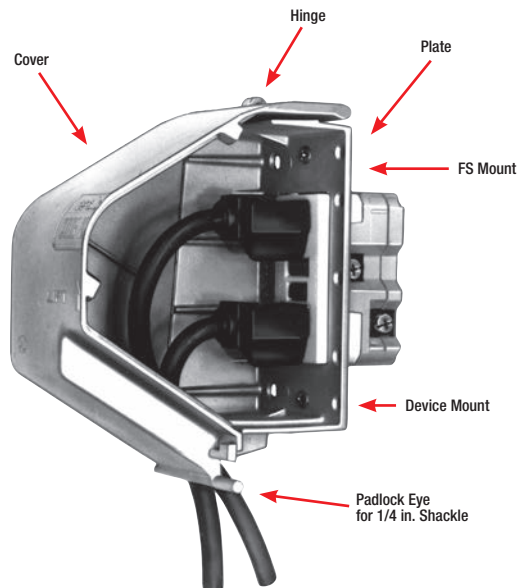

## Red•Dot® metallic weatherproof covers



Duplex



GFCI



Single Receptacle



Switch



Cat. No.	Description
<b>Single Gang Cover – 2-1/4 in. Internal Depth (Aluminum)</b>	
<b>CKSUU</b>	Small vertical cover universal code keeper accommodates duplex, GFCI, single receptacle and toggle switch – lockable

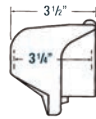

Duplex



GFCI



Single Receptacle



Switch

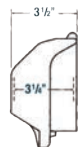

Duplex



GFCI



Single Receptacle



Switch



Cat. No.	Description
<b>Single Gang Cover – 3-1/4 in. Internal Depth (Aluminum)</b>	
<b>CKMU</b>	Medium horizontal cover universal code keeper accommodates duplex, GFCI, single receptacle and toggle switch – lockable
<b>CKMUV</b>	Medium vertical cover universal code keeper accommodates duplex, GFCI, single receptacle and toggle switch – lockable

**Red•Dot® metallic weatherproof covers**

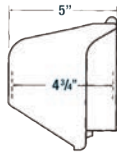

Single Receptacle



Cat. No.	Description
<b>Single Gang Cover – 4-3/4 in. Internal Depth (Aluminum)</b>	
<b>CKLSVU</b>	Large vertical cover – Box mount universal code keeper with adapter rings to accommodate 1-19/32 in. and 1-3/4 in. single receptacles – lockable

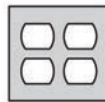
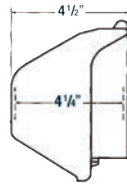

Two duplex receptacle

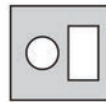

Single and GFCI receptacle

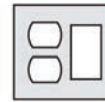

Duplex and GFCI receptacle



Toggle and duplex receptacle

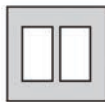

Two GFCI receptacle

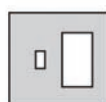

Toggle and GFCI receptacle

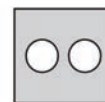

Two single receptacle



Toggle and single receptacle

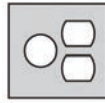

Single and duplex receptacle

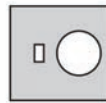

Toggle and single receptacle



Cat. No.	Description
<b>Two Gang Cover – 4-1/4 in. Internal Depth (Aluminum)</b>	
<b>2CKU*</b>	Regular cover universal code keeper accommodates various configurations – lockable

\* Can be used to cover one receptacle with an oversized wall opening

## Red•Dot® metallic weatherproof covers

### Technical Specifications



#### Applications :

- Protects receptacles, switches, and plugs for single gang and two gang configurations in dry and wet locations
- Provides a lockable cover that complies with OSHA lockout/tagout requirements
- Prevents accidental equipment disconnects, reduces tampering, and deters theft and equipment removal

#### Features/Benefits :

- Alloy A360 copper-free (less than 0.004 copper content) aluminum provides increased corrosion resistance
- Die cast, metal construction provides long lasting durability
- NEMA 3R rating ensures protection against falling rain, sleet, and external ice formation when used with appropriate device boxes
- Clear UL and CSA markings speed approval by inspectors
- Wide range of cover depths and receptacle configurations accommodate almost every common plug and cord size
- Combination box or device mounting design provides flexibility in installation

#### Standard Materials :

- Covers and Plates: Die cast aluminum alloy A360
- Gaskets: Closed-cell foam

#### Standard Finish :

- Powder coated finish

#### Compliances :

Compliances as noted on each page of the catalogue in clude:

- CSA Certified
- UL Listed

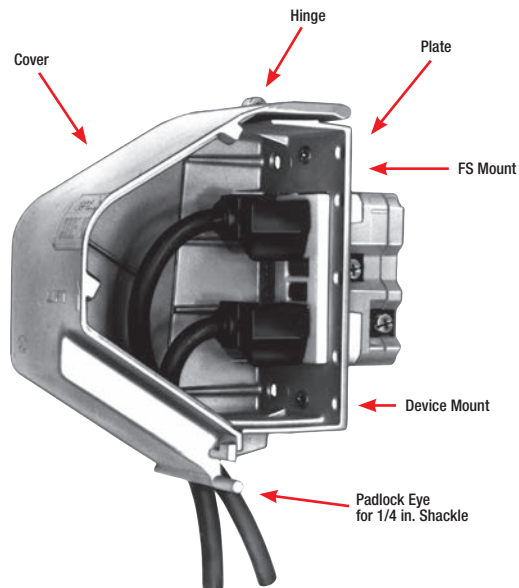

## Red•Dot® metallic weatherproof covers



Duplex



GFCI



Single Receptacle



Switch



Cat. No.	Description
<b>Single Gang Cover – 2-1/4 in. Internal Depth (Aluminum)</b>	
<b>CKSUU</b>	Small vertical cover universal code keeper accommodates duplex, GFCI, single receptacle and toggle switch – lockable

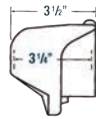

Duplex



GFCI



Single Receptacle



Switch

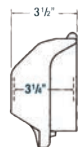

Duplex



GFCI



Single Receptacle



Switch



Cat. No.	Description
<b>Single Gang Cover – 3-1/4 in. Internal Depth (Aluminum)</b>	
<b>CKMU</b>	Medium horizontal cover universal code keeper accommodates duplex, GFCI, single receptacle and toggle switch – lockable
<b>CKMUV</b>	Medium vertical cover universal code keeper accommodates duplex, GFCI, single receptacle and toggle switch – lockable

**Red•Dot® metallic weatherproof covers**

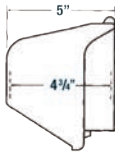

Single Receptacle



Cat. No.	Description
<b>Single Gang Cover – 4-3/4 in. Internal Depth (Aluminum)</b>	
<b>CKLSVU</b>	Large vertical cover – Box mount universal code keeper with adapter rings to accommodate 1-19/32 in. and 1-3/4 in. single receptacles – lockable



Two duplex receptacle

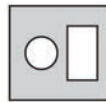

Single and GFCI receptacle

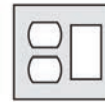

Duplex and GFCI receptacle



Toggle and duplex receptacle

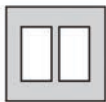

Two GFCI receptacle

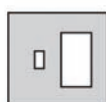

Toggle and GFCI receptacle

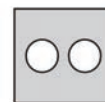

Two single receptacle



Toggle and single receptacle

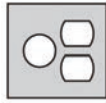

Single and duplex receptacle

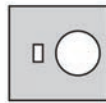

Toggle and single receptacle



Cat. No.	Description
<b>Two Gang Cover – 4-1/4 in. Internal Depth (Aluminum)</b>	
<b>2CKU*</b>	Regular cover universal code keeper accommodates various configurations – lockable

\* Can be used to cover one receptacle with an oversized wall opening