



SERVICE PARTS LIST

BULLETIN NO.
54-26-2830

SPECIFY CATALOG NO. AND SERIAL NO. WHEN ORDERING PARTS		REVISED BULLETIN	DATE
M18 FUEL™ 1/2" SQUARE IMPACT WRENCH with friction ring			Nov. 2018
CATALOG NO.	2767-20	STARTING SERIAL NO.	H96A
		WIRING INSTRUCTION See Page 2	

EXAMPLE:
Component Parts (Small #) Are Included When Ordering The Assembly (Large #).

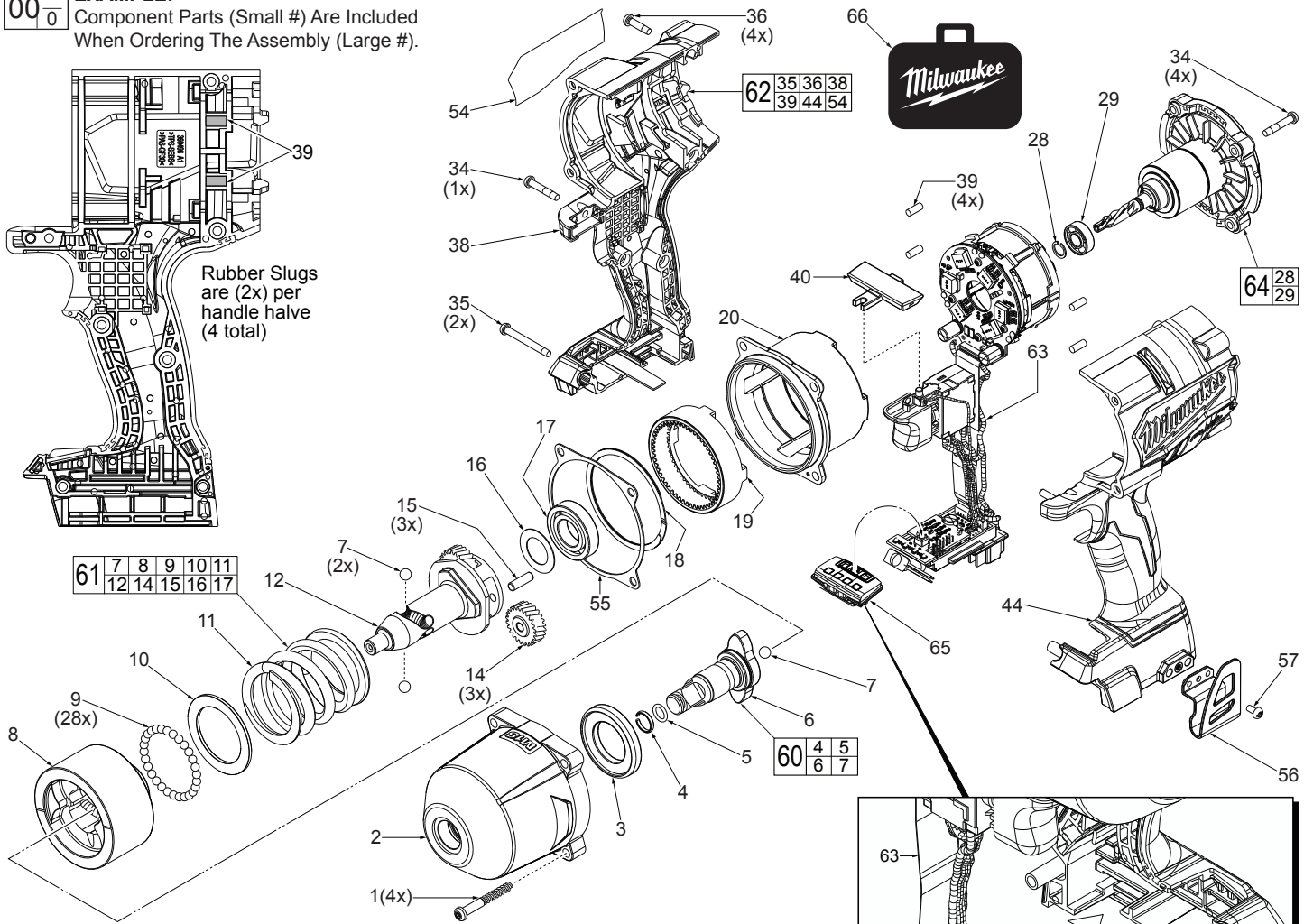
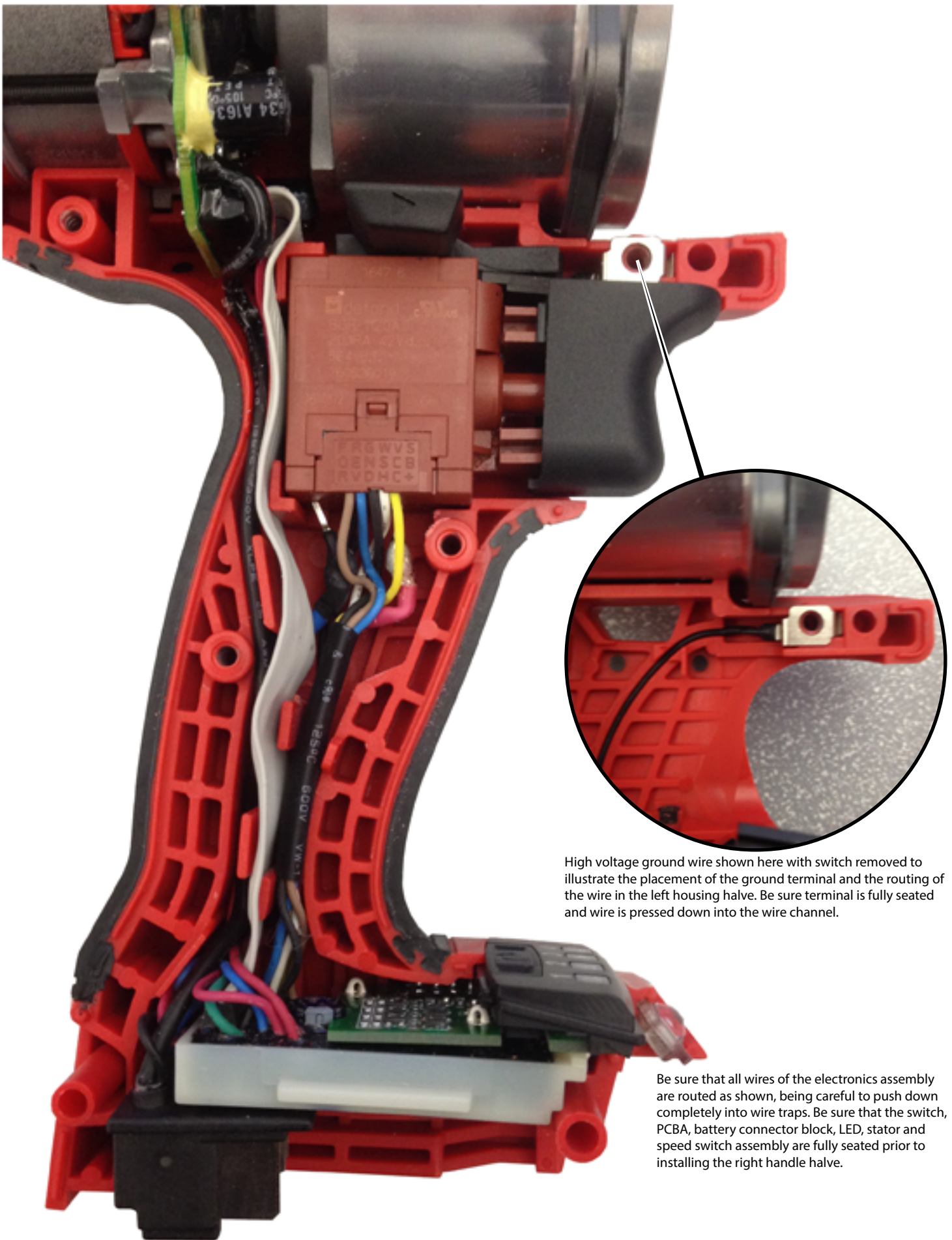

FIG.	PART NO.	DESCRIPTION OF PART	NO. REQ.
1	06-82-4000	M5 x 40mm Pan Hd. ST T-20 Screw	(4)
2	14-30-0840	Front Housing Assembly with Bushing	(1)
3	45-88-2005	Front Housing Washer	(1)
4	44-90-4530	Friction Ring	(1)
5	34-40-0900	O-Ring	(1)
6	-----	1/2" Square Anvil	(1)
7	02-02-0251	6.6mm Steel Ball	(3)
8	43-81-0310	Hammer	(1)
9	02-02-2050	3/16" Steel Ball	(28)
10	45-88-2015	Washer	(1)
11	40-50-1925	Hammer Spring	(1)
12	36-10-0910	Cam Shaft	(1)
14	32-62-0700	Planet Gear	(3)
15	44-60-1960	Planet Pin	(3)
16	45-88-2020	Washer	(1)
17	02-04-0375	Ball Bearing	(1)
18	34-80-5002	Retaining Ring	(1)
19	32-65-0375	Ring Gear	(1)
20	44-66-1650	Rear Gear Case	(1)
28	34-60-0011	Retaining Ring	(1)
29	02-04-0155	Ball Bearing	(1)
34	06-82-4001	M4 x 22mm Pan Hd. ST T-20 Screw	(5)
35	06-82-4002	M4 x 35mm Pan Hd. ST T-20 Screw	(2)
36	06-82-4003	M4 x 16mm Pan Hd. ST T-20 Screw	(4)
38	-----	Housing Cover - Right	(1)
39	45-30-0255	Rubber Slug	(4)
40	45-24-0022	Forward / Reverse Shuttle	(1)

FIG.	PART NO.	DESCRIPTION OF PART	NO. REQ.
44	-----	Housing Support - Left with Metal Pin	(1)
54	12-20-2810	Service Nameplate	(1)
55	43-44-1420	Gasket	(1)
56	42-70-5151	Belt Hook	(1)
57	06-82-0130	6-32 x 5/16 Pan Hd. T-15 Machine Screw	(1)
60	42-06-2760	1/2" Square Anvil Assy. w/ Friction Ring	(1)
61	14-46-2820	Impacting Assembly	(1)
62	31-44-3160	Housing Assembly	(1)
63	14-20-0930	Electronics Assembly	(1)
64	16-01-0400	Rotor/End Cap Assembly	(1)
65	45-24-0450	Speed Switch Assembly	(1)
66	42-55-2820	Carrying Case	(1)

As an aid for servicing, the Speed Switch Assembly #65 should be mounted onto the PCBA first and then carefully installed together into the Left Housing Half #44.



High voltage ground wire shown here with switch removed to illustrate the placement of the ground terminal and the routing of the wire in the left housing halve. Be sure terminal is fully seated and wire is pressed down into the wire channel.

Be sure that all wires of the electronics assembly are routed as shown, being careful to push down completely into wire traps. Be sure that the switch, PCBA, battery connector block, LED, stator and speed switch assembly are fully seated prior to installing the right handle halve.