

DESCRIPTION

The SkyRidge™ transforms ambient lighting by perfectly blending a refined modern styling with our breakthrough WaveStream™ LED technology to deliver exceptional performance and superior energy savings. SkyRidge's advanced engineered LED system with superior optical design delivers an unparalleled combination of optimal light uniformity and exceptional efficiency for greater energy savings.

SkyRidge is compatible with all of today's popular ceiling systems and available in a variety of configurations for application versatility. Its perfect balance of form and function make it an ideal choice for commercial office spaces, schools, hospitals, retail and other indoor ambient applications.

SPECIFICATION FEATURES

Construction

Shallow 4.75" deep housing is extruded aluminum frame and injected molded composite end plates. End plates are securely attached with screws for strength and rigidity and the elimination of gaps. End plates have accessory grid-lock feature for safety and convenience. Four auxiliary fixture end suspension points are provided. Large access plate for supply connection.

Controls

The SkyRidge LED is Powered by Fifth Light, with a standard 0-10V continuous dimming driver that works with any 0-10V control/dimmer. Combine with energy saving products like occupancy sensors, daylighting controls and lighting relay panels to maximize energy savings. In addition, the SkyRidge can include a factory-installed integrated sensor system for occupancy and daylight dimming control and manual control from an optional handheld remote. Or, specify the Digital Addressable Lighting Interface (DALI) drivers, dimmable down to 1% with the HD option, for use with Fifth Light controls. See ordering information for details on all three options.

Electrical

Long-life LED system coupled with electrical driver to deliver optimal performance. LED's available in 3000K, 3500K, 4000K or 5000K with a typical CRI ≥ 85. Projected life is 60,000 hours at 84% lumen output. Electronic drivers are available for 120-277V applications.

Emergency Battery Pack Option

Optional 120v-277v integral emergency battery pack is available in 7-watts or 14-watts to meet critical life-safety lighting requirements. The 90-minute batteries provide constant power to the LED system, ensuring code-compliance. A test switch/indicator button can be tested safely from the ground using a laser pointer, while the patented EZ Key prevents accidental discharge of the battery during construction. See ordering information for details.

Driver Access

Drivers can be accessed via plenum.

Finish

Durable frame has high reflectance baked matte white enamel finish for luminous uniformity.

Catalog #		Type
Project		
Comments		Date
Prepared by		

Optics

Precision formed optical assembly with positively retained high

optical grade acrylic lens provides a directed optical distribution using WaveStream LED technology.

SkyTrim Accessory

Designed for an array of interior applications, SkyTrim is a luminous decorative accent that can be mounted directly on the light guide of a SkyRidge fixture either at the factory or in the field. It is ideal for spaces where color is necessary to provide visual cues, emphasize brand identity, directional awareness or simply as an artistic expression.

Compliance

Components are UL recognized. Indoor luminaires are cULus listed for 25° C ambient environments, RoHS compliant, and comply with IESNA LM-79. LEDs comply with LM-80 standards. DesignLights Consortium® Qualified. Refer to www.designlights.org Qualified Products List under Family Models for details.

Warranty

Five year warranty.



22SR LED

2' X 2' TROFFER LED MODULE

Specification Grade Troffer

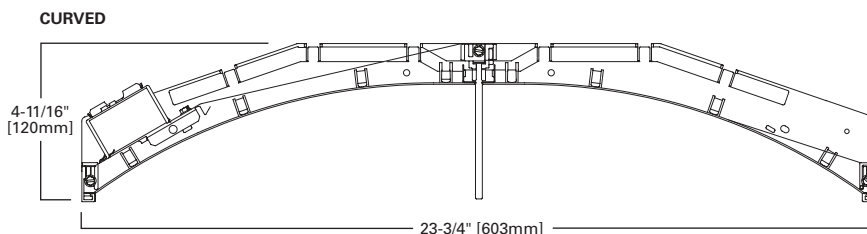

MOUNTING DATA

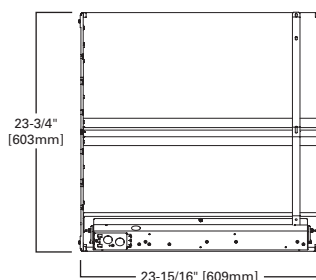

LAMP CONFIGURATIONS

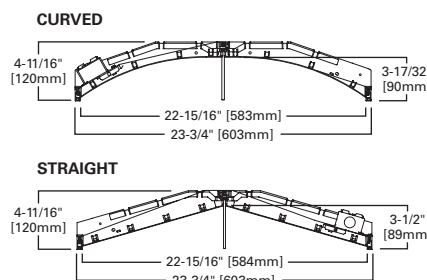

*See Drywall Frame Kit Accessory in Ordering Information section.

**Fixture construction is suitable for use in Air-handling and plenum rated spaces in accordance with Section 300.22 (C) of the National Electrical Code, Section 4.3.11.2.6.5 of NFPA 90A and Section 602.2.1.4 of ICC.

LINEAR DISCONNECT
Safe and convenient means of disconnecting power



CEILING COMPATIBILITY

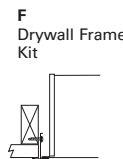
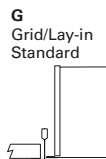

Ceiling Type	Trim Type
Exposed Grid	G
Concealed T	G or T
Slot Grid	G or T
Flange	*

PHOTOMETRICS

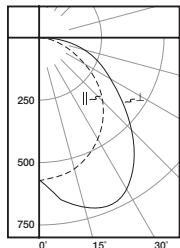

22SR-LD1-20-C-UNV-L835-CD1-U
 Dimming Driver
 Linear LED 3500K
 Spacing criterion:
 (H) 1.2 x mounting height, (L) 1.6 x mounting height
 Lumens: 2046
 Input Watts: 19.9W
 Efficacy: 103 LPW
 Test Report:
 22SR-LD1-20-C-UNV-L835-CD1-U.IES

Angle	Candlepower		
	Along H	45°	Across L
0	572	572	572
5	567	611	634
10	559	644	678
15	543	658	709
20	524	659	728
25	499	647	727
30	469	623	700
35	435	584	650
40	396	536	585
45	353	484	515
50	306	431	446
55	257	378	383
60	207	327	327
65	160	278	277
70	119	231	230
75	86	187	182
80	57	138	124
85	30	75	63
90	0	0	0

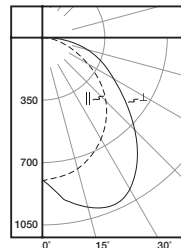

22SR-LD1-29-C-UNV-L835-CD1-U
 Dimming Driver
 Linear LED 3500K
 Spacing criterion:
 (H) 1.2 x mounting height, (L) 1.6 x mounting height
 Lumens: 2935
 Input Watts: 30.0W
 Efficacy: 98 LPW
 Test Report:
 22SR-LD1-29-C-UNV-L835-CD1-U.IES

Angle	Candlepower		
	Along H	45°	Across L
0	818	818	818
5	811	869	904
10	799	918	965
15	778	938	1011
20	749	940	1039
25	715	924	1039
30	672	890	1001
35	624	836	933
40	568	768	840
45	507	693	738
50	438	617	641
55	369	542	549
60	299	469	470
65	231	398	397
70	174	333	332
75	124	268	265
80	83	200	180
85	45	113	94
90	0	0	0

Coefficients of Utilization

rc rw RCR	Effective floor cavity reflectance																							
	80%				70%				50%				30%				10%				0%			
	70	50	30	10	70	50	30	10	50	30	10	50	30	10	50	30	10	50	30	10	50	30	10	0
0	119	119	119	119	116	116	116	116	111	111	111	106	106	106	102	102	102	100						
1	108	103	98	94	105	100	96	92	96	93	90	92	89	87	89	86	84	82						
2	98	89	82	76	95	87	81	75	84	78	73	80	76	71	77	73	70	68						
3	89	78	69	63	86	76	68	62	73	67	61	71	65	60	68	63	59	57						
4	81	69	60	53	79	68	59	53	65	58	52	63	56	51	60	55	50	48						
5	75	62	52	45	73	60	52	45	58	51	45	56	49	44	54	48	44	41						
6	69	55	46	40	67	54	46	39	53	45	39	51	44	39	49	43	38	36						
7	64	50	41	35	62	49	41	35	48	40	34	46	39	34	45	39	34	32						
8	59	46	37	31	58	45	37	31	44	36	31	42	36	31	41	35	30	28						
9	56	42	34	28	54	41	33	28	40	33	28	39	32	27	38	32	27	25						
10	52	39	31	25	51	38	30	25	37	30	25	36	30	25	35	29	25	23						

Coefficients of Utilization

rc rw RCR	Effective floor cavity reflectance																							
	80%				70%				50%				30%				10%				0%			
	70	50	30	10	70	50	30	10	50	30	10	50	30	10	50	30	10	50	30	10	50	30	10	0
0	119	119	119	119	116	116	116	116	111	111	111	106	106	106	102	102	102	100						
1	108	103	98	94	105	100	96	92	96	93	89	92	89	87	89	86	84	82						
2	98	89	82	76	95	87	80	75	83	78	73	80	76	71	77	73	70	68						
3	89	78	69	63	86	76	68	62	73	66	61	70	65	60	68	63	59	57						
4	81	69	60	53	79	68	59	52	65	58	52	63	56	51	60	55	50	48						
5	75	62	52	45	73	60	52	45	58	50	45	56	49	44	54	48	44	41						
6	69	55	46	39	67	54	46	39	52	45	39	51	44	39	49	43	38	36						
7	64	50	41	35	62	49	41	35	48	40	34	46	39	34	45	39	34	32						
8	59	46	37	31	58	45	37	31	44	36	31	42	36	31	41	35	30	28						
9	56	42	33	28	54	41	33	28	40	33	28	39	32	27	38	32	27	25						
10	52	39	30	25	51	38	30	25	37	30	25	36	29	25	35	29	25	23						

Zonal Lumen Summary

Zone	Lumens	%Fixture
0-30	533	26.1
0-40	886	43.3
0-60	1556	76.0
0-90	2046	100.0
0-180	2046	100.0

Luminance Data

Angle in Deg	Average 0-Deg cd/sm	Average 45-Deg cd/sm	Average 90-Deg cd/sm
45	1343	1841	1959
55	1205	1773	1796
65	1018	1769	1763
75	894	1944	1892
85	926	2315	1944

Zonal Lumen Summary

Zone	Lumens	%Fixture
0-30	762	26.0
0-40	1267	43.2
0-60	2227	75.9
0-90	2935	100.0
0-180	2935	100.0

Luminance Data

Angle in Deg	Average 0-Deg cd/sm	Average 45-Deg cd/sm	Average 90-Deg cd/sm
45	1929	2636	2808
55	1731	2542	2575
65	1470	2533	2527
75	1289	2785	2754
85	1389	3488	2901

LUMEN MAINTENANCE

Ambient Temperature	TM-21 Lumen Maintenance (60,000 hours)	Theoretical L70 (Hours)
25°C	> 84%	> 144,000

SKYTRIM FIELD INSTALLATION KITS

Color Choice	Kit Catalog Number	Kit Quantity
Tahitian Blue	STK-2-TB-10PK	10
Primary Green	STK-2-PG-10PK	10
Storaro Orange	STK-2-SO-10PK	10
Belladonna Rose	STK-2-BR-10PK	10
Medium Red	STK-2-MR-10PK	10
Pearl	STK-2-PL-10PK	10
Straw	STK-2-ST-10PK	10
Custom Color	STK-2-CC-*-10PK	10

*Custom color requires Roscolux numeric specification color code, consult factory for more information.

Note: Chosen color will be matched on acrylic but will appear lighter once applied to lit light guide.

ENERGY AND PERFORMANCE DATA BY CATALOG NUMBER

Stock or MTO*	Catalog Logic (Curved)	Delivered Lumens	Watts	Efficacy (LPW)
MTO	22SR-LD1-20-C-UNV-L830-CD1-U	1981	19.9	99
Stock	22SR-LD1-20-C-UNV-L835-CD1-U	2046	19.9	103
Stock	22SR-LD1-20-C-UNV-L840-CD1-U	2095	19.9	105
MTO	22SR-LD1-20-C-UNV-L850-CD1-U	2216	19.9	111
MTO	22SR-LD1-25-C-UNV-L830-CD1-U	2464	25.4	97
MTO	22SR-LD1-25-C-UNV-L835-CD1-U	2550	25.5	100
MTO	22SR-LD1-25-C-UNV-L840-CD1-U	2617	25.5	103
MTO	22SR-LD1-25-C-UNV-L850-CD1-U	2768	25.5	109
MTO	22SR-LD1-29-C-UNV-L830-CD1-U	2820	29.9	94
Stock	22SR-LD1-29-C-UNV-L835-CD1-U	2935	30.0	98
Stock	22SR-LD1-29-C-UNV-L840-CD1-U	3003	30.0	100
MTO	22SR-LD1-29-C-UNV-L850-CD1-U	3177	30.0	106

Stock or MTO*	Catalog Logic (Straight)	Delivered Lumens	Watts	Efficacy (LPW)
MTO	22SR-LD1-20-S-UNV-L830-CD1-U	1977	19.7	101
MTO	22SR-LD1-20-S-UNV-L835-CD1-U	2083	19.7	106
MTO	22SR-LD1-20-S-UNV-L840-CD1-U	2140	19.7	109
MTO	22SR-LD1-20-S-UNV-L850-CD1-U	2140	19.6	109
MTO	22SR-LD1-25-S-UNV-L830-CD1-U	2467	25.1	98
MTO	22SR-LD1-25-S-UNV-L835-CD1-U	2597	25.1	103
MTO	22SR-LD1-25-S-UNV-L840-CD1-U	2672	25.1	106
MTO	22SR-LD1-25-S-UNV-L850-CD1-U	2826	25.1	113
MTO	22SR-LD1-29-S-UNV-L830-CD1-U	2824	29.6	95
MTO	22SR-LD1-29-S-UNV-L835-CD1-U	2984	29.7	101
MTO	22SR-LD1-29-S-UNV-L840-CD1-U	3075	29.7	104
MTO	22SR-LD1-29-S-UNV-L850-CD1-U	3253	29.7	110

*Made to order (MTO) requires a typical four week lead time.

ORDERING INFORMATION

SAMPLE NUMBER: 22SR-LD1-29-C-UNV-L835-CD1-SVPD1-U

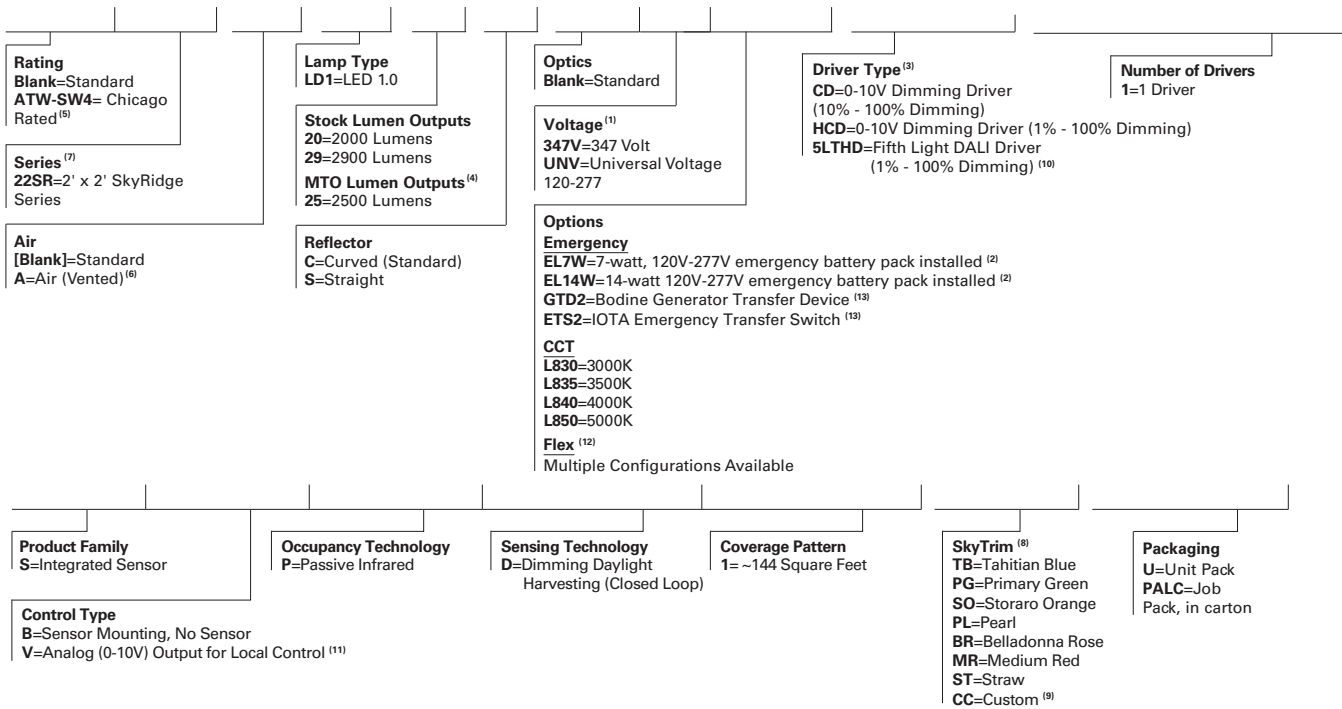

ACCESSORIES

- T3A END E.Q. BRACKET PARTS BAG (Standard with fixture)
- DF-22-W=2' x 2' Drywall Frame Kit
- SK-22-WT=2' x 2' Tall Surface Mount Kit
- DF10P-C_=Decorator Dimmer, 0-10V
- SF10P-_=Decorator Slide Dimmer, 0-10V
- HHPRG-MS=Programming Remote for Integrated Sensor
- ISHH-02=Personal Control Remote for Integrated Sensor

NOTES:⁽¹⁾Products also available in non-US voltages and frequencies for international markets. ⁽²⁾With integral test switch/indicator/laser test. For approximate delivered lumens multiply the lumens per watt of the desired fixture by the wattage of the emergency battery pack (100 lm/W x 7=700 lumens). IES-format photometry for luminaire under emergency operation available. ⁽³⁾Call factory for step-dimming options. ⁽⁴⁾Made-to-order (MTO) requires four week lead time. ⁽⁵⁾Chicago rated version does not allow for row mounting. ⁽⁶⁾Air version is vented but does not meet air handling requirements. Air version is non-IC. Air version is not available with integrated sensor. ⁽⁷⁾DesignLights Consortium™ Qualified and classified for DLC Standard (all lumen packages). Refer to www.designlights.org for details. ⁽⁸⁾Fixtures using factory installed SkyTrim option are not DLC qualified. ⁽⁹⁾Custom color must list Roscolux numeric color specification code. ⁽¹⁰⁾Must be used in conjunction with a DALI control system. For complete DALI solutions by Fifth Light, visit www.eaton.com/lightingsystems ⁽¹¹⁾Integral sensor works only with "CD" driver and is factory prewired to the driver for stand-alone control. ⁽¹²⁾Flex does not include dimming leads. Control leads provided by others. ⁽¹³⁾Used to transfer fixture to secondary power source for life-safety operation. When used with a dimming fixture, two devices are required to ensure control is disabled while operating under emergency power.

Specifications & dimensions subject to change without notice. Consult your Eaton Representative for availability and ordering information.

SHIPPING DATA

Catalog No.	Wt.
22SR-LD1-20	12 lbs.
22SR-LD1-29	12 lbs.

INTEGRATED SENSOR

Description

This innovative luminaire-integrated sensor control system is optimized for code-compliant occupancy detection and daylight harvesting – all from within the foot print of Metalux’s award-winning recessed ambient luminaires.

No New Wires

An in-place fixture retrofit is all that’s needed to meet most energy codes in commercial spaces. The sensor system is factory wired to the luminaire, switching on or off based on occupancy, and dimming the light when enough daylight is available.

Sophisticated lighting control without commissioning

The luminaire-integrated sensor system offers out-of-the-box operation using thoughtful default settings.

Flexibility and Individual Control

When the application demands more, the sensor system has the option to make changes using a remote control. The remote allows changes from the default settings for occupancy, target light level, preset lighting levels, and more.

Cost-effective, Stand-alone Operation

With a single product to mount and a single electrical connection to make, the Metalux luminaire with an integrated sensor system saves money on the total installed cost when occupancy or daylight harvesting controls are needed. The integrated sensor system works stand-alone, without the need for additional switches and dimmers. When manual-on, manual dimming or other code-required control schemes are needed, please see the comprehensive offering of Greengate and Fifth Light solutions from Cooper Controls at www.coopercontrol.com.

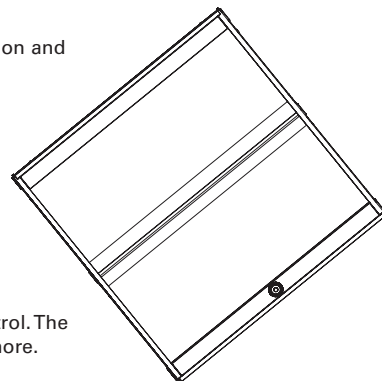

Metalux Integrated Sensor Sequence of Operation

The occupancy sensing portion of the sensor uses Passive Infrared (PIR) technology with Auto-on/Auto-off operation. The small lens in the center of the sensor directs the view of a passive infrared occupancy detector to sense occupants moving through the room. To trigger the light on, an occupant must cross at least two passive infrared beams. When motion in the coverage area ceases, the sensor logic concludes the room is unoccupied, and begins a count-down timer. By default, the timer is factory-set to 20 minutes, and can be adjusted to 5, 10, 15 and 20 minutes using the optional remote control, model number HHPRG-MS. Any motion detected during the count-down timer will cause the light to remain on and resets the timer. When motion is detected, a red LED will blink. In addition to the default on/off functionality, the sensor has an Energy Saver feature, where the light can be set to dim to a preset level after the sensor detects no occupancy for half of the count-down timer, when the timer is complete the lighting will change to the unoccupied setting. The Energy Saver feature works when the count-down timer is set to at least 15 minutes, and the preset level and feature are configured using the optional remote control. See the Sensor Programming Guide that comes with the HHPRG-MS remote for details on this feature. The sensitivity of the occupancy detection can be adjusted, using the HHPRG-MS remote. By default, the sensor operates at the full detection range shown on the coverage pattern diagram. Using the “LO” button on the HHPRG-MS remote, reduces the sensor detection range by 50%. Full coverage can be restored at any time by pressing the “HI” button on the remote. The red LED indicator will blink repeatedly to confirm any programming change.

The dimming daylight harvesting portion of the sensor uses a small photo sensor located next to the occupancy sensing lens. The sensor continuously measures the available light in the room, even when the fixture is turned off. This allows sensor to operate in one of three daylighting modes, where the artificial light from the paired Metalux luminaire can adjust the light based on the amount of ambient light from surrounding natural and artificial light sources. Since the sensor measures light from its luminaire along with other light sources, this sensor follows a closed-loop dimming daylight harvesting style. The first mode, Daytime, is active when the sensor detects light of at least 100 lux in the room. In Daytime mode, when the light is turned on after detecting occupancy, the sensor will begin balancing the luminaire light level relative to the total available light it measures. The default light balancing target in daytime mode is 500 lux. This level can be adjusted higher or lower using the optional HHPRG-MS remote, and pressing “SET” and then the “DO” (Daytime Occupied) button to store the new light level. Similarly, the Daytime Unoccupied, “DU” has a default of level of 0 lux, or off, but can be adjusted higher to prevent the lights from turning off completely when unoccupied. More details on this function are found in the Sensor Programming Guide for the HHPRG-MS remote.

The next two modes, Twilight and Nighttime, function in a similar way, allowing the artificial light to adjust to different levels based on the surroundings. While primarily for use in outdoor luminaires, these modes are available for use in areas with a wide range of natural light, including atriums, day lit stairwells, and rooms with large or continuous windows. The Twilight mode is active when the sensor detects 50-100 lux in the off position, and has a 300 lux default light balancing target. The Nighttime mode is active when the sensor detects less than 50 lux, and has a 250 lux default light balancing target. Like the Daytime mode, there are separate settings for Twilight Occupied (“TO”), Twilight Unoccupied (“TU”), Nighttime Occupied (“NO”) and Nighttime Unoccupied (“NU”) which can be adjusted and set using the optional HHPRG-MS remote.

In addition to programming the sensor, the optional HHPRG-MS remote can be used for personal control to adjust the lighting temporarily override the functions of the sensor temporarily. The remote has raise/lower buttons to adjust the light level for special tasks, as well as a power button to turn the lights on or off. Unless the SET button and another function is selected, any changes made using these buttons will revert to the programmed settings after the sensor has detected no occupancy for its programmed time out, and turned off the lighting. The next time the sensor detects occupancy, it will revert to its programmed settings for count-down timer and light balancing.

Coverage

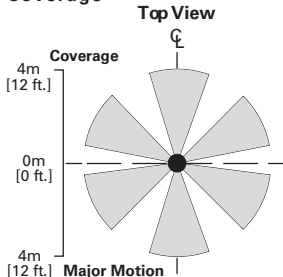

Side View

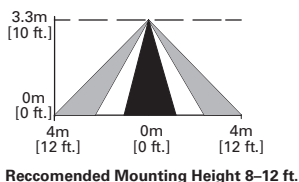

Optional Remote Control



HHPRG-MS Remote

DESCRIPTION

The SkyRidge™ transforms ambient lighting by perfectly blending a refined modern styling with our breakthrough WaveStream™ LED technology to deliver exceptional performance and superior energy savings. SkyRidge's advanced engineered LED system with superior optical design delivers an unparalleled combination of optimal light uniformity and exceptional efficiency for greater energy savings.

SkyRidge is compatible with all of today's popular ceiling systems and available in a variety of configurations for application versatility. Its perfect balance of form and function make it an ideal choice for commercial office spaces, schools, hospitals, retail and other indoor ambient applications.

SPECIFICATION FEATURES

Construction

Shallow 4.75" deep housing is extruded aluminum frame and injected molded composite end plates. End plates are securely attached with screws for strength and rigidity and the elimination of gaps. End plates have accessory grid-lock feature for safety and convenience. Four auxiliary fixture end suspension points are provided. Large access plate for supply connection.

Controls

The SkyRidge LED is Powered by Fifth Light, with a standard 0-10V continuous dimming driver that works with any 0-10V control/dimmer. Combine with energy saving products like occupancy sensors, daylighting controls and lighting relay panels to maximize energy savings. In addition, the SkyRidge can include a factory-installed integrated sensor system for occupancy and daylight dimming control and manual control from an optional handheld remote. Or, specify the Digital Addressable Lighting Interface (DALI) drivers, dimmable down to 1% with the HD option, for use with Fifth Light controls. See ordering information for details on all three options.

Electrical

Long-life LED system coupled with electrical driver to deliver optimal performance. LED's available in 3000K, 3500K, 4000K or 5000K with a typical CRI ≥ 85. Projected life is 60,000 hours at 84% lumen output. Electronic drivers are available for 120-277V applications.

Emergency Battery Pack Option

Optional 120v-277v integral emergency battery pack is available in 7-watts or 14-watts to meet critical life-safety lighting requirements. The 90-minute batteries provide constant power to the LED system, ensuring code-compliance. A test switch/indicator button can be tested safely from the ground using a laser pointer, while the patented EZ Key prevents accidental discharge of the battery during construction. See ordering information for details.

Driver Access

Drivers can be accessed via plenum.

Finish

Durable frame has high reflectance baked matte white enamel finish for luminous uniformity.

Catalog #		Type
Project		
Comments		Date
Prepared by		

Optics

Precision formed optical assembly with positively retained high

optical grade acrylic lens provides a directed optical distribution using WaveStream LED technology.

SkyTrim Accessory

Designed for an array of interior applications, SkyTrim is a luminous decorative accent that can be mounted directly on the light guide of a SkyRidge fixture either at the factory or in the field. It is ideal for spaces where color is necessary to provide visual cues, emphasize brand identity, directional awareness or simply as an artistic expression.

Compliance

Components are UL recognized. Indoor luminaires are cULus listed for 25° C ambient environments, RoHS compliant, and comply with IESNA LM-79. LEDs comply with LM-80 standards. DesignLights Consortium® Qualified. Refer to www.designlights.org Qualified Products List under Family Models for details.

Warranty

Five year warranty.



22SR LED

2' X 2' TROFFER LED MODULE

Specification Grade Troffer

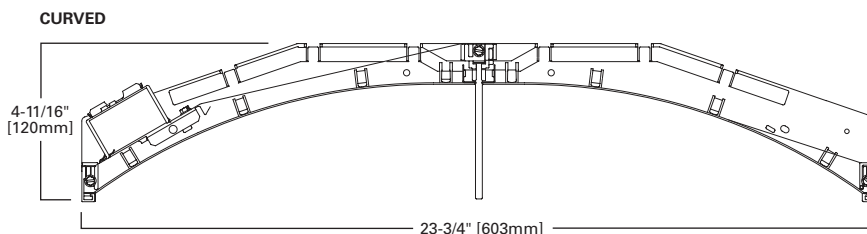

MOUNTING DATA

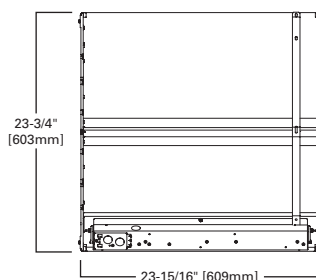

LAMP CONFIGURATIONS

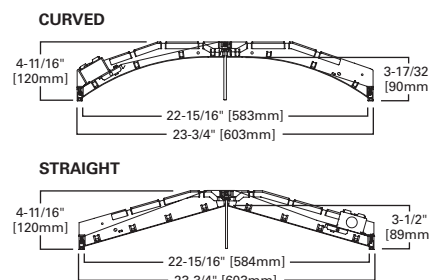

CERTIFICATION DATA

cULus - 1598 and 2043**
 Damp Location Listed
 IC Rated
 LM79/LM80 Compliant
 ROHS Compliant
 DesignLights Consortium® Qualified
 NOM Compliant

*See Drywall Frame Kit Accessory in Ordering Information section.

**Fixture construction is suitable for use in Air-handling and plenum rated spaces in accordance with Section 300.22 (C) of the National Electrical Code, Section 4.3.11.2.6.5 of NFPA 90A and Section 602.2.1.4 of ICC.

LINEAR DISCONNECT
 Safe and convenient means of disconnecting power



CEILING COMPATIBILITY

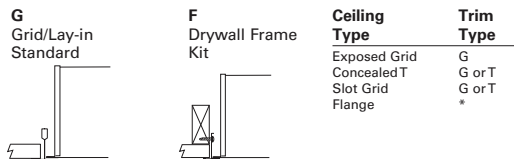

PHOTOMETRICS

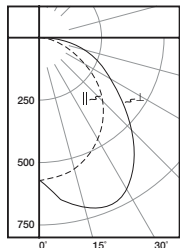

22SR-LD1-20-C-UNV-L835-CD1-U
Dimming Driver
Linear LED 3500K
Spacing criterion:
(H) 1.2 x mounting height, (L) 1.6 x mounting height
Lumens: 2046
Input Watts: 19.9W
Efficacy: 103 LPW
Test Report:
22SR-LD1-20-C-UNV-L835-CD1-U.IES

Candlepower			
Angle	Along H	45°	Across L
0	572	572	572
5	567	611	634
10	559	644	678
15	543	658	709
20	524	659	728
25	499	647	727
30	469	623	700
35	435	584	650
40	396	536	585
45	353	484	515
50	306	431	446
55	257	378	383
60	207	327	327
65	160	278	277
70	119	231	230
75	86	187	182
80	57	138	124
85	30	75	63
90	0	0	0

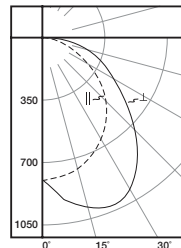

22SR-LD1-29-C-UNV-L835-CD1-U
Dimming Driver
Linear LED 3500K
Spacing criterion:
(H) 1.2 x mounting height, (L) 1.6 x mounting height
Lumens: 2935
Input Watts: 30.0W
Efficacy: 98 LPW
Test Report:
22SR-LD1-29-C-UNV-L835-CD1-U.IES

Candlepower			
Angle	Along H	45°	Across L
0	818	818	818
5	811	869	904
10	799	918	965
15	778	938	1011
20	749	940	1039
25	715	924	1039
30	672	890	1001
35	624	836	933
40	568	768	840
45	507	693	738
50	438	617	641
55	369	542	549
60	299	469	470
65	231	398	397
70	174	333	332
75	124	268	265
80	83	200	180
85	45	113	94
90	0	0	0

Coefficients of Utilization

rc rw RCR	Effective floor cavity reflectance																				
	80%				70%				50%				30%				10%				0%
	70	50	30	10	70	50	30	10	50	30	10	50	30	10	50	30	10	0			
0	119	119	119	119	116	116	116	116	111	111	111	106	106	106	102	102	102	100			
1	108	103	98	94	105	100	96	92	96	93	90	92	89	87	89	86	84	82			
2	98	89	82	76	95	87	81	75	84	78	73	80	76	71	77	73	70	68			
3	89	78	69	63	86	76	68	62	73	67	61	71	65	60	68	63	59	57			
4	81	69	60	53	79	68	59	53	65	58	52	63	56	51	60	55	50	48			
5	75	62	52	45	73	60	52	45	58	51	45	56	49	44	54	48	44	41			
6	69	55	46	40	67	54	46	39	53	45	39	51	44	39	49	43	38	36			
7	64	50	41	35	62	49	41	35	48	40	34	46	39	34	45	39	34	32			
8	59	46	37	31	58	45	37	31	44	36	31	42	36	31	41	35	30	28			
9	56	42	34	28	54	41	33	28	40	33	28	39	32	27	38	32	27	25			
10	52	39	31	25	51	38	30	25	37	30	25	36	30	25	35	29	25	23			

Coefficients of Utilization

rc rw RCR	Effective floor cavity reflectance																				
	80%				70%				50%				30%				10%				0%
	70	50	30	10	70	50	30	10	50	30	10	50	30	10	50	30	10	0			
0	119	119	119	119	116	116	116	116	111	111	111	106	106	106	102	102	102	100			
1	108	103	98	94	105	100	96	92	96	93	89	92	89	87	89	86	84	82			
2	98	89	82	76	95	87	80	75	83	78	73	80	76	71	77	73	70	68			
3	89	78	69	63	86	76	68	62	73	66	61	70	65	60	68	63	59	57			
4	81	69	60	53	79	68	59	52	65	58	52	63	56	51	60	55	50	48			
5	75	61	52	45	73	60	52	45	58	50	45	56	49	44	54	48	44	41			
6	69	55	46	39	67	54	46	39	52	45	39	51	44	39	49	43	38	36			
7	64	50	41	35	62	49	41	35	48	40	34	46	39	34	45	39	34	32			
8	59	46	37	31	58	45	37	31	44	36	31	42	35	30	41	35	30	28			
9	55	42	33	28	54	41	33	28	40	33	28	39	32	27	38	32	27	25			
10	52	39	30	25	51	38	30	25	37	30	25	36	29	25	35	29	25	23			

Zonal Lumen Summary

Zone	Lumens	%Fixture
0-30	533	26.1
0-40	886	43.3
0-60	1556	76.0
0-90	2046	100.0
0-180	2046	100.0

Luminance Data

Angle in Deg	Average 0-Deg cd/sm	Average 45-Deg cd/sm	Average 90-Deg cd/sm
45	1343	1841	1959
55	1205	1773	1796
65	1018	1769	1763
75	894	1944	1892
85	926	2315	1944

Zonal Lumen Summary

Zone	Lumens	%Fixture
0-30	762	26.0
0-40	1267	43.2
0-60	2227	75.9
0-90	2935	100.0
0-180	2935	100.0

Luminance Data

Angle in Deg	Average 0-Deg cd/sm	Average 45-Deg cd/sm	Average 90-Deg cd/sm
45	1929	2636	2808
55	1731	2542	2575
65	1470	2533	2527
75	1289	2785	2754
85	1389	3488	2901

LUMEN MAINTENANCE

Ambient Temperature	TM-21 Lumen Maintenance (60,000 hours)	Theoretical L70 (Hours)
25°C	> 84%	> 144,000

SKYTRIM FIELD INSTALLATION KITS

Color Choice	Kit Catalog Number	Kit Quantity
Tahitian Blue	STK-2-TB-10PK	10
Primary Green	STK-2-PG-10PK	10
Storaro Orange	STK-2-SO-10PK	10
Belladonna Rose	STK-2-BR-10PK	10
Medium Red	STK-2-MR-10PK	10
Pearl	STK-2-PL-10PK	10
Straw	STK-2-ST-10PK	10
Custom Color	STK-2-CC-*-10PK	10

*Custom color requires Roscolux numeric specification color code, consult factory for more information.

Note: Chosen color will be matched on acrylic but will appear lighter once applied to lit light guide.

ENERGY AND PERFORMANCE DATA BY CATALOG NUMBER

Stock or MTO*	Catalog Logic (Curved)	Delivered Lumens	Watts	Efficacy (LPW)
MTO	22SR-LD1-20-C-UNV-L830-CD1-U	1981	19.9	99
Stock	22SR-LD1-20-C-UNV-L835-CD1-U	2046	19.9	103
Stock	22SR-LD1-20-C-UNV-L840-CD1-U	2095	19.9	105
MTO	22SR-LD1-20-C-UNV-L850-CD1-U	2216	19.9	111
MTO	22SR-LD1-25-C-UNV-L830-CD1-U	2464	25.4	97
MTO	22SR-LD1-25-C-UNV-L835-CD1-U	2550	25.5	100
MTO	22SR-LD1-25-C-UNV-L840-CD1-U	2617	25.5	103
MTO	22SR-LD1-25-C-UNV-L850-CD1-U	2768	25.5	109
MTO	22SR-LD1-29-C-UNV-L830-CD1-U	2820	29.9	94
Stock	22SR-LD1-29-C-UNV-L835-CD1-U	2935	30.0	98
Stock	22SR-LD1-29-C-UNV-L840-CD1-U	3003	30.0	100
MTO	22SR-LD1-29-C-UNV-L850-CD1-U	3177	30.0	106

Stock or MTO*	Catalog Logic (Straight)	Delivered Lumens	Watts	Efficacy (LPW)
MTO	22SR-LD1-20-S-UNV-L830-CD1-U	1977	19.7	101
MTO	22SR-LD1-20-S-UNV-L835-CD1-U	2083	19.7	106
MTO	22SR-LD1-20-S-UNV-L840-CD1-U	2140	19.7	109
MTO	22SR-LD1-20-S-UNV-L850-CD1-U	2140	19.6	109
MTO	22SR-LD1-25-S-UNV-L830-CD1-U	2467	25.1	98
MTO	22SR-LD1-25-S-UNV-L835-CD1-U	2597	25.1	103
MTO	22SR-LD1-25-S-UNV-L840-CD1-U	2672	25.1	106
MTO	22SR-LD1-25-S-UNV-L850-CD1-U	2826	25.1	113
MTO	22SR-LD1-29-S-UNV-L830-CD1-U	2824	29.6	95
MTO	22SR-LD1-29-S-UNV-L835-CD1-U	2984	29.7	101
MTO	22SR-LD1-29-S-UNV-L840-CD1-U	3075	29.7	104
MTO	22SR-LD1-29-S-UNV-L850-CD1-U	3253	29.7	110

*Made to order (MTO) requires a typical four week lead time.

ORDERING INFORMATION

SAMPLE NUMBER: 22SR-LD1-29-C-UNV-L835-CD1-SVPD1-U

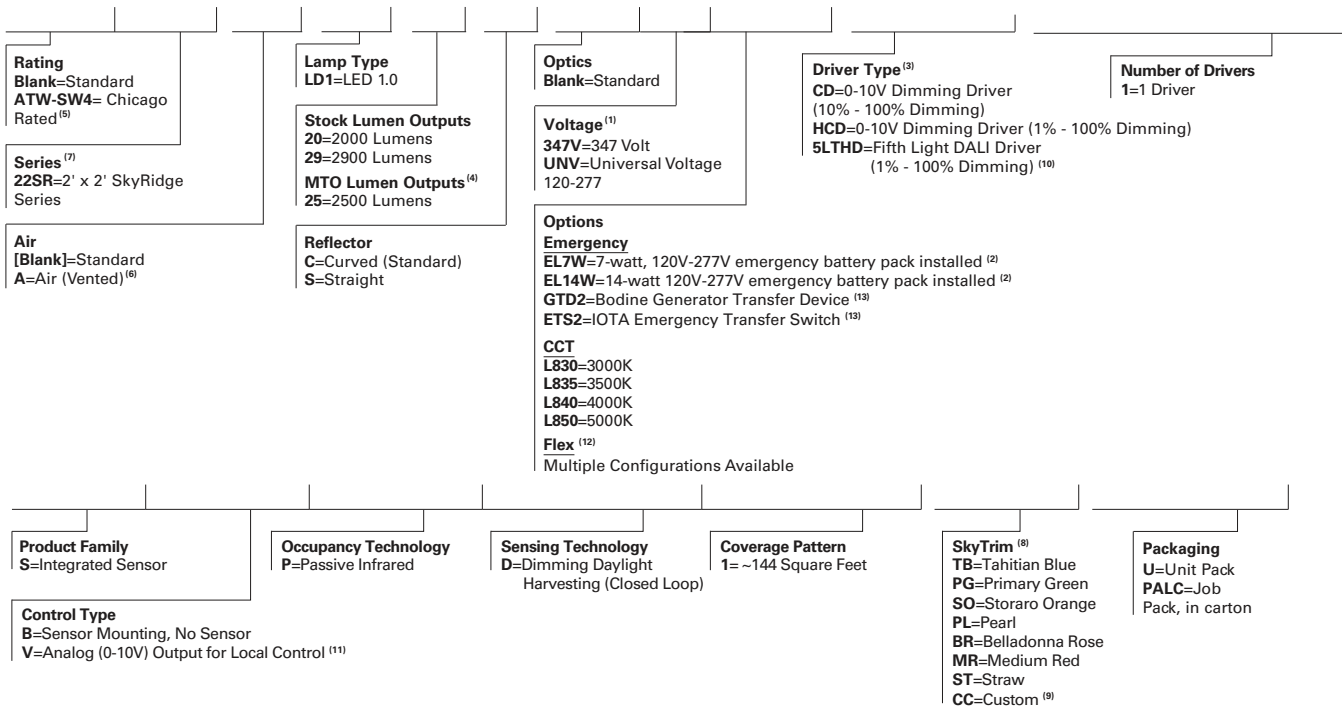

ACCESSORIES

- T3A END E.Q. BRACKET PARTS BAG (Standard with fixture)
- DF-22-W=2' x 2' Drywall Frame Kit
- SK-22-WT=2' x 2' Tall Surface Mount Kit
- DF10P-C_=Decorator Dimmer, 0-10V
- SF10P-_=Decorator Slide Dimmer, 0-10V
- HHPRG-MS=Programming Remote for Integrated Sensor
- ISHH-02=Personal Control Remote for Integrated Sensor

NOTES:⁽¹⁾Products also available in non-US voltages and frequencies for international markets.⁽²⁾With integral test switch/indicator/laser test. For approximate delivered lumens multiply the lumens per watt of the desired fixture by the wattage of the emergency battery pack (100 lm/W x 7=700 lumens). IES-format photometry for luminaire under emergency operation available.⁽³⁾Call factory for step-dimming options.⁽⁴⁾Made-to-order (MTO) requires four week lead time.⁽⁵⁾Chicago rated version does not allow for row mounting.⁽⁶⁾Air version is vented but does not meet air handling requirements. Air version is non-IC. Air version is not available with integrated sensor.⁽⁷⁾DesignLights Consortium™ Qualified and classified for DLC Standard (all lumen packages). Refer to www.designlights.org for details.⁽⁸⁾Fixtures using factory installed SkyTrim option are not DLC qualified.⁽⁹⁾Custom color must list Roscolux numeric color specification code.⁽¹⁰⁾Must be used in conjunction with a DALI control system. For complete DALI solutions by Fifth Light, visit www.eaton.com/lightingsystems⁽¹¹⁾Integral sensor works only with "CD" driver and is factory prewired to the driver for stand-alone control.⁽¹²⁾Flex does not include dimming leads. Control leads provided by others.⁽¹³⁾Used to transfer fixture to secondary power source for life-safety operation. When used with a dimming fixture, two devices are required to ensure control is disabled while operating under emergency power.

Specifications & dimensions subject to change without notice. Consult your Eaton Representative for availability and ordering information.

SHIPPING DATA

Catalog No.	Wt.
22SR-LD1-20	12 lbs.
22SR-LD1-29	12 lbs.

INTEGRATED SENSOR

Description

This innovative luminaire-integrated sensor control system is optimized for code-compliant occupancy detection and daylight harvesting – all from within the foot print of Metalux’s award-winning recessed ambient luminaires.

No New Wires

An in-place fixture retrofit is all that’s needed to meet most energy codes in commercial spaces. The sensor system is factory wired to the luminaire, switching on or off based on occupancy, and dimming the light when enough daylight is available.

Sophisticated lighting control without commissioning

The luminaire-integrated sensor system offers out-of-the-box operation using thoughtful default settings.

Flexibility and Individual Control

When the application demands more, the sensor system has the option to make changes using a remote control. The remote allows changes from the default settings for occupancy, target light level, preset lighting levels, and more.

Cost-effective, Stand-alone Operation

With a single product to mount and a single electrical connection to make, the Metalux luminaire with an integrated sensor system saves money on the total installed cost when occupancy or daylight harvesting controls are needed. The integrated sensor system works stand-alone, without the need for additional switches and dimmers. When manual-on, manual dimming or other code-required control schemes are needed, please see the comprehensive offering of Greengate and Fifth Light solutions from Cooper Controls at www.coopercontrol.com.

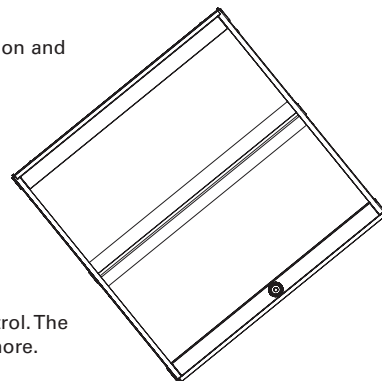

Metalux Integrated Sensor Sequence of Operation

The occupancy sensing portion of the sensor uses Passive Infrared (PIR) technology with Auto-on/Auto-off operation. The small lens in the center of the sensor directs the view of a passive infrared occupancy detector to sense occupants moving through the room. To trigger the light on, an occupant must cross at least two passive infrared beams. When motion in the coverage area ceases, the sensor logic concludes the room is unoccupied, and begins a count-down timer. By default, the timer is factory-set to 20 minutes, and can be adjusted to 5, 10, 15 and 20 minutes using the optional remote control, model number HHPRG-MS. Any motion detected during the count-down timer will cause the light to remain on and resets the timer. When motion is detected, a red LED will blink. In addition to the default on/off functionality, the sensor has an Energy Saver feature, where the light can be set to dim to a preset level after the sensor detects no occupancy for half of the count-down timer, when the timer is complete the lighting will change to the unoccupied setting. The Energy Saver feature works when the count-down timer is set to at least 15 minutes, and the preset level and feature are configured using the optional remote control. See the Sensor Programming Guide that comes with the HHPRG-MS remote for details on this feature. The sensitivity of the occupancy detection can be adjusted, using the HHPRG-MS remote. By default, the sensor operates at the full detection range shown on the coverage pattern diagram. Using the “LO” button on the HHPRG-MS remote, reduces the sensor detection range by 50%. Full coverage can be restored at any time by pressing the “HI” button on the remote. The red LED indicator will blink repeatedly to confirm any programming change.

The dimming daylight harvesting portion of the sensor uses a small photo sensor located next to the occupancy sensing lens. The sensor continuously measures the available light in the room, even when the fixture is turned off. This allows sensor to operate in one of three daylighting modes, where the artificial light from the paired Metalux luminaire can adjust the light based on the amount of ambient light from surrounding natural and artificial light sources. Since the sensor measures light from its luminaire along with other light sources, this sensor follows a closed-loop dimming daylight harvesting style. The first mode, Daytime, is active when the sensor detects light of at least 100 lux in the room. In Daytime mode, when the light is turned on after detecting occupancy, the sensor will begin balancing the luminaire light level relative to the total available light it measures. The default light balancing target in daytime mode is 500 lux. This level can be adjusted higher or lower using the optional HHPRG-MS remote, and pressing “SET” and then the “DO” (Daytime Occupied) button to store the new light level. Similarly, the Daytime Unoccupied, “DU” has a default of level of 0 lux, or off, but can be adjusted higher to prevent the lights from turning off completely when unoccupied. More details on this function are found in the Sensor Programming Guide for the HHPRG-MS remote.

The next two modes, Twilight and Nighttime, function in a similar way, allowing the artificial light to adjust to different levels based on the surroundings. While primarily for use in outdoor luminaires, these modes are available for use in areas with a wide range of natural light, including atriums, day lit stairwells, and rooms with large or continuous windows. The Twilight mode is active when the sensor detects 50-100 lux in the off position, and has a 300 lux default light balancing target. The Nighttime mode is active when the sensor detects less than 50 lux, and has a 250 lux default light balancing target. Like the Daytime mode, there are separate settings for Twilight Occupied (“TO”), Twilight Unoccupied (“TU”), Nighttime Occupied (“NO”) and Nighttime Unoccupied (“NU”) which can be adjusted and set using the optional HHPRG-MS remote.

In addition to programming the sensor, the optional HHPRG-MS remote can be used for personal control to adjust the lighting temporarily override the functions of the sensor temporarily. The remote has raise/lower buttons to adjust the light level for special tasks, as well as a power button to turn the lights on or off. Unless the SET button and another function is selected, any changes made using these buttons will revert to the programmed settings after the sensor has detected no occupancy for its programmed time out, and turned off the lighting. The next time the sensor detects occupancy, it will revert to its programmed settings for count-down timer and light balancing.

Coverage

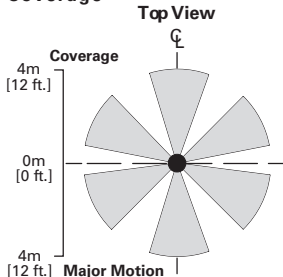

Side View

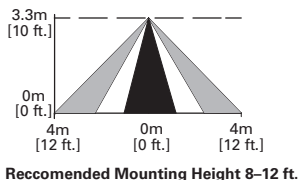

Optional Remote Control



HHPRG-MS Remote