

Condulet conduit bodies – cast iron or aluminum

See page 8 for gaskets and covers

Applications:

Conduit outlet bodies are installed in conduit systems to:

- Act as pull outlets for conductors being installed
- Provide openings for making splices and taps in conductors
- Connect conduit sections
- Provide taps for branch conduit runs
- Make 90° bends in conduit runs
- Provide for access to conductors for maintenance and future system changes

Features:

Conduit outlet bodies:

- Form 7 Condulet® outlet bodies approach conduit in size for neat, compact installations
- Form 8 and Mark 9 bodies provide more room for heavier conductors
- Many shapes and sizes are available for rigid threaded conduit – for complete listings, see pages 6-13
- Conduit hubs have tapered threads and feature integral bushings for protection of wire insulation
- Form 7 has exclusive SNAPTIGHT™ and wedge nut cover attachment to provide clear, unobstructed cover opening
- Certified to UL50E (dusttight) when used with cover containing integral gasket

Gaskets:

Solid gaskets

- Are used with blank covers
- For Mark 9, can be converted to open type gaskets by tearing out center section along scored lines – ½" to 2" sizes
- For Form 7 are used with all covers

Open gaskets

- For Form 8 – ½" to 4" sizes
- For Mark 9 – 2½" to 4" sizes

Blank covers:

- Stainless steel cover screws are standard on Form 7, Form 8 and Mark 9 covers
- Form 7 – wedge nut design facilitates installation and removal; nuts are held captive in cover; covers can be used with or without gaskets; SNAPTIGHT Form 7 covers with integral sealing gaskets are installed without the use of screws, reducing installation time and costs; covers are reusable
- Form 8 – two cover screws provided on all sizes to provide tight cover and gasket assembly; Feraloy iron alloy covers have dome shapes for added strength and extra wiring room
- Mark 9 – self-retaining cover screws

Certifications and compliances:

Outlet bodies:

- UL standard: 514B
- Fed. Spec.: W-C-586D
- CSA standard: C22.2 No. 18
- NEMA 3R raintight (when installed with cover and gasket)
- UL50E dusttight Type 12

Standard materials:

- Form 7, Form 8 outlet bodies – Feraloy iron alloy
- Mark 9 outlet bodies – copper-free aluminum

Standard finishes:

- Form 7, Form 8 outlet bodies – electrogalvanized with aluminum acrylic paint
- Mark 9 outlet bodies – natural

Options:

Description

Suffix

Form 7 body and cover only:

- Copper-free aluminum **SA**
- Corro-free™ epoxy powder coat, external body only **S752**
- Corro-free epoxy powder coat, internal and external **S753**



Form 7



Mark 9



Form 8













Mogul

Condulet conduit bodies – cast iron or aluminum

See pages 10-13 for dimensions

Ordering information – threaded rigid bodies:

| Shape | Style | Hub size | | | | | | | | | |
|---|--------|----------|------|------|--------|--------|------|--------|-------|--------|--------|
| | | 1/2" | 3/4" | 1" | 1 1/4" | 1 1/2" | 2" | 2 1/2" | 3" | 3 1/2" | 4" |
| C | | | | | | | | | | | |
|  | Form 7 | C17 | C27 | C37 | C47 | C57 | C67 | C77 | C87 | | |
| | Form 8 | C18 | C28 | C38 | C448 | C58 | C68 | C78 | C88 | | |
| | Mark 9 | C19 | C29 | C39 | C49 | C59 | C69 | C789 | C889 | C989 | C1089 |
| E | | | | | | | | | | | |
|  | Form 7 | E17 | E27 | E37 | | | | | | | |
| L | | | | | | | | | | | |
|  | Form 7 | L17 | L27 | L37 | L47 | L57 | L67 | | | | |
| Double faced – may be used as LL or LR – has 2 openings, one of which is furnished with a blank sheet steel cover | | | | | | | | | | | |
| LB | | | | | | | | | | | |
|  | Form 7 | LB17 | LB27 | LB37 | LB47 | LB57 | LB67 | LB777 | LB87 | LB97 | LB107 |
| | Form 8 | LB18 | LB28 | LB38 | LB448 | LB58 | LB68 | LB78 | LB888 | LB98 | LB108 |
| | Mark 9 | LB19 | LB29 | LB39 | LB49 | LB59 | LB69 | LB789 | LB889 | | LB1089 |
| LL | | | | | | | | | | | |
|  | Form 7 | LL17 | LL27 | LL37 | LL47 | LL57 | LL67 | LL777 | LL87 | LL97 | LL107 |
| | Form 8 | LL18 | LL28 | LL38 | LL448 | LL58 | LL68 | LL78 | LL888 | | |
| | Mark 9 | LL19 | LL29 | LL39 | LL49 | LL59 | LL69 | LL789 | LL889 | LL989 | LL1089 |
| LR | | | | | | | | | | | |
|  | Form 7 | LR17 | LR27 | LR37 | LR47 | LR57 | LR67 | LR777 | LR87 | LR97 | LR107 |
| | Form 8 | LR18 | LR28 | LR38 | LR448 | LR58 | LR68 | LR78 | LR888 | | |
| | Mark 9 | LR19 | LR29 | LR39 | LR49 | LR59 | LR69 | LR789 | LR889 | LR989 | LR1089 |
| T | | | | | | | | | | | |
|  | Form 7 | T17 | T27 | T37 | T47 | T57 | T67 | T77 | T87 | T97 | T107 |
| | Form 8 | T18 | T28 | T38 | T448 | T58 | T68 | T78 | T88 | | |
| | Mark 9 | T19 | T29 | T39 | T49 | T59 | T69 | T789 | T889 | T989 | T1089 |
| TA | | | | | | | | | | | |
|  | Form 7 | TA17 | TA27 | TA37 | TA47 | TA57 | TA67 | | | | |
| TB | | | | | | | | | | | |
|  | Form 7 | TB17 | TB27 | TB37 | TB47 | TB57 | TB67 | | | | |
| | Form 8 | TB18 | TB28 | TB38 | TB448 | TB58 | TB68 | | | | |
| | Mark 9 | TB19 | TB29 | TB39 | TB49 | TB59 | TB69 | | | | |
| U | | | | | | | | | | | |
|  | Form 7 | U17 | U27 | U37 | U47 | U57 | U67 | | | | |
| X | | | | | | | | | | | |
|  | Form 7 | X17 | X27 | X37 | X47 | X57 | X67 | | | | |
| | Form 8 | X18 | X28 | X38 | X448 | X58 | X68 | | | | |
| | Mark 9 | X19 | X29 | X39 | | | | | | | |

Condulet conduit bodies – cast iron or aluminum

Covers and gaskets

Ordering information – blank covers:



Sheet steel

| Size | Cat. # Form 7 wedge nut | Cat. # Form 7 SNAPTIGHT™ ^A | Cat. # Form 7 wedge nut with integral gasket ^C | Cat. # Form 8 ^E | Cat. # Form 8 with integral gasket ^C |
|--------|-------------------------------|---|---|-------------------------------|---|
| 1/2" | 170 | 170SG | 170G | 180 ^E | 180G ^E |
| 3/4" | 270 | 270SG | 270G | 280 ^E | 280G ^E |
| 1" | 370 | 370SG | 370G | 380 ^E | 380G ^E |
| 1 1/4" | 470 | 470SG | 470G | 480 ^E | 480G ^E |
| 1 1/2" | 570 | 570SG | 570G | 580 ^E | 580G ^E |
| 2" | 670 | 670SG | 670G | 680 ^E | 680G ^E |
| 2 1/2" | 870 | | 870G | 880 | |
| 3" | 870 | | 870G | 880 | |
| 3 1/2" | 970 | | 970G | 980 | |
| 4" | 970 | | 970G | 980 | |



Sheet aluminum



Feraloy iron alloy



Cast aluminum

| Size | Cat. # Mark 9 | Cat. # Mark 9 with integral gasket ^C | Cat. # Form 7 | Cat. # Form 7 with integral gasket ^C | Cat. # Form 7 wedge nut | Cat. # Form 7 wedge nut with integral gasket ^C | Cat. # Form 8 ^D | Cat. # Form 7 wedge nut |
|--------|------------------|--|------------------|--|-------------------------------|---|-------------------------------|-------------------------------|
| 1/2" | 190 | 190G | 170 SA | 170G SA | 170F | 170FG | 180F ^D | 170F SA |
| 3/4" | 290 | 290G | 270 SA | 270G SA | 270F | 270FG | 280F ^D | 270F SA |
| 1" | 390 | 390G | 370 SA | 370G SA | 370F | 370FG | 380F ^D | 370F SA |
| 1 1/4" | 490 | 490G | 470 SA | 470G SA | 470F | 470FG | 480F ^D | 470F SA |
| 1 1/2" | 590 | 590G | 570 SA | 570G SA | 570F | 570FG | 580F | 570F SA |
| 2" | 690 | 690G | 670 SA | 670G SA | 670F | 670FG | 680F | 670F SA |
| 2 1/2" | 889 | | 870 SA | | 870F | | 880F | 870F SA |
| 3" | 889 | | 870 SA | | 870F | | 880F | 870F SA |
| 3 1/2" | 989 | | 970 SA | | 970F | | 980F | 970F SA |
| 4" | 989 | | 970 SA | | 970F | | 980F | 970F SA |

Ordering information – neoprene solid gaskets:



| Size | Cat. # Form 7 | Cat. # Form 8 ^E | Cat. # Mark 9 ^F |
|--------|------------------|-------------------------------|-------------------------------|
| 1/2" | GASK571 | GASK851N | GASK1941 |
| 3/4" | GASK572 | GASK852N | GASK1942 |
| 1" | GASK573 | GASK853N | GASK1943 |
| 1 1/4" | GASK574 | GASK854N | GASK1944 |
| 1 1/2" | GASK575 | GASK805N | GASK1945 |
| 2" | GASK576 | GASK806N | GASK1946 |
| 2 1/2" | GASK578 | GASK808N | GASK808N |
| 3" | GASK578 | GASK808N | GASK808N |
| 3 1/2" | GASK579 | GASK809N | GASK809N |
| 4" | GASK579 | GASK809N | GASK809N |

- ^A Form 7 SNAPTIGHT covers with integral sealing gasket are installed without the use of screws.
- ^B Two cover screws on 1/2" to 2" Form 8 covers and four cover screws on 2 1/2" and larger Form 8 covers.
- ^C Urethane integral gaskets.
- ^D Two cover screws on 1/2" to 1 1/4" Form 8 covers and four cover screws on 1 1/2" and larger Form 8 covers.
- ^E 1/2" to 1 1/4" are solid gaskets; 1 1/2" to 4" are open gaskets.
- ^F 1/2" to 2" are solid gaskets; 2 1/4" to 4" are open gaskets.

Condulet conduit bodies – cast iron or aluminum

Dimensions (in inches):

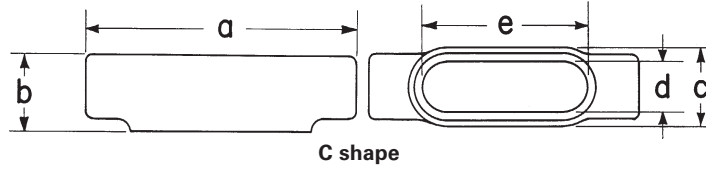

Form 7 C

| Hub size | ½" | ¾" | 1" | 1¼" | 1½" | 2" | 2½" | 3" |
|----------|--------------------------------|---------------------------------|-------------------------------|--------------------------------|---------------------------------|--------------------------------|--------------------------------|--------------------------------|
| a | 5 ⁵ / ₈ | 6 | 7 | 7 ⁷ / ₁₆ | 8 ⁷ / ₁₆ | 9 ⁷ / ₁₆ | 12 | 11 ³ / ₄ |
| b | 1 ³ / ₈ | 1 ⁵ / ₈ | 1 ⁷ / ₈ | 2 ⁵ / ₁₆ | 2 ⁹ / ₁₆ | 3 ¹ / ₈ | 3 ⁵ / ₈ | 4 ³ / ₈ |
| c | 1 ³ / ₈ | 1 ³ / ₁₆ | 1 ³ / ₄ | 2 ³ / ₁₆ | 2 ⁷ / ₁₆ | 3 | 4 ¹ / ₄ | 4 ¹ / ₄ |
| d | 1 ⁵ / ₁₆ | 1 ¹ / ₈ | 1 ³ / ₈ | 1 ³ / ₄ | 1 ¹⁵ / ₁₆ | 2 ⁷ / ₁₆ | 3 ⁹ / ₁₆ | 3 ⁹ / ₁₆ |
| e | 3 ⁷ / ₁₆ | 3 ¹³ / ₁₆ | 4 ¹ / ₂ | 5 | 5 ⁷ / ₁₆ | 6 ³ / ₈ | 8 ³ / ₈ | 8 ³ / ₈ |

Form 8 C

| Hub size | ½" | ¾" | 1" | 1¼" | 1½" | 2" | 2½" | 3" |
|----------|---------------------------------|---------------------------------|---------------------------------|--------------------------------|---------------------------------|--------------------------------|--------------------------------|---------------------------------|
| a | 5 ¹¹ / ₁₆ | 6 ³ / ₃₂ | 7 ⁷ / ₁₆ | 8 ¹ / ₂ | 10 ³ / ₈ | 12 ¹ / ₄ | 15 ⁵ / ₈ | 15 ⁵ / ₈ |
| b | 1 ⁷ / ₁₆ | 1 ¹¹ / ₁₆ | 1 ¹⁵ / ₁₆ | 2 ³ / ₈ | 2 ²⁵ / ₃₂ | 3 ³ / ₁₆ | 4 ⁷ / ₁₆ | 4 ¹³ / ₁₆ |
| c | 1 ³ / ₈ | 1 ³ / ₁₆ | 1 ³ / ₄ | 2 ³ / ₁₆ | 2 ⁷ / ₄ | 3 ³ / ₄ | 5 | 5 |
| d | 1 | 1 ³ / ₁₆ | 1 ³ / ₈ | 1 ³ / ₄ | 2 ¹ / ₈ | 3 | 4 ¹ / ₄ | 4 ¹ / ₄ |
| e | 3 ⁷ / ₁₆ | 3 ¹⁵ / ₁₆ | 4 ⁹ / ₁₆ | 5 ⁷ / ₁₆ | 6 ¹ / ₂ | 8 ⁷ / ₁₆ | 10 ¹ / ₈ | 10 ¹ / ₈ |

Mark 9 C

| Hub size | ½" | ¾" | 1" | 1¼" | 1½" | 2" | 2½" | 3" | 3½" | 4" |
|----------|---------------------------------|---------------------------------|---------------------------------|---------------------------------|---------------------------------|---------------------------------|--------------------------------|---------------------------------|---------------------------------|---------------------------------|
| a | 4 ³¹ / ₃₂ | 5 ¹¹ / ₃₂ | 6 ¹⁹ / ₃₂ | 7 ⁵ / ₈ | 8 ¹¹ / ₃₂ | 10 ⁶ / ₈ | 15 ⁵ / ₈ | 15 ⁵ / ₈ | 18 ³ / ₄ | 18 ³ / ₄ |
| b | 1 ¹³ / ₃₂ | 1 ⁵ / ₈ | 1 ⁷ / ₈ | 2 ¹ / ₂ | 2 ¹³ / ₁₆ | 3 ⁷ / ₁₆ | 4 ⁷ / ₁₆ | 4 ¹³ / ₁₆ | 5 ¹¹ / ₁₆ | 5 ⁵ / ₁₆ |
| c | 1 ³ / ₈ | 1 ³ / ₁₆ | 1 ³ / ₄ | 2 ³ / ₁₆ | 2 ¹ / ₂ | 3 ⁷ / ₃₂ | 5 | 5 | 6 ¹ / ₄ | 6 ¹ / ₄ |
| d | 1 ¹ / ₈ | 1 ¹ / ₄ | 1 ³ / ₈ | 1 ²⁷ / ₃₂ | 2 ⁵ / ₃₂ | 2 ²⁵ / ₃₂ | 4 ¹ / ₄ | 4 ¹ / ₄ | 5 ¹ / ₁₆ | 5 ¹ / ₁₆ |
| e | 3 ⁷ / ₃₂ | 3 ²⁷ / ₃₂ | 4 ⁹ / ₁₆ | 5 ⁷ / ₁₆ | 5 ⁷ / ₈ | 8 ³ / ₃₂ | 10 ⁷ / ₈ | 10 ⁷ / ₈ | 13 ⁷ / ₁₆ | 13 ⁷ / ₁₆ |

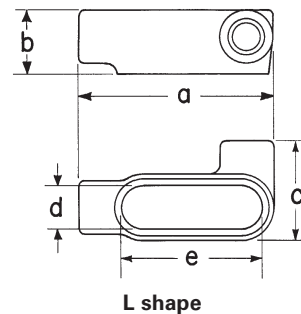
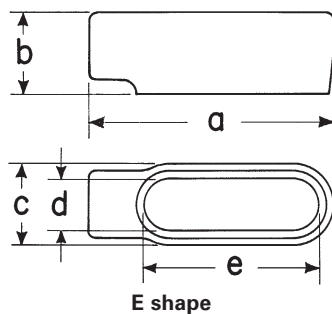

Form 7 E

| Hub size | ½" | ¾" | 1" |
|----------|--------------------------------|---------------------------------|-------------------------------|
| a | 4 ⁹ / ₁₆ | 5 ³ / ₁₆ | 6 |
| b | 1 ³ / ₈ | 1 ⁵ / ₈ | 1 ⁷ / ₈ |
| c | 1 ³ / ₈ | 1 ³ / ₁₆ | 1 ³ / ₄ |
| d | 1 ⁵ / ₁₆ | 1 ¹ / ₈ | 1 ³ / ₈ |
| e | 3 ⁷ / ₁₆ | 3 ¹³ / ₁₆ | 4 ¹ / ₂ |

Form 7 L

| Hub size | ½" | ¾" | 1" | 1¼" | 1½" | 2" |
|----------|--------------------------------|---------------------------------|-------------------------------|--------------------------------|---------------------------------|--------------------------------|
| a | 4 ⁹ / ₁₆ | 5 ³ / ₁₆ | 6 | 6 ¹ / ₂ | 7 ¹ / ₈ | 8 ¹ / ₈ |
| b | 1 ³ / ₈ | 1 ⁵ / ₈ | 1 ⁷ / ₈ | 2 ⁷ / ₁₆ | 2 ⁷ / ₁₆ | 3 ¹ / ₈ |
| c | 2 ¹ / ₄ | 2 ¹ / ₁₆ | 2 ³ / ₄ | 3 ³ / ₁₆ | 3 ⁹ / ₁₆ | 4 ¹ / ₈ |
| d | 1 ⁵ / ₁₆ | 1 ¹ / ₈ | 1 ³ / ₈ | 1 ³ / ₄ | 1 ¹⁵ / ₁₆ | 2 ¹ / ₁₆ |
| e | 3 ⁷ / ₁₆ | 3 ¹³ / ₁₆ | 4 ¹ / ₂ | 5 | 5 ⁷ / ₁₆ | 6 ³ / ₈ |

Condulet conduit bodies – cast iron or aluminum

Dimensions (in inches):

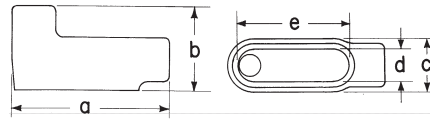

LB shape

Form 7 LB

| Hub size | ½" | ¾" | 1" | 1¼" | 1½" | 2" | 2½" | 3" | 3½" | 4" |
|----------|--------------------------------|---------------------------------|-------------------------------|--------------------------------|---------------------------------|--------------------------------|--------------------------------|--------------------------------|----------------------------------|----------------------------------|
| a | 4 ⁹ / ₁₆ | 5 ³ / ₁₆ | 6 | 6½ | 7 ¹ / ₈ | 8 ¹ / ₈ | 10½ | 10½ | 12 ¹¹ / ₁₆ | 12 ¹¹ / ₁₆ |
| b | 2¼ | 2½ | 2 ⁷ / ₈ | 3 ⁵ / ₁₆ | 3 ¹¹ / ₁₆ | 4¼ | 5 ¹ / ₈ | 5 ⁷ / ₈ | 6 ⁹ / ₁₆ | 7 ¹ / ₁₆ |
| c | 1 ³ / ₈ | 1 ⁹ / ₁₆ | 1 ³ / ₄ | 2 ³ / ₁₆ | 2 ⁷ / ₁₆ | 3 | 4¼ | 4¼ | 5¼ | 5¼ |
| d | 1 ⁵ / ₁₆ | 1 ¹ / ₈ | 1 ³ / ₈ | 1 ³ / ₄ | 1 ¹⁵ / ₁₆ | 2 ⁷ / ₁₆ | 3 ³ / ₁₆ | 3 ³ / ₁₆ | 4½ | 4½ |
| e | 3 ³ / ₁₆ | 3 ¹³ / ₁₆ | 4½ | 5 | 5 ¹ / ₁₆ | 6 ⁷ / ₈ | 8 ¹ / ₈ | 8 ¹ / ₈ | 10¼ | 10¼ |

Form 8 LB

| Hub size | ½" | ¾" | 1" | 1¼" | 1½" | 2" | 2½" | 3" | 3½" | 4" |
|----------|---------------------------------|---------------------------------|---------------------------------|---------------------------------|--------------------------------|---------------------------------|----------------------------------|----------------------------------|---------------------------------|---------------------------------|
| a | 4 ¹⁵ / ₁₆ | 5 ³ / ₁₆ | 6 ¹⁵ / ₃₂ | 7 ¹⁷ / ₃₂ | 9 ¹ / ₈ | 11 | 13 ¹⁵ / ₁₆ | 13 ¹⁵ / ₁₆ | 16 ¹ / ₈ | 16 ¹ / ₈ |
| b | 2 ⁷ / ₃₂ | 2 ¹ / ₁₆ | 2 ¹³ / ₁₆ | 3 ¹¹ / ₃₂ | 4 ¹ / ₃₂ | 4 ¹³ / ₁₆ | 6 ¹ / ₈ | 6 ¹ / ₂ | 7 ⁹ / ₁₆ | 7 ¹³ / ₁₆ |
| c | 1 ³ / ₈ | 1 ⁹ / ₁₆ | 1 ³ / ₄ | 2 ³ / ₁₆ | 2 ¹ / ₄ | 3 ³ / ₄ | 5 | 5 | 6¼ | 6¼ |
| d | 1 | 1 ³ / ₁₆ | 1 ³ / ₈ | 1 ³ / ₄ | 2 ¹ / ₈ | 3 | 4¼ | 4¼ | 5 ¹ / ₁₆ | 5 ¹ / ₁₆ |
| e | 3 ³ / ₁₆ | 3 ¹⁵ / ₁₆ | 4 ⁹ / ₁₆ | 5 ⁵ / ₁₆ | 6½ | 8 ⁷ / ₁₆ | 10 ¹ / ₈ | 10 ¹ / ₈ | 13 ¹ / ₁₆ | 13 ¹ / ₁₆ |

Mark 9 LB

| Hub size | ½" | ¾" | 1" | 1¼" | 1½" | 2" | 2½" | 3" | 3½" | 4" |
|----------|---------------------------------|---------------------------------|---------------------------------|--------------------------------|---------------------------------|---------------------------------|----------------------------------|----------------------------------|---------------------------------|---------------------------------|
| a | 4 ¹⁹ / ₃₂ | 5¼ | 6 ³ / ₃₂ | 7 ³ / ₃₂ | 7 ²⁵ / ₃₂ | 10 ³ / ₃₂ | 13 ¹⁵ / ₁₆ | 13 ¹⁵ / ₁₆ | 16 ¹ / ₈ | 16 ¹ / ₈ |
| b | 2 ⁷ / ₈ | 2 ¹⁵ / ₃₂ | 2 ¹³ / ₁₆ | 3 ⁵ / ₈ | 3 ⁷ / ₈ | 4 ¹⁹ / ₃₂ | 6 ¹ / ₈ | 6 ¹ / ₂ | 7 ⁹ / ₁₆ | 7 ⁹ / ₁₆ |
| c | 1 ³ / ₈ | 1 ¹⁵ / ₃₂ | 1 ³ / ₄ | 2 ³ / ₁₆ | 2 ¹ / ₂ | 3 ⁷ / ₃₂ | 5 | 5 | 6¼ | 6¼ |
| d | 1 ¹ / ₁₆ | 1 ⁹ / ₃₂ | 1 ⁷ / ₁₆ | 1 ⁷ / ₈ | 2 ¹ / ₁₆ | 2 ²³ / ₃₂ | 4¼ | 4¼ | 5 ¹ / ₁₆ | 5 ¹ / ₁₆ |
| e | 3 ⁹ / ₃₂ | 3 ²⁷ / ₃₂ | 4 ⁹ / ₁₆ | 5 ³ / ₁₆ | 5 ¹ / ₈ | 8 ³ / ₃₂ | 10 ¹ / ₈ | 10 ¹ / ₈ | 13 ¹ / ₁₆ | 13 ¹ / ₁₆ |

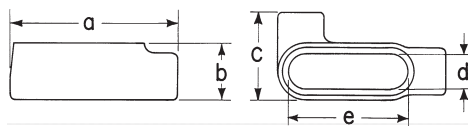

LL shape

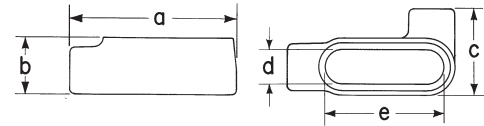

LR shape

Form 7 LL & LR

| Hub size | ½" | ¾" | 1" | 1¼" | 1½" | 2" | 2½" | 3" | 3½" | 4" |
|----------|--------------------------------|---------------------------------|-------------------------------|--------------------------------|---------------------------------|--------------------------------|--------------------------------|--------------------------------|----------------------------------|----------------------------------|
| a | 4 ⁹ / ₁₆ | 5 ³ / ₁₆ | 6 | 6½ | 7 ¹ / ₈ | 8 ¹ / ₈ | 10½ | 10½ | 12 ¹¹ / ₁₆ | 12 ¹¹ / ₁₆ |
| b | 1 ³ / ₈ | 1 ⁹ / ₁₆ | 1 ⁷ / ₈ | 2 ¹ / ₁₆ | 2 ¹ / ₁₆ | 3 ¹ / ₈ | 3 ³ / ₈ | 4 ⁷ / ₈ | 4 ⁷ / ₈ | 5 ¹ / ₈ |
| c | 2¼ | 2 ¹ / ₁₆ | 2 ³ / ₄ | 3 ⁵ / ₁₆ | 3 ⁹ / ₁₆ | 4 ¹ / ₈ | 5¼ | 5¼ | 6 ¹⁵ / ₁₆ | 6 ¹⁵ / ₁₆ |
| d | 1 ⁵ / ₁₆ | 1 ¹ / ₈ | 1 ³ / ₈ | 1 ³ / ₄ | 1 ¹⁵ / ₁₆ | 2 ⁷ / ₁₆ | 3 ³ / ₁₆ | 3 ³ / ₁₆ | 4½ | 4½ |
| e | 3 ³ / ₁₆ | 3 ¹³ / ₁₆ | 4½ | 5 | 5 ¹ / ₁₆ | 6 ⁷ / ₈ | 8 ¹ / ₈ | 8 ¹ / ₈ | 10¼ | 10¼ |

Form 8 LL & LR

| Hub size | ½" | ¾" | 1" | 1¼" | 1½" | 2" | 2½" | 3" |
|----------|---------------------------------|---------------------------------|---------------------------------|---------------------------------|---------------------------------|--------------------------------|----------------------------------|----------------------------------|
| a | 4 ¹⁵ / ₁₆ | 5 ³ / ₁₆ | 6 ¹⁵ / ₃₂ | 7 ¹⁷ / ₃₂ | 9 ¹ / ₈ | 11 | 13 ¹⁵ / ₁₆ | 13 ¹⁵ / ₁₆ |
| b | 1 ⁷ / ₁₆ | 1 ¹¹ / ₁₆ | 1 ¹⁵ / ₁₆ | 2 ¹ / ₈ | 2 ²³ / ₃₂ | 3 ¹ / ₁₆ | 4 ¹ / ₁₆ | 4 ¹³ / ₁₆ |
| c | 2 ² / ₃₂ | 2 ⁵ / ₁₆ | 2 ⁵ / ₈ | 3 ⁵ / ₃₂ | 4 | 5 | 6 ¹¹ / ₁₆ | 6 ¹¹ / ₁₆ |
| d | 1 | 1 ³ / ₁₆ | 1 ³ / ₈ | 1 ³ / ₄ | 2 ¹ / ₈ | 3 | 4¼ | 4¼ |
| e | 3 ³ / ₁₆ | 3 ¹⁵ / ₁₆ | 4 ⁹ / ₁₆ | 5 ⁵ / ₁₆ | 6½ | 8 ⁷ / ₁₆ | 10 ¹ / ₈ | 10 ¹ / ₈ |

Mark 9 LL & LR

| Hub size | ½" | ¾" | 1" | 1¼" | 1½" | 2" | 2½" | 3" | 3½" | 4" |
|----------|---------------------------------|---------------------------------|--------------------------------|--------------------------------|---------------------------------|---------------------------------|----------------------------------|----------------------------------|---------------------------------|---------------------------------|
| a | 4 ¹⁹ / ₃₂ | 5¼ | 6 ³ / ₃₂ | 7 ³ / ₃₂ | 7 ⁵¹ / ₆₄ | 10 ³ / ₃₂ | 13 ¹⁵ / ₁₆ | 13 ¹⁵ / ₁₆ | 16 ¹ / ₈ | 16 ¹ / ₈ |
| b | 1 ¹³ / ₃₂ | 1 ⁵ / ₈ | 1 ⁷ / ₈ | 2 ¹ / ₂ | 2 ³ / ₁₆ | 3 ¹ / ₁₆ | 4 ¹ / ₁₆ | 4 ¹⁹ / ₁₆ | 5 ¹¹ / ₁₆ | 5 ¹³ / ₁₆ |
| c | 2 ¹ / ₈ | 2 ⁵ / ₁₆ | 2 ¹ / ₁₆ | 3¼ | 3½ | 4 ¹³ / ₆₄ | 6 ¹¹ / ₁₆ | 6 ¹ / ₁₆ | 8 ¹ / ₈ | 8 ¹ / ₈ |
| d | 1 ¹ / ₁₆ | 1 ¹ / ₄ | 1 ³ / ₈ | 1 ³ / ₄ | 2 ¹ / ₁₆ | 2 ²³ / ₃₂ | 4¼ | 4¼ | 5 ¹ / ₁₆ | 5 ¹ / ₁₆ |
| e | 3 ⁹ / ₃₂ | 3 ²⁷ / ₃₂ | 4 ⁹ / ₁₆ | 5 ³ / ₁₆ | 5 ¹ / ₈ | 8 ³ / ₃₂ | 10 ¹ / ₈ | 10 ¹ / ₈ | 13 ¹ / ₁₆ | 13 ¹ / ₁₆ |

Condulet conduit bodies – cast iron or aluminum

Dimensions (in inches):

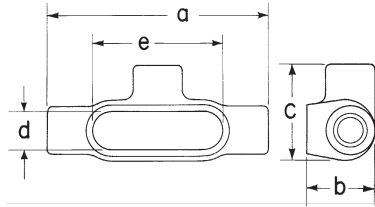

T shape

Form 7 T

| Hub size | a | b | c | d | e |
|----------|---------------------------------|--------------------------------|---------------------------------|---------------------------------|---------------------------------|
| 1/2" | 5 ⁵ / ₈ | 1 ³ / ₄ | 2 ⁷ / ₁₆ | 1 ⁵ / ₁₆ | 3 ⁷ / ₁₆ |
| 3/4" | 6 ¹ / ₄ | 2 | 2 ⁵ / ₈ | 1 ¹ / ₈ | 3 ¹³ / ₁₆ |
| 1" | 7 ¹ / ₄ | 2 ¹ / ₄ | 3 | 1 ³ / ₈ | 4 ¹ / ₂ |
| 1 1/4" | 7 ⁷ / ₁₆ | 2 ⁵ / ₁₆ | 3 ³ / ₁₆ | 1 ³ / ₄ | 5 |
| 1 1/2" | 8 ³ / ₁₆ | 2 ⁹ / ₁₆ | 3 ⁹ / ₁₆ | 1 ¹⁵ / ₁₆ | 5 ¹ / ₁₆ |
| 2" | 9 ³ / ₁₆ | 3 ³ / ₈ | 4 ¹ / ₈ | 2 ¹ / ₁₆ | 6 ³ / ₈ |
| 2 1/2" | 12 | 3 ³ / ₈ | 5 ¹ / ₄ | 3 ⁷ / ₁₆ | 8 ⁷ / ₈ |
| 3" | 12 ¹ / ₁₆ | 4 ³ / ₈ | 5 ¹ / ₄ | 3 ⁹ / ₁₆ | 8 ⁷ / ₈ |
| 3 1/2" | 14 ⁷ / ₁₆ | 4 ⁷ / ₈ | 6 ¹⁵ / ₁₆ | 4 ¹ / ₂ | 10 ¹ / ₄ |
| 4" | 14 ⁹ / ₁₆ | 5 ³ / ₈ | 6 ¹⁵ / ₁₆ | 4 ¹ / ₂ | 10 ¹ / ₄ |

Form 8 T

| Hub size | a | b | c | d | e |
|----------|---------------------------------|---------------------------------|---------------------------------|--------------------------------|---------------------------------|
| 1/2" | 5 ¹¹ / ₁₆ | 1 ³ / ₄ | 2 ⁵ / ₃₂ | 1 | 3 ⁵ / ₁₆ |
| 3/4" | 6 ⁹ / ₃₂ | 2 | 2 ⁵ / ₁₆ | 1 ¹ / ₁₆ | 3 ¹⁵ / ₁₆ |
| 1" | 7 ⁵ / ₁₆ | 2 ¹ / ₄ | 2 ⁵ / ₈ | 1 ³ / ₈ | 4 ⁷ / ₁₆ |
| 1 1/4" | 8 ¹ / ₂ | 2 ⁵ / ₈ | 3 ⁵ / ₃₂ | 1 ³ / ₄ | 5 ⁵ / ₁₆ |
| 1 1/2" | 10 ³ / ₈ | 2 ²⁵ / ₃₂ | 4 | 2 ¹ / ₈ | 6 ¹ / ₂ |
| 2" | 12 ¹ / ₄ | 3 ⁹ / ₁₆ | 5 | 3 | 8 ⁷ / ₁₆ |
| 2 1/2" | 15 ⁵ / ₈ | 4 ¹ / ₁₆ | 6 ¹¹ / ₁₆ | 4 ¹ / ₄ | 10 ⁷ / ₈ |
| 3" | 15 ⁵ / ₈ | 4 ¹³ / ₁₆ | 6 ¹¹ / ₁₆ | 4 ¹ / ₄ | 10 ⁷ / ₈ |

Mark 9 T

| Hub size | a | b | c | d | e |
|----------|---------------------------------|---------------------------------|---------------------------------|---------------------------------|---------------------------------|
| 1/2" | 5 | 1 ¹³ / ₃₂ | 2 ¹ / ₈ | 1 ¹ / ₁₆ | 3 ⁹ / ₃₂ |
| 3/4" | 5 ¹¹ / ₁₆ | 1 ⁵ / ₈ | 2 ⁵ / ₁₆ | 1 ¹ / ₄ | 3 ²⁷ / ₃₂ |
| 1" | 6 ¹⁹ / ₃₂ | 1 ⁷ / ₈ | 2 ¹¹ / ₁₆ | 1 ³ / ₈ | 4 ⁷ / ₁₆ |
| 1 1/4" | 7 ⁵ / ₈ | 2 ¹ / ₂ | 3 ¹ / ₄ | 1 ⁷ / ₈ | 5 ¹ / ₁₆ |
| 1 1/2" | 8 ¹¹ / ₃₂ | 2 ¹³ / ₁₆ | 3 ¹ / ₂ | 2 ¹ / ₁₆ | 5 ⁵ / ₈ |
| 2" | 10 ³ / ₈ | 3 ¹ / ₁₆ | 4 ¹³ / ₃₂ | 2 ²⁹ / ₃₂ | 8 ⁷ / ₃₂ |
| 2 1/2" | 15 ⁵ / ₈ | 4 ¹ / ₁₆ | 6 ¹¹ / ₁₆ | 4 ¹ / ₄ | 10 ⁷ / ₈ |
| 3" | 15 ⁵ / ₈ | 4 ¹³ / ₁₆ | 6 ¹¹ / ₁₆ | 4 ¹ / ₄ | 10 ⁷ / ₈ |
| 3 1/2" | 18 ⁷ / ₄ | 5 ¹¹ / ₁₆ | 8 ⁷ / ₈ | 5 ¹ / ₁₆ | 13 ¹ / ₁₆ |
| 4" | 18 ⁷ / ₄ | 5 ¹⁵ / ₁₆ | 8 ⁷ / ₈ | 5 ¹ / ₁₆ | 13 ¹ / ₁₆ |

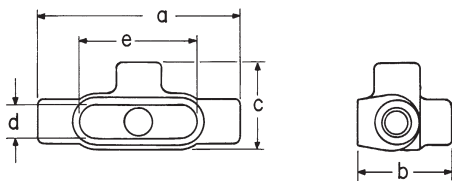

TA shape

Form 7 TA

| Hub size | a | b | c | d | e |
|----------|--------------------------------|---------------------------------|--------------------------------|---------------------------------|---------------------------------|
| 1/2" | 5 ⁵ / ₈ | 2 ⁵ / ₈ | 2 ⁷ / ₁₆ | 1 ⁵ / ₁₆ | 3 ⁷ / ₁₆ |
| 3/4" | 6 ¹ / ₄ | 2 ¹ / ₈ | 2 ⁵ / ₈ | 1 ¹ / ₈ | 3 ¹³ / ₁₆ |
| 1" | 7 ¹ / ₄ | 3 ¹ / ₄ | 3 | 1 ³ / ₈ | 4 ¹ / ₂ |
| 1 1/4" | 7 ⁷ / ₁₆ | 3 ⁵ / ₁₆ | 3 ³ / ₁₆ | 1 ³ / ₄ | 5 |
| 1 1/2" | 8 ³ / ₁₆ | 3 ¹¹ / ₁₆ | 3 ⁹ / ₁₆ | 1 ¹⁵ / ₁₆ | 5 ¹ / ₁₆ |
| 2" | 9 ³ / ₁₆ | 4 ¹ / ₄ | 4 ¹ / ₈ | 2 ¹ / ₁₆ | 6 ³ / ₈ |

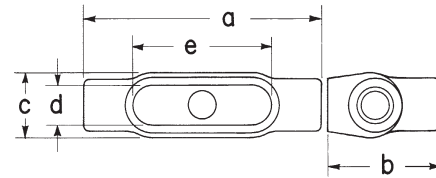

TB shape

Form 7 TB

| Hub size | a | b | c | d | e |
|----------|--------------------------------|--------------------------------|--------------------------------|---------------------------------|---------------------------------|
| 1/2" | 5 ⁵ / ₈ | 2 ⁵ / ₈ | 1 ⁹ / ₁₆ | 1 ⁵ / ₁₆ | 3 ⁷ / ₁₆ |
| 3/4" | 6 ¹ / ₄ | 2 ¹ / ₈ | 1 ³ / ₄ | 1 ¹ / ₈ | 3 ¹³ / ₁₆ |
| 1" | 7 ¹ / ₄ | 3 ¹ / ₄ | 2 | 1 ³ / ₈ | 4 ¹ / ₂ |
| 1 1/4" | 7 ⁷ / ₁₆ | 3 ⁵ / ₁₆ | 2 ³ / ₁₆ | 1 ³ / ₄ | 5 |
| 1 1/2" | 8 ³ / ₁₆ | 5 | 2 ¹ / ₁₆ | 1 ¹⁵ / ₁₆ | 5 ¹ / ₁₆ |
| 2" | 9 ³ / ₁₆ | 6 ¹ / ₈ | 3 | 2 ¹ / ₁₆ | 6 ³ / ₈ |

Form 8 TB

| Hub size | a | b | c | d | e |
|----------|---------------------------------|---------------------------------|--------------------------------|--------------------------------|---------------------------------|
| 1/2" | 5 ¹¹ / ₁₆ | 2 ¹⁷ / ₃₂ | 1 ³ / ₈ | 1 | 3 ⁵ / ₁₆ |
| 3/4" | 6 ⁹ / ₃₂ | 2 ³ / ₄ | 1 ⁹ / ₁₆ | 1 ³ / ₁₆ | 3 ¹⁵ / ₁₆ |
| 1" | 7 ⁵ / ₁₆ | 3 ¹ / ₈ | 1 ³ / ₄ | 1 ³ / ₈ | 4 ⁷ / ₁₆ |
| 1 1/4" | 8 ¹ / ₂ | 3 ¹¹ / ₃₂ | 2 ³ / ₁₆ | 1 ³ / ₄ | 5 ⁵ / ₁₆ |
| 1 1/2" | 10 ³ / ₈ | 4 ¹ / ₃₂ | 2 ¹ / ₄ | 2 ¹ / ₈ | 6 ¹ / ₂ |
| 2" | 12 ¹ / ₄ | 4 ¹³ / ₁₆ | 3 ³ / ₄ | 3 | 8 ⁷ / ₁₆ |

Mark 9 TB

| Hub size | a | b | c | d | e |
|----------|---------------------------------|---------------------------------|--------------------------------|---------------------------------|---------------------------------|
| 1/2" | 5 ¹¹ / ₁₆ | 2 ³³ / ₆₄ | 1 ³ / ₈ | 1 | 3 ⁵ / ₁₆ |
| 3/4" | 6 ⁹ / ₁₆ | 2 ¹ / ₈ | 1 ⁹ / ₁₆ | 1 ³ / ₁₆ | 3 ¹⁵ / ₁₆ |
| 1" | 7 ⁵ / ₁₆ | 3 ¹ / ₈ | 1 ³ / ₄ | 1 ³ / ₈ | 4 ⁷ / ₁₆ |
| 1 1/4" | 8 ¹ / ₂ | 3 ¹¹ / ₃₂ | 2 ³ / ₁₆ | 1 ³ / ₄ | 5 ⁵ / ₁₆ |
| 1 1/2" | 8 ¹¹ / ₃₂ | 3 ¹ / ₈ | 2 ¹ / ₂ | 2 ³ / ₁₆ | 5 ⁷ / ₈ |
| 2" | 10 ⁷ / ₈ | 4 ¹⁵ / ₃₂ | 3 ¹ / ₃₂ | 2 ¹³ / ₁₆ | 8 ⁷ / ₃₂ |

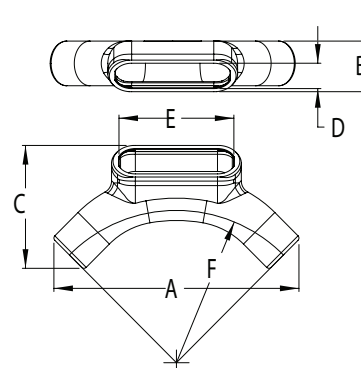

U shape

Form 7 U

| Hub size | A | B | C | D | E | F (bend radius) |
|----------|---------------------------------|---------------------------------|---------------------------------|---------------------------------|---------------------------------|-----------------|
| 1/2" | 7 ¹ / ₈ | 1 ¹ / ₂ | 3 ¹¹ / ₁₆ | 1 ⁵ / ₁₆ | 3 ⁷ / ₁₆ | 4.4 |
| 3/4" | 7 ¹ / ₂ | 1 ¹¹ / ₁₆ | 3 ⁷ / ₈ | 1 ¹ / ₈ | 3 ¹³ / ₁₆ | 4.6 |
| 1" | 9 ¹¹ / ₁₆ | 2 | 4 ¹³ / ₁₆ | 1 ³ / ₈ | 4 ¹ / ₂ | 6.0 |
| 1 1/4" | 12 | 2 ¹ / ₂ | 5 ¹⁵ / ₁₆ | 1 ³ / ₄ | 5 | 7.4 |
| 1 1/2" | 15 ⁵ / ₈ | 2 ⁷ / ₈ | 7 ³ / ₁₆ | 1 ¹⁵ / ₁₆ | 5 ¹ / ₁₆ | 9.6 |
| 2" | 17 ⁵ / ₁₆ | 3 ³ / ₈ | 8 ³ / ₈ | 2 ¹ / ₁₆ | 6 ³ / ₈ | 10.9 |

Condulet conduit bodies – cast iron or aluminum

Dimensions (in inches):

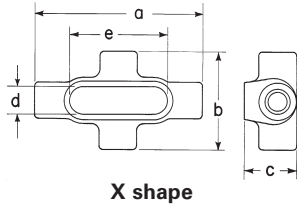

Form 7 X

| Hub size | a | b | c | d | e |
|----------|--------------------------------|--------------------------------|--------------------------------|---------------------------------|---------------------------------|
| 1/2" | 5 ⁵ / ₈ | 3 ⁵ / ₁₆ | 1 ³ / ₄ | 1 ⁵ / ₁₆ | 3 ³ / ₁₆ |
| 3/4" | 6 ¹ / ₄ | 3 ¹ / ₂ | 2 | 1 ¹ / ₈ | 3 ¹³ / ₁₆ |
| 1" | 7 ¹ / ₄ | 4 | 2 ¹ / ₄ | 1 ³ / ₈ | 4 ¹ / ₂ |
| 1 1/4" | 7 ⁷ / ₁₆ | 4 ¹ / ₈ | 2 ⁵ / ₁₆ | 1 ³ / ₄ | 5 |
| 1 1/2" | 8 ³ / ₁₆ | 4 ⁵ / ₈ | 2 ³ / ₁₆ | 1 ¹⁵ / ₁₆ | 5 ¹ / ₁₆ |
| 2" | 9 ³ / ₁₆ | 5 ³ / ₁₆ | 3 ¹ / ₈ | 2 ¹ / ₁₆ | 6 ³ / ₈ |

Form 8 X

| Hub size | a | b | c | d | e |
|----------|---------------------------------|---------------------------------|---------------------------------|--------------------------------|---------------------------------|
| 1/2" | 5 ¹¹ / ₁₆ | 2 ²⁹ / ₃₂ | 1 ³ / ₄ | 1 | 3 ⁷ / ₁₆ |
| 3/4" | 6 ⁹ / ₃₂ | 3 ¹ / ₁₆ | 2 | 1 ³ / ₁₆ | 3 ¹⁵ / ₁₆ |
| 1" | 7 ³ / ₁₆ | 3 ¹ / ₂ | 2 ¹ / ₄ | 1 ³ / ₈ | 4 ⁹ / ₁₆ |
| 1 1/4" | 8 ¹ / ₂ | 4 ¹ / ₈ | 2 ⁵ / ₈ | 1 ³ / ₄ | 5 ⁵ / ₁₆ |
| 1 1/2" | 10 ³ / ₈ | 5 ¹ / ₄ | 2 ¹⁵ / ₃₂ | 2 ¹ / ₈ | 6 ¹ / ₂ |
| 2" | 12 ¹ / ₄ | 6 ¹ / ₄ | 3 ³ / ₁₆ | 3 | 8 ³ / ₁₆ |

Mark 9 X

| Hub size | a | b | c | d | e |
|----------|---------------------------------|---------------------------------|-------------------------------|--------------------------------|---------------------------------|
| 1/2" | 5 ¹¹ / ₁₆ | 2 ⁵⁷ / ₆₄ | 1 ³ / ₄ | 1 | 3 ⁵ / ₁₆ |
| 3/4" | 6 ⁹ / ₁₆ | 3 ¹ / ₄ | 2 | 1 ³ / ₁₆ | 3 ¹⁵ / ₁₆ |
| 1" | 7 ⁵ / ₁₆ | 3 ¹ / ₂ | 2 ¹ / ₄ | 1 ³ / ₈ | 4 ⁹ / ₁₆ |

Condulet conduit bodies – cast iron or aluminum

See page 8 for gaskets and covers

Applications:

Conduit outlet bodies are installed in conduit systems to:

- Act as pull outlets for conductors being installed
- Provide openings for making splices and taps in conductors
- Connect conduit sections
- Provide taps for branch conduit runs
- Make 90° bends in conduit runs
- Provide for access to conductors for maintenance and future system changes

Features:

Conduit outlet bodies:

- Form 7 Condulet® outlet bodies approach conduit in size for neat, compact installations
- Form 8 and Mark 9 bodies provide more room for heavier conductors
- Many shapes and sizes are available for rigid threaded conduit – for complete listings, see pages 6-13
- Conduit hubs have tapered threads and feature integral bushings for protection of wire insulation
- Form 7 has exclusive SNAPTIGHT™ and wedge nut cover attachment to provide clear, unobstructed cover opening
- Certified to UL50E (dusttight) when used with cover containing integral gasket

Gaskets:

Solid gaskets

- Are used with blank covers
- For Mark 9, can be converted to open type gaskets by tearing out center section along scored lines – ½" to 2" sizes
- For Form 7 are used with all covers

Open gaskets

- For Form 8 – ½" to 4" sizes
- For Mark 9 – 2½" to 4" sizes

Blank covers:

- Stainless steel cover screws are standard on Form 7, Form 8 and Mark 9 covers
- Form 7 – wedge nut design facilitates installation and removal; nuts are held captive in cover; covers can be used with or without gaskets; SNAPTIGHT Form 7 covers with integral sealing gaskets are installed without the use of screws, reducing installation time and costs; covers are reusable
- Form 8 – two cover screws provided on all sizes to provide tight cover and gasket assembly; Feraloy iron alloy covers have dome shapes for added strength and extra wiring room
- Mark 9 – self-retaining cover screws

Certifications and compliances:

Outlet bodies:

- UL standard: 514B
- Fed. Spec.: W-C-586D
- CSA standard: C22.2 No. 18
- NEMA 3R raintight (when installed with cover and gasket)
- UL50E dusttight Type 12

Standard materials:

- Form 7, Form 8 outlet bodies – Feraloy iron alloy
- Mark 9 outlet bodies – copper-free aluminum

Standard finishes:

- Form 7, Form 8 outlet bodies – electrogalvanized with aluminum acrylic paint
- Mark 9 outlet bodies – natural

Options:

Description

Suffix

Form 7 body and cover only:

- Copper-free aluminum **SA**
- Corro-free™ epoxy powder coat, external body only **S752**
- Corro-free epoxy powder coat, internal and external **S753**



Form 7



Mark 9



Form 8













Mogul

Condulet conduit bodies – cast iron or aluminum

See pages 10-13 for dimensions

Ordering information – threaded rigid bodies:

| Shape | Style | Hub size | | | | | | | | | |
|---|--------|----------|------|------|--------|--------|------|--------|-------|--------|--------|
| | | 1/2" | 3/4" | 1" | 1 1/4" | 1 1/2" | 2" | 2 1/2" | 3" | 3 1/2" | 4" |
| C | | | | | | | | | | | |
|  | Form 7 | C17 | C27 | C37 | C47 | C57 | C67 | C77 | C87 | | |
| | Form 8 | C18 | C28 | C38 | C448 | C58 | C68 | C78 | C88 | | |
| | Mark 9 | C19 | C29 | C39 | C49 | C59 | C69 | C789 | C889 | C989 | C1089 |
| E | | | | | | | | | | | |
|  | Form 7 | E17 | E27 | E37 | | | | | | | |
| L | | | | | | | | | | | |
|  | Form 7 | L17 | L27 | L37 | L47 | L57 | L67 | | | | |
| Double faced – may be used as LL or LR – has 2 openings, one of which is furnished with a blank sheet steel cover | | | | | | | | | | | |
| LB | | | | | | | | | | | |
|  | Form 7 | LB17 | LB27 | LB37 | LB47 | LB57 | LB67 | LB777 | LB87 | LB97 | LB107 |
| | Form 8 | LB18 | LB28 | LB38 | LB448 | LB58 | LB68 | LB78 | LB888 | LB98 | LB108 |
| | Mark 9 | LB19 | LB29 | LB39 | LB49 | LB59 | LB69 | LB789 | LB889 | | LB1089 |
| LL | | | | | | | | | | | |
|  | Form 7 | LL17 | LL27 | LL37 | LL47 | LL57 | LL67 | LL777 | LL87 | LL97 | LL107 |
| | Form 8 | LL18 | LL28 | LL38 | LL448 | LL58 | LL68 | LL78 | LL888 | | |
| | Mark 9 | LL19 | LL29 | LL39 | LL49 | LL59 | LL69 | LL789 | LL889 | LL989 | LL1089 |
| LR | | | | | | | | | | | |
|  | Form 7 | LR17 | LR27 | LR37 | LR47 | LR57 | LR67 | LR777 | LR87 | LR97 | LR107 |
| | Form 8 | LR18 | LR28 | LR38 | LR448 | LR58 | LR68 | LR78 | LR888 | | |
| | Mark 9 | LR19 | LR29 | LR39 | LR49 | LR59 | LR69 | LR789 | LR889 | LR989 | LR1089 |
| T | | | | | | | | | | | |
|  | Form 7 | T17 | T27 | T37 | T47 | T57 | T67 | T77 | T87 | T97 | T107 |
| | Form 8 | T18 | T28 | T38 | T448 | T58 | T68 | T78 | T88 | | |
| | Mark 9 | T19 | T29 | T39 | T49 | T59 | T69 | T789 | T889 | T989 | T1089 |
| TA | | | | | | | | | | | |
|  | Form 7 | TA17 | TA27 | TA37 | TA47 | TA57 | TA67 | | | | |
| TB | | | | | | | | | | | |
|  | Form 7 | TB17 | TB27 | TB37 | TB47 | TB57 | TB67 | | | | |
| | Form 8 | TB18 | TB28 | TB38 | TB448 | TB58 | TB68 | | | | |
| | Mark 9 | TB19 | TB29 | TB39 | TB49 | TB59 | TB69 | | | | |
| U | | | | | | | | | | | |
|  | Form 7 | U17 | U27 | U37 | U47 | U57 | U67 | | | | |
| X | | | | | | | | | | | |
|  | Form 7 | X17 | X27 | X37 | X47 | X57 | X67 | | | | |
| | Form 8 | X18 | X28 | X38 | X448 | X58 | X68 | | | | |
| | Mark 9 | X19 | X29 | X39 | | | | | | | |

Condulet conduit bodies – cast iron or aluminum

Covers and gaskets

Ordering information – blank covers:



Sheet steel

| Size | Cat. # Form 7 wedge nut | Cat. # Form 7 SNAPTIGHT™ ^A | Cat. # Form 7 wedge nut with integral gasket ^C | Cat. # Form 8 ^E | Cat. # Form 8 with integral gasket ^C |
|--------|-------------------------------|---|---|-------------------------------|---|
| 1/2" | 170 | 170SG | 170G | 180 ^E | 180G ^E |
| 3/4" | 270 | 270SG | 270G | 280 ^E | 280G ^E |
| 1" | 370 | 370SG | 370G | 380 ^E | 380G ^E |
| 1 1/4" | 470 | 470SG | 470G | 480 ^E | 480G ^E |
| 1 1/2" | 570 | 570SG | 570G | 580 ^E | 580G ^E |
| 2" | 670 | 670SG | 670G | 680 ^E | 680G ^E |
| 2 1/2" | 870 | | 870G | 880 | |
| 3" | 870 | | 870G | 880 | |
| 3 1/2" | 970 | | 970G | 980 | |
| 4" | 970 | | 970G | 980 | |



Sheet aluminum

Feraloy iron alloy

Cast aluminum

| Size | Cat. # Mark 9 | Cat. # Mark 9 with integral gasket ^C | Cat. # Form 7 | Cat. # Form 7 with integral gasket ^C | Cat. # Form 7 wedge nut | Cat. # Form 7 wedge nut with integral gasket ^C | Cat. # Form 8 ^D | Cat. # Form 7 wedge nut |
|--------|------------------|--|------------------|--|-------------------------------|---|-------------------------------|-------------------------------|
| 1/2" | 190 | 190G | 170 SA | 170G SA | 170F | 170FG | 180F ^D | 170F SA |
| 3/4" | 290 | 290G | 270 SA | 270G SA | 270F | 270FG | 280F ^D | 270F SA |
| 1" | 390 | 390G | 370 SA | 370G SA | 370F | 370FG | 380F ^D | 370F SA |
| 1 1/4" | 490 | 490G | 470 SA | 470G SA | 470F | 470FG | 480F ^D | 470F SA |
| 1 1/2" | 590 | 590G | 570 SA | 570G SA | 570F | 570FG | 580F | 570F SA |
| 2" | 690 | 690G | 670 SA | 670G SA | 670F | 670FG | 680F | 670F SA |
| 2 1/2" | 889 | | 870 SA | | 870F | | 880F | 870F SA |
| 3" | 889 | | 870 SA | | 870F | | 880F | 870F SA |
| 3 1/2" | 989 | | 970 SA | | 970F | | 980F | 970F SA |
| 4" | 989 | | 970 SA | | 970F | | 980F | 970F SA |

Ordering information – neoprene solid gaskets:



| Size | Cat. # Form 7 | Cat. # Form 8 ^E | Cat. # Mark 9 ^F |
|--------|------------------|-------------------------------|-------------------------------|
| 1/2" | GASK571 | GASK851N | GASK1941 |
| 3/4" | GASK572 | GASK852N | GASK1942 |
| 1" | GASK573 | GASK853N | GASK1943 |
| 1 1/4" | GASK574 | GASK854N | GASK1944 |
| 1 1/2" | GASK575 | GASK805N | GASK1945 |
| 2" | GASK576 | GASK806N | GASK1946 |
| 2 1/2" | GASK578 | GASK808N | GASK808N |
| 3" | GASK578 | GASK808N | GASK808N |
| 3 1/2" | GASK579 | GASK809N | GASK809N |
| 4" | GASK579 | GASK809N | GASK809N |

^A Form 7 SNAPTIGHT covers with integral sealing gasket are installed without the use of screws.

^B Two cover screws on 1/2" to 2" Form 8 covers and four cover screws on 2 1/2" and larger Form 8 covers.

^C Urethane integral gaskets.

^D Two cover screws on 1/2" to 1 1/4" Form 8 covers and four cover screws on 1 1/2" and larger Form 8 covers.

^E 1/2" to 1 1/4" are solid gaskets; 1 1/2" to 4" are open gaskets.

^F 1/2" to 2" are solid gaskets; 2 1/4" to 4" are open gaskets.

Condulet conduit bodies – cast iron or aluminum

Dimensions (in inches):

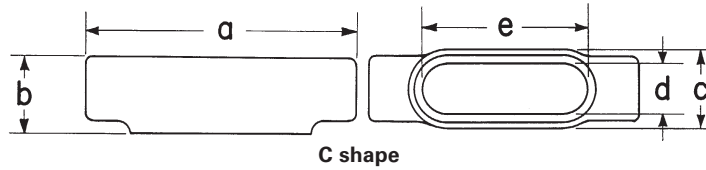

Form 7 C

| Hub size | ½" | ¾" | 1" | 1¼" | 1½" | 2" | 2½" | 3" |
|----------|--------------------------------|---------------------------------|-------------------------------|--------------------------------|---------------------------------|--------------------------------|--------------------------------|--------------------------------|
| a | 5 ⁵ / ₈ | 6 | 7 | 7 ⁷ / ₁₆ | 8 ⁷ / ₁₆ | 9 ⁷ / ₁₆ | 12 | 11 ³ / ₄ |
| b | 1 ³ / ₈ | 1 ⁵ / ₈ | 1 ⁷ / ₈ | 2 ⁵ / ₁₆ | 2 ⁹ / ₁₆ | 3 ¹ / ₈ | 3 ⁵ / ₈ | 4 ³ / ₈ |
| c | 1 ³ / ₈ | 1 ³ / ₁₆ | 1 ³ / ₄ | 2 ³ / ₁₆ | 2 ⁷ / ₁₆ | 3 | 4 ¹ / ₄ | 4 ¹ / ₄ |
| d | 1 ⁵ / ₁₆ | 1 ¹ / ₈ | 1 ³ / ₈ | 1 ³ / ₄ | 1 ¹⁵ / ₁₆ | 2 ⁷ / ₁₆ | 3 ⁹ / ₁₆ | 3 ⁹ / ₁₆ |
| e | 3 ⁷ / ₁₆ | 3 ¹³ / ₁₆ | 4 ¹ / ₂ | 5 | 5 ⁷ / ₁₆ | 6 ³ / ₈ | 8 ³ / ₈ | 8 ³ / ₈ |

Form 8 C

| Hub size | ½" | ¾" | 1" | 1¼" | 1½" | 2" | 2½" | 3" |
|----------|---------------------------------|---------------------------------|---------------------------------|--------------------------------|---------------------------------|--------------------------------|--------------------------------|---------------------------------|
| a | 5 ¹¹ / ₁₆ | 6 ³ / ₃₂ | 7 ⁷ / ₁₆ | 8 ¹ / ₂ | 10 ³ / ₈ | 12 ¹ / ₄ | 15 ⁵ / ₈ | 15 ⁵ / ₈ |
| b | 1 ⁷ / ₁₆ | 1 ¹¹ / ₁₆ | 1 ¹⁵ / ₁₆ | 2 ³ / ₈ | 2 ²⁵ / ₃₂ | 3 ³ / ₁₆ | 4 ⁷ / ₁₆ | 4 ¹³ / ₁₆ |
| c | 1 ³ / ₈ | 1 ³ / ₁₆ | 1 ³ / ₄ | 2 ³ / ₁₆ | 2 ⁷ / ₄ | 3 ³ / ₄ | 5 | 5 |
| d | 1 | 1 ³ / ₁₆ | 1 ³ / ₈ | 1 ³ / ₄ | 2 ¹ / ₈ | 3 | 4 ¹ / ₄ | 4 ¹ / ₄ |
| e | 3 ⁷ / ₁₆ | 3 ¹⁵ / ₁₆ | 4 ⁹ / ₁₆ | 5 ⁷ / ₁₆ | 6 ¹ / ₂ | 8 ⁷ / ₁₆ | 10 ¹ / ₈ | 10 ¹ / ₈ |

Mark 9 C

| Hub size | ½" | ¾" | 1" | 1¼" | 1½" | 2" | 2½" | 3" | 3½" | 4" |
|----------|---------------------------------|---------------------------------|---------------------------------|---------------------------------|---------------------------------|---------------------------------|--------------------------------|---------------------------------|---------------------------------|---------------------------------|
| a | 4 ³¹ / ₃₂ | 5 ¹¹ / ₃₂ | 6 ¹⁹ / ₃₂ | 7 ⁵ / ₈ | 8 ¹¹ / ₃₂ | 10 ⁶ / ₈ | 15 ⁵ / ₈ | 15 ⁵ / ₈ | 18 ³ / ₄ | 18 ³ / ₄ |
| b | 1 ¹³ / ₃₂ | 1 ⁵ / ₈ | 1 ⁷ / ₈ | 2 ¹ / ₂ | 2 ¹³ / ₁₆ | 3 ⁷ / ₁₆ | 4 ⁷ / ₁₆ | 4 ¹³ / ₁₆ | 5 ¹¹ / ₁₆ | 5 ⁵ / ₁₆ |
| c | 1 ³ / ₈ | 1 ³ / ₁₆ | 1 ³ / ₄ | 2 ³ / ₁₆ | 2 ¹ / ₂ | 3 ⁷ / ₃₂ | 5 | 5 | 6 ¹ / ₄ | 6 ¹ / ₄ |
| d | 1 ¹ / ₈ | 1 ¹ / ₄ | 1 ³ / ₈ | 1 ²⁷ / ₃₂ | 2 ⁵ / ₃₂ | 2 ²⁵ / ₃₂ | 4 ¹ / ₄ | 4 ¹ / ₄ | 5 ¹ / ₁₆ | 5 ¹ / ₁₆ |
| e | 3 ⁷ / ₃₂ | 3 ²⁷ / ₃₂ | 4 ⁹ / ₁₆ | 5 ⁷ / ₁₆ | 5 ⁷ / ₈ | 8 ³ / ₃₂ | 10 ⁷ / ₈ | 10 ⁷ / ₈ | 13 ⁷ / ₁₆ | 13 ⁷ / ₁₆ |

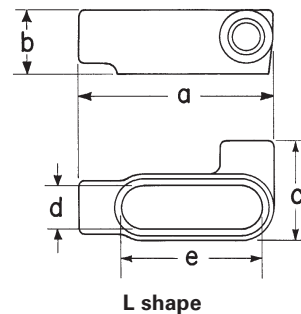
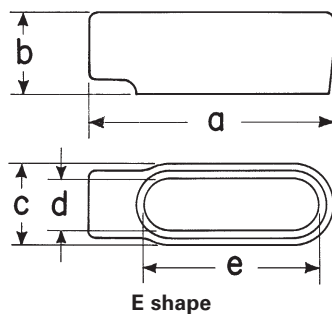

Form 7 E

| Hub size | ½" | ¾" | 1" |
|----------|--------------------------------|---------------------------------|-------------------------------|
| a | 4 ⁹ / ₁₆ | 5 ³ / ₁₆ | 6 |
| b | 1 ³ / ₈ | 1 ⁵ / ₈ | 1 ⁷ / ₈ |
| c | 1 ³ / ₈ | 1 ³ / ₁₆ | 1 ³ / ₄ |
| d | 1 ⁵ / ₁₆ | 1 ¹ / ₈ | 1 ³ / ₈ |
| e | 3 ⁷ / ₁₆ | 3 ¹³ / ₁₆ | 4 ¹ / ₂ |

Form 7 L

| Hub size | ½" | ¾" | 1" | 1¼" | 1½" | 2" |
|----------|--------------------------------|---------------------------------|-------------------------------|--------------------------------|---------------------------------|--------------------------------|
| a | 4 ⁹ / ₁₆ | 5 ³ / ₁₆ | 6 | 6 ¹ / ₂ | 7 ¹ / ₈ | 8 ¹ / ₈ |
| b | 1 ³ / ₈ | 1 ⁵ / ₈ | 1 ⁷ / ₈ | 2 ⁷ / ₁₆ | 2 ⁷ / ₁₆ | 3 ¹ / ₈ |
| c | 2 ¹ / ₄ | 2 ¹ / ₁₆ | 2 ³ / ₄ | 3 ³ / ₁₆ | 3 ⁹ / ₁₆ | 4 ¹ / ₈ |
| d | 1 ⁵ / ₁₆ | 1 ¹ / ₈ | 1 ³ / ₈ | 1 ³ / ₄ | 1 ¹⁵ / ₁₆ | 2 ¹ / ₁₆ |
| e | 3 ⁷ / ₁₆ | 3 ¹³ / ₁₆ | 4 ¹ / ₂ | 5 | 5 ⁷ / ₁₆ | 6 ³ / ₈ |

Condulet conduit bodies – cast iron or aluminum

Dimensions (in inches):

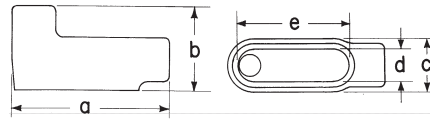

LB shape

Form 7 LB

| Hub size | ½" | ¾" | 1" | 1¼" | 1½" | 2" | 2½" | 3" | 3½" | 4" |
|----------|--------------------------------|---------------------------------|-------------------------------|--------------------------------|---------------------------------|--------------------------------|--------------------------------|--------------------------------|----------------------------------|----------------------------------|
| a | 4 ⁹ / ₁₆ | 5 ³ / ₁₆ | 6 | 6½ | 7 ¹ / ₈ | 8 ¹ / ₈ | 10½ | 10½ | 12 ¹¹ / ₁₆ | 12 ¹¹ / ₁₆ |
| b | 2¼ | 2½ | 2 ⁷ / ₈ | 3 ⁵ / ₁₆ | 3 ¹¹ / ₁₆ | 4¼ | 5 ¹ / ₈ | 5 ⁷ / ₈ | 6 ⁹ / ₁₆ | 7 ¹ / ₁₆ |
| c | 1 ³ / ₈ | 1 ³ / ₁₆ | 1 ³ / ₄ | 2 ³ / ₁₆ | 2 ⁷ / ₁₆ | 3 | 4¼ | 4¼ | 5¼ | 5¼ |
| d | 1 ⁵ / ₁₆ | 1 ¹ / ₈ | 1 ³ / ₈ | 1 ³ / ₄ | 1 ¹⁵ / ₁₆ | 2 ⁷ / ₁₆ | 3 ³ / ₁₆ | 3 ³ / ₁₆ | 4½ | 4½ |
| e | 3 ³ / ₁₆ | 3 ¹³ / ₁₆ | 4½ | 5 | 5 ¹ / ₁₆ | 6 ⁷ / ₈ | 8 ¹ / ₈ | 8 ¹ / ₈ | 10¼ | 10¼ |

Form 8 LB

| Hub size | ½" | ¾" | 1" | 1¼" | 1½" | 2" | 2½" | 3" | 3½" | 4" |
|----------|---------------------------------|---------------------------------|---------------------------------|---------------------------------|--------------------------------|---------------------------------|----------------------------------|----------------------------------|---------------------------------|---------------------------------|
| a | 4 ¹⁵ / ₁₆ | 5 ³ / ₁₆ | 6 ¹⁵ / ₃₂ | 7 ¹⁷ / ₃₂ | 9 ¹ / ₈ | 11 | 13 ¹⁵ / ₁₆ | 13 ¹⁵ / ₁₆ | 16 ¹ / ₈ | 16 ¹ / ₈ |
| b | 2 ⁷ / ₃₂ | 2 ¹ / ₁₆ | 2 ¹³ / ₁₆ | 3 ¹¹ / ₃₂ | 4 ¹ / ₃₂ | 4 ¹³ / ₁₆ | 6 ¹ / ₈ | 6 ¹ / ₂ | 7 ⁹ / ₁₆ | 7 ¹³ / ₁₆ |
| c | 1 ³ / ₈ | 1 ³ / ₁₆ | 1 ³ / ₄ | 2 ³ / ₁₆ | 2 ¹ / ₄ | 3 ³ / ₄ | 5 | 5 | 6¼ | 6¼ |
| d | 1 | 1 ³ / ₁₆ | 1 ³ / ₈ | 1 ³ / ₄ | 2 ¹ / ₈ | 3 | 4¼ | 4¼ | 5 ¹ / ₁₆ | 5 ¹ / ₁₆ |
| e | 3 ³ / ₁₆ | 3 ¹⁵ / ₁₆ | 4 ⁹ / ₁₆ | 5 ⁵ / ₁₆ | 6½ | 8 ⁷ / ₁₆ | 10 ¹ / ₈ | 10 ¹ / ₈ | 13 ¹ / ₁₆ | 13 ¹ / ₁₆ |

Mark 9 LB

| Hub size | ½" | ¾" | 1" | 1¼" | 1½" | 2" | 2½" | 3" | 3½" | 4" |
|----------|---------------------------------|---------------------------------|---------------------------------|--------------------------------|---------------------------------|---------------------------------|----------------------------------|----------------------------------|---------------------------------|---------------------------------|
| a | 4 ¹⁹ / ₃₂ | 5¼ | 6 ³ / ₃₂ | 7 ³ / ₃₂ | 7 ²⁵ / ₃₂ | 10 ³ / ₃₂ | 13 ¹⁵ / ₁₆ | 13 ¹⁵ / ₁₆ | 16 ¹ / ₈ | 16 ¹ / ₈ |
| b | 2 ⁷ / ₈ | 2 ¹⁵ / ₃₂ | 2 ¹³ / ₁₆ | 3 ⁵ / ₈ | 3 ⁷ / ₈ | 4 ¹⁹ / ₃₂ | 6 ¹ / ₈ | 6 ¹ / ₂ | 7 ⁹ / ₁₆ | 7 ⁹ / ₁₆ |
| c | 1 ³ / ₈ | 1 ¹⁹ / ₃₂ | 1 ³ / ₄ | 2 ³ / ₁₆ | 2 ¹ / ₂ | 3 ⁷ / ₃₂ | 5 | 5 | 6¼ | 6¼ |
| d | 1 ¹ / ₁₆ | 1 ⁹ / ₃₂ | 1 ⁷ / ₁₆ | 1 ⁷ / ₈ | 2 ¹ / ₁₆ | 2 ²⁹ / ₃₂ | 4¼ | 4¼ | 5 ¹ / ₁₆ | 5 ¹ / ₁₆ |
| e | 3 ⁹ / ₃₂ | 3 ²⁷ / ₃₂ | 4 ⁹ / ₁₆ | 5 ³ / ₁₆ | 5 ¹ / ₈ | 8 ³ / ₃₂ | 10 ¹ / ₈ | 10 ¹ / ₈ | 13 ¹ / ₁₆ | 13 ¹ / ₁₆ |

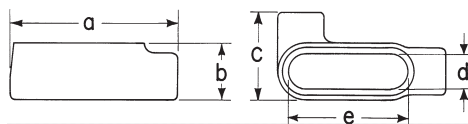

LL shape

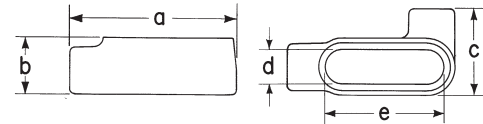

LR shape

Form 7 LL & LR

| Hub size | ½" | ¾" | 1" | 1¼" | 1½" | 2" | 2½" | 3" | 3½" | 4" |
|----------|--------------------------------|---------------------------------|-------------------------------|--------------------------------|---------------------------------|--------------------------------|--------------------------------|--------------------------------|----------------------------------|----------------------------------|
| a | 4 ⁹ / ₁₆ | 5 ³ / ₁₆ | 6 | 6½ | 7 ¹ / ₈ | 8 ¹ / ₈ | 10½ | 10½ | 12 ¹¹ / ₁₆ | 12 ¹¹ / ₁₆ |
| b | 1 ³ / ₈ | 1 ³ / ₁₆ | 1 ⁷ / ₈ | 2 ¹ / ₁₆ | 2 ¹ / ₁₆ | 3 ¹ / ₈ | 3 ³ / ₈ | 4 ⁷ / ₈ | 4 ⁷ / ₈ | 5 ¹ / ₈ |
| c | 2¼ | 2 ¹ / ₁₆ | 2 ³ / ₄ | 3 ⁵ / ₁₆ | 3 ⁹ / ₁₆ | 4 ¹ / ₈ | 5¼ | 5¼ | 6 ¹⁵ / ₁₆ | 6 ¹⁵ / ₁₆ |
| d | 1 ⁵ / ₁₆ | 1 ¹ / ₈ | 1 ³ / ₈ | 1 ³ / ₄ | 1 ¹⁵ / ₁₆ | 2 ⁷ / ₁₆ | 3 ³ / ₁₆ | 3 ³ / ₁₆ | 4½ | 4½ |
| e | 3 ³ / ₁₆ | 3 ¹³ / ₁₆ | 4½ | 5 | 5 ¹ / ₁₆ | 6 ⁷ / ₈ | 8 ¹ / ₈ | 8 ¹ / ₈ | 10¼ | 10¼ |

Form 8 LL & LR

| Hub size | ½" | ¾" | 1" | 1¼" | 1½" | 2" | 2½" | 3" |
|----------|---------------------------------|---------------------------------|---------------------------------|---------------------------------|---------------------------------|--------------------------------|----------------------------------|----------------------------------|
| a | 4 ¹⁵ / ₁₆ | 5 ³ / ₁₆ | 6 ¹⁵ / ₃₂ | 7 ¹⁷ / ₃₂ | 9 ¹ / ₈ | 11 | 13 ¹⁵ / ₁₆ | 13 ¹⁵ / ₁₆ |
| b | 1 ⁷ / ₁₆ | 1 ¹¹ / ₁₆ | 1 ¹⁵ / ₁₆ | 2 ¹ / ₈ | 2 ²⁹ / ₃₂ | 3 ¹ / ₁₆ | 4 ¹ / ₁₆ | 4 ¹³ / ₁₆ |
| c | 2 ² / ₃₂ | 2 ⁵ / ₁₆ | 2 ⁵ / ₈ | 3 ⁵ / ₃₂ | 4 | 5 | 6 ¹¹ / ₁₆ | 6 ¹¹ / ₁₆ |
| d | 1 | 1 ³ / ₁₆ | 1 ³ / ₈ | 1 ³ / ₄ | 2 ¹ / ₈ | 3 | 4¼ | 4¼ |
| e | 3 ³ / ₁₆ | 3 ¹⁵ / ₁₆ | 4 ⁹ / ₁₆ | 5 ⁵ / ₁₆ | 6½ | 8 ⁷ / ₁₆ | 10 ¹ / ₈ | 10 ¹ / ₈ |

Mark 9 LL & LR

| Hub size | ½" | ¾" | 1" | 1¼" | 1½" | 2" | 2½" | 3" | 3½" | 4" |
|----------|---------------------------------|---------------------------------|--------------------------------|--------------------------------|---------------------------------|---------------------------------|----------------------------------|----------------------------------|---------------------------------|---------------------------------|
| a | 4 ¹⁹ / ₃₂ | 5¼ | 6 ³ / ₃₂ | 7 ³ / ₃₂ | 7 ⁵¹ / ₆₄ | 10 ³ / ₃₂ | 13 ¹⁵ / ₁₆ | 13 ¹⁵ / ₁₆ | 16 ¹ / ₈ | 16 ¹ / ₈ |
| b | 1 ¹³ / ₃₂ | 1 ⁵ / ₈ | 1 ⁷ / ₈ | 2 ¹ / ₂ | 2 ³ / ₁₆ | 3 ¹ / ₁₆ | 4 ¹ / ₁₆ | 4 ¹⁹ / ₁₆ | 5 ¹¹ / ₁₆ | 5 ¹³ / ₁₆ |
| c | 2 ¹ / ₈ | 2 ⁵ / ₁₆ | 2 ¹ / ₁₆ | 3¼ | 3½ | 4 ¹³ / ₆₄ | 6 ¹¹ / ₁₆ | 6 ¹ / ₁₆ | 8 ¹ / ₈ | 8 ¹ / ₈ |
| d | 1 ¹ / ₁₆ | 1 ¹ / ₄ | 1 ³ / ₈ | 1 ³ / ₄ | 2 ¹ / ₁₆ | 2 ²⁹ / ₃₂ | 4¼ | 4¼ | 5 ¹ / ₁₆ | 5 ¹ / ₁₆ |
| e | 3 ⁹ / ₃₂ | 3 ²⁷ / ₃₂ | 4 ⁹ / ₁₆ | 5 ³ / ₁₆ | 5 ¹ / ₈ | 8 ³ / ₃₂ | 10 ¹ / ₈ | 10 ¹ / ₈ | 13 ¹ / ₁₆ | 13 ¹ / ₁₆ |

Condulet conduit bodies – cast iron or aluminum

Dimensions (in inches):

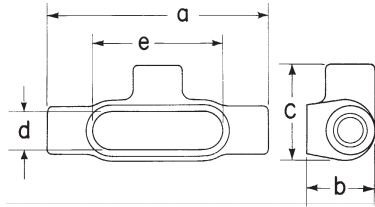

T shape

Form 7 T

| Hub size | a | b | c | d | e |
|----------|---------------------------------|--------------------------------|---------------------------------|---------------------------------|---------------------------------|
| 1/2" | 5 ⁵ / ₈ | 1 ³ / ₄ | 2 ⁷ / ₁₆ | 1 ⁵ / ₁₆ | 3 ⁷ / ₁₆ |
| 3/4" | 6 ¹ / ₄ | 2 | 2 ⁵ / ₈ | 1 ¹ / ₈ | 3 ¹³ / ₁₆ |
| 1" | 7 ¹ / ₄ | 2 ¹ / ₄ | 3 | 1 ³ / ₈ | 4 ¹ / ₂ |
| 1 1/4" | 7 ⁷ / ₁₆ | 2 ⁵ / ₁₆ | 3 ³ / ₁₆ | 1 ³ / ₄ | 5 |
| 1 1/2" | 8 ³ / ₁₆ | 2 ⁹ / ₁₆ | 3 ⁹ / ₁₆ | 1 ¹⁵ / ₁₆ | 5 ¹ / ₁₆ |
| 2" | 9 ³ / ₁₆ | 3 ³ / ₈ | 4 ¹ / ₈ | 2 ¹ / ₁₆ | 6 ³ / ₈ |
| 2 1/2" | 12 | 3 ³ / ₈ | 5 ¹ / ₄ | 3 ⁷ / ₁₆ | 8 ⁷ / ₈ |
| 3" | 12 ¹ / ₁₆ | 4 ³ / ₈ | 5 ¹ / ₄ | 3 ⁹ / ₁₆ | 8 ⁷ / ₈ |
| 3 1/2" | 14 ⁷ / ₁₆ | 4 ⁷ / ₈ | 6 ¹⁵ / ₁₆ | 4 ¹ / ₂ | 10 ¹ / ₄ |
| 4" | 14 ⁹ / ₁₆ | 5 ³ / ₈ | 6 ¹⁵ / ₁₆ | 4 ¹ / ₂ | 10 ¹ / ₄ |

Form 8 T

| Hub size | a | b | c | d | e |
|----------|---------------------------------|---------------------------------|---------------------------------|--------------------------------|---------------------------------|
| 1/2" | 5 ¹¹ / ₁₆ | 1 ³ / ₄ | 2 ⁹ / ₃₂ | 1 | 3 ⁹ / ₁₆ |
| 3/4" | 6 ⁹ / ₃₂ | 2 | 2 ⁹ / ₁₆ | 1 ¹ / ₁₆ | 3 ¹⁵ / ₁₆ |
| 1" | 7 ⁷ / ₁₆ | 2 ¹ / ₄ | 2 ⁹ / ₈ | 1 ³ / ₈ | 4 ⁷ / ₁₆ |
| 1 1/4" | 8 ¹ / ₂ | 2 ⁵ / ₈ | 3 ⁵ / ₃₂ | 1 ³ / ₄ | 5 ⁵ / ₁₆ |
| 1 1/2" | 10 ³ / ₈ | 2 ²⁵ / ₃₂ | 4 | 2 ¹ / ₈ | 6 ¹ / ₂ |
| 2" | 12 ¹ / ₄ | 3 ⁹ / ₁₆ | 5 | 3 | 8 ⁷ / ₁₆ |
| 2 1/2" | 15 ⁵ / ₈ | 4 ¹ / ₁₆ | 6 ¹¹ / ₁₆ | 4 ¹ / ₄ | 10 ⁷ / ₈ |
| 3" | 15 ⁵ / ₈ | 4 ¹³ / ₁₆ | 6 ¹¹ / ₁₆ | 4 ¹ / ₄ | 10 ⁷ / ₈ |

Mark 9 T

| Hub size | a | b | c | d | e |
|----------|---------------------------------|---------------------------------|---------------------------------|---------------------------------|---------------------------------|
| 1/2" | 5 | 1 ¹³ / ₃₂ | 2 ¹ / ₈ | 1 ¹ / ₁₆ | 3 ⁹ / ₃₂ |
| 3/4" | 5 ¹¹ / ₁₆ | 1 ⁵ / ₈ | 2 ⁵ / ₁₆ | 1 ¹ / ₄ | 3 ²⁷ / ₃₂ |
| 1" | 6 ¹⁹ / ₃₂ | 1 ⁷ / ₈ | 2 ¹¹ / ₁₆ | 1 ³ / ₈ | 4 ⁷ / ₁₆ |
| 1 1/4" | 7 ⁷ / ₈ | 2 ¹ / ₂ | 3 ¹ / ₄ | 1 ⁷ / ₈ | 5 ¹ / ₁₆ |
| 1 1/2" | 8 ¹¹ / ₃₂ | 2 ¹³ / ₁₆ | 3 ¹ / ₂ | 2 ¹ / ₁₆ | 5 ⁷ / ₈ |
| 2" | 10 ³ / ₈ | 3 ¹ / ₁₆ | 4 ¹³ / ₃₂ | 2 ²⁹ / ₃₂ | 8 ⁷ / ₃₂ |
| 2 1/2" | 15 ⁵ / ₈ | 4 ⁷ / ₁₆ | 6 ¹¹ / ₁₆ | 4 ¹ / ₄ | 10 ⁷ / ₈ |
| 3" | 15 ⁵ / ₈ | 4 ¹³ / ₁₆ | 6 ¹¹ / ₁₆ | 4 ¹ / ₄ | 10 ⁷ / ₈ |
| 3 1/2" | 18 ⁷ / ₄ | 5 ¹¹ / ₁₆ | 8 ⁷ / ₈ | 5 ¹ / ₁₆ | 13 ¹ / ₁₆ |
| 4" | 18 ⁷ / ₄ | 5 ¹⁵ / ₁₆ | 8 ⁷ / ₈ | 5 ¹ / ₁₆ | 13 ¹ / ₁₆ |

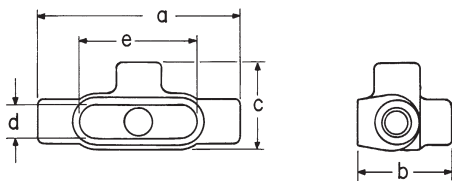

TA shape

Form 7 TA

| Hub size | a | b | c | d | e |
|----------|--------------------------------|---------------------------------|--------------------------------|---------------------------------|---------------------------------|
| 1/2" | 5 ⁵ / ₈ | 2 ⁵ / ₈ | 2 ⁷ / ₁₆ | 1 ⁵ / ₁₆ | 3 ⁷ / ₁₆ |
| 3/4" | 6 ¹ / ₄ | 2 ¹ / ₈ | 2 ⁵ / ₈ | 1 ¹ / ₈ | 3 ¹³ / ₁₆ |
| 1" | 7 ¹ / ₄ | 3 ¹ / ₄ | 3 | 1 ³ / ₈ | 4 ¹ / ₂ |
| 1 1/4" | 7 ⁷ / ₁₆ | 3 ⁵ / ₁₆ | 3 ³ / ₁₆ | 1 ³ / ₄ | 5 |
| 1 1/2" | 8 ³ / ₁₆ | 3 ¹¹ / ₁₆ | 3 ⁹ / ₁₆ | 1 ¹⁵ / ₁₆ | 5 ¹ / ₁₆ |
| 2" | 9 ³ / ₁₆ | 4 ¹ / ₄ | 4 ¹ / ₈ | 2 ¹ / ₁₆ | 6 ³ / ₈ |

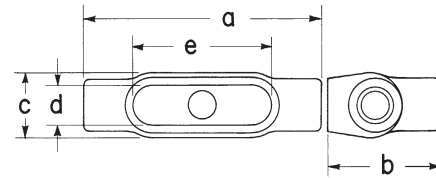

TB shape

Form 7 TB

| Hub size | a | b | c | d | e |
|----------|--------------------------------|--------------------------------|--------------------------------|---------------------------------|---------------------------------|
| 1/2" | 5 ⁵ / ₈ | 2 ⁵ / ₈ | 1 ⁹ / ₁₆ | 1 ⁵ / ₁₆ | 3 ⁷ / ₁₆ |
| 3/4" | 6 ¹ / ₄ | 2 ¹ / ₈ | 1 ³ / ₄ | 1 ¹ / ₈ | 3 ¹³ / ₁₆ |
| 1" | 7 ¹ / ₄ | 3 ¹ / ₄ | 2 | 1 ³ / ₈ | 4 ¹ / ₂ |
| 1 1/4" | 7 ⁷ / ₁₆ | 3 ⁵ / ₁₆ | 2 ³ / ₁₆ | 1 ³ / ₄ | 5 |
| 1 1/2" | 8 ³ / ₁₆ | 5 | 2 ¹ / ₁₆ | 1 ¹⁵ / ₁₆ | 5 ¹ / ₁₆ |
| 2" | 9 ³ / ₁₆ | 6 ¹ / ₈ | 3 | 2 ¹ / ₁₆ | 6 ³ / ₈ |

Form 8 TB

| Hub size | a | b | c | d | e |
|----------|---------------------------------|---------------------------------|--------------------------------|--------------------------------|---------------------------------|
| 1/2" | 5 ¹¹ / ₁₆ | 2 ¹⁷ / ₃₂ | 1 ³ / ₈ | 1 | 3 ⁹ / ₁₆ |
| 3/4" | 6 ⁹ / ₃₂ | 2 ³ / ₄ | 1 ⁹ / ₁₆ | 1 ³ / ₁₆ | 3 ¹⁵ / ₁₆ |
| 1" | 7 ⁷ / ₁₆ | 3 ¹ / ₈ | 1 ³ / ₄ | 1 ³ / ₈ | 4 ⁷ / ₁₆ |
| 1 1/4" | 8 ¹ / ₂ | 3 ¹¹ / ₃₂ | 2 ³ / ₁₆ | 1 ³ / ₄ | 5 ⁵ / ₁₆ |
| 1 1/2" | 10 ³ / ₈ | 4 ¹ / ₃₂ | 2 ¹ / ₄ | 2 ¹ / ₈ | 6 ¹ / ₂ |
| 2" | 12 ¹ / ₄ | 4 ¹³ / ₁₆ | 3 ³ / ₄ | 3 | 8 ⁷ / ₁₆ |

Mark 9 TB

| Hub size | a | b | c | d | e |
|----------|---------------------------------|---------------------------------|--------------------------------|---------------------------------|---------------------------------|
| 1/2" | 5 ¹¹ / ₁₆ | 2 ³³ / ₆₄ | 1 ³ / ₈ | 1 | 3 ⁹ / ₁₆ |
| 3/4" | 6 ⁹ / ₁₆ | 2 ¹ / ₈ | 1 ⁹ / ₁₆ | 1 ³ / ₁₆ | 3 ¹⁵ / ₁₆ |
| 1" | 7 ⁷ / ₁₆ | 3 ¹ / ₈ | 1 ³ / ₄ | 1 ³ / ₈ | 4 ⁷ / ₁₆ |
| 1 1/4" | 8 ¹ / ₂ | 3 ¹¹ / ₃₂ | 2 ³ / ₁₆ | 1 ³ / ₄ | 5 ⁵ / ₁₆ |
| 1 1/2" | 8 ¹¹ / ₃₂ | 3 ¹ / ₈ | 2 ¹ / ₂ | 2 ³ / ₁₆ | 5 ⁷ / ₈ |
| 2" | 10 ⁷ / ₈ | 4 ¹⁵ / ₃₂ | 3 ¹ / ₃₂ | 2 ¹³ / ₁₆ | 8 ⁷ / ₃₂ |

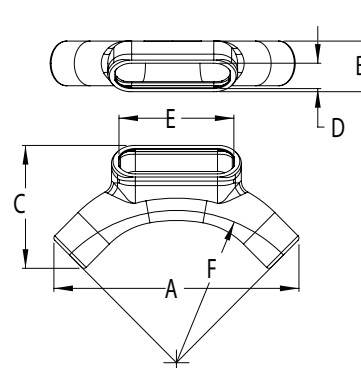

U shape

Form 7 U

| Hub size | A | B | C | D | E | F (bend radius) |
|----------|---------------------------------|---------------------------------|---------------------------------|---------------------------------|---------------------------------|-----------------|
| 1/2" | 7 ¹ / ₈ | 1 ¹ / ₂ | 3 ¹¹ / ₁₆ | 1 ⁵ / ₁₆ | 3 ⁷ / ₁₆ | 4.4 |
| 3/4" | 7 ¹ / ₂ | 1 ¹¹ / ₁₆ | 3 ⁷ / ₈ | 1 ¹ / ₈ | 3 ¹³ / ₁₆ | 4.6 |
| 1" | 9 ¹¹ / ₁₆ | 2 | 4 ¹³ / ₁₆ | 1 ³ / ₈ | 4 ¹ / ₂ | 6.0 |
| 1 1/4" | 12 | 2 ¹ / ₂ | 5 ¹⁵ / ₁₆ | 1 ³ / ₄ | 5 | 7.4 |
| 1 1/2" | 15 ⁵ / ₈ | 2 ¹ / ₈ | 7 ³ / ₁₆ | 1 ¹⁵ / ₁₆ | 5 ¹ / ₁₆ | 9.6 |
| 2" | 17 ⁹ / ₁₆ | 3 ³ / ₈ | 8 ³ / ₈ | 2 ¹ / ₁₆ | 6 ³ / ₈ | 10.9 |

Condulet conduit bodies – cast iron or aluminum

Dimensions (in inches):

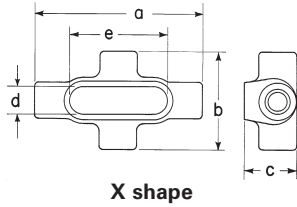

Form 7 X

| Hub size | a | b | c | d | e |
|----------|--------------------------------|--------------------------------|--------------------------------|---------------------------------|---------------------------------|
| 1/2" | 5 ⁵ / ₈ | 3 ⁵ / ₁₆ | 1 ³ / ₄ | 1 ⁵ / ₁₆ | 3 ³ / ₁₆ |
| 3/4" | 6 ¹ / ₄ | 3 ¹ / ₂ | 2 | 1 ¹ / ₈ | 3 ¹³ / ₁₆ |
| 1" | 7 ¹ / ₄ | 4 | 2 ¹ / ₄ | 1 ³ / ₈ | 4 ¹ / ₂ |
| 1 1/4" | 7 ⁷ / ₁₆ | 4 ¹ / ₈ | 2 ⁵ / ₁₆ | 1 ³ / ₄ | 5 |
| 1 1/2" | 8 ³ / ₁₆ | 4 ⁵ / ₈ | 2 ³ / ₁₆ | 1 ¹⁵ / ₁₆ | 5 ⁷ / ₁₆ |
| 2" | 9 ³ / ₁₆ | 5 ³ / ₁₆ | 3 ³ / ₈ | 2 ⁷ / ₁₆ | 6 ⁷ / ₈ |

Form 8 X

| Hub size | a | b | c | d | e |
|----------|---------------------------------|---------------------------------|---------------------------------|--------------------------------|---------------------------------|
| 1/2" | 5 ¹¹ / ₁₆ | 2 ²⁹ / ₃₂ | 1 ³ / ₄ | 1 | 3 ⁷ / ₁₆ |
| 3/4" | 6 ⁹ / ₃₂ | 3 ¹ / ₁₆ | 2 | 1 ³ / ₁₆ | 3 ¹⁵ / ₁₆ |
| 1" | 7 ³ / ₁₆ | 3 ¹ / ₂ | 2 ¹ / ₄ | 1 ³ / ₈ | 4 ⁹ / ₁₆ |
| 1 1/4" | 8 ¹ / ₂ | 4 ¹ / ₈ | 2 ⁵ / ₈ | 1 ³ / ₄ | 5 ⁷ / ₁₆ |
| 1 1/2" | 10 ³ / ₈ | 5 ¹ / ₄ | 2 ¹⁵ / ₃₂ | 2 ¹ / ₈ | 6 ¹ / ₂ |
| 2" | 12 ¹ / ₄ | 6 ¹ / ₄ | 3 ³ / ₁₆ | 3 | 8 ³ / ₁₆ |

Mark 9 X

| Hub size | a | b | c | d | e |
|----------|---------------------------------|---------------------------------|-------------------------------|--------------------------------|---------------------------------|
| 1/2" | 5 ¹¹ / ₁₆ | 2 ⁵⁷ / ₆₄ | 1 ³ / ₄ | 1 | 3 ⁷ / ₁₆ |
| 3/4" | 6 ⁹ / ₁₆ | 3 ¹ / ₄ | 2 | 1 ³ / ₁₆ | 3 ¹⁵ / ₁₆ |
| 1" | 7 ⁵ / ₁₆ | 3 ¹ / ₂ | 2 ¹ / ₄ | 1 ³ / ₈ | 4 ⁹ / ₁₆ |