

UL Recognized power distribution blocks



Catalog number example:

16220-3 is a 3-pole 16220

Where:

- The prefix "16220" defines the block's lineside characteristics (i.e., one conductor port per pole that accepts 2/0 - #14 Cu, or 2/0 - #8 Al conductors) and the loadside characteristics (i.e., four conductor ports per pole that each accepts #4 - #14 Cu or #4 - #8 Al conductors).
- The suffix "3" in this example defines this as a three-pole block.
- See the catalog number tables for details on the available lineside/loadside characteristics.

How to order:

From the catalog number tables, select the catalog number that defines the desired lineside/loadside port and conductor characteristics.

Add to the catalog number the suffix that defines the desired pole configuration. Note, you must select from the available number of poles for each catalog number. These appear in the second column of the catalog number tables.

Specifications:

Ratings

- Volts: 600 V
- Amps: 175 to 1520 A
- SCCR: up to 200 kA* (see table for SCCR by catalog number)
- * Maximum SCCR contingent upon the application of an upstream current-limiting overcurrent protective device. See table for fusing requirements.

Flammability rating

- UL 94 V0

Storage and operating temperature range

- -4°F to 248°F (-20°C to 120°C)

Agency information

- UL 1059 Recognized, Guide XCFR2, File E62622
- CSA® Certified, Class 6228-01, File 15364

Conductors†

- Stranded 75°C copper and aluminum
- Higher temperature rated conductors permitted with appropriate derating

† As specified in the catalog number table.

Optional covers

- See table for catalog numbers and ordering details

Catalog symbols:

- 160__-(poles)
- 162__-(poles)
- 163__-(poles)
- 164__-(poles)
- 165__-(poles)

Description:

Bussmann™ series UL® Recognized power distribution blocks offer a variety of lineside and loadside port configurations to provide greater flexibility in panel wiring and wire management.

These blocks are UL Recognized to UL 1059 and rated for use in UL 508A industrial control panels.

Blocks are factory configured in 1-, 2 and 3-pole versions, and have optional covers to enhance safety (order covers separately).



Powering Business Worldwide

Catalog numbers:

Line/load port configuration	No. of poles	Current rating (A)	Lineside				Loadside					
			Wire size (Sol/ferrule unless noted)*	Wires per port	Torque N•m (Lb-in)	Ports/pole	Wire size (Sol/ferrule unless noted)*	Wires per port	Torque N•m (Lb-in)	Ports/pole	Max SCCR (kA)†	Catalog Number
	2, 3, 4	175	2/0 - #1 Cu/Al (Str)	1	13.6 (120)	1	#4 - #6 Cu/Al (Str)	1	4.0 (35)	6	10	16021-
			#2 - #3 Cu/Al	1			#8 Cu	1	2.8 (25)			
			#4 - #8 Cu/Al	1-2			#8 Al (Str)	1-2				
			#10 - #14 Cu	1-2			#10 - #14 Cu	1-2	2.3 (20)			
	1, 2, 3	175	2/0 - #1 Cu/Al (Str)	1	13.6 (120)	1	#4 - #6 Cu/Al (Str)	1	4.0 (35)	4	200	16220-
			#2 - #3 Cu/Al	1			#8 Cu	1	2.8 (25)			
			#4 - #8 Cu/Al	1-2			#8 Al (Str)	1-2				
			#10 - #14 Cu	1-2			#10 - #14 Cu	1-2	2.3 (20)			
	1, 2, 3	175	2/0 - #1 Cu/Al (Str)	1	13.6 (120)	1	#4 - #6 Cu/Al (Str)	1	4.0 (35)	4	200	16220-H ††
			#2 - #3 Cu/Al	1			#8 Cu	1	2.8 (25)			
			#4 - #8 Cu/Al	1-2			#8 Al (Str)	1-2				
			#10 - #14 Cu	1-2			#10 - #14 Cu	1-2	2.3 (20)			
	1, 2, 3	175	2/0 - #1 Cu/Al (Str)	1	13.6 (120)	1	#4 - #6 Cu/Al (Str)	1	4.0 (35)	6	200	16321-
			#2 - #3 Cu/Al	1			#8 Cu	1	2.8 (25)			
			#4 - #8 Cu/Al	1-2			#8 Al (Str)	1-2				
			#10 - #14 Cu	1-2			#10 - #14 Cu	1-2	2.3 (20)			
	2,3,4	310	350kcmil - 2/0 Cu/Al (Str)	1	31.1 (275)††	1	#4 - #6 Cu/Al (Str)	1	4.0 (35)	6	10	16023-
			1/0 Cu/Al (Str)	1-2			#8 Cu	1	2.8 (25)			
			#1 - #6 Cu/Al	1-2			#8 Al (Str)	1-2				
							#10 - #12 Al (Str)	1	2.3 (20)			
	1, 2, 3	310	350kcmil - 2/0 Cu/Al (Str)	1	31.1 (275)††	1	#4 - #6 Cu/Al (Str)	1	4.0 (35)	6	200	16323-
			1/0 Cu/Al (Str)	1-2			#8 Cu	1	2.8 (25)			
			#1 - #6 Cu/Al	1-2			#8 Al (Str)	1-2				
							#10 - #14 Cu	1-2	2.3 (20)			
	1, 2, 3	310	350kcmil - 2/0 Cu/Al (Str)	1	31.1 (275)††	1	#2 - #3 Cu/Al (Str)	1	5.6 (50)	3	10	16332-
			1/0 Cu/Al (Str)	1-2			#4 Cu/Al	1	5.1 (45)			
			#1 - #6 Cu/Al	1-2			#6 Cu/Al	1-2	4.5 (40)			
							#8 Cu/Al	1-2	4.0 (35)			
	1, 2, 3	310	350kcmil - 2/0 Cu/Al (Str)	1	31.1 (275)††	1	#4 - #6 Cu/Al (Str)	1	4.0 (35)	12	200	16370-
			1/0 Cu/Al (Str)	1-2			#8 Cu	1	2.8 (25)			
			#1 - #6 Cu/Al	1-2			#8 Al (Str)	1-2				
							#10 - #12 Al (Str)	1	2.3 (20)			
	1, 2, 3	310	350kcmil - 2/0 Cu/Al (Str)	1	31.1 (275)††	1	#2 - #3 Cu/Al (Str)	1	5.6 (50)	6	200	16371-
			1/0 Cu/Al (Str)	1-2			#4 - #6 Cu/Al (Str)	1	5.1 (45)			
			#1 - #6 Cu/Al	1-2			#8 Cu/Al (Str)	1	4.5 (40)			
							#10 - #14 Cu (Str)	1	4.0 (35)			
	1, 2, 3	310	350kcmil - 2/0 Cu/Al (Str)	1	31.1 (275)††	1	1/0 - #3 Cu/Al (Str)	1		3	10	16372-
			1/0 Cu/Al (Str)	1-2			#4 - #8 Al (Str)	1-2	13.6 (120)			
			#1 - #6 Cu/Al	1-2			#6 - #14 Cu	2				
							#4 - #8 Al (Str)	2				

* 75°C wire (higher temperature rated wire acceptable with appropriate derating). Using a ferrule on a stranded conductor requires a correctly sized UL Listed ferrule (customer supplied) applied according to the manufacturer's specifications. Ferrule ratings apply to copper wire only.







** Not covered by CSA certification.

† See Short-Circuit Current Ratings table for the tested upstream overcurrent protective devices necessary for achieving these SCCRs.

†† Torque rating for dual wire and ferrule application is 30.5 N•m (270 Lb-in).

††† Configuration includes hex screws.

Catalog numbers cont.:

Line/load port configuration	No. of poles	Current rating (A)	Lineside				Loadside							
			Wire size (Sol/ferrule unless noted)*	Wires per port	Torque N•m (Lb-in)	Ports/pole	Wire size (Sol/ferrule unless noted)*	Wires per port	Torque N•m (Lb-in)	Ports/pole	Max SCCR (kA) [†]	Catalog number		
	1, 2, 3	310	350kcmil - 2/0 Cu/Al (Str)	1	31.1 (275) ^{††}	1	#10 Cu/Al	1	0.8 (7)	14				
	1, 2, 3	310	1/0 Cu/Al (Str)	1-2			#12 - #14 Cu	1						
			#1 - #6 Cu/Al	1-2			1/0 - #3 Cu/Al (Str)	1						
	1, 2, 3	350	2/0 - #1 Cu/Al (Str)	1	13.6 (120)	2	#4 Cu	1				10		16373- _{__}
			#2 - #3 Cu/Al	1			#6 - #14 Cu	1-2	13.6 (120)	3				
			#4 - #8 Cu/Al	1-2			#4 - #8 Al (Str)	1-2						
			#10 - #14 Cu	1-2			#10 - #14 Al (Str)	1						
	1, 2, 3	380	500kcmil - 4/0 Cu/Al (Str)	1	56.5 (500)	1	#2 - #3 Cu/Al (Str)	1	5.6 (50)					
			3/0 - 1/0 Cu/Al (Str)	1-2			#4 Cu/Al	1	5.1 (45)					
			#1 - #6 Cu/Al	1-2			#6 Cu/Al	1-2	4.5 (40)	6		10		16330- _{__}
							#10 - #12 Al (Str)	1	4.0 (35)					
							#10 - #14 Cu	1-2						
	1, 2, 3	380	500kcmil - 4/0 Cu/Al (Str)	1	56.5 (500)	1	#2 - #3 Cu/Al (Str)	1	5.6 (50)					
			3/0 - 1/0 Cu/Al (Str)	1-2			#4 Cu/Al	1	5.1 (45)	3				
			#1 - #6 Cu/Al	1-2			#6 Cu/Al	1-2	4.5 (40)					
							#8 Cu/Al	1-2	4.0 (35)			10		16335- _{__}
							#10 - #14 Cu	1-2						
							1/0 - #3 Cu/Al (Str)	1						
							#4 Cu	1	13.6 (120)	2				
							#4 - #8 Al (Str)	1-2						
							#6 - #14 Cu	1-2						
	1, 2, 3	380	500kcmil - 4/0 Cu/Al (Str)	1	56.5 (500)	1	#6 Cu/Al (Str)	1	4.0 (35)					
			3/0 - 1/0 Cu/Al (Str)	1-2			#8 Cu	1	2.8 (25)			21	10	16541- _{__}
			#1 - #6 Cu/Al	1-2			#8 Al (Str)	1-2						
							#10 - #14 Al (Str)	1	2.3 (20)					
							#10 - #14 Cu	1-2						
	1, 2, 3	420	600kcmil - #2 Cu/Al (Str)	1	56.5 (500)	1	#4 - #6 Cu/Al (Str)	1	4.0 (35)					
							#8 Cu	1	2.8 (25)					
							#8 Al (Str)	1-2				12	10	16375- _{__}
							#10 - #12 Al (Str)	1	2.3 (20)					
							#10 - #14 Cu	1-2						

* 75°C wire (higher temperature rated wire acceptable with appropriate derating). Using a ferrule on a stranded conductor requires a correctly sized UL Listed ferrule (customer supplied) applied according to the manufacturer's specifications. Ferrule ratings apply to copper wire only.

† See Short-Circuit Current Ratings table for the tested upstream overcurrent protective devices necessary for achieving these SCCR's.

†† Dual wire and ferrule application torque rating = 30.5 N•m (270 Lb-in).

Short-Circuit Current Rating (SCCR) data:

Catalog number	No. of poles	Conductors (AWG or kcmil)		Fuse Class/Bussmann series symbol/ampacity				
		Lineside	Loadside	J/ LPJ	RK1/ LPN-RK (250 V), LPS-RK (600 V)	RK5/ FRN-R (250 V), FRS-R (600 V)	T/ JJJ (300 V), JJS (600 V)	SCCR
16220- _{__}	1, 2, 3	2/0 - #8	#4 - #12	200	200	60	200	200 kA
			#4 - #14	175	100	60	175	100 kA
16321- _{__}	1, 2, 3	2/0 - #8	#4 - #12	400	200	100	400	200 kA
				175	100	60	175	100 kA
16323- _{__}	1, 2, 3	350 - #4	#4 - #8	400	200	100	400	200 kA
			#4 - #12	175	100	60	175	100 kA
16370- _{__}	1, 2, 3	350 - #4	#4 - #8	400	200	100	400	200 kA
			#4 - #14	175	100	60	175	100 kA
16371- _{__}	1, 2, 3	350 - #4	1/0 - #6	400	200	100	400	200 kA
			1/0 - #12	175	100	60	175	100 kA

Catalog numbers cont.:

		Lineside					Loadside						
Line/load port configuration	No. of poles	Current rating (A)	Wire size (Str/ferrule unless noted)*	Wires per port	Torque N•m (Lb-in)	Ports/pole	Wire size (Str/ferrule unless noted)*	Wires per port	Torque N•m (Lb-in)	Ports/pole	Max SCCR (kA)†	Catalog number	
	1, 2, 3	420	600kcmil - #2 Cu/Al (Str)	1	56.5 (500)	1	#2 - #3 Cu/Al (Str)	1	5.6 (50)				
							#4 Cu/Al	1	5.1 (45)	6			
							#6 Cu/Al	1-2					
							#8 Cu/Al	1-2	4.5 (40)				
							#10 - #14 Cu	1-2	4.0 (35)		10	16376-	
							1/0 - #3 Cu/Al (Str)	1					
							#4 Cu	1	13.6 (120)	3			
							#6 - #14 Cu	1-2					
							#4 - #8 Al (Str)	1-2					
	1, 2, 3	570	300kcmil - 2/0 Cu/Al (Str)	1			#4 - #6 Cu/Al (Str)	1	4.0 (35)				
			1/0 Cu/Al (Str)	1-2			#8 Cu	1	2.8 (25)	12	10	16377-	
			#1 - #2 Cu/Al	1-2	31.1 (275)††	2	#8 Al (Str)	1-2					
			#4 Cu/Al (Str)	1-2			#10 - #12 Al (Str)	1	2.3 (20)				
							#10 - #14 Cu	1-2					
	1, 2, 3	760	500kcmil - 4/0 Cu/Al (Str)	1			#4 - #6 Cu/Al (Str)	1	4.0 (35)				
			3/0 - 1/0 Cu/Al (Str)	1-2	56.5 (500)	2	#8 Cu	1	2.8 (25)	12	10	16530-	
			#1 - #6 Cu/Al	1-2			#8 Al (Str)	1-2					
							#10 - #14 Al (Str)	1	2.3 (20)				
							#10 - #14 Cu	1-2					
	1, 2, 3	840	600kcmil - #2 Cu/Al	1	56.5 (500)	2	3/0 - #6 Cu/Al (Str)	1	13.6 (120)	4			
							#4 - #6 Cu/Al (Str)	1	4.0 (35)				
							#8 Cu	1	2.8 (25)	4	10	16528-	
							#8 Al (Str)	1-2					
							#10 - #14 Al (Str)	1	2.3 (20)				
							#10 - #14 Cu	1-2					
	1	1520	500kcmil - 4/0 Cu/Al (Str)	1			#2 - #3 Cu/Al (Str)	1	5.6 (50)				
							#4 Cu/Al	1	5.1 (45)	22			
							#6 Cu/Al	1-2					
							#8 Cu/Al	1-2	4.5 (40)				
							#10 - #14 Cu	1-2	4.0 (35)		10	16400	
							1/0 - #3 Cu/Al (Str)	1					
							#4 Cu	1	13.6 (120)	6			
							#4 - #8 Al (Str)	1-2					
							#6 - #14 Cu	1-2					

* 75°C wire (higher temperature rated wire acceptable with appropriate derating). Using a ferrule on a stranded conductor requires a correctly sized UL Listed ferrule (customer supplied) applied according to the manufacturer's specifications. Ferrule ratings apply to copper wire only.

† See Short-Circuit Current Ratings table for the tested upstream overcurrent protective devices necessary for achieving these SCCRs.

†† Dual wire and ferrule application torque rating = 30.5 N•m (270 Lb-in).

Dual wire port application

- Rated for dual wire port application to increase the possible number of lineside and loadside connections. E.g., 16220-1 can accept two wires into the lineside port (#4 - #14 Cu, #4 - #8 Al) and two wires per port (eight connections total) on the loadside lug (#8 - #14 Cu, #8 Al).
- Dual wire applications are only viable when using two wires of the same size, stranding, and insulating and conductor material.

Ferrule terminal application

- Busmann series UL Recognized power distribution blocks are rated for use with UL Listed ferrules (see catalog number table for details).
- Ferrule applications allow for the use of a broader range of conductor stranding and simulate a more efficient, solid wire connection with the terminal port.
- Always use UL Listed ferrules in accordance with the manufacturer's specifications and instructions.

Dimensions — in

160_blocks

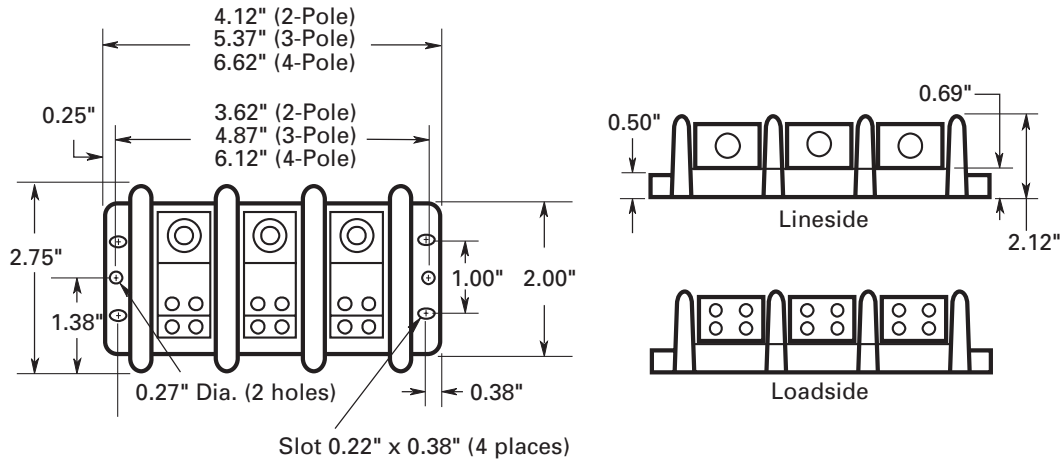

162_, 163_ and 165_ blocks

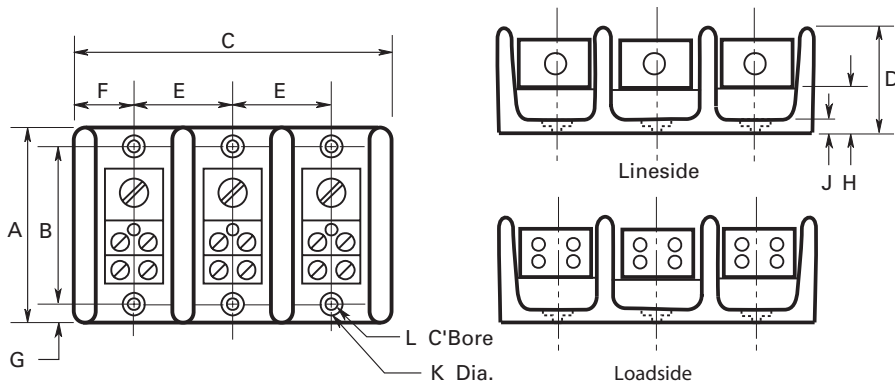

Catalog number prefix	A	B	C1	C2	C3	D	E	F	G	H	J	K	L
162_	2.88	2.25	1.07	1.88	2.70	1.75	0.82	0.54	0.32	0.84	0.31	0.20	0.41
163_	4.0	3.38	1.98	3.60	5.21	3.32	1.62	0.99	0.31	0.88	0.35	Slot 0.20" wide x 0.41" long	Slot 0.42" wide x 0.62" long
165_	5.5	4.75	3.11	5.76	8.48	2.94	2.69	1.55	0.36	1.19	0.44	Slot 0.20" wide x 0.33" long	Slot 0.41" wide x 0.53" long

Optional covers

For block catalog number starting	Order cover catalog number
160_	CPB160-(poles)*
162_	CPB162-(poles)*
163_	CPDB-(poles)*
165_	CPDB165**

* Order one cover for each block by specifying the number of poles in the catalog number suffix. E.g., For the block catalog number 16021-4, order the cover catalog number CPD160-4.

** Order one cover for each of the block's poles. E.g., For block catalog number 16530-3, order three of cover catalog number CPDB165.

The only controlled copy of this data sheet is the electronic read-only version located on the Eaton network drive. All other copies of this document are by definition uncontrolled. This bulletin is intended to clearly present comprehensive product data and provide technical information that will help the end user with design applications. Eaton reserves the right, without notice, to change design or construction of any products and to discontinue or limit distribution of any products. Eaton also reserves the right to change or update, without notice, any technical information contained in this bulletin. Once a product has been selected, it should be tested by the user in all possible applications.

Eaton
1000 Eaton Boulevard
Cleveland, OH 44122
Eaton.com

Bussmann Division
114 Old State Road
Ellisville, MO 63021
United States
Eaton.com/bussmannseries

© 2017 Eaton
All Rights Reserved
Printed in USA
Publication No. 10533 — BU-MC16056
September 2017

Eaton and Bussmann are valuable trademarks of Eaton in the U.S. and other countries. You are not permitted to use the Eaton trademarks without prior written consent of Eaton.

CSA is a registered trademark of the Canadian Standards Group.
UL is a registered trademark of the Underwriters Laboratories, Inc.

For Eaton's Bussmann series product information, call **1-855-287-7626** or visit: **Eaton.com/bussmannseries**

Follow us on social media to get the latest product and support information.



UL Recognized power distribution blocks



Catalog number example:

16220-3 is a 3-pole 16220

Where:

- The prefix "16220" defines the block's lineside characteristics (i.e., one conductor port per pole that accepts 2/0 - #14 Cu, or 2/0 - #8 Al conductors) and the loadside characteristics (i.e., four conductor ports per pole that each accepts #4 - #14 Cu or #4 - #8 Al conductors).
- The suffix "3" in this example defines this as a three-pole block.
- See the catalog number tables for details on the available lineside/loadside characteristics.

How to order:

From the catalog number tables, select the catalog number that defines the desired lineside/loadside port and conductor characteristics.

Add to the catalog number the suffix that defines the desired pole configuration. Note, you must select from the available number of poles for each catalog number. These appear in the second column of the catalog number tables.

Specifications:

Ratings

- Volts: 600 V
- Amps: 175 to 1520 A
- SCCR: up to 200 kA* (see table for SCCR by catalog number)
- * Maximum SCCR contingent upon the application of an upstream current-limiting overcurrent protective device. See table for fusing requirements.

Flammability rating

- UL 94 V0

Storage and operating temperature range

- -4°F to 248°F (-20°C to 120°C)

Agency information

- UL 1059 Recognized, Guide XCFR2, File E62622
- CSA® Certified, Class 6228-01, File 15364

Conductors†

- Stranded 75°C copper and aluminum
- Higher temperature rated conductors permitted with appropriate derating

† As specified in the catalog number table.

Optional covers

- See table for catalog numbers and ordering details

Catalog symbols:

- 160__-(poles)
- 162__-(poles)
- 163__-(poles)
- 164__-(poles)
- 165__-(poles)

Description:

Bussmann™ series UL® Recognized power distribution blocks offer a variety of lineside and loadside port configurations to provide greater flexibility in panel wiring and wire management.

These blocks are UL Recognized to UL 1059 and rated for use in UL 508A industrial control panels.

Blocks are factory configured in 1-, 2 and 3-pole versions, and have optional covers to enhance safety (order covers separately).



Powering Business Worldwide

Catalog numbers:

Line/load port configuration	No. of poles	Current rating (A)	Lineside				Loadside					
			Wire size (Sol/ferrule unless noted)*	Wires per port	Torque N•m (Lb-in)	Ports/pole	Wire size (Sol/ferrule unless noted)*	Wires per port	Torque N•m (Lb-in)	Ports/pole	Max SCCR (kA)†	Catalog Number
	2, 3, 4	175	2/0 - #1 Cu/Al (Str)	1	13.6 (120)	1	#4 - #6 Cu/Al (Str)	1	4.0 (35)	6	10	16021- _
			#2 - #3 Cu/Al	1			#8 Cu	1	2.8 (25)			
			#4 - #8 Cu/Al	1-2			#8 Al (Str)	1-2				
			#10 - #14 Cu	1-2			#10 - #14 Cu	1-2	2.3 (20)			
	1, 2, 3	175	2/0 - #1 Cu/Al (Str)	1	13.6 (120)	1	#4 - #6 Cu/Al (Str)	1	4.0 (35)	4	200	16220- _
			#2 - #3 Cu/Al	1			#8 Cu	1	2.8 (25)			
			#4 - #8 Cu/Al	1-2			#8 Al (Str)	1-2				
			#10 - #14 Cu	1-2			#10 - #14 Cu	1-2	2.3 (20)			
	1, 2, 3	175	2/0 - #1 Cu/Al (Str)	1	13.6 (120)	1	#4 - #6 Cu/Al (Str)	1	4.0 (35)	4	200	16220- _H††
			#2 - #3 Cu/Al	1			#8 Cu	1	2.8 (25)			
			#4 - #8 Cu/Al	1-2			#8 Al (Str)	1-2				
			#10 - #14 Cu	1-2			#10 - #14 Cu	1-2	2.3 (20)			
	1, 2, 3	175	2/0 - #1 Cu/Al (Str)	1	13.6 (120)	1	#4 - #6 Cu/Al (Str)	1	4.0 (35)	6	200	16321- _
			#2 - #3 Cu/Al	1			#8 Cu	1	2.8 (25)			
			#4 - #8 Cu/Al	1-2			#8 Al (Str)	1-2				
			#10 - #14 Cu	1-2			#10 - #14 Cu	1-2	2.3 (20)			
	2,3,4	310	350kcmil - 2/0 Cu/Al (Str)	1	31.1 (275)††	1	#4 - #6 Cu/Al (Str)	1	4.0 (35)	6	10	16023- _
			1/0 Cu/Al (Str)	1-2			#8 Cu	1	2.8 (25)			
			#1 - #6 Cu/Al	1-2			#8 Al (Str)	1-2				
							#10 - #12 Al (Str)	1	2.3 (20)			
	1, 2, 3	310	350kcmil - 2/0 Cu/Al (Str)	1	31.1 (275)††	1	#4 - #6 Cu/Al (Str)	1	4.0 (35)	6	200	16323- _
			1/0 Cu/Al (Str)	1-2			#8 Cu	1	2.8 (25)			
			#1 - #6 Cu/Al	1-2			#8 Al (Str)	1-2				
							#10 - #12 Al (Str)	1	2.3 (20)			
	1, 2, 3	310	350kcmil - 2/0 Cu/Al (Str)	1	31.1 (275)††	1	#2 - #3 Cu/Al (Str)	1	5.6 (50)	3	10	16332- _
							#4 Cu/Al	1	5.1 (45)			
							#6 Cu/Al	1-2	4.5 (40)			
			1/0 Cu/Al (Str)	1-2			#8 Cu/Al	1-2	4.0 (35)			
	1, 2, 3	310			31.1 (275)††	1	#10 - #14 Cu	1-2	4.0 (35)	2	200	16370- _
							1/0 - #3 Cu/Al (Str)	1				
							#4 Cu	1	13.6 (120)			
			#1 - #6 Cu/Al	1-2			#4 - #8 Al (Str)	1-2				
	1, 2, 3	310	350kcmil - 2/0 Cu/Al (Str)	1	31.1 (275)††	1	#6 - #14 Cu	1-2		3	200	16371- _
							#4 - #6 Cu/Al (Str)	1	5.1 (45)			
							#8 Cu/Al (Str)	1	4.5 (40)			
			1/0 Cu/Al (Str)	1-2			#10 - #14 Cu (Str)	1	4.0 (35)			
	1, 2, 3	310	350kcmil - 2/0 Cu/Al (Str)	1	31.1 (275)††	1	#10 - #14 Cu	1	13.6 (120)	3	10	16372- _
							#4 - #8 Al (Str)	2				
							#6 - #14 Cu	2				
			#1 - #6 Cu/Al	1-2			#4 - #8 Al (Str)	2				

* 75°C wire (higher temperature rated wire acceptable with appropriate derating). Using a ferrule on a stranded conductor requires a correctly sized UL Listed ferrule (customer supplied) applied according to the manufacturer's specifications. Ferrule ratings apply to copper wire only.







** Not covered by CSA certification.

† See Short-Circuit Current Ratings table for the tested upstream overcurrent protective devices necessary for achieving these SCCRs.

†† Torque rating for dual wire and ferrule application is 30.5 N•m (270 Lb-in).

††† Configuration includes hex screws.

Catalog numbers cont.:

Line/load port configuration	No. of poles	Current rating (A)	Lineside				Loadside						
			Wire size (Sol/ferrule unless noted)*	Wires per port	Torque N•m (Lb-in)	Ports/pole	Wire size (Sol/ferrule unless noted)*	Wires per port	Torque N•m (Lb-in)	Ports/pole	Max SCCR (kA) [†]	Catalog number	
	1, 2, 3	310	350kcmil - 2/0 Cu/Al (Str)	1	31.1 (275) ^{††}	1	#10 Cu/Al	1	0.8 (7)	14			
	1, 2, 3	310	1/0 Cu/Al (Str)	1-2			#12 - #14 Cu	1					
			#1 - #6 Cu/Al	1-2			1/0 - #3 Cu/Al (Str)	1				10	16373- <u> </u>
	1, 2, 3	350	2/0 - #1 Cu/Al (Str)	1	13.6 (120)	2	#4 Cu	1					
			#2 - #3 Cu/Al	1			#6 - #14 Cu	1-2	13.6 (120)	3			
			#4 - #8 Cu/Al	1-2			#4 - #8 Al (Str)	1-2					
			#10 - #14 Cu	1-2			#10 - #14 Al (Str)	1					
	1, 2, 3	380	500kcmil - 4/0 Cu/Al (Str)	1	56.5 (500)	1	#2 - #3 Cu/Al (Str)	1	5.6 (50)				
			3/0 - 1/0 Cu/Al (Str)	1-2			#4 Cu/Al	1	5.1 (45)				
			#1 - #6 Cu/Al	1-2			#6 Cu/Al	1-2	4.5 (40)	6		10	16330- <u> </u>
							#10 - #12 Al (Str)	1	4.0 (35)				
							#10 - #14 Cu	1-2					
	1, 2, 3	380	500kcmil - 4/0 Cu/Al (Str)	1	56.5 (500)	1	#2 - #3 Cu/Al (Str)	1	5.6 (50)				
			3/0 - 1/0 Cu/Al (Str)	1-2			#4 Cu/Al	1	5.1 (45)	3			
			#1 - #6 Cu/Al	1-2			#6 Cu/Al	1-2	4.5 (40)				
							#8 Cu/Al	1-2	4.0 (35)		10		16335- <u> </u>
							#10 - #14 Cu	1-2					
							1/0 - #3 Cu/Al (Str)	1					
							#4 Cu	1	13.6 (120)	2			
							#4 - #8 Al (Str)	1-2					
							#6 - #14 Cu	1-2					
	1, 2, 3	380	500kcmil - 4/0 Cu/Al (Str)	1	56.5 (500)	1	#6 Cu/Al (Str)	1	4.0 (35)				
			3/0 - 1/0 Cu/Al (Str)	1-2			#8 Cu	1	2.8 (25)				
			#1 - #6 Cu/Al	1-2			#8 Al (Str)	1-2	2.3 (20)	21		10	16541- <u> </u>
							#10 - #14 Al (Str)	1					
							#10 - #14 Cu	1-2					
	1, 2, 3	420	600kcmil - #2 Cu/Al (Str)	1	56.5 (500)	1	#4 - #6 Cu/Al (Str)	1	4.0 (35)				
							#8 Cu	1	2.8 (25)				
							#8 Al (Str)	1-2		12		10	16375- <u> </u>
							#10 - #12 Al (Str)	1	2.3 (20)				
							#10 - #14 Cu	1-2					

* 75°C wire (higher temperature rated wire acceptable with appropriate derating). Using a ferrule on a stranded conductor requires a correctly sized UL Listed ferrule (customer supplied) applied according to the manufacturer's specifications. Ferrule ratings apply to copper wire only.





† See Short-Circuit Current Ratings table for the tested upstream overcurrent protective devices necessary for achieving these SCCR's.

†† Dual wire and ferrule application torque rating = 30.5 N•m (270 Lb-in).

Short-Circuit Current Rating (SCCR) data:

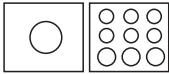
Catalog number	No. of poles	Conductors (AWG or kcmil)		Fuse Class/Bussmann series symbol/ampacity				
		Lineside	Loadside	J/ LPJ	RK1/ LPN-RK (250 V), LPS-RK (600 V)	RK5/ FRN-R (250 V), FRS-R (600 V)	T/ JJJ (300 V), JJS (600 V)	SCCR
16220- <u> </u>	1, 2, 3	2/0 - #8	#4 - #12	200	200	60	200	200 kA
			#4 - #14	175	100	60	175	100 kA
16321- <u> </u>	1, 2, 3	2/0 - #8	#4 - #12	400	200	100	400	200 kA
				175	100	60	175	100 kA
16323- <u> </u>	1, 2, 3	350 - #4	#4 - #8	400	200	100	400	200 kA
			#4 - #12	175	100	60	175	100 kA
16370- <u> </u>	1, 2, 3	350 - #4	#4 - #8	400	200	100	400	200 kA
			#4 - #14	175	100	60	175	100 kA
16371- <u> </u>	1, 2, 3	350 - #4	1/0 - #6	400	200	100	400	200 kA
			1/0 - #12	175	100	60	175	100 kA

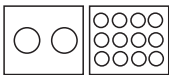
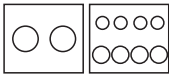
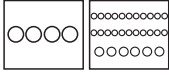
Catalog numbers cont.:

		Lineside					Loadside						
Line/load port configuration	No. of poles	Current rating (A)	Wire size (Str/ferrule unless noted)*	Wires per port	Torque N•m (Lb-in)	Ports/pole	Wire size (Str/ferrule unless noted)*	Wires per port	Torque N•m (Lb-in)	Ports/pole	Max SCCR (kA)†	Catalog number	
	1, 2, 3	420	600kcmil - #2 Cu/Al (Str)	1	56.5 (500)	1	#2 - #3 Cu/Al (Str)	1	5.6 (50)				
							#4 Cu/Al	1	5.1 (45)	6			
							#6 Cu/Al	1-2					
							#8 Cu/Al	1-2	4.5 (40)				
							#10 - #14 Cu	1-2	4.0 (35)		10	16376-	
							1/0 - #3 Cu/Al (Str)	1					
							#4 Cu	1	13.6 (120)	3			
							#6 - #14 Cu	1-2					
							#4 - #8 Al (Str)	1-2					
	1, 2, 3	570	300kcmil - 2/0 Cu/Al (Str)	1			#4 - #6 Cu/Al (Str)	1	4.0 (35)				
			1/0 Cu/Al (Str)	1-2			#8 Cu	1	2.8 (25)		10	16377-	
			#1 - #2 Cu/Al	1-2	31.1 (275)††	2	#8 Al (Str)	1-2		12			
			#4 Cu/Al (Str)	1-2			#10 - #12 Al (Str)	1	2.3 (20)				
							#10 - #14 Cu	1-2					
	1, 2, 3	760	500kcmil - 4/0 Cu/Al (Str)	1			#4 - #6 Cu/Al (Str)	1	4.0 (35)				
			3/0 - 1/0 Cu/Al (Str)	1-2			#8 Cu	1	2.8 (25)		10	16530-	
					56.5 (500)	2	#8 Al (Str)	1-2		12			
			#1 - #6 Cu/Al	1-2			#10 - #14 Al (Str)	1	2.3 (20)				
							#10 - #14 Cu	1-2					
	1, 2, 3	840	600kcmil - #2 Cu/Al	1	56.5 (500)	2	3/0 - #6 Cu/Al (Str)	1	13.6 (120)	4			
							#4 - #6 Cu/Al (Str)	1	4.0 (35)				
							#8 Cu	1	2.8 (25)		10	16528-	
							#8 Al (Str)	1-2		4			
							#10 - #14 Al (Str)	1	2.3 (20)				
							#10 - #14 Cu	1-2					
	1	1520	500kcmil - 4/0 Cu/Al (Str)	1			#2 - #3 Cu/Al (Str)	1	5.6 (50)				
							#4 Cu/Al	1	5.1 (45)				
							#6 Cu/Al	1-2		22			
							#8 Cu/Al	1-2	4.5 (40)				
			3/0 - 1/0 Cu/Al (Str)	1-2	56.5 (500)	4	#10 - #14 Cu	1-2	4.0 (35)		10	16400	
							1/0 - #3 Cu/Al (Str)	1					
							#4 Cu	1	13.6 (120)	6			
							#4 - #8 Al (Str)	1-2					
			#1 - #6 Cu/Al	1-2			#6 - #14 Cu	1-2					

* 75°C wire (higher temperature rated wire acceptable with appropriate derating). Using a ferrule on a stranded conductor requires a correctly sized UL Listed ferrule (customer supplied) applied according to the manufacturer's specifications. Ferrule ratings apply to copper wire only.

† See Short-Circuit Current Ratings table for the tested upstream overcurrent protective devices necessary for achieving these SCCRs.

†† Dual wire and ferrule application torque rating = 30.5 N•m (270 Lb-in).

Dual wire port application

- Rated for dual wire port application to increase the possible number of lineside and loadside connections. E.g., 16220-1 can accept two wires into the lineside port (#4 - #14 Cu, #4 - #8 Al) and two wires per port (eight connections total) on the loadside lug (#8 - #14 Cu, #8 Al).
- Dual wire applications are only viable when using two wires of the same size, stranding, and insulating and conductor material.

Ferrule terminal application

- Busmann series UL Recognized power distribution blocks are rated for use with UL Listed ferrules (see catalog number table for details).
- Ferrule applications allow for the use of a broader range of conductor stranding and simulate a more efficient, solid wire connection with the terminal port.
- Always use UL Listed ferrules in accordance with the manufacturer's specifications and instructions.

Dimensions — in

160_blocks

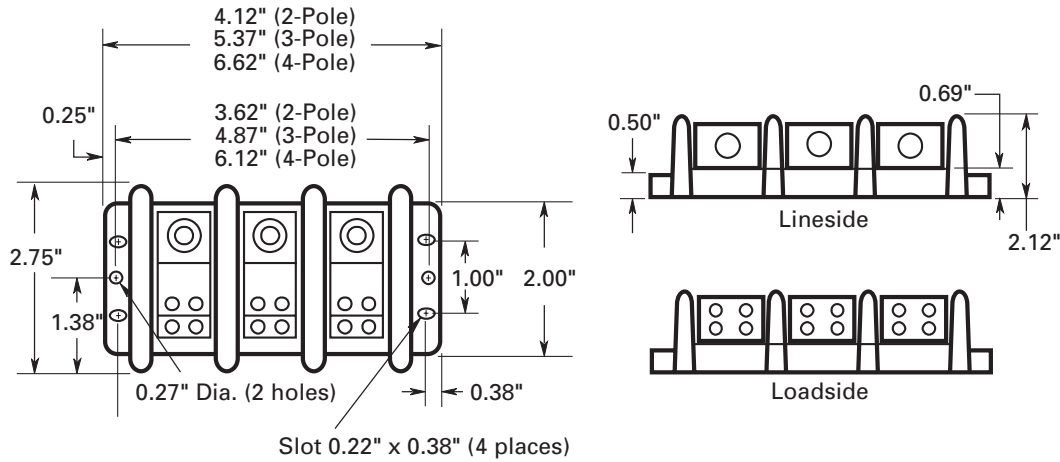

162_, 163_ and 165_ blocks

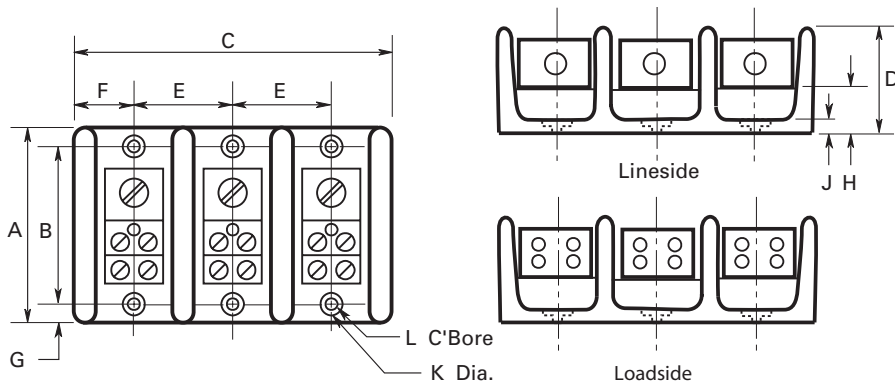

Catalog number prefix	A	B	C1	C2	C3	D	E	F	G	H	J	K	L
162_	2.88	2.25	1.07	1.88	2.70	1.75	0.82	0.54	0.32	0.84	0.31	0.20	0.41
163_	4.0	3.38	1.98	3.60	5.21	3.32	1.62	0.99	0.31	0.88	0.35	Slot 0.20" wide x 0.41" long	Slot 0.42" wide x 0.62" long
165_	5.5	4.75	3.11	5.76	8.48	2.94	2.69	1.55	0.36	1.19	0.44	Slot 0.20" wide x 0.33" long	Slot 0.41" wide x 0.53" long

Optional covers

For block catalog number starting	Order cover catalog number
160_	CPB160-(poles)*
162_	CPB162-(poles)*
163_	CPDB-(poles)*
165_	CPDB165**

* Order one cover for each block by specifying the number of poles in the catalog number suffix. E.g., For the block catalog number 16021-4, order the cover catalog number CPD160-4.

** Order one cover for each of the block's poles. E.g., For block catalog number 16530-3, order three of cover catalog number CPDB165.

The only controlled copy of this data sheet is the electronic read-only version located on the Eaton network drive. All other copies of this document are by definition uncontrolled. This bulletin is intended to clearly present comprehensive product data and provide technical information that will help the end user with design applications. Eaton reserves the right, without notice, to change design or construction of any products and to discontinue or limit distribution of any products. Eaton also reserves the right to change or update, without notice, any technical information contained in this bulletin. Once a product has been selected, it should be tested by the user in all possible applications.

Eaton
1000 Eaton Boulevard
Cleveland, OH 44122
Eaton.com

Bussmann Division
114 Old State Road
Ellisville, MO 63021
United States
Eaton.com/bussmannseries

© 2017 Eaton
All Rights Reserved
Printed in USA
Publication No. 10533 — BU-MC16056
September 2017

Eaton and Bussmann are valuable trademarks of Eaton in the U.S. and other countries. You are not permitted to use the Eaton trademarks without prior written consent of Eaton.

CSA is a registered trademark of the Canadian Standards Group.
UL is a registered trademark of the Underwriters Laboratories, Inc.

For Eaton's Bussmann series product information, call **1-855-287-7626** or visit: **Eaton.com/bussmannseries**

Follow us on social media to get the latest product and support information.

