

## 14, 15, 24, 25, 26, 27, 28, 29 Series

### Severe Duty Devices for Industrial Applications

Made of thermoplastic elastomer, these plugs and connectors are built to resist the damaging effects of impacts, oils, chemicals, heat and weather.

With captive assembly screws, a self-centering cord clamp and keyed body for simple and fast assembly.



#### FEATURES & BENEFITS

**Industrial-strength brass blades & contacts** for long-lasting superior corrosion resistance.

**Thermoplastic elastomer construction** stands up to impacts oils, chemicals, heat, and weather.

**Quick-drive assembly screws** allow for fast installation, saving time and money.



**Two-screw self-centering cable clamp** secures wire and provides superior strain relief.

**Keyed body & cover** for easy assembly and alignment.

**Recessed assembly screws** are isolated from live parts.



#### FIELD USES / VERTICAL MARKETS

- Food & Beverage Processing
- Chemical Processing
- Temporary Power
- Pulp & Paper Mills
- Mining
- Industrial Manufacturing
- Water/Waste Water
- Warehousing/Refrigeration



# PASS & SEYMOUR®

## Straight Blade and Turnlok®

### Rubber Dust-Tight Plugs & Connectors

#### ORDERING INFORMATION

| Catalog Number | Description                        | Poles/<br>Wires | Rating |         | NEMA<br>Config. No. |
|----------------|------------------------------------|-----------------|--------|---------|---------------------|
|                |                                    |                 | A      | V       |                     |
| 1447           | Plug, Yellow, Rubber               | 2P/3W           | 15     | 125     | 5-15P               |
| 1547           | Connector, Yellow, Rubber          | 2P/3W           | 15     | 125     | 5-15R               |
| 1433P          | Plug, Yellow, Rubber               | 2P/3W           | 20     | 125     | 5-20P               |
| 1533           | Connector, Yellow, Rubber          | 2P/3W           | 20     | 125     | 5-20R               |
| 1449           | Plug, Yellow, Rubber               | 2P/3W           | 15     | 250     | 6-15P               |
| 1549           | Connector, Yellow, Rubber          | 2P/3W           | 15     | 250     | 6-15R               |
| 1448           | Plug, Yellow, Rubber               | 2P/3W           | 20     | 250     | 6-20P               |
| 1548           | Connector, Yellow, Rubber          | 2P/3W           | 20     | 250     | 6-20R               |
| 2447           | Plug, Yellow, Rubber, Locking      | 2P/3W           | 15     | 125     | L5-15P              |
| 2547           | Connector, Yellow, Rubber, Locking | 2P/3W           | 15     | 125     | L5-15R              |
| 2647           | Plug, Yellow, Rubber, Locking      | 2P/3W           | 20     | 125     | L5-20P              |
| 2747           | Connector, Yellow, Rubber, Locking | 2P/3W           | 20     | 125     | L5-20R              |
| 2847           | Plug, Yellow, Rubber, Locking      | 2P/3W           | 30     | 125     | L5-30P              |
| 2947           | Connector, Yellow, Rubber, Locking | 2P/3W           | 30     | 125     | L5-30R              |
| 2449           | Plug, Yellow, Rubber, Locking      | 2P/3W           | 15     | 250     | L6-15P              |
| 2549           | Connector, Yellow, Rubber, Locking | 2P/3W           | 15     | 250     | L6-15R              |
| 2648           | Plug, Yellow, Rubber, Locking      | 2P/3W           | 20     | 250     | L6-20P              |
| 2748           | Connector, Yellow, Rubber, Locking | 2P/3W           | 20     | 250     | L6-20R              |
| 2848           | Plug, Yellow, Rubber, Locking      | 2P/3W           | 30     | 250     | L6-30P              |
| 2948           | Connector, Yellow, Rubber, Locking | 2P/3W           | 30     | 250     | L6-30R              |
| 2434           | Plug, Yellow, Rubber, Locking      | 2P/3W           | 15     | 277     | L7-15P              |
| 2534           | Connector, Yellow, Rubber, Locking | 2P/3W           | 15     | 277     | L7-15R              |
| 2649           | Plug, Yellow, Rubber, Locking      | 2P/3W           | 20     | 277     | L7-20P              |
| 2749           | Connector, Yellow, Rubber, Locking | 2P/3W           | 20     | 277     | L7-20R              |
| 2849           | Plug, Yellow, Rubber, Locking      | 2P/3W           | 30     | 277     | L7-30P              |
| 2949           | Connector, Yellow, Rubber, Locking | 2P/3W           | 30     | 277     | L7-30R              |
| 2674           | Plug, Yellow, Rubber, Locking      | 3P/4W           | 20     | 125/250 | L14-20P             |
| 2774           | Connector, Yellow, Rubber, Locking | 3P/4W           | 20     | 125/250 | L14-20R             |
| 2874           | Plug, Yellow, Rubber, Locking      | 3P/4W           | 30     | 125/250 | L14-30P             |
| 2974           | Connector, Yellow, Rubber, Locking | 3P/4W           | 30     | 125/250 | L14-30R             |
| 2675           | Plug, Yellow, Rubber, Locking      | 3P/4W           | 20     | 3Ø 250  | L15-20P             |
| 2775           | Connector, Yellow, Rubber, Locking | 3P/4W           | 20     | 3Ø 250  | L15-20R             |
| 2875           | Plug, Yellow, Rubber, Locking      | 3P/4W           | 30     | 3Ø 250  | L15-30P             |
| 2975           | Connector, Yellow, Rubber, Locking | 3P/4W           | 30     | 3Ø 250  | L15-30R             |
| 2676           | Plug, Yellow, Rubber, Locking      | 3P/4W           | 20     | 3Ø 480  | L16-20P             |
| 2776           | Connector, Yellow, Rubber, Locking | 3P/4W           | 20     | 3Ø 480  | L16-20R             |
| 2876           | Plug, Yellow, Rubber, Locking      | 3P/4W           | 30     | 3Ø 480  | L16-30P             |
| 2976           | Connector, Yellow, Rubber, Locking | 3P/4W           | 30     | 3Ø 480  | L16-30R             |
| 2877           | Plug, Yellow, Rubber, Locking      | 3P/4W           | 30     | 3ØY 600 | L17-30P             |
| 2977           | Connector, Yellow, Rubber, Locking | 3P/4W           | 30     | 3ØY 600 | L17-30R             |
| 2608           | Plug, Yellow, Rubber               | 3P/3W NG        | 20     | 125/250 | NON                 |
| 2708           | Connector, Yellow, Rubber          | 3P/3W NG        | 20     | 125/250 | NON                 |

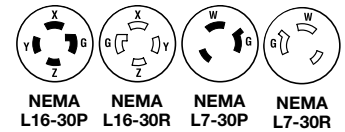
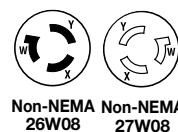
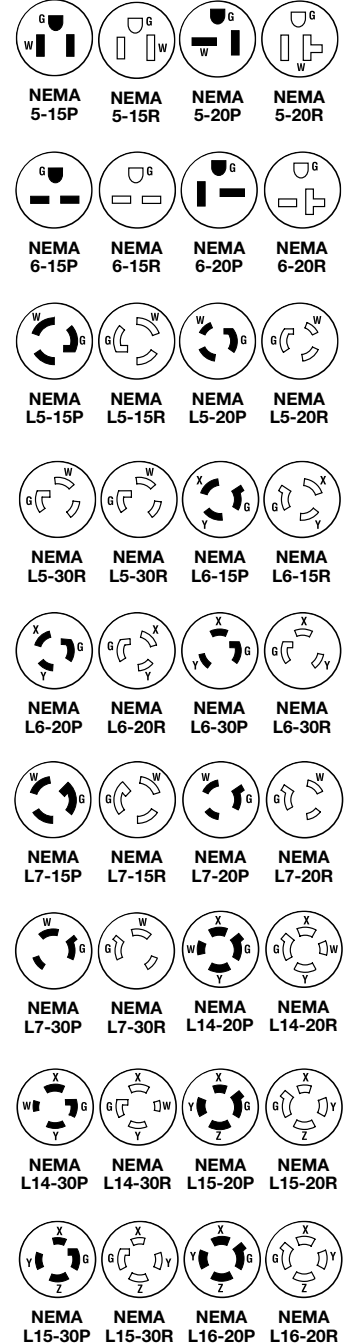

For more information on these and other P&S products refer to our Catalog or visit our web site.

# PASS & SEYMOUR®

## Straight Blade and Turnlok®

### Rubber Dust-Tight Plugs & Connectors



#### TECHNICAL INFORMATION

#### 3rd Party Compliance

UL Listed, Standard UL498, Attachment Plugs and Receptacles.  
 Federal Specification WC596.  
 CSA Certified Standard CSA-C22.2 No. 42, General Use Receptacles and Attachment Plugs.  
 Conforms to NEMA WD-1.

#### Performance

##### Electrical

|                              |  |
|------------------------------|--|
| Dielectric Withstand Voltage | 15A = 1600V minimum, 20A & 30A = 2200V minimum           |
| Maximum Working Voltage      | 15A = 277VAC, 20 & 30A = 600VAC                          |
| Current Interrupting         | Certified for current interrupting at full-rated current |
| Temperature Rise             | 30°C maximum after 50 cycles at 150% rated current       |

##### Mechanical

|                         |  |
|-------------------------|--|
| Cord Accommodations     | Round portable service cords of diameters in accordance with the device rating as defined in UL62  |
| Terminal Identification | 15A = Green = Ground, White = Neutral, Brass = Hot<br>20A & 30A = "GR" and Green color = Ground, "WH" and White color = Neutral, "X", "Y", "Z" = Hot |
| Terminal Accommodation  | 15A = #18 AWG min. – #10 AWG max.<br>20A = #18 AWG min. – #8 AWG max.<br>30A = #18 AWG min. – #6 AWG max.  |
| Product Identification  | Amperage, Voltage, 3rd Party Compliance, NEMA Configuration hot stamped onto device  |

##### Environmental

|                       |  |
|-----------------------|--|
| Flammability          | UL94 V2  |
| Operating Temperature | Maximum continuous +75°C, minimum -40°C without impact |

#### Materials

|                             |                                   |
|-----------------------------|-----------------------------------|
| Body                        | Thermoplastic Elastomer           |
| Terminal Chamber            | Polycarbonate                     |
| Compression Nut             | Nylon                             |
| Compression Grommet         | Thermoplastic Elastomer           |
| Dust Cover                  | Thermoplastic Elastomer           |
| Plug Blades                 | Brass                             |
| Connector Contacts          | Brass                             |
| Terminal Clamps             | Brass                             |
| Terminal Screws Hot         | Brass                             |
| Terminal Screws Hot/Neutral | Zinc-Plated Brass                 |
| Ground Screws               | Zinc/Green-Plated Brass, Hex-Head |
| Assembly Screws             | Stainless Steel                   |

#### Warranty

1 Year

# DIMENSIONS & NEMA CONFIGURATIONS

## SMALL PLUGS

| PART NUMBER | NEMA CONFIG |
|-------------|-------------|
| 1447        | 5-15P       |
| 1443P       | 5-20P       |
| 1449        | 6-15P       |
| 1448        | 6-20P       |
| 2447        | L5-15P      |
| 2449        | L6-15P      |
| 2434        | L7-15P      |

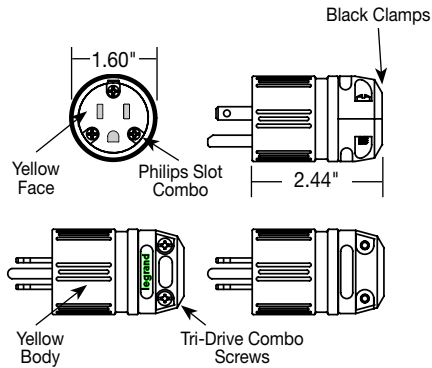

## SMALL CONNECTORS

| PART NUMBER | NEMA CONFIG |
|-------------|-------------|
| 1547        | 5-15R       |
| 1533        | 5-20R       |
| 1549        | 6-15R       |
| 1548        | 6-20R       |
| 2547        | L5-15R      |
| 2549        | L6-15R      |
| 2534        | L7-15R      |

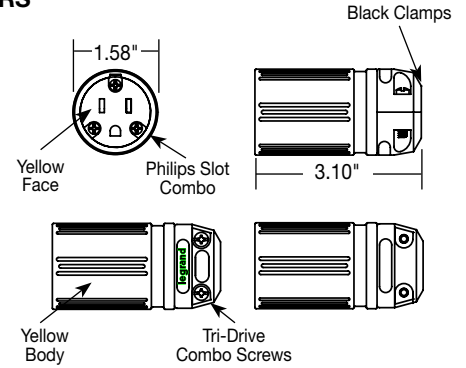

## MEDIUM PLUGS

| PART NUMBER | NEMA CONFIG |
|-------------|-------------|
| 2647        | L5-20P      |
| 2648        | L6-20P      |
| 2608        | NON         |
| 2649        | L7-20P      |
| 2674        | L14-20P     |
| 2675        | L15-20P     |
| 2676        | L16-20P     |

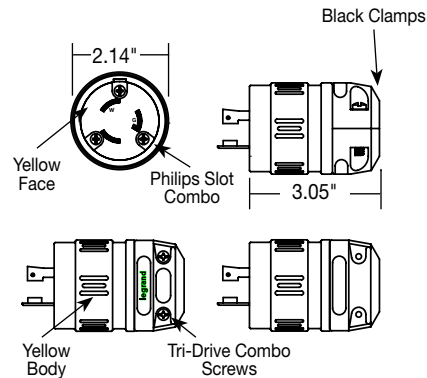

## MEDIUM CONNECTORS

| PART NUMBER | NEMA CONFIG |
|-------------|-------------|
| 2747        | L5-20R      |
| 2748        | L6-20R      |
| 2708        | NON         |
| 2749        | L7-20R      |
| 2774        | L14-20R     |
| 2775        | L15-20R     |
| 2776        | L16-20R     |

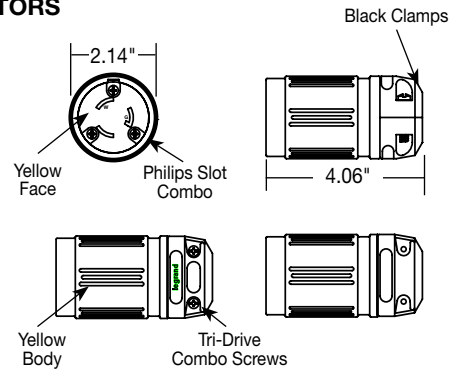

## LARGE PLUGS

| PART NUMBER | NEMA CONFIG |
|-------------|-------------|
| 2847        | L5-30P      |
| 2848        | L6-30P      |
| 2876        | L16-30P     |
| 2877        | L17-30P     |
| 2849        | L7-30P      |
| 2874        | L14-30P     |
| 2875        | L15-30P     |

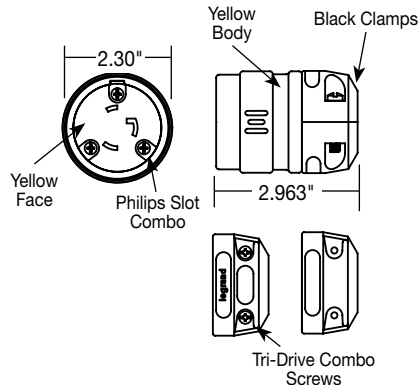

## LARGE CONNECTORS

| PART NUMBER | NEMA CONFIG |
|-------------|-------------|
| 2947        | L5-30R      |
| 2948        | L6-30R      |
| 2949        | L7-30R      |
| 2974        | L14-30R     |
| 2975        | L15-30R     |
| 2976        | L16-30R     |
| 2977        | L17-30R     |

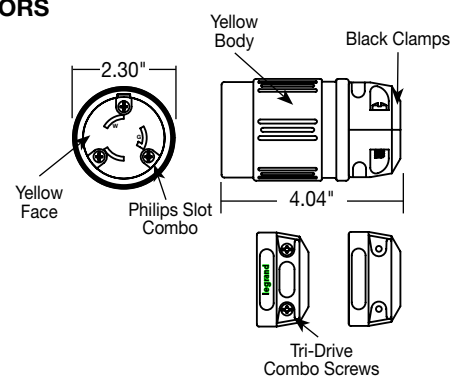

## ALSO AVAILABLE...

- Surge Products
- Flexcor® Wire Mesh Grips
- Turnlok® Locking Devices
- Portable GFCI
- IEC 309 Industrial Products
- Straight Blade Plugs & Connectors
- Ground Continuity Monitoring (GCM)



### Electrical Wiring Systems

P.O. Box 4822  
Syracuse, NY 13221-4822  
Phone: 1.800.776.4035  
[www.legrand.us/passandseymour](http://www.legrand.us/passandseymour)

570 Applewood Crescent  
Vaughan, Ontario L4K 4B4  
Phone: 905.738.9195  
[www.legrand.ca](http://www.legrand.ca)

## 14, 15, 24, 25, 26, 27, 28, 29 Series

### Severe Duty Devices for Industrial Applications

Made of thermoplastic elastomer, these plugs and connectors are built to resist the damaging effects of impacts, oils, chemicals, heat and weather.

With captive assembly screws, a self-centering cord clamp and keyed body for simple and fast assembly.



#### FEATURES & BENEFITS

**Industrial-strength brass blades & contacts** for long-lasting superior corrosion resistance.

**Thermoplastic elastomer construction** stands up to impacts oils, chemicals, heat, and weather.

**Quick-drive assembly screws** allow for fast installation, saving time and money.



**Two-screw self-centering cable clamp** secures wire and provides superior strain relief.

**Keyed body & cover** for easy assembly and alignment.



**Recessed assembly screws** are isolated from live parts.

#### FIELD USES / VERTICAL MARKETS

- Food & Beverage Processing
- Chemical Processing
- Temporary Power
- Pulp & Paper Mills
- Mining
- Industrial Manufacturing
- Water/Waste Water
- Warehousing/Refrigeration



# PASS & SEYMOUR®

## Straight Blade and Turnlok®

### Rubber Dust-Tight Plugs & Connectors

#### ORDERING INFORMATION

| Catalog Number | Description                        | Poles/<br>Wires | Rating |         | NEMA<br>Config. No. |
|----------------|------------------------------------|-----------------|--------|---------|---------------------|
|                |                                    |                 | A      | V       |                     |
| 1447           | Plug, Yellow, Rubber               | 2P/3W           | 15     | 125     | 5-15P               |
| 1547           | Connector, Yellow, Rubber          | 2P/3W           | 15     | 125     | 5-15R               |
| 1433P          | Plug, Yellow, Rubber               | 2P/3W           | 20     | 125     | 5-20P               |
| 1533           | Connector, Yellow, Rubber          | 2P/3W           | 20     | 125     | 5-20R               |
| 1449           | Plug, Yellow, Rubber               | 2P/3W           | 15     | 250     | 6-15P               |
| 1549           | Connector, Yellow, Rubber          | 2P/3W           | 15     | 250     | 6-15R               |
| 1448           | Plug, Yellow, Rubber               | 2P/3W           | 20     | 250     | 6-20P               |
| 1548           | Connector, Yellow, Rubber          | 2P/3W           | 20     | 250     | 6-20R               |
| 2447           | Plug, Yellow, Rubber, Locking      | 2P/3W           | 15     | 125     | L5-15P              |
| 2547           | Connector, Yellow, Rubber, Locking | 2P/3W           | 15     | 125     | L5-15R              |
| 2647           | Plug, Yellow, Rubber, Locking      | 2P/3W           | 20     | 125     | L5-20P              |
| 2747           | Connector, Yellow, Rubber, Locking | 2P/3W           | 20     | 125     | L5-20R              |
| 2847           | Plug, Yellow, Rubber, Locking      | 2P/3W           | 30     | 125     | L5-30P              |
| 2947           | Connector, Yellow, Rubber, Locking | 2P/3W           | 30     | 125     | L5-30R              |
| 2449           | Plug, Yellow, Rubber, Locking      | 2P/3W           | 15     | 250     | L6-15P              |
| 2549           | Connector, Yellow, Rubber, Locking | 2P/3W           | 15     | 250     | L6-15R              |
| 2648           | Plug, Yellow, Rubber, Locking      | 2P/3W           | 20     | 250     | L6-20P              |
| 2748           | Connector, Yellow, Rubber, Locking | 2P/3W           | 20     | 250     | L6-20R              |
| 2848           | Plug, Yellow, Rubber, Locking      | 2P/3W           | 30     | 250     | L6-30P              |
| 2948           | Connector, Yellow, Rubber, Locking | 2P/3W           | 30     | 250     | L6-30R              |
| 2434           | Plug, Yellow, Rubber, Locking      | 2P/3W           | 15     | 277     | L7-15P              |
| 2534           | Connector, Yellow, Rubber, Locking | 2P/3W           | 15     | 277     | L7-15R              |
| 2649           | Plug, Yellow, Rubber, Locking      | 2P/3W           | 20     | 277     | L7-20P              |
| 2749           | Connector, Yellow, Rubber, Locking | 2P/3W           | 20     | 277     | L7-20R              |
| 2849           | Plug, Yellow, Rubber, Locking      | 2P/3W           | 30     | 277     | L7-30P              |
| 2949           | Connector, Yellow, Rubber, Locking | 2P/3W           | 30     | 277     | L7-30R              |
| 2674           | Plug, Yellow, Rubber, Locking      | 3P/4W           | 20     | 125/250 | L14-20P             |
| 2774           | Connector, Yellow, Rubber, Locking | 3P/4W           | 20     | 125/250 | L14-20R             |
| 2874           | Plug, Yellow, Rubber, Locking      | 3P/4W           | 30     | 125/250 | L14-30P             |
| 2974           | Connector, Yellow, Rubber, Locking | 3P/4W           | 30     | 125/250 | L14-30R             |
| 2675           | Plug, Yellow, Rubber, Locking      | 3P/4W           | 20     | 3Ø 250  | L15-20P             |
| 2775           | Connector, Yellow, Rubber, Locking | 3P/4W           | 20     | 3Ø 250  | L15-20R             |
| 2875           | Plug, Yellow, Rubber, Locking      | 3P/4W           | 30     | 3Ø 250  | L15-30P             |
| 2975           | Connector, Yellow, Rubber, Locking | 3P/4W           | 30     | 3Ø 250  | L15-30R             |
| 2676           | Plug, Yellow, Rubber, Locking      | 3P/4W           | 20     | 3Ø 480  | L16-20P             |
| 2776           | Connector, Yellow, Rubber, Locking | 3P/4W           | 20     | 3Ø 480  | L16-20R             |
| 2876           | Plug, Yellow, Rubber, Locking      | 3P/4W           | 30     | 3Ø 480  | L16-30P             |
| 2976           | Connector, Yellow, Rubber, Locking | 3P/4W           | 30     | 3Ø 480  | L16-30R             |
| 2877           | Plug, Yellow, Rubber, Locking      | 3P/4W           | 30     | 3ØY 600 | L17-30P             |
| 2977           | Connector, Yellow, Rubber, Locking | 3P/4W           | 30     | 3ØY 600 | L17-30R             |
| 2608           | Plug, Yellow, Rubber               | 3P/3W NG        | 20     | 125/250 | NON                 |
| 2708           | Connector, Yellow, Rubber          | 3P/3W NG        | 20     | 125/250 | NON                 |

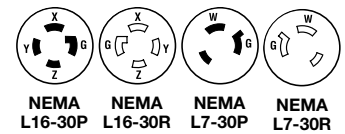
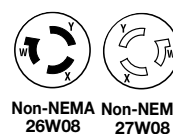
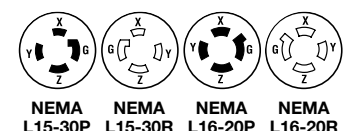
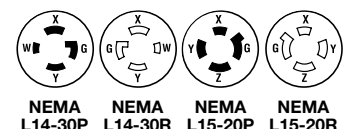
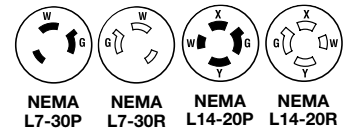
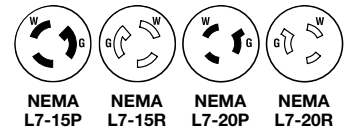
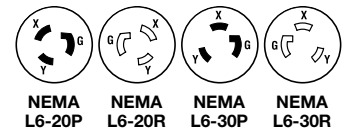
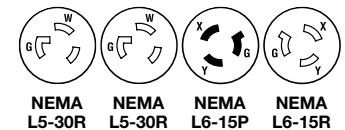
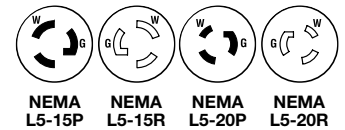
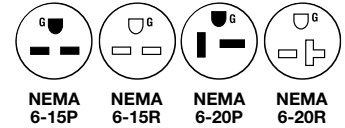
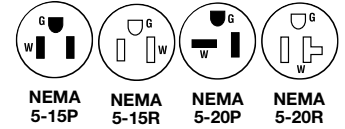

For more information on these and other P&S products refer to our Catalog or visit our web site.

# PASS & SEYMOUR®

## Straight Blade and Turnlok®

### Rubber Dust-Tight Plugs & Connectors



#### TECHNICAL INFORMATION

#### 3rd Party Compliance

UL Listed, Standard UL498, Attachment Plugs and Receptacles.  
 Federal Specification WC596.  
 CSA Certified Standard CSA-C22.2 No. 42, General Use Receptacles and Attachment Plugs.  
 Conforms to NEMA WD-1.

#### Performance

##### Electrical

|                              |  |
|------------------------------|--|
| Dielectric Withstand Voltage | 15A = 1600V minimum, 20A & 30A = 2200V minimum           |
| Maximum Working Voltage      | 15A = 277VAC, 20 & 30A = 600VAC                          |
| Current Interrupting         | Certified for current interrupting at full-rated current |
| Temperature Rise             | 30°C maximum after 50 cycles at 150% rated current       |

##### Mechanical

|                         |  |
|-------------------------|--|
| Cord Accommodations     | Round portable service cords of diameters in accordance with the device rating as defined in UL62  |
| Terminal Identification | 15A = Green = Ground, White = Neutral, Brass = Hot<br>20A & 30A = "GR" and Green color = Ground, "WH" and White color = Neutral, "X", "Y", "Z" = Hot |
| Terminal Accommodation  | 15A = #18 AWG min. – #10 AWG max.<br>20A = #18 AWG min. – #8 AWG max.<br>30A = #18 AWG min. – #6 AWG max.  |
| Product Identification  | Amperage, Voltage, 3rd Party Compliance, NEMA Configuration hot stamped onto device  |

##### Environmental

|                       |  |
|-----------------------|--|
| Flammability          | UL94 V2  |
| Operating Temperature | Maximum continuous +75°C, minimum -40°C without impact |

#### Materials

|                             |                                   |
|-----------------------------|-----------------------------------|
| Body                        | Thermoplastic Elastomer           |
| Terminal Chamber            | Polycarbonate                     |
| Compression Nut             | Nylon                             |
| Compression Grommet         | Thermoplastic Elastomer           |
| Dust Cover                  | Thermoplastic Elastomer           |
| Plug Blades                 | Brass                             |
| Connector Contacts          | Brass                             |
| Terminal Clamps             | Brass                             |
| Terminal Screws Hot         | Brass                             |
| Terminal Screws Hot/Neutral | Zinc-Plated Brass                 |
| Ground Screws               | Zinc/Green-Plated Brass, Hex-Head |
| Assembly Screws             | Stainless Steel                   |

#### Warranty

1 Year

# DIMENSIONS & NEMA CONFIGURATIONS

## SMALL PLUGS

| PART NUMBER | NEMA CONFIG |
|-------------|-------------|
| 1447        | 5-15P       |
| 1443P       | 5-20P       |
| 1449        | 6-15P       |
| 1448        | 6-20P       |
| 2447        | L5-15P      |
| 2449        | L6-15P      |
| 2434        | L7-15P      |

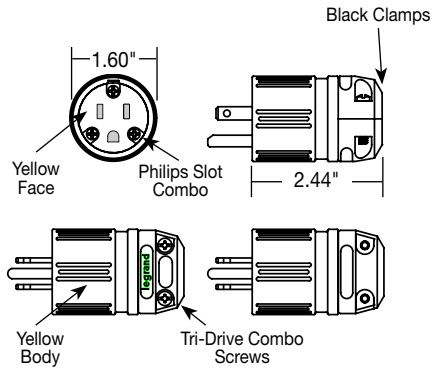

## SMALL CONNECTORS

| PART NUMBER | NEMA CONFIG |
|-------------|-------------|
| 1547        | 5-15R       |
| 1533        | 5-20R       |
| 1549        | 6-15R       |
| 1548        | 6-20R       |
| 2547        | L5-15R      |
| 2549        | L6-15R      |
| 2534        | L7-15R      |

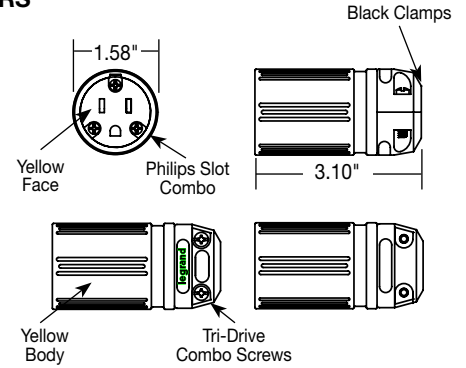

## MEDIUM PLUGS

| PART NUMBER | NEMA CONFIG |
|-------------|-------------|
| 2647        | L5-20P      |
| 2648        | L6-20P      |
| 2608        | NON         |
| 2649        | L7-20P      |
| 2674        | L14-20P     |
| 2675        | L15-20P     |
| 2676        | L16-20P     |

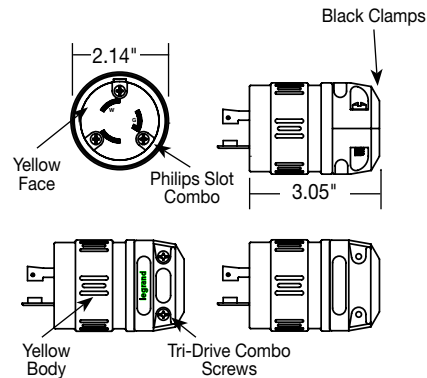

## MEDIUM CONNECTORS

| PART NUMBER | NEMA CONFIG |
|-------------|-------------|
| 2747        | L5-20R      |
| 2748        | L6-20R      |
| 2708        | NON         |
| 2749        | L7-20R      |
| 2774        | L14-20R     |
| 2775        | L15-20R     |
| 2776        | L16-20R     |

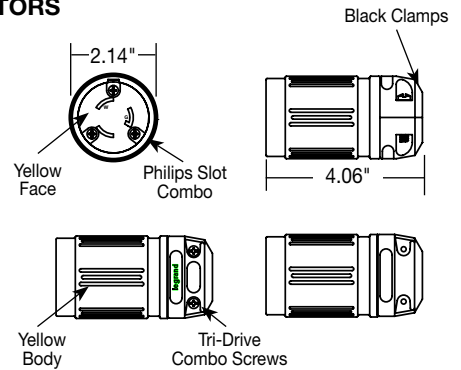

## LARGE PLUGS

| PART NUMBER | NEMA CONFIG |
|-------------|-------------|
| 2847        | L5-30P      |
| 2848        | L6-30P      |
| 2876        | L16-30P     |
| 2877        | L17-30P     |
| 2849        | L7-30P      |
| 2874        | L14-30P     |
| 2875        | L15-30P     |

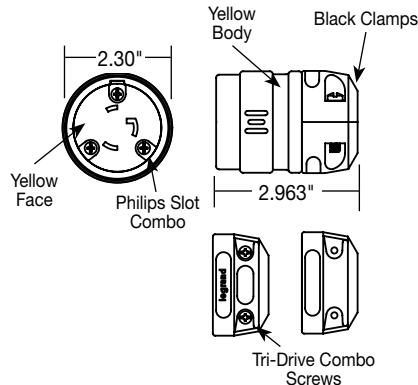

## LARGE CONNECTORS

| PART NUMBER | NEMA CONFIG |
|-------------|-------------|
| 2947        | L5-30R      |
| 2948        | L6-30R      |
| 2949        | L7-30R      |
| 2974        | L14-30R     |
| 2975        | L15-30R     |
| 2976        | L16-30R     |
| 2977        | L17-30R     |

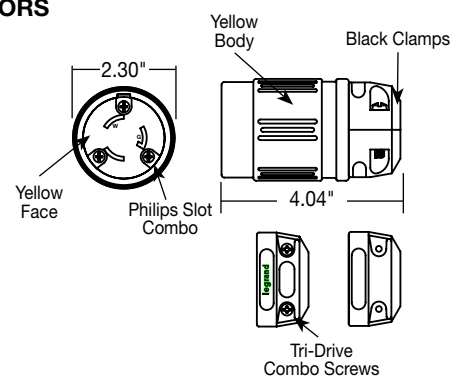

## ALSO AVAILABLE...

- Surge Products
- Flexcor® Wire Mesh Grips
- Turnlok® Locking Devices
- Portable GFCI
- IEC 309 Industrial Products
- Straight Blade Plugs & Connectors
- Ground Continuity Monitoring (GCM)



### Electrical Wiring Systems

P.O. Box 4822  
Syracuse, NY 13221-4822  
Phone: 1.800.776.4035  
[www.legrand.us/passandseymour](http://www.legrand.us/passandseymour)

570 Applewood Crescent  
Vaughan, Ontario L4K 4B4  
Phone: 905.738.9195  
[www.legrand.ca](http://www.legrand.ca)