

HEAVY-DUTY INDUSTRIAL



WOODHEAD® TOUGH NYLON SAFEWAY® AND SUPER-SAFEWAY™ RUBBERIZED WIRING DEVICES ARE DESIGNED FOR USE IN RUGGED INDUSTRIAL ENVIRONMENTS

Woodhead Super-Safeway products are heavy-duty industrial-wiring devices designed for abusive conditions and dependable performance for applications that demand the unmatched durability that rubber exclusively delivers. These rubberized industrial devices are the only wiring devices made of NEÖTEX® Paracril OZO rubber, a rubber construction that yields ultimate performance within a wide temperature range, around many oils and chemicals and abrasive conditions.

FEATURES AND BENEFITS

Super-Safeway	Rubber construction	An ultimate solution for temperature, chemical and abrasion resistance
Safeway and Super-Safeway	Self-aligning blades	Lower operating temperatures yielding longer life
	Wiring screw terminals backed out	Provides easier and quicker wiring
	Stainless-steel assembly screw	Provides a stronger, more long-lasting product

APPLICATIONS

- Aircraft construction/airports
- Construction site
- Facility maintenance
- Petrochemical
- Pulp and paper manufacturing

Industrial Duty Wiring Devices Straight Blade 15A 125V 2-Pole/2-Wire NEMA 1-15

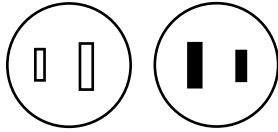

Features and Benefits

- NEōTEX® Paracril OZO rubber body yields the best performance for abrasion, chemical exposure and temperature extremes within the Super-Safeway™ offering
- Rugged nylon bodies within the Safeway® offering provide exceptional durability and performance
- Color-coded ¼" terminal screws pre-set in open position, ready to wire
- Wire screw terminals are tri-drive to be used with straight blade, Phillips and square-drive screw drivers
- Floating blade construction provides self-alignment, and a better mechanical and electrical connection minimizing wear and heat generation
- Transparent wiring guide to verify all wire strands are in place before securing wire
- Captive, tri-drive head, Stainless Steel, speed screw provides easy assembly and long life
- Two-piece cord-clamp strain relief includes tri-drive screws to firmly secure the cord

Reference Information

UL File No.: E10176
CSA File No.: LR6837



Physical

Plug blades and connector contacts: Nickel-plated Brass
Super-Safeway Outer Housing: NEōTEX Paracril OZO rubber

Safeway Outer Housing: Nylon
Face Screws: Stainless Steel
Face Insert: Nylon
Wire Saddle Clamp: Brass
Cord Clamp Screws: Steel, Zinc-plated
Plug/Connector Range: .335 to .640"

Environmental

Operating Temperature: Maximum continuous 75° C, minimum -40° C (no impact)
Temperature Rise: Maximum 30° C temperature rise at full rated current after 50 cycles of overload at 150% of rated current at a power factor of 75%.



Super-Safeway Industrial Rubber Plug and Connector

Description	Plug		Connector	
	Woodhead No.	Order No.	Woodhead No.	Order No.
Yellow rubber	1404	130141-0006	1504	130141-0023
Yellow rubber, Polarized	1419	130141-0008		



Safeway Industrial Nylon Plug and Connector

Description	Plug		Connector	
	Woodhead No.	Order No.	Woodhead No.	Order No.
Black and white	5166	130144-0034	5169	130144-0035
Black and white, polarized	5176	130144-0008		

Find adapters and technical support at the end of this section

Industrial Duty Wiring Devices Straight Blade 15A 125V 2-Pole/2-Wire NEMA 1-15

Wiring Devices

D

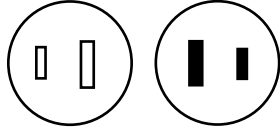

Safeway Inlet

Description	Single Male Inlet	
	Woodhead No.	Order No.
White, flanged	1404MB	130149-0005



Super-Safeway Industrial Rubber Cordset

Description	Cord Length	Woodhead No.	Order No.
Yellow 16 gauge SOOW cord	7.62m (25.0')	1404A162	130143-0083

Find adapters and technical support at the end of this section

Features and Benefits

- NEoTEX® Paracril OZO rubber body yields the best performance for abrasion, chemical exposure and temperature extremes within the Super-Safeway™ offering
- Rugged nylon bodies within the Safeway® offering provide exceptional durability and performance
- Color-coded ¼" terminal screws pre-set in open position, ready to wire
- Wire screw terminals are tri-drive to be used with straight blade, Phillips and square-drive screw drivers
- Floating blade construction provides self-alignment, and a better mechanical and electrical connection minimizing wear and heat generation
- Transparent wiring guide to verify all wire strands are in place before securing wire
- Captive, tri-drive head, Stainless Steel, speed screw provides easy assembly and long life
- Two-piece cord-clamp strain relief includes tri-drive screws to firmly secure the cord

Reference Information

UL File No.: Receptacle—E46231

Cordset—E38085

CSA File No.: LR6837



Physical

Plug blades and connector contacts: Nickel-plated Brass
Super-Safeway Outer Housing: NEoTEX Paracril OZO rubber

Safeway Outer Housing: Nylon

Face Screws: Stainless Steel

Face Insert: Nylon

Wire Saddle Clamp: Brass

Cord Clamp Screws: Steel, Zinc-plated

Environmental

Operating Temperature: Maximum continuous 75° C, minimum -40° C (no impact)

Temperature Rise: Maximum 30° C temperature rise at full rated current after 50 cycles of overload at 150% of rated current at a power factor of 75%.

Industrial Duty Wiring Devices Straight Blade 15A 125V 2-Pole/3-Wire NEMA 5-15

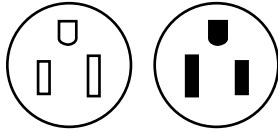

Features and Benefits

- NEoTEX® Paracril OZO rubber body yields the best performance for abrasion, chemical exposure and temperature extremes within the Super-Safeway™ offering
- Rugged nylon bodies within the Safeway® offering provide exceptional durability and performance.
- Color-coded ¼" terminal screws pre-set in open position, ready to wire
- Wire screw terminals are tri-drive to be used with straight blade, Phillips and square-drive screw drivers
- Floating blade construction provides self-alignment, and a better mechanical and electrical connection minimizing wear and heat generation
- Transparent wiring guide to verify all wire strands are in place before securing wire
- Captive, tri-drive head, Stainless Steel, speed screw provides easy assembly and long life
- Two-piece cord-clamp strain relief includes tri-drive screws to firmly secure the cord

Reference Information

UL File No.: E10176
CSA File No.: LR6837



Physical

Plug blades and connector contacts: Nickel-plated Brass
Super-Safeway Outer Housing: NEoTEX Paracril OZO rubber

Safeway Outer Housing: Nylon
Face Screws: Stainless Steel
Face Insert: Nylon
Wire Saddle Clamp: Brass
Cord Clamp Screws: Steel, Zinc-plated
Plug/Connector Range: .335 to .640"

Environmental

Operating Temperature: Maximum continuous 75° C, minimum -40° C (no impact)
Temperature Rise: Maximum 30° C temperature rise at full rated current after 50 cycles of overload at 150% of rated current at a power factor of 75%.



Super-Safeway Industrial Rubber Plug and Connector

Description	Plug		Connector		Lighted Plug		Lighted Connector	
	Woodhead No.	Order No.	Woodhead No.	Order No.	Woodhead No.	Order No.	Woodhead No.	Order No.
Yellow rubber	1447	130141-0015	1547	130141-0031			15L47 ¹	130141-0040
Black rubber	1447BLK	130141-0016	1547BLK	130141-0032			15L47BLK ¹	130141-0041
Yellow rubber, ground continuity monitor					1447EZ*	130141-0017	1547GCM*	130141-0033



Super-Safeway Industrial Rubber Plug and Connector

Description	Plug		Lighted Connector	
	Woodhead No.	Order No.	Woodhead No.	Order No.
Hospital duty, black rubber, grommet-style grip	85000	130141-0070		
Hospital duty, gray rubber, grommet-style grip			85002*	130141-0071

* Ground Continuity Monitor lights indicating a good ground is present

¹ Light indicates power is present

Find adapters and technical support at the end of this section

Industrial Duty Wiring Devices Straight Blade 15A 125V 2-Pole/3-Wire NEMA 5-15

Wiring Devices

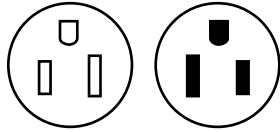

Features and Benefits

- NEoTEX® Paracril OZO rubber body yields the best performance for abrasion, chemical exposure and temperature extremes within the Super-Safeway™ offering
- Rugged nylon bodies within the Safeway® offering provide exceptional durability and performance
- Color-coded ¼" terminal screws pre-set in open position, ready to wire
- Wire screw terminals are tri-drive to be used with straight blade, Phillips and square-drive screw drivers
- Floating blade construction provides self-alignment, and a better mechanical and electrical connection minimizing wear and heat generation
- Transparent wiring guide to verify all wire strands are in place before securing wire
- Captive, tri-drive head, Stainless Steel, speed screw provides easy assembly and long life
- Two-piece cord-clamp strain relief includes tri-drive screws to firmly secure the cord

Reference Information

UL File No.: E10176
CSA File No.: LR6837



Physical

Plug blades and connector contacts: Nickel-plated Brass
Super-Safeway Outer Housing: NEoTEX Paracril OZO rubber
Safeway Outer Housing: Nylon
Face Screws: Stainless Steel
Face Insert: Nylon
Wire Saddle Clamp: Brass
Cord Clamp Screws: Steel, Zinc-plated
Plug/Connector Range: .335 to .640"

Environmental

Operating Temperature: Maximum continuous 75° C, minimum -40° C (no impact)
Temperature Rise: Maximum 30° C temperature rise at full rated current after 50 cycles of overload at 150% of rated current at a power factor of 75%.



5266

5269

5266YL

5269YL

85269

14F47

85447L

5269L

Safeway Industrial Nylon Plug and Connector

Description	Plug		Connector		Lighted Plug		Lighted Connector	
	Woodhead No.	Order No.	Woodhead No.	Order No.	Woodhead No.	Order No.	Woodhead No.	Order No.
Black and white	5266	130144-0036	5269	130144-0044				
Yellow and white	5266YL	130144-0043	5269YL	130144-0050				
Black, hospital duty	85266	130144-0078	85269	130144-0080				
Yellow, hospital duty	85266YL	130144-0079	85269YL	130144-0081				
Transparent, hospital duty	85447	130144-0087	85547	130144-0089	85447L	130144-0088	5269L	130144-0048
Yellow, right angle	14R47	130144-0016						
Transparent, right angle, hospital duty	85050	130144-0075						
Yellow, individually fused	14F47*	130144-0014						

* UL File No. 52190, not CSA

Find adapters and technical support at the end of this section

Industrial Duty Wiring Devices Straight Blade 15A 125V 2-Pole/3-Wire NEMA 5-15

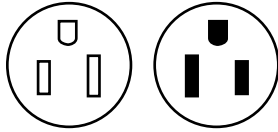

Features and Benefits

- NEoTEX® Paracril OZO rubber body yields the best performance for abrasion, chemical exposure and temperature extremes within the Super-Safeway™ offering
- Rugged nylon bodies within the Safeway® offering provide exceptional durability and performance
- Color-coded ¼" terminal screws pre-set in open position, ready to wire
- Wire screw terminals are tri-drive to be used with straight blade, Phillips and square-drive screw drivers
- Floating blade construction provides self-alignment, and a better mechanical and electrical connection minimizing wear and heat generation
- Transparent wiring guide to verify all wire strands are in place before securing wire
- Captive, tri-drive head, Stainless Steel, speed screw provides easy assembly and long life
- Two-piece cord-clamp strain relief includes tri-drive screws to firmly secure the cord

Reference Information

UL File No.: E46237
CSA File No.: LR6837



Physical

Plug blades and connector contacts: Nickel-plated Brass
Super-Safeway Outer Housing: NEoTEX Paracril OZO rubber

Safeway Outer Housing: Nylon

Face Screws: Stainless Steel

Face Insert: Nylon

Wire Saddle Clamp: Brass

Cord Clamp Screws: Steel, Zinc-plated

Environmental

Operating Temperature: Maximum continuous 75° C, minimum -40° C (no impact)

Temperature Rise: Maximum 30° C temperature rise at full rated current after 50 cycles of overload at 150% of rated current at a power factor of 75%.

D

Wiring Devices



5261DW



1547MB



5252DWBK



5262DWCR



1447MB



85447MB

Safeway Receptacle and Inlet

Description	Single Receptacle		Duplex Receptacle		Single Male Inlet	
	Woodhead No.	Order No.	Woodhead No.	Order No.	Woodhead No.	Order No.
White, flanged	1547MB	130149-0012			1447MB	130149-0008
White, flanged, hospital duty					85447MB	130149-0094
Brown			5252DW	130148-0075		
Black			5252DWBK	130148-0076		
Brown, heavy-duty	5261DW	130149-0087	5262DW	130148-0083		
Ivory, heavy-duty	5261DWI	130149-0088	5262DWI	130148-0086		
White, heavy-duty			5262DWW	130148-0089		
Yellow, heavy-duty corrosion resistant			5262DWCR	130148-0084		
Brown, heavy duty, hospital duty			85262DW	130148-0114		
Ivory, heavy duty, hospital duty			85262DWI	130148-0115		
Red, heavy duty, hospital duty			85262DWR	130148-0116		
White, heavy duty, hospital duty			85262DWW	130148-0117		

Find adapters and technical support at the end of this section

Industrial Duty Wiring Devices Straight Blade 15A 125V 2-Pole/3-Wire NEMA 5-15

Wiring Devices

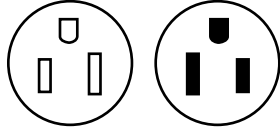

Features and Benefits

- NEoTEX® Paracril OZO rubber body yields the best performance for abrasion, chemical exposure and temperature extremes within the Super-Safeway™ offering
- Rugged nylon bodies within the Safeway® offering provide exceptional durability and performance
- Color-coded ¼" terminal screws pre-set in open position, ready to wire
- Wire screw terminals are tri-drive to be used with straight blade, Phillips and square-drive screw drivers
- Floating blade construction provides self-alignment, and a better mechanical and electrical connection minimizing wear and heat generation
- Transparent wiring guide to verify all wire strands are in place before securing wire
- Captive, tri-drive head, Stainless Steel, speed screw provides easy assembly and long life
- Two-piece cord-clamp strain relief includes tri-drive screws to firmly secure the cord

Reference Information

UL File No.: E38085
CSA File No.: LR6837



Physical

Plug blades and connector contacts: Nickel-plated Brass
Super-Safeway Outer Housing: NEoTEX Paracril OZO rubber

Safeway Outer Housing: Nylon

Face Screws: Stainless Steel

Face Insert: Nylon

Wire Saddle Clamp: Brass

Cord Clamp Screws: Steel, Zinc-plated

Environmental

Operating Temperature: Maximum continuous 75° C, minimum -40° C (no impact)

Temperature Rise: Maximum 30° C temperature rise at full rated current after 50 cycles of overload at 150% of rated current at a power factor of 75%.



Super-Safeway Industrial Rubber Cordset

Description	Cord Length	Woodhead No.	Order No.
Yellow 16 gauge S00W cord	7.62m (25.0')	1447A163	130143-0097
	15.24m (50.0')	1447B163	130143-0104
	30.48m (100.0')	1447D163	130143-0113
Yellow 14 gauge S00W cord	1.83m (6.0')	1447L143	130143-0114
	7.62m (25.0')	1447A143	130143-0095
	15.24m (50.0')	1447B143	130143-0102
	30.48m (100.0')	1447D143	130143-0111
Yellow 12 gauge S00W cord	7.62m (25.0')	1447A123	130143-0093
	15.24m (50.0')	1447B123	130143-0099

Super-Safeway Industrial Rubber Cordset with Inline GFCI

Description	Cord Length	Woodhead No.	Order No.
Yellow, 14 gauge SJOW cord with inline GFCI	15.24m (50.0')	1447B143IN	130143-0103

Find adapters and technical support at the end of this section

Industrial Duty Wiring Devices Straight Blade 15A 125V 2-Pole/3-Wire NEMA 5-15

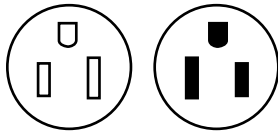

Features and Benefits

- NEōTEX® Paracril OZO rubber body yields the best performance for abrasion, chemical exposure and temperature extremes within the Super-Safeway™ offering
- Rugged nylon bodies within the Safeway® offering provide exceptional durability and performance
- Color-coded ¼" terminal screws pre-set in open position, ready to wire
- Wire screw terminals are tri-drive to be used with straight blade, Phillips and square-drive screw drivers
- Floating blade construction provides self-alignment, and a better mechanical and electrical connection minimizing wear and heat generation
- Transparent wiring guide to verify all wire strands are in place before securing wire
- Captive, tri-drive head, Stainless Steel, speed screw provides easy assembly and long life
- Two-piece cord-clamp strain relief includes tri-drive screws to firmly secure the cord

Reference Information

UL File No.: E38085

Y and W Non-Inline GFCI Cordset—E38085

CSA File No.: LR6837

Y and W Non-Inline GFCI Cordset—LL52750



Physical

Plug blades and connector contacts: Nickel-plated Brass
Super-Safeway Outer Housing: NEōTEX Paracril OZO rubber

Safeway Outer Housing: Nylon

Face Screws: Stainless Steel

Face Insert: Nylon

Wire Saddle Clamp: Brass

Cord Clamp Screws: Steel, Zinc-plated

Environmental

Operating Temperature: Maximum continuous 75° C, minimum -40° C (no impact)

Temperature Rise: Maximum 30° C temperature rise at full rated current after 50 cycles of overload at 150% of rated current at a power factor of 75%.



Super-Safeway Industrial Rubber Molded Y and W Cordset

Description	Color	Y-Cordset, 3.0'		W-Cordset, 3.0'	
		Woodhead No.	Order No.	Woodhead No.	Order No.
Yellow, 12 gauge S00W cord	Yellow	1447-Y	130154-0038	1447-W	130154-0035
Black, 12 gauge S00W cord	Black	1447-YB	130154-0039		



Super-Safeway Industrial Rubber Molded Cordset

Description	Y-Cordset, 3.0'		W-Cordset, 3.0'	
	Woodhead No.	Order No.	Woodhead No.	Order No.
Yellow, 12 gauge SJ0W cord with inline GFCI	1447-Y-IN	130154-0040	1447-W-IN	130154-0037

Find adapters and technical support at the end of this section

Industrial Duty Wiring Devices Straight Blade 15A 250V 2-Pole/3-Wire NEMA 6-15

Wiring Devices

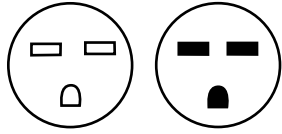

Features and Benefits

- NEoTEX® Paracril OZO rubber body yields the best performance for abrasion, chemical exposure and temperature extremes within the Super-Safeway™ offering
- Rugged nylon bodies within the Safeway® offering provide exceptional durability and performance
- Color-coded ¼" terminal screws pre-set in open position, ready to wire
- Wire screw terminals are tri-drive to be used with straight blade, Phillips and square-drive screw drivers
- Floating blade construction provides self-alignment, and a better mechanical and electrical connection minimizing wear and heat generation
- Transparent wiring guide to verify all wire strands are in place before securing wire
- Captive, tri-drive head, Stainless Steel, speed screw provides easy assembly and long life
- Two-piece cord-clamp strain relief includes tri-drive screws to firmly secure the cord

Reference Information

UL File No.: Plug and Connector—E10176

Receptacle—E46237

CSA File No.: LR6837



Physical

Plug blades and connector contacts: Nickel-plated Brass
Super-Safeway Outer Housing: NEoTEX Paracril OZO rubber

Safeway Outer Housing: Nylon

Face Screws: Stainless Steel

Face Insert: Nylon

Wire Saddle Clamp: Brass

Cord Clamp Screws: Steel, Zinc-plated

Plug/Connector Range: .335 to .640"

Environmental

Operating Temperature: Maximum continuous 75° C, minimum -40° C (no impact)

Temperature Rise: Maximum 30° C temperature rise at full rated current after 50 cycles of overload at 150% of rated current at a power factor of 75%.



Super-Safeway Industrial Rubber Plug and Connector

Description	Plug		Connector	
	Woodhead No.	Order No.	Woodhead No.	Order No.
Yellow rubber	1449	130141-0022	1549	130141-0038



Safeway Industrial Nylon Plug and Connector

Description	Plug		Connector	
	Woodhead No.	Order No.	Woodhead No.	Order No.
Black and white	5666	130144-0065	5669	130144-0067



Safeway Receptacle and Inlet

Description	Duplex Receptacle	
	Woodhead No.	Order No.
Brown, heavy-duty	5662DW	130148-0111
Yellow, heavy-duty corrosion resistant	5662DWCR	130148-0112

Find adapters and technical support at the end of this section.

Industrial Duty Wiring Devices Straight Blade 15A 250V 2-Pole/3-Wire NEMA 6-15

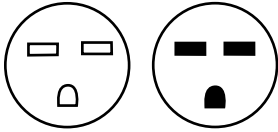

Features and Benefits

- NEōTEX® Paracril OZO rubber body yields the best performance for abrasion, chemical exposure and temperature extremes within the Super-Safeway™ offering
- Rugged nylon bodies within the Safeway® offering provide exceptional durability and performance
- Color-coded ¼" terminal screws pre-set in open position, ready to wire
- Wire screw terminals are tri-drive to be used with straight blade, Phillips and square-drive screw drivers
- Floating blade construction provides self-alignment, and a better mechanical and electrical connection minimizing wear and heat generation
- Transparent wiring guide to verify all wire strands are in place before securing wire
- Captive, tri-drive head, Stainless Steel, speed screw provides easy assembly and long life
- Two-piece cord-clamp strain relief includes tri-drive screws to firmly secure the cord

Reference Information

UL File No.: E38085
W Cordset—E38085
CSA File No.: LR6837
W Cordset—LL52750



Physical

Plug blades and connector contacts: Nickel-plated Brass
Super-Safeway Outer Housing: NEōTEX Paracril OZO rubber
Safeway Outer Housing: Nylon
Face Screws: Stainless Steel
Face Insert: Nylon
Wire Saddle Clamp: Brass
Cord Clamp Screws: Steel, Zinc-plated

Environmental

Operating Temperature: Maximum continuous 75° C, minimum -40° C (no impact)
Temperature Rise: Maximum 30° C temperature rise at full rated current after 50 cycles of overload at 150% of rated current at a power factor of 75%.

D

Wiring Devices



Super-Safeway Industrial Rubber Cordset

Description	Cord Length	Woodhead No.	Order No.
Yellow 14 gauge SOOW cord	15.24m (50.0')	1449B143	130143-0119



Super-Safeway Industrial Rubber Molded W Cordset

Description	W-Cordset, 3.0'	
	Woodhead No.	Order No.
Yellow 12 gauge SOOW cord	1449-W	130154-0042

Find adapters and technical support at the end of this section

Industrial Duty Wiring Devices Straight Blade 15A 277V 2-Pole/3-Wire NEMA 7-15

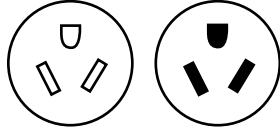

Features and Benefits

- NEoTEX® Paracril OZO rubber body yields the best performance for abrasion, chemical exposure and temperature extremes within the Super-Safeway™ offering
- Rugged nylon bodies within the Safeway® offering provide exceptional durability and performance
- Color-coded ¼" terminal screws pre-set in open position, ready to wire
- Wire screw terminals are tri-drive to be used with straight blade, Phillips and square-drive screw drivers
- Floating blade construction provides self-alignment, and a better mechanical and electrical connection minimizing wear and heat generation
- Transparent wiring guide to verify all wire strands are in place before securing wire
- Captive, tri-drive head, Stainless Steel, speed screw provides easy assembly and long life
- Two-piece cord-clamp strain relief includes tri-drive screws to firmly secure the cord

Reference Information

UL File No.: E10176
CSA File No.: LR6837



Physical

Plug blades and connector contacts: Nickel-plated Brass
Super-Safeway Outer Housing: NEoTEX Paracril OZO rubber

Safeway Outer Housing: Nylon

Face Screws: Stainless Steel

Face Insert: Nylon

Wire Saddle Clamp: Brass

Cord Clamp Screws: Steel, Zinc-plated

Plug/Connector Range: .335 to .640"

Environmental

Operating Temperature: Maximum continuous 75° C, minimum -40° C (no impact)

Temperature Rise: Maximum 30° C temperature rise at full rated current after 50 cycles of overload at 150% of rated current at a power factor of 75%.



1434



1534

Super-Safeway Industrial Rubber Plug and Connector

Description	Plug		Connector	
	Woodhead No.	Order No.	Woodhead No.	Order No.
Yellow rubber	1434	130141-0014	1534	130141-0030



Safeway Industrial Nylon Plug and Connector

Description	Plug		Connector	
	Woodhead No.	Order No.	Woodhead No.	Order No.
Black and white	5766	130144-0069	5769	130144-0071

Find adapters and technical support at the end of this section

Industrial Duty Wiring Devices Straight Blade 20A 125V 2-Pole/3-Wire NEMA 5-20

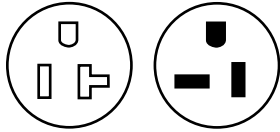

Features and Benefits

- NEoTEX® Paracril OZO rubber body yields the best performance for abrasion, chemical exposure and temperature extremes within the Super-Safeway™ offering
- Rugged nylon bodies within the Safeway® offering provide exceptional durability and performance
- Color-coded ¼" terminal screws pre-set in open position, ready to wire
- Wire screw terminals are tri-drive to be used with straight blade, Phillips and square-drive screw drivers
- Floating blade construction provides self-alignment, and a better mechanical and electrical connection minimizing wear and heat generation
- Transparent wiring guide to verify all wire strands are in place before securing wire
- Captive, tri-drive head, Stainless Steel, speed screw provides easy assembly and long life
- Two-piece cord-clamp strain relief includes tri-drive screws to firmly secure the cord

Reference Information

UL File No.: E10176
CSA File No.: LR6837



Physical

Plug blades and connector contacts: Nickel-plated Brass
Super-Safeway Outer Housing: NEoTEX Paracril OZO rubber

Safeway Outer Housing: Nylon
Face Screws: Stainless Steel
Face Insert: Nylon
Wire Saddle Clamp: Brass
Cord Clamp Screws: Steel, Zinc-plated
Plug/Connector Range: .335 to .640"

Environmental

Operating Temperature: Maximum continuous 75° C, minimum -40° C (no impact)
Temperature Rise: Maximum 30° C temperature rise at full rated current after 50 cycles of overload at 150% of rated current at a power factor of 75%.



1433



1533



1433EZ



1533GCM

Super-Safeway Industrial Rubber Plug and Connector

Description	Plug		Connector		Lighted Plug		Lighted Connector	
	Woodhead No.	Order No.	Woodhead No.	Order No.	Woodhead No.*	Order No.	Woodhead No.*	Order No.
Yellow rubber	1433	130141-0010	1533	130141-0025				
Black rubber	1433BLK	130141-0011						
Yellow rubber, Ground Continuity Monitor					1433EZ	130141-0012	1533GCM	130141-0027

* Ground Continuity Monitor lights indicating a good ground is present



85366



85053



85369

Safeway Industrial Nylon Plug and Connector

Description	Plug		Connector	
	Woodhead No.	Order No.	Woodhead No.	Order No.
Black and white	5366	130144-0053	5369	130144-0057
Orange and white	5366ORG	130144-0054		
Black, hospital duty	85366	130144-0082	85369	130144-0084
Transparent, right angle	85053	130144-0076		

Find adapters and technical support at the end of this section

Industrial Duty Wiring Devices Straight Blade 20A 125V 2-Pole/3-Wire NEMA 5-20

Wiring Devices

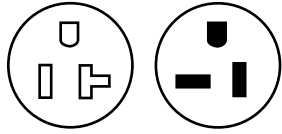

Features and Benefits

- NEoTEX® Paracril OZO rubber body yields the best performance for abrasion, chemical exposure and temperature extremes within the Super-Safeway™ offering
- Rugged nylon bodies within the Safeway® offering provide exceptional durability and performance
- Color-coded ¼" terminal screws pre-set in open position, ready to wire
- Wire screw terminals are tri-drive to be used with straight blade, Phillips and square-drive screw drivers
- Floating blade construction provides self-alignment, and a better mechanical and electrical connection minimizing wear and heat generation
- Transparent wiring guide to verify all wire strands are in place before securing wire
- Captive, tri-drive head, Stainless Steel, speed screw provides easy assembly and long life
- Two-piece cord-clamp strain relief includes tri-drive screws to firmly secure the cord

Reference Information

UL File No.: Receptacle—E46237 (except for 5362DWR)
Cordset—E38085

CSA File No.: LR6837



Physical

Plug blades and connector contacts: Nickel-plated Brass
Super-Safeway Outer Housing: NEoTEX Paracril OZO rubber

Safeway Outer Housing: Nylon

Face Screws: Stainless Steel

Face Insert: Nylon

Wire Saddle Clamp: Brass

Cord Clamp Screws: Steel, Zinc-plated

Environmental

Operating Temperature: Maximum continuous 75° C, minimum -40° C (no impact)

Temperature Rise: Maximum 30° C temperature rise at full rated current after 50 cycles of overload at 150% of rated current at a power factor of 75%.



Safeway Receptacle and Inlet

Description	Single Receptacle		Duplex Receptacle		Single Male Inlet	
	Woodhead No.	Order No.	Woodhead No.	Order No.	Woodhead No.	Order No.
White, flanged	1533MB	130149-0011			1433MB	130149-0007
Brown, heavy-duty	5361DW*	130149-0089	5362DW*	130148-0097		
Black, heavy-duty			5362DWBLK*	130148-0099		
Ivory, heavy-duty			5362DWI*	130148-0102		
Red, heavy-duty			5362DWR*	130148-0104		
Blue, heavy-duty			5362DWBL*	130148-0091		
Yellow, heavy-duty corrosion resistant			5362DWCR*	130148-0100		
Brown, heavy-duty, hospital duty			85362DW*	130148-0118		
Black, heavy-duty, hospital duty			85362DWBLK*	130148-0119		
Ivory, heavy-duty, hospital duty			85362DWI*	130148-0121		
Red, heavy-duty, hospital duty			85362DWR*	130148-0122		
White, heavy-duty, hospital duty			85362DWW*	130148-0123		

* Not CSA listed



Super-Safeway Industrial Rubber Cordset

Description	Cord Length	Woodhead No.	Order No.
Yellow 14 gauge 500W cord	7.62m (25.0')	1433A143	130143-0086
	7.62m (25.0')	1433A123	130143-0084
Yellow 12 gauge 500W cord	15.24m (50.0')	1433B123	130143-0088
	30.48m (100.0')	1433D123	130143-0091

Find adapters and technical support at the end of this section

Industrial Duty Wiring Devices Straight Blade 20A 125V 2-Pole/3-Wire NEMA 5-20

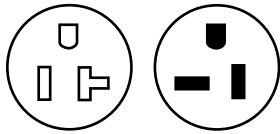

Features and Benefits

- NEōTEX® Paracril OZO rubber body yields the best performance for abrasion, chemical exposure and temperature extremes within the Super-Safeway™ offering
- Rugged nylon bodies within the Safeway® offering provide exceptional durability and performance
- Color-coded ¼" terminal screws pre-set in open position, ready to wire
- Wire screw terminals are tri-drive to be used with straight blade, Phillips and square-drive screw drivers
- Floating blade construction provides self-alignment, and a better mechanical and electrical connection minimizing wear and heat generation
- Transparent wiring guide to verify all wire strands are in place before securing wire
- Captive, tri-drive head, Stainless Steel, speed screw provides easy assembly and long life
- Two-piece cord-clamp strain relief includes tri-drive screws to firmly secure the cord

Reference Information

UL File No.: E38085

Y and W Non-Inline GFCI Cordset—E38085

CSA File No.: LR6837

Y and W Non-Inline GFCI Cordset—LL52750



Physical

Plug blades and connector contacts: Nickel-plated Brass
Super-Safeway Outer Housing: NEōTEX Paracril OZO rubber

Safeway Outer Housing: Nylon

Face Screws: Stainless Steel

Face Insert: Nylon

Wire Saddle Clamp: Brass

Cord Clamp Screws: Steel, Zinc-plated

Environmental

Operating Temperature: Maximum continuous 75° C, minimum -40° C (no impact)

Temperature Rise: Maximum 30° C temperature rise at full rated current after 50 cycles of overload at 150% of rated current at a power factor of 75%.

D

Wiring Devices



Super-Safeway Industrial Rubber Molded Y and W Cordset

Description	Cord Length	Y-Cordset		W-Cordset	
		Woodhead No.	Order No.	Woodhead No.	Order No.
Yellow 12 gauge 500W cord	0.91m (3.0')	1433-Y	130154-0034	1433-W	130154-0033



Super-Safeway Industrial Rubber Molded W Cordset with Inline GFCI

Description	Cord Length	W-Cordset	
		Woodhead No.	Order No.
Yellow, 12 gauge SJOW cord with inline GFCI	0.91m (3.0')	1433-W-IN	130154-0105

Find adapters and technical support at the end of this section

Industrial Duty Wiring Devices Straight Blade 20A 250V 2-Pole/3-Wire NEMA 6-20

Wiring Devices

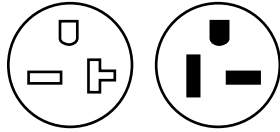

Features and Benefits

- NEoTEX® Paracril OZO rubber body yields the best performance for abrasion, chemical exposure and temperature extremes within the Super-Safeway™ offering
- Rugged nylon bodies within the Safeway® offering provide exceptional durability and performance
- Color-coded ¼" terminal screws pre-set in open position, ready to wire
- Wire screw terminals are tri-drive to be used with straight blade, Phillips and square-drive screw drivers
- Floating blade construction provides self-alignment, and a better mechanical and electrical connection minimizing wear and heat generation
- Transparent wiring guide to verify all wire strands are in place before securing wire
- Captive, tri-drive head, Stainless Steel, speed screw provides easy assembly and long life
- Two-piece cord-clamp strain relief includes tri-drive screws to firmly secure the cord

Reference Information

UL File No.: Plug and Connector—E10176

Receptacle—E46237

CSA File No.: LR6837



Physical

Plug blades and connector contacts: Nickel-plated Brass
Super-Safeway Outer Housing: NEoTEX Paracril OZO rubber

Safeway Outer Housing: Nylon

Face Screws: Stainless Steel

Face Insert: Nylon

Wire Saddle Clamp: Brass

Cord Clamp Screws: Steel, Zinc-plated

Plug/Connector Range: .335 to .640"

Environmental

Operating Temperature: Maximum continuous 75° C, minimum -40° C (no impact)

Temperature Rise: Maximum 30° C temperature rise at full rated current after 50 cycles of overload at 150% of rated current at a power factor of 75%.



Super-Safeway Industrial Rubber Plug and Connector

Description	Plug		Connector	
	Woodhead No.	Order No.	Woodhead No.	Order No.
Yellow rubber	1448	130141-0020	1548	130141-0036



Safeway Industrial Nylon Plug and Connector

Description	Plug		Connector	
	Woodhead No.	Order No.	Woodhead No.	Order No.
Black and white	5466	130144-0061	5469	130144-0063
Yellow and white	5466YL	130144-0062	5469YL	130144-0064



1548MB



5462DW



5462DWCR

Safeway Receptacle and Inlet

Description	Single Receptacle		Duplex Receptacle	
	Woodhead No.	Order No.	Woodhead No.	Order No.
White, flanged	1548MB	130149-0013		
Brown			5452DW*	130148-0106
Brown, heavy-duty			5462DW*	130148-0107
Yellow, heavy-duty corrosion resistant			5462DWCR*	130148-0108

* Not CSA listed

Find adapters and technical support at the end of this section

Industrial Duty Wiring Devices Straight Blade 20A 250V 2-Pole/3-Wire NEMA 6-20

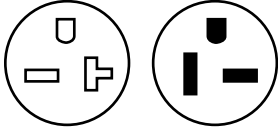

Features and Benefits

- NEōTEX® Paracril OZO rubber body yields the best performance for abrasion, chemical exposure and temperature extremes within the Super-Safeway™ offering
- Rugged nylon bodies within the Safeway® offering provide exceptional durability and performance
- Color-coded ¼" terminal screws pre-set in open position, ready to wire
- Wire screw terminals are tri-drive to be used with straight blade, Phillips and square-drive screw drivers
- Floating blade construction provides self-alignment, and a better mechanical and electrical connection minimizing wear and heat generation
- Transparent wiring guide to verify all wire strands are in place before securing wire
- Captive, tri-drive head, Stainless Steel, speed screw provides easy assembly and long life
- Two-piece cord-clamp strain relief includes tri-drive screws to firmly secure the cord

Reference Information

UL File No.: 38085
Y Non-Inline GFCI Cordset—E38085
CSA File No.: LR6837
Y Non-Inline GFCI Cordset—LL52750



Physical

Plug blades and connector contacts: Nickel-plated Brass
Super-Safeway Outer Housing: NEōTEX Paracril OZO rubber
Safeway Outer Housing: Nylon
Face Screws: Stainless Steel
Face Insert: Nylon
Wire Saddle Clamp: Brass
Cord Clamp Screws: Steel, Zinc-plated

Environmental

Operating Temperature: Maximum continuous 75° C, minimum -40° C (no impact)
Temperature Rise: Maximum 30° C temperature rise at full rated current after 50 cycles of overload at 150% of rated current at a power factor of 75%.



Super-Safeway Industrial Rubber Cordset

Description	Cord Length	Woodhead No.	Order No.
Yellow 14 gauge SOOW cord	7.62m (25.0')	1448A143	130143-0115



Super-Safeway Industrial Rubber Molded Y Cordset

Description	Cord Length	Y-Cordset	
		Woodhead No.	Order No.
Yellow 12 gauge SOOW cord	0.91m (3.0')	1448-Y	130154-0041

Find adapters and technical support at the end of this section

Industrial Duty Wiring Devices Straight Blade 15A 125V 10A 250V 3-Pole/3-Wire Non-NEMA

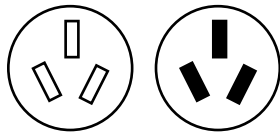

Super-Safeway Industrial Rubber Plug and Connector

Description	Plug		Connector	
	Woodhead No.	Order No.	Woodhead No.	Order No.
Yellow rubber	1407	130141-0007	1507	130141-0024

Features and Benefits

- NEoTEX® Paracril OZO rubber body yields the best performance for abrasion, chemical exposure and temperature extremes within the Super-Safeway™ offering
- Rugged nylon bodies within the Safeway® offering provide exceptional durability and performance
- Color-coded ¼" terminal screws pre-set in open position, ready to wire
- Wire screw terminals are tri-drive to be used with straight blade, Phillips and square-drive screw drivers
- Floating blade construction provides self-alignment, and a better mechanical and electrical connection minimizing wear and heat generation
- Transparent wiring guide to verify all wire strands are in place before securing wire
- Captive, tri-drive head, Stainless Steel, speed screw provides easy assembly and long life
- Two-piece cord-clamp strain relief includes tri-drive screws to firmly secure the cord

Physical

Plug blades and connector contacts: Nickel-plated Brass
Super-Safeway™ Outer Housing: NEoTEX Paracril OZO rubber
Face Screws: Stainless Steel
Face Insert: Nylon
Wire Saddle Clamp: Brass
Cord Clamp Screws: Steel, Zinc-plated
Plug/Connector Range: .335 to .640"

Environmental

Operating Temperature: Maximum continuous 75° C, minimum -40° C (no impact)
Temperature Rise: Maximum 30° C temperature rise at full rated current after 50 cycles of overload at 150% of rated current at a power factor of 75%.

Industrial Duty Wiring Devices Straight Blade 50A 250V 2-Pole/3-Wire NEMA 6-50

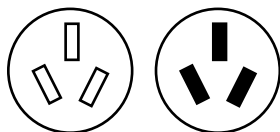

Super-Safeway Industrial Rubber Plug and Connector

Description	Plug		Connector	
	Woodhead No.	Order No.	Woodhead No.	Order No.
Yellow rubber	8664	130142-0051	8665	130142-0052

Find adapters and technical support at the end of this section

Features and Benefits

- NEoTEX® Paracril OZO rubber body yields the best performance for abrasion, chemical exposure and temperature extremes within the Super-Safeway™ offering
- Rugged nylon bodies within the Safeway® offering provide exceptional durability and performance
- Color-coded ¼" terminal screws pre-set in open position, ready to wire
- Wire screw terminals are tri-drive to be used with straight blade, Phillips and square-drive screw drivers
- Floating blade construction provides self-alignment, and a better mechanical and electrical connection minimizing wear and heat generation
- Transparent wiring guide to verify all wire strands are in place before securing wire
- Captive, tri-drive head, Stainless Steel, speed screw provides easy assembly and long life
- Two-piece cord-clamp strain relief includes tri-drive screws to firmly secure the cord

Physical

Plug blades and connector contacts: Nickel-plated Brass
Super-Safeway™ Outer Housing: NEoTEX Paracril OZO rubber
Face Screws: Stainless Steel
Face Insert: Nylon
Wire Saddle Clamp: Brass
Cord Clamp Screws: Steel, Zinc-plated

Environmental

Operating Temperature: Maximum continuous 75° C, minimum -40° C (no impact)
Temperature Rise: Maximum 30° C temperature rise at full rated current after 50 cycles of overload at 150% of rated current at a power factor of 75%.

Industrial Duty Wiring Devices Locking Blade 15A 125V 2-Pole/2-Wire NEMA L1-15

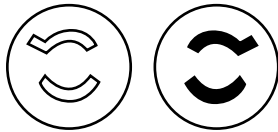

Features and Benefits

- NEoTEX® Paracril OZO rubber body yields the best performance for abrasion, chemical exposure and temperature extremes within the Super-Safeway™ offering
- Rugged nylon bodies within the Safeway® offering provide exceptional durability and performance
- Color-coded ¼" terminal screws pre-set in open position, ready to wire
- Wire screw terminals are tri-drive to be used with straight blade, Phillips and square-drive screw drivers
- Floating blade construction provides self-alignment, and a better mechanical and electrical connection minimizing wear and heat generation
- Transparent wiring guide to verify all wire strands are in place before securing wire
- Captive, tri-drive head, Stainless Steel, speed screw provides easy assembly and long life
- Two-piece cord-clamp strain relief includes tri-drive screws to firmly secure the cord

Reference Information

UL File No.: Plug and Connector—E10176
CSA File No.: LR6837



Physical

Plug blades and connector contacts: Nickel-plated Brass
Super-Safeway Outer Housing: NEoTEX Paracril OZO rubber

Safeway Outer Housing: Nylon

Face Screws: Stainless Steel

Face Insert: Nylon

Wire Saddle Clamp: Brass

Cord Clamp Screws: Steel, Zinc-plated

Plug/Connector Range: .335 to .640"

Environmental

Operating Temperature: Maximum continuous 75° C, minimum -40° C (no impact)

Temperature Rise: Maximum 30° C temperature rise at full rated current after 50 cycles of overload at 150% of rated current at a power factor of 75%.



Super-Safeway Industrial Rubber Plug and Connector

Description	Plug		Connector	
	Woodhead No.	Order No.	Woodhead No.	Order No.
Yellow rubber	2404	130141-0043	2504	130141-0052



Safeway Industrial Nylon Plug and Connector

Description	Plug		Connector	
	Woodhead No.	Order No.	Woodhead No.	Order No.
Black and White	24T04	130144-0017	25T04	130144-0019



Safeway Receptacle and Inlet

Description	Single Receptacle		Single Male	
	Woodhead No.	Order No.	Woodhead No.	Order No.
White, flanged	2504MB	130149-0018	2404MB	130143-0014

Find adapters and technical support at the end of this section

Industrial Duty Wiring Devices Locking Blade 20A 250V 2-Pole/2-Wire NEMA L2-20

Wiring Devices

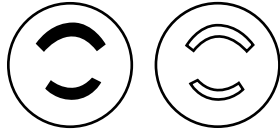

Features and Benefits

- NEoTEX® Paracril OZO rubber body yields the best performance for abrasion, chemical exposure and temperature extremes within the Super-Safeway™ offering
- Rugged nylon bodies within the Safeway® offering provide exceptional durability and performance
- Color-coded ¼" terminal screws pre-set in open position, ready to wire
- Wire screw terminals are tri-drive to be used with straight blade, Phillips and square-drive screw drivers
- Floating blade construction provides self-alignment, and a better mechanical and electrical connection minimizing wear and heat generation
- Transparent wiring guide to verify all wire strands are in place before securing wire
- Captive, tri-drive head, Stainless Steel, speed screw provides easy assembly and long life
- Two-piece cord-clamp strain relief includes tri-drive screws to firmly secure the cord

Reference Information

UL File No.: E10176
CSA File No.: LR6837



Physical

Plug blades and connector contacts: Nickel-plated Brass
Super-Safeway Outer Housing: NEoTEX Paracril OZO rubber

Safeway Outer Housing: Nylon

Face Screws: Stainless Steel

Face Insert: Nylon

Wire Saddle Clamp: Brass

Cord Clamp Screws: Steel, Zinc-plated

Plug/Connector Range: .325 to .840"

Environmental

Operating Temperature: Maximum continuous 75° C, minimum -40° C (no impact)

Temperature Rise: Maximum 30° C temperature rise at full rated current after 50 cycles of overload at 150% of rated current at a power factor of 75%.



Super-Safeway Industrial Rubber Plug and Connector

Description	Plug		Connector	
	Woodhead No.	Order No.	Woodhead No.	Order No.
Yellow rubber	2607	130141-0061	2707	130141-0065



Safeway Industrial Nylon Plug and Connector

Description	Plug		Connector	
	Woodhead No.	Order No.	Woodhead No.	Order No.
Black and white	26T07	130144-0021	27T07	130144-0022

Find adapters and technical support at the end of this section

Industrial Duty Wiring Devices Locking Blade 15A 125V 2-Pole/3-Wire NEMA L5-15

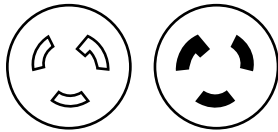

Features and Benefits

- NEōTEX® Paracril OZO rubber body yields the best performance for abrasion, chemical exposure and temperature extremes within the Super-Safeway™ offering
- Rugged nylon bodies within the Safeway® offering provide exceptional durability and performance
- Color-coded ¼" terminal screws pre-set in open position, ready to wire
- Wire screw terminals are tri-drive to be used with straight blade, Phillips and square-drive screw drivers
- Floating blade construction provides self-alignment, and a better mechanical and electrical connection minimizing wear and heat generation
- Transparent wiring guide to verify all wire strands are in place before securing wire
- Captive, tri-drive head, Stainless Steel, speed screw provides easy assembly and long life
- Two-piece cord-clamp strain relief includes tri-drive screws to firmly secure the cord

Reference Information

UL File No.: Plug and Connector—E10176

Receptacle—E46237

CSA File No.: LR6837



Physical

Plug blades and connector contacts: Nickel-plated Brass
Super-Safeway Outer Housing: NEōTEX Paracril OZO rubber

Safeway Outer Housing: Nylon

Face Screws: Stainless Steel

Face Insert: Nylon

Wire Saddle Clamp: Brass

Cord Clamp Screws: Steel, Zinc-plated

Plug/Connector Range: .335 to .640"

Environmental

Operating Temperature: Maximum continuous 75° C, minimum -40° C (no impact)

Temperature Rise: Maximum 30° C temperature rise at full rated current after 50 cycles of overload at 150% of rated current at a power factor of 75%.



Super-Safeway Industrial Rubber Plug and Connector

Description	Plug		Connector		Lighted Plug		Lighted Connector	
	Woodhead No.	Order No.	Woodhead No.	Order No.	Woodhead No.*	Order No.	Woodhead No.*	Order No.
Yellow rubber	2447	130141-0047	2547	130141-0056				
Yellow rubber ground continuity monitor					2447EZ	130141-0048	2547GCM	130141-0057

* Ground continuity monitor lights indicating a good ground is present



Safeway Industrial Nylon Plug and Connector

Description	Plug		Connector	
	Woodhead No.	Order No.	Woodhead No.	Order No.
Black and white	4720	130144-0023	4729	130144-0025
Yellow and white	4720YL	130144-0024	4729YL	130144-0026



Safeway Receptacle and Inlet

Description	Single Receptacle		Duplex Receptacle		Single Male Inlet	
	Woodhead No.	Order No.	Woodhead No.	Order No.	Woodhead No.	Order No.
White, flanged	2547MB	130149-0021			2447MB	130149-0016
Brown, heavy-duty			4700DW ¹	130148-0074		

¹ Not UL/CSA listed

Find adapters and technical support at the end of this section

Industrial Duty Wiring Devices Locking Blade 15A 125V 2-Pole/3-Wire NEMA L5-15

D
Wiring Devices

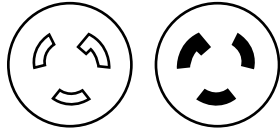

Features and Benefits

- NEoTEX® Paracril OZO rubber body yields the best performance for abrasion, chemical exposure and temperature extremes within the Super-Safeway™ offering
- Rugged nylon bodies within the Safeway® offering provide exceptional durability and performance
- Color-coded ¼" terminal screws pre-set in open position, ready to wire
- Wire screw terminals are tri-drive to be used with straight blade, Phillips and square-drive screw drivers
- Floating blade construction provides self-alignment, and a better mechanical and electrical connection minimizing wear and heat generation
- Transparent wiring guide to verify all wire strands are in place before securing wire
- Captive, tri-drive head, Stainless Steel, speed screw provides easy assembly and long life
- Two-piece cord-clamp strain relief includes tri-drive screws to firmly secure the cord

Reference Information

UL File No.: E38085

Y and W Non-Inline GFCI Cordset—E38085

CSA File No.: LR6837

Y and W Non-Inline GFCI Cordset—LL52750



Physical

Plug blades and connector contacts: Nickel-plated Brass
Super-Safeway Outer Housing: NEoTEX Paracril OZO rubber

Safeway Outer Housing: Nylon

Face Screws: Stainless Steel

Face Insert: Nylon

Wire Saddle Clamp: Brass

Cord Clamp Screws: Steel, Zinc-plated

Environmental

Operating Temperature: Maximum continuous 75° C, minimum -40° C (no impact)

Temperature Rise: Maximum 30° C temperature rise at full rated current after 50 cycles of overload at 150% of rated current at a power factor of 75%.



Super-Safeway Industrial Rubber Cordset

Description	Cord Length	Woodhead No.	Order No.
Yellow 16 gauge SOOW cord	7.62m (25.0')	2447A163	130143-0174
Yellow 14 gauge SOOW Cord	15.2m (50.0')	2447B143	130143-0176
	30.5m (100.0')	2447D143	130143-0178



Super-Safeway Industrial Rubber Molded Y and W Cordset

Description	Cord Length	Y-Cordset		W-Cordset	
		Woodhead No.	Order No.	Woodhead No.	Order No.
Yellow 12 gauge SOOW cord	0.91m (3.0')	2447-Y	130154-0056	2447-W	130154-0055

Find adapters and technical support at the end of this section

Industrial Duty Wiring Devices Locking Blade 15A 250V 2-Pole/3-Wire NEMA L6-15

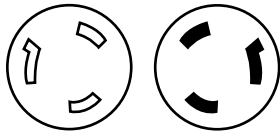

Features and Benefits

- NEōTEX® Paracril OZO rubber body yields the best performance for abrasion, chemical exposure and temperature extremes within the Super-Safeway™ offering
- Rugged nylon bodies within the Safeway® offering provide exceptional durability and performance
- Color-coded ¼" terminal screws pre-set in open position, ready to wire
- Wire screw terminals are tri-drive to be used with straight blade, Phillips and square-drive screw drivers
- Floating blade construction provides self-alignment, and a better mechanical and electrical connection minimizing wear and heat generation
- Transparent wiring guide to verify all wire strands are in place before securing wire
- Captive, tri-drive head, Stainless Steel, speed screw provides easy assembly and long life
- Two-piece cord-clamp strain relief includes tri-drive screws to firmly secure the cord

Reference Information

UL File No.: E10176
CSA File No.: LR6837



Physical

Plug blades and connector contacts: Nickel-plated Brass
Super-Safeway Outer Housing: NEōTEX Paracril OZO rubber

Safeway Outer Housing: Nylon
Face Screws: Stainless Steel
Face Insert: Nylon
Wire Saddle Clamp: Brass
Cord Clamp Screws: Steel, Zinc-plated
Plug/Connector Range: .335 to .640"

Environmental

Operating Temperature: Maximum continuous 75° C, minimum -40° C (no impact)
Temperature Rise: Maximum 30° C temperature rise at full rated current after 50 cycles of overload at 150% of rated current at a power factor of 75%.



Super-Safeway Industrial Rubber Plug and Connector

Description	Plug		Connector	
	Woodhead No.	Order No.	Woodhead No.	Order No.
Yellow rubber	2449	130141-0051	2549	130141-0060



Safeway Receptacle and Inlet

Description	Single Receptacle		Single Male Inlet	
	Woodhead No.	Order No.	Woodhead No.	Order No.
White, flanged	2549MB	130149-0022	2449MB	130149-0017

Find adapters and technical support at the end of this section

Industrial Duty Wiring Devices Locking Blade 15A 277V 2-Pole/3-Wire NEMA L7-15

Wiring Devices

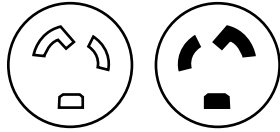

Features and Benefits

- NEoTEX® Paracril OZO rubber body yields the best performance for abrasion, chemical exposure and temperature extremes within the Super-Safeway™ offering
- Rugged nylon bodies within the Safeway® offering provide exceptional durability and performance
- Color-coded ¼" terminal screws pre-set in open position, ready to wire
- Wire screw terminals are tri-drive to be used with straight blade, Phillips and square-drive screw drivers
- Floating blade construction provides self-alignment, and a better mechanical and electrical connection minimizing wear and heat generation
- Transparent wiring guide to verify all wire strands are in place before securing wire
- Captive, tri-drive head, Stainless Steel, speed screw provides easy assembly and long life
- Two-piece cord-clamp strain relief includes tri-drive screws to firmly secure the cord

Reference Information

UL File No.: E10176
CSA File No.: LR6837



Physical

Plug blades and connector contacts: Nickel-plated Brass
Super-Safeway Outer Housing: NEoTEX Paracril OZO rubber

Safeway Outer Housing: Nylon

Face Screws: Stainless Steel

Face Insert: Nylon

Wire Saddle Clamp: Brass

Cord Clamp Screws: Steel, Zinc-plated

Plug/Connector Range: .335 to .640"

Environmental

Operating Temperature: Maximum continuous 75° C, minimum -40° C (no impact)

Temperature Rise: Maximum 30° C temperature rise at full rated current after 50 cycles of overload at 150% of rated current at a power factor of 75%.



Super-Safeway Industrial Rubber Plug and Connector

Description	Plug		Connector	
	Woodhead No.	Order No.	Woodhead No.	Order No.
Yellow rubber	2434	130141-0045	2534	130141-0054



Safeway Industrial Nylon Plug and Connector

Description	Plug		Connector	
	Woodhead No.	Order No.	Woodhead No.	Order No.
Black and white	4770	130144-0031	4779	130144-0033



Safeway Receptacle and Inlet

Description	Single Receptacle	
	Woodhead No.	Order No.
White, flanged	2534MB	130149-0020

Find adapters and technical support at the end of this section

Industrial Duty Wiring Devices Locking Blade 20A 125V 2-Pole/3-Wire NEMA L5-20

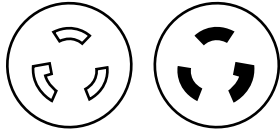

Features and Benefits

- NEōTEX® Paracril OZO rubber body yields the best performance for abrasion, chemical exposure and temperature extremes within the Super-Safeway™ offering
- Rugged nylon bodies within the Safeway® offering provide exceptional durability and performance
- Color-coded ¼" terminal screws pre-set in open position, ready to wire
- Wire screw terminals are tri-drive to be used with straight blade, Phillips and square-drive screw drivers
- Floating blade construction provides self-alignment, and a better mechanical and electrical connection minimizing wear and heat generation
- Transparent wiring guide to verify all wire strands are in place before securing wire
- Captive, tri-drive head, Stainless Steel, speed screw provides easy assembly and long life
- Two-piece cord-clamp strain relief includes tri-drive screws to firmly secure the cord

Reference Information

UL File No.: Plug and Connector—E10176

Receptacle—E68122

CSA File No.: LR6837



Physical

Plug blades and connector contacts: Nickel-plated Brass
Super-Safeway Outer Housing: NEōTEX Paracril OZO rubber

Safeway Outer Housing: Nylon

Face Screws: Stainless Steel

Face Insert: Nylon

Wire Saddle Clamp: Brass

Cord Clamp Screws: Steel, Zinc-plated

Plug/Connector Range: .335 to .640"

Environmental

Operating Temperature: Maximum continuous 75° C, minimum -40° C (no impact)

Temperature Rise: Maximum 30° C temperature rise at full rated current after 50 cycles of overload at 150% of rated current at a power factor of 75%.



Super-Safeway Industrial Rubber Plug and Connector

Description	Plug		Connector	
	Woodhead No.	Order No.	Woodhead No.	Order No.
Yellow rubber	2647	130141-0062	2747	130142-0021



Safeway Industrial Nylon Plug and Connector

Description	Plug		Connector	
	Woodhead No.	Order No.	Woodhead No.	Order No.
Black and white	26T47	130145-0008	27T47	130145-0030
Yellow and white	26T47YL	130145-0010	27T47YL	130145-0031



Safeway Receptacle and Inlet

Description	Single Receptacle		Single Male Inlet	
	Woodhead No.	Order No.	Woodhead No.	Order No.
White, flanged	2747MB	130149-0039	2647MB	130149-0027
Black, heavy-duty	4747	130149-0066		
Yellow, heavy-duty corrosion resistant	4747CR	130149-0067		

Find adapters and technical support at the end of this section

Industrial Duty Wiring Devices Locking Blade 20A 125V 2-Pole/3-Wire NEMA L5-20

D
Wiring Devices

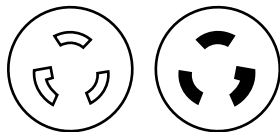

Features and Benefits

- NEoTEX® Paracril OZO rubber body yields the best performance for abrasion, chemical exposure and temperature extremes within the Super-Safeway™ offering
- Rugged nylon bodies within the Safeway® offering provide exceptional durability and performance
- Color-coded ¼" terminal screws pre-set in open position, ready to wire
- Wire screw terminals are tri-drive to be used with straight blade, Phillips and square-drive screw drivers
- Floating blade construction provides self-alignment, and a better mechanical and electrical connection minimizing wear and heat generation
- Transparent wiring guide to verify all wire strands are in place before securing wire
- Captive, tri-drive head, Stainless Steel, speed screw provides easy assembly and long life
- Two-piece cord-clamp strain relief includes tri-drive screws to firmly secure the cord

Reference Information

UL File No.: E38085
CSA File No.: LR6837



Physical

Plug blades and connector contacts: Nickel-plated Brass
Super-Safeway Outer Housing: NEoTEX Paracril OZO rubber
Safeway Outer Housing: Nylon
Face Screws: Stainless Steel
Face Insert: Nylon
Wire Saddle Clamp: Brass
Cord Clamp Screws: Steel, Zinc-plated

Environmental

Operating Temperature: Maximum continuous 75° C, minimum -40° C (no impact)
Temperature Rise: Maximum 30° C temperature rise at full rated current after 50 cycles of overload at 150% of rated current at a power factor of 75%.



Super-Safeway Industrial Rubber Cordset

Description	Cord Length	Woodhead No.	Order No.
Yellow 14 gauge 500W cord	7.62m (25.0')	2647A143	130143-0204
	15.2m (50.0')	2647B143	130143-0207
Yellow 12 gauge 500W cord	7.62m (25.0')	2647A123	130143-0203
	15.2m (50.0')	2647B123	130143-0205
	30.5m (100.0')	2647D123	130143-0209



Super-Safeway Industrial Rubber Cordset with Inline GFCI

Description	Cord Length	Woodhead No.	Order No.
Yellow 12 gauge SJOW cord with inline GFCI	.305m (1.0')	2647E123IN	130143-0210

Find adapters and technical support at the end of this section

**Industrial Duty
Wiring Devices
Locking Blade
20A 125V
2-Pole/3-Wire
NEMA L5-20**

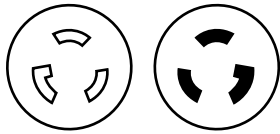

Features and Benefits

- NEōTEX® Paracril OZO rubber body yields the best performance for abrasion, chemical exposure and temperature extremes within the Super-Safeway™ offering
- Rugged nylon bodies within the Safeway® offering provide exceptional durability and performance
- Color-coded ¼" terminal screws pre-set in open position, ready to wire
- Wire screw terminals are tri-drive to be used with straight blade, Phillips and square-drive screw drivers
- Floating blade construction provides self-alignment, and a better mechanical and electrical connection minimizing wear and heat generation
- Transparent wiring guide to verify all wire strands are in place before securing wire
- Captive, tri-drive head, Stainless Steel, speed screw provides easy assembly and long life
- Two-piece cord-clamp strain relief includes tri-drive screws to firmly secure the cord

Reference Information

UL File No.: E38085
Y and W Non-Inline GFCI Cordset—E38085
CSA File No.: LR6837
Y and W Non-Inline GFCI Cordset—LL52750



Physical

Plug blades and connector contacts: Nickel-plated Brass
Super-Safeway Outer Housing: NEōTEX Paracril OZO rubber
Safeway Outer Housing: Nylon
Face Screws: Stainless Steel
Face Insert: Nylon
Wire Saddle Clamp: Brass
Cord Clamp Screws: Steel, Zinc-plated

Environmental

Operating Temperature: Maximum continuous 75° C, minimum -40° C (no impact)
Temperature Rise: Maximum 30° C temperature rise at full rated current after 50 cycles of overload at 150% of rated current at a power factor of 75%.



Super-Safeway Industrial Rubber Molded Y and W Cordset

Description	Cord Length	Y-Cordset		W-Cordset	
		Woodhead No.	Order No.	Woodhead No.	Order No.
Yellow 12 gauge 500W cord	0.91m (3.0')	2647-Y	130154-0064	2647-W	130154-0062



Super-Safeway Industrial Rubber Molded Y and W Cordset with Inline GFCI

Description	Cord Length	Y-Cordset		W-Cordset	
		Woodhead No.	Order No.	Woodhead No.	Order No.
Yellow 12 gauge SJOW cord with inline GFCI	0.91m (3.0')	2647-Y-IN	130154-0065	2647-W-IN	130154-0063

Find adapters and technical support at the end of this section

Industrial Duty Wiring Devices Locking Blade 20A 250V 2-Pole/3-Wire NEMA L6-20

Wiring Devices

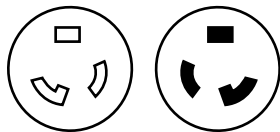

Features and Benefits

- NEoTEX® Paracril OZO rubber body yields the best performance for abrasion, chemical exposure and temperature extremes within the Super-Safeway™ offering
- Rugged nylon bodies within the Safeway® offering provide exceptional durability and performance
- Color-coded ¼" terminal screws pre-set in open position, ready to wire
- Wire screw terminals are tri-drive to be used with straight blade, Phillips and square-drive screw drivers
- Floating blade construction provides self-alignment, and a better mechanical and electrical connection minimizing wear and heat generation
- Transparent wiring guide to verify all wire strands are in place before securing wire
- Captive, tri-drive head, Stainless Steel, speed screw provides easy assembly and long life
- Two-piece cord-clamp strain relief includes tri-drive screws to firmly secure the cord

Reference Information

UL File No.: Plug and Connector—E10176

Receptacle—E46237

CSA File No.: LR6837



Physical

Plug blades and connector contacts: Nickel-plated Brass
Super-Safeway Outer Housing: NEoTEX Paracril OZO rubber

Safeway Outer Housing: Nylon

Face Screws: Stainless Steel

Face Insert: Nylon

Wire Saddle Clamp: Brass

Cord Clamp Screws: Steel, Zinc-plated

Plug/Connector Range: .325 to .840"

Environmental

Operating Temperature: Maximum continuous 75° C, minimum -40° C (no impact)

Temperature Rise: Maximum 30° C temperature rise at full rated current after 50 cycles of overload at 150% of rated current at a power factor of 75%.



Super-Safeway Industrial Rubber Plug and Connector

Description	Plug		Connector	
	Woodhead No.	Order No.	Woodhead No.	Order No.
Yellow rubber	2648	130141-0063	2748	130141-0066



Safeway Industrial Nylon Plug and Connector

Description	Plug		Connector	
	Woodhead No.	Order No.	Woodhead No.	Order No.
Black and white	26T48	130145-0011	27T48	130145-0032
Yellow and white	26T48YL	130145-0012	27T48YL	130145-0033



Safeway Receptacle and Inlet

Description	Single Receptacle		Single Male Inlet	
	Woodhead No.	Order No.	Woodhead No.	Order No.
White, flanged	2748MB	130149-0040	2648MB	130149-0028
Black, heavy-duty	4748	130149-0068		
Yellow, heavy-duty corrosion resistant	4748CR	130149-0069		

Find adapters and technical support at the end of this section

**Industrial Duty
Wiring Devices
Locking Blade
20A 250V
2-Pole/3-Wire
NEMA L6-20**

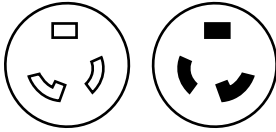

Features and Benefits

- NEöTEX® Paracril OZO rubber body yields the best performance for abrasion, chemical exposure and temperature extremes within the Super-Safeway™ offering
- Rugged nylon bodies within the Safeway® offering provide exceptional durability and performance
- Color-coded ¼" terminal screws pre-set in open position, ready to wire
- Wire screw terminals are tri-drive to be used with straight blade, Phillips and square-drive screw drivers
- Floating blade construction provides self-alignment, and a better mechanical and electrical connection minimizing wear and heat generation
- Transparent wiring guide to verify all wire strands are in place before securing wire
- Captive, tri-drive head, Stainless Steel, speed screw provides easy assembly and long life
- Two-piece cord-clamp strain relief includes tri-drive screws to firmly secure the cord

Reference Information

UL File No.: E38085
CSA File No.: LR6837



Physical

Plug blades and connector contacts: Nickel-plated Brass
Super-Safeway Outer Housing: NEöTEX Paracril OZO rubber
Safeway Outer Housing: Nylon
Face Screws: Stainless Steel
Face Insert: Nylon
Wire Saddle Clamp: Brass
Cord Clamp Screws: Steel, Zinc-plated

Environmental

Operating Temperature: Maximum continuous 75° C, minimum -40° C (no impact)
Temperature Rise: Maximum 30° C temperature rise at full rated current after 50 cycles of overload at 150% of rated current at a power factor of 75%.



Super-Safeway Industrial Rubber Cordset

Description	Cord Length	Woodhead No.	Order No.
Yellow 14 gauge SOOW cord	7.62m (25.0')	2648A143	130143-0212
Yellow 12 gauge SOOW cord	7.62m (25.0')	2648A123	130143-0211

Find adapters and technical support at the end of this section

Industrial Duty Wiring Devices Locking Blade 20A 277V 2-Pole/3-Wire NEMA L7-20

D
Wiring Devices

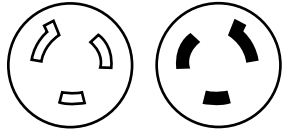

Features and Benefits

- NEoTEX® Paracril OZO rubber body yields the best performance for abrasion, chemical exposure and temperature extremes within the Super-Safeway™ offering
- Rugged nylon bodies within the Safeway® offering provide exceptional durability and performance
- Color-coded ¼" terminal screws pre-set in open position, ready to wire
- Wire screw terminals are tri-drive to be used with straight blade, Phillips and square-drive screw drivers
- Floating blade construction provides self-alignment, and a better mechanical and electrical connection minimizing wear and heat generation
- Transparent wiring guide to verify all wire strands are in place before securing wire
- Captive, tri-drive head, Stainless Steel, speed screw provides easy assembly and long life
- Two-piece cord-clamp strain relief includes tri-drive screws to firmly secure the cord

Reference Information

UL File No.: E10176
CSA File No.: LR6837



Physical

Plug blades and connector contacts: Nickel-plated Brass
Super-Safeway Outer Housing: NEoTEX Paracril OZO rubber

Safeway Outer Housing: Nylon

Face Screws: Stainless Steel

Face Insert: Nylon

Wire Saddle Clamp: Brass

Cord Clamp Screws: Steel, Zinc-plated

Plug/Connector Range: .325 to .840"

Environmental

Operating Temperature: Maximum continuous 75° C, minimum -40° C (no impact)

Temperature Rise: Maximum 30° C temperature rise at full rated current after 50 cycles of overload at 150% of rated current at a power factor of 75%.



Super-Safeway Industrial Rubber Plug and Connector

Description	Plug		Connector	
	Woodhead No.	Order No.	Woodhead No.	Order No.
Yellow rubber	2649	130141-0064	2749	130142-0023



Safeway Industrial Nylon Plug and Connector

Description	Plug		Connector	
	Woodhead No.	Order No.	Woodhead No.	Order No.
Black and white	26749	130145-0013	27749	130145-0034



Safeway Receptacle and Inlet

Description	Single Receptacle	
	Woodhead No.	Order No.
Black, heavy-duty	4749	130149-0070
White, flanged	2749MB	130149-0041

Find adapters and technical support at the end of this section

Industrial Duty Wiring Devices Locking Blade 30A 125V 2-Pole/3-Wire NEMA L5-30

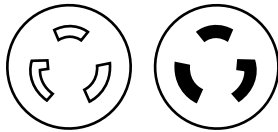

Features and Benefits

- NEōTEX® Paracril OZO rubber body yields the best performance for abrasion, chemical exposure and temperature extremes within the Super-Safeway™ offering
- Rugged nylon bodies within the Safeway® offering provide exceptional durability and performance
- Color-coded ¼" terminal screws pre-set in open position, ready to wire
- Wire screw terminals are tri-drive to be used with straight blade, Phillips and square-drive screw drivers
- Floating blade construction provides self-alignment, and a better mechanical and electrical connection minimizing wear and heat generation
- Transparent wiring guide to verify all wire strands are in place before securing wire
- Captive, tri-drive head, Stainless Steel, speed screw provides easy assembly and long life
- Two-piece cord-clamp strain relief includes tri-drive screws to firmly secure the cord

Reference Information

UL File No.: E38085
CSA File No.: LR6837



Physical

Plug blades and connector contacts: Nickel-plated Brass
Super-Safeway Outer Housing: NEōTEX Paracril OZO rubber

Safeway Outer Housing: Nylon
Face Screws: Stainless Steel
Face Insert: Nylon
Wire Saddle Clamp: Brass
Cord Clamp Screws: Steel, Zinc-plated
Plug/Connector Range: .325 to .840"

Environmental

Operating Temperature: Maximum continuous 75° C, minimum -40° C (no impact)
Temperature Rise: Maximum 30° C temperature rise at full rated current after 50 cycles of overload at 150% of rated current at a power factor of 75%.



Super-Safeway Industrial Rubber Plug and Connector

Description	Plug		Connector	
	Woodhead No.	Order No.	Woodhead No.	Order No.
Yellow rubber	2847	130142-0033	2947	130141-0067



Safeway Industrial Nylon Plug and Connector

Description	Plug		Connector	
	Woodhead No.	Order No.	Woodhead No.	Order No.
Black and white	28T47	130145-0048	29T47	130145-0071



Super-Safeway Industrial Rubber Cordset

Description	Cord Length	Woodhead No.	Order No.
Yellow 12 gauge SOOW cord	7.62m (25.0')	2847A123	130143-0252

Find adapters and technical support at the end of this section

Industrial Duty Wiring Devices Locking Blade 30A 250V 2-Pole/3-Wire NEMA L6-30

Wiring Devices

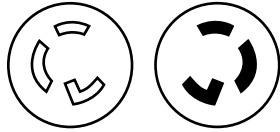

Features and Benefits

- NEoTEX® Paracril OZO rubber body yields the best performance for abrasion, chemical exposure and temperature extremes within the Super-Safeway™ offering
- Rugged nylon bodies within the Safeway® offering provide exceptional durability and performance
- Color-coded ¼" terminal screws pre-set in open position, ready to wire
- Wire screw terminals are tri-drive to be used with straight blade, Phillips and square-drive screw drivers
- Floating blade construction provides self-alignment, and a better mechanical and electrical connection minimizing wear and heat generation
- Transparent wiring guide to verify all wire strands are in place before securing wire
- Captive, tri-drive head, Stainless Steel, speed screw provides easy assembly and long life
- Two-piece cord-clamp strain relief includes tri-drive screws to firmly secure the cord

Reference Information

UL File No.: E10176
CSA File No.: LR6837



Physical

Plug blades and connector contacts: Nickel-plated Brass
Super-Safeway Outer Housing: NEoTEX Paracril OZO rubber

Safeway Outer Housing: Nylon

Face Screws: Stainless Steel

Face Insert: Nylon

Wire Saddle Clamp: Brass

Cord Clamp Screws: Steel, Zinc-plated

Plug/Connector Range: .425 to 1.150"

Environmental

Operating Temperature: Maximum continuous 75° C, minimum -40° C (no impact)

Temperature Rise: Maximum 30° C temperature rise at full rated current after 50 cycles of overload at 150% of rated current at a power factor of 75%.



Super-Safeway Industrial Rubber Plug and Connector

Description	Plug		Connector	
	Woodhead No.	Order No.	Woodhead No.	Order No.
Yellow rubber	2848	130142-0034	2948	130141-0068



Safeway Industrial Nylon Plug and Connector

Description	Plug		Connector	
	Woodhead No.	Order No.	Woodhead No.	Order No.
Black and white	28T48	130145-0050	29T48	130145-0072

Find adapters and technical support at the end of this section

Industrial Duty Wiring Devices Locking Blade 30A 250V 2-Pole/3-Wire NEMA L6-30

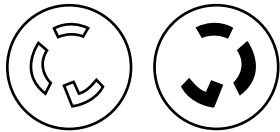

Features and Benefits

- NEōTEX® Paracril OZO rubber body yields the best performance for abrasion, chemical exposure and temperature extremes within the Super-Safeway™ offering
- Rugged nylon bodies within the Safeway® offering provide exceptional durability and performance
- Color-coded ¼" terminal screws pre-set in open position, ready to wire
- Wire screw terminals are tri-drive to be used with straight blade, Phillips and square-drive screw drivers
- Floating blade construction provides self-alignment, and a better mechanical and electrical connection minimizing wear and heat generation
- Transparent wiring guide to verify all wire strands are in place before securing wire
- Captive, tri-drive head, Stainless Steel, speed screw provides easy assembly and long life
- Two-piece cord-clamp strain relief includes tri-drive screws to firmly secure the cord

Reference Information

UL File No.: E38085
Y Non-Inline GFCI Cordset—E38085
CSA File No.: LR6837
Y Non-Inline GFCI Cordset—LL52750



Physical

Plug blades and connector contacts: Nickel-plated Brass
Super-Safeway Outer Housing: NEōTEX Paracril OZO rubber
Safeway Outer Housing: Nylon
Face Screws: Stainless Steel
Face Insert: Nylon
Wire Saddle Clamp: Brass
Cord Clamp Screws: Steel, Zinc-plated

Environmental

Operating Temperature: Maximum continuous 75° C, minimum -40° C (no impact)
Temperature Rise: Maximum 30° C temperature rise at full rated current after 50 cycles of overload at 150% of rated current at a power factor of 75%.

D

Wiring Devices



Super-Safeway Industrial Rubber Cordset

Description	Cord Length	Woodhead No.	Order No.
Yellow 12 gauge 500W cord	7.62m (25.0')	2848A123	130143-0255
Yellow, 10 Gauge 500W Cord	7.62m (25.0')	2848A103	130143-0254
	15.2m (50.0')	2848B103	130143-0312



Super-Safeway Industrial Rubber Molded Y Cordset

Description	Cord Length	Y-Cordset	
		Woodhead No.	Order No.
Yellow 12 gauge 500W cord	0.91m (3.0')	2848-Y	130154-0073

Find adapters and technical support at the end of this section

Industrial Duty Wiring Devices Locking Blade 30A 277V 2-Pole/3-Wire NEMA L7-30

Wiring Devices

D

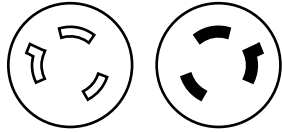

Features and Benefits

- NEöTEX® Paracril OZO rubber body yields the best performance for abrasion, chemical exposure and temperature extremes within the Super-Safeway™ offering
- Color-coded ¼" terminal screws pre-set in open position, ready to wire
- Wire screw terminals are tri-drive to be used with straight blade, Phillips and square-drive screw drivers
- Floating blade construction provides self-alignment, and a better mechanical and electrical connection minimizing wear and heat generation
- Transparent wiring guide to verify all wire strands are in place before securing wire
- Captive, tri-drive head, Stainless Steel, speed screw provides easy assembly and long life
- Two-piece cord-clamp strain relief includes tri-drive screws to firmly secure the cord

Reference Information

UL File No.: E10176
CSA File No.: LR6837



Physical

Plug blades and connector contacts: Nickel-plated Brass
Super-Safeway Outer Housing: NEöTEX Paracril OZO rubber
Safeway Outer Housing: Nylon
Face Screws: Stainless Steel
Face Insert: Nylon
Wire Saddle Clamp: Brass
Cord Clamp Screws: Steel, Zinc-plated
Plug/Connector Range: .425 to 1.150"

Environmental

Operating Temperature: Maximum continuous 75° C, minimum -40° C (no impact)
Temperature Rise: Maximum 30° C temperature rise at full rated current after 50 cycles of overload at 150% of rated current at a power factor of 75%.

Super-Safeway Industrial Rubber Plug and Connector

Description	Plug		Connector	
	Woodhead No.	Order No.	Woodhead No.	Order No.
Yellow rubber	2849	130142-0035	2949	130141-0069

Find adapters and technical support at the end of this section

Industrial Duty Wiring Devices Locking Blade 15A 125V 10A 250V 3-Pole/3-Wire Non-NEMA Locking

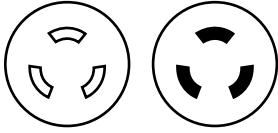

Features and Benefits

- NEoTEX® Paracril OZO rubber body yields the best performance for abrasion, chemical exposure and temperature extremes within the Super-Safeway™ offering
- Rugged nylon bodies within the Safeway® offering provide exceptional durability and performance
- Color-coded ¼" terminal screws pre-set in open position, ready to wire
- Wire screw terminals are tri-drive to be used with straight blade, Phillips and square-drive screw drivers
- Floating blade construction provides self-alignment, and a better mechanical and electrical connection minimizing wear and heat generation
- Transparent wiring guide to verify all wire strands are in place before securing wire
- Captive, tri-drive head, Stainless Steel, speed screw provides easy assembly and long life
- Two-piece cord-clamp strain relief includes tri-drive screws to firmly secure the cord

Physical

Plug blades and connector contacts: Nickel-plated Brass
Super-Safeway Outer Housing: NEoTEX Paracril OZO rubber
Safeway Outer Housing: Nylon
Face Screws: Stainless Steel
Face Insert: Nylon
Wire Saddle Clamp: Brass
Cord Clamp Screws: Steel, Zinc-plated
Plug/Connector Range: .325 to .840"

Environmental

Operating Temperature: Maximum continuous 75° C, minimum -40° C (no impact)
Temperature Rise: Maximum 30° C temperature rise at full rated current after 50 cycles of overload at 150% of rated current at a power factor of 75%.

Super-Safeway Industrial Rubber Plug and Connector

Description	Plug		Connector	
	Woodhead No.	Order No.	Woodhead No.	Order No.
Yellow rubber	2407	130141-0044	2507	130141-0053



Safeway Industrial Nylon Plug and Connector

Description	Plug		Connector	
	Woodhead No.	Order No.	Woodhead No.	Order No.
Black and white	4730	130144-0027	4739	130144-0029



Safeway Receptacle and Inlet

Description	Single Receptacle		Single Male Inlet	
	Woodhead No.	Order No.	Woodhead No.	Order No.
White, flanged	2507MB	130149-0019	2407MB	130149-0014



Super-Safeway Industrial Rubber Cordset

Description	Cord Length	Woodhead No.	Order No.
Yellow 16 gauge 500W cord	15.24m (50.0')	2407B163	130143-0171
Yellow 14 gauge 500W cord	7.62m (25.0')	2407A143	130143-0169

Find adapters and technical support at the end of this section

Industrial Duty Wiring Devices Locking Blade 20A 125/250V 3-Pole/3-Wire Non-NEMA Locking

Wiring Devices

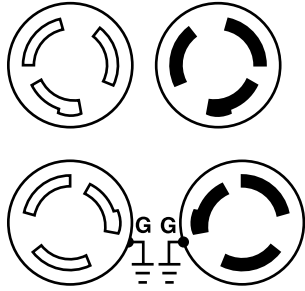

Features and Benefits

- NEoTEX® Paracril OZO rubber body yields the best performance for abrasion, chemical exposure and temperature extremes within the Super-Safeway™ offering
- Rugged nylon bodies within the Safeway® offering provide exceptional durability and performance
- Color-coded ¼" terminal screws pre-set in open position, ready to wire
- Wire screw terminals are tri-drive to be used with straight blade, Phillips and square-drive screw drivers
- Floating blade construction provides self-alignment, and a better mechanical and electrical connection minimizing wear and heat generation
- Transparent wiring guide to verify all wire strands are in place before securing wire
- Captive, tri-drive head, Stainless Steel, speed screw provides easy assembly and long life
- Two-piece cord-clamp strain relief includes tri-drive screws to firmly secure the cord

Reference Information

UL File No.: E10176
CSA File No.: LR6837



Physical

Plug blades and connector contacts: Nickel-plated Brass
Super-Safeway Outer Housing: NEoTEX Paracril OZO rubber

Safeway Outer Housing: Nylon

Face Screws: Stainless Steel

Face Insert: Nylon

Wire Saddle Clamp: Brass

Cord Clamp Screws: Steel, Zinc-plated

Plug/Connector Range: .425 to 1.150"

Environmental

Operating Temperature: Maximum continuous 75° C, minimum -40° C (no impact)

Temperature Rise: Maximum 30° C temperature rise at full rated current after 50 cycles of overload at 150% of rated current at a power factor of 75%.



Super-Safeway Industrial Rubber Plug and Connector

Description	Plug, No Ground		Connector, No Ground		Plug with Ground		Connector, with Ground	
	Woodhead No.	Order No.	Woodhead No.	Order No.	Woodhead No.	Order No.	Woodhead No.	Order No.
Yellow rubber	2608	130142-0002	2708	130142-0017				
Yellow rubber with grounding tab					2608G	130142-0004	2708G	130142-0018



Safeway Industrial Nylon Plug and Connector, No Ground

Description	Plug		Connector	
	Woodhead No.	Order No.	Woodhead No.	Order No.
Black and white	26T08	130145-0002	27T08	130145-0025



Safeway Receptacle and Inlet, No Ground

Description	Single Receptacle		Single Male Inlet	
	Woodhead No.	Order No.	Woodhead No.	Order No.
White, flanged	2708MB	130149-0036	2608MB	130149-0024

Find adapters and technical support at the end of this section

**Industrial Duty
Wiring Devices
Locking Blade
20A 125/250V
3-Pole/3-Wire
Non-NEMA Locking**

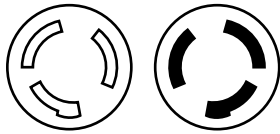

Features and Benefits

- NEōTEX® Paracril OZO rubber body yields the best performance for abrasion, chemical exposure and temperature extremes within the Super-Safeway™ offering
- Rugged nylon bodies within the Safeway® offering provide exceptional durability and performance
- Color-coded ¼" terminal screws pre-set in open position, ready to wire
- Wire screw terminals are tri-drive to be used with straight blade, Phillips and square-drive screw drivers
- Floating blade construction provides self-alignment, and a better mechanical and electrical connection minimizing wear and heat generation
- Transparent wiring guide to verify all wire strands are in place before securing wire
- Captive, tri-drive head, Stainless Steel, speed screw provides easy assembly and long life
- Two-piece cord-clamp strain relief includes tri-drive screws to firmly secure the cord

Reference Information

UL File No.: E38085
Y Non-Inline GFCI Cordset—E38085
CSA File No.: LR6837
Y Non-Inline GFCI Cordset—LL52750



Physical

Plug blades and connector contacts: Nickel-plated Brass
Super-Safeway Outer Housing: NEōTEX Paracril OZO rubber
Safeway Outer Housing: Nylon
Face Screws: Stainless Steel
Face Insert: Nylon
Wire Saddle Clamp: Brass
Cord Clamp Screws: Steel, Zinc-plated

Environmental

Operating Temperature: Maximum continuous 75° C, minimum -40° C (no impact)
Temperature Rise: Maximum 30° C temperature rise at full rated current after 50 cycles of overload at 150% of rated current at a power factor of 75%.



Super-Safeway Industrial Rubber Cordset

Description	Cord Length	Woodhead No.	Order No.
Yellow 14 gauge SOOW cord	15.2m (50.0')	2608B143	130143-0201



Super-Safeway Industrial Rubber Molded Y and W Cordsets

Description	Cord Length	Y-Cordset	
		Woodhead No.	Order No.
Yellow 12 gauge SOOW cord	0.91m (3.0')	2608-Y	130154-0106

Find adapters and technical support at the end of this section

Industrial Duty Wiring Devices Locking Blade 30A 250V 3-Pole/3-Wire Non-NEMA Locking

D
Wiring Devices

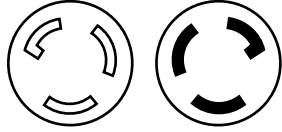

Features and Benefits

- NEöTEX® Paracril OZO rubber body yields the best performance for abrasion, chemical exposure and temperature extremes within the Super-Safeway™ offering
- Color-coded ¼" terminal screws pre-set in open position, ready to wire
- Wire screw terminals are tri-drive to be used with straight blade, Phillips and square-drive screw drivers
- Floating blade construction provides self-alignment, and a better mechanical and electrical connection minimizing wear and heat generation
- Transparent wiring guide to verify all wire strands are in place before securing wire
- Captive, tri-drive head, Stainless Steel, speed screw provides easy assembly and long life
- Two-piece cord-clamp strain relief includes tri-drive screws to firmly secure the cord

Reference Information

UL File No.: E10176
CSA File No.: LR6837



Physical

Plug blades and connector contacts: Nickel-plated Brass
Super-Safeway Outer Housing: NEöTEX Paracril OZO rubber
Safeway Outer Housing: Nylon
Face Screws: Stainless Steel
Face Insert: Nylon
Wire Saddle Clamp: Brass
Cord Clamp Screws: Steel, Zinc-plated
Plug/Connector Range: .325 to .840"

Environmental

Operating Temperature: Maximum continuous 75° C, minimum -40° C (no impact)
Temperature Rise: Maximum 30° C temperature rise at full rated current after 50 cycles of overload at 150% of rated current at a power factor of 75%.



Super-Safeway Industrial Rubber Plug and Connector

Description	Plug		Connector	
	Woodhead No.	Order No.	Woodhead No.	Order No.
Yellow rubber	2808	130142-0031	2908	130145-0066

Find adapters and technical support at the end of this section

Industrial Duty Wiring Devices Locking Blade 20A 125/250V 3-Pole/4-Wire NEMA L14-20

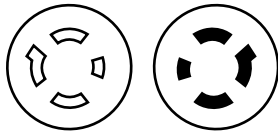

Features and Benefits

- NEōTEX® Paracril OZO rubber body yields the best performance for abrasion, chemical exposure and temperature extremes within the Super-Safeway™ offering
- Rugged nylon bodies within the Safeway® offering provide exceptional durability and performance
- Color-coded ¼" terminal screws pre-set in open position, ready to wire
- Wire screw terminals are tri-drive to be used with straight blade, Phillips and square-drive screw drivers
- Floating blade construction provides self-alignment, and a better mechanical and electrical connection minimizing wear and heat generation
- Transparent wiring guide to verify all wire strands are in place before securing wire
- Captive, tri-drive head, Stainless Steel, speed screw provides easy assembly and long life
- Two-piece cord-clamp strain relief includes tri-drive screws to firmly secure the cord

Reference Information

UL File No.: Plug and Connector—E10176

Receptacle—E46237

CSA File No.: LR6837



Physical

Plug blades and connector contacts: Nickel-plated Brass
Super-Safeway Outer Housing: NEōTEX Paracril OZO rubber

Safeway Outer Housing: Nylon

Face Screws: Stainless Steel

Face Insert: Nylon

Wire Saddle Clamp: Brass

Cord Clamp Screws: Steel, Zinc-plated

Plug/Connector Range: .325 to .840"

Environmental

Operating Temperature: Maximum continuous 75° C, minimum -40° C (no impact)

Temperature Rise: Maximum 30° C temperature rise at full rated current after 50 cycles of overload at 150% of rated current at a power factor of 75%.



Super-Safeway Industrial Rubber Plug and Connector

Description	Plug		Connector	
	Woodhead No.	Order No.	Woodhead No.	Order No.
Yellow rubber	2674	130142-0009	2774	130142-0024



Safeway Industrial Nylon Plug and Connector

Description	Plug		Connector	
	Woodhead No.	Order No.	Woodhead No.	Order No.
Black and white	2674	130145-0015	2774	130145-0035



Safeway Receptacle and Inlet

Description	Single Receptacle		Single Male Inlet	
	Woodhead No.	Order No.	Woodhead No.	Order No.
White, flanged	2774MB	130149-0042	2674MB	130149-0029
Black	4774	130149-0071		

Find adapters and technical support at the end of this section

Industrial Duty Wiring Devices Locking Blade 20A 125/250V 3-Pole/4-Wire NEMA L14-20

Wiring Devices

D

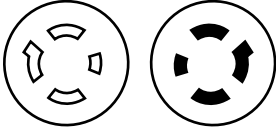

Super-Safeway Industrial Rubber Cordset

Description	Cord Length	Woodhead No.	Order No.
Yellow 16 gauge SOOW cord	15.2m (50.0')	26748124	130143-0214

Find adapters and technical support at the end of this section

Features and Benefits

- NEoTEX® Paracril OZO rubber body yields the best performance for abrasion, chemical exposure and temperature extremes within the Super-Safeway™ offering
- Rugged nylon bodies within the Safeway® offering provide exceptional durability and performance
- Color-coded ¼" terminal screws pre-set in open position, ready to wire
- Wire screw terminals are tri-drive to be used with straight blade, Phillips and square-drive screw drivers
- Floating blade construction provides self-alignment, and a better mechanical and electrical connection minimizing wear and heat generation
- Transparent wiring guide to verify all wire strands are in place before securing wire
- Captive, tri-drive head, Stainless Steel, speed screw provides easy assembly and long life
- Two-piece cord-clamp strain relief includes tri-drive screws to firmly secure the cord

Reference Information

UL File No.: E38085
CSA File No.: LR6837



Physical

Plug blades and connector contacts: Nickel-plated Brass
Super-Safeway Outer Housing: NEoTEX Paracril OZO rubber

Safeway Outer Housing: Nylon

Face Screws: Stainless Steel

Face Insert: Nylon

Wire Saddle Clamp: Brass

Cord Clamp Screws: Steel, Zinc-plated

Environmental

Operating Temperature: Maximum continuous 75° C, minimum -40° C (no impact)

Temperature Rise: Maximum 30° C temperature rise at full rated current after 50 cycles of overload at 150% of rated current at a power factor of 75%.

Industrial Duty Wiring Devices Locking Blade 20A 250V 3Ø 3-Pole/4-Wire NEMA L15-20

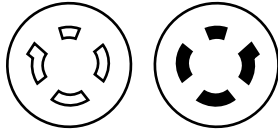

Features and Benefits

- NEōTEX® Paracril OZO rubber body yields the best performance for abrasion, chemical exposure and temperature extremes within the Super-Safeway™ offering
- Rugged nylon bodies within the Safeway® offering provide exceptional durability and performance
- Color-coded ¼" terminal screws pre-set in open position, ready to wire
- Wire screw terminals are tri-drive to be used with straight blade, Phillips and square-drive screw drivers
- Floating blade construction provides self-alignment, and a better mechanical and electrical connection minimizing wear and heat generation
- Transparent wiring guide to verify all wire strands are in place before securing wire
- Captive, tri-drive head, Stainless Steel, speed screw provides easy assembly and long life
- Two-piece cord-clamp strain relief includes tri-drive screws to firmly secure the cord

Reference Information

UL File No.: Plug and Connector—E10176

Receptacle—E46237

CSA File No.: LR6837



Physical

Plug blades and connector contacts: Nickel-plated Brass
Super-Safeway Outer Housing: NEōTEX Paracril OZO rubber

Safeway Outer Housing: Nylon

Face Screws: Stainless Steel

Face Insert: Nylon

Wire Saddle Clamp: Brass

Cord Clamp Screws: Steel, Zinc-plated

Plug/Connector Range: .325 to .840"

Environmental

Operating Temperature: Maximum continuous 75° C, minimum -40° C (no impact)

Temperature Rise: Maximum 30° C temperature rise at full rated current after 50 cycles of overload at 150% of rated current at a power factor of 75%.



Super-Safeway Industrial Rubber Plug and Connector

Description	Plug		Connector	
	Woodhead No.	Order No.	Woodhead No.	Order No.
Yellow rubber	2675	130142-0010	2775	130142-0025



Safeway Industrial Nylon Plug and Connector

Description	Plug		Connector	
	Woodhead No.	Order No.	Woodhead No.	Order No.
Black and white	26175	130145-0017	27175	130145-0037



Safeway Receptacle and Inlet

Description	Single Receptacle	
	Woodhead No.	Order No.
Black	4775	130149-0072

Find adapters and technical support at the end of this section

Industrial Duty Wiring Devices Locking Blade 20A 480V 3Ø 3-Pole/4-Wire NEMA L16-20

Wiring Devices

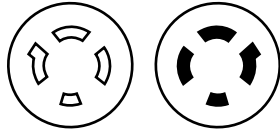

Features and Benefits

- NEoTEX® Paracril OZO rubber body yields the best performance for abrasion, chemical exposure and temperature extremes within the Super-Safeway™ offering
- Rugged nylon bodies within the Safeway® offering provide exceptional durability and performance
- Color-coded ¼" terminal screws pre-set in open position, ready to wire
- Wire screw terminals are tri-drive to be used with straight blade, Phillips and square-drive screw drivers
- Floating blade construction provides self-alignment, and a better mechanical and electrical connection minimizing wear and heat generation
- Transparent wiring guide to verify all wire strands are in place before securing wire
- Captive, tri-drive head, Stainless Steel, speed screw provides easy assembly and long life
- Two-piece cord-clamp strain relief includes tri-drive screws to firmly secure the cord

Reference Information

UL File No.: Plug and Connector—E10176

Receptacle—E46237

CSA File No.: LR6837



Physical

Plug blades and connector contacts: Nickel-plated Brass
Super-Safeway Outer Housing: NEoTEX Paracril OZO rubber

Safeway Outer Housing: Nylon

Face Screws: Stainless Steel

Face Insert: Nylon

Wire Saddle Clamp: Brass

Cord Clamp Screws: Steel, Zinc-plated

Plug/Connector Range: .425 to 1.150"

Environmental

Operating Temperature: Maximum continuous 75° C,
minimum -40° C (no impact)

Temperature Rise: Maximum 30° C temperature rise at full rated current after 50 cycles of overload at 150% of rated current at a power factor of 75%.



Super-Safeway Industrial Rubber Plug and Connector

Description	Plug		Connector	
	Woodhead No.	Order No.	Woodhead No.	Order No.
Yellow rubber	2676	130142-0012	2776	130142-0026



Safeway Industrial Nylon Plug and Connector

Description	Plug		Connector	
	Woodhead No.	Order No.	Woodhead No.	Order No.
Black and white	2676	130145-0019	2776	130145-0039



Safeway Receptacle and Inlet

Description	Single Receptacle	
	Woodhead No.	Order No.
Black	4776	130149-0074

Find adapters and technical support at the end of this section

Industrial Duty Wiring Devices Locking Blade 30A 125/250V 3-Pole/4-Wire NEMA L14-30

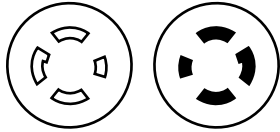

Features and Benefits

- NEōTEX® Paracril OZO rubber body yields the best performance for abrasion, chemical exposure and temperature extremes within the Super-Safeway™ offering
- Rugged nylon bodies within the Safeway® offering provide exceptional durability and performance
- Color-coded ¼" terminal screws pre-set in open position, ready to wire
- Wire screw terminals are tri-drive to be used with straight blade, Phillips and square-drive screw drivers
- Floating blade construction provides self-alignment, and a better mechanical and electrical connection minimizing wear and heat generation
- Transparent wiring guide to verify all wire strands are in place before securing wire
- Captive, tri-drive head, Stainless Steel, speed screw provides easy assembly and long life
- Two-piece cord-clamp strain relief includes tri-drive screws to firmly secure the cord

Reference Information

UL File No.: E10176
CSA File No.: LR6837



Physical

Plug blades and connector contacts: Nickel-plated Brass
Super-Safeway Outer Housing: NEōTEX Paracril OZO rubber

Safeway Outer Housing: Nylon

Face Screws: Stainless Steel

Face Insert: Nylon

Wire Saddle Clamp: Brass

Cord Clamp Screws: Steel, Zinc-plated

Plug/Connector Range: .425 to 1.150"

Environmental

Operating Temperature: Maximum continuous 75° C, minimum -40° C (no impact)

Temperature Rise: Maximum 30° C temperature rise at full rated current after 50 cycles of overload at 150% of rated current at a power factor of 75%.



Super-Safeway Industrial Rubber Plug and Connector

Description	Plug		Connector	
	Woodhead No.	Order No.	Woodhead No.	Order No.
Yellow rubber	2874	130142-0036	2974	130142-0043



Safeway Industrial Nylon Plug and Connector

Description	Plug		Connector	
	Woodhead No.	Order No.	Woodhead No.	Order No.
Black and white	2874	130145-0052	2974	130145-0076



Safeway Receptacle and Inlet

Description	Single Receptacle		Single Male Inlet	
	Woodhead No.	Order No.	Woodhead No.	Order No.
White, flanged	2974MB	130149-0059	2874MB	130149-0051

Find adapters and technical support at the end of this section

Industrial Duty Wiring Devices Locking Blade 30A 250V 3Ø 3-Pole/4-Wire NEMA L15-30

Wiring Devices

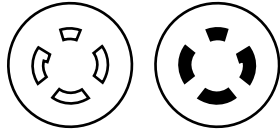

Features and Benefits

- NEoTEX® Paracril OZO rubber body yields the best performance for abrasion, chemical exposure and temperature extremes within the Super-Safeway™ offering
- Rugged nylon bodies within the Safeway® offering provide exceptional durability and performance
- Color-coded ¼" terminal screws pre-set in open position, ready to wire
- Wire screw terminals are tri-drive to be used with straight blade, Phillips and square-drive screw drivers
- Floating blade construction provides self-alignment, and a better mechanical and electrical connection minimizing wear and heat generation
- Transparent wiring guide to verify all wire strands are in place before securing wire
- Captive, tri-drive head, Stainless Steel, speed screw provides easy assembly and long life
- Two-piece cord-clamp strain relief includes tri-drive screws to firmly secure the cord

Reference Information

UL File No.: E10176
CSA File No.: LR6837



Physical

Plug blades and connector contacts: Nickel-plated Brass
Super-Safeway Outer Housing: NEoTEX Paracril OZO rubber

Safeway Outer Housing: Nylon

Face Screws: Stainless Steel

Face Insert: Nylon

Wire Saddle Clamp: Brass

Cord Clamp Screws: Steel, Zinc-plated

Plug/Connector Range: .425 to 1.150"

Environmental

Operating Temperature: Maximum continuous 75° C, minimum -40° C (no impact)

Temperature Rise: Maximum 30° C temperature rise at full rated current after 50 cycles of overload at 150% of rated current at a power factor of 75%.



Super-Safeway Industrial Rubber Plug and Connector

Description	Plug		Connector	
	Woodhead No.	Order No.	Woodhead No.	Order No.
Yellow rubber	2875	130142-0037	2975	130142-0044



Safeway Industrial Nylon Plug and Connector

DescriptionD-104	Plug		Connector	
	Woodhead No.	Order No.	Woodhead No.	Order No.
Black and white	28175	130145-0054	29175	130145-0078



Safeway Receptacle and Inlet

Description	Single Receptacle		Single Male Inlet	
	Woodhead No.	Order No.	Woodhead No.	Order No.
White, flanged	2975MB	130149-0060	2875MB	130149-0052

Find adapters and technical support at the end of this section

Industrial Duty Wiring Devices Locking Blade 30A 480V 3ø 3-Pole/4-Wire NEMA L16-30

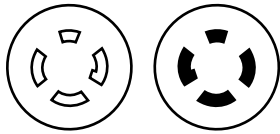

Features and Benefits

- NEōTEX® Paracril OZO rubber body yields the best performance for abrasion, chemical exposure and temperature extremes within the Super-Safeway™ offering
- Rugged nylon bodies within the Safeway® offering provide exceptional durability and performance
- Color-coded ¼" terminal screws pre-set in open position, ready to wire
- Wire screw terminals are tri-drive to be used with straight blade, Phillips and square-drive screw drivers
- Floating blade construction provides self-alignment, and a better mechanical and electrical connection minimizing wear and heat generation
- Transparent wiring guide to verify all wire strands are in place before securing wire
- Captive, tri-drive head, Stainless Steel, speed screw provides easy assembly and long life
- Two-piece cord-clamp strain relief includes tri-drive screws to firmly secure the cord

Reference Information

UL File No.: Plug and Connector—E10176

Receptacle—E46237

CSA File No.: LR6837



Physical

Plug blades and connector contacts: Nickel-plated Brass
Super-Safeway Outer Housing: NEōTEX Paracril OZO rubber

Safeway Outer Housing: Nylon

Face Screws: Stainless Steel

Face Insert: Nylon

Wire Saddle Clamp: Brass

Cord Clamp Screws: Steel, Zinc-plated

Plug/Connector Range: .425 to 1.150"

Environmental

Operating Temperature: Maximum continuous 75° C, minimum -40° C (no impact)

Temperature Rise: Maximum 30° C temperature rise at full rated current after 50 cycles of overload at 150% of rated current at a power factor of 75%.



Super-Safeway Industrial Rubber Plug and Connector

Description	Plug		Connector	
	Woodhead No.	Order No.	Woodhead No.	Order No.
Yellow rubber	2876	130142-0038	2976	130142-0045



Safeway Industrial Nylon Plug and Connector

Description	Plug		Connector	
	Woodhead No.	Order No.	Woodhead No.	Order No.
Yellow	2876	130145-0056	2976	130145-0080



Safeway Receptacle and Inlet

Description	Single Receptacle		Single Male Inlet	
	Woodhead No.	Order No.	Woodhead No.	Order No.
White, flanged	2976MB	130149-0061	2876MB	130149-0053
Black	4976	130149-0085		
Corrosion resistant	4976CR	130149-0086		

Find adapters and technical support at the end of this section

Industrial Duty Wiring Devices Locking Blade 30A 480V 3Ø 3-Pole/4-Wire NEMA L16-30

Wiring Devices

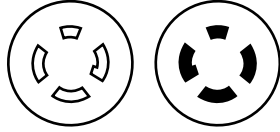

Features and Benefits

- NEoTEX® Paracril OZO rubber body yields the best performance for abrasion, chemical exposure and temperature extremes within the Super-Safeway™ offering
- Rugged nylon bodies within the Safeway® offering provide exceptional durability and performance
- Color-coded ¼" terminal screws pre-set in open position, ready to wire
- Wire screw terminals are tri-drive to be used with straight blade, Phillips and square-drive screw drivers
- Floating blade construction provides self-alignment, and a better mechanical and electrical connection minimizing wear and heat generation
- Transparent wiring guide to verify all wire strands are in place before securing wire
- Captive, tri-drive head, Stainless Steel, speed screw provides easy assembly and long life
- Two-piece cord-clamp strain relief includes tri-drive screws to firmly secure the cord

Reference Information

UL File No.: E38085
CSA File No.: LR6837



Physical

Plug blades and connector contacts: Nickel-plated Brass
Super-Safeway Outer Housing: NEoTEX Paracril OZO rubber

Safeway Outer Housing: Nylon

Face Screws: Stainless Steel

Face Insert: Nylon

Wire Saddle Clamp: Brass

Cord Clamp Screws: Steel, Zinc-plated

Environmental

Operating Temperature: Maximum continuous 75° C, minimum -40° C (no impact)

Temperature Rise: Maximum 30° C temperature rise at full rated current after 50 cycles of overload at 150% of rated current at a power factor of 75%.



Super-Safeway Industrial Rubber Cordset

Description	Cord Length	Woodhead No.	Order No.
Yellow 10 gauge 500W cord	15.2m (50.0')	2876B104	130143-0257

Find adapters and technical support at the end of this section

**Industrial Duty
Wiring Devices
Locking Blade
30A 600V 3Ø
3-Pole/4-Wire
NEMA L17-30**

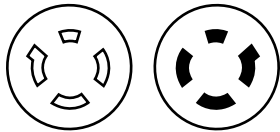

Features and Benefits

- NEōTEX® Paracril OZO rubber body yields the best performance for abrasion, chemical exposure and temperature extremes within the Super-Safeway™ offering
- Rugged nylon bodies within the Safeway® offering provide exceptional durability and performance
- Color-coded ¼" terminal screws pre-set in open position, ready to wire
- Wire screw terminals are tri-drive to be used with straight blade, Phillips and square-drive screw drivers
- Floating blade construction provides self-alignment, and a better mechanical and electrical connection minimizing wear and heat generation
- Transparent wiring guide to verify all wire strands are in place before securing wire
- Captive, tri-drive head, Stainless Steel, speed screw provides easy assembly and long life
- Two-piece cord-clamp strain relief includes tri-drive screws to firmly secure the cord

Reference Information

UL File No.: E10176
CSA File No.: LR6837



Physical

Plug blades and connector contacts: Nickel-plated Brass
Super-Safeway Outer Housing: NEōTEX Paracril OZO rubber

Safeway Outer Housing: Nylon

Face Screws: Stainless Steel

Face Insert: Nylon

Wire Saddle Clamp: Brass

Cord Clamp Screws: Steel, Zinc-plated

Plug/Connector Range: .425 to 1.150"

Environmental

Operating Temperature: Maximum continuous 75° C, minimum -40° C (no impact)

Temperature Rise: Maximum 30° C temperature rise at full rated current after 50 cycles of overload at 150% of rated current at a power factor of 75%.



Super-Safeway Industrial Rubber Plug and Connector

Description	Plug		Connector	
	Woodhead No.	Order No.	Woodhead No.	Order No.
Yellow rubber	2877	130142-0039	2977	130142-0046



Safeway Industrial Nylon Plug and Connector

Description	Plug		Connector	
	Woodhead No.	Order No.	Woodhead No.	Order No.
Black and white	28177	130145-0058	29177	130145-0082

Find adapters and technical support at the end of this section

Industrial Duty Wiring Devices Locking Blade 50A 125/250V 3-Pole/4-Wire Non-NEMA Locking CA

Wiring Devices

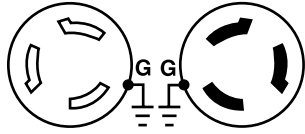

Features and Benefits

- Rugged nylon bodies within the Safeway® offering provide exceptional durability and performance
- Color-coded ¼" terminal screws pre-set in open position, ready to wire
- Wire screw terminals are tri-drive to be used with straight blade, Phillips and square-drive screw drivers
- Floating blade construction provides self-alignment, and a better mechanical and electrical connection minimizing wear and heat generation
- Transparent wiring guide to verify all wire strands are in place before securing wire
- Captive, tri-drive head, Stainless Steel, speed screw provides easy assembly and long life
- Two-piece cord-clamp strain relief includes tri-drive screws to firmly secure the cord

Physical

Plug blades and connector contacts: Nickel-plated Brass
Safeway Outer Housing: Nylon
Face Screws: Stainless Steel
Face Insert: Nylon
Wire Saddle Clamp: Brass
Cord Clamp Screws: Steel, Zinc-plated

Environmental

Operating Temperature: Maximum continuous 75° C, minimum -40° C (no impact)
Temperature Rise: Maximum 30° C temperature rise at full rated current after 50 cycles of overload at 150% of rated current at a power factor of 75%.



Safeway Industrial Nylon Plug and Connector

Description	Plug		Connector	
	Woodhead No.	Order No.	Woodhead No.	Order No.
Yellow	CS6365N	130155-0134	CS6364N	130155-0133



Safeway Receptacle and Inlet

Description	Single Receptacle		Single Male Inlet	
	Woodhead No.	Order No.	Woodhead No.	Order No.
White, flanged			CS6375	130155-0137
Black	CS6369	130155-0135		

Find adapters and technical support at the end of this section

Industrial Duty Wiring Devices Locking Blade 50A 250V 3Ø 3-Pole/4-Wire Non-NEMA Locking CA

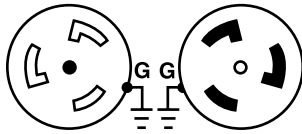

Features and Benefits

- Rugged nylon bodies within the Safeway® offering provide exceptional durability and performance
- Color-coded ¼" terminal screws pre-set in open position, ready to wire
- Wire screw terminals are tri-drive to be used with straight blade, Phillips and square-drive screw drivers
- Floating blade construction provides self-alignment, and a better mechanical and electrical connection minimizing wear and heat generation
- Transparent wiring guide to verify all wire strands are in place before securing wire
- Captive, tri-drive head, Stainless Steel, speed screw provides easy assembly and long life
- Two-piece cord-clamp strain relief includes tri-drive screws to firmly secure the cord

Physical

Plug blades and connector contacts: Nickel-plated Brass
Super-Safeway Outer Housing: NEōTEX® Paracril OZO rubber
Safeway Outer Housing: Nylon
Face Screws: Stainless Steel
Face Insert: Nylon
Wire Saddle Clamp: Brass
Cord Clamp Screws: Steel, Zinc-plated

Environmental

Operating Temperature: Maximum continuous 75° C, minimum -40° C (no impact)
Temperature Rise: Maximum 30° C temperature rise at full rated current after 50 cycles of overload at 150% of rated current at a power factor of 75%.

D

Wiring Devices



Safeway Industrial Nylon Plug and Connector

Description	Plug		Connector	
	Woodhead No.	Order No.	Woodhead No.	Order No.
Yellow	CS8365N	130155-0157	CS8364N	130155-0156



Safeway Receptacle and Inlet

Description	Single Receptacle		Single Male Inlet	
	Woodhead No.	Order No.	Woodhead No.	Order No.
White, flanged			CS8375	130155-0159
Black	CS8369	130155-0158		

Find adapters and technical support at the end of this section

Industrial Duty Wiring Devices Locking Blade 50A 480V 3Ø 3-Pole/4-Wire Non-NEMA Locking CA

Wiring Devices

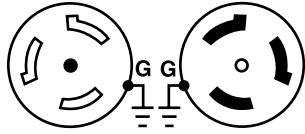

Features and Benefits

- Rugged nylon bodies within the Safeway® offering provide exceptional durability and performance
- Color-coded ¼" terminal screws pre-set in open position, ready to wire
- Wire screw terminals are tri-drive to be used with straight blade, Phillips and square-drive screw drivers
- Floating blade construction provides self-alignment, and a better mechanical and electrical connection minimizing wear and heat generation
- Transparent wiring guide to verify all wire strands are in place before securing wire
- Captive, tri-drive head, Stainless Steel, speed screw provides easy assembly and long life
- Two-piece cord-clamp strain relief includes tri-drive screws to firmly secure the cord

Physical

Plug blades and connector contacts: Nickel-plated Brass
Safeway Outer Housing: Nylon
Face Screws: Stainless Steel
Face Insert: Nylon
Wire Saddle Clamp: Brass
Cord Clamp Screws: Steel, Zinc-plated

Environmental

Operating Temperature: Maximum continuous 75° C, minimum -40° C (no impact)
Temperature Rise: Maximum 30° C temperature rise at full rated current after 50 cycles of overload at 150% of rated current at a power factor of 75%.



Safeway Industrial Nylon Plug and Connector

Description	Plug		Connector	
	Woodhead No.	Order No.	Woodhead No.	Order No.
Black and white	CS8165N	130155-0145	CS8164N	130155-0144



Safeway Receptacle and Inlet

Description	Single Receptacle		Single Male Inlet	
	Woodhead No.	Order No.	Woodhead No.	Order No.
White, flanged			CS8175	130155-0147
Black	CS8169	130155-0146		

Find adapters and technical support at the end of this section

**Industrial Duty
Wiring Devices
Locking Blade
50A 600V AC/250V DC
Grounding
3-Pole/4-Wire
Non-NEMA**

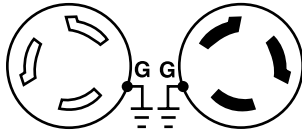

Features and Benefits

- Rugged nylon bodies within the Safeway® offering provide exceptional durability and performance
- Color-coded ¼" terminal screws pre-set in open position, ready to wire
- Wire screw terminals are tri-drive to be used with straight blade, Phillips and square-drive screw drivers
- Floating blade construction provides self-alignment, and a better mechanical and electrical connection minimizing wear and heat generation
- Transparent wiring guide to verify all wire strands are in place before securing wire
- Captive, tri-drive head, Stainless Steel, speed screw provides easy assembly and long life
- Two-piece cord-clamp strain relief includes tri-drive screws to firmly secure the cord

Physical

Plug blades and connector contacts: Nickel-plated Brass
 Super-Safeway Outer Housing: NEōTEX® Paracril OZO rubber
 Safeway Outer Housing: Nylon
 Face Screws: Stainless Steel
 Face Insert: Nylon
 Wire Saddle Clamp: Brass
 Cord Clamp Screws: Steel, Zinc-plated

Environmental

Operating Temperature: Maximum continuous 75° C, minimum -40° C (no impact)
 Temperature Rise: Maximum 30° C temperature rise at full rated current after 50 cycles of overload at 150% of rated current at a power factor of 75%.



Safeway Industrial Nylon Plug and Connector

Description	Plug		Connector	
	Woodhead No.	Order No.	Woodhead No.	Order No.
Yellow	7765N	130155-0123	7764N	130155-0122

Find adapters and technical support at the end of this section

Industrial Duty Wiring Devices Locking Blade 50A 600V AC/250V DC 3-Pole/4-Wire Non-NEMA Locking

Wiring Devices

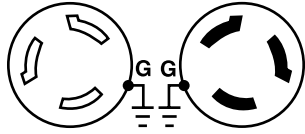

Features and Benefits

- Rugged nylon bodies within the Safeway® offering provide exceptional durability and performance
- Color-coded 1/4" terminal screws pre-set in open position, ready to wire
- Wire screw terminals are tri-drive to be used with straight blade, Phillips and square-drive screw drivers
- Floating blade construction provides self-alignment, and a better mechanical and electrical connection minimizing wear and heat generation
- Transparent wiring guide to verify all wire strands are in place before securing wire
- Captive, tri-drive head, Stainless Steel, speed screw provides easy assembly and long life
- Two-piece cord-clamp strain relief includes tri-drive screws to firmly secure the cord

Physical

Plug blades and connector contacts: Nickel-plated Brass
 Super-Safeway Outer Housing: NEōTEX® Paracril OZO rubber
 Safeway Outer Housing: Nylon
 Face Screws: Stainless Steel
 Face Insert: Nylon
 Wire Saddle Clamp: Brass
 Cord Clamp Screws: Steel, Zinc-plated

Environmental

Operating Temperature: Maximum continuous 75° C, minimum -40° C (no impact)
 Temperature Rise: Maximum 30° C temperature rise at full rated current after 50 cycles of overload at 150% of rated current at a power factor of 75%.



Safeway Industrial Nylon Plug and Connector

Description	Plug		Connector	
	Woodhead No.	Order No.	Woodhead No.	Order No.
Yellow	3765N	130155-0042	3764N	130155-0041



Safeway Receptacle and Inlet

Description	Single Receptacle		Single Male Inlet	
	Woodhead No.	Order No.	Woodhead No.	Order No.
White, Flanged			3775	130155-0044
Black	3769	130155-0043		

Find adapters and technical support at the end of this section

Industrial Duty Wiring Devices Locking Blade 20A 208V 4-Pole/4-Wire Non-NEMA

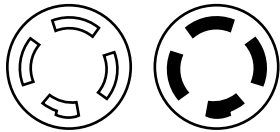

Super-Safeway Industrial Rubber Plug and Connector



Description	Plug		Connector	
	Woodhead No.	Order No.	Woodhead No.	Order No.
Yellow rubber	2609	130142-0006	2709	130142-0019

Find adapters and technical support at the end of this section

Features and Benefits

- NEōTEX® Paracril OZO rubber body yields the best performance for abrasion, chemical exposure and temperature extremes within the Super-Safeway™ offering
- Color-coded ¼" terminal screws pre-set in open position, ready to wire
- Wire screw terminals are tri-drive to be used with straight blade, Phillips and square-drive screw drivers
- Floating blade construction provides self-alignment, and a better mechanical and electrical connection minimizing wear and heat generation
- Transparent wiring guide to verify all wire strands are in place before securing wire
- Captive, tri-drive head, Stainless Steel, speed screw provides easy assembly and long life
- Two-piece cord-clamp strain relief includes tri-drive screws to firmly secure the cord

Reference Information

UL File No.: E10176
CSA File No.: LR6837  

Physical

Plug blades and connector contacts: Nickel-plated Brass
Super-Safeway Outer Housing: NEōTEX Paracril OZO rubber
Safeway Outer Housing: Nylon
Face Screws: Stainless Steel
Face Insert: Nylon
Wire Saddle Clamp: Brass
Cord Clamp Screws: Steel, Zinc-plated
Plug/Connector Range: .425 to 1.150"

Environmental

Operating Temperature: Maximum continuous 75° C, minimum -40° C (no impact)
Temperature Rise: Maximum 30° C temperature rise at full rated current after 50 cycles of overload at 150% of rated current at a power factor of 75%.

Industrial Duty Wiring Devices Locking Blade 30A 208V 4-Pole/4-Wire Non-NEMA Locking

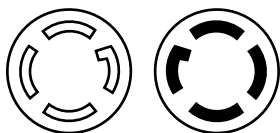

Super-Safeway Industrial Rubber Plug and Connector



Description	Plug		Connector	
	Woodhead No.	Order No.	Woodhead No.	Order No.
Yellow rubber	2809	130142-0032	2909	130145-0067

Find adapters and technical support at the end of this section

Features and Benefits

- NEōTEX® Paracril OZO rubber body yields the best performance for abrasion, chemical exposure and temperature extremes within the Super-Safeway™ offering
- Color-coded ¼" terminal screws pre-set in open position, ready to wire
- Wire screw terminals are tri-drive to be used with straight blade, Phillips and square-drive screw drivers
- Floating blade construction provides self-alignment, and a better mechanical and electrical connection minimizing wear and heat generation
- Transparent wiring guide to verify all wire strands are in place before securing wire
- Captive, tri-drive head, Stainless Steel, speed screw provides easy assembly and long life
- Two-piece cord-clamp strain relief includes tri-drive screws to firmly secure the cord

Reference Information

UL File No.: E10176
CSA File No.: LR6837  

Physical

Plug blades and connector contacts: Nickel-plated Brass
Super-Safeway Outer Housing: NEōTEX Paracril OZO rubber
Safeway Outer Housing: Nylon
Face Screws: Stainless Steel
Face Insert: Nylon
Wire Saddle Clamp: Brass
Cord Clamp Screws: Steel, Zinc-plated
Plug/Connector Range: .425 to 1.150"

Environmental

Operating Temperature: Maximum continuous 75° C, minimum -40° C (no impact)
Temperature Rise: Maximum 30° C temperature rise at full rated current after 50 cycles of overload at 150% of rated current at a power factor of 75%.

Industrial Duty Wiring Devices Locking Blade 20A 208V 3Ø 4-Pole/5-Wire NEMA L21-20

Wiring Devices

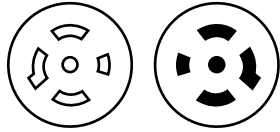

Features and Benefits

- NEöTEX® Paracril OZO rubber body yields the best performance for abrasion, chemical exposure and temperature extremes within the Super-Safeway™ offering
- Color-coded ¼" terminal screws pre-set in open position, ready to wire
- Wire screw terminals are tri-drive to be used with straight blade, Phillips and square-drive screw drivers
- Floating blade construction provides self-alignment, and a better mechanical and electrical connection minimizing wear and heat generation
- Transparent wiring guide to verify all wire strands are in place before securing wire
- Captive, tri-drive head, Stainless Steel, speed screw provides easy assembly and long life
- Two-piece cord-clamp strain relief includes tri-drive screws to firmly secure the cord

Reference Information

UL File No.: E10176
CSA File No.: LR6837



Physical

Plug blades and connector contacts: Nickel-plated Brass
Super-Safeway Outer Housing: NEöTEX Paracril OZO rubber
Safeway Outer Housing: Nylon
Face Screws: Stainless Steel
Face Insert: Nylon
Wire Saddle Clamp: Brass
Cord Clamp Screws: Steel, Zinc-plated
Plug/Connector Range: .325 to .840"

Environmental

Operating Temperature: Maximum continuous 75° C, minimum -40° C (no impact)
Temperature Rise: Maximum 30° C temperature rise at full rated current after 50 cycles of overload at 150% of rated current at a power factor of 75%.



Super-Safeway Industrial Rubber Plug and Connector

Description	Plug		Connector	
	Woodhead No.	Order No.	Woodhead No.	Order No.
Yellow rubber	2681	130142-0014	2781	130142-0028

Find adapters and technical support at the end of this section

Industrial Duty Wiring Devices Locking Blade 20A 480V 3Ø 4-Pole/5-Wire NEMA L22-20

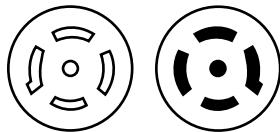

Features and Benefits

- NEöTEX® Paracril OZO rubber body yields the best performance for abrasion, chemical exposure and temperature extremes within the Super-Safeway™ offering
- Color-coded ¼" terminal screws pre-set in open position, ready to wire
- Wire screw terminals are tri-drive to be used with straight blade, Phillips and square-drive screw drivers
- Floating blade construction provides self-alignment, and a better mechanical and electrical connection minimizing wear and heat generation
- Transparent wiring guide to verify all wire strands are in place before securing wire
- Captive, tri-drive head, Stainless Steel, speed screw provides easy assembly and long life
- Two-piece cord-clamp strain relief includes tri-drive screws to firmly secure the cord

Reference Information

UL File No.: E10176
CSA File No.: LR6837



Physical

Plug blades and connector contacts: Nickel-plated Brass
Super-Safeway Outer Housing: NEöTEX Paracril OZO rubber
Safeway Outer Housing: Nylon
Face Screws: Stainless Steel
Face Insert: Nylon
Wire Saddle Clamp: Brass
Cord Clamp Screws: Steel, Zinc-plated
Plug/Connector Range: .325 to .840"

Environmental

Operating Temperature: Maximum continuous 75° C, minimum -40° C (no impact)
Temperature Rise: Maximum 30° C temperature rise at full rated current after 50 cycles of overload at 150% of rated current at a power factor of 75%.



Super-Safeway Industrial Rubber Plug and Connector

Description	Plug		Connector	
	Woodhead No.	Order No.	Woodhead No.	Order No.
Yellow rubber	2682	130142-0015	2782	130142-0029

Find adapters and technical support at the end of this section

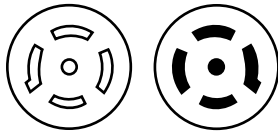

Industrial Duty Wiring Devices Locking Blade 20A 600V 3ø 4-Pole/5-Wire NEMA L23-20



Features and Benefits

- NEōTEX® Paracril OZO rubber body yields the best performance for abrasion, chemical exposure and temperature extremes within the Super-Safeway™ offering
- Color-coded ¼" terminal screws pre-set in open position, ready to wire
- Wire screw terminals are tri-drive to be used with straight blade, Phillips and square-drive screw drivers
- Floating blade construction provides self-alignment, and a better mechanical and electrical connection minimizing wear and heat generation
- Transparent wiring guide to verify all wire strands are in place before securing wire
- Captive, tri-drive head, Stainless Steel, speed screw provides easy assembly and long life
- Two-piece cord-clamp strain relief includes tri-drive screws to firmly secure the cord

Reference Information

UL File No.: E10176
CSA File No.: LR6837  

Physical

Plug blades and connector contacts: Nickel-plated Brass
Super-Safeway Outer Housing: NEōTEX Paracril OZO rubber
Safeway Outer Housing: Nylon
Face Screws: Stainless Steel
Face Insert: Nylon
Wire Saddle Clamp: Brass
Cord Clamp Screws: Steel, Zinc-plated
Plug/Connector Range: .325 to .840"

Environmental

Operating Temperature: Maximum continuous 75° C,
minimum -40° C (no impact)
Temperature Rise: Maximum 30° C temperature rise at full
rated current after 50 cycles of overload at 150% of
rated current at a power factor of 75%.



Super-Safeway Industrial Rubber Plug and Connector

Description	Plug		Connector	
	Woodhead No.	Order No.	Woodhead No.	Order No.
Yellow rubber	2683	130142-0016	2783	130142-0030

Find adapters and technical support at the end of this section

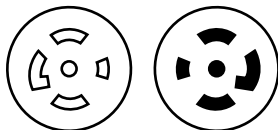

Industrial Duty Wiring Devices Locking Blade 30A 208V 3ø 4-Pole/5-Wire NEMA L21-30



Features and Benefits

- NEōTEX® Paracril OZO rubber body yields the best performance for abrasion, chemical exposure and temperature extremes within the Super-Safeway™ offering
- Color-coded ¼" screws pre-set in open position, ready to wire
- Wire screw terminals are tri-drive to be used with straight blade, Phillips and square-drive screw drivers
- Floating blade construction provides self-alignment, and a better mechanical and electrical connection minimizing wear and heat generation
- Transparent wiring guide to verify all wire strands are in place before securing wire
- Captive, tri-drive head, Stainless Steel, speed screw provides easy assembly and long life
- Two-piece cord-clamp strain relief includes tri-drive screws to firmly secure the cord

Reference Information

UL File No.: E10176
CSA File No.: LR6837  

Physical

Plug blades and connector contacts: Nickel-plated Brass
Super-Safeway Outer Housing: NEōTEX Paracril OZO rubber
Safeway Outer Housing: Nylon
Face Screws: Stainless Steel
Face Insert: Nylon
Wire Saddle Clamp: Brass
Cord Clamp Screws: Steel, Zinc-plated
Plug/Connector Range: .425 to 1.150"

Environmental

Operating Temperature: Maximum continuous 75° C,
minimum -40° C (no impact)
Temperature Rise: Maximum 30° C temperature rise at full
rated current after 50 cycles of overload at 150% of
rated current at a power factor of 75%.



Super-Safeway Industrial Rubber Plug and Connector

Description	Plug		Connector	
	Woodhead No.	Order No.	Woodhead No.	Order No.
Yellow rubber	2881	130142-0040	2981	130142-0047

Find adapters and technical support at the end of this section

Industrial Duty Wiring Devices Locking Blade 30A 480V 3Ø 4-Pole/5-Wire NEMA L22-30

Wiring Devices

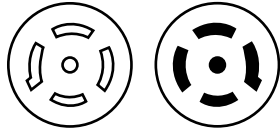

Features and Benefits

- NEöTEX® Paracril OZO rubber body yields the best performance for abrasion, chemical exposure and temperature extremes within the Super-Safeway™ offering
- Color-coded ¼" terminal screws pre-set in open position, ready to wire
- Wire screw terminals are tri-drive to be used with straight blade, Phillips and square-drive screw drivers
- Floating blade construction provides self-alignment, and a better mechanical and electrical connection minimizing wear and heat generation
- Transparent wiring guide to verify all wire strands are in place before securing wire
- Captive, tri-drive head, Stainless Steel, speed screw provides easy assembly and long life
- Two-piece cord-clamp strain relief includes tri-drive screws to firmly secure the cord

Reference Information

UL File No.: E10176

CSA File No.: LR6837



Physical

Plug blades and connector contacts: Nickel-plated Brass
Super-Safeway Outer Housing: NEöTEX Paracril OZO rubber
Safeway Outer Housing: Nylon
Face Screws: Stainless Steel
Face Insert: Nylon
Wire Saddle Clamp: Brass
Cord Clamp Screws: Steel, Zinc-plated
Plug/Connector Range: .425 to 1.150"

Environmental

Operating Temperature: Maximum continuous 75° C, minimum -40° C (no impact)
Temperature Rise: Maximum 30° C temperature rise at full rated current after 50 cycles of overload at 150% of rated current at a power factor of 75%.



Super-Safeway Industrial Rubber Plug and Connector

Description	Plug		Connector	
	Woodhead No.	Order No.	Woodhead No.	Order No.
Yellow rubber	2882	130142-0041	2982	130142-0048

Find adapters and technical support at the end of this section

Industrial Duty Wiring Devices Locking Blade 30A 600V 3Ø 4-Pole/5-Wire NEMA L23-30

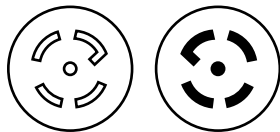

Features and Benefits

- NEöTEX® Paracril OZO rubber body yields the best performance for abrasion, chemical exposure and temperature extremes within the Super-Safeway™ offering
- Color-coded ¼" terminal screws pre-set in open position, ready to wire
- Wire screw terminals are tri-drive to be used with straight blade, Phillips and square-drive screw drivers
- Floating blade construction provides self-alignment, and a better mechanical and electrical connection minimizing wear and heat generation
- Transparent wiring guide to verify all wire strands are in place before securing wire
- Captive, tri-drive head, Stainless Steel, speed screw provides easy assembly and long life
- Two-piece cord-clamp strain relief includes tri-drive screws to firmly secure the cord

Reference Information

UL File No.: E10176

CSA File No.: LR6837



Physical

Plug blades and connector contacts: Nickel-plated Brass
Super-Safeway Outer Housing: NEöTEX Paracril OZO rubber
Safeway Outer Housing: Nylon
Face Screws: Stainless Steel
Face Insert: Nylon
Wire Saddle Clamp: Brass
Cord Clamp Screws: Steel, Zinc-plated
Plug/Connector Range: .425 to 1.150"

Environmental

Operating Temperature: Maximum continuous 75° C, minimum -40° C (no impact)
Temperature Rise: Maximum 30° C temperature rise at full rated current after 50 cycles of overload at 150% of rated current at a power factor of 75%.



Super-Safeway Industrial Rubber Plug and Connector

Description	Plug		Connector	
	Woodhead No.	Order No.	Woodhead No.	Order No.
Yellow rubber	2883	130142-0042	2983	130142-0049

Find adapters and technical support at the end of this section

Industrial Duty Wiring Devices Super-Safeway™ Adapters



Read across for plug (blade) configuration, then read down for receptacle (slot) configuration. Order the Woodhead number in intersecting box.

The following letter codes indicate limited use adapters:

- A For use only with receptacles wired for 125V single-phase grounding service.
- B For use only up to a maximum of 15A.
- C For use only with receptacles wires for 15A/125V single-phase grounding service

Features and Benefits

- NEōTEX® Paracril OZO rubber body yields the best performance for abrasion, chemical exposure and temperature extremes within the Super-Safeway™ offering
- Floating blade construction provides self-alignment, and a better mechanical and electrical connection minimizing wear and heat generation

Reference Information

UL File No.: E10176
CSA File No.: LR6837



Physical

Plug blades and connector contacts: Nickel-plated Brass
Super-Safeway Outer Housing: NEōTEX Paracril OZO rubber

Environmental









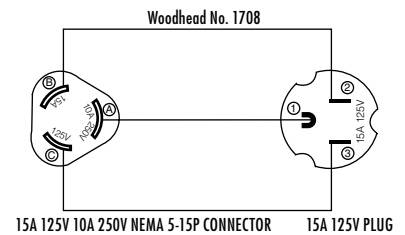
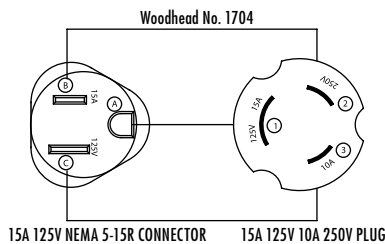
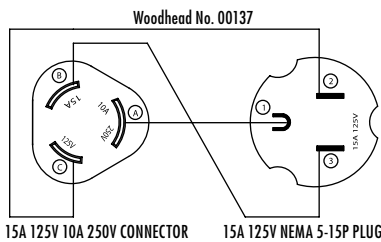
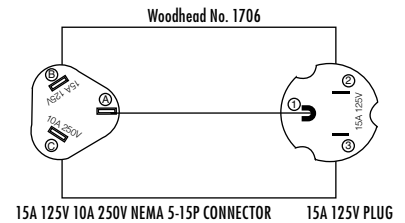
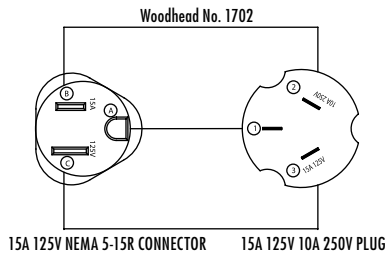
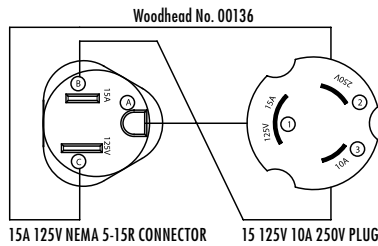







Operating Temperature: Maximum continuous 75° C, minimum -40° C (no impact)
Temperature Rise: Maximum 30° C temperature rise at full rated current after 50 cycles of overload at 150% of rated current at a power factor of 75%.

Receptable (female end)	Plug (Male End)							
	15A/125V 5-15	15A/125V* Non-NEMA	20A/125V 5-20	15A/125V L5-15	15A/125V* Non-NEMA	20A/125V L5-20	20A/125V P and S Pins	20A/250V Non-NEMA
15A/125V 5-15		1702† C		1705	1704† 00136† C	1740		1730
15A/125V* Non-NEMA	1706							
20A/125V 5-20						1740	1733	1730 A
15A/125V L5-15	1712				1725 C	1783		
15A/125V* Non-NEMA	1708 00137			1719				
20A/125V L5-20	1744 B		1741					
20A/250V Non-NEMA	1732 C							

* Also rated 10A/250V

† For adapter wiring, refer to wiring schematics below, not UL or CSA



Adapter	Woodhead No.	Order No.	Adapter	Woodhead No.	Order No.
	1706*†	130151-0015		1719*	130151-0018
	1712	130151-0017		1704*	130151-0013
	1708*	130151-0016		00136*†	130151-0001
	00137*†	130151-0002		1725*	130151-0019
	1744*	130151-0025		1740	130151-0023
	1732*	130151-0021		1783*	130151-0026
	1702*†	130151-0012		1733*	130151-0022
	1741	130151-0024		1730*†	130151-0020
	1705	130151-0014			

* Not UL listed
† Not CSA listed

Wiring Devices

Industrial Duty

60.0A

277V/480V

4-Pole/5-Wire

Features and Benefits

- Designed specifically for the Expo Center environment
- Woodhead Expo Connectors provide a single device that accepts both flat and round cable, a durable light-weight construction and a non-conductive exterior. This new design provides compact versatility in 60A configurations.
- Woodhead Expo Connectors are specifically designed for power distribution from ceiling drops, wall mounts and floor boxes to portable panel-boards.

Reference Information

UL File No.: E145923
 CSA File No.: LR6837



Physical

Pins: Brass
 Housing, Insert, Clamp: Polycarbonate

Environmental

General purpose

Expo Connector	Face View	Type	Description	Woodhead No.	Order No.
		Plug	60A Safeway Pin and Sleeve Device, Exposition Plug, 4-Pole/5-Wire Grounding with Flat Cable	Y560PF	130150-0284
		Inlet	60A Safeway Pin and Sleeve Device, Exposition Inlet, 4-Pole/5-Wire Grounding	Y560B	130150-0280
		Connector	60A Safeway Pin and Sleeve Device, Exposition Connector, 4-Pole/5-Wire Grounding with Flat Cable	Y560CF	130150-0282
		Receptacle	60A Safeway Pin and Sleeve Device, Exposition Receptacle, 4-Pole/5-Wire Grounding	Y560R	130150-0285
			60A Safeway Pin and Sleeve Device, Exposition Receptacle with Flip Lid, 4-Pole/5-Wire Grounding	Y561R	130150-0287

D

Wiring Devices

Safeway® Pin and Sleeve Devices Nylon

Features and Benefits

- IP44 rated
- Deadfront construction
- Self-adjusting split contact sleeves. Nickel-plated Steel spring compensates for wear, maintains constant pressure along contact surface to ensure electrical continuity and grounding
- Latching mechanism prevents accidental disengagement
- Keyway for fast, accurate alignment
- Internal strain relief with “swing away” feature
- External strain relief reduces bending arc of cable
- Large, identified terminals accept conductors one or two sizes larger or smaller than normal
- “Onion ring” neoprene bushing in cable grip accommodates wide range of cable sizes

Physical

Pins: Brass
Housing: Type G nylon
Contact Carrier: Type G nylon

Environmental

IEC Rating: IP44
IEC Standards*: 309-1 and 309-2

Applications

- Temporary power systems
- Power disconnect for portable processing equipment
- Machinery intended for export and users of foreign-built equipment

* IEC 309-1 and 309-2 are a worldwide pin and sleeve standard established by the International Electrotechnical Commission. It meets requirements of Section 410-56(g) of the National Electrical Code



20A Safeway Devices

Pole/Wire	Color	Voltage	Receptacle		Plug		Connector	
			Woodhead No.	Order No.	Woodhead No.	Order No.	Woodhead No.	Order No.
2-Pole/3-Wire	Yellow	125	320R4	130150-0056	320P4	130150-0049	320C4	130150-0036
2-Pole/3-Wire	Blue	250	320R6	130150-0058	320P6	130150-0052	320C6	130150-0039
2-Pole/3-Wire	Gray	277	320R5	130150-0289	320P5	130150-0051	320C5	130150-0038
3-Pole/4-Wire	Orange	125/250	420R12	130150-0143	420P12	130150-0135	420C12	130198-0124
3-Pole/4-Wire	Blue	3ø250	420R9	130150-0149	420P9	130150-0141	420C9	130150-0288
3-Pole/4-Wire	Red	3ø480	420R7	130150-0147	420P7	130150-0139	420C7	130150-0127
3-Pole/4-Wire	Black	3ø600	420R5	130150-0145	420P5	130150-0137	420C5	130150-0125
4-Pole/5-Wire	Blue	3øY 120/208	520R9	130150-0244	520P9	130150-0240	520C9	130150-0229
5-Pole/5-Wire	Red	3øY 277/480	520R7	130150-0242	520P7	130150-0238	520C7	130150-0227

30A Safeway Devices

Pole/Wire	Color	Voltage	Receptacle		Plug		Connector	
			Woodhead No.	Order No.	Woodhead No.	Order No.	Woodhead No.	Order No.
3-Pole/4-Wire	Red	3ø480	420R7	130150-0147	430P7	130150-0170	430C7	130150-0157

60A Safeway Devices

Pole/Wire	Color	Voltage	Receptacle		Plug		Connector	
			Woodhead No.	Order No.	Woodhead No.	Order No.	Woodhead No.	Order No.
3-Pole/4-Wire	Orange	125/250	460R12	130150-0206	460P12	130150-0198	460C12	130150-0185
3-Pole/4-Wire	Blue	3ø250	460R9	130150-0212	460P9	130150-0204	460C9	130150-0191
3-Pole/4-Wire	Red	3ø480	460R7	130150-0210	460P7	130150-0202	460C7	130150-0189
3-Pole/4-Wire	Black	3ø600	460R5	130150-0208	460P5	130150-0200	460C5	130150-0187

Note: Angled inlet and mechanical interlock also available for 2-Pole/3-Wire, 4-Pole/5-Wire

Technical Information

Safeway®

Pin and Sleeve Devices

Industrial Duty

IEC 309 PIN AND SLEEVE CONFIGURATION AND COLOR-CODING STANDARD

Contact Positions

The grounding contact position is based on a clock face. With the keyway at bottom, the female grounding contact will appear at one of the 12 clock positions. Example: all 480V AC receptacles and connectors, regardless of amperage, have their grounding sleeve at 7 o'clock (which puts the grounding pin on all mating plugs and inlets at 5 o'clock).

Voltage Rating Color-Code

The housings of every device in a particular voltage group are identical in color for instant identification. Example: All 480V AC devices are red, all 250V AC devices are blue.

Amperage Rating Identification

Amperage differences can be identified by the relative sizes of the devices. Smallest is 20A, largest is 60A.

Woodhead Catalog Numbering System

First Digit of Woodhead Number	Second Series of Digits	Letter	Third Digit
3 = 3-Wire	20 = 20A	P = Plug	Clock position of female grounding contact
4 = 4-Wire	30 = 30A	R = Receptacle	
5 = 5-Wire	60 = 60A	C = Connector	
	100 = 100A	B = Inlet	
		BA = Angled Inlet	

Examples: 430R7 = Woodhead 4-Wire, 30A receptacle with a grounding sleeve at seven o'clock.

430P7 = Woodhead 4-Wire, 30A plug which mates with a grounding sleeve at seven o'clock.

Cord Grip Ranges

Plug and Connector Type	Cable Diameter Min. (in.)	Cable Diameter Max. (in.)
320	.395	.825
420	.395	.825
520	.395	.825
330	.395	.825
430	.710	1.20
530	.710	1.20
60A	.710	1.20

Note: For Watertite® products, see page D-61

Technical Information

Woodhead® Wiring Devices

Technical Reference

Super-Safeway™ Adapters

Wiring Diagrams for NEMA Configurations
 Configurations shown are for female devices.

D
Wiring Devices

125V
2P, 2W

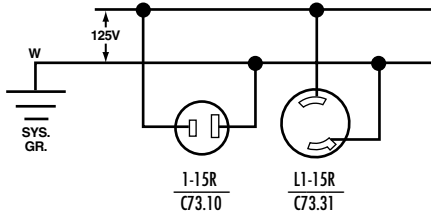

NEMA
ANSI

250V
2P, 2W

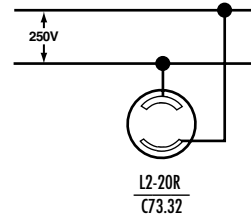

NEMA
ANSI

125
2P, 3W
GROUNDING

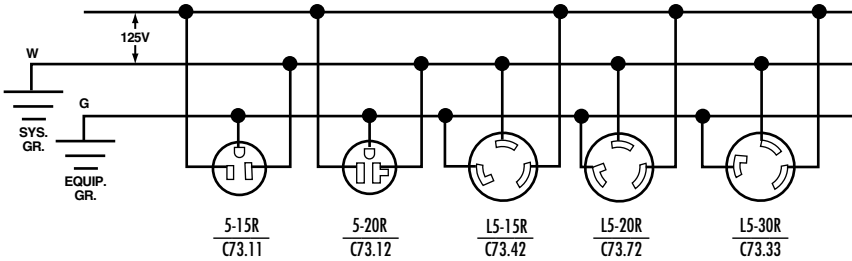

NEMA
ANSI

250V
2P, 3W
GROUNDING

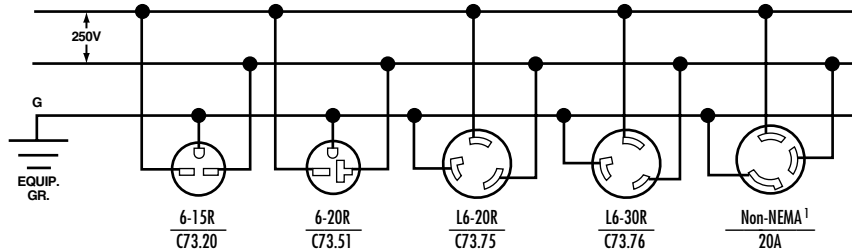

NEMA
ANSI

277VAC
2P, 3W
GROUNDING

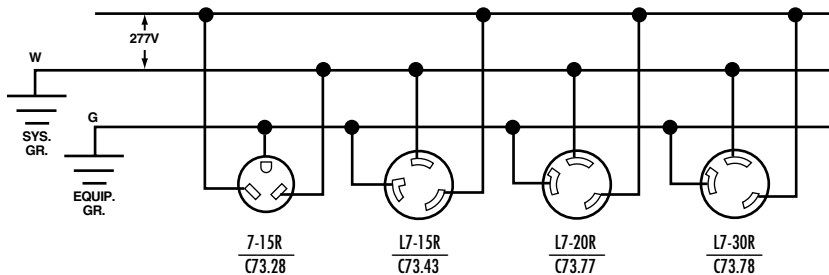

NEMA
ANSI

¹ Previously rated 20A/250V or 10A/600V.

² Previously rated 30A/250V.

Note: The above diagrams are intended to show wiring device terminal identification only.

Technical Information

Woodhead® Wiring Devices

Technical Reference

Wiring Diagrams for NEMA Configurations

Configurations shown are for female devices.

15A 125V/10A 250V
2P, 3W
GROUNDING

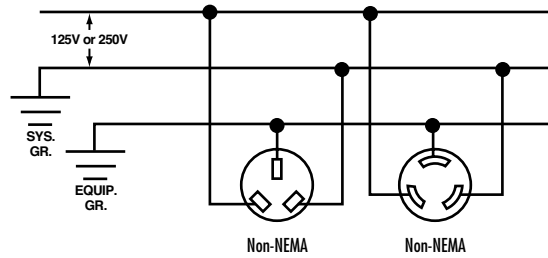

NEMA
ANSI

125/250V
3P, 3W

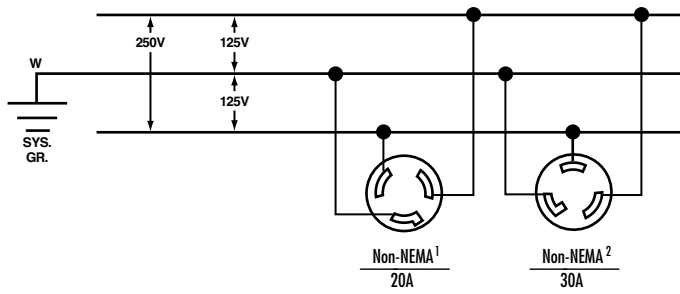

NEMA
ANSI

125/250V
3P, 4W
GROUNDING

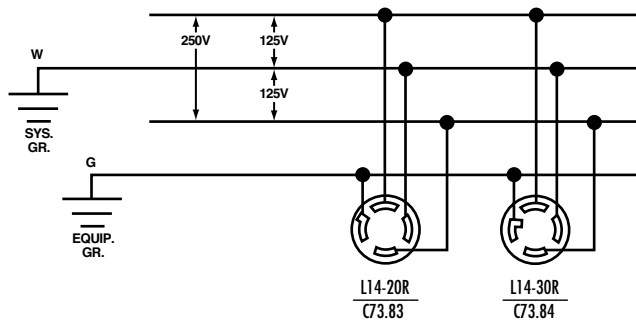

NEMA
ANSI

¹ Previously rated 20A/250V or 10A/600V.

² Previously rated 30A/250V.

Note: The above diagrams are intended to show wiring device terminal identification only.

Technical Information

Woodhead® Wiring Devices

Technical Reference

Wiring Diagrams for NEMA Configurations

Configurations shown are for female devices.

Wiring Devices

D
3ø
250V
3P, 4W
GROUNDING

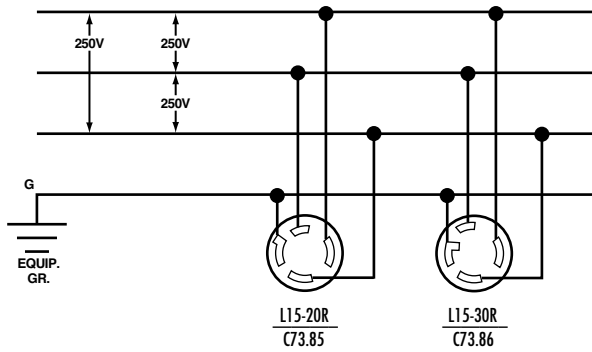

NEMA
ANSI

3ø
480V
3P, 4W
GROUNDING

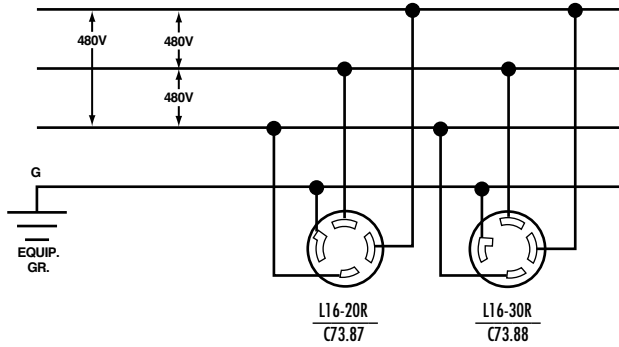

NEMA
ANSI

Note: The above diagrams are intended to show wiring device terminal identification only.

Technical Information

Woodhead® Wiring Devices

Technical Reference

Wiring Diagrams for NEMA Configurations

Configurations shown are for female devices.

3 ϕ
600V
3P, 4W
GROUNDING

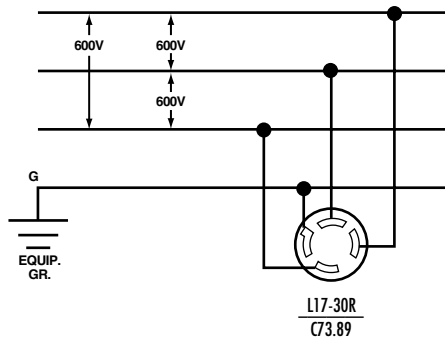

NEMA
ANSI

3 ϕ
120/208V
4P, 4W

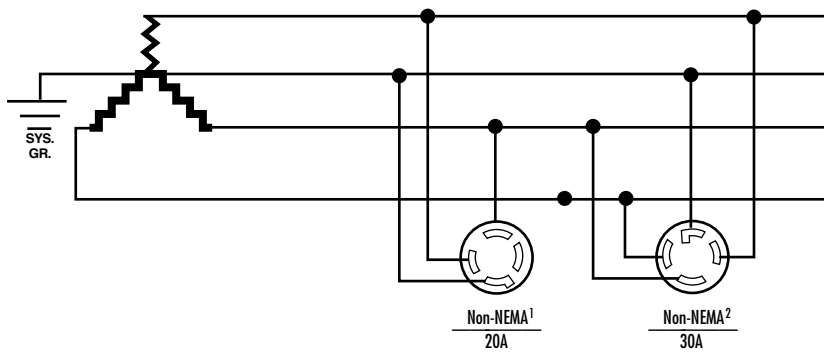

NEMA
ANSI

3 ϕ Y
120/208V
4P, 5W
GROUNDING

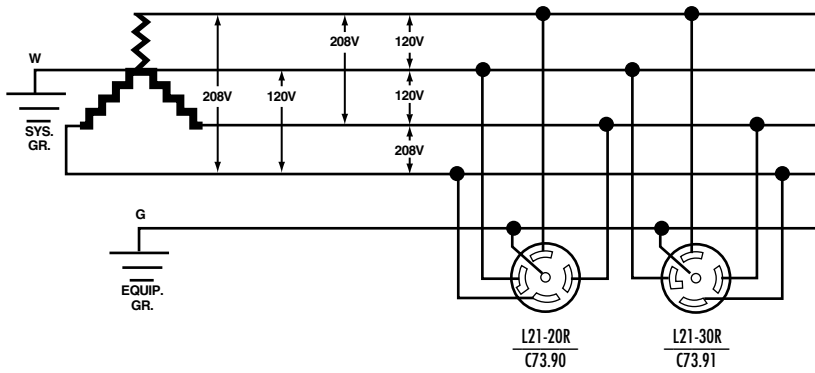

NEMA
ANSI

¹ Previously rated 20A/250V or 10A/600V.

² Previously rated 30A/250V.

Note: The above diagrams are intended to show wiring device terminal identification only.

Technical Information

Woodhead® Wiring Devices

Technical Reference

Wiring Diagrams for NEMA Configurations

Configurations shown are for female devices.

D
Wiring Devices

3 ϕ Y
277/480V
4P, 5W
GROUNDING

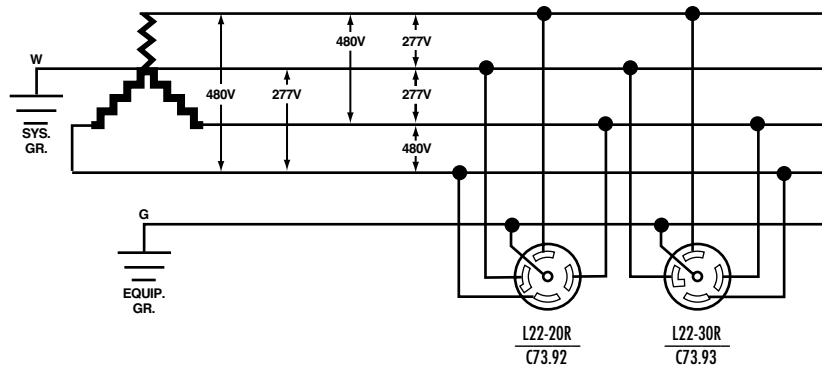

NEMA
ANSI

3 ϕ Y
347/600V
4P, 5W
GROUNDING

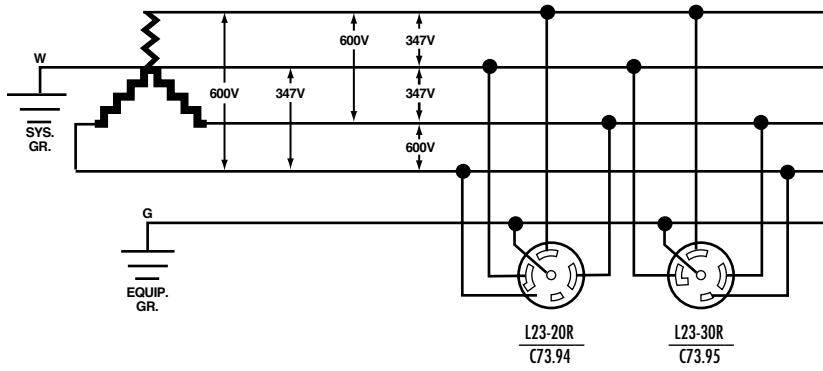

Note: The above diagrams are intended to show wiring device terminal identification only.

Technical Information

Woodhead® Wiring Devices

Technical Reference

Terminal Identification

Most Woodhead plugs, connectors, and receptacles are standard NEMA configurations. As such, standard terminal identification is used to incorporate these devices in the wiring system.

Terminal	Letter Designation	Description	Conductor
Green	G	Grounding terminal	Green, Green w/Yellow Stripe
White	W	Grounded terminal	White or Gray
X, Y, Z	X, Y, Z	Hot terminals	Black, Red, Blue, Etc. ¹

¹ There is no standard that matches color to letters. Once a correlation is chosen, it should be used consistently.

Watertite® Devices Cord Range

Dimensional Reference Information	Cord Range
F2	0.2–1.6cm (.062–.625")
F3	0.5–2.1cm (.187–.812")
F4	1.1–2.8cm (.437–1.10")
F5	2.2–3.5cm (.875–1.375")

Super-Safeway™, Safeway® Devices Cord Range

Dimensional Reference Information	Cord Range
2	0.8–1.7cm (.300–.675")
3	0.8–2.1cm (.325–.840")
4	1.1–2.9cm (.425–1.150")

Technical Information

Woodhead® Wiring Devices

Technical Reference

Horsepower Ratings for NEMA Configuration Attachment Plugs and Receptacles

15A

AC Voltage Rating	Phases	Poles	Horsepower Rating	NEMA Designation
125	1	2	½	1-15, L1-15, 5-15, L5-15
250	1	2	2	6-15, L6-15, 7-15, L7-15

20A

AC Voltage Rating	Phases	Poles	Horsepower Rating	NEMA Designation
125	1	2	1	5-20, L5-20
250	1	2	2	L2-20, 6-20, L6-20
277	1	2	2	L7-20
125/250	1	3	2 L-L, 1 L-N	10-20, L10-20, L14-20
250	3	3	5	L11-20, L15-20
480	3	3	10	L16-20
120/208	3	4	3	L21-20
277/480	3	4	10	L22-20

30A

AC Voltage Rating	Phases	Poles	Horsepower Rating	NEMA Designation
125	1	2	2	L5-30
250	1	2	3	L6-30
277	1	2	3	L7-30
125/250	1	3	2 L-N	L14-30
250	3	3	7½	L15-30
480	3	3	15	L16-30
120/208	3	4	5	L21-30
277/480	3	4	15	L22-30

L-L: Motor connected line-to-line

L-N: Motor connected line-to-neutral

Note: Horsepower ratings are not applicable to devices incorporating overcurrent protection or a switch.
Refer to ANSI/NEMA WD6-1988 for configurations of the NEMA designations.

Technical Information

Woodhead® Wiring Devices

Technical Reference

Selecting the Proper Cable Size

1. Determine the load ampacity requirements.
2. Read across for the number of current-carrying conductors.
3. Read down until the value meets or exceeds the requirements established in Step 1.
4. Read back across to left to determine the appropriate size cord.

AWG	2 Current-Carrying Conductors*	3 Current-Carrying Conductors*	4-6 Current-Carrying Conductors*
22	3A	3A	3A
18	10A	7A	5A
16	13A	10A	8A
14	18A	15A	12A
12	25A	20A	16A
10	30A	25A	20A
8	40A	35A	28A
6	55A	45A	36A
4	70A	60A	48A
2	95A	80A	64A

* In determining cord capacity, count only those conductors that are current-carrying. The grounding conductor is not counted.
 Note: For further information consult Table 400-5 of the National Electrical Code.

Nominal Cord Diameter*

AWG	2 Conductors	3 Conductors	4 Conductors	5 Conductors
22	0.215–0.235	0.215–0.235	0.240–0.260	0.250–0.270
18	0.340–0.385	0.360–0.400	0.385–0.430	0.460–0.510
16	0.365–0.410	0.385–0.430	0.410–0.460	0.490–0.550
14	0.495–0.550	0.520–0.575	0.560–0.620	0.630–0.705
12	0.565–0.625	0.590–0.655	0.640–0.710	0.700–0.770
10	0.615–0.685	0.650–0.720	0.700–0.775	0.760–0.840
8	0.780–0.880	0.830–0.930	0.925–1.050	1.000–1.150
6	0.920–1.050	0.970–1.100	1.050–1.200	1.180–1.330
4	1.060–1.210	1.130–1.280	1.250–1.450	
2	1.210–1.400	1.300–1.500	1.450–1.650	

* Cord types S, SE, SOO, SO, SEO, ST, ST00, and ST0. Information for 2- through 18-AWG cable taken from U.L. Standard 62 "Flexible Cord and Fixture Wire."
 Information for 22 AWG cable based on Woodhead cord.

Technical Information

Watertite® Rubber Devices

Dimensions

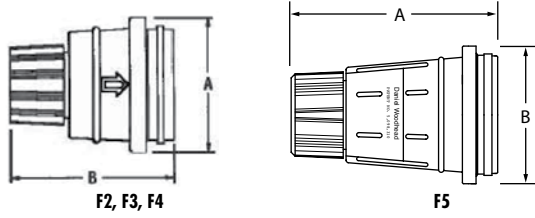

Male Plug

Cord Grip/Body Size	A Diameter	B Length
F2	4.7cm (1.85")	6.7cm (2.62")
F3	6.4cm (2.50")	7.6cm (3.00")
F4	6.9cm (2.75")	7.6cm (3.00")
F5	10.8cm (4.25")	8.3cm (3.25")

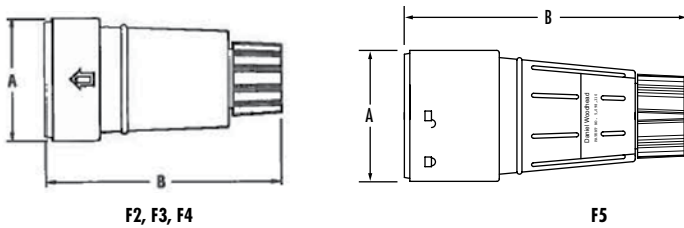

Female Connectors

Cord Grip/Body Size	A Diameter	B Length
F2	4.7cm (1.85")	10.2cm (4.03")
F3	6.4cm (2.50")	12.0cm (4.75")
F4	6.9cm (2.75")	12.0cm (4.75")
F5	8.3cm (3.25")	16.2cm (6.38")

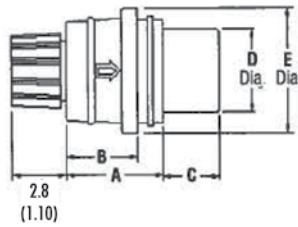

F2, F3, F4

Female Connector for Flip Lid with Male Receptacle

Cord Grip/Body Size	A Length	B Length	C Length	D Diameter	E Diameter
F2	4.1cm (1.63")	2.8cm (1.09")	1.8cm (.72")	3.3cm (1.30")	4.7cm (1.85")
F3	5.0cm (1.95")	3.6cm (1.43")	2.9cm (1.13")	4.2cm (1.66")	6.4cm (2.50")
F4	5.1cm (2.00")	3.8cm (1.49")	2.9cm (1.13")	4.7cm (1.86")	7.0cm (2.75")

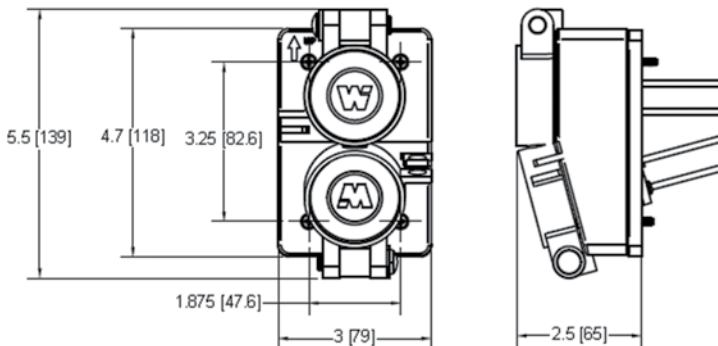

Technical Information

Watertite® Rubber Devices

Dimensions

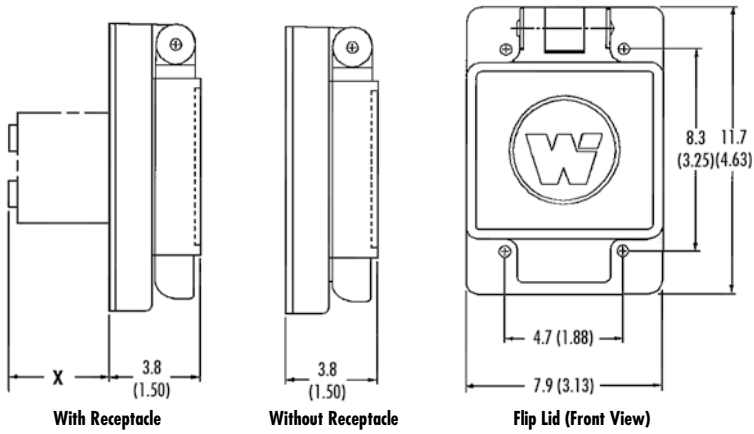

Flip Lid

Description	X Depth with Female Receptacle
Female locking 15A receptacles	2.3cm (0.91")
Female locking straight-blade 15A and 20A receptacles	2.3cm (0.91")
Female locking 20A and 30A receptacles	3.8cm (1.50")

Description	X Depth with Male Receptacle
Male locking 15A receptacles	4.8cm (1.88")
Male locking straight-blade 15A and 20A receptacles	4.8cm (1.88")
Male locking 20A and 30A receptacles	4.8cm (1.88")

GFCI Receptacle

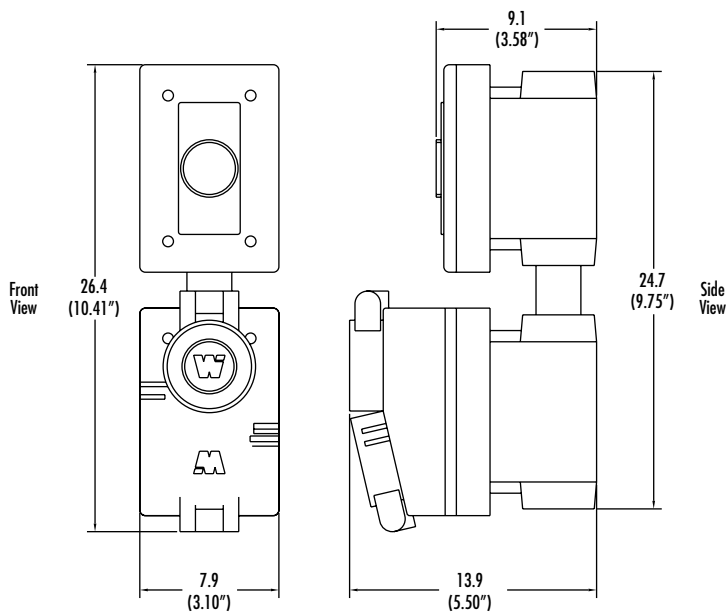

Technical Information

Watertite® Rubber Devices

Dimensions

F.S. Box

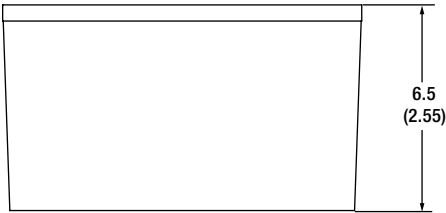
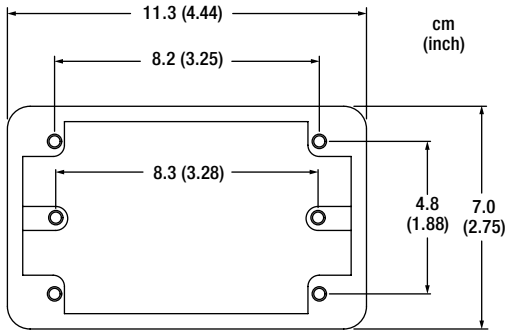

F.D. Box

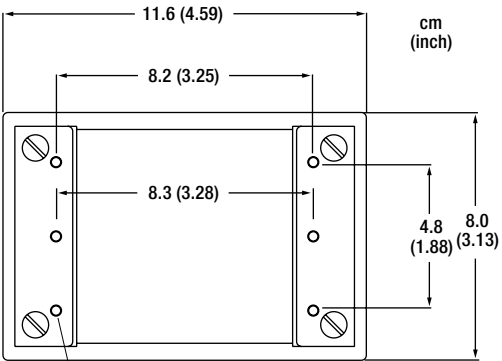

#6-32 threads (6)

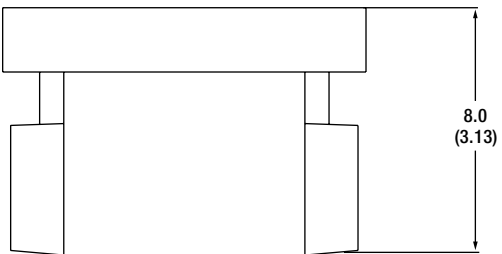

Technical Information

Super-Safeway™

Rubber Devices

Dimensions

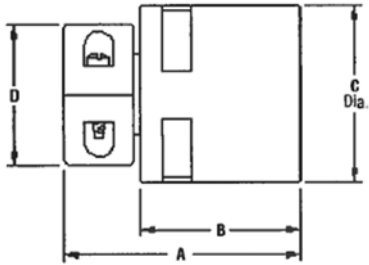

Male Plug

Current	A Length	B Length	C Diameter	D Diameter
All 15A devices and 20A straight-blade devices	5.8cm (2.27")	3.7cm (1.44")	3.9cm (1.53")	3.9cm (1.53")
20A locking	6.6cm (2.59")	4.5cm (1.76")	4.9cm (1.93")	4.2cm (1.60")
30A locking	6.7cm (2.64")	4.6cm (1.81")	5.4cm (2.11")	4.4cm (1.72")

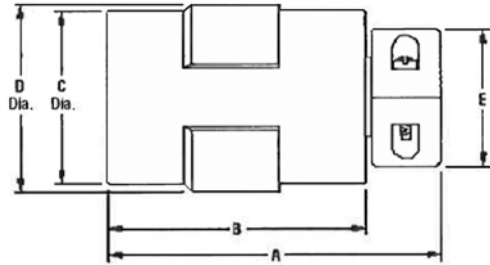

Female Connector

Current	A Length	B Length	C Diameter	D Diameter	E Diameter
All 15A devices and 20A straight-blade devices	7.6cm (2.99")	5.5cm (2.16")	3.9cm (1.53")	4.2cm (1.66")	3.9cm (1.53")
20A Locking	9.5cm (3.74")	5.6cm (2.19")	4.9cm (1.93")	5.3cm (2.07")	4.1cm (1.60")
30A Locking	9.6cm (3.77")	7.5cm (2.94")	5.4cm (2.13")	5.9cm (2.31")	4.4cm (1.72")

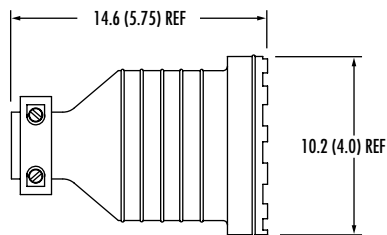
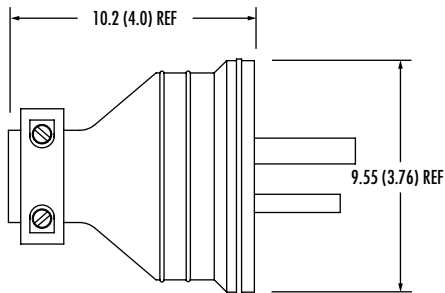

Woodhead No.	Order No.
8664	130142-0051
8665	130142-0052

Technical Information

Safeway® Nylon Devices

Dimensions

D
Wiring Devices

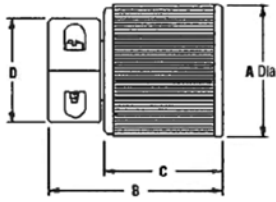

Safeway Plug

Dimensional Reference Information	A Diameter	B Length	C Length	D Diameter
All 15A devices and 20A straight-blade	3.9cm (1.53")	5.5cm (2.17")	3.4cm (1.34")	3.9cm (1.53")
20A Locking	4.9cm (1.94")	6.6cm (2.58")	4.5cm (1.75")	4.1cm (1.60")
30A Locking	5.4cm (2.14")	6.7cm (2.64")	4.6cm (1.81")	4.4cm (1.72")

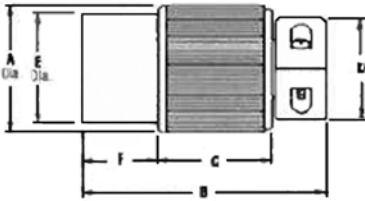

Safeway Connector

Dimensional Reference Information	A Diameter	B Length	C Length	D Diameter	E Diameter	F Length
All 15A devices and 20A straight-blade	3.9cm (1.53")	7.3cm (2.88")	3.4cm (1.34")	3.9cm (1.53")	3.3cm (1.30")	1.8cm (.71")
20A Locking	4.9cm (1.94")	9.5cm (3.75")	4.5cm (1.75")	4.1cm (1.60")	4.2cm (1.67")	3.0cm (1.17")
30A Locking	5.4cm (2.14")	9.7cm (3.80")	4.6cm (1.81")	4.4cm (1.72")	4.8cm (1.87")	2.9cm (1.16")

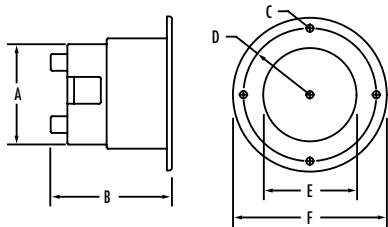

Flanged Inlet Receptacle

Dimensional Reference Information	A Diameter	B Length	C Length	D Diameter	E Diameter	F Length
All 15A devices and 20A straight-blade	5.8cm (2.25")	6.7cm (2.62")	.5cm (0.19")	3.8cm (1.5")	5.1cm (2.02")	8.9cm (3.5")
20A Locking	4.7cm (1.84")	5.0cm (1.95")	.5cm (0.19")	6.4cm (2.5")	4.8cm (1.88")	7.3cm (2.88")
30A Locking	5.2cm (2.04")	5.1cm (2.0")	.5cm (0.19")	6.9cm (2.7")	5.2cm (2.03")	7.7cm (3.03")

Technical Information

Safeway® Nylon Devices

Dimensions

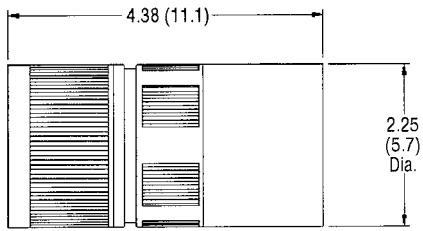

50A Plug

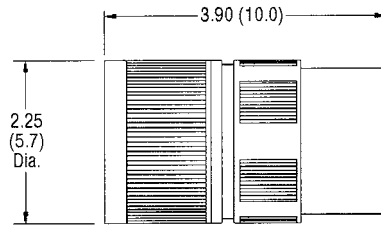

50A Connector*

* Cord range: 1.7–2.9cm (.680–1.125")

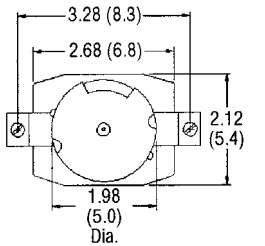

50A Receptacle

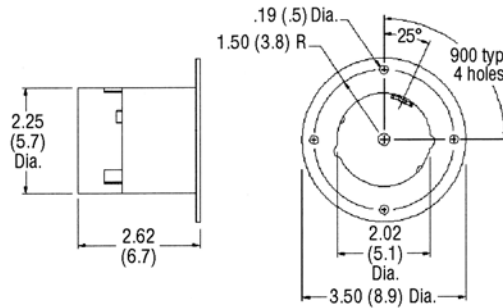

50A Flanged Inlet

Dimensions for all duplex receptacles

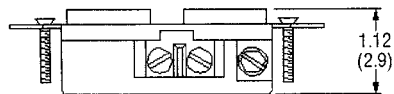
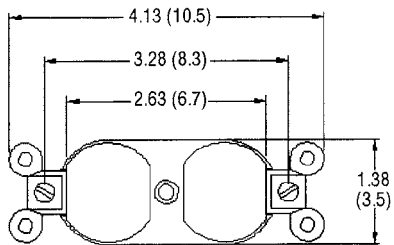

Duplex Receptacles

Dimensions for all straight-blade single receptacles

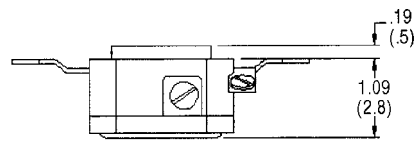
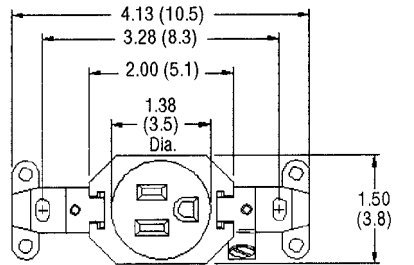

Straight-Blade Single Receptacles

Technical Information

Safeway® Nylon Devices

Dimensions

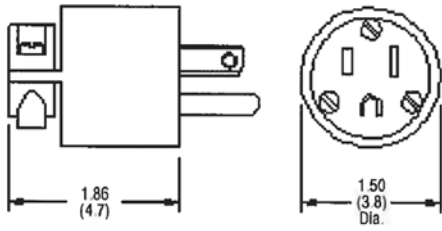

Hospital-Grade Devices

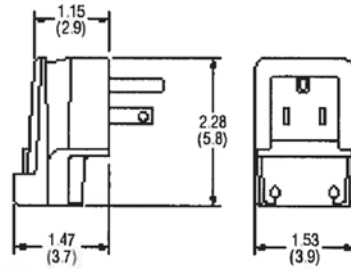

Right Angle Plug

Description	Woodhead No.	Order No.
Hospital-Grade Devices	85447	130144-0087
	85447L	130144-0088
Right Angle Plug	14R47	130144-0016
	85050	130144-0075

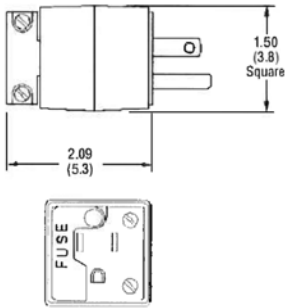

Individually Fused Grounding Plug

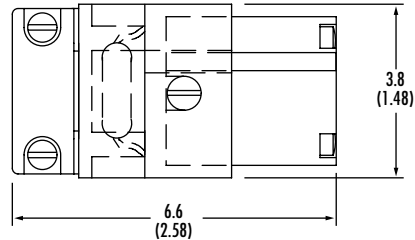

Lighted Connector

Description	Woodhead No.	Order No.
Individually Fused Grounding Plug	14F47	130144-0014
	85125	130144-0077
Lighted Connector	5269L	130144-0048

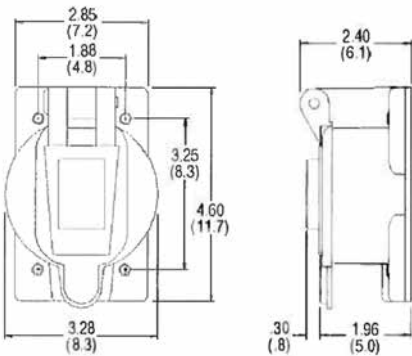

Flip Lid Cover

20A/30A Locking Single Receptacle

Current	Face Diameter
20A	4.0cm (1.56")
30A	4.1cm (1.63")

HEAVY-DUTY INDUSTRIAL



WOODHEAD® TOUGH NYLON SAFEWAY® AND SUPER-SAFEWAY™ RUBBERIZED WIRING DEVICES ARE DESIGNED FOR USE IN RUGGED INDUSTRIAL ENVIRONMENTS

Woodhead Super-Safeway products are heavy-duty industrial-wiring devices designed for abusive conditions and dependable performance for applications that demand the unmatched durability that rubber exclusively delivers. These rubberized industrial devices are the only wiring devices made of NEÖTEX® Paracril OZO rubber, a rubber construction that yields ultimate performance within a wide temperature range, around many oils and chemicals and abrasive conditions.

FEATURES AND BENEFITS

Super-Safeway	Rubber construction	An ultimate solution for temperature, chemical and abrasion resistance
Safeway and Super-Safeway	Self-aligning blades	Lower operating temperatures yielding longer life
	Wiring screw terminals backed out	Provides easier and quicker wiring
	Stainless-steel assembly screw	Provides a stronger, more long-lasting product

APPLICATIONS

- Aircraft construction/airports
- Construction site
- Facility maintenance
- Petrochemical
- Pulp and paper manufacturing

Industrial Duty Wiring Devices Straight Blade 15A 125V 2-Pole/2-Wire NEMA 1-15

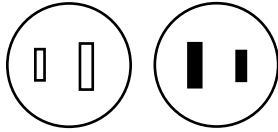

Features and Benefits

- NEoTEX® Paracril OZO rubber body yields the best performance for abrasion, chemical exposure and temperature extremes within the Super-Safeway™ offering
- Rugged nylon bodies within the Safeway® offering provide exceptional durability and performance
- Color-coded ¼" terminal screws pre-set in open position, ready to wire
- Wire screw terminals are tri-drive to be used with straight blade, Phillips and square-drive screw drivers
- Floating blade construction provides self-alignment, and a better mechanical and electrical connection minimizing wear and heat generation
- Transparent wiring guide to verify all wire strands are in place before securing wire
- Captive, tri-drive head, Stainless Steel, speed screw provides easy assembly and long life
- Two-piece cord-clamp strain relief includes tri-drive screws to firmly secure the cord

Reference Information

UL File No.: E10176
CSA File No.: LR6837



Physical

Plug blades and connector contacts: Nickel-plated Brass
Super-Safeway Outer Housing: NEoTEX Paracril OZO rubber

Safeway Outer Housing: Nylon
Face Screws: Stainless Steel
Face Insert: Nylon
Wire Saddle Clamp: Brass
Cord Clamp Screws: Steel, Zinc-plated
Plug/Connector Range: .335 to .640"

Environmental

Operating Temperature: Maximum continuous 75° C, minimum -40° C (no impact)
Temperature Rise: Maximum 30° C temperature rise at full rated current after 50 cycles of overload at 150% of rated current at a power factor of 75%.



Super-Safeway Industrial Rubber Plug and Connector

Description	Plug		Connector	
	Woodhead No.	Order No.	Woodhead No.	Order No.
Yellow rubber	1404	130141-0006	1504	130141-0023
Yellow rubber, Polarized	1419	130141-0008		



Safeway Industrial Nylon Plug and Connector

Description	Plug		Connector	
	Woodhead No.	Order No.	Woodhead No.	Order No.
Black and white	5166	130144-0034	5169	130144-0035
Black and white, polarized	5176	130144-0008		

Find adapters and technical support at the end of this section

Industrial Duty Wiring Devices Straight Blade 15A 125V 2-Pole/2-Wire NEMA 1-15

Wiring Devices

D

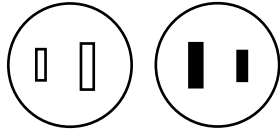

Safeway Inlet

Description	Single Male Inlet	
	Woodhead No.	Order No.
White, flanged	1404MB	130149-0005



Super-Safeway Industrial Rubber Cordset

Description	Cord Length	Woodhead No.	Order No.
Yellow 16 gauge SOOW cord	7.62m (25.0')	1404A162	130143-0083

Find adapters and technical support at the end of this section

Features and Benefits

- NEoTEX® Paracril OZO rubber body yields the best performance for abrasion, chemical exposure and temperature extremes within the Super-Safeway™ offering
- Rugged nylon bodies within the Safeway® offering provide exceptional durability and performance
- Color-coded ¼" terminal screws pre-set in open position, ready to wire
- Wire screw terminals are tri-drive to be used with straight blade, Phillips and square-drive screw drivers
- Floating blade construction provides self-alignment, and a better mechanical and electrical connection minimizing wear and heat generation
- Transparent wiring guide to verify all wire strands are in place before securing wire
- Captive, tri-drive head, Stainless Steel, speed screw provides easy assembly and long life
- Two-piece cord-clamp strain relief includes tri-drive screws to firmly secure the cord

Reference Information

UL File No.: Receptacle—E46231

Cordset—E38085

CSA File No.: LR6837



Physical

Plug blades and connector contacts: Nickel-plated Brass
Super-Safeway Outer Housing: NEoTEX Paracril OZO rubber

Safeway Outer Housing: Nylon

Face Screws: Stainless Steel

Face Insert: Nylon

Wire Saddle Clamp: Brass

Cord Clamp Screws: Steel, Zinc-plated

Environmental

Operating Temperature: Maximum continuous 75° C, minimum -40° C (no impact)

Temperature Rise: Maximum 30° C temperature rise at full rated current after 50 cycles of overload at 150% of rated current at a power factor of 75%.

Industrial Duty Wiring Devices Straight Blade 15A 125V 2-Pole/3-Wire NEMA 5-15

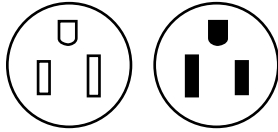

Features and Benefits

- NEoTEX® Paracril OZO rubber body yields the best performance for abrasion, chemical exposure and temperature extremes within the Super-Safeway™ offering
- Rugged nylon bodies within the Safeway® offering provide exceptional durability and performance.
- Color-coded ¼" terminal screws pre-set in open position, ready to wire
- Wire screw terminals are tri-drive to be used with straight blade, Phillips and square-drive screw drivers
- Floating blade construction provides self-alignment, and a better mechanical and electrical connection minimizing wear and heat generation
- Transparent wiring guide to verify all wire strands are in place before securing wire
- Captive, tri-drive head, Stainless Steel, speed screw provides easy assembly and long life
- Two-piece cord-clamp strain relief includes tri-drive screws to firmly secure the cord

Reference Information

UL File No.: E10176
CSA File No.: LR6837



Physical

Plug blades and connector contacts: Nickel-plated Brass
Super-Safeway Outer Housing: NEoTEX Paracril OZO rubber

Safeway Outer Housing: Nylon
Face Screws: Stainless Steel
Face Insert: Nylon
Wire Saddle Clamp: Brass
Cord Clamp Screws: Steel, Zinc-plated
Plug/Connector Range: .335 to .640"

Environmental

Operating Temperature: Maximum continuous 75° C, minimum -40° C (no impact)
Temperature Rise: Maximum 30° C temperature rise at full rated current after 50 cycles of overload at 150% of rated current at a power factor of 75%.



Super-Safeway Industrial Rubber Plug and Connector

Description	Plug		Connector		Lighted Plug		Lighted Connector	
	Woodhead No.	Order No.	Woodhead No.	Order No.	Woodhead No.	Order No.	Woodhead No.	Order No.
Yellow rubber	1447	130141-0015	1547	130141-0031			15L47 ¹	130141-0040
Black rubber	1447BLK	130141-0016	1547BLK	130141-0032			15L47BLK ¹	130141-0041
Yellow rubber, ground continuity monitor					1447EZ*	130141-0017	1547GCM*	130141-0033



Super-Safeway Industrial Rubber Plug and Connector

Description	Plug		Lighted Connector	
	Woodhead No.	Order No.	Woodhead No.	Order No.
Hospital duty, black rubber, grommet-style grip	85000	130141-0070		
Hospital duty, gray rubber, grommet-style grip			85002*	130141-0071

* Ground Continuity Monitor lights indicating a good ground is present

¹ Light indicates power is present

Find adapters and technical support at the end of this section

Industrial Duty Wiring Devices Straight Blade 15A 125V 2-Pole/3-Wire NEMA 5-15

Wiring Devices

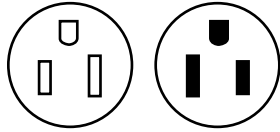

Features and Benefits

- NEoTEX® Paracril OZO rubber body yields the best performance for abrasion, chemical exposure and temperature extremes within the Super-Safeway™ offering
- Rugged nylon bodies within the Safeway® offering provide exceptional durability and performance
- Color-coded ¼" terminal screws pre-set in open position, ready to wire
- Wire screw terminals are tri-drive to be used with straight blade, Phillips and square-drive screw drivers
- Floating blade construction provides self-alignment, and a better mechanical and electrical connection minimizing wear and heat generation
- Transparent wiring guide to verify all wire strands are in place before securing wire
- Captive, tri-drive head, Stainless Steel, speed screw provides easy assembly and long life
- Two-piece cord-clamp strain relief includes tri-drive screws to firmly secure the cord

Reference Information

UL File No.: E10176
CSA File No.: LR6837



Physical

Plug blades and connector contacts: Nickel-plated Brass
Super-Safeway Outer Housing: NEoTEX Paracril OZO rubber
Safeway Outer Housing: Nylon
Face Screws: Stainless Steel
Face Insert: Nylon
Wire Saddle Clamp: Brass
Cord Clamp Screws: Steel, Zinc-plated
Plug/Connector Range: .335 to .640"

Environmental

Operating Temperature: Maximum continuous 75° C, minimum -40° C (no impact)
Temperature Rise: Maximum 30° C temperature rise at full rated current after 50 cycles of overload at 150% of rated current at a power factor of 75%.



Safeway Industrial Nylon Plug and Connector

Description	Plug		Connector		Lighted Plug		Lighted Connector	
	Woodhead No.	Order No.	Woodhead No.	Order No.	Woodhead No.	Order No.	Woodhead No.	Order No.
Black and white	5266	130144-0036	5269	130144-0044				
Yellow and white	5266YL	130144-0043	5269YL	130144-0050				
Black, hospital duty	85266	130144-0078	85269	130144-0080				
Yellow, hospital duty	85266YL	130144-0079	85269YL	130144-0081				
Transparent, hospital duty	85447	130144-0087	85547	130144-0089	85447L	130144-0088	5269L	130144-0048
Yellow, right angle	14R47	130144-0016						
Transparent, right angle, hospital duty	85050	130144-0075						
Yellow, individually fused	14F47*	130144-0014						

* UL File No. 52190, not CSA

Find adapters and technical support at the end of this section

Industrial Duty Wiring Devices Straight Blade 15A 125V 2-Pole/3-Wire NEMA 5-15

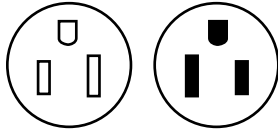

Features and Benefits

- NEōTEX® Paracril OZO rubber body yields the best performance for abrasion, chemical exposure and temperature extremes within the Super-Safeway™ offering
- Rugged nylon bodies within the Safeway® offering provide exceptional durability and performance
- Color-coded ¼" terminal screws pre-set in open position, ready to wire
- Wire screw terminals are tri-drive to be used with straight blade, Phillips and square-drive screw drivers
- Floating blade construction provides self-alignment, and a better mechanical and electrical connection minimizing wear and heat generation
- Transparent wiring guide to verify all wire strands are in place before securing wire
- Captive, tri-drive head, Stainless Steel, speed screw provides easy assembly and long life
- Two-piece cord-clamp strain relief includes tri-drive screws to firmly secure the cord

Reference Information

UL File No.: E46237
CSA File No.: LR6837



Physical

Plug blades and connector contacts: Nickel-plated Brass
Super-Safeway Outer Housing: NEōTEX Paracril OZO rubber

Safeway Outer Housing: Nylon

Face Screws: Stainless Steel

Face Insert: Nylon

Wire Saddle Clamp: Brass

Cord Clamp Screws: Steel, Zinc-plated

Environmental

Operating Temperature: Maximum continuous 75° C, minimum -40° C (no impact)

Temperature Rise: Maximum 30° C temperature rise at full rated current after 50 cycles of overload at 150% of rated current at a power factor of 75%.

D

Wiring Devices



5261DW



1547MB



5252DWBLK



5262DWCR



1447MB



85447MB

Safeway Receptacle and Inlet

Description	Single Receptacle		Duplex Receptacle		Single Male Inlet	
	Woodhead No.	Order No.	Woodhead No.	Order No.	Woodhead No.	Order No.
White, flanged	1547MB	130149-0012			1447MB	130149-0008
White, flanged, hospital duty					85447MB	130149-0094
Brown			5252DW	130148-0075		
Black			5252DWBLK	130148-0076		
Brown, heavy-duty	5261DW	130149-0087	5262DW	130148-0083		
Ivory, heavy-duty	5261DWI	130149-0088	5262DWI	130148-0086		
White, heavy-duty			5262DWW	130148-0089		
Yellow, heavy-duty corrosion resistant			5262DWCR	130148-0084		
Brown, heavy duty, hospital duty			85262DW	130148-0114		
Ivory, heavy duty, hospital duty			85262DWI	130148-0115		
Red, heavy duty, hospital duty			85262DWR	130148-0116		
White, heavy duty, hospital duty			85262DWW	130148-0117		

Find adapters and technical support at the end of this section

Industrial Duty Wiring Devices Straight Blade 15A 125V 2-Pole/3-Wire NEMA 5-15

Wiring Devices

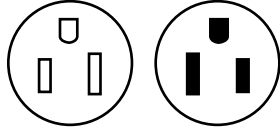

Features and Benefits

- NEoTEX® Paracril OZO rubber body yields the best performance for abrasion, chemical exposure and temperature extremes within the Super-Safeway™ offering
- Rugged nylon bodies within the Safeway® offering provide exceptional durability and performance
- Color-coded ¼" terminal screws pre-set in open position, ready to wire
- Wire screw terminals are tri-drive to be used with straight blade, Phillips and square-drive screw drivers
- Floating blade construction provides self-alignment, and a better mechanical and electrical connection minimizing wear and heat generation
- Transparent wiring guide to verify all wire strands are in place before securing wire
- Captive, tri-drive head, Stainless Steel, speed screw provides easy assembly and long life
- Two-piece cord-clamp strain relief includes tri-drive screws to firmly secure the cord

Reference Information

UL File No.: E38085
CSA File No.: LR6837



Physical

Plug blades and connector contacts: Nickel-plated Brass
Super-Safeway Outer Housing: NEoTEX Paracril OZO rubber

Safeway Outer Housing: Nylon

Face Screws: Stainless Steel

Face Insert: Nylon

Wire Saddle Clamp: Brass

Cord Clamp Screws: Steel, Zinc-plated

Environmental

Operating Temperature: Maximum continuous 75° C, minimum -40° C (no impact)

Temperature Rise: Maximum 30° C temperature rise at full rated current after 50 cycles of overload at 150% of rated current at a power factor of 75%.



Super-Safeway Industrial Rubber Cordset

Description	Cord Length	Woodhead No.	Order No.
Yellow 16 gauge S00W cord	7.62m (25.0')	1447A163	130143-0097
	15.24m (50.0')	1447B163	130143-0104
	30.48m (100.0')	1447D163	130143-0113
Yellow 14 gauge S00W cord	1.83m (6.0')	1447L143	130143-0114
	7.62m (25.0')	1447A143	130143-0095
	15.24m (50.0')	1447B143	130143-0102
	30.48m (100.0')	1447D143	130143-0111
Yellow 12 gauge S00W cord	7.62m (25.0')	1447A123	130143-0093
	15.24m (50.0')	1447B123	130143-0099

Super-Safeway Industrial Rubber Cordset with Inline GFCI

Description	Cord Length	Woodhead No.	Order No.
Yellow, 14 gauge SJOW cord with inline GFCI	15.24m (50.0')	1447B143IN	130143-0103

Find adapters and technical support at the end of this section

Industrial Duty Wiring Devices Straight Blade 15A 125V 2-Pole/3-Wire NEMA 5-15

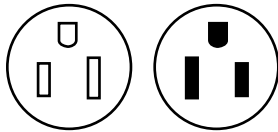

Features and Benefits

- NEōTEX® Paracril OZO rubber body yields the best performance for abrasion, chemical exposure and temperature extremes within the Super-Safeway™ offering
- Rugged nylon bodies within the Safeway® offering provide exceptional durability and performance
- Color-coded ¼" terminal screws pre-set in open position, ready to wire
- Wire screw terminals are tri-drive to be used with straight blade, Phillips and square-drive screw drivers
- Floating blade construction provides self-alignment, and a better mechanical and electrical connection minimizing wear and heat generation
- Transparent wiring guide to verify all wire strands are in place before securing wire
- Captive, tri-drive head, Stainless Steel, speed screw provides easy assembly and long life
- Two-piece cord-clamp strain relief includes tri-drive screws to firmly secure the cord

Reference Information

UL File No.: E38085

Y and W Non-Inline GFCI Cordset—E38085

CSA File No.: LR6837

Y and W Non-Inline GFCI Cordset—LL52750



Physical

Plug blades and connector contacts: Nickel-plated Brass
Super-Safeway Outer Housing: NEōTEX Paracril OZO rubber

Safeway Outer Housing: Nylon

Face Screws: Stainless Steel

Face Insert: Nylon

Wire Saddle Clamp: Brass

Cord Clamp Screws: Steel, Zinc-plated

Environmental

Operating Temperature: Maximum continuous 75° C, minimum -40° C (no impact)

Temperature Rise: Maximum 30° C temperature rise at full rated current after 50 cycles of overload at 150% of rated current at a power factor of 75%.



Super-Safeway Industrial Rubber Molded Y and W Cordset

Description	Color	Y-Cordset, 3.0'		W-Cordset, 3.0'	
		Woodhead No.	Order No.	Woodhead No.	Order No.
Yellow, 12 gauge S00W cord	Yellow	1447-Y	130154-0038	1447-W	130154-0035
Black, 12 gauge S00W cord	Black	1447-YB	130154-0039		



Super-Safeway Industrial Rubber Molded Cordset

Description	Y-Cordset, 3.0'		W-Cordset, 3.0'	
	Woodhead No.	Order No.	Woodhead No.	Order No.
Yellow, 12 gauge SJ0W cord with inline GFCI	1447-Y-IN	130154-0040	1447-W-IN	130154-0037

Find adapters and technical support at the end of this section

Industrial Duty Wiring Devices Straight Blade 15A 250V 2-Pole/3-Wire NEMA 6-15

Wiring Devices

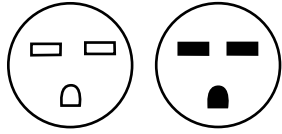

Features and Benefits

- NEoTEX® Paracril OZO rubber body yields the best performance for abrasion, chemical exposure and temperature extremes within the Super-Safeway™ offering
- Rugged nylon bodies within the Safeway® offering provide exceptional durability and performance
- Color-coded ¼" terminal screws pre-set in open position, ready to wire
- Wire screw terminals are tri-drive to be used with straight blade, Phillips and square-drive screw drivers
- Floating blade construction provides self-alignment, and a better mechanical and electrical connection minimizing wear and heat generation
- Transparent wiring guide to verify all wire strands are in place before securing wire
- Captive, tri-drive head, Stainless Steel, speed screw provides easy assembly and long life
- Two-piece cord-clamp strain relief includes tri-drive screws to firmly secure the cord

Reference Information

UL File No.: Plug and Connector—E10176

Receptacle—E46237

CSA File No.: LR6837



Physical

Plug blades and connector contacts: Nickel-plated Brass
Super-Safeway Outer Housing: NEoTEX Paracril OZO rubber

Safeway Outer Housing: Nylon

Face Screws: Stainless Steel

Face Insert: Nylon

Wire Saddle Clamp: Brass

Cord Clamp Screws: Steel, Zinc-plated

Plug/Connector Range: .335 to .640"

Environmental

Operating Temperature: Maximum continuous 75° C, minimum -40° C (no impact)

Temperature Rise: Maximum 30° C temperature rise at full rated current after 50 cycles of overload at 150% of rated current at a power factor of 75%.



Super-Safeway Industrial Rubber Plug and Connector

Description	Plug		Connector	
	Woodhead No.	Order No.	Woodhead No.	Order No.
Yellow rubber	1449	130141-0022	1549	130141-0038



Safeway Industrial Nylon Plug and Connector

Description	Plug		Connector	
	Woodhead No.	Order No.	Woodhead No.	Order No.
Black and white	5666	130144-0065	5669	130144-0067



Safeway Receptacle and Inlet

Description	Duplex Receptacle	
	Woodhead No.	Order No.
Brown, heavy-duty	5662DW	130148-0111
Yellow, heavy-duty corrosion resistant	5662DWCR	130148-0112

Find adapters and technical support at the end of this section.

Industrial Duty Wiring Devices Straight Blade 15A 250V 2-Pole/3-Wire NEMA 6-15

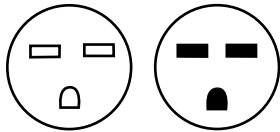

Features and Benefits

- NEōTEX® Paracril OZO rubber body yields the best performance for abrasion, chemical exposure and temperature extremes within the Super-Safeway™ offering
- Rugged nylon bodies within the Safeway® offering provide exceptional durability and performance
- Color-coded ¼" terminal screws pre-set in open position, ready to wire
- Wire screw terminals are tri-drive to be used with straight blade, Phillips and square-drive screw drivers
- Floating blade construction provides self-alignment, and a better mechanical and electrical connection minimizing wear and heat generation
- Transparent wiring guide to verify all wire strands are in place before securing wire
- Captive, tri-drive head, Stainless Steel, speed screw provides easy assembly and long life
- Two-piece cord-clamp strain relief includes tri-drive screws to firmly secure the cord

Reference Information

UL File No.: E38085
W Cordset—E38085
CSA File No.: LR6837
W Cordset—LL52750



Physical

Plug blades and connector contacts: Nickel-plated Brass
Super-Safeway Outer Housing: NEōTEX Paracril OZO rubber
Safeway Outer Housing: Nylon
Face Screws: Stainless Steel
Face Insert: Nylon
Wire Saddle Clamp: Brass
Cord Clamp Screws: Steel, Zinc-plated

Environmental

Operating Temperature: Maximum continuous 75° C, minimum -40° C (no impact)
Temperature Rise: Maximum 30° C temperature rise at full rated current after 50 cycles of overload at 150% of rated current at a power factor of 75%.

D

Wiring Devices



Super-Safeway Industrial Rubber Cordset

Description	Cord Length	Woodhead No.	Order No.
Yellow 14 gauge SOOW cord	15.24m (50.0')	1449B143	130143-0119



Super-Safeway Industrial Rubber Molded W Cordset

Description	W-Cordset, 3.0'	
	Woodhead No.	Order No.
Yellow 12 gauge SOOW cord	1449-W	130154-0042

Find adapters and technical support at the end of this section

Industrial Duty Wiring Devices Straight Blade 15A 277V 2-Pole/3-Wire NEMA 7-15

D
Wiring Devices

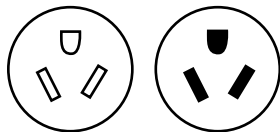

Features and Benefits

- NEoTEX® Paracril OZO rubber body yields the best performance for abrasion, chemical exposure and temperature extremes within the Super-Safeway™ offering
- Rugged nylon bodies within the Safeway® offering provide exceptional durability and performance
- Color-coded ¼" terminal screws pre-set in open position, ready to wire
- Wire screw terminals are tri-drive to be used with straight blade, Phillips and square-drive screw drivers
- Floating blade construction provides self-alignment, and a better mechanical and electrical connection minimizing wear and heat generation
- Transparent wiring guide to verify all wire strands are in place before securing wire
- Captive, tri-drive head, Stainless Steel, speed screw provides easy assembly and long life
- Two-piece cord-clamp strain relief includes tri-drive screws to firmly secure the cord

Reference Information

UL File No.: E10176
CSA File No.: LR6837



Physical

Plug blades and connector contacts: Nickel-plated Brass
Super-Safeway Outer Housing: NEoTEX Paracril OZO rubber
Safeway Outer Housing: Nylon
Face Screws: Stainless Steel
Face Insert: Nylon
Wire Saddle Clamp: Brass
Cord Clamp Screws: Steel, Zinc-plated
Plug/Connector Range: .335 to .640"

Environmental

Operating Temperature: Maximum continuous 75° C, minimum -40° C (no impact)
Temperature Rise: Maximum 30° C temperature rise at full rated current after 50 cycles of overload at 150% of rated current at a power factor of 75%.



1434



1534

Super-Safeway Industrial Rubber Plug and Connector

Description	Plug		Connector	
	Woodhead No.	Order No.	Woodhead No.	Order No.
Yellow rubber	1434	130141-0014	1534	130141-0030



Safeway Industrial Nylon Plug and Connector

Description	Plug		Connector	
	Woodhead No.	Order No.	Woodhead No.	Order No.
Black and white	5766	130144-0069	5769	130144-0071

Find adapters and technical support at the end of this section

Industrial Duty Wiring Devices Straight Blade 20A 125V 2-Pole/3-Wire NEMA 5-20

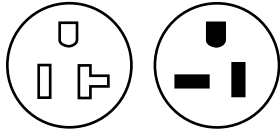

Features and Benefits

- NEōTEX® Paracril OZO rubber body yields the best performance for abrasion, chemical exposure and temperature extremes within the Super-Safeway™ offering
- Rugged nylon bodies within the Safeway® offering provide exceptional durability and performance
- Color-coded ¼" terminal screws pre-set in open position, ready to wire
- Wire screw terminals are tri-drive to be used with straight blade, Phillips and square-drive screw drivers
- Floating blade construction provides self-alignment, and a better mechanical and electrical connection minimizing wear and heat generation
- Transparent wiring guide to verify all wire strands are in place before securing wire
- Captive, tri-drive head, Stainless Steel, speed screw provides easy assembly and long life
- Two-piece cord-clamp strain relief includes tri-drive screws to firmly secure the cord

Reference Information

UL File No.: E10176
CSA File No.: LR6837



Physical

Plug blades and connector contacts: Nickel-plated Brass
Super-Safeway Outer Housing: NEōTEX Paracril OZO rubber
Safeway Outer Housing: Nylon
Face Screws: Stainless Steel
Face Insert: Nylon
Wire Saddle Clamp: Brass
Cord Clamp Screws: Steel, Zinc-plated
Plug/Connector Range: .335 to .640"

Environmental

Operating Temperature: Maximum continuous 75° C, minimum -40° C (no impact)
Temperature Rise: Maximum 30° C temperature rise at full rated current after 50 cycles of overload at 150% of rated current at a power factor of 75%.



1433



1533



1433EZ



1533GCM

Super-Safeway Industrial Rubber Plug and Connector

Description	Plug		Connector		Lighted Plug		Lighted Connector	
	Woodhead No.	Order No.	Woodhead No.	Order No.	Woodhead No.*	Order No.	Woodhead No.*	Order No.
Yellow rubber	1433	130141-0010	1533	130141-0025				
Black rubber	1433BLK	130141-0011						
Yellow rubber, Ground Continuity Monitor					1433EZ	130141-0012	1533GCM	130141-0027

* Ground Continuity Monitor lights indicating a good ground is present



85366



85053



85369

Safeway Industrial Nylon Plug and Connector

Description	Plug		Connector	
	Woodhead No.	Order No.	Woodhead No.	Order No.
Black and white	5366	130144-0053	5369	130144-0057
Orange and white	5366ORG	130144-0054		
Black, hospital duty	85366	130144-0082	85369	130144-0084
Transparent, right angle	85053	130144-0076		

Find adapters and technical support at the end of this section

Industrial Duty Wiring Devices Straight Blade 20A 125V 2-Pole/3-Wire NEMA 5-20

Wiring Devices

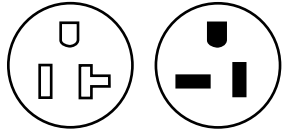

Features and Benefits

- NEoTEX® Paracril OZO rubber body yields the best performance for abrasion, chemical exposure and temperature extremes within the Super-Safeway™ offering
- Rugged nylon bodies within the Safeway® offering provide exceptional durability and performance
- Color-coded ¼" terminal screws pre-set in open position, ready to wire
- Wire screw terminals are tri-drive to be used with straight blade, Phillips and square-drive screw drivers
- Floating blade construction provides self-alignment, and a better mechanical and electrical connection minimizing wear and heat generation
- Transparent wiring guide to verify all wire strands are in place before securing wire
- Captive, tri-drive head, Stainless Steel, speed screw provides easy assembly and long life
- Two-piece cord-clamp strain relief includes tri-drive screws to firmly secure the cord

Reference Information

UL File No.: Receptacle—E46237 (except for 5362DWR)
Cordset—E38085

CSA File No.: LR6837



Physical

Plug blades and connector contacts: Nickel-plated Brass
Super-Safeway Outer Housing: NEoTEX Paracril OZO rubber
Safeway Outer Housing: Nylon
Face Screws: Stainless Steel
Face Insert: Nylon
Wire Saddle Clamp: Brass
Cord Clamp Screws: Steel, Zinc-plated

Environmental

Operating Temperature: Maximum continuous 75° C, minimum -40° C (no impact)
Temperature Rise: Maximum 30° C temperature rise at full rated current after 50 cycles of overload at 150% of rated current at a power factor of 75%.



Safeway Receptacle and Inlet

Description	Single Receptacle		Duplex Receptacle		Single Male Inlet	
	Woodhead No.	Order No.	Woodhead No.	Order No.	Woodhead No.	Order No.
White, flanged	1533MB	130149-0011			1433MB	130149-0007
Brown, heavy-duty	5361DW*	130149-0089	5362DW*	130148-0097		
Black, heavy-duty			5362DWBLK*	130148-0099		
Ivory, heavy-duty			5362DWI*	130148-0102		
Red, heavy-duty			5362DWR*	130148-0104		
Blue, heavy-duty			5362DWBL*	130148-0091		
Yellow, heavy-duty corrosion resistant			5362DWCR*	130148-0100		
Brown, heavy-duty, hospital duty			85362DW*	130148-0118		
Black, heavy-duty, hospital duty			85362DWBLK*	130148-0119		
Ivory, heavy-duty, hospital duty			85362DWI*	130148-0121		
Red, heavy-duty, hospital duty			85362DWR*	130148-0122		
White, heavy-duty, hospital duty			85362DWW*	130148-0123		

* Not CSA listed



Super-Safeway Industrial Rubber Cordset

Description	Cord Length	Woodhead No.	Order No.
Yellow 14 gauge 500W cord	7.62m (25.0')	1433A143	130143-0086
	7.62m (25.0')	1433A123	130143-0084
Yellow 12 gauge 500W cord	15.24m (50.0')	1433B123	130143-0088
	30.48m (100.0')	1433D123	130143-0091

Find adapters and technical support at the end of this section

Industrial Duty Wiring Devices Straight Blade 20A 125V 2-Pole/3-Wire NEMA 5-20

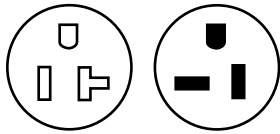

Features and Benefits

- NEōTEX® Paracril OZO rubber body yields the best performance for abrasion, chemical exposure and temperature extremes within the Super-Safeway™ offering
- Rugged nylon bodies within the Safeway® offering provide exceptional durability and performance
- Color-coded ¼" terminal screws pre-set in open position, ready to wire
- Wire screw terminals are tri-drive to be used with straight blade, Phillips and square-drive screw drivers
- Floating blade construction provides self-alignment, and a better mechanical and electrical connection minimizing wear and heat generation
- Transparent wiring guide to verify all wire strands are in place before securing wire
- Captive, tri-drive head, Stainless Steel, speed screw provides easy assembly and long life
- Two-piece cord-clamp strain relief includes tri-drive screws to firmly secure the cord

Reference Information

UL File No.: E38085

Y and W Non-Inline GFCI Cordset—E38085

CSA File No.: LR6837

Y and W Non-Inline GFCI Cordset—LL52750



Physical

Plug blades and connector contacts: Nickel-plated Brass
Super-Safeway Outer Housing: NEōTEX Paracril OZO rubber

Safeway Outer Housing: Nylon

Face Screws: Stainless Steel

Face Insert: Nylon

Wire Saddle Clamp: Brass

Cord Clamp Screws: Steel, Zinc-plated

Environmental

Operating Temperature: Maximum continuous 75° C, minimum -40° C (no impact)

Temperature Rise: Maximum 30° C temperature rise at full rated current after 50 cycles of overload at 150% of rated current at a power factor of 75%.

D

Wiring Devices



Super-Safeway Industrial Rubber Molded Y and W Cordset

Description	Cord Length	Y-Cordset		W-Cordset	
		Woodhead No.	Order No.	Woodhead No.	Order No.
Yellow 12 gauge 500W cord	0.91m (3.0')	1433-Y	130154-0034	1433-W	130154-0033



Super-Safeway Industrial Rubber Molded W Cordset with Inline GFCI

Description	Cord Length	W-Cordset	
		Woodhead No.	Order No.
Yellow, 12 gauge SJOW cord with inline GFCI	0.91m (3.0')	1433-W-IN	130154-0105

Find adapters and technical support at the end of this section

Industrial Duty Wiring Devices Straight Blade 20A 250V 2-Pole/3-Wire NEMA 6-20

Wiring Devices

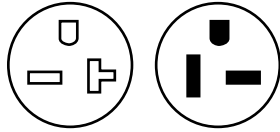

Features and Benefits

- NEoTEX® Paracril OZO rubber body yields the best performance for abrasion, chemical exposure and temperature extremes within the Super-Safeway™ offering
- Rugged nylon bodies within the Safeway® offering provide exceptional durability and performance
- Color-coded ¼" terminal screws pre-set in open position, ready to wire
- Wire screw terminals are tri-drive to be used with straight blade, Phillips and square-drive screw drivers
- Floating blade construction provides self-alignment, and a better mechanical and electrical connection minimizing wear and heat generation
- Transparent wiring guide to verify all wire strands are in place before securing wire
- Captive, tri-drive head, Stainless Steel, speed screw provides easy assembly and long life
- Two-piece cord-clamp strain relief includes tri-drive screws to firmly secure the cord

Reference Information

UL File No.: Plug and Connector—E10176

Receptacle—E46237

CSA File No.: LR6837



Physical

Plug blades and connector contacts: Nickel-plated Brass
Super-Safeway Outer Housing: NEoTEX Paracril OZO rubber

Safeway Outer Housing: Nylon

Face Screws: Stainless Steel

Face Insert: Nylon

Wire Saddle Clamp: Brass

Cord Clamp Screws: Steel, Zinc-plated

Plug/Connector Range: .335 to .640"

Environmental

Operating Temperature: Maximum continuous 75° C, minimum -40° C (no impact)

Temperature Rise: Maximum 30° C temperature rise at full rated current after 50 cycles of overload at 150% of rated current at a power factor of 75%.



Super-Safeway Industrial Rubber Plug and Connector

Description	Plug		Connector	
	Woodhead No.	Order No.	Woodhead No.	Order No.
Yellow rubber	1448	130141-0020	1548	130141-0036



Safeway Industrial Nylon Plug and Connector

Description	Plug		Connector	
	Woodhead No.	Order No.	Woodhead No.	Order No.
Black and white	5466	130144-0061	5469	130144-0063
Yellow and white	5466YL	130144-0062	5469YL	130144-0064



1548MB



5462DW



5462DWCR

Safeway Receptacle and Inlet

Description	Single Receptacle		Duplex Receptacle	
	Woodhead No.	Order No.	Woodhead No.	Order No.
White, flanged	1548MB	130149-0013		
Brown			5452DW*	130148-0106
Brown, heavy-duty			5462DW*	130148-0107
Yellow, heavy-duty corrosion resistant			5462DWCR*	130148-0108

* Not CSA listed

Find adapters and technical support at the end of this section

Industrial Duty Wiring Devices Straight Blade 20A 250V 2-Pole/3-Wire NEMA 6-20

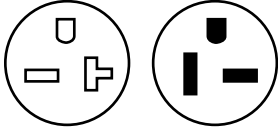

Features and Benefits

- NEōTEX® Paracril OZO rubber body yields the best performance for abrasion, chemical exposure and temperature extremes within the Super-Safeway™ offering
- Rugged nylon bodies within the Safeway® offering provide exceptional durability and performance
- Color-coded ¼" terminal screws pre-set in open position, ready to wire
- Wire screw terminals are tri-drive to be used with straight blade, Phillips and square-drive screw drivers
- Floating blade construction provides self-alignment, and a better mechanical and electrical connection minimizing wear and heat generation
- Transparent wiring guide to verify all wire strands are in place before securing wire
- Captive, tri-drive head, Stainless Steel, speed screw provides easy assembly and long life
- Two-piece cord-clamp strain relief includes tri-drive screws to firmly secure the cord

Reference Information

UL File No.: 38085
Y Non-Inline GFCI Cordset—E38085
CSA File No.: LR6837
Y Non-Inline GFCI Cordset—LL52750



Physical

Plug blades and connector contacts: Nickel-plated Brass
Super-Safeway Outer Housing: NEōTEX Paracril OZO rubber
Safeway Outer Housing: Nylon
Face Screws: Stainless Steel
Face Insert: Nylon
Wire Saddle Clamp: Brass
Cord Clamp Screws: Steel, Zinc-plated

Environmental

Operating Temperature: Maximum continuous 75° C, minimum -40° C (no impact)
Temperature Rise: Maximum 30° C temperature rise at full rated current after 50 cycles of overload at 150% of rated current at a power factor of 75%.



Super-Safeway Industrial Rubber Cordset

Description	Cord Length	Woodhead No.	Order No.
Yellow 14 gauge SOOW cord	7.62m (25.0')	1448A143	130143-0115



Super-Safeway Industrial Rubber Molded Y Cordset

Description	Cord Length	Y-Cordset	
		Woodhead No.	Order No.
Yellow 12 gauge SOOW cord	0.91m (3.0')	1448-Y	130154-0041

Find adapters and technical support at the end of this section

Industrial Duty Wiring Devices Straight Blade 15A 125V 10A 250V 3-Pole/3-Wire Non-NEMA

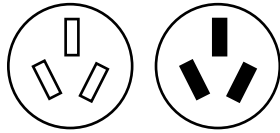

Super-Safeway Industrial Rubber Plug and Connector

Description	Plug		Connector	
	Woodhead No.	Order No.	Woodhead No.	Order No.
Yellow rubber	1407	130141-0007	1507	130141-0024

Features and Benefits

- NEoTEX® Paracril OZO rubber body yields the best performance for abrasion, chemical exposure and temperature extremes within the Super-Safeway™ offering
- Rugged nylon bodies within the Safeway® offering provide exceptional durability and performance
- Color-coded ¼" terminal screws pre-set in open position, ready to wire
- Wire screw terminals are tri-drive to be used with straight blade, Phillips and square-drive screw drivers
- Floating blade construction provides self-alignment, and a better mechanical and electrical connection minimizing wear and heat generation
- Transparent wiring guide to verify all wire strands are in place before securing wire
- Captive, tri-drive head, Stainless Steel, speed screw provides easy assembly and long life
- Two-piece cord-clamp strain relief includes tri-drive screws to firmly secure the cord

Physical

Plug blades and connector contacts: Nickel-plated Brass
Super-Safeway™ Outer Housing: NEoTEX Paracril OZO rubber
Face Screws: Stainless Steel
Face Insert: Nylon
Wire Saddle Clamp: Brass
Cord Clamp Screws: Steel, Zinc-plated
Plug/Connector Range: .335 to .640"

Environmental

Operating Temperature: Maximum continuous 75° C, minimum -40° C (no impact)
Temperature Rise: Maximum 30° C temperature rise at full rated current after 50 cycles of overload at 150% of rated current at a power factor of 75%.

Industrial Duty Wiring Devices Straight Blade 50A 250V 2-Pole/3-Wire NEMA 6-50

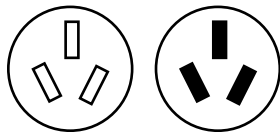

Super-Safeway Industrial Rubber Plug and Connector

Description	Plug		Connector	
	Woodhead No.	Order No.	Woodhead No.	Order No.
Yellow rubber	8664	130142-0051	8665	130142-0052

Find adapters and technical support at the end of this section

Features and Benefits

- NEoTEX® Paracril OZO rubber body yields the best performance for abrasion, chemical exposure and temperature extremes within the Super-Safeway™ offering
- Rugged nylon bodies within the Safeway® offering provide exceptional durability and performance
- Color-coded ¼" terminal screws pre-set in open position, ready to wire
- Wire screw terminals are tri-drive to be used with straight blade, Phillips and square-drive screw drivers
- Floating blade construction provides self-alignment, and a better mechanical and electrical connection minimizing wear and heat generation
- Transparent wiring guide to verify all wire strands are in place before securing wire
- Captive, tri-drive head, Stainless Steel, speed screw provides easy assembly and long life
- Two-piece cord-clamp strain relief includes tri-drive screws to firmly secure the cord

Physical

Plug blades and connector contacts: Nickel-plated Brass
Super-Safeway™ Outer Housing: NEoTEX Paracril OZO rubber
Face Screws: Stainless Steel
Face Insert: Nylon
Wire Saddle Clamp: Brass
Cord Clamp Screws: Steel, Zinc-plated

Environmental

Operating Temperature: Maximum continuous 75° C, minimum -40° C (no impact)
Temperature Rise: Maximum 30° C temperature rise at full rated current after 50 cycles of overload at 150% of rated current at a power factor of 75%.

Industrial Duty Wiring Devices Locking Blade 15A 125V 2-Pole/2-Wire NEMA L1-15

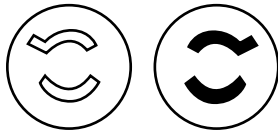

Features and Benefits

- NEoTEX® Paracril OZO rubber body yields the best performance for abrasion, chemical exposure and temperature extremes within the Super-Safeway™ offering
- Rugged nylon bodies within the Safeway® offering provide exceptional durability and performance
- Color-coded ¼" terminal screws pre-set in open position, ready to wire
- Wire screw terminals are tri-drive to be used with straight blade, Phillips and square-drive screw drivers
- Floating blade construction provides self-alignment, and a better mechanical and electrical connection minimizing wear and heat generation
- Transparent wiring guide to verify all wire strands are in place before securing wire
- Captive, tri-drive head, Stainless Steel, speed screw provides easy assembly and long life
- Two-piece cord-clamp strain relief includes tri-drive screws to firmly secure the cord

Reference Information

UL File No.: Plug and Connector—E10176
CSA File No.: LR6837



Physical

Plug blades and connector contacts: Nickel-plated Brass
Super-Safeway Outer Housing: NEoTEX Paracril OZO rubber

Safeway Outer Housing: Nylon

Face Screws: Stainless Steel

Face Insert: Nylon

Wire Saddle Clamp: Brass

Cord Clamp Screws: Steel, Zinc-plated

Plug/Connector Range: .335 to .640"

Environmental

Operating Temperature: Maximum continuous 75° C, minimum -40° C (no impact)

Temperature Rise: Maximum 30° C temperature rise at full rated current after 50 cycles of overload at 150% of rated current at a power factor of 75%.



Super-Safeway Industrial Rubber Plug and Connector

Description	Plug		Connector	
	Woodhead No.	Order No.	Woodhead No.	Order No.
Yellow rubber	2404	130141-0043	2504	130141-0052



Safeway Industrial Nylon Plug and Connector

Description	Plug		Connector	
	Woodhead No.	Order No.	Woodhead No.	Order No.
Black and White	24T04	130144-0017	25T04	130144-0019



Safeway Receptacle and Inlet

Description	Single Receptacle		Single Male	
	Woodhead No.	Order No.	Woodhead No.	Order No.
White, flanged	2504MB	130149-0018	2404MB	130143-0014

Find adapters and technical support at the end of this section

Industrial Duty Wiring Devices Locking Blade 20A 250V 2-Pole/2-Wire NEMA L2-20

Wiring Devices

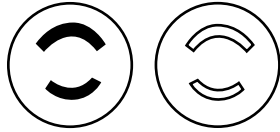

Features and Benefits

- NEoTEX® Paracril OZO rubber body yields the best performance for abrasion, chemical exposure and temperature extremes within the Super-Safeway™ offering
- Rugged nylon bodies within the Safeway® offering provide exceptional durability and performance
- Color-coded ¼" terminal screws pre-set in open position, ready to wire
- Wire screw terminals are tri-drive to be used with straight blade, Phillips and square-drive screw drivers
- Floating blade construction provides self-alignment, and a better mechanical and electrical connection minimizing wear and heat generation
- Transparent wiring guide to verify all wire strands are in place before securing wire
- Captive, tri-drive head, Stainless Steel, speed screw provides easy assembly and long life
- Two-piece cord-clamp strain relief includes tri-drive screws to firmly secure the cord

Reference Information

UL File No.: E10176
CSA File No.: LR6837



Physical

Plug blades and connector contacts: Nickel-plated Brass
Super-Safeway Outer Housing: NEoTEX Paracril OZO rubber

Safeway Outer Housing: Nylon

Face Screws: Stainless Steel

Face Insert: Nylon

Wire Saddle Clamp: Brass

Cord Clamp Screws: Steel, Zinc-plated

Plug/Connector Range: .325 to .840"

Environmental

Operating Temperature: Maximum continuous 75° C, minimum -40° C (no impact)

Temperature Rise: Maximum 30° C temperature rise at full rated current after 50 cycles of overload at 150% of rated current at a power factor of 75%.



Super-Safeway Industrial Rubber Plug and Connector

Description	Plug		Connector	
	Woodhead No.	Order No.	Woodhead No.	Order No.
Yellow rubber	2607	130141-0061	2707	130141-0065



Safeway Industrial Nylon Plug and Connector

Description	Plug		Connector	
	Woodhead No.	Order No.	Woodhead No.	Order No.
Black and white	26T07	130144-0021	27T07	130144-0022

Find adapters and technical support at the end of this section

Industrial Duty Wiring Devices Locking Blade 15A 125V 2-Pole/3-Wire NEMA L5-15

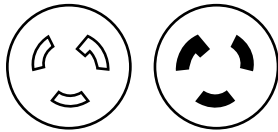

Features and Benefits

- NEōTEX® Paracril OZO rubber body yields the best performance for abrasion, chemical exposure and temperature extremes within the Super-Safeway™ offering
- Rugged nylon bodies within the Safeway® offering provide exceptional durability and performance
- Color-coded ¼" terminal screws pre-set in open position, ready to wire
- Wire screw terminals are tri-drive to be used with straight blade, Phillips and square-drive screw drivers
- Floating blade construction provides self-alignment, and a better mechanical and electrical connection minimizing wear and heat generation
- Transparent wiring guide to verify all wire strands are in place before securing wire
- Captive, tri-drive head, Stainless Steel, speed screw provides easy assembly and long life
- Two-piece cord-clamp strain relief includes tri-drive screws to firmly secure the cord

Reference Information

UL File No.: Plug and Connector—E10176

Receptacle—E46237

CSA File No.: LR6837



Physical

Plug blades and connector contacts: Nickel-plated Brass
Super-Safeway Outer Housing: NEōTEX Paracril OZO rubber

Safeway Outer Housing: Nylon

Face Screws: Stainless Steel

Face Insert: Nylon

Wire Saddle Clamp: Brass

Cord Clamp Screws: Steel, Zinc-plated

Plug/Connector Range: .335 to .640"

Environmental

Operating Temperature: Maximum continuous 75° C, minimum -40° C (no impact)

Temperature Rise: Maximum 30° C temperature rise at full rated current after 50 cycles of overload at 150% of rated current at a power factor of 75%.



Super-Safeway Industrial Rubber Plug and Connector

Description	Plug		Connector		Lighted Plug		Lighted Connector	
	Woodhead No.	Order No.	Woodhead No.	Order No.	Woodhead No.*	Order No.	Woodhead No.*	Order No.
Yellow rubber	2447	130141-0047	2547	130141-0056				
Yellow rubber ground continuity monitor					2447EZ	130141-0048	2547GCM	130141-0057

* Ground continuity monitor lights indicating a good ground is present



Safeway Industrial Nylon Plug and Connector

Description	Plug		Connector	
	Woodhead No.	Order No.	Woodhead No.	Order No.
Black and white	4720	130144-0023	4729	130144-0025
Yellow and white	4720YL	130144-0024	4729YL	130144-0026



Safeway Receptacle and Inlet

Description	Single Receptacle		Duplex Receptacle		Single Male Inlet	
	Woodhead No.	Order No.	Woodhead No.	Order No.	Woodhead No.	Order No.
White, flanged	2547MB	130149-0021			2447MB	130149-0016
Brown, heavy-duty			4700DW ¹	130148-0074		

¹ Not UL/CSA listed

Find adapters and technical support at the end of this section

Industrial Duty Wiring Devices Locking Blade 15A 125V 2-Pole/3-Wire NEMA L5-15

D
Wiring Devices

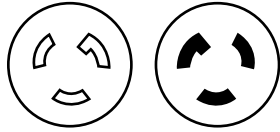

Features and Benefits

- NEoTEX® Paracril OZO rubber body yields the best performance for abrasion, chemical exposure and temperature extremes within the Super-Safeway™ offering
- Rugged nylon bodies within the Safeway® offering provide exceptional durability and performance
- Color-coded ¼" terminal screws pre-set in open position, ready to wire
- Wire screw terminals are tri-drive to be used with straight blade, Phillips and square-drive screw drivers
- Floating blade construction provides self-alignment, and a better mechanical and electrical connection minimizing wear and heat generation
- Transparent wiring guide to verify all wire strands are in place before securing wire
- Captive, tri-drive head, Stainless Steel, speed screw provides easy assembly and long life
- Two-piece cord-clamp strain relief includes tri-drive screws to firmly secure the cord

Reference Information

UL File No.: E38085

Y and W Non-Inline GFCI Cordset—E38085

CSA File No.: LR6837

Y and W Non-Inline GFCI Cordset—LL52750



Physical

Plug blades and connector contacts: Nickel-plated Brass
Super-Safeway Outer Housing: NEoTEX Paracril OZO rubber

Safeway Outer Housing: Nylon

Face Screws: Stainless Steel

Face Insert: Nylon

Wire Saddle Clamp: Brass

Cord Clamp Screws: Steel, Zinc-plated

Environmental

Operating Temperature: Maximum continuous 75° C, minimum -40° C (no impact)

Temperature Rise: Maximum 30° C temperature rise at full rated current after 50 cycles of overload at 150% of rated current at a power factor of 75%.



Super-Safeway Industrial Rubber Cordset

Description	Cord Length	Woodhead No.	Order No.
Yellow 16 gauge SOOW cord	7.62m (25.0')	2447A163	130143-0174
Yellow 14 gauge SOOW Cord	15.2m (50.0')	2447B143	130143-0176
	30.5m (100.0')	2447D143	130143-0178



Super-Safeway Industrial Rubber Molded Y and W Cordset

Description	Cord Length	Y-Cordset		W-Cordset	
		Woodhead No.	Order No.	Woodhead No.	Order No.
Yellow 12 gauge SOOW cord	0.91m (3.0')	2447-Y	130154-0056	2447-W	130154-0055

Find adapters and technical support at the end of this section

Industrial Duty Wiring Devices Locking Blade 15A 250V 2-Pole/3-Wire NEMA L6-15

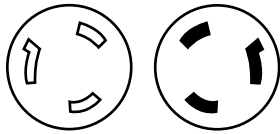

Features and Benefits

- NEōTEX® Paracril OZO rubber body yields the best performance for abrasion, chemical exposure and temperature extremes within the Super-Safeway™ offering
- Rugged nylon bodies within the Safeway® offering provide exceptional durability and performance
- Color-coded ¼" terminal screws pre-set in open position, ready to wire
- Wire screw terminals are tri-drive to be used with straight blade, Phillips and square-drive screw drivers
- Floating blade construction provides self-alignment, and a better mechanical and electrical connection minimizing wear and heat generation
- Transparent wiring guide to verify all wire strands are in place before securing wire
- Captive, tri-drive head, Stainless Steel, speed screw provides easy assembly and long life
- Two-piece cord-clamp strain relief includes tri-drive screws to firmly secure the cord

Reference Information

UL File No.: E10176
CSA File No.: LR6837



Physical

Plug blades and connector contacts: Nickel-plated Brass
Super-Safeway Outer Housing: NEōTEX Paracril OZO rubber

Safeway Outer Housing: Nylon
Face Screws: Stainless Steel
Face Insert: Nylon
Wire Saddle Clamp: Brass
Cord Clamp Screws: Steel, Zinc-plated
Plug/Connector Range: .335 to .640"

Environmental

Operating Temperature: Maximum continuous 75° C, minimum -40° C (no impact)
Temperature Rise: Maximum 30° C temperature rise at full rated current after 50 cycles of overload at 150% of rated current at a power factor of 75%.



Super-Safeway Industrial Rubber Plug and Connector

Description	Plug		Connector	
	Woodhead No.	Order No.	Woodhead No.	Order No.
Yellow rubber	2449	130141-0051	2549	130141-0060



Safeway Receptacle and Inlet

Description	Single Receptacle		Single Male Inlet	
	Woodhead No.	Order No.	Woodhead No.	Order No.
White, flanged	2549MB	130149-0022	2449MB	130149-0017

Find adapters and technical support at the end of this section

Industrial Duty Wiring Devices Locking Blade 15A 277V 2-Pole/3-Wire NEMA L7-15

Wiring Devices

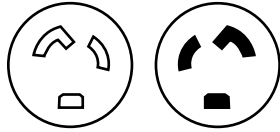

Features and Benefits

- NEoTEX® Paracril OZO rubber body yields the best performance for abrasion, chemical exposure and temperature extremes within the Super-Safeway™ offering
- Rugged nylon bodies within the Safeway® offering provide exceptional durability and performance
- Color-coded ¼" terminal screws pre-set in open position, ready to wire
- Wire screw terminals are tri-drive to be used with straight blade, Phillips and square-drive screw drivers
- Floating blade construction provides self-alignment, and a better mechanical and electrical connection minimizing wear and heat generation
- Transparent wiring guide to verify all wire strands are in place before securing wire
- Captive, tri-drive head, Stainless Steel, speed screw provides easy assembly and long life
- Two-piece cord-clamp strain relief includes tri-drive screws to firmly secure the cord

Reference Information

UL File No.: E10176
CSA File No.: LR6837



Physical

Plug blades and connector contacts: Nickel-plated Brass
Super-Safeway Outer Housing: NEoTEX Paracril OZO rubber

Safeway Outer Housing: Nylon

Face Screws: Stainless Steel

Face Insert: Nylon

Wire Saddle Clamp: Brass

Cord Clamp Screws: Steel, Zinc-plated

Plug/Connector Range: .335 to .640"

Environmental

Operating Temperature: Maximum continuous 75° C, minimum -40° C (no impact)

Temperature Rise: Maximum 30° C temperature rise at full rated current after 50 cycles of overload at 150% of rated current at a power factor of 75%.



Super-Safeway Industrial Rubber Plug and Connector

Description	Plug		Connector	
	Woodhead No.	Order No.	Woodhead No.	Order No.
Yellow rubber	2434	130141-0045	2534	130141-0054



Safeway Industrial Nylon Plug and Connector

Description	Plug		Connector	
	Woodhead No.	Order No.	Woodhead No.	Order No.
Black and white	4770	130144-0031	4779	130144-0033



Safeway Receptacle and Inlet

Description	Single Receptacle	
	Woodhead No.	Order No.
White, flanged	2534MB	130149-0020

Find adapters and technical support at the end of this section

Industrial Duty Wiring Devices Locking Blade 20A 125V 2-Pole/3-Wire NEMA L5-20

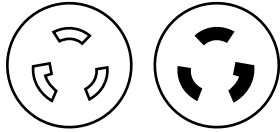

Features and Benefits

- NEōTEX® Paracril OZO rubber body yields the best performance for abrasion, chemical exposure and temperature extremes within the Super-Safeway™ offering
- Rugged nylon bodies within the Safeway® offering provide exceptional durability and performance
- Color-coded ¼" terminal screws pre-set in open position, ready to wire
- Wire screw terminals are tri-drive to be used with straight blade, Phillips and square-drive screw drivers
- Floating blade construction provides self-alignment, and a better mechanical and electrical connection minimizing wear and heat generation
- Transparent wiring guide to verify all wire strands are in place before securing wire
- Captive, tri-drive head, Stainless Steel, speed screw provides easy assembly and long life
- Two-piece cord-clamp strain relief includes tri-drive screws to firmly secure the cord

Reference Information

UL File No.: Plug and Connector—E10176

Receptacle—E68122

CSA File No.: LR6837



Physical

Plug blades and connector contacts: Nickel-plated Brass
Super-Safeway Outer Housing: NEōTEX Paracril OZO rubber

Safeway Outer Housing: Nylon

Face Screws: Stainless Steel

Face Insert: Nylon

Wire Saddle Clamp: Brass

Cord Clamp Screws: Steel, Zinc-plated

Plug/Connector Range: .335 to .640"

Environmental

Operating Temperature: Maximum continuous 75° C,
minimum -40° C (no impact)

Temperature Rise: Maximum 30° C temperature rise at full rated current after 50 cycles of overload at 150% of rated current at a power factor of 75%.



Super-Safeway Industrial Rubber Plug and Connector

Description	Plug		Connector	
	Woodhead No.	Order No.	Woodhead No.	Order No.
Yellow rubber	2647	130141-0062	2747	130142-0021



Safeway Industrial Nylon Plug and Connector

Description	Plug		Connector	
	Woodhead No.	Order No.	Woodhead No.	Order No.
Black and white	26T47	130145-0008	27T47	130145-0030
Yellow and white	26T47YL	130145-0010	27T47YL	130145-0031



Safeway Receptacle and Inlet

Description	Single Receptacle		Single Male Inlet	
	Woodhead No.	Order No.	Woodhead No.	Order No.
White, flanged	2747MB	130149-0039	2647MB	130149-0027
Black, heavy-duty	4747	130149-0066		
Yellow, heavy-duty corrosion resistant	4747CR	130149-0067		

Find adapters and technical support at the end of this section

Industrial Duty Wiring Devices Locking Blade 20A 125V 2-Pole/3-Wire NEMA L5-20

Wiring Devices

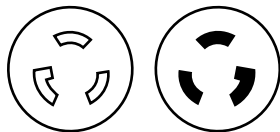

Features and Benefits

- NEoTEX® Paracril OZO rubber body yields the best performance for abrasion, chemical exposure and temperature extremes within the Super-Safeway™ offering
- Rugged nylon bodies within the Safeway® offering provide exceptional durability and performance
- Color-coded ¼" terminal screws pre-set in open position, ready to wire
- Wire screw terminals are tri-drive to be used with straight blade, Phillips and square-drive screw drivers
- Floating blade construction provides self-alignment, and a better mechanical and electrical connection minimizing wear and heat generation
- Transparent wiring guide to verify all wire strands are in place before securing wire
- Captive, tri-drive head, Stainless Steel, speed screw provides easy assembly and long life
- Two-piece cord-clamp strain relief includes tri-drive screws to firmly secure the cord

Reference Information

UL File No.: E38085
CSA File No.: LR6837



Physical

Plug blades and connector contacts: Nickel-plated Brass
Super-Safeway Outer Housing: NEoTEX Paracril OZO rubber
Safeway Outer Housing: Nylon
Face Screws: Stainless Steel
Face Insert: Nylon
Wire Saddle Clamp: Brass
Cord Clamp Screws: Steel, Zinc-plated

Environmental

Operating Temperature: Maximum continuous 75° C, minimum -40° C (no impact)
Temperature Rise: Maximum 30° C temperature rise at full rated current after 50 cycles of overload at 150% of rated current at a power factor of 75%.



Super-Safeway Industrial Rubber Cordset

Description	Cord Length	Woodhead No.	Order No.
Yellow 14 gauge 500W cord	7.62m (25.0')	2647A143	130143-0204
	15.2m (50.0')	2647B143	130143-0207
Yellow 12 gauge 500W cord	7.62m (25.0')	2647A123	130143-0203
	15.2m (50.0')	2647B123	130143-0205
	30.5m (100.0')	2647D123	130143-0209



Super-Safeway Industrial Rubber Cordset with Inline GFCI

Description	Cord Length	Woodhead No.	Order No.
Yellow 12 gauge SJOW cord with inline GFCI	.305m (1.0')	2647E123IN	130143-0210

Find adapters and technical support at the end of this section

**Industrial Duty
Wiring Devices
Locking Blade
20A 125V
2-Pole/3-Wire
NEMA L5-20**

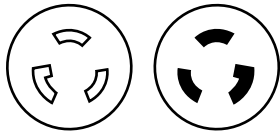

Features and Benefits

- NEōTEX® Paracril OZO rubber body yields the best performance for abrasion, chemical exposure and temperature extremes within the Super-Safeway™ offering
- Rugged nylon bodies within the Safeway® offering provide exceptional durability and performance
- Color-coded ¼" terminal screws pre-set in open position, ready to wire
- Wire screw terminals are tri-drive to be used with straight blade, Phillips and square-drive screw drivers
- Floating blade construction provides self-alignment, and a better mechanical and electrical connection minimizing wear and heat generation
- Transparent wiring guide to verify all wire strands are in place before securing wire
- Captive, tri-drive head, Stainless Steel, speed screw provides easy assembly and long life
- Two-piece cord-clamp strain relief includes tri-drive screws to firmly secure the cord

Reference Information

UL File No.: E38085
Y and W Non-Inline GFCI Cordset—E38085
CSA File No.: LR6837
Y and W Non-Inline GFCI Cordset—LL52750



Physical

Plug blades and connector contacts: Nickel-plated Brass
Super-Safeway Outer Housing: NEōTEX Paracril OZO rubber
Safeway Outer Housing: Nylon
Face Screws: Stainless Steel
Face Insert: Nylon
Wire Saddle Clamp: Brass
Cord Clamp Screws: Steel, Zinc-plated

Environmental

Operating Temperature: Maximum continuous 75° C, minimum -40° C (no impact)
Temperature Rise: Maximum 30° C temperature rise at full rated current after 50 cycles of overload at 150% of rated current at a power factor of 75%.



Super-Safeway Industrial Rubber Molded Y and W Cordset

Description	Cord Length	Y-Cordset		W-Cordset	
		Woodhead No.	Order No.	Woodhead No.	Order No.
Yellow 12 gauge 500W cord	0.91m (3.0')	2647-Y	130154-0064	2647-W	130154-0062



Super-Safeway Industrial Rubber Molded Y and W Cordset with Inline GFCI

Description	Cord Length	Y-Cordset		W-Cordset	
		Woodhead No.	Order No.	Woodhead No.	Order No.
Yellow 12 gauge SJOW cord with inline GFCI	0.91m (3.0')	2647-Y-IN	130154-0065	2647-W-IN	130154-0063

Find adapters and technical support at the end of this section

Industrial Duty Wiring Devices Locking Blade 20A 250V 2-Pole/3-Wire NEMA L6-20

Wiring Devices

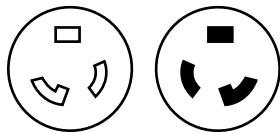

Features and Benefits

- NEoTEX® Paracril OZO rubber body yields the best performance for abrasion, chemical exposure and temperature extremes within the Super-Safeway™ offering
- Rugged nylon bodies within the Safeway® offering provide exceptional durability and performance
- Color-coded ¼" terminal screws pre-set in open position, ready to wire
- Wire screw terminals are tri-drive to be used with straight blade, Phillips and square-drive screw drivers
- Floating blade construction provides self-alignment, and a better mechanical and electrical connection minimizing wear and heat generation
- Transparent wiring guide to verify all wire strands are in place before securing wire
- Captive, tri-drive head, Stainless Steel, speed screw provides easy assembly and long life
- Two-piece cord-clamp strain relief includes tri-drive screws to firmly secure the cord

Reference Information

UL File No.: Plug and Connector—E10176

Receptacle—E46237

CSA File No.: LR6837



Physical

Plug blades and connector contacts: Nickel-plated Brass
Super-Safeway Outer Housing: NEoTEX Paracril OZO rubber

Safeway Outer Housing: Nylon

Face Screws: Stainless Steel

Face Insert: Nylon

Wire Saddle Clamp: Brass

Cord Clamp Screws: Steel, Zinc-plated

Plug/Connector Range: .325 to .840"

Environmental

Operating Temperature: Maximum continuous 75° C, minimum -40° C (no impact)

Temperature Rise: Maximum 30° C temperature rise at full rated current after 50 cycles of overload at 150% of rated current at a power factor of 75%.



Super-Safeway Industrial Rubber Plug and Connector

Description	Plug		Connector	
	Woodhead No.	Order No.	Woodhead No.	Order No.
Yellow rubber	2648	130141-0063	2748	130141-0066



Safeway Industrial Nylon Plug and Connector

Description	Plug		Connector	
	Woodhead No.	Order No.	Woodhead No.	Order No.
Black and white	26T48	130145-0011	27T48	130145-0032
Yellow and white	26T48YL	130145-0012	27T48YL	130145-0033



Safeway Receptacle and Inlet

Description	Single Receptacle		Single Male Inlet	
	Woodhead No.	Order No.	Woodhead No.	Order No.
White, flanged	2748MB	130149-0040	2648MB	130149-0028
Black, heavy-duty	4748	130149-0068		
Yellow, heavy-duty corrosion resistant	4748CR	130149-0069		

Find adapters and technical support at the end of this section

**Industrial Duty
Wiring Devices
Locking Blade
20A 250V
2-Pole/3-Wire
NEMA L6-20**

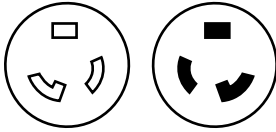

Features and Benefits

- NEöTEX® Paracril OZO rubber body yields the best performance for abrasion, chemical exposure and temperature extremes within the Super-Safeway™ offering
- Rugged nylon bodies within the Safeway® offering provide exceptional durability and performance
- Color-coded ¼" terminal screws pre-set in open position, ready to wire
- Wire screw terminals are tri-drive to be used with straight blade, Phillips and square-drive screw drivers
- Floating blade construction provides self-alignment, and a better mechanical and electrical connection minimizing wear and heat generation
- Transparent wiring guide to verify all wire strands are in place before securing wire
- Captive, tri-drive head, Stainless Steel, speed screw provides easy assembly and long life
- Two-piece cord-clamp strain relief includes tri-drive screws to firmly secure the cord

Reference Information

UL File No.: E38085
CSA File No.: LR6837



Physical

Plug blades and connector contacts: Nickel-plated Brass
Super-Safeway Outer Housing: NEöTEX Paracril OZO rubber
Safeway Outer Housing: Nylon
Face Screws: Stainless Steel
Face Insert: Nylon
Wire Saddle Clamp: Brass
Cord Clamp Screws: Steel, Zinc-plated

Environmental

Operating Temperature: Maximum continuous 75° C, minimum -40° C (no impact)
Temperature Rise: Maximum 30° C temperature rise at full rated current after 50 cycles of overload at 150% of rated current at a power factor of 75%.



Super-Safeway Industrial Rubber Cordset

Description	Cord Length	Woodhead No.	Order No.
Yellow 14 gauge SOOW cord	7.62m (25.0')	2648A143	130143-0212
Yellow 12 gauge SOOW cord	7.62m (25.0')	2648A123	130143-0211

Find adapters and technical support at the end of this section

Industrial Duty Wiring Devices Locking Blade 20A 277V 2-Pole/3-Wire NEMA L7-20

D
Wiring Devices

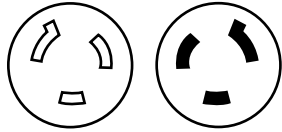

Features and Benefits

- NEoTEX® Paracril OZO rubber body yields the best performance for abrasion, chemical exposure and temperature extremes within the Super-Safeway™ offering
- Rugged nylon bodies within the Safeway® offering provide exceptional durability and performance
- Color-coded ¼" terminal screws pre-set in open position, ready to wire
- Wire screw terminals are tri-drive to be used with straight blade, Phillips and square-drive screw drivers
- Floating blade construction provides self-alignment, and a better mechanical and electrical connection minimizing wear and heat generation
- Transparent wiring guide to verify all wire strands are in place before securing wire
- Captive, tri-drive head, Stainless Steel, speed screw provides easy assembly and long life
- Two-piece cord-clamp strain relief includes tri-drive screws to firmly secure the cord

Reference Information

UL File No.: E10176
CSA File No.: LR6837



Physical

Plug blades and connector contacts: Nickel-plated Brass
Super-Safeway Outer Housing: NEoTEX Paracril OZO rubber

Safeway Outer Housing: Nylon

Face Screws: Stainless Steel

Face Insert: Nylon

Wire Saddle Clamp: Brass

Cord Clamp Screws: Steel, Zinc-plated

Plug/Connector Range: .325 to .840"

Environmental

Operating Temperature: Maximum continuous 75° C, minimum -40° C (no impact)

Temperature Rise: Maximum 30° C temperature rise at full rated current after 50 cycles of overload at 150% of rated current at a power factor of 75%.



Super-Safeway Industrial Rubber Plug and Connector

Description	Plug		Connector	
	Woodhead No.	Order No.	Woodhead No.	Order No.
Yellow rubber	2649	130141-0064	2749	130142-0023



Safeway Industrial Nylon Plug and Connector

Description	Plug		Connector	
	Woodhead No.	Order No.	Woodhead No.	Order No.
Black and white	26749	130145-0013	27749	130145-0034



Safeway Receptacle and Inlet

Description	Single Receptacle	
	Woodhead No.	Order No.
Black, heavy-duty	4749	130149-0070
White, flanged	2749MB	130149-0041

Find adapters and technical support at the end of this section

Industrial Duty Wiring Devices Locking Blade 30A 125V 2-Pole/3-Wire NEMA L5-30

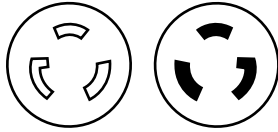

Features and Benefits

- NEoTEX® Paracril OZO rubber body yields the best performance for abrasion, chemical exposure and temperature extremes within the Super-Safeway™ offering
- Rugged nylon bodies within the Safeway® offering provide exceptional durability and performance
- Color-coded ¼" terminal screws pre-set in open position, ready to wire
- Wire screw terminals are tri-drive to be used with straight blade, Phillips and square-drive screw drivers
- Floating blade construction provides self-alignment, and a better mechanical and electrical connection minimizing wear and heat generation
- Transparent wiring guide to verify all wire strands are in place before securing wire
- Captive, tri-drive head, Stainless Steel, speed screw provides easy assembly and long life
- Two-piece cord-clamp strain relief includes tri-drive screws to firmly secure the cord

Reference Information

UL File No.: E38085
CSA File No.: LR6837



Physical

Plug blades and connector contacts: Nickel-plated Brass
Super-Safeway Outer Housing: NEoTEX Paracril OZO rubber

Safeway Outer Housing: Nylon
Face Screws: Stainless Steel
Face Insert: Nylon
Wire Saddle Clamp: Brass
Cord Clamp Screws: Steel, Zinc-plated
Plug/Connector Range: .325 to .840"

Environmental

Operating Temperature: Maximum continuous 75° C, minimum -40° C (no impact)
Temperature Rise: Maximum 30° C temperature rise at full rated current after 50 cycles of overload at 150% of rated current at a power factor of 75%.



Super-Safeway Industrial Rubber Plug and Connector

Description	Plug		Connector	
	Woodhead No.	Order No.	Woodhead No.	Order No.
Yellow rubber	2847	130142-0033	2947	130141-0067



Safeway Industrial Nylon Plug and Connector

Description	Plug		Connector	
	Woodhead No.	Order No.	Woodhead No.	Order No.
Black and white	28T47	130145-0048	29T47	130145-0071



Super-Safeway Industrial Rubber Cordset

Description	Cord Length	Woodhead No.	Order No.
Yellow 12 gauge SOOW cord	7.62m (25.0')	2847A123	130143-0252

Find adapters and technical support at the end of this section

Industrial Duty Wiring Devices Locking Blade 30A 250V 2-Pole/3-Wire NEMA L6-30

Wiring Devices

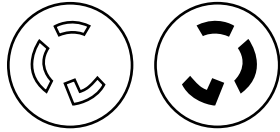

Features and Benefits

- NEoTEX® Paracril OZO rubber body yields the best performance for abrasion, chemical exposure and temperature extremes within the Super-Safeway™ offering
- Rugged nylon bodies within the Safeway® offering provide exceptional durability and performance
- Color-coded ¼" terminal screws pre-set in open position, ready to wire
- Wire screw terminals are tri-drive to be used with straight blade, Phillips and square-drive screw drivers
- Floating blade construction provides self-alignment, and a better mechanical and electrical connection minimizing wear and heat generation
- Transparent wiring guide to verify all wire strands are in place before securing wire
- Captive, tri-drive head, Stainless Steel, speed screw provides easy assembly and long life
- Two-piece cord-clamp strain relief includes tri-drive screws to firmly secure the cord

Reference Information

UL File No.: E10176
CSA File No.: LR6837



Physical

Plug blades and connector contacts: Nickel-plated Brass
Super-Safeway Outer Housing: NEoTEX Paracril OZO rubber

Safeway Outer Housing: Nylon

Face Screws: Stainless Steel

Face Insert: Nylon

Wire Saddle Clamp: Brass

Cord Clamp Screws: Steel, Zinc-plated

Plug/Connector Range: .425 to 1.150"

Environmental

Operating Temperature: Maximum continuous 75° C, minimum -40° C (no impact)

Temperature Rise: Maximum 30° C temperature rise at full rated current after 50 cycles of overload at 150% of rated current at a power factor of 75%.



Super-Safeway Industrial Rubber Plug and Connector

Description	Plug		Connector	
	Woodhead No.	Order No.	Woodhead No.	Order No.
Yellow rubber	2848	130142-0034	2948	130141-0068



Safeway Industrial Nylon Plug and Connector

Description	Plug		Connector	
	Woodhead No.	Order No.	Woodhead No.	Order No.
Black and white	28T48	130145-0050	29T48	130145-0072

Find adapters and technical support at the end of this section

Industrial Duty Wiring Devices Locking Blade 30A 250V 2-Pole/3-Wire NEMA L6-30

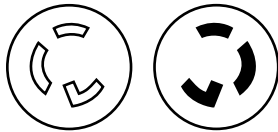

Features and Benefits

- NEōTEX® Paracril OZO rubber body yields the best performance for abrasion, chemical exposure and temperature extremes within the Super-Safeway™ offering
- Rugged nylon bodies within the Safeway® offering provide exceptional durability and performance
- Color-coded ¼" terminal screws pre-set in open position, ready to wire
- Wire screw terminals are tri-drive to be used with straight blade, Phillips and square-drive screw drivers
- Floating blade construction provides self-alignment, and a better mechanical and electrical connection minimizing wear and heat generation
- Transparent wiring guide to verify all wire strands are in place before securing wire
- Captive, tri-drive head, Stainless Steel, speed screw provides easy assembly and long life
- Two-piece cord-clamp strain relief includes tri-drive screws to firmly secure the cord

Reference Information

UL File No.: E38085
Y Non-Inline GFCI Cordset—E38085
CSA File No.: LR6837
Y Non-Inline GFCI Cordset—LL52750



Physical

Plug blades and connector contacts: Nickel-plated Brass
Super-Safeway Outer Housing: NEōTEX Paracril OZO rubber
Safeway Outer Housing: Nylon
Face Screws: Stainless Steel
Face Insert: Nylon
Wire Saddle Clamp: Brass
Cord Clamp Screws: Steel, Zinc-plated

Environmental

Operating Temperature: Maximum continuous 75° C, minimum -40° C (no impact)
Temperature Rise: Maximum 30° C temperature rise at full rated current after 50 cycles of overload at 150% of rated current at a power factor of 75%.

D

Wiring Devices



Super-Safeway Industrial Rubber Cordset

Description	Cord Length	Woodhead No.	Order No.
Yellow 12 gauge 500W cord	7.62m (25.0')	2848A123	130143-0255
Yellow, 10 Gauge 500W Cord	7.62m (25.0')	2848A103	130143-0254
	15.2m (50.0')	2848B103	130143-0312



Super-Safeway Industrial Rubber Molded Y Cordset

Description	Cord Length	Y-Cordset	
		Woodhead No.	Order No.
Yellow 12 gauge 500W cord	0.91m (3.0')	2848-Y	130154-0073

Find adapters and technical support at the end of this section

Industrial Duty Wiring Devices Locking Blade 30A 277V 2-Pole/3-Wire NEMA L7-30

Wiring Devices

D

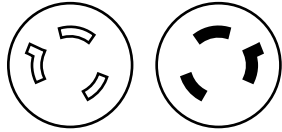

Features and Benefits

- NEöTEX® Paracril OZO rubber body yields the best performance for abrasion, chemical exposure and temperature extremes within the Super-Safeway™ offering
- Color-coded ¼" terminal screws pre-set in open position, ready to wire
- Wire screw terminals are tri-drive to be used with straight blade, Phillips and square-drive screw drivers
- Floating blade construction provides self-alignment, and a better mechanical and electrical connection minimizing wear and heat generation
- Transparent wiring guide to verify all wire strands are in place before securing wire
- Captive, tri-drive head, Stainless Steel, speed screw provides easy assembly and long life
- Two-piece cord-clamp strain relief includes tri-drive screws to firmly secure the cord

Reference Information

UL File No.: E10176
CSA File No.: LR6837



Physical

Plug blades and connector contacts: Nickel-plated Brass
Super-Safeway Outer Housing: NEöTEX Paracril OZO rubber
Safeway Outer Housing: Nylon
Face Screws: Stainless Steel
Face Insert: Nylon
Wire Saddle Clamp: Brass
Cord Clamp Screws: Steel, Zinc-plated
Plug/Connector Range: .425 to 1.150"

Environmental

Operating Temperature: Maximum continuous 75° C, minimum -40° C (no impact)
Temperature Rise: Maximum 30° C temperature rise at full rated current after 50 cycles of overload at 150% of rated current at a power factor of 75%.

Super-Safeway Industrial Rubber Plug and Connector

Description	Plug		Connector	
	Woodhead No.	Order No.	Woodhead No.	Order No.
Yellow rubber	2849	130142-0035	2949	130141-0069

Find adapters and technical support at the end of this section

Industrial Duty Wiring Devices Locking Blade 15A 125V 10A 250V 3-Pole/3-Wire Non-NEMA Locking

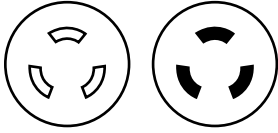

Features and Benefits

- NEoTEX® Paracril OZO rubber body yields the best performance for abrasion, chemical exposure and temperature extremes within the Super-Safeway™ offering
- Rugged nylon bodies within the Safeway® offering provide exceptional durability and performance
- Color-coded ¼" terminal screws pre-set in open position, ready to wire
- Wire screw terminals are tri-drive to be used with straight blade, Phillips and square-drive screw drivers
- Floating blade construction provides self-alignment, and a better mechanical and electrical connection minimizing wear and heat generation
- Transparent wiring guide to verify all wire strands are in place before securing wire
- Captive, tri-drive head, Stainless Steel, speed screw provides easy assembly and long life
- Two-piece cord-clamp strain relief includes tri-drive screws to firmly secure the cord

Physical

Plug blades and connector contacts: Nickel-plated Brass
Super-Safeway Outer Housing: NEoTEX Paracril OZO rubber
Safeway Outer Housing: Nylon
Face Screws: Stainless Steel
Face Insert: Nylon
Wire Saddle Clamp: Brass
Cord Clamp Screws: Steel, Zinc-plated
Plug/Connector Range: .325 to .840"

Environmental

Operating Temperature: Maximum continuous 75° C, minimum -40° C (no impact)
Temperature Rise: Maximum 30° C temperature rise at full rated current after 50 cycles of overload at 150% of rated current at a power factor of 75%.

Super-Safeway Industrial Rubber Plug and Connector

Description	Plug		Connector	
	Woodhead No.	Order No.	Woodhead No.	Order No.
Yellow rubber	2407	130141-0044	2507	130141-0053



Safeway Industrial Nylon Plug and Connector

Description	Plug		Connector	
	Woodhead No.	Order No.	Woodhead No.	Order No.
Black and white	4730	130144-0027	4739	130144-0029



Safeway Receptacle and Inlet

Description	Single Receptacle		Single Male Inlet	
	Woodhead No.	Order No.	Woodhead No.	Order No.
White, flanged	2507MB	130149-0019	2407MB	130149-0014



Super-Safeway Industrial Rubber Cordset

Description	Cord Length	Woodhead No.	Order No.
Yellow 16 gauge 500W cord	15.24m (50.0')	2407B163	130143-0171
Yellow 14 gauge 500W cord	7.62m (25.0')	2407A143	130143-0169

Find adapters and technical support at the end of this section

Industrial Duty Wiring Devices Locking Blade 20A 125/250V 3-Pole/3-Wire Non-NEMA Locking

D
Wiring Devices

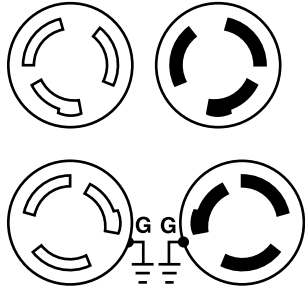

Features and Benefits

- NEoTEX® Paracril OZO rubber body yields the best performance for abrasion, chemical exposure and temperature extremes within the Super-Safeway™ offering
- Rugged nylon bodies within the Safeway® offering provide exceptional durability and performance
- Color-coded ¼" terminal screws pre-set in open position, ready to wire
- Wire screw terminals are tri-drive to be used with straight blade, Phillips and square-drive screw drivers
- Floating blade construction provides self-alignment, and a better mechanical and electrical connection minimizing wear and heat generation
- Transparent wiring guide to verify all wire strands are in place before securing wire
- Captive, tri-drive head, Stainless Steel, speed screw provides easy assembly and long life
- Two-piece cord-clamp strain relief includes tri-drive screws to firmly secure the cord

Reference Information

UL File No.: E10176
CSA File No.: LR6837



Physical

Plug blades and connector contacts: Nickel-plated Brass
Super-Safeway Outer Housing: NEoTEX Paracril OZO rubber

Safeway Outer Housing: Nylon

Face Screws: Stainless Steel

Face Insert: Nylon

Wire Saddle Clamp: Brass

Cord Clamp Screws: Steel, Zinc-plated

Plug/Connector Range: .425 to 1.150"

Environmental

Operating Temperature: Maximum continuous 75° C, minimum -40° C (no impact)

Temperature Rise: Maximum 30° C temperature rise at full rated current after 50 cycles of overload at 150% of rated current at a power factor of 75%.



Super-Safeway Industrial Rubber Plug and Connector

Description	Plug, No Ground		Connector, No Ground		Plug with Ground		Connector, with Ground	
	Woodhead No.	Order No.	Woodhead No.	Order No.	Woodhead No.	Order No.	Woodhead No.	Order No.
Yellow rubber	2608	130142-0002	2708	130142-0017				
Yellow rubber with grounding tab					2608G	130142-0004	2708G	130142-0018



Safeway Industrial Nylon Plug and Connector, No Ground

Description	Plug		Connector	
	Woodhead No.	Order No.	Woodhead No.	Order No.
Black and white	26T08	130145-0002	27T08	130145-0025



Safeway Receptacle and Inlet, No Ground

Description	Single Receptacle		Single Male Inlet	
	Woodhead No.	Order No.	Woodhead No.	Order No.
White, flanged	2708MB	130149-0036	2608MB	130149-0024

Find adapters and technical support at the end of this section

**Industrial Duty
Wiring Devices
Locking Blade
20A 125/250V
3-Pole/3-Wire
Non-NEMA Locking**

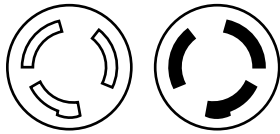

Features and Benefits

- NEoTEX® Paracril OZO rubber body yields the best performance for abrasion, chemical exposure and temperature extremes within the Super-Safeway™ offering
- Rugged nylon bodies within the Safeway® offering provide exceptional durability and performance
- Color-coded ¼" terminal screws pre-set in open position, ready to wire
- Wire screw terminals are tri-drive to be used with straight blade, Phillips and square-drive screw drivers
- Floating blade construction provides self-alignment, and a better mechanical and electrical connection minimizing wear and heat generation
- Transparent wiring guide to verify all wire strands are in place before securing wire
- Captive, tri-drive head, Stainless Steel, speed screw provides easy assembly and long life
- Two-piece cord-clamp strain relief includes tri-drive screws to firmly secure the cord

Reference Information

UL File No.: E38085
Y Non-Inline GFCI Cordset—E38085
CSA File No.: LR6837
Y Non-Inline GFCI Cordset—LL52750



Physical

Plug blades and connector contacts: Nickel-plated Brass
Super-Safeway Outer Housing: NEoTEX Paracril OZO rubber
Safeway Outer Housing: Nylon
Face Screws: Stainless Steel
Face Insert: Nylon
Wire Saddle Clamp: Brass
Cord Clamp Screws: Steel, Zinc-plated

Environmental

Operating Temperature: Maximum continuous 75° C, minimum -40° C (no impact)
Temperature Rise: Maximum 30° C temperature rise at full rated current after 50 cycles of overload at 150% of rated current at a power factor of 75%.



Super-Safeway Industrial Rubber Cordset

Description	Cord Length	Woodhead No.	Order No.
Yellow 14 gauge SOOW cord	15.2m (50.0')	2608B143	130143-0201



Super-Safeway Industrial Rubber Molded Y and W Cordsets

Description	Cord Length	Y-Cordset	
		Woodhead No.	Order No.
Yellow 12 gauge SOOW cord	0.91m (3.0')	2608-Y	130154-0106

Find adapters and technical support at the end of this section

Industrial Duty Wiring Devices Locking Blade 30A 250V 3-Pole/3-Wire Non-NEMA Locking

D
Wiring Devices

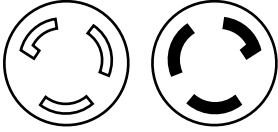

Features and Benefits

- NEöTEX® Paracril OZO rubber body yields the best performance for abrasion, chemical exposure and temperature extremes within the Super-Safeway™ offering
- Color-coded ¼" terminal screws pre-set in open position, ready to wire
- Wire screw terminals are tri-drive to be used with straight blade, Phillips and square-drive screw drivers
- Floating blade construction provides self-alignment, and a better mechanical and electrical connection minimizing wear and heat generation
- Transparent wiring guide to verify all wire strands are in place before securing wire
- Captive, tri-drive head, Stainless Steel, speed screw provides easy assembly and long life
- Two-piece cord-clamp strain relief includes tri-drive screws to firmly secure the cord

Reference Information

UL File No.: E10176
CSA File No.: LR6837



Physical

Plug blades and connector contacts: Nickel-plated Brass
Super-Safeway Outer Housing: NEöTEX Paracril OZO rubber
Safeway Outer Housing: Nylon
Face Screws: Stainless Steel
Face Insert: Nylon
Wire Saddle Clamp: Brass
Cord Clamp Screws: Steel, Zinc-plated
Plug/Connector Range: .325 to .840"

Environmental

Operating Temperature: Maximum continuous 75° C, minimum -40° C (no impact)
Temperature Rise: Maximum 30° C temperature rise at full rated current after 50 cycles of overload at 150% of rated current at a power factor of 75%.



Super-Safeway Industrial Rubber Plug and Connector

Description	Plug		Connector	
	Woodhead No.	Order No.	Woodhead No.	Order No.
Yellow rubber	2808	130142-0031	2908	130145-0066

Find adapters and technical support at the end of this section

Industrial Duty Wiring Devices Locking Blade 20A 125/250V 3-Pole/4-Wire NEMA L14-20

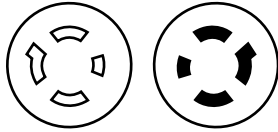

Features and Benefits

- NEōTEX® Paracril OZO rubber body yields the best performance for abrasion, chemical exposure and temperature extremes within the Super-Safeway™ offering
- Rugged nylon bodies within the Safeway® offering provide exceptional durability and performance
- Color-coded ¼" terminal screws pre-set in open position, ready to wire
- Wire screw terminals are tri-drive to be used with straight blade, Phillips and square-drive screw drivers
- Floating blade construction provides self-alignment, and a better mechanical and electrical connection minimizing wear and heat generation
- Transparent wiring guide to verify all wire strands are in place before securing wire
- Captive, tri-drive head, Stainless Steel, speed screw provides easy assembly and long life
- Two-piece cord-clamp strain relief includes tri-drive screws to firmly secure the cord

Reference Information

UL File No.: Plug and Connector—E10176

Receptacle—E46237

CSA File No.: LR6837



Physical

Plug blades and connector contacts: Nickel-plated Brass
Super-Safeway Outer Housing: NEōTEX Paracril OZO rubber

Safeway Outer Housing: Nylon

Face Screws: Stainless Steel

Face Insert: Nylon

Wire Saddle Clamp: Brass

Cord Clamp Screws: Steel, Zinc-plated

Plug/Connector Range: .325 to .840"

Environmental

Operating Temperature: Maximum continuous 75° C, minimum -40° C (no impact)

Temperature Rise: Maximum 30° C temperature rise at full rated current after 50 cycles of overload at 150% of rated current at a power factor of 75%.



Super-Safeway Industrial Rubber Plug and Connector

Description	Plug		Connector	
	Woodhead No.	Order No.	Woodhead No.	Order No.
Yellow rubber	2674	130142-0009	2774	130142-0024



Safeway Industrial Nylon Plug and Connector

Description	Plug		Connector	
	Woodhead No.	Order No.	Woodhead No.	Order No.
Black and white	2674	130145-0015	2774	130145-0035



Safeway Receptacle and Inlet

Description	Single Receptacle		Single Male Inlet	
	Woodhead No.	Order No.	Woodhead No.	Order No.
White, flanged	2774MB	130149-0042	2674MB	130149-0029
Black	4774	130149-0071		

Find adapters and technical support at the end of this section

Industrial Duty Wiring Devices Locking Blade 20A 125/250V 3-Pole/4-Wire NEMA L14-20

Wiring Devices

D

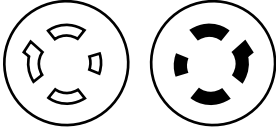

Super-Safeway Industrial Rubber Cordset

Description	Cord Length	Woodhead No.	Order No.
Yellow 16 gauge SOOW cord	15.2m (50.0')	26748124	130143-0214

Find adapters and technical support at the end of this section

Features and Benefits

- NEoTEX® Paracril OZO rubber body yields the best performance for abrasion, chemical exposure and temperature extremes within the Super-Safeway™ offering
- Rugged nylon bodies within the Safeway® offering provide exceptional durability and performance
- Color-coded ¼" terminal screws pre-set in open position, ready to wire
- Wire screw terminals are tri-drive to be used with straight blade, Phillips and square-drive screw drivers
- Floating blade construction provides self-alignment, and a better mechanical and electrical connection minimizing wear and heat generation
- Transparent wiring guide to verify all wire strands are in place before securing wire
- Captive, tri-drive head, Stainless Steel, speed screw provides easy assembly and long life
- Two-piece cord-clamp strain relief includes tri-drive screws to firmly secure the cord

Reference Information

UL File No.: E38085
CSA File No.: LR6837



Physical

Plug blades and connector contacts: Nickel-plated Brass
Super-Safeway Outer Housing: NEoTEX Paracril OZO rubber

Safeway Outer Housing: Nylon

Face Screws: Stainless Steel

Face Insert: Nylon

Wire Saddle Clamp: Brass

Cord Clamp Screws: Steel, Zinc-plated

Environmental

Operating Temperature: Maximum continuous 75° C, minimum -40° C (no impact)

Temperature Rise: Maximum 30° C temperature rise at full rated current after 50 cycles of overload at 150% of rated current at a power factor of 75%.

Industrial Duty Wiring Devices Locking Blade 20A 250V 3Ø 3-Pole/4-Wire NEMA L15-20

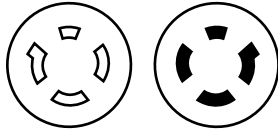

Features and Benefits

- NEōTEX® Paracril OZO rubber body yields the best performance for abrasion, chemical exposure and temperature extremes within the Super-Safeway™ offering
- Rugged nylon bodies within the Safeway® offering provide exceptional durability and performance
- Color-coded ¼" terminal screws pre-set in open position, ready to wire
- Wire screw terminals are tri-drive to be used with straight blade, Phillips and square-drive screw drivers
- Floating blade construction provides self-alignment, and a better mechanical and electrical connection minimizing wear and heat generation
- Transparent wiring guide to verify all wire strands are in place before securing wire
- Captive, tri-drive head, Stainless Steel, speed screw provides easy assembly and long life
- Two-piece cord-clamp strain relief includes tri-drive screws to firmly secure the cord

Reference Information

UL File No.: Plug and Connector—E10176

Receptacle—E46237

CSA File No.: LR6837



Physical

Plug blades and connector contacts: Nickel-plated Brass
Super-Safeway Outer Housing: NEōTEX Paracril OZO rubber

Safeway Outer Housing: Nylon

Face Screws: Stainless Steel

Face Insert: Nylon

Wire Saddle Clamp: Brass

Cord Clamp Screws: Steel, Zinc-plated

Plug/Connector Range: .325 to .840"

Environmental

Operating Temperature: Maximum continuous 75° C, minimum -40° C (no impact)

Temperature Rise: Maximum 30° C temperature rise at full rated current after 50 cycles of overload at 150% of rated current at a power factor of 75%.



Super-Safeway Industrial Rubber Plug and Connector

Description	Plug		Connector	
	Woodhead No.	Order No.	Woodhead No.	Order No.
Yellow rubber	2675	130142-0010	2775	130142-0025



Safeway Industrial Nylon Plug and Connector

Description	Plug		Connector	
	Woodhead No.	Order No.	Woodhead No.	Order No.
Black and white	26175	130145-0017	27175	130145-0037



Safeway Receptacle and Inlet

Description	Single Receptacle	
	Woodhead No.	Order No.
Black	4775	130149-0072

Find adapters and technical support at the end of this section

Industrial Duty Wiring Devices Locking Blade 20A 480V 3Ø 3-Pole/4-Wire NEMA L16-20

D
Wiring Devices

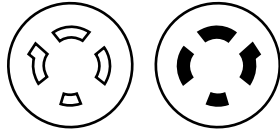

Features and Benefits

- NEoTEX® Paracril OZO rubber body yields the best performance for abrasion, chemical exposure and temperature extremes within the Super-Safeway™ offering
- Rugged nylon bodies within the Safeway® offering provide exceptional durability and performance
- Color-coded ¼" terminal screws pre-set in open position, ready to wire
- Wire screw terminals are tri-drive to be used with straight blade, Phillips and square-drive screw drivers
- Floating blade construction provides self-alignment, and a better mechanical and electrical connection minimizing wear and heat generation
- Transparent wiring guide to verify all wire strands are in place before securing wire
- Captive, tri-drive head, Stainless Steel, speed screw provides easy assembly and long life
- Two-piece cord-clamp strain relief includes tri-drive screws to firmly secure the cord

Reference Information

UL File No.: Plug and Connector—E10176

Receptacle—E46237

CSA File No.: LR6837



Physical

Plug blades and connector contacts: Nickel-plated Brass
Super-Safeway Outer Housing: NEoTEX Paracril OZO rubber

Safeway Outer Housing: Nylon

Face Screws: Stainless Steel

Face Insert: Nylon

Wire Saddle Clamp: Brass

Cord Clamp Screws: Steel, Zinc-plated

Plug/Connector Range: .425 to 1.150"

Environmental

Operating Temperature: Maximum continuous 75° C, minimum -40° C (no impact)

Temperature Rise: Maximum 30° C temperature rise at full rated current after 50 cycles of overload at 150% of rated current at a power factor of 75%.



Super-Safeway Industrial Rubber Plug and Connector

Description	Plug		Connector	
	Woodhead No.	Order No.	Woodhead No.	Order No.
Yellow rubber	2676	130142-0012	2776	130142-0026



Safeway Industrial Nylon Plug and Connector

Description	Plug		Connector	
	Woodhead No.	Order No.	Woodhead No.	Order No.
Black and white	2676	130145-0019	2776	130145-0039



Safeway Receptacle and Inlet

Description	Single Receptacle	
	Woodhead No.	Order No.
Black	4776	130149-0074

Find adapters and technical support at the end of this section

Industrial Duty Wiring Devices Locking Blade 30A 125/250V 3-Pole/4-Wire NEMA L14-30

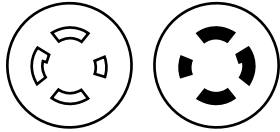

Features and Benefits

- NEōTEX® Paracril OZO rubber body yields the best performance for abrasion, chemical exposure and temperature extremes within the Super-Safeway™ offering
- Rugged nylon bodies within the Safeway® offering provide exceptional durability and performance
- Color-coded ¼" terminal screws pre-set in open position, ready to wire
- Wire screw terminals are tri-drive to be used with straight blade, Phillips and square-drive screw drivers
- Floating blade construction provides self-alignment, and a better mechanical and electrical connection minimizing wear and heat generation
- Transparent wiring guide to verify all wire strands are in place before securing wire
- Captive, tri-drive head, Stainless Steel, speed screw provides easy assembly and long life
- Two-piece cord-clamp strain relief includes tri-drive screws to firmly secure the cord

Reference Information

UL File No.: E10176
CSA File No.: LR6837



Physical

Plug blades and connector contacts: Nickel-plated Brass
Super-Safeway Outer Housing: NEōTEX Paracril OZO rubber

Safeway Outer Housing: Nylon

Face Screws: Stainless Steel

Face Insert: Nylon

Wire Saddle Clamp: Brass

Cord Clamp Screws: Steel, Zinc-plated

Plug/Connector Range: .425 to 1.150"

Environmental

Operating Temperature: Maximum continuous 75° C, minimum -40° C (no impact)

Temperature Rise: Maximum 30° C temperature rise at full rated current after 50 cycles of overload at 150% of rated current at a power factor of 75%.



Super-Safeway Industrial Rubber Plug and Connector

Description	Plug		Connector	
	Woodhead No.	Order No.	Woodhead No.	Order No.
Yellow rubber	2874	130142-0036	2974	130142-0043



Safeway Industrial Nylon Plug and Connector

Description	Plug		Connector	
	Woodhead No.	Order No.	Woodhead No.	Order No.
Black and white	2874	130145-0052	2974	130145-0076



Safeway Receptacle and Inlet

Description	Single Receptacle		Single Male Inlet	
	Woodhead No.	Order No.	Woodhead No.	Order No.
White, flanged	2974MB	130149-0059	2874MB	130149-0051

Find adapters and technical support at the end of this section

Industrial Duty Wiring Devices Locking Blade 30A 250V 3Ø 3-Pole/4-Wire NEMA L15-30

Wiring Devices

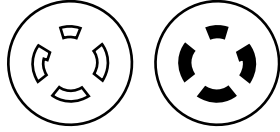

Features and Benefits

- NEoTEX® Paracril OZO rubber body yields the best performance for abrasion, chemical exposure and temperature extremes within the Super-Safeway™ offering
- Rugged nylon bodies within the Safeway® offering provide exceptional durability and performance
- Color-coded ¼" terminal screws pre-set in open position, ready to wire
- Wire screw terminals are tri-drive to be used with straight blade, Phillips and square-drive screw drivers
- Floating blade construction provides self-alignment, and a better mechanical and electrical connection minimizing wear and heat generation
- Transparent wiring guide to verify all wire strands are in place before securing wire
- Captive, tri-drive head, Stainless Steel, speed screw provides easy assembly and long life
- Two-piece cord-clamp strain relief includes tri-drive screws to firmly secure the cord

Reference Information

UL File No.: E10176
CSA File No.: LR6837



Physical

Plug blades and connector contacts: Nickel-plated Brass
Super-Safeway Outer Housing: NEoTEX Paracril OZO rubber

Safeway Outer Housing: Nylon

Face Screws: Stainless Steel

Face Insert: Nylon

Wire Saddle Clamp: Brass

Cord Clamp Screws: Steel, Zinc-plated

Plug/Connector Range: .425 to 1.150"

Environmental

Operating Temperature: Maximum continuous 75° C, minimum -40° C (no impact)

Temperature Rise: Maximum 30° C temperature rise at full rated current after 50 cycles of overload at 150% of rated current at a power factor of 75%.



Super-Safeway Industrial Rubber Plug and Connector

Description	Plug		Connector	
	Woodhead No.	Order No.	Woodhead No.	Order No.
Yellow rubber	2875	130142-0037	2975	130142-0044



Safeway Industrial Nylon Plug and Connector

DescriptionD-104	Plug		Connector	
	Woodhead No.	Order No.	Woodhead No.	Order No.
Black and white	28175	130145-0054	29175	130145-0078



Safeway Receptacle and Inlet

Description	Single Receptacle		Single Male Inlet	
	Woodhead No.	Order No.	Woodhead No.	Order No.
White, flanged	2975MB	130149-0060	2875MB	130149-0052

Find adapters and technical support at the end of this section

Industrial Duty Wiring Devices Locking Blade 30A 480V 3ø 3-Pole/4-Wire NEMA L16-30

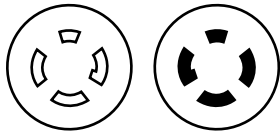

Features and Benefits

- NEōTEX® Paracril OZO rubber body yields the best performance for abrasion, chemical exposure and temperature extremes within the Super-Safeway™ offering
- Rugged nylon bodies within the Safeway® offering provide exceptional durability and performance
- Color-coded ¼" terminal screws pre-set in open position, ready to wire
- Wire screw terminals are tri-drive to be used with straight blade, Phillips and square-drive screw drivers
- Floating blade construction provides self-alignment, and a better mechanical and electrical connection minimizing wear and heat generation
- Transparent wiring guide to verify all wire strands are in place before securing wire
- Captive, tri-drive head, Stainless Steel, speed screw provides easy assembly and long life
- Two-piece cord-clamp strain relief includes tri-drive screws to firmly secure the cord

Reference Information

UL File No.: Plug and Connector—E10176

Receptacle—E46237

CSA File No.: LR6837



Physical

Plug blades and connector contacts: Nickel-plated Brass
Super-Safeway Outer Housing: NEōTEX Paracril OZO rubber

Safeway Outer Housing: Nylon

Face Screws: Stainless Steel

Face Insert: Nylon

Wire Saddle Clamp: Brass

Cord Clamp Screws: Steel, Zinc-plated

Plug/Connector Range: .425 to 1.150"

Environmental

Operating Temperature: Maximum continuous 75° C,
minimum -40° C (no impact)

Temperature Rise: Maximum 30° C temperature rise at full rated current after 50 cycles of overload at 150% of rated current at a power factor of 75%.



Super-Safeway Industrial Rubber Plug and Connector

Description	Plug		Connector	
	Woodhead No.	Order No.	Woodhead No.	Order No.
Yellow rubber	2876	130142-0038	2976	130142-0045



Safeway Industrial Nylon Plug and Connector

Description	Plug		Connector	
	Woodhead No.	Order No.	Woodhead No.	Order No.
Yellow	2876	130145-0056	2976	130145-0080



Safeway Receptacle and Inlet

Description	Single Receptacle		Single Male Inlet	
	Woodhead No.	Order No.	Woodhead No.	Order No.
White, flanged	2976MB	130149-0061	2876MB	130149-0053
Black	4976	130149-0085		
Corrosion resistant	4976CR	130149-0086		

Find adapters and technical support at the end of this section

Industrial Duty Wiring Devices Locking Blade 30A 480V 3Ø 3-Pole/4-Wire NEMA L16-30

Wiring Devices

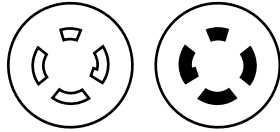

Features and Benefits

- NEoTEX® Paracril OZO rubber body yields the best performance for abrasion, chemical exposure and temperature extremes within the Super-Safeway™ offering
- Rugged nylon bodies within the Safeway® offering provide exceptional durability and performance
- Color-coded ¼" terminal screws pre-set in open position, ready to wire
- Wire screw terminals are tri-drive to be used with straight blade, Phillips and square-drive screw drivers
- Floating blade construction provides self-alignment, and a better mechanical and electrical connection minimizing wear and heat generation
- Transparent wiring guide to verify all wire strands are in place before securing wire
- Captive, tri-drive head, Stainless Steel, speed screw provides easy assembly and long life
- Two-piece cord-clamp strain relief includes tri-drive screws to firmly secure the cord

Reference Information

UL File No.: E38085
CSA File No.: LR6837



Physical

Plug blades and connector contacts: Nickel-plated Brass
Super-Safeway Outer Housing: NEoTEX Paracril OZO rubber

Safeway Outer Housing: Nylon

Face Screws: Stainless Steel

Face Insert: Nylon

Wire Saddle Clamp: Brass

Cord Clamp Screws: Steel, Zinc-plated

Environmental

Operating Temperature: Maximum continuous 75° C, minimum -40° C (no impact)

Temperature Rise: Maximum 30° C temperature rise at full rated current after 50 cycles of overload at 150% of rated current at a power factor of 75%.



Super-Safeway Industrial Rubber Cordset

Description	Cord Length	Woodhead No.	Order No.
Yellow 10 gauge 500W cord	15.2m (50.0')	2876B104	130143-0257

Find adapters and technical support at the end of this section

**Industrial Duty
Wiring Devices
Locking Blade
30A 600V 3Ø
3-Pole/4-Wire
NEMA L17-30**

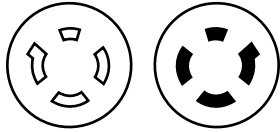

Features and Benefits

- NEōTEX® Paracril OZO rubber body yields the best performance for abrasion, chemical exposure and temperature extremes within the Super-Safeway™ offering
- Rugged nylon bodies within the Safeway® offering provide exceptional durability and performance
- Color-coded ¼" terminal screws pre-set in open position, ready to wire
- Wire screw terminals are tri-drive to be used with straight blade, Phillips and square-drive screw drivers
- Floating blade construction provides self-alignment, and a better mechanical and electrical connection minimizing wear and heat generation
- Transparent wiring guide to verify all wire strands are in place before securing wire
- Captive, tri-drive head, Stainless Steel, speed screw provides easy assembly and long life
- Two-piece cord-clamp strain relief includes tri-drive screws to firmly secure the cord

Reference Information

UL File No.: E10176
CSA File No.: LR6837



Physical

Plug blades and connector contacts: Nickel-plated Brass
Super-Safeway Outer Housing: NEōTEX Paracril OZO rubber

Safeway Outer Housing: Nylon

Face Screws: Stainless Steel

Face Insert: Nylon

Wire Saddle Clamp: Brass

Cord Clamp Screws: Steel, Zinc-plated

Plug/Connector Range: .425 to 1.150"

Environmental

Operating Temperature: Maximum continuous 75° C, minimum -40° C (no impact)

Temperature Rise: Maximum 30° C temperature rise at full rated current after 50 cycles of overload at 150% of rated current at a power factor of 75%.



Super-Safeway Industrial Rubber Plug and Connector

Description	Plug		Connector	
	Woodhead No.	Order No.	Woodhead No.	Order No.
Yellow rubber	2877	130142-0039	2977	130142-0046



Safeway Industrial Nylon Plug and Connector

Description	Plug		Connector	
	Woodhead No.	Order No.	Woodhead No.	Order No.
Black and white	28177	130145-0058	29177	130145-0082

Find adapters and technical support at the end of this section

Industrial Duty Wiring Devices Locking Blade 50A 125/250V 3-Pole/4-Wire Non-NEMA Locking CA

Wiring Devices

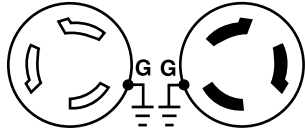

Features and Benefits

- Rugged nylon bodies within the Safeway® offering provide exceptional durability and performance
- Color-coded ¼" terminal screws pre-set in open position, ready to wire
- Wire screw terminals are tri-drive to be used with straight blade, Phillips and square-drive screw drivers
- Floating blade construction provides self-alignment, and a better mechanical and electrical connection minimizing wear and heat generation
- Transparent wiring guide to verify all wire strands are in place before securing wire
- Captive, tri-drive head, Stainless Steel, speed screw provides easy assembly and long life
- Two-piece cord-clamp strain relief includes tri-drive screws to firmly secure the cord

Physical

Plug blades and connector contacts: Nickel-plated Brass
Safeway Outer Housing: Nylon
Face Screws: Stainless Steel
Face Insert: Nylon
Wire Saddle Clamp: Brass
Cord Clamp Screws: Steel, Zinc-plated

Environmental

Operating Temperature: Maximum continuous 75° C, minimum -40° C (no impact)
Temperature Rise: Maximum 30° C temperature rise at full rated current after 50 cycles of overload at 150% of rated current at a power factor of 75%.



Safeway Industrial Nylon Plug and Connector

Description	Plug		Connector	
	Woodhead No.	Order No.	Woodhead No.	Order No.
Yellow	CS6365N	130155-0134	CS6364N	130155-0133



Safeway Receptacle and Inlet

Description	Single Receptacle		Single Male Inlet	
	Woodhead No.	Order No.	Woodhead No.	Order No.
White, flanged			CS6375	130155-0137
Black	CS6369	130155-0135		

Find adapters and technical support at the end of this section

Industrial Duty Wiring Devices Locking Blade 50A 250V 3Ø 3-Pole/4-Wire Non-NEMA Locking CA

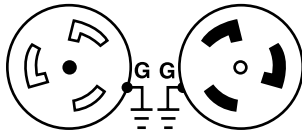

Features and Benefits

- Rugged nylon bodies within the Safeway® offering provide exceptional durability and performance
- Color-coded ¼" terminal screws pre-set in open position, ready to wire
- Wire screw terminals are tri-drive to be used with straight blade, Phillips and square-drive screw drivers
- Floating blade construction provides self-alignment, and a better mechanical and electrical connection minimizing wear and heat generation
- Transparent wiring guide to verify all wire strands are in place before securing wire
- Captive, tri-drive head, Stainless Steel, speed screw provides easy assembly and long life
- Two-piece cord-clamp strain relief includes tri-drive screws to firmly secure the cord

Physical

Plug blades and connector contacts: Nickel-plated Brass
 Super-Safeway Outer Housing: NEöTEX® Paracril OZO rubber
 Safeway Outer Housing: Nylon
 Face Screws: Stainless Steel
 Face Insert: Nylon
 Wire Saddle Clamp: Brass
 Cord Clamp Screws: Steel, Zinc-plated

Environmental

Operating Temperature: Maximum continuous 75° C, minimum -40° C (no impact)
 Temperature Rise: Maximum 30° C temperature rise at full rated current after 50 cycles of overload at 150% of rated current at a power factor of 75%.

D

Wiring Devices



Safeway Industrial Nylon Plug and Connector

Description	Plug		Connector	
	Woodhead No.	Order No.	Woodhead No.	Order No.
Yellow	CS8365N	130155-0157	CS8364N	130155-0156



Safeway Receptacle and Inlet

Description	Single Receptacle		Single Male Inlet	
	Woodhead No.	Order No.	Woodhead No.	Order No.
White, flanged			CS8375	130155-0159
Black	CS8369	130155-0158		

Find adapters and technical support at the end of this section

Industrial Duty Wiring Devices Locking Blade 50A 480V 3Ø 3-Pole/4-Wire Non-NEMA Locking CA

Wiring Devices

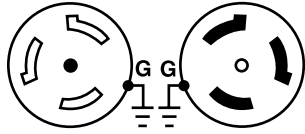

Features and Benefits

- Rugged nylon bodies within the Safeway® offering provide exceptional durability and performance
- Color-coded ¼" terminal screws pre-set in open position, ready to wire
- Wire screw terminals are tri-drive to be used with straight blade, Phillips and square-drive screw drivers
- Floating blade construction provides self-alignment, and a better mechanical and electrical connection minimizing wear and heat generation
- Transparent wiring guide to verify all wire strands are in place before securing wire
- Captive, tri-drive head, Stainless Steel, speed screw provides easy assembly and long life
- Two-piece cord-clamp strain relief includes tri-drive screws to firmly secure the cord

Physical

Plug blades and connector contacts: Nickel-plated Brass
Safeway Outer Housing: Nylon
Face Screws: Stainless Steel
Face Insert: Nylon
Wire Saddle Clamp: Brass
Cord Clamp Screws: Steel, Zinc-plated

Environmental

Operating Temperature: Maximum continuous 75° C, minimum -40° C (no impact)
Temperature Rise: Maximum 30° C temperature rise at full rated current after 50 cycles of overload at 150% of rated current at a power factor of 75%.



Safeway Industrial Nylon Plug and Connector

Description	Plug		Connector	
	Woodhead No.	Order No.	Woodhead No.	Order No.
Black and white	CS8165N	130155-0145	CS8164N	130155-0144



Safeway Receptacle and Inlet

Description	Single Receptacle		Single Male Inlet	
	Woodhead No.	Order No.	Woodhead No.	Order No.
White, flanged			CS8175	130155-0147
Black	CS8169	130155-0146		

Find adapters and technical support at the end of this section

**Industrial Duty
Wiring Devices
Locking Blade
50A 600V AC/250V DC
Grounding
3-Pole/4-Wire
Non-NEMA**

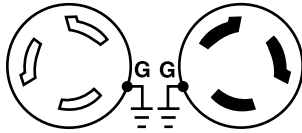

Features and Benefits

- Rugged nylon bodies within the Safeway® offering provide exceptional durability and performance
- Color-coded ¼" terminal screws pre-set in open position, ready to wire
- Wire screw terminals are tri-drive to be used with straight blade, Phillips and square-drive screw drivers
- Floating blade construction provides self-alignment, and a better mechanical and electrical connection minimizing wear and heat generation
- Transparent wiring guide to verify all wire strands are in place before securing wire
- Captive, tri-drive head, Stainless Steel, speed screw provides easy assembly and long life
- Two-piece cord-clamp strain relief includes tri-drive screws to firmly secure the cord

Physical

Plug blades and connector contacts: Nickel-plated Brass
 Super-Safeway Outer Housing: NEöTEX® Paracril OZO rubber
 Safeway Outer Housing: Nylon
 Face Screws: Stainless Steel
 Face Insert: Nylon
 Wire Saddle Clamp: Brass
 Cord Clamp Screws: Steel, Zinc-plated

Environmental

Operating Temperature: Maximum continuous 75° C, minimum -40° C (no impact)
 Temperature Rise: Maximum 30° C temperature rise at full rated current after 50 cycles of overload at 150% of rated current at a power factor of 75%.



Safeway Industrial Nylon Plug and Connector

Description	Plug		Connector	
	Woodhead No.	Order No.	Woodhead No.	Order No.
Yellow	7765N	130155-0123	7764N	130155-0122

Find adapters and technical support at the end of this section

Industrial Duty Wiring Devices Locking Blade 50A 600V AC/250V DC 3-Pole/4-Wire Non-NEMA Locking

Wiring Devices

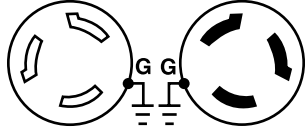

Features and Benefits

- Rugged nylon bodies within the Safeway® offering provide exceptional durability and performance
- Color-coded 1/4" terminal screws pre-set in open position, ready to wire
- Wire screw terminals are tri-drive to be used with straight blade, Phillips and square-drive screw drivers
- Floating blade construction provides self-alignment, and a better mechanical and electrical connection minimizing wear and heat generation
- Transparent wiring guide to verify all wire strands are in place before securing wire
- Captive, tri-drive head, Stainless Steel, speed screw provides easy assembly and long life
- Two-piece cord-clamp strain relief includes tri-drive screws to firmly secure the cord

Physical

Plug blades and connector contacts: Nickel-plated Brass
Super-Safeway Outer Housing: NEōTEX® Paracril OZO rubber
Safeway Outer Housing: Nylon
Face Screws: Stainless Steel
Face Insert: Nylon
Wire Saddle Clamp: Brass
Cord Clamp Screws: Steel, Zinc-plated

Environmental

Operating Temperature: Maximum continuous 75° C, minimum -40° C (no impact)
Temperature Rise: Maximum 30° C temperature rise at full rated current after 50 cycles of overload at 150% of rated current at a power factor of 75%.



Safeway Industrial Nylon Plug and Connector

Description	Plug		Connector	
	Woodhead No.	Order No.	Woodhead No.	Order No.
Yellow	3765N	130155-0042	3764N	130155-0041



Safeway Receptacle and Inlet

Description	Single Receptacle		Single Male Inlet	
	Woodhead No.	Order No.	Woodhead No.	Order No.
White, Flanged			3775	130155-0044
Black	3769	130155-0043		

Find adapters and technical support at the end of this section

Industrial Duty Wiring Devices Locking Blade 20A 208V 4-Pole/4-Wire Non-NEMA

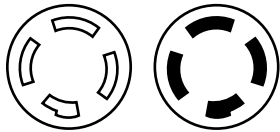

Super-Safeway Industrial Rubber Plug and Connector



Description	Plug		Connector	
	Woodhead No.	Order No.	Woodhead No.	Order No.
Yellow rubber	2609	130142-0006	2709	130142-0019

Find adapters and technical support at the end of this section

Features and Benefits

- NEōTEX® Paracril OZO rubber body yields the best performance for abrasion, chemical exposure and temperature extremes within the Super-Safeway™ offering
- Color-coded ¼" terminal screws pre-set in open position, ready to wire
- Wire screw terminals are tri-drive to be used with straight blade, Phillips and square-drive screw drivers
- Floating blade construction provides self-alignment, and a better mechanical and electrical connection minimizing wear and heat generation
- Transparent wiring guide to verify all wire strands are in place before securing wire
- Captive, tri-drive head, Stainless Steel, speed screw provides easy assembly and long life
- Two-piece cord-clamp strain relief includes tri-drive screws to firmly secure the cord

Reference Information

UL File No.: E10176
CSA File No.: LR6837  

Physical

Plug blades and connector contacts: Nickel-plated Brass
Super-Safeway Outer Housing: NEōTEX Paracril OZO rubber
Safeway Outer Housing: Nylon
Face Screws: Stainless Steel
Face Insert: Nylon
Wire Saddle Clamp: Brass
Cord Clamp Screws: Steel, Zinc-plated
Plug/Connector Range: .425 to 1.150"

Environmental

Operating Temperature: Maximum continuous 75° C, minimum -40° C (no impact)
Temperature Rise: Maximum 30° C temperature rise at full rated current after 50 cycles of overload at 150% of rated current at a power factor of 75%.

Industrial Duty Wiring Devices Locking Blade 30A 208V 4-Pole/4-Wire Non-NEMA Locking

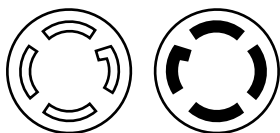

Super-Safeway Industrial Rubber Plug and Connector



Description	Plug		Connector	
	Woodhead No.	Order No.	Woodhead No.	Order No.
Yellow rubber	2809	130142-0032	2909	130145-0067

Find adapters and technical support at the end of this section

Features and Benefits

- NEōTEX® Paracril OZO rubber body yields the best performance for abrasion, chemical exposure and temperature extremes within the Super-Safeway™ offering
- Color-coded ¼" terminal screws pre-set in open position, ready to wire
- Wire screw terminals are tri-drive to be used with straight blade, Phillips and square-drive screw drivers
- Floating blade construction provides self-alignment, and a better mechanical and electrical connection minimizing wear and heat generation
- Transparent wiring guide to verify all wire strands are in place before securing wire
- Captive, tri-drive head, Stainless Steel, speed screw provides easy assembly and long life
- Two-piece cord-clamp strain relief includes tri-drive screws to firmly secure the cord

Reference Information

UL File No.: E10176
CSA File No.: LR6837  

Physical

Plug blades and connector contacts: Nickel-plated Brass
Super-Safeway Outer Housing: NEōTEX Paracril OZO rubber
Safeway Outer Housing: Nylon
Face Screws: Stainless Steel
Face Insert: Nylon
Wire Saddle Clamp: Brass
Cord Clamp Screws: Steel, Zinc-plated
Plug/Connector Range: .425 to 1.150"

Environmental

Operating Temperature: Maximum continuous 75° C, minimum -40° C (no impact)
Temperature Rise: Maximum 30° C temperature rise at full rated current after 50 cycles of overload at 150% of rated current at a power factor of 75%.

Industrial Duty Wiring Devices Locking Blade 20A 208V 3Ø 4-Pole/5-Wire NEMA L21-20

Wiring Devices

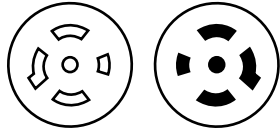

Features and Benefits

- NEoTEX® Paracril OZO rubber body yields the best performance for abrasion, chemical exposure and temperature extremes within the Super-Safeway™ offering
- Color-coded ¼" terminal screws pre-set in open position, ready to wire
- Wire screw terminals are tri-drive to be used with straight blade, Phillips and square-drive screw drivers
- Floating blade construction provides self-alignment, and a better mechanical and electrical connection minimizing wear and heat generation
- Transparent wiring guide to verify all wire strands are in place before securing wire
- Captive, tri-drive head, Stainless Steel, speed screw provides easy assembly and long life
- Two-piece cord-clamp strain relief includes tri-drive screws to firmly secure the cord

Reference Information

UL File No.: E10176

CSA File No.: LR6837



Physical

Plug blades and connector contacts: Nickel-plated Brass
Super-Safeway Outer Housing: NEoTEX Paracril OZO rubber
Safeway Outer Housing: Nylon
Face Screws: Stainless Steel
Face Insert: Nylon
Wire Saddle Clamp: Brass
Cord Clamp Screws: Steel, Zinc-plated
Plug/Connector Range: .325 to .840"

Environmental

Operating Temperature: Maximum continuous 75° C, minimum -40° C (no impact)
Temperature Rise: Maximum 30° C temperature rise at full rated current after 50 cycles of overload at 150% of rated current at a power factor of 75%.



Super-Safeway Industrial Rubber Plug and Connector

Description	Plug		Connector	
	Woodhead No.	Order No.	Woodhead No.	Order No.
Yellow rubber	2681	130142-0014	2781	130142-0028

Find adapters and technical support at the end of this section

Industrial Duty Wiring Devices Locking Blade 20A 480V 3Ø 4-Pole/5-Wire NEMA L22-20

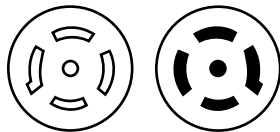

Features and Benefits

- NEoTEX® Paracril OZO rubber body yields the best performance for abrasion, chemical exposure and temperature extremes within the Super-Safeway™ offering
- Color-coded ¼" terminal screws pre-set in open position, ready to wire
- Wire screw terminals are tri-drive to be used with straight blade, Phillips and square-drive screw drivers
- Floating blade construction provides self-alignment, and a better mechanical and electrical connection minimizing wear and heat generation
- Transparent wiring guide to verify all wire strands are in place before securing wire
- Captive, tri-drive head, Stainless Steel, speed screw provides easy assembly and long life
- Two-piece cord-clamp strain relief includes tri-drive screws to firmly secure the cord

Reference Information

UL File No.: E10176

CSA File No.: LR6837



Physical

Plug blades and connector contacts: Nickel-plated Brass
Super-Safeway Outer Housing: NEoTEX Paracril OZO rubber
Safeway Outer Housing: Nylon
Face Screws: Stainless Steel
Face Insert: Nylon
Wire Saddle Clamp: Brass
Cord Clamp Screws: Steel, Zinc-plated
Plug/Connector Range: .325 to .840"

Environmental

Operating Temperature: Maximum continuous 75° C, minimum -40° C (no impact)
Temperature Rise: Maximum 30° C temperature rise at full rated current after 50 cycles of overload at 150% of rated current at a power factor of 75%.



Super-Safeway Industrial Rubber Plug and Connector

Description	Plug		Connector	
	Woodhead No.	Order No.	Woodhead No.	Order No.
Yellow rubber	2682	130142-0015	2782	130142-0029

Find adapters and technical support at the end of this section

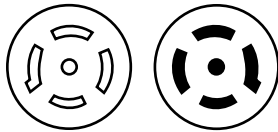

Industrial Duty Wiring Devices Locking Blade 20A 600V 3ø 4-Pole/5-Wire NEMA L23-20



Features and Benefits

- NEōTEX® Paracril OZO rubber body yields the best performance for abrasion, chemical exposure and temperature extremes within the Super-Safeway™ offering
- Color-coded ¼" terminal screws pre-set in open position, ready to wire
- Wire screw terminals are tri-drive to be used with straight blade, Phillips and square-drive screw drivers
- Floating blade construction provides self-alignment, and a better mechanical and electrical connection minimizing wear and heat generation
- Transparent wiring guide to verify all wire strands are in place before securing wire
- Captive, tri-drive head, Stainless Steel, speed screw provides easy assembly and long life
- Two-piece cord-clamp strain relief includes tri-drive screws to firmly secure the cord

Reference Information

UL File No.: E10176
CSA File No.: LR6837  

Physical

Plug blades and connector contacts: Nickel-plated Brass
Super-Safeway Outer Housing: NEōTEX Paracril OZO rubber
Safeway Outer Housing: Nylon
Face Screws: Stainless Steel
Face Insert: Nylon
Wire Saddle Clamp: Brass
Cord Clamp Screws: Steel, Zinc-plated
Plug/Connector Range: .325 to .840"

Environmental

Operating Temperature: Maximum continuous 75° C,
minimum -40° C (no impact)
Temperature Rise: Maximum 30° C temperature rise at full
rated current after 50 cycles of overload at 150% of
rated current at a power factor of 75%.



Super-Safeway Industrial Rubber Plug and Connector

Description	Plug		Connector	
	Woodhead No.	Order No.	Woodhead No.	Order No.
Yellow rubber	2683	130142-0016	2783	130142-0030

Find adapters and technical support at the end of this section

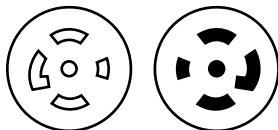

Industrial Duty Wiring Devices Locking Blade 30A 208V 3ø 4-Pole/5-Wire NEMA L21-30



Features and Benefits

- NEōTEX® Paracril OZO rubber body yields the best performance for abrasion, chemical exposure and temperature extremes within the Super-Safeway™ offering
- Color-coded ¼" screws pre-set in open position, ready to wire
- Wire screw terminals are tri-drive to be used with straight blade, Phillips and square-drive screw drivers
- Floating blade construction provides self-alignment, and a better mechanical and electrical connection minimizing wear and heat generation
- Transparent wiring guide to verify all wire strands are in place before securing wire
- Captive, tri-drive head, Stainless Steel, speed screw provides easy assembly and long life
- Two-piece cord-clamp strain relief includes tri-drive screws to firmly secure the cord

Reference Information

UL File No.: E10176
CSA File No.: LR6837  

Physical

Plug blades and connector contacts: Nickel-plated Brass
Super-Safeway Outer Housing: NEōTEX Paracril OZO rubber
Safeway Outer Housing: Nylon
Face Screws: Stainless Steel
Face Insert: Nylon
Wire Saddle Clamp: Brass
Cord Clamp Screws: Steel, Zinc-plated
Plug/Connector Range: .425 to 1.150"

Environmental

Operating Temperature: Maximum continuous 75° C,
minimum -40° C (no impact)
Temperature Rise: Maximum 30° C temperature rise at full
rated current after 50 cycles of overload at 150% of
rated current at a power factor of 75%.



Super-Safeway Industrial Rubber Plug and Connector

Description	Plug		Connector	
	Woodhead No.	Order No.	Woodhead No.	Order No.
Yellow rubber	2881	130142-0040	2981	130142-0047

Find adapters and technical support at the end of this section

Industrial Duty Wiring Devices Locking Blade 30A 480V 3Ø 4-Pole/5-Wire NEMA L22-30

Wiring Devices

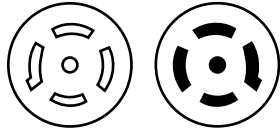

Features and Benefits

- NEöTEX® Paracril OZO rubber body yields the best performance for abrasion, chemical exposure and temperature extremes within the Super-Safeway™ offering
- Color-coded ¼" terminal screws pre-set in open position, ready to wire
- Wire screw terminals are tri-drive to be used with straight blade, Phillips and square-drive screw drivers
- Floating blade construction provides self-alignment, and a better mechanical and electrical connection minimizing wear and heat generation
- Transparent wiring guide to verify all wire strands are in place before securing wire
- Captive, tri-drive head, Stainless Steel, speed screw provides easy assembly and long life
- Two-piece cord-clamp strain relief includes tri-drive screws to firmly secure the cord

Reference Information

UL File No.: E10176

CSA File No.: LR6837



Physical

Plug blades and connector contacts: Nickel-plated Brass
Super-Safeway Outer Housing: NEöTEX Paracril OZO rubber
Safeway Outer Housing: Nylon
Face Screws: Stainless Steel
Face Insert: Nylon
Wire Saddle Clamp: Brass
Cord Clamp Screws: Steel, Zinc-plated
Plug/Connector Range: .425 to 1.150"

Environmental

Operating Temperature: Maximum continuous 75° C, minimum -40° C (no impact)
Temperature Rise: Maximum 30° C temperature rise at full rated current after 50 cycles of overload at 150% of rated current at a power factor of 75%.



Super-Safeway Industrial Rubber Plug and Connector

Description	Plug		Connector	
	Woodhead No.	Order No.	Woodhead No.	Order No.
Yellow rubber	2882	130142-0041	2982	130142-0048

Find adapters and technical support at the end of this section

Industrial Duty Wiring Devices Locking Blade 30A 600V 3Ø 4-Pole/5-Wire NEMA L23-30

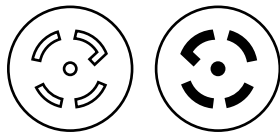

Features and Benefits

- NEöTEX® Paracril OZO rubber body yields the best performance for abrasion, chemical exposure and temperature extremes within the Super-Safeway™ offering
- Color-coded ¼" terminal screws pre-set in open position, ready to wire
- Wire screw terminals are tri-drive to be used with straight blade, Phillips and square-drive screw drivers
- Floating blade construction provides self-alignment, and a better mechanical and electrical connection minimizing wear and heat generation
- Transparent wiring guide to verify all wire strands are in place before securing wire
- Captive, tri-drive head, Stainless Steel, speed screw provides easy assembly and long life
- Two-piece cord-clamp strain relief includes tri-drive screws to firmly secure the cord

Reference Information

UL File No.: E10176

CSA File No.: LR6837



Physical

Plug blades and connector contacts: Nickel-plated Brass
Super-Safeway Outer Housing: NEöTEX Paracril OZO rubber
Safeway Outer Housing: Nylon
Face Screws: Stainless Steel
Face Insert: Nylon
Wire Saddle Clamp: Brass
Cord Clamp Screws: Steel, Zinc-plated
Plug/Connector Range: .425 to 1.150"

Environmental

Operating Temperature: Maximum continuous 75° C, minimum -40° C (no impact)
Temperature Rise: Maximum 30° C temperature rise at full rated current after 50 cycles of overload at 150% of rated current at a power factor of 75%.



Super-Safeway Industrial Rubber Plug and Connector

Description	Plug		Connector	
	Woodhead No.	Order No.	Woodhead No.	Order No.
Yellow rubber	2883	130142-0042	2983	130142-0049

Find adapters and technical support at the end of this section

Industrial Duty Wiring Devices Super-Safeway™ Adapters



Read across for plug (blade) configuration, then read down for receptacle (slot) configuration. Order the Woodhead number in intersecting box.

The following letter codes indicate limited use adapters:

- A For use only with receptacles wired for 125V single-phase grounding service.
- B For use only up to a maximum of 15A.
- C For use only with receptacles wires for 15A/125V single-phase grounding service

Features and Benefits

- NEōTEX® Paracril OZO rubber body yields the best performance for abrasion, chemical exposure and temperature extremes within the Super-Safeway™ offering
- Floating blade construction provides self-alignment, and a better mechanical and electrical connection minimizing wear and heat generation

Reference Information

UL File No.: E10176
CSA File No.: LR6837



Physical

Plug blades and connector contacts: Nickel-plated Brass
Super-Safeway Outer Housing: NEōTEX Paracril OZO rubber

Environmental









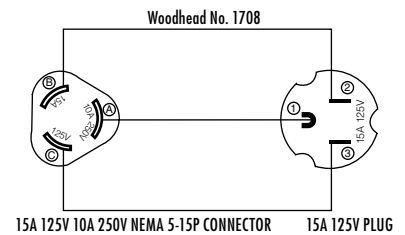
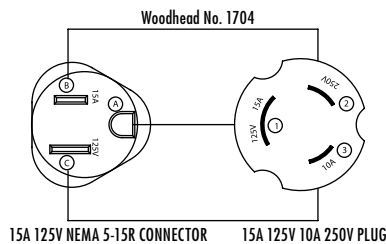
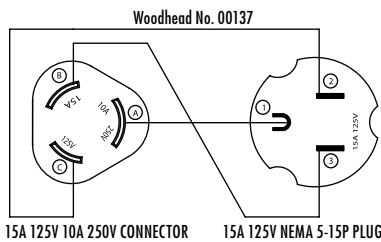
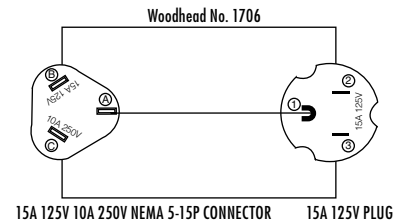
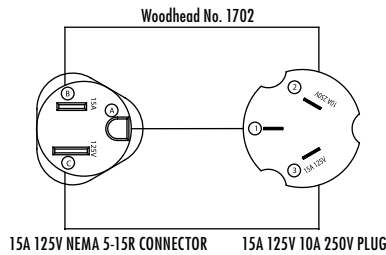
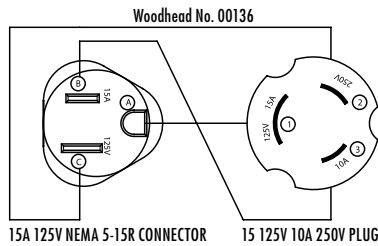







Operating Temperature: Maximum continuous 75° C, minimum -40° C (no impact)
Temperature Rise: Maximum 30° C temperature rise at full rated current after 50 cycles of overload at 150% of rated current at a power factor of 75%.

Receptable (female end)	Plug (Male End)							
	15A/125V 5-15	15A/125V* Non-NEMA	20A/125V 5-20	15A/125V L5-15	15A/125V* Non-NEMA	20A/125V L5-20	20A/125V P and S Pins	20A/250V Non-NEMA
15A/125V 5-15		1702 [†] C		1705	1704 [†] 00136 [†] C	1740		1730
15A/125V* Non-NEMA	1706							
20A/125V 5-20						1740	1733	1730 A
15A/125V L5-15	1712				1725 C	1783		
15A/125V* Non-NEMA	1708 00137			1719				
20A/125V L5-20	1744 B		1741					
20A/250V Non-NEMA	1732 C							

* Also rated 10A/250V

[†] For adapter wiring, refer to wiring schematics below, not UL or CSA



Adapter	Woodhead No.	Order No.	Adapter	Woodhead No.	Order No.
	1706*†	130151-0015		1719*	130151-0018
	1712	130151-0017		1704*	130151-0013
	1708*	130151-0016		00136*†	130151-0001
	00137*†	130151-0002		1725*	130151-0019
	1744*	130151-0025		1740	130151-0023
	1732*	130151-0021		1783*	130151-0026
	1702*†	130151-0012		1733*	130151-0022
	1741	130151-0024		1730*†	130151-0020
	1705	130151-0014			

* Not UL listed
† Not CSA listed

Wiring Devices

Industrial Duty

60.0A

277V/480V

4-Pole/5-Wire

Features and Benefits

- Designed specifically for the Expo Center environment
- Woodhead Expo Connectors provide a single device that accepts both flat and round cable, a durable light-weight construction and a non-conductive exterior. This new design provides compact versatility in 60A configurations.
- Woodhead Expo Connectors are specifically designed for power distribution from ceiling drops, wall mounts and floor boxes to portable panel-boards.

Reference Information

UL File No.: E145923
 CSA File No.: LR6837



Physical

Pins: Brass
 Housing, Insert, Clamp: Polycarbonate

Environmental

General purpose

Expo Connector	Face View	Type	Description	Woodhead No.	Order No.
		Plug	60A Safeway Pin and Sleeve Device, Exposition Plug, 4-Pole/5-Wire Grounding with Flat Cable	Y560PF	130150-0284
		Inlet	60A Safeway Pin and Sleeve Device, Exposition Inlet, 4-Pole/5-Wire Grounding	Y560B	130150-0280
		Connector	60A Safeway Pin and Sleeve Device, Exposition Connector, 4-Pole/5-Wire Grounding with Flat Cable	Y560CF	130150-0282
		Receptacle	60A Safeway Pin and Sleeve Device, Exposition Receptacle, 4-Pole/5-Wire Grounding	Y560R	130150-0285
			60A Safeway Pin and Sleeve Device, Exposition Receptacle with Flip Lid, 4-Pole/5-Wire Grounding	Y561R	130150-0287

D

Wiring Devices

Safeway® Pin and Sleeve Devices Nylon

Features and Benefits

- IP44 rated
- Deadfront construction
- Self-adjusting split contact sleeves. Nickel-plated Steel spring compensates for wear, maintains constant pressure along contact surface to ensure electrical continuity and grounding
- Latching mechanism prevents accidental disengagement
- Keyway for fast, accurate alignment
- Internal strain relief with “swing away” feature
- External strain relief reduces bending arc of cable
- Large, identified terminals accept conductors one or two sizes larger or smaller than normal
- “Onion ring” neoprene bushing in cable grip accommodates wide range of cable sizes

Physical

Pins: Brass
Housing: Type G nylon
Contact Carrier: Type G nylon

Environmental

IEC Rating: IP44
IEC Standards*: 309-1 and 309-2

Applications

- Temporary power systems
- Power disconnect for portable processing equipment
- Machinery intended for export and users of foreign-built equipment

* IEC 309-1 and 309-2 are a worldwide pin and sleeve standard established by the International Electrotechnical Commission. It meets requirements of Section 410-56(g) of the National Electrical Code



20A Safeway Devices

Pole/Wire	Color	Voltage	Receptacle		Plug		Connector	
			Woodhead No.	Order No.	Woodhead No.	Order No.	Woodhead No.	Order No.
2-Pole/3-Wire	Yellow	125	320R4	130150-0056	320P4	130150-0049	320C4	130150-0036
2-Pole/3-Wire	Blue	250	320R6	130150-0058	320P6	130150-0052	320C6	130150-0039
2-Pole/3-Wire	Gray	277	320R5	130150-0289	320P5	130150-0051	320C5	130150-0038
3-Pole/4-Wire	Orange	125/250	420R12	130150-0143	420P12	130150-0135	420C12	130198-0124
3-Pole/4-Wire	Blue	3ø250	420R9	130150-0149	420P9	130150-0141	420C9	130150-0288
3-Pole/4-Wire	Red	3ø480	420R7	130150-0147	420P7	130150-0139	420C7	130150-0127
3-Pole/4-Wire	Black	3ø600	420R5	130150-0145	420P5	130150-0137	420C5	130150-0125
4-Pole/5-Wire	Blue	3øY 120/208	520R9	130150-0244	520P9	130150-0240	520C9	130150-0229
5-Pole/5-Wire	Red	3øY 277/480	520R7	130150-0242	520P7	130150-0238	520C7	130150-0227

30A Safeway Devices

Pole/Wire	Color	Voltage	Receptacle		Plug		Connector	
			Woodhead No.	Order No.	Woodhead No.	Order No.	Woodhead No.	Order No.
3-Pole/4-Wire	Red	3ø480	420R7	130150-0147	430P7	130150-0170	430C7	130150-0157

60A Safeway Devices

Pole/Wire	Color	Voltage	Receptacle		Plug		Connector	
			Woodhead No.	Order No.	Woodhead No.	Order No.	Woodhead No.	Order No.
3-Pole/4-Wire	Orange	125/250	460R12	130150-0206	460P12	130150-0198	460C12	130150-0185
3-Pole/4-Wire	Blue	3ø250	460R9	130150-0212	460P9	130150-0204	460C9	130150-0191
3-Pole/4-Wire	Red	3ø480	460R7	130150-0210	460P7	130150-0202	460C7	130150-0189
3-Pole/4-Wire	Black	3ø600	460R5	130150-0208	460P5	130150-0200	460C5	130150-0187

Note: Angled inlet and mechanical interlock also available for 2-Pole/3-Wire, 4-Pole/5-Wire

Technical Information

Safeway®

Pin and Sleeve Devices

Industrial Duty

IEC 309 PIN AND SLEEVE CONFIGURATION AND COLOR-CODING STANDARD

Contact Positions

The grounding contact position is based on a clock face. With the keyway at bottom, the female grounding contact will appear at one of the 12 clock positions. Example: all 480V AC receptacles and connectors, regardless of amperage, have their grounding sleeve at 7 o'clock (which puts the grounding pin on all mating plugs and inlets at 5 o'clock).

Voltage Rating Color-Code

The housings of every device in a particular voltage group are identical in color for instant identification. Example: All 480V AC devices are red, all 250V AC devices are blue.

Amperage Rating Identification

Amperage differences can be identified by the relative sizes of the devices. Smallest is 20A, largest is 60A.

Woodhead Catalog Numbering System

First Digit of Woodhead Number	Second Series of Digits	Letter	Third Digit
3 = 3-Wire	20 = 20A	P = Plug	Clock position of female grounding contact
4 = 4-Wire	30 = 30A	R = Receptacle	
5 = 5-Wire	60 = 60A	C = Connector	
	100 = 100A	B = Inlet	
		BA = Angled Inlet	

Examples: 430R7 = Woodhead 4-Wire, 30A receptacle with a grounding sleeve at seven o'clock.

430P7 = Woodhead 4-Wire, 30A plug which mates with a grounding sleeve at seven o'clock.

Cord Grip Ranges

Plug and Connector Type	Cable Diameter Min. (in.)	Cable Diameter Max. (in.)
320	.395	.825
420	.395	.825
520	.395	.825
330	.395	.825
430	.710	1.20
530	.710	1.20
60A	.710	1.20

Note: For Watertite® products, see page D-61

Technical Information

Woodhead® Wiring Devices

Technical Reference

Super-Safeway™ Adapters

Wiring Diagrams for NEMA Configurations
 Configurations shown are for female devices.

D
Wiring Devices

125V
2P, 2W

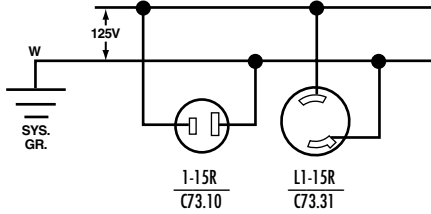

NEMA
ANSI

250V
2P, 2W

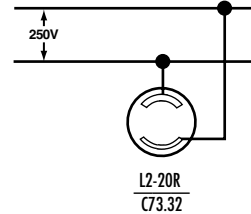

NEMA
ANSI

125
2P, 3W
GROUNDING

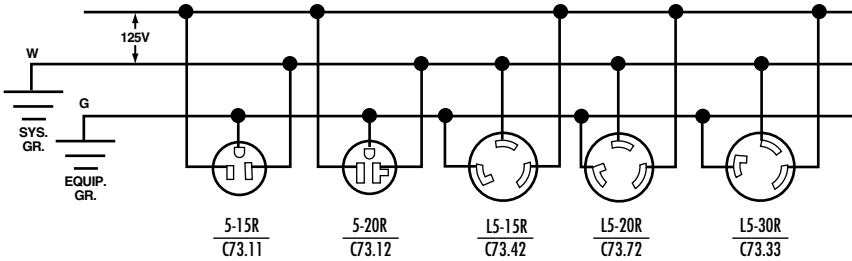

NEMA
ANSI

250V
2P, 3W
GROUNDING

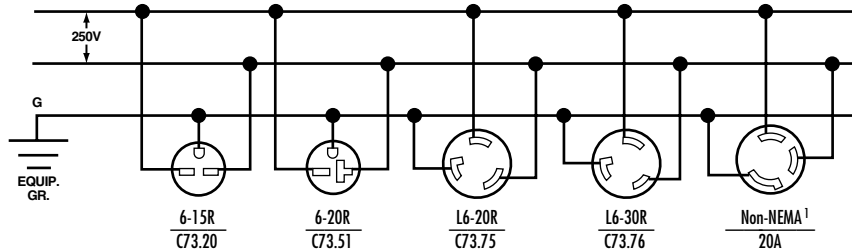

NEMA
ANSI

277VAC
2P, 3W
GROUNDING

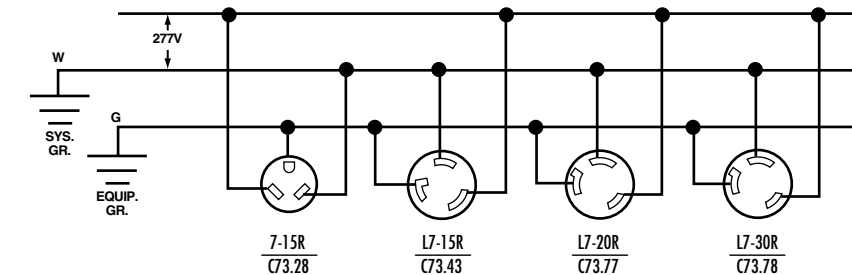

NEMA
ANSI

¹ Previously rated 20A/250V or 10A/600V.

² Previously rated 30A/250V.

Note: The above diagrams are intended to show wiring device terminal identification only.

Technical Information

Woodhead® Wiring Devices

Technical Reference

Wiring Diagrams for NEMA Configurations

Configurations shown are for female devices.

15A 125V/10A 250V
2P, 3W
GROUNDING

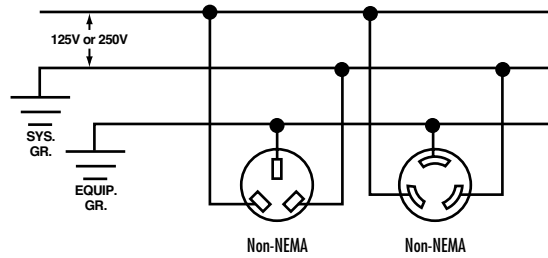

NEMA
ANSI

125/250V
3P, 3W

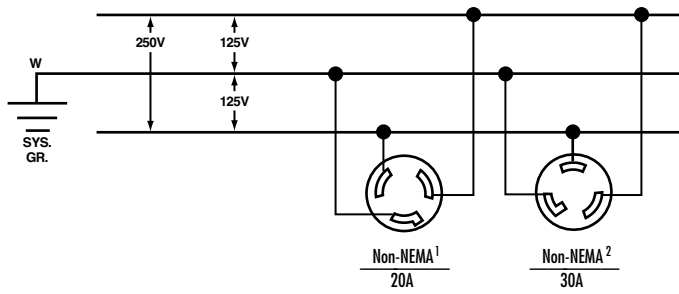

NEMA
ANSI

125/250V
3P, 4W
GROUNDING

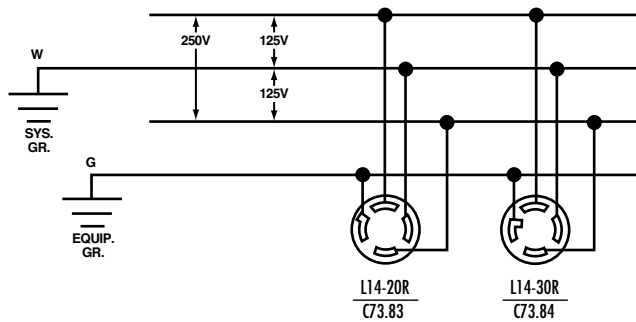

NEMA
ANSI

¹ Previously rated 20A/250V or 10A/600V.

² Previously rated 30A/250V.

Note: The above diagrams are intended to show wiring device terminal identification only.

Technical Information

Woodhead® Wiring Devices

Technical Reference

Wiring Diagrams for NEMA Configurations

Configurations shown are for female devices.

D
Wiring Devices

3ø
250V
3P, 4W
GROUNDING

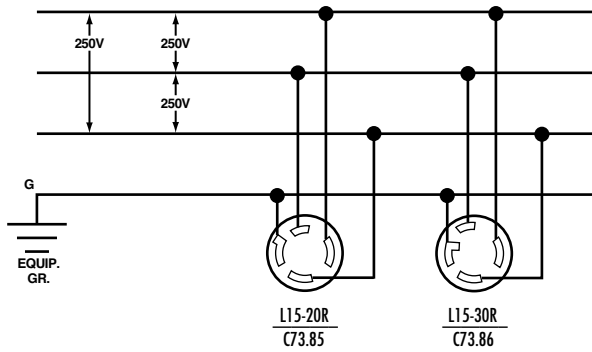

NEMA
ANSI

3ø
480V
3P, 4W
GROUNDING

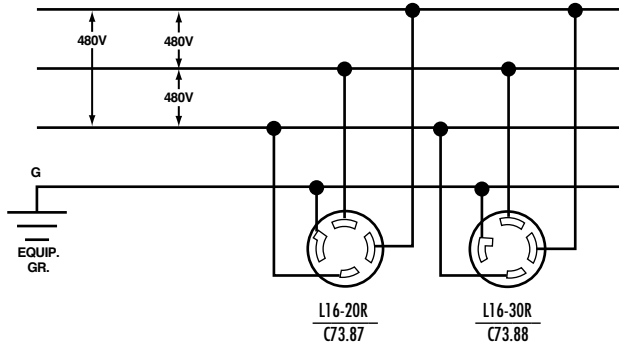

NEMA
ANSI

Note: The above diagrams are intended to show wiring device terminal identification only.

Technical Information

Woodhead® Wiring Devices

Technical Reference

Wiring Diagrams for NEMA Configurations

Configurations shown are for female devices.

3 ϕ
600V
3P, 4W
GROUNDING

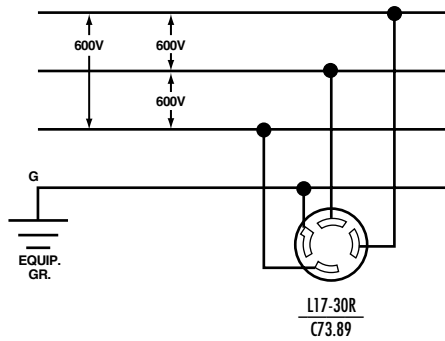

NEMA
ANSI

3 ϕ
120/208V
4P, 4W

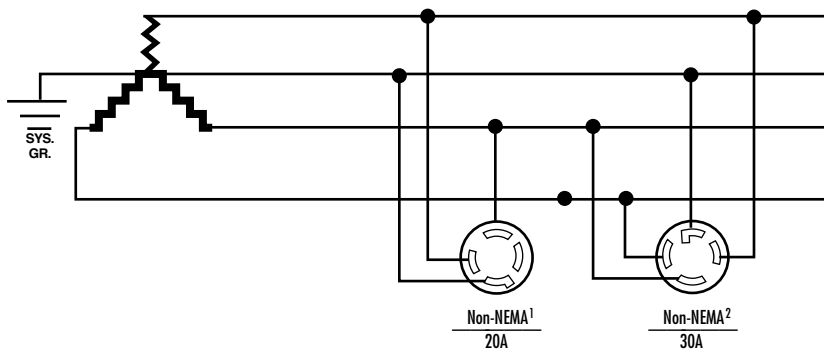

NEMA
ANSI

3 ϕ Y
120/208V
4P, 5W
GROUNDING

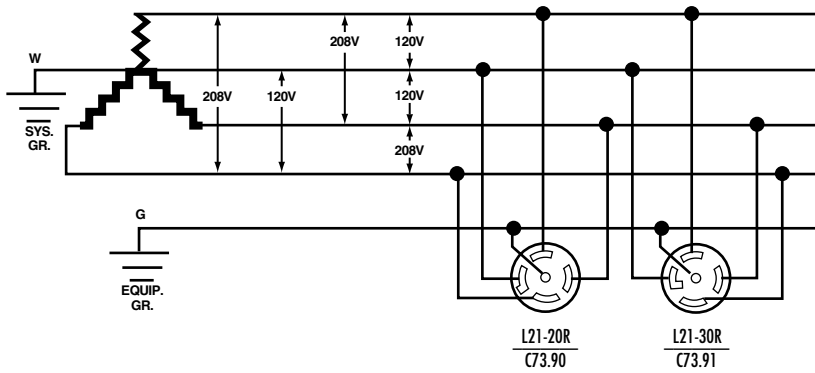

NEMA
ANSI

¹ Previously rated 20A/250V or 10A/600V.

² Previously rated 30A/250V.

Note: The above diagrams are intended to show wiring device terminal identification only.

Technical Information

Woodhead® Wiring Devices

Technical Reference

Wiring Diagrams for NEMA Configurations

Configurations shown are for female devices.

D
Wiring Devices

3 ϕ Y
277/480V
4P, 5W
GROUNDING

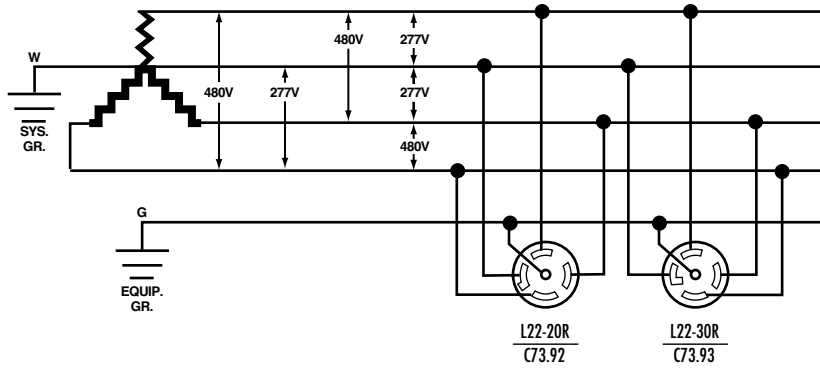

NEMA
ANSI

3 ϕ Y
347/600V
4P, 5W
GROUNDING

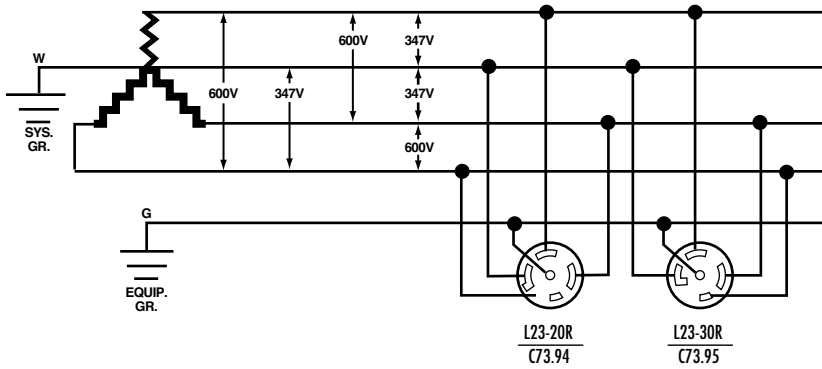

Note: The above diagrams are intended to show wiring device terminal identification only.

Technical Information

Woodhead® Wiring Devices

Technical Reference

Terminal Identification

Most Woodhead plugs, connectors, and receptacles are standard NEMA configurations. As such, standard terminal identification is used to incorporate these devices in the wiring system.

Terminal	Letter Designation	Description	Conductor
Green	G	Grounding terminal	Green, Green w/Yellow Stripe
White	W	Grounded terminal	White or Gray
X, Y, Z	X, Y, Z	Hot terminals	Black, Red, Blue, Etc. ¹

¹ There is no standard that matches color to letters. Once a correlation is chosen, it should be used consistently.

Watertite® Devices Cord Range

Dimensional Reference Information	Cord Range
F2	0.2–1.6cm (.062–.625")
F3	0.5–2.1cm (.187–.812")
F4	1.1–2.8cm (.437–1.10")
F5	2.2–3.5cm (.875–1.375")

Super-Safeway™, Safeway® Devices Cord Range

Dimensional Reference Information	Cord Range
2	0.8–1.7cm (.300–.675")
3	0.8–2.1cm (.325–.840")
4	1.1–2.9cm (.425–1.150")

Technical Information

Woodhead® Wiring Devices

Technical Reference

Horsepower Ratings for NEMA Configuration Attachment Plugs and Receptacles

15A

AC Voltage Rating	Phases	Poles	Horsepower Rating	NEMA Designation
125	1	2	½	1-15, L1-15, 5-15, L5-15
250	1	2	2	6-15, L6-15, 7-15, L7-15

20A

AC Voltage Rating	Phases	Poles	Horsepower Rating	NEMA Designation
125	1	2	1	5-20, L5-20
250	1	2	2	L2-20, 6-20, L6-20
277	1	2	2	L7-20
125/250	1	3	2 L-L, 1 L-N	10-20, L10-20, L14-20
250	3	3	5	L11-20, L15-20
480	3	3	10	L16-20
120/208	3	4	3	L21-20
277/480	3	4	10	L22-20

30A

AC Voltage Rating	Phases	Poles	Horsepower Rating	NEMA Designation
125	1	2	2	L5-30
250	1	2	3	L6-30
277	1	2	3	L7-30
125/250	1	3	2 L-N	L14-30
250	3	3	7½	L15-30
480	3	3	15	L16-30
120/208	3	4	5	L21-30
277/480	3	4	15	L22-30

L-L: Motor connected line-to-line

L-N: Motor connected line-to-neutral

Note: Horsepower ratings are not applicable to devices incorporating overcurrent protection or a switch.
Refer to ANSI/NEMA WD6-1988 for configurations of the NEMA designations.

Technical Information

Woodhead® Wiring Devices

Technical Reference

Selecting the Proper Cable Size

1. Determine the load ampacity requirements.
2. Read across for the number of current-carrying conductors.
3. Read down until the value meets or exceeds the requirements established in Step 1.
4. Read back across to left to determine the appropriate size cord.

AWG	2 Current-Carrying Conductors*	3 Current-Carrying Conductors*	4-6 Current-Carrying Conductors*
22	3A	3A	3A
18	10A	7A	5A
16	13A	10A	8A
14	18A	15A	12A
12	25A	20A	16A
10	30A	25A	20A
8	40A	35A	28A
6	55A	45A	36A
4	70A	60A	48A
2	95A	80A	64A

* In determining cord capacity, count only those conductors that are current-carrying. The grounding conductor is not counted.
 Note: For further information consult Table 400-5 of the National Electrical Code.

Nominal Cord Diameter*

AWG	2 Conductors	3 Conductors	4 Conductors	5 Conductors
22	0.215–0.235	0.215–0.235	0.240–0.260	0.250–0.270
18	0.340–0.385	0.360–0.400	0.385–0.430	0.460–0.510
16	0.365–0.410	0.385–0.430	0.410–0.460	0.490–0.550
14	0.495–0.550	0.520–0.575	0.560–0.620	0.630–0.705
12	0.565–0.625	0.590–0.655	0.640–0.710	0.700–0.770
10	0.615–0.685	0.650–0.720	0.700–0.775	0.760–0.840
8	0.780–0.880	0.830–0.930	0.925–1.050	1.000–1.150
6	0.920–1.050	0.970–1.100	1.050–1.200	1.180–1.330
4	1.060–1.210	1.130–1.280	1.250–1.450	
2	1.210–1.400	1.300–1.500	1.450–1.650	

* Cord types S, SE, SOO, SO, SEO, ST, ST00, and ST0. Information for 2- through 18-AWG cable taken from U.L. Standard 62 "Flexible Cord and Fixture Wire."
 Information for 22 AWG cable based on Woodhead cord.

Technical Information

Watertite® Rubber Devices

Dimensions

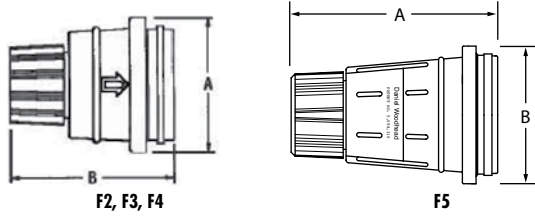

Male Plug

Cord Grip/Body Size	A Diameter	B Length
F2	4.7cm (1.85")	6.7cm (2.62")
F3	6.4cm (2.50")	7.6cm (3.00")
F4	6.9cm (2.75")	7.6cm (3.00")
F5	10.8cm (4.25")	8.3cm (3.25")

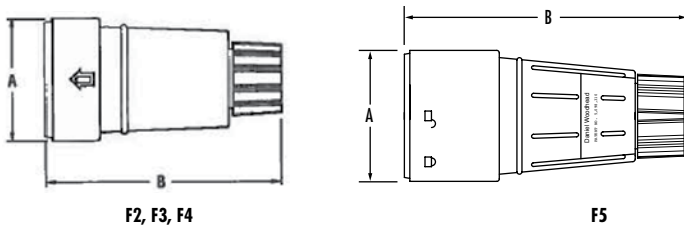

Female Connectors

Cord Grip/Body Size	A Diameter	B Length
F2	4.7cm (1.85")	10.2cm (4.03")
F3	6.4cm (2.50")	12.0cm (4.75")
F4	6.9cm (2.75")	12.0cm (4.75")
F5	8.3cm (3.25")	16.2cm (6.38")

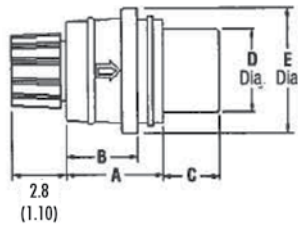

Female Connector for Flip Lid with Male Receptacle

Cord Grip/Body Size	A Length	B Length	C Length	D Diameter	E Diameter
F2	4.1cm (1.63")	2.8cm (1.09")	1.8cm (.72")	3.3cm (1.30")	4.7cm (1.85")
F3	5.0cm (1.95")	3.6cm (1.43")	2.9cm (1.13")	4.2cm (1.66")	6.4cm (2.50")
F4	5.1cm (2.00")	3.8cm (1.49")	2.9cm (1.13")	4.7cm (1.86")	7.0cm (2.75")

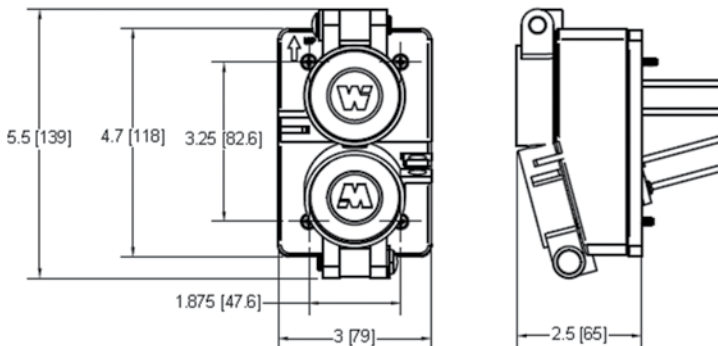

Technical Information

Watertite® Rubber Devices

Dimensions

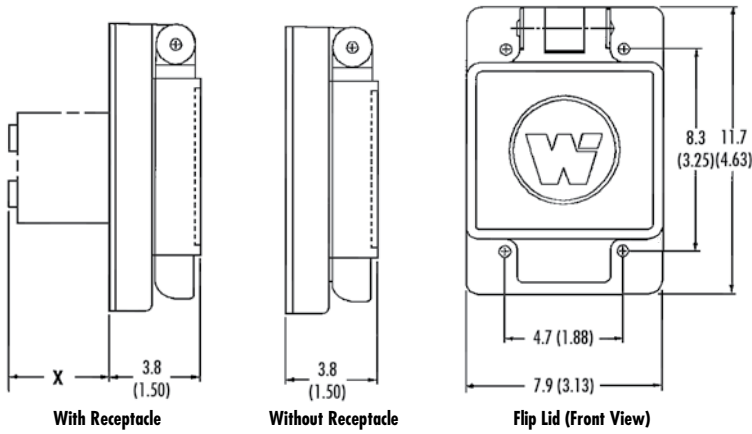

Flip Lid

Description	X Depth with Female Receptacle
Female locking 15A receptacles	2.3cm (0.91")
Female locking straight-blade 15A and 20A receptacles	2.3cm (0.91")
Female locking 20A and 30A receptacles	3.8cm (1.50")

Description	X Depth with Male Receptacle
Male locking 15A receptacles	4.8cm (1.88")
Male locking straight-blade 15A and 20A receptacles	4.8cm (1.88")
Male locking 20A and 30A receptacles	4.8cm (1.88")

GFCI Receptacle

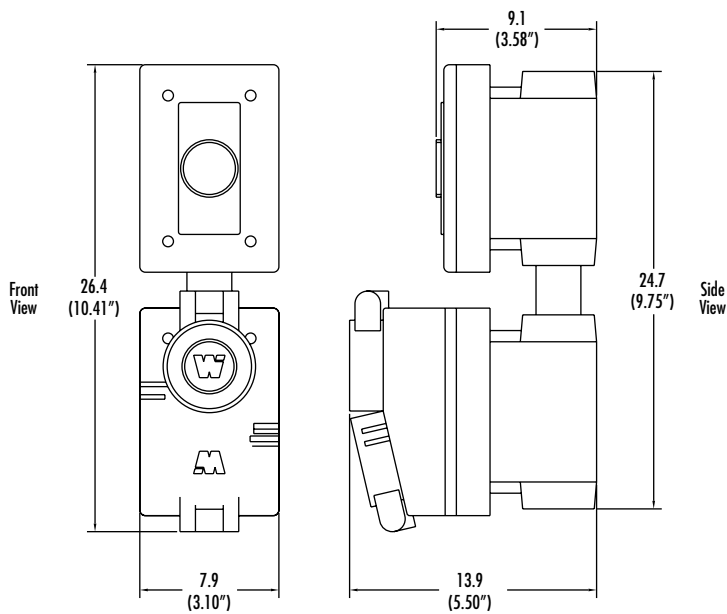

Technical Information

Watertite® Rubber Devices

Dimensions

F.S. Box

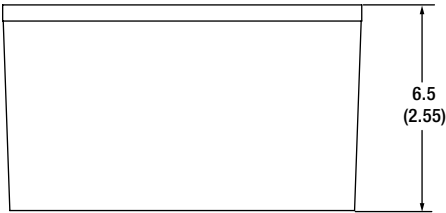
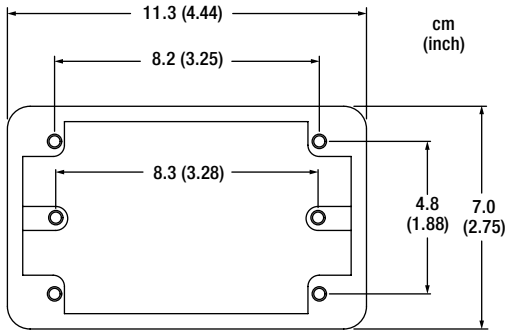

F.D. Box

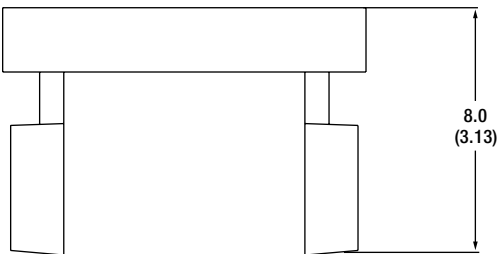
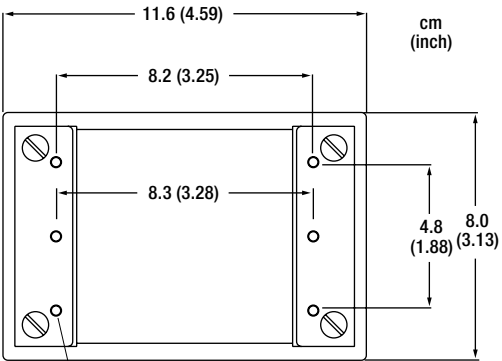

Wiring Devices

D

Technical Information

Super-Safeway™

Rubber Devices

Dimensions

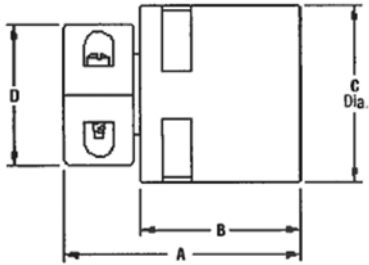

Male Plug

Current	A Length	B Length	C Diameter	D Diameter
All 15A devices and 20A straight-blade devices	5.8cm (2.27")	3.7cm (1.44")	3.9cm (1.53")	3.9cm (1.53")
20A locking	6.6cm (2.59")	4.5cm (1.76")	4.9cm (1.93")	4.2cm (1.60")
30A locking	6.7cm (2.64")	4.6cm (1.81")	5.4cm (2.11")	4.4cm (1.72")

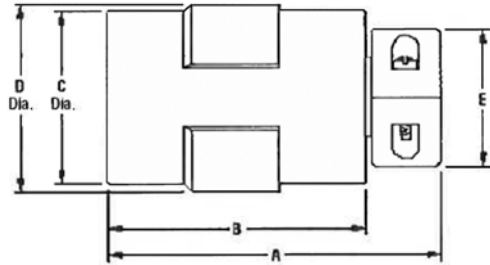

Female Connector

Current	A Length	B Length	C Diameter	D Diameter	E Diameter
All 15A devices and 20A straight-blade devices	7.6cm (2.99")	5.5cm (2.16")	3.9cm (1.53")	4.2cm (1.66")	3.9cm (1.53")
20A Locking	9.5cm (3.74")	5.6cm (2.19")	4.9cm (1.93")	5.3cm (2.07")	4.1cm (1.60")
30A Locking	9.6cm (3.77")	7.5cm (2.94")	5.4cm (2.13")	5.9cm (2.31")	4.4cm (1.72")

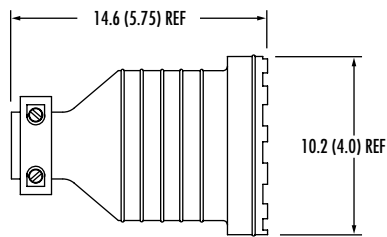
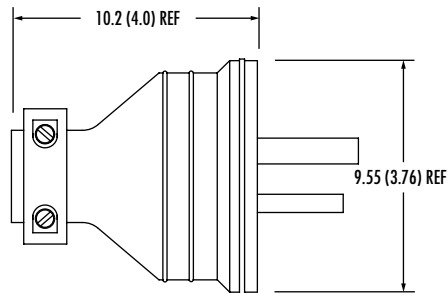

Woodhead No.	Order No.
8664	130142-0051
8665	130142-0052

Technical Information

Safeway® Nylon Devices

Dimensions

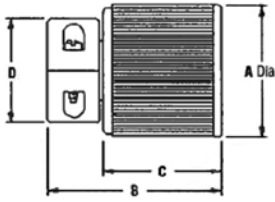

Safeway Plug

Dimensional Reference Information	A Diameter	B Length	C Length	D Diameter
All 15A devices and 20A straight-blade	3.9cm (1.53")	5.5cm (2.17")	3.4cm (1.34")	3.9cm (1.53")
20A Locking	4.9cm (1.94")	6.6cm (2.58")	4.5cm (1.75")	4.1cm (1.60")
30A Locking	5.4cm (2.14")	6.7cm (2.64")	4.6cm (1.81")	4.4cm (1.72")

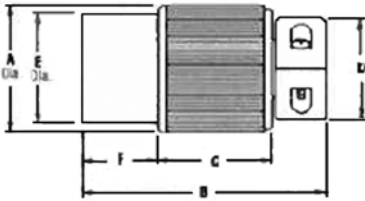

Safeway Connector

Dimensional Reference Information	A Diameter	B Length	C Length	D Diameter	E Diameter	F Length
All 15A devices and 20A straight-blade	3.9cm (1.53")	7.3cm (2.88")	3.4cm (1.34")	3.9cm (1.53")	3.3cm (1.30")	1.8cm (.71")
20A Locking	4.9cm (1.94")	9.5cm (3.75")	4.5cm (1.75")	4.1cm (1.60")	4.2cm (1.67")	3.0cm (1.17")
30A Locking	5.4cm (2.14")	9.7cm (3.80")	4.6cm (1.81")	4.4cm (1.72")	4.8cm (1.87")	2.9cm (1.16")

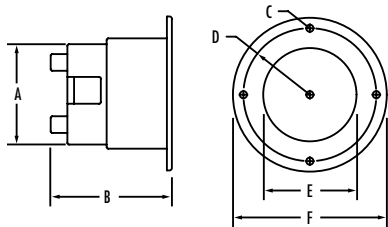

Flanged Inlet Receptacle

Dimensional Reference Information	A Diameter	B Length	C Length	D Diameter	E Diameter	F Length
All 15A devices and 20A straight-blade	5.8cm (2.25")	6.7cm (2.62")	.5cm (0.19")	3.8cm (1.5")	5.1cm (2.02")	8.9cm (3.5")
20A Locking	4.7cm (1.84")	5.0cm (1.95")	.5cm (0.19")	6.4cm (2.5")	4.8cm (1.88")	7.3cm (2.88")
30A Locking	5.2cm (2.04")	5.1cm (2.0")	.5cm (0.19")	6.9cm (2.7")	5.2cm (2.03")	7.7cm (3.03")

Technical Information

Safeway® Nylon Devices

Dimensions

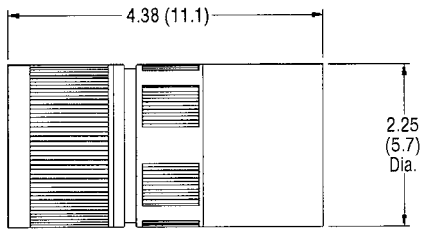

50A Plug

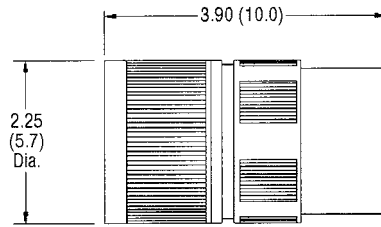

50A Connector*

* Cord range: 1.7–2.9cm (.680–1.125")

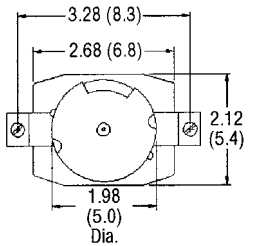

50A Receptacle

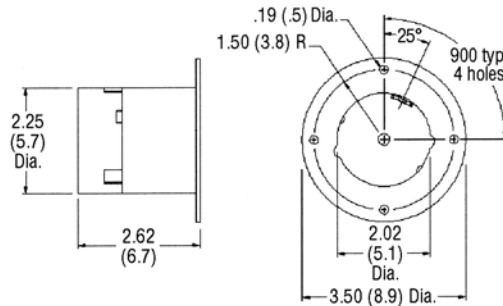
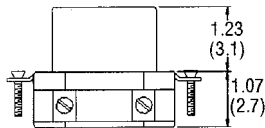

50A Flanged Inlet

Dimensions for all duplex receptacles

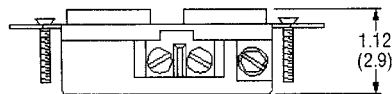
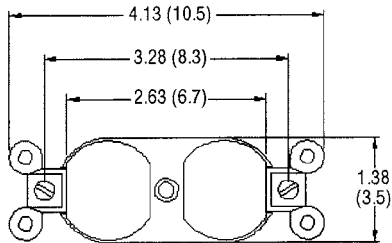

Duplex Receptacles

Dimensions for all straight-blade single receptacles

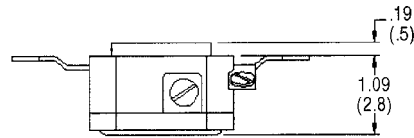
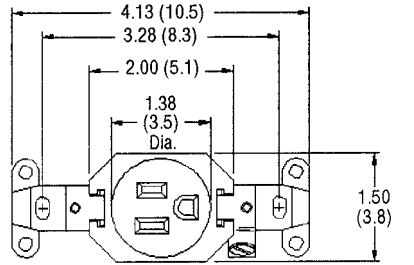

Straight-Blade Single Receptacles

Technical Information

Safeway® Nylon Devices

Dimensions

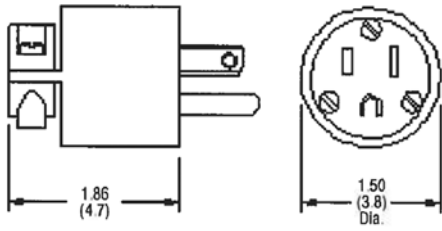

Hospital-Grade Devices

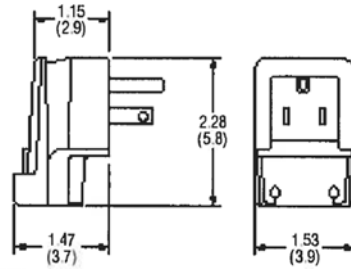

Right Angle Plug

Description	Woodhead No.	Order No.
Hospital-Grade Devices	85447	130144-0087
	85447L	130144-0088
Right Angle Plug	14R47	130144-0016
	85050	130144-0075

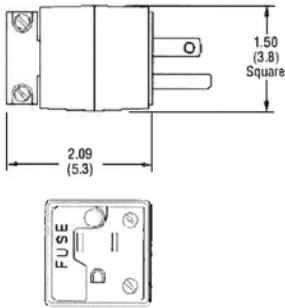

Individually Fused Grounding Plug

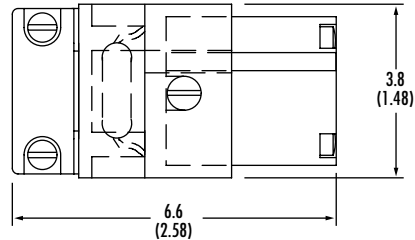

Lighted Connector

Description	Woodhead No.	Order No.
Individually Fused Grounding Plug	14F47	130144-0014
	85125	130144-0077
Lighted Connector	5269L	130144-0048

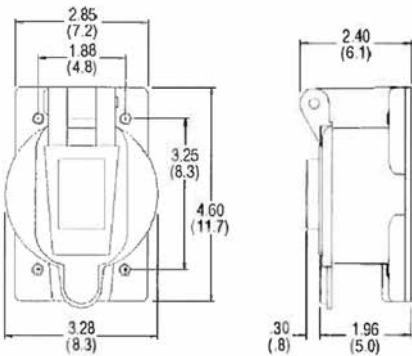

Flip Lid Cover

20A/30A Locking Single Receptacle

Current	Face Diameter
20A	4.0cm (1.56")
30A	4.1cm (1.63")