



PUSH IN CONDUIT CLAMP, 3/4" EMT, 0.866"–1.181" OD, 9/32" HOLE, PLAIN

CATALOG NUMBER

12P



FEATURES

Push-in installation of conduit

Eliminates need for offset bending conduit

May be used for either vertical or horizontal installations

PRODUCT ATTRIBUTES

Material: Spring Steel

Finish: nVent CADDY Armour

EMT Conduit Size: 3/4"

Outer Diameter (OD): 0.870" - 1.18"

Hole Size (HS): 9/32"

Hole Type: Plain

Ultimate Static Load 1 (F1): 25lb

Ultimate Static Load 2 (F2): 15lb

DIAGRAMS

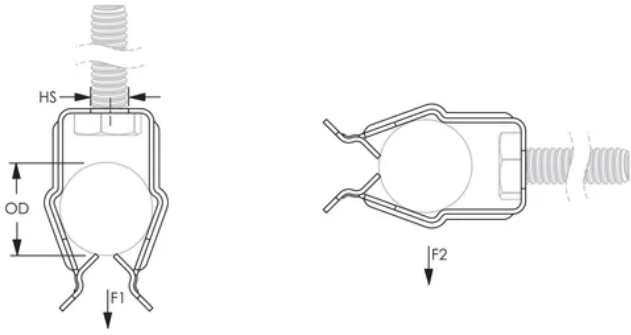

WARNING

nVent products shall be installed and used only as indicated in nVent's product instruction sheets and training materials. Instruction sheets are available at www.nvent.com and from your nVent customer service representative. Improper installation, misuse, misapplication or other failure to completely follow nVent's instructions and warnings may cause product malfunction, property damage, serious bodily injury and death and/or void your warranty.

North America

+1.800.753.9221

Option 1 – Customer Care

Option 2 – Technical Support

Europe

Netherlands:

+31 800-0200135

France:

+33 800 901 793

Europe

Germany:

800 1890272

Other Countries:

+31 13 5835404

APAC

Shanghai:

+ 86 21 2412 1618/19

Sydney:

+61 2 9751 8500



Our powerful portfolio of brands:
nVent.com CADDY ERICO HOFFMAN RAYCHEM SCHROFF
TRACER

© 2025 nVent. All nVent marks and logos are owned or licensed by nVent Services GmbH or its affiliates. All other trademarks are the property of their respective owners.

nVent reserves the right to change specifications without notice.



PUSH IN CONDUIT CLAMP, 3/4" EMT, 0.866"–1.181" OD, 9/32" HOLE, PLAIN

CATALOG NUMBER

12P



FEATURES

Push-in installation of conduit

Eliminates need for offset bending conduit

May be used for either vertical or horizontal installations

PRODUCT ATTRIBUTES

Material: Spring Steel

Finish: nVent CADDY Armour

EMT Conduit Size: 3/4"

Outer Diameter (OD): 0.870" - 1.18"

Hole Size (HS): 9/32"

Hole Type: Plain

Ultimate Static Load 1 (F1): 25lb

Ultimate Static Load 2 (F2): 15lb

DIAGRAMS

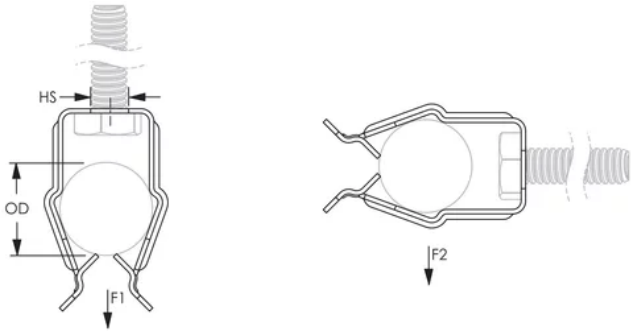

WARNING

nVent products shall be installed and used only as indicated in nVent's product instruction sheets and training materials. Instruction sheets are available at www.nvent.com and from your nVent customer service representative. Improper installation, misuse, misapplication or other failure to completely follow nVent's instructions and warnings may cause product malfunction, property damage, serious bodily injury and death and/or void your warranty.

North America

+1.800.753.9221
Option 1 – Customer Care
Option 2 – Technical Support

Europe

Netherlands:
+31 800-0200135
France:
+33 800 901 793

Europe

Germany:
800 1890272
Other Countries:
+31 13 5835404

APAC

Shanghai:
+ 86 21 2412 1618/19
Sydney:
+61 2 9751 8500



Our powerful portfolio of brands:
nVent.com CADDY ERICO HOFFMAN RAYCHEM SCHROFF
TRACER